



# SAR EVALUATION REPORT

For

## Hytera Communications Corporation Limited

Hytera Tower, Hi-Tech Industrial Park North, 9108# Beihuan Road,  
Nanshan District, Shenzhen, People's Republic of China

**FCC ID: YAMPNC380B9**

<b>Report Type:</b> Original Report	<b>Product Type:</b> PoC Radio
<b>Report Number:</b> RDG200109003-SAA	
<b>Report Date:</b> 2020-04-01	
<b>Reviewed By:</b> Alvin Huang Lab Manager	
<b>Prepared By:</b> Bay Area Compliance Laboratories Corp. (Shenzhen) 6/F., West Wing, Third Phase of Wanli Industrial Building, Shihua Road, Futian Free Trade Zone, Shenzhen, Guangdong, China Tel: +86-755-33320018 Fax: +86-755-33320008 <a href="http://www.baclcorp.com.cn">www.baclcorp.com.cn</a>	

**Note:** This report must not be used by the customer to claim product certification, approval, or endorsement by A2LA\* or any agency of the Federal Government. This report may contain data that are not covered by the A2LA accreditation and are marked with an asterisk "★".

BACL is not responsible for the authenticity of any test data provided by the applicant. Data included from the applicant that may affect test results are marked with an asterisk '\*'. Customer model name, addresses, names, trademarks etc. are not considered data.

This report cannot be reproduced except in full, without prior written approval of the Company. Unless otherwise stated the results shown in this test report refer only to the sample(s) tested. This report is valid only with a valid digital signature. The digital signature may be available only under the Adobe software above version 7.0.

Attestation of Test Results			
<b>EUT Information</b>	<b>EUT Description</b>	PoC Radio	
	<b>Tested Model</b>	PNC380	
	<b>FCC ID</b>	YAMPNC380B9	
	<b>Serial Number</b>	RDG200109003-SA-S2	
	<b>Test Date</b>	2020/02/10 to 2020/02/13	
<b>MODE</b>		<b>Max. SAR Level(s) Reported(W/kg)</b>	<b>Limit (W/kg)</b>
<b>GSM 850</b>	1g Face SAR	0.48	<b>1.6</b>
	1g Body SAR	0.50	
<b>PCS 1900</b>	1g Face SAR	0.16	
	1g Body SAR	0.33	
<b>WCDMA Band 2</b>	1g Face SAR	0.50	
	1g Body SAR	1.01	
<b>WCDMA Band 4</b>	1g Face SAR	0.55	
	1g Body SAR	1.33	
<b>WCDMA Band 5</b>	1g Face SAR	0.46	
	1g Body SAR	0.85	
<b>LTE Band 2</b>	1g Face SAR	0.25	
	1g Body SAR	0.62	
<b>LTE Band 4</b>	1g Face SAR	0.32	
	1g Body SAR	0.79	
<b>LTE Band 5</b>	1g Face SAR	0.44	
	1g Body SAR	0.86	
<b>LTE Band 7</b>	1g Face SAR	0.28	
	1g Body SAR	0.52	
<b>LTE Band 12&amp;17</b>	1g Face SAR	0.35	
	1g Body SAR	0.71	
<b>LTE Band 13</b>	1g Face SAR	0.38	
	1g Body SAR	0.65	
<b>LTE Band 26</b>	1g Face SAR	0.49	
	1g Body SAR	0.89	
<b>LTE Band 38</b>	1g Face SAR	0.14	
	1g Body SAR	0.26	
<b>LTE Band 41</b>	1g Face SAR	0.14	
	1g Body SAR	0.23	
<b>2.4G wifi</b>	1g Face SAR	0.03	
	1g Body SAR	0.18	
<b>5.2G wifi</b>	1g Face SAR	0.14	
	1g Body SAR	0.14	
<b>5.6G wifi</b>	1g Face SAR	0.14	
	1g Body SAR	0.17	
<b>5.8G wifi</b>	1g Face SAR	0.16	
	1g Body SAR	0.16	
<b>Simultaneous</b>	1g Face SAR	<b>0.71</b>	
	1g Body SAR	<b>1.51</b>	

<b>Applicable Standards</b>	<p><b>FCC 47 CFR part 2.1093</b> Radiofrequency radiation exposure evaluation: portable devices</p>
	<p><b>IEEE1528:2013</b> IEEE Recommended Practice for Determining the Peak Spatial-Average Specific Absorption Rate (SAR) in the Human Head from Wireless Communications Devices: Measurement Techniques</p>
	<p><b>IEC 62209-2:2010</b> Human exposure to radio frequency fields from hand-held and body-mounted wireless communication devices-Human models, instrumentation, and procedures-Part 2: Procedure to determine the specific absorption rate (SAR) for wireless communication devices used in close proximity to the human body (frequency range of 30 MHz to 6 GHz)</p>
	<p><b>KDB procedures</b> KDB 447498 D01 General RF Exposure Guidance v06 KDB 648474 D04 Handset SAR v01r03 KDB 865664 D01 SAR Measurement 100 MHz to 6 GHz v01r04 KDB 865664 D02 RF Exposure Reporting v01r02 KDB 941225 D01 3G SAR Procedures v03r01</p>
<p><b>Note:</b> This wireless device has been shown to be capable of compliance for localized specific absorption rate (SAR) for General Population/Uncontrolled Exposure limits specified in <b>FCC 47 CFR part 2.1093</b> and has been tested in accordance with the measurement procedures specified in IEEE 1528-2013 and RF exposure KDB procedures. <b>The results and statements contained in this report pertain only to the device(s) evaluated.</b></p>	

## TABLE OF CONTENTS

<b>DOCUMENT REVISION HISTORY</b> .....	<b>5</b>
<b>EUT DESCRIPTION</b> .....	<b>6</b>
TECHNICAL SPECIFICATION.....	6
<b>REFERENCE, STANDARDS, AND GUIDELINES</b> .....	<b>8</b>
SAR LIMITS .....	9
<b>FACILITIES</b> .....	<b>10</b>
<b>DESCRIPTION OF TEST SYSTEM</b> .....	<b>11</b>
<b>EQUIPMENT LIST AND CALIBRATION</b> .....	<b>17</b>
EQUIPMENTS LIST & CALIBRATION INFORMATION .....	17
<b>SAR MEASUREMENT SYSTEM VERIFICATION</b> .....	<b>18</b>
LIQUID VERIFICATION.....	18
SYSTEM ACCURACY VERIFICATION .....	21
SAR SYSTEM VALIDATION DATA .....	22
<b>EUT TEST STRATEGY AND METHODOLOGY</b> .....	<b>29</b>
TEST POSITIONS FOR DEVICE OPERATING NEXT TO A PERSON’S EAR.....	29
CHEEK/TOUCH POSITION .....	30
EAR/TILT POSITION.....	30
TEST POSITIONS FOR BODY-WORN AND OTHER CONFIGURATIONS .....	31
TEST DISTANCE FOR SAR EVALUATION .....	31
SAR EVALUATION PROCEDURE .....	32
<b>CONDUCTED OUTPUT POWER MEASUREMENT</b> .....	<b>33</b>
PROVISION APPLICABLE.....	33
TEST PROCEDURE.....	33
RADIO CONFIGURATION.....	33
MAXIMUM TARGET OUTPUT POWER.....	36
TEST RESULTS:.....	39
<b>STANDALONE SAR TEST EXCLUSION CONSIDERATIONS</b> .....	<b>66</b>
ANTENNA DISTANCE TO EDGE.....	66
SAR TEST EXCLUSION FOR THE EUT EDGE CONSIDERATIONS RESULT.....	68
<b>SAR MEASUREMENT RESULTS</b> .....	<b>69</b>
SAR TEST DATA .....	69
<b>SAR SIMULTANEOUS TRANSMISSION DESCRIPTION</b> .....	<b>78</b>
<b>SAR PLOTS</b> .....	<b>83</b>
<b>APPENDIX A MEASUREMENT UNCERTAINTY</b> .....	<b>84</b>
<b>APPENDIX B EUT TEST POSITION PHOTOS</b> .....	<b>86</b>
<b>APPENDIX C CALIBRATION CERTIFICATES</b> .....	<b>87</b>

---

## DOCUMENT REVISION HISTORY

---

Revision Number	Report Number	Description of Revision	Date of Revision
0	RDG200109003-SAA	Original Report	2020-04-01

## EUT DESCRIPTION

This report has been prepared on behalf of **Hytera Communications Corporation Limited** and their product **PoC Radio**, Model: **PNC380**, FCC ID: **YAMPNC380B9** or the EUT (Equipment under Test) as referred to in the rest of this report.

*\*All measurement and test data in this report was gathered from production sample serial number: RDG200109003-SA-S2(Assigned by BACL, Shenzhen).The EUT supplied by the applicant was received on 2020-02-09.*

## Technical Specification

<b>Device Type:</b>	Portable
<b>Exposure Category:</b>	Population / Uncontrolled
<b>Antenna Type(s):</b>	External antenna
<b>DTM Type:</b>	Class B
<b>Multi-slot Class:</b>	GPRS(Class 12)
<b>Proximity sensor for SAR reduction:</b>	None
<b>Body-Worn Accessories:</b>	Headset
<b>Face-Head Accessories:</b>	None
<b>Operation Mode :</b>	GSM Voice, GPRS Data, WCDMA( R99 (Voice+Data), HSDPA/HSUPA/DC-HSDPA,HSPA+), FDD-LTE, TDD-LTE WLAN, Bluetooth
<b>Frequency Band:</b>	GSM 850: 824-849 MHz(TX); 869-894 MHz(RX) PCS 1900: 1850-1910 MHz(TX); 1930-1990 MHz(RX) WCDMA Band 2: 1850-1910 MHz(TX); 1930-1990 MHz(RX) WCDMA Band 4: 1710-1755 MHz(TX); 2110-2155 MHz(RX) WCDMA Band 5: 824-849 MHz(TX); 869-894 MHz(RX) LTE Band 2: 1850-1910 MHz(TX); 1930-1990 MHz(RX) LTE Band 4: 1710-1755 MHz(TX) ; 2110-2155 MHz(RX) LTE Band 5: 824-849 MHz(TX) ; 869-894 MHz(RX) LTE Band 7: 2500-2570 MHz(TX); 2620-2690 MHz(RX) LTE Band 12: 699-716 MHz(TX); 729-746 MHz(RX) LTE Band 13:777-787 MHz(TX); 746-756 MHz(RX) LTE Band 17: 704-716 MHz(TX); 734-746 MHz(RX) LTE Band 26: 814-849 MHz(TX); 869-894 MHz(RX) LTE Band 38: 2570-2620 MHz(TX); 2570-2620 MHz(RX); LTE Band 41: 2496-2690 MHz(TX); 2496-2690 MHz(RX); WLAN (2.4G): 2412 -2462 MHz WLAN (5.2G): 5180-5240 MHz WLAN (5.6G): 5500-5700 MHz WLAN (5.8G): 5745-5825 MHz Bluetooth : 2402 MHz-2480 MHz

<b>Conducted RF Power:</b>	GSM 850 : 32.04 dBm PCS 1900: 30.26 dBm WCDMA Band 2: 23.00 dBm WCDMA Band 4: 22.96 dBm WCDMA Band 5: 23.51 dBm LTE Band 2: 22.55 dBm LTE Band 4: 23.29 dBm LTE Band 5: 24.23dBm LTE Band 7: 22.55 dBm LTE Band 12: 23.04 dBm LTE Band 13: 24.18 dBm LTE Band 26: 23.14 dBm LTE Band 38: 23.32 dBm LTE Band 41: 22.61 dBm WLAN (2.4G): 16.45 dBm WLAN (5.2G): 10.14 dBm WLAN (5.6G): 10.37 dBm WLAN (5.8G): 10.44 dBm Bluetooth(BDR/EDR): 5.59 dBm BLE: -3.37 dBm
<b>Power Source:</b>	Rechargeable Battery
<b>Normal Operation:</b>	Face up and Body

---

## REFERENCE, STANDARDS, AND GUIDELINES

---

### FCC:

The Report and Order requires routine SAR evaluation prior to equipment authorization of portable transmitter devices, including portable telephones. For consumer products, the applicable limit is 1.6 mW/g as recommended by the ANSI/IEEE standard C95.1-1992 [6] for an uncontrolled environment (Paragraph 65). According to the Supplement C of OET Bulletin 65 "Evaluating Compliance with FCC Guide-lines for Human Exposure to Radio frequency Electromagnetic Fields", released on Jun 29, 2001 by the FCC, the device should be evaluated at maximum output power (radiated from the antenna) under "worst-case" conditions for normal or intended use, incorporating normal antenna operating positions, device peak performance frequencies and positions for maximum RF energy coupling.

This report describes the methodology and results of experiments performed on wireless data terminal. The objective was to determine if there is RF radiation and if radiation is found, what is the extent of radiation with respect to safety limits. SAR (Specific Absorption Rate) is the measure of RF exposure determined by the amount of RF energy absorbed by human body (or its parts) – to determine how the RF energy couples to the body or head which is a primary health concern for body worn devices. The limit below which the exposure to RF is considered safe by regulatory bodies in North America is 1.6 mW/g average over 1 gram of tissue mass.

### CE:

The order requires routine SAR evaluation prior to equipment authorization of portable transmitter devices, including portable telephones. For consumer products, the applicable limit is 2 mW/g as recommended by EN62209-1 for an uncontrolled environment. According to the Standard, the device should be evaluated at maximum output power (radiated from the antenna) under "worst-case" conditions for normal or intended use, incorporating normal antenna operating positions, device peak performance frequencies and positions for maximum RF energy coupling.

This report describes the methodology and results of experiments performed on wireless data terminal. The objective was to determine if there is RF radiation and if radiation is found, what is the extent of radiation with respect to safety limits. SAR (Specific Absorption Rate) is the measure of RF exposure determined by the amount of RF energy absorbed by human body (or its parts) – to determine how the RF energy couples to the body or head which is a primary health concern for body worn devices. The limit below which the exposure to RF is considered safe by regulatory bodies in Europe is 2 mW/g average over 10 gram of tissue mass.

The test configurations were laid out on a specially designed test fixture to ensure the reproducibility of measurements. Each configuration was scanned for SAR. Analysis of each scan was carried out to characterize the above effects in the device.



**SAR Limits**

**FCC Limit**

EXPOSURE LIMITS	SAR (W/kg)	
	(General Population / Uncontrolled Exposure Environment)	(Occupational / Controlled Exposure Environment)
Spatial Average (averaged over the whole body)	0.08	0.4
Spatial Peak (averaged over any 1 g of tissue)	<b>1.60</b>	8.0
Spatial Peak (hands/wrists/feet/ankles averaged over 10 g)	4.0	20.0

**CE Limit**

EXPOSURE LIMITS	SAR (W/kg)	
	(General Population / Uncontrolled Exposure Environment)	(Occupational / Controlled Exposure Environment)
Spatial Average (averaged over the whole body)	0.08	0.4
Spatial Peak (averaged over any 10 g of tissue)	2.0	10
Spatial Peak (hands/wrists/feet/ankles averaged over 10 g)	4.0	20.0

Population/Uncontrolled Environments are defined as locations where there is the exposure of individual who have no knowledge or control of their exposure.

Occupational/Controlled Environments are defined as locations where there is exposure that may be incurred by people who are aware of the potential for exposure (i.e. as a result of employment or occupation).

General Population/Uncontrolled environments Spatial Peak limit 1.6W/kg (FCC) & 2 W/kg (CE) applied to the EUT.

## **FACILITIES**

---

The test site used by Bay Area Compliance Laboratories Corp. (Shenzhen) to collect data is located at 6/F., West Wing, Third Phase of Wanli Industrial Building, Shihua Road, Futian Free Trade Zone, Shenzhen, Guangdong, China.

The test site has been approved by the FCC under the KDB 974614 D01 and is listed in the FCC Public Access Link (PAL) database, FCC Registration No.: 342867, the FCC Designation No.: CN1221.

The test site has been registered with ISED Canada under ISED Canada Registration Number 3062B.

## DESCRIPTION OF TEST SYSTEM

These measurements were performed with the automated near-field scanning system DASY6 from Schmid & Partner Engineering AG (SPEAG) which is the Fifth generation of the system shown in the figure hereinafter:

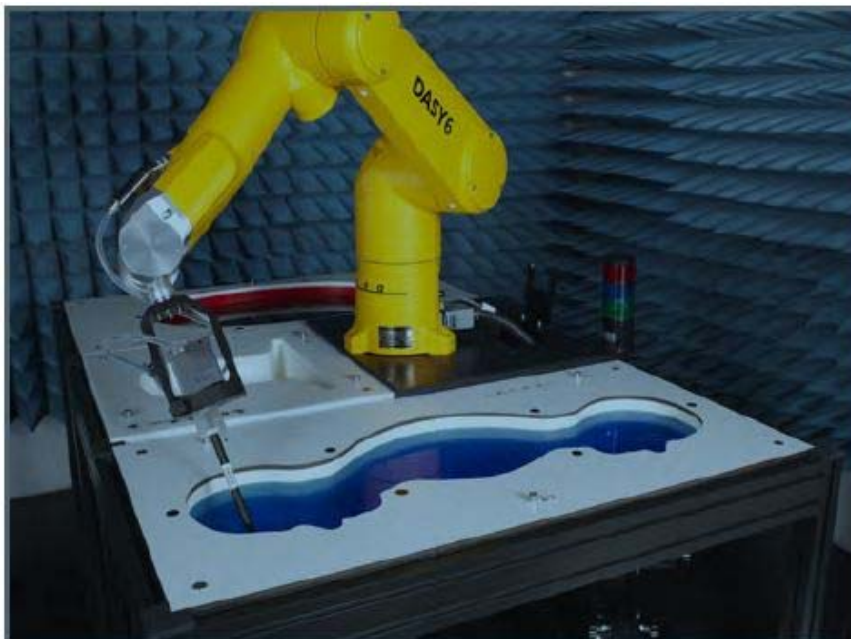

### DASY6 System Description

The DASY6 system for performing compliance tests consists of the following items:

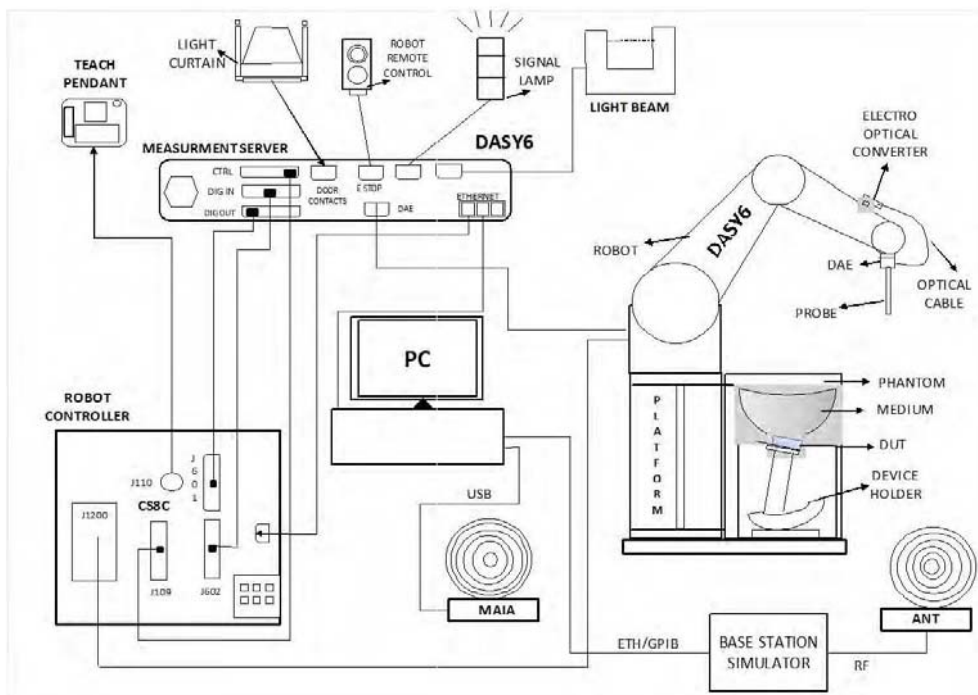

- A standard high precision 6-axis robot (Staubli TX=RX family) with controller, teach pendant and software. An arm extension for accommodating the data acquisition electronics (DAE).
- An isotropic field probe optimized and calibrated for the targeted measurement.
- A data acquisition electronics (DAE) which performs the signal application, signal multiplexing, AD-conversion, offset measurements, mechanical surface detection, collision detection, etc. The unit is battery powered with standard or rechargeable batteries. The signal is optically transmitted to the EOC.
- The Electro-optical converter (EOC) performs the conversion from optical to electrical signals for the digital communication to the DAE. To use optical surface detection, a special version of the EOC is required. The EOC signal is transmitted to the measurement server.
- The function of the measurement server is to perform the time critical tasks such as signal filtering, control of the robot operation and fast movement interrupts.
- The Light Beam used is for probe alignment. This improves the (absolute) accuracy of the probe positioning.
- A computer running Win7 professional operating system and the DASY52 software.
- Remote control and teach pendant as well as additional circuitry for robot safety such as warning lamps, etc.
- The phantom, the device holder and other accessories according to the targeted measurement.

### DASY6 Measurement Server

The DASY6 measurement server is based on a PC/104 CPU board with a 400 MHz Intel ULV Celeron, 128 MB chip-disk and 128 MB RAM. The necessary circuits for communication with the DAE4 (or DAE3) electronics box, as well as the 16-bit AD converter system for optical detection and digital I/O interface are contained on the DASY6 I/O board, which is directly connected to the PC/104 bus of the CPU board.



The measurement server performs all real-time data evaluations of field measurements and surface detection, controls robot movements, and handles safety operations. The PC operating system cannot interfere with these time-critical processes. All connections are supervised by a watchdog, and disconnection of any of the cables to the measurement server will automatically disarm the robot and disable all program-controlled robot movements. Furthermore, the measurement server is equipped with an expansion port, which is reserved for future applications. Please note that this expansion port does not have a standardized pinout, and therefore only devices provided by SPEAG can be connected. Connection of devices from any other supplier could seriously damage the measurement server.

### Data Acquisition Electronics

The data acquisition electronics (DAE4) consist of a highly sensitive electrometer-grade preamplifier with auto-zeroing, a channel and gain-switching multiplexer, a fast 16 bit AD-converter and a command decoder with a control logic unit. Transmission to the measurement server is accomplished through an optical downlink for data and status information, as well as an optical uplink for commands and the clock.

The mechanical probe mounting device includes two different sensor systems for frontal and sideways probe contacts. They are used for mechanical surface detection and probe collision detection.

The input impedance of both the DAE4 as well as of the DAE3 box is 200M $\Omega$ ; the inputs are symmetrical and floating. Common mode rejection is above 80 dB.

**EX3DV4 E-Field Probes**

<b>Frequency</b>	10 MHz to > 6 GHz Linearity: ± 0.2 dB (30 MHz to 6 GHz)
<b>Directivity</b>	± 0.3 dB in TSL (rotation around probe axis) ± 0.5 dB in TSL (rotation normal to probe axis)
<b>Dynamic Range</b>	10 µW/g to > 100 mW/g Linearity: ± 0.2 dB (noise: typically < 1 µW/g)
<b>Dimensions</b>	Overall length: 337 mm (Tip: 20 mm) Tip diameter: 2.5 mm (Body: 12 mm) Typical distance from probe tip to dipole centers: 1 mm
<b>Application</b>	High precision dosimetric measurements in any exposure scenario (e.g., very strong gradient fields); the only probe that enables compliance testing for frequencies up to 6 GHz with precision of better 30%.
<b>Compatibility</b>	DASY3, DASY4, DASY52 SAR and higher, EASY4/MRI

**SAM Twin Phantom**

The SAM Twin Phantom (shown in front of DASY6) is a fiberglass shell phantom with shell thickness 2 mm, except in the ear region where the thickness is increased to 6 mm. The phantom has three measurement areas: 1) Left Head, 2) Right Head, and 3) Flat Section. For larger devices, the use of the ELI-Phantom (shown behind DASY6) is required. For devices such as glasses with a wireless link, the Face Down Phantom is the most suitable (between the SAM Twin and ELI phantoms).

When the phantom is mounted inside allocated slot of the DASY6 platform, phantom reference points can be taught directly in the DASY5 V5.2 software. When the DASY6 platform is used to mount the

Phantom, some of the phantom teaching points cannot be reached by the robot in DASY5 V5.2. A special tool called P1a-P2aX-Former is provided to transform two of the three points, P1 and P2, to reachable locations. To use these new teaching points, a revised phantom configuration file is required.

In addition to our standard broadband liquids, the phantom can be used with the following tissue simulating liquids:

Sugar-water-based liquids can be left permanently in the phantom. Always cover the liquid when the system is not in use to prevent changes in liquid parameters due to water evaporation.

DGBE-based liquids should be used with care. As DGBE is a softener for most plastics, the liquid should be taken out of the phantom, and the phantom should be dried when the system is not in use (desirable at least once a week).

Do not use other organic solvents without previously testing the solvent resistivity of the phantom. Approximately 25 liters of liquid is required to fill the SAM Twin phantom.

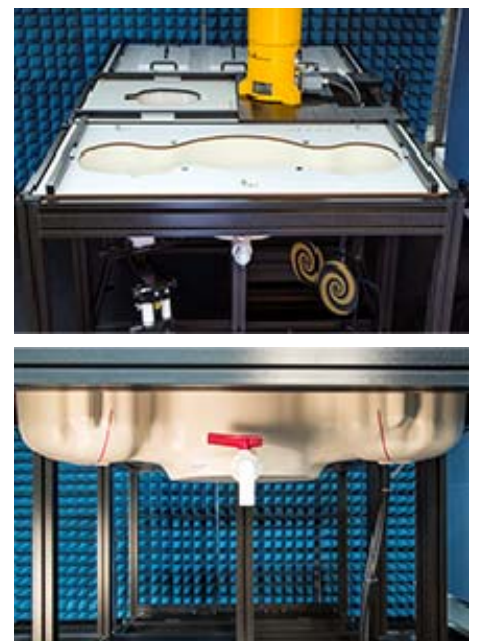

## ELI Phantom

The ELI phantom is intended for compliance testing of handheld and body-mounted wireless devices in the frequency range of 30MHz to 6 GHz. ELI is fully compatible with the latest draft of the standard IEC 62209-2 and the use of all known tissue simulating liquids. ELI has been optimized for performance and can be integrated into a SPEAG standard phantom table. A cover is provided to prevent evaporation of water and changes in liquid parameters. Reference markings on the phantom allow installation of the complete setup, including all predefined phantom positions and measurement grids, by teaching three points.

The phantom can be used with the following tissue simulating liquids:

- Sugar-water-based liquids can be left permanently in the phantom. Always cover the liquid when the system is not in use to prevent changes in liquid parameters due to water evaporation.
- DGBE-based liquids should be used with care. As DGBE is a softener for most plastics, the liquid should be taken out of the phantom, and the phantom should be dried when the system is not in use (desirable at least once a week).
- Do not use other organic solvents without previously testing the solvent resistivity of the phantom.

Approximately 25 liters of liquid is required to fill the ELI phantom.

## Robots

The DASY6 system uses the high-precision industrial robots TX60L, TX90XL, and RX160L from Staubli SA (France). The TX robot family - the successor of the well-known RX robot family - continues to offer the features important for DASY6 applications:

- High precision (repeatability 0.02mm)
- High reliability (industrial design)
- Low maintenance costs (virtually maintenance free due to direct drive gears; no belt drives)
- Jerk-free straight movements (brushless synchrony motors; no stepper motors)
- Low ELF interference (motor control fields shielded via the closed metallic construction shields)

The robots are controlled by the Staubli CS8c robot controllers. All information regarding the use and maintenance of the robot arm and the robot controller is provided

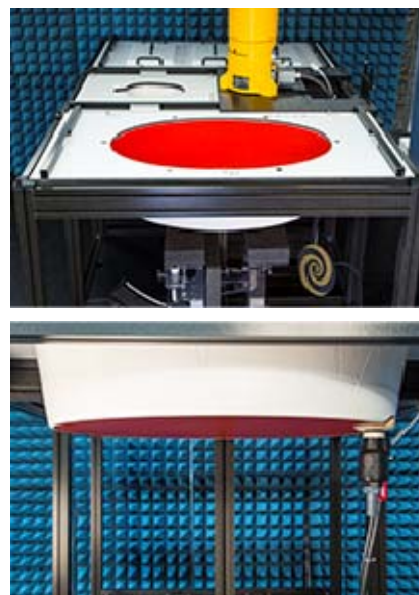

**Calibration Frequency Points for EX3DV4 E-Field Probes SN: 7520 Calibrated: 2019/09/26**

Calibration Frequency Point(MHz)	Frequency Range(MHz)		Conversion Factor		
	From	To	X	Y	Z
150 Head	100	200	12.14	12.14	12.14
750 Head	650	810	9.87	9.87	9.87
850 Head	810	935	9.71	9.71	9.71
1750 Head	1650	1810	8.62	8.62	8.62
1900 Head	1810	1920	8.17	8.17	8.17
2000 Head	1920	2100	8.15	8.15	8.15
2300 Head	2200	2399	7.86	7.86	7.86
2450 Head	2399	2500	7.57	7.57	7.57
2600 Head	2500	2700	7.37	7.37	7.37
5250 Head	5140	5360	5.51	5.51	5.51
5600 Head	5490	5700	4.85	4.85	4.85
5800 Head	5700	5910	5.00	5.00	5.00

**Area Scans**

Area scans are defined prior to the measurement process being executed with a user defined variable spacing between each measurement point (integral) allowing low uncertainty measurements to be conducted. Scans defined for FCC applications utilize a 15mm 2 step integral, with 1.5mm interpolation used to locate the peak SAR area used for zoom scan assessments.

Where the system identifies multiple SAR peaks (which are within 25% of peak value) the system will provide the user with the option of assessing each peak location individually for zoom scan averaging.

**Zoom Scan (Cube Scan Averaging)**

The averaging zoom scan volume utilized in the DASY5 software is in the shape of a cube and the side dimension of a 1 g or 10 g mass is dependent on the density of the liquid representing the simulated tissue. A density of 1000 kg/m<sup>3</sup> is used to represent the head and body tissue density and not the phantom liquid density, in order to be consistent with the definition of the liquid dielectric properties, i.e. the side length of the 1g cube is 10mm, with the side length of the 10g cube is 21.5mm.

When the cube intersects with the surface of the phantom, it is oriented so that 3 vertices touch the surface of the shell or the center of a face is tangent to the surface. The face of the cube closest to the surface is modified in order to conform to the tangent surface.

The zoom scan integer steps can be user defined so as to reduce uncertainty, but normal practice for typical test applications (including FCC) utilize a physical step of 7 x 7 x 7 (5mmx5mmx5mm) providing a volume of 30 mm in the X & Y & Z axis.

## Tissue Dielectric Parameters for Head and Body Phantoms

The head tissue dielectric parameters recommended by the IEC 62209-1:2016

### Recommended Tissue Dielectric Parameters for Head and Body

**Table A.3 – Dielectric properties of the head tissue-equivalent liquid**

Frequency MHz	Relative permittivity $\epsilon_r$	Conductivity ( $\sigma$ ) S/m
300	45,3	0,87
450	43,5	0,87
<i>750</i>	<i>41,9</i>	<i>0,89</i>
835	41,5	0,90
900	41,5	0,97
1 450	40,5	1,20
<i>1 500</i>	<i>40,4</i>	<i>1,23</i>
<i>1 640</i>	<i>40,2</i>	<i>1,31</i>
<i>1 750</i>	<i>40,1</i>	<i>1,37</i>
1 800	40,0	1,40
1 900	40,0	1,40
2 000	40,0	1,40
<i>2 100</i>	<i>39,8</i>	<i>1,49</i>
<i>2 300</i>	<i>39,5</i>	<i>1,67</i>
2 450	39,2	1,80
<i>2 600</i>	<i>39,0</i>	<i>1,96</i>
3 000	38,5	2,40
<i>3 500</i>	<i>37,9</i>	<i>2,91</i>
<i>4 000</i>	<i>37,4</i>	<i>3,43</i>
<i>4 500</i>	<i>36,8</i>	<i>3,94</i>
<i>5 000</i>	<i>36,2</i>	<i>4,45</i>
<i>5 200</i>	<i>36,0</i>	<i>4,66</i>
<i>5 400</i>	<i>35,8</i>	<i>4,86</i>
<i>5 600</i>	<i>35,5</i>	<i>5,07</i>
<i>5 800</i>	<i>35,3</i>	<i>5,27</i>
6 000	35,1	5,48

NOTE For convenience, permittivity and conductivity values at those frequencies which are not part of the original data provided by Drossos et al. [33] or the extension to 5 800 MHz are provided (i.e. the values shown *in italics*). These values were linearly interpolated between the values in this table that are immediately above and below these values, except the values at 6 000 MHz that were linearly extrapolated from the values at 3 000 MHz and 5 800 MHz.



## EQUIPMENT LIST AND CALIBRATION

### Equipments List & Calibration Information

Equipment	Model	S/N	Calibration Date	Calibration Due Date
DASY5 Test Software	DASY52 52.10.2	N/A	NCR	NCR
DASY6 Measurement Server	DASY6 6.0.31	N/A	NCR	NCR
Data Acquisition Electronics	DAE4	1561	2019/9/13	2020/9/13
E-Field Probe	EX3DV4	7520	2019/9/26	2020/9/26
Mounting Device	MD4HHTV5	SD 000 H01 KA	NCR	NCR
SAM Twin Phantom	SAM-Twin V8.0	1962	NCR	NCR
ELI Phantom	ELI V8.0	2092	NCR	NCR
Dipole, 750MHz	D750V3	1194	2020/01/13	2023/01/13
Dipole, 900MHz	D900V2	132	2017/10/10	2020/10/10
Dipole, 1800MHz	D1800V2	2d018	2017/10/11	2020/10/11
Dipole, 1900MHz	D1900V2	5d231	2020/01/14	2023/01/14
Dipole, 2450MHz	D2450V2	751	2017/10/12	2020/10/12
Dipole, 2600MHz	D2600V2	1162	2019/10/02	2022/10/02
Dipole, 5GHz	D5GHZV2	1301	2020/01/10	2023/01/10
Simulated Tissue Liquid Head	HBBL600-10000V6	180622-2	Each Time	
Network Analyzer	8753D	3410A08288	2019/04/25	2020/04/25
Dielectric Assessment Kit	DAK-3.5	1248	NCR	NCR
Anritsu Signal Generator	68369B	4114	2019/07/09	2020/07/09
Power Meter	E4419B	GB39511341	2019/06/23	2020/06/23
Power Amplifier	5S1G4	71377	NCR	NCR
Directional Coupler	4242-10	3307	NCR	NCR
Attenuator	3dB	5402	NCR	NCR
Attenuator	10dB	AU 3842	NCR	NCR
R&S, universal Radio Communication Tester	CMU200	106891	2020/01/15	2021/01/15
Wireless communication tester	8960	MY50266471	2019/4/25	2020/4/25
WIDEBAND RADIO COMMUNICATION TESTER	CMW500	1201.002K50-146520-wh	2019/6/23	2020/6/23

# SAR MEASUREMENT SYSTEM VERIFICATION

## Liquid Verification

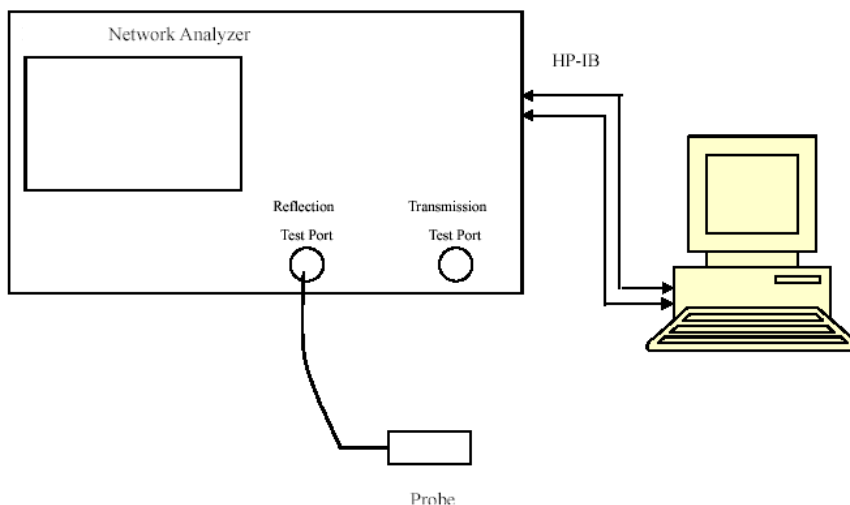

Liquid Verification Setup Block Diagram

## Liquid Verification Results

Frequency (MHz)	Liquid Type	Liquid Parameter		Target Value		Delta (%)		Tolerance (%)
		$\epsilon_r$	$\sigma$ (S/m)	$\epsilon_r$	$\sigma$ (S/m)	$\Delta\epsilon_r$	$\Delta\sigma$	
704	Simulated Tissue Liquid	43.157	0.885	42.18	0.89	2.32	-0.56	±5
707.5	Simulated Tissue Liquid	42.968	0.883	42.16	0.89	1.92	-0.79	±5
709	Simulated Tissue Liquid	43.183	0.887	42.15	0.89	2.45	-0.34	±5
710	Simulated Tissue Liquid	43.034	0.89	42.15	0.89	2.1	0	±5
711	Simulated Tissue Liquid	42.728	0.889	42.14	0.89	1.4	-0.11	±5
750	Simulated Tissue Liquid	43.058	0.895	41.90	0.89	2.76	0.56	±5
782	Simulated Tissue Liquid	41.619	0.91	41.75	0.89	-0.31	2.25	±5

\*Liquid Verification above was performed on 2020/02/10.

Frequency (MHz)	Liquid Type	Liquid Parameter		Target Value		Delta (%)		Tolerance (%)
		$\epsilon_r$	$\sigma$ (S/m)	$\epsilon_r$	$\sigma$ (S/m)	$\Delta\epsilon_r$	$\Delta\sigma$	
821.5	Simulated Tissue Liquid Head	41.791	0.892	41.56	0.89	0.56	0.22	±5
824.2	Simulated Tissue Liquid Head	41.435	0.891	41.55	0.89	-0.28	0.11	±5
826.4	Simulated Tissue Liquid Head	41.73	0.903	41.54	0.89	0.46	1.46	±5
829	Simulated Tissue Liquid Head	41.579	0.902	41.53	0.90	0.12	0.22	±5
831.5	Simulated Tissue Liquid Head	41.466	0.904	41.51	0.90	-0.11	0.44	±5
835	Simulated Tissue Liquid Head	41.694	0.907	41.5	0.90	0.47	0.78	±5
836.5	Simulated Tissue Liquid Head	41.776	0.906	41.5	0.90	0.67	0.67	±5
836.6	Simulated Tissue Liquid Head	41.604	0.927	41.5	0.90	0.25	3	±5
841.5	Simulated Tissue Liquid Head	42.009	0.931	41.5	0.90	1.23	3.44	±5
844	Simulated Tissue Liquid Head	41.581	0.936	41.5	0.91	0.2	2.86	±5
846.6	Simulated Tissue Liquid Head	41.696	0.937	41.5	0.91	0.47	2.97	±5
848.8	Simulated Tissue Liquid Head	41.527	0.948	41.5	0.91	0.07	4.18	±5
900	Simulated Tissue Liquid Head	41.735	0.962	41.5	0.97	0.57	-0.82	±5

\*Liquid Verification above was performed on 2020/02/11.

Frequency (MHz)	Liquid Type	Liquid Parameter		Target Value		Delta (%)		Tolerance (%)
		$\epsilon_r$	$\sigma$ (S/m)	$\epsilon_r$	$\sigma$ (S/m)	$\Delta\epsilon_r$	$\Delta\sigma$	
1712.4	Simulated Tissue Liquid Head	40.937	1.344	40.13	1.34	2.01	0.3	±5
1720	Simulated Tissue Liquid Head	41.58	1.365	40.13	1.35	3.61	1.11	±5
1732.5	Simulated Tissue Liquid Head	41.577	1.378	40.12	1.36	3.63	1.32	±5
1732.6	Simulated Tissue Liquid Head	40.682	1.379	40.11	1.36	1.43	1.4	±5
1745	Simulated Tissue Liquid Head	41.625	1.382	40.1	1.37	3.8	0.88	±5
1752.6	Simulated Tissue Liquid Head	41.579	1.395	40.1	1.38	3.69	1.09	±5
1800	Simulated Tissue Liquid Head	40.082	1.401	40.0	1.40	0.21	0.07	±5

\*Liquid Verification above was performed on 2020/02/10.

Frequency (MHz)	Liquid Type	Liquid Parameter		Target Value		Delta (%)		Tolerance (%)
		$\epsilon_r$	$\sigma$ (S/m)	$\epsilon_r$	$\sigma$ (S/m)	$\Delta\epsilon_r$	$\Delta\sigma$	
1850.2	Simulated Tissue Liquid Head	41.161	1.402	40.0	1.40	2.9	0.14	±5
1852.4	Simulated Tissue Liquid Head	40.404	1.414	40.0	1.40	1.01	1	±5
1860	Simulated Tissue Liquid Head	40.658	1.41	40.0	1.40	1.65	0.71	±5
1880	Simulated Tissue Liquid Head	40.704	1.415	40.0	1.40	1.76	1.07	±5
1900	Simulated Tissue Liquid Head	40.821	1.429	40.0	1.40	2.05	2.07	±5
1907.6	Simulated Tissue Liquid Head	40.931	1.426	40.0	1.40	2.33	1.86	±5
1909.8	Simulated Tissue Liquid Head	40.318	1.443	40.0	1.40	0.79	3.07	±5

\*Liquid Verification above was performed on 2020/02/12.

Frequency (MHz)	Liquid Type	Liquid Parameter		Target Value		Delta (%)		Tolerance (%)
		$\epsilon_r$	$\sigma$ (S/m)	$\epsilon_r$	$\sigma$ (S/m)	$\Delta\epsilon_r$	$\Delta\sigma$	
2412	Simulated Tissue Liquid Head	39.356	1.742	39.28	1.77	0.19	-1.58	±5
2437	Simulated Tissue Liquid Head	39.125	1.774	39.22	1.79	-0.24	-0.89	±5
2450	Simulated Tissue Liquid Head	39.163	1.783	39.20	1.80	-0.09	-0.94	±5
2462	Simulated Tissue Liquid Head	39.477	1.827	39.17	1.82	0.78	0.38	±5

\*Liquid Verification above was performed on 2020/02/11.

Frequency (MHz)	Liquid Type	Liquid Parameter		Target Value		Delta (%)		Tolerance (%)
		$\epsilon_r$	$\sigma$ (S/m)	$\epsilon_r$	$\sigma$ (S/m)	$\Delta\epsilon_r$	$\Delta\sigma$	
2506	Simulated Tissue Liquid Head	39.933	1.898	39.12	1.87	2.08	1.5	±5
2510	Simulated Tissue Liquid Head	39.538	1.905	39.12	1.87	1.07	1.87	±5
2535	Simulated Tissue Liquid Head	39.38	1.914	39.09	1.89	0.74	1.27	±5
2560	Simulated Tissue Liquid Head	39.47	1.928	39.05	1.92	1.08	0.42	±5
2580	Simulated Tissue Liquid Head	39.66	1.942	39.02	1.94	1.64	0.1	±5
2593	Simulated Tissue Liquid Head	39.653	1.957	39.00	1.96	1.67	-0.15	±5
2595	Simulated Tissue Liquid Head	39.331	1.982	39.00	1.96	0.85	1.12	±5
2600	Simulated Tissue Liquid Head	39.658	1.989	39.00	1.96	1.69	1.48	±5
2610	Simulated Tissue Liquid Head	39.313	1.995	38.99	1.96	0.83	1.79	±5
2680	Simulated Tissue Liquid Head	39.062	2.016	38.89	2.04	0.44	-1.18	±5

\*Liquid Verification above was performed on 2020/02/13.

Frequency (MHz)	Liquid Type	Liquid Parameter		Target Value		Delta (%)		Tolerance (%)
		$\epsilon_r$	$\sigma$ (S/m)	$\epsilon_r$	$\sigma$ (S/m)	$\Delta\epsilon_r$	$\Delta\sigma$	
5180	Simulated Tissue Liquid Head	36.964	4.688	36.02	4.65	2.62	0.82	±5
5200	Simulated Tissue Liquid Head	35.731	4.702	36.00	4.66	-0.75	0.9	±5
5240	Simulated Tissue Liquid Head	35.11	4.711	35.96	4.70	-2.36	0.23	±5
5250	Simulated Tissue Liquid Head	35.157	4.712	35.95	4.70	-2.21	0.26	±5
5500	Simulated Tissue Liquid Head	36.099	4.715	35.94	4.72	0.44	-0.11	±5
5580	Simulated Tissue Liquid Head	35.846	4.732	35.92	4.74	-0.21	-0.17	±5
5600	Simulated Tissue Liquid Head	37.003	4.836	35.50	5.07	4.23	-4.62	±5
5700	Simulated Tissue Liquid Head	35.617	4.922	35.40	5.17	0.61	-4.8	±5
5745	Simulated Tissue Liquid Head	36.85	4.962	35.36	5.21	4.21	-4.76	±5
5785	Simulated Tissue Liquid Head	35.859	4.998	35.32	5.26	1.53	-4.98	±5
5800	Simulated Tissue Liquid Head	34.97	5.095	35.30	5.27	-0.93	-3.32	±5
5825	Simulated Tissue Liquid Head	36.067	5.126	35.28	5.29	2.23	-3.1	±5

\*Liquid Verification above was performed on 2020/02/12

### System Accuracy Verification

Prior to the assessment, the system validation kit was used to test whether the system was operating within its specifications of  $\pm 10\%$ . The validation results are tabulated below. And also the corresponding SAR plot is attached as well in the SAR plots files.

The spacing distances in the **System Verification Setup Block Diagram** is given by the following:

- a)  $s = 15 \text{ mm} \pm 0,2 \text{ mm}$  for  $300 \text{ MHz} \leq f \leq 1\ 000 \text{ MHz}$ ;
- b)  $s = 10 \text{ mm} \pm 0,2 \text{ mm}$  for  $1\ 000 \text{ MHz} < f \leq 3\ 000 \text{ MHz}$ ;
- c)  $s = 10 \text{ mm} \pm 0,2 \text{ mm}$  for  $3\ 000 \text{ MHz} < f \leq 6\ 000 \text{ MHz}$ .

### System Verification Setup Block Diagram

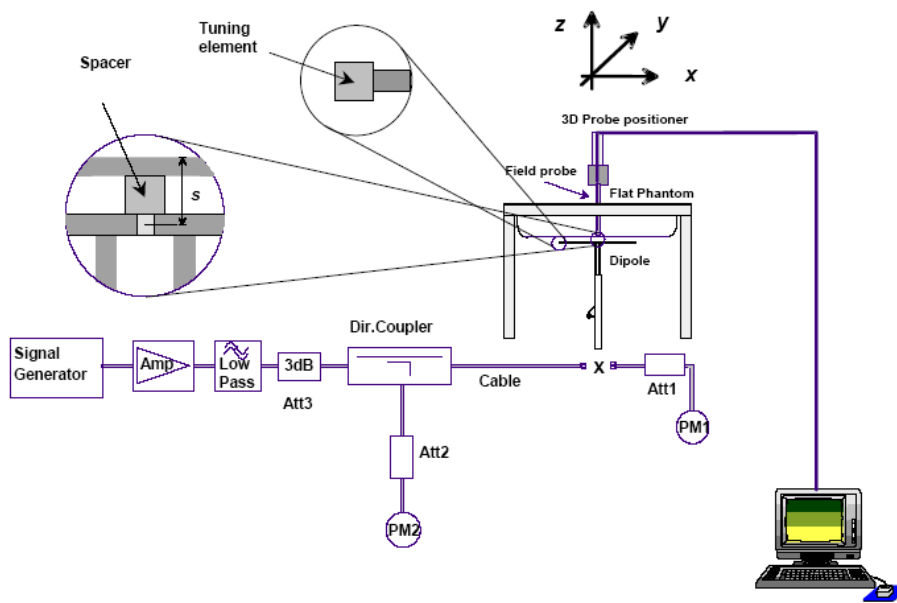

### System Accuracy Check Results

Date	Frequency Band (MHz)	Liquid Type	Input Power (mW)	Measured SAR (W/kg)	Normalized to 1W (W/kg)	Target Value (W/Kg)	Delta (%)	Tolerance (%)
2020/02/10	750	Head	100	1g 0.812	8.12	8.55	-5.029	$\pm 10$
2020/02/11	900	Head	100	1g 1.02	10.2	10.9	-6.422	$\pm 10$
2020/02/10	1800	Head	100	1g 3.75	37.5	38.5	-2.597	$\pm 10$
2020/02/12	1900	Head	100	1g 4.09	40.9	40.3	1.489	$\pm 10$
2020/02/11	2450	Head	100	1g 5.19	51.9	51.7	0.387	$\pm 10$
2020/02/13	2600	Head	100	1g 5.62	56.2	55.4	1.444	$\pm 10$
2020/02/12	5800	Head	250	1g 18.6	74.4	80.2	-7.232	$\pm 10$

\*The SAR values above are normalized to 1 Watt forward power.

### SAR SYSTEM VALIDATION DATA

#### System Performance 750 MHz Head

**DUT: Dipole 750 MHz; Type: D750V3; Serial: 1194**

Communication System: UID 0, CW (0); Frequency: 750 MHz; Duty Cycle: 1:1  
 Medium parameters used:  $f = 750 \text{ MHz}$ ;  $\sigma = 0.895 \text{ S/m}$ ;  $\epsilon_r = 43.058$ ;  $\rho = 1000 \text{ kg/m}^3$   
 Phantom section: Flat Section

DASY5 Configuration:

- Probe: EX3DV4 - SN7520; ConvF(9.87, 9.87, 9.87) @ 750 MHz;
- Sensor-Surface: 4mm (Mechanical Surface Detection)
- Electronics: DAE4 Sn1561; Calibrated: 2019/09/13
- Phantom: SAM-Twin V8.0 P1aP2a; Type: QD 000 P41 AA ; Serial: 1962
- Measurement SW: DASY52, Version 52.10 (2);

**Head 750MHz Pin=100mW /Area Scan (101x161x1):** Interpolated grid:  $dx=1.000 \text{ mm}$ ,  $dy=1.000 \text{ mm}$   
 Maximum value of SAR (interpolated) = 0.984 W/kg

**Head 750MHz Pin=100mW /Zoom Scan (7x7x7)/Cube 0:** Measurement grid:  $dx=5\text{mm}$ ,  $dy=5\text{mm}$ ,  $dz=5\text{mm}$   
 Reference Value = 36.33 V/m; Power Drift = -0.15 dB  
 Peak SAR (extrapolated) = 1.31 W/kg  
**SAR(1 g) = 0.812 W/kg; SAR(10 g) = 0.559 W/kg**  
 Maximum value of SAR (measured) = 0.849 W/kg

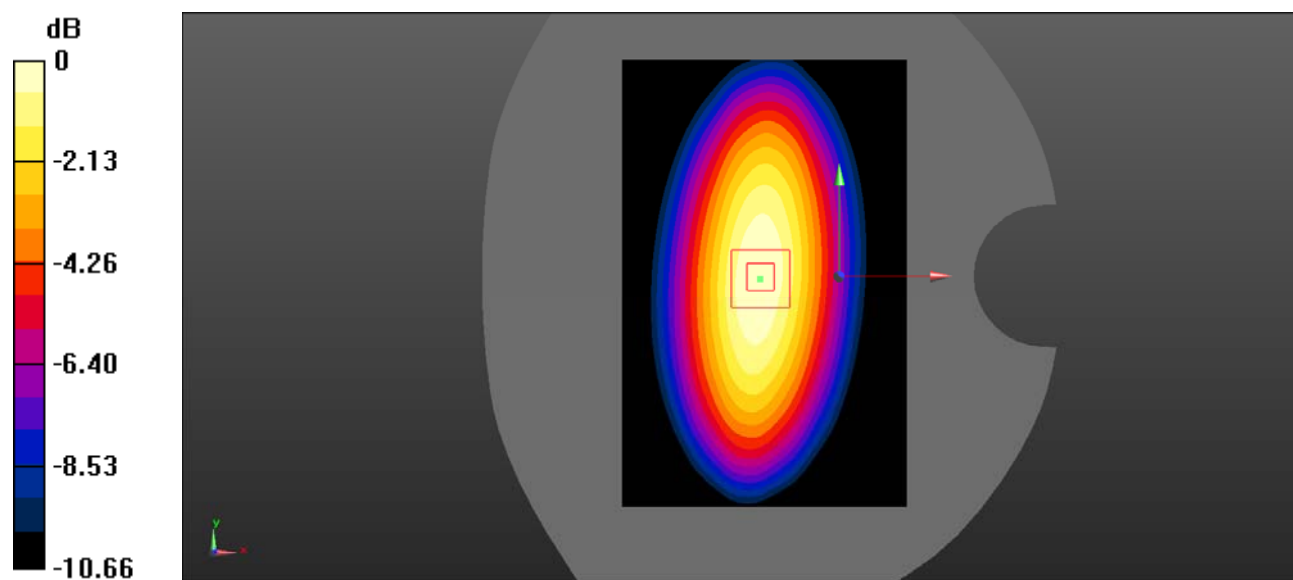

0 dB = 0.849 W/kg = -0.71 dBW/kg

**System Performance 900 MHz Head**

**DUT: Dipole 900 MHz; Type: D900V2; Serial: 132**

Communication System: UID 0, CW (0); Frequency: 900 MHz; Duty Cycle: 1:1  
 Medium parameters used:  $f = 900 \text{ MHz}$ ;  $\sigma = 0.962 \text{ S/m}$ ;  $\epsilon_r = 41.735$ ;  $\rho = 1000 \text{ kg/m}^3$   
 Phantom section: Flat Section

DASY5 Configuration:

- Probe: EX3DV4 - SN7520; ConvF(9.71, 9.71, 9.71) @ 900 MHz;
- Sensor-Surface: 4mm (Mechanical Surface Detection)
- Electronics: DAE4 Sn1561; Calibrated: 2019/09/13
- Phantom: SAM-Twin V8.0 P1aP2a; Type: QD 000 P41 AA ; Serial: 1962
- Measurement SW: DASY52, Version 52.10 (2);

**Head 900MHz Pin=100mW/Area Scan (101x141x1):** Interpolated grid:  $dx=1.000 \text{ mm}$ ,  $dy=1.000 \text{ mm}$   
 Maximum value of SAR (interpolated) = 1.27 W/kg

**Head 900MHz Pin=100mW/Zoom Scan (7x7x7)/Cube 0:** Measurement grid:  $dx=5\text{mm}$ ,  $dy=5\text{mm}$ ,  $dz=5\text{mm}$   
 Reference Value = 34.45 V/m; Power Drift = -0.02 dB  
 Peak SAR (extrapolated) = 1.55 W/kg  
**SAR(1 g) = 1.02 W/kg; SAR(10 g) = 0.631W/kg**  
 Maximum value of SAR (measured) = 1.16W/kg

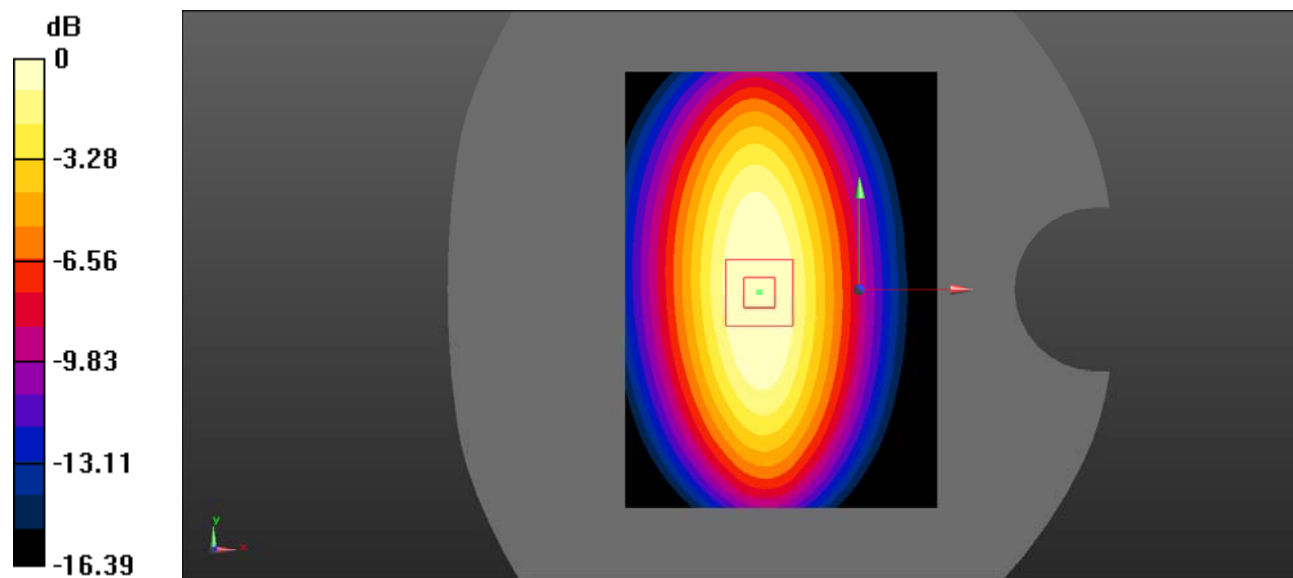

0 dB = 1.16 W/kg = 0.64 dBW/kg

**System Performance 1800 MHz Head**

**DUT: Dipole 1800 MHz; Type: D1800V2; Serial: 2d018**

Communication System: UID 0, CW (0); Frequency: 1800 MHz; Duty Cycle: 1:1  
 Medium parameters used:  $f = 1800 \text{ MHz}$ ;  $\sigma = 1.401 \text{ S/m}$ ;  $\epsilon_r = 40.082$ ;  $\rho = 1000 \text{ kg/m}^3$   
 Phantom section: Flat Section

DASY5 Configuration:

- Probe: EX3DV4 - SN7520; ConvF(8.62, 8.62, 8.62) @ 1800 MHz;
- Sensor-Surface: 4mm (Mechanical Surface Detection)
- Electronics: DAE4 Sn1561; Calibrated: 2019/09/13
- Phantom: SAM-Twin V8.0 P1aP2a; Type: QD 000 P41 AA ; Serial: 1962
- Measurement SW: DASY52, Version 52.10 (2);

**Head 1800MHz Pin=100mW/Area Scan (81x121x1):** Interpolated grid:  $dx=1.000 \text{ mm}$ ,  $dy=1.000 \text{ mm}$   
 Maximum value of SAR (interpolated) = 4.14 W/kg

**Head 1800MHz Pin=100mW/Zoom Scan (7x7x7)/Cube 0:** Measurement grid:  $dx=5\text{mm}$ ,  $dy=5\text{mm}$ ,  $dz=5\text{mm}$   
 Reference Value = 50.01 V/m; Power Drift = 0.06 dB  
 Peak SAR (extrapolated) = 4.34 W/kg  
**SAR(1 g) = 3.75 W/kg; SAR(10 g) = 2.03 W/kg**  
 Maximum value of SAR (measured) = 4.12 W/kg

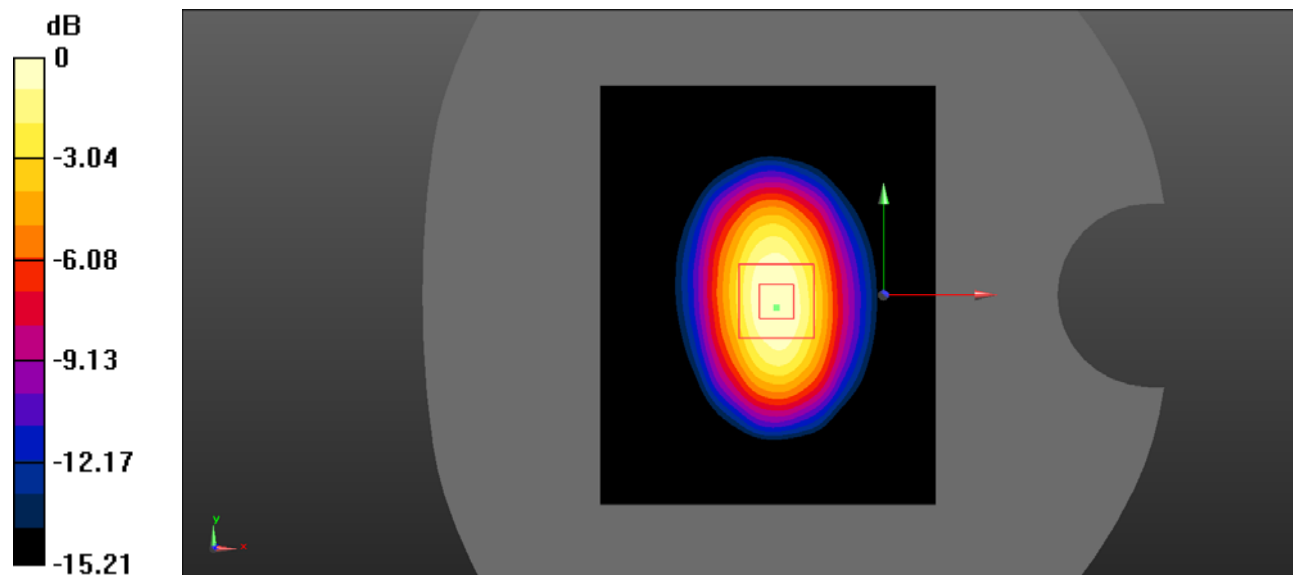

0 dB = 4.12 W/kg = 6.15 dBW/kg



**System Performance 1900 MHz Head**

**DUT: Dipole 1900MHz; Type: D1900V2; Serial: 5d231**

Communication System: CW; Frequency: 1900 MHz; Duty Cycle: 1:1

Medium parameters used:  $f = 1900 \text{ MHz}$ ;  $\sigma = 1.429 \text{ S/m}$ ;  $\epsilon_r = 40.821$ ;  $\rho = 1000 \text{ kg/m}^3$

Phantom section: Flat Section

DASY5 Configuration:

- Probe: EX3DV4 - SN7520; ConvF(8.17, 8.17,8.17) @ 1900 MHz;
- Sensor-Surface: 4mm (Mechanical Surface Detection)
- Electronics: DAE4 Sn1561; Calibrated: 2019/09/13
- Phantom: SAM-Twin V8.0 P1aP2a; Type: QD 000 P41 AA ; Serial: 1962
- Measurement SW: DASY52, Version 52.10 (2);

**Head 1900MHz Pin=100mW/Area Scan (81x121x1):** Interpolated grid:  $dx=1.000 \text{ mm}$ ,  $dy=1.000 \text{ mm}$

Maximum value of SAR (interpolated) = 5.32 W/kg

**Head 1900MHz Pin=100mW/Zoom Scan (7x7x7)/Cube 0:** Measurement grid:  $dx=5\text{mm}$ ,  $dy=5\text{mm}$ ,  $dz=5\text{mm}$

Reference Value = 56.22 V/m; Power Drift = -0.02 dB

Peak SAR (extrapolated) = 5.41 W/kg

**SAR(1 g) = 4.09 W/kg; SAR(10 g) = 2.05 W/kg**

Maximum value of SAR (measured) = 4.32 W/kg

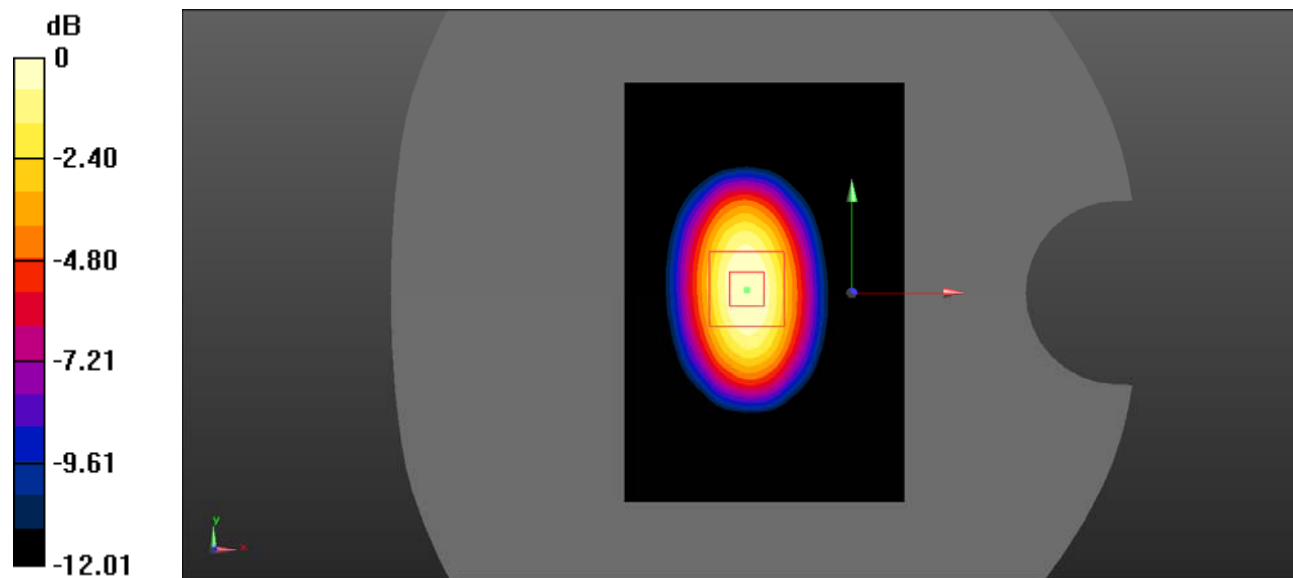

0 dB = 4.32 W/kg = 6.35 dBW/kg

**System Performance 2450 Head**

**DUT: Dipole 2450 MHz; Type: D2450V2; Serial: 751**

Communication System: UID 0, CW (0); Frequency: 2450 MHz; Duty Cycle: 1:1  
 Medium parameters used:  $f = 2450 \text{ MHz}$ ;  $\sigma = 1.783 \text{ S/m}$ ;  $\epsilon_r = 39.163$ ;  $\rho = 1000 \text{ kg/m}^3$   
 Phantom section: Flat Section

DASY5 Configuration:

- Probe: EX3DV4 - SN7520; ConvF(7.57, 7.57, 7.57) @ 2450 MHz;
- Sensor-Surface: 4mm (Mechanical Surface Detection)
- Electronics: DAE4 Sn1561; Calibrated: 2019/09/13
- Phantom: SAM-Twin V8.0 P1aP2a; Type: QD 000 P41 AA ; Serial: 1962
- Measurement SW: DASY52, Version 52.10 (2);

**Head 2450MHz Pin=100mW/Area Scan (81x121x1):** Interpolated grid:  $dx=1.000 \text{ mm}$ ,  $dy=1.000 \text{ mm}$   
 Maximum value of SAR (interpolated) = 6.12 W/kg

**Head 2450MHz Pin=100mW/Zoom Scan (7x7x7)/Cube 0:** Measurement grid:  $dx=5\text{mm}$ ,  $dy=5\text{mm}$ ,  $dz=5\text{mm}$   
 Reference Value = 52.35 V/m; Power Drift = -0.05 dB  
 Peak SAR (extrapolated) = 8.59 W/kg  
**SAR(1 g) = 5.19W/kg; SAR(10 g) = 2.34 W/kg**  
 Maximum value of SAR (measured) = 5.62 W/kg

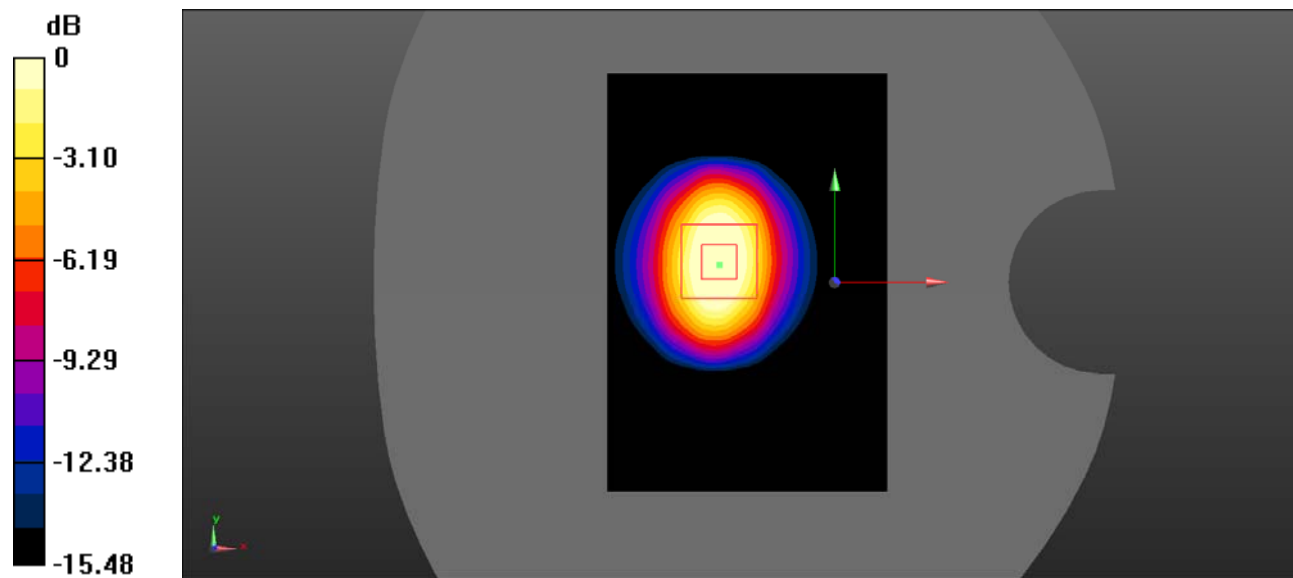

0 dB = 5.62 W/kg = 7.50 dBW/kg

**System Performance 2600 Head**

**DUT: Dipole 2600 Type: D2600V2; Serial: 1162**

Communication System: UID 0, CW (0); Frequency: 2600 MHz; Duty Cycle: 1:1  
 Medium parameters used:  $f = 2600$  MHz;  $\sigma = 1.989$  S/m;  $\epsilon_r = 39.658$ ;  $\rho = 1000$  kg/m<sup>3</sup>  
 Phantom section: Flat Section

DASY5 Configuration:

- Probe: EX3DV4 - SN7520; ConvF(7.37, 7.37, 7.37) @ 2600 MHz;
- Sensor-Surface: 4mm (Mechanical Surface Detection)
- Electronics: DAE4 Sn1561; Calibrated: 2019/09/13
- Phantom: SAM-Twin V8.0 P1aP2a; Type: QD 000 P41 AA ; Serial: 1962
- Measurement SW: DASY52, Version 52.10 (2);

**Head 2600MHz Pin=100mW/Area Scan (81x121x1):** Interpolated grid: dx=1.000 mm, dy=1.000 mm

Maximum value of SAR (interpolated) = 8.49 W/kg

**Head 2600MHz Pin=100mW/Zoom Scan (7x7x7)/Cube 0:** Measurement grid: dx=5mm, dy=5mm, dz=5mm

Reference Value = 53.38V/m; Power Drift = -0.03 dB

Peak SAR (extrapolated) = 9.36 W/kg

**SAR(1 g) = 5.62 W/kg; SAR(10 g) = 2.53 W/kg**

Maximum value of SAR (measured) = 6.42W/kg

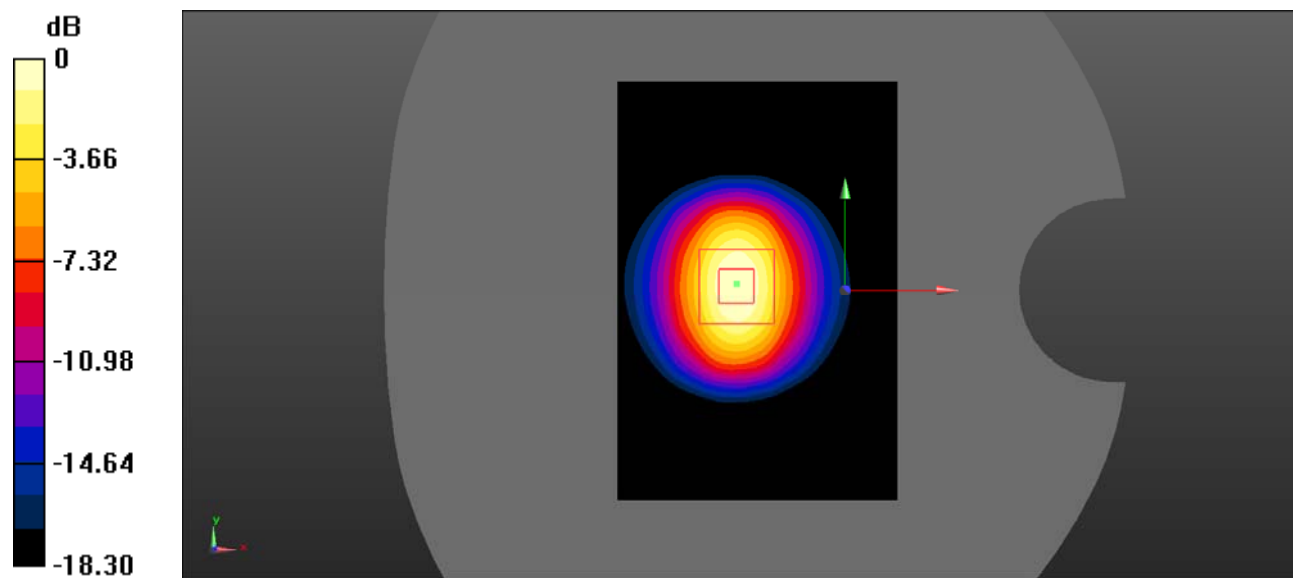

0 dB = 6.42 W/kg = 8.08 dBW/kg

**System Performance 5800 Head**

**DUT: Dipole 5800 Type: D5GHZV2; Serial: 1301**

Communication System: UID 0, CW (0); Frequency: 5800 MHz; Duty Cycle: 1:1  
 Medium parameters used:  $f = 5800 \text{ MHz}$ ;  $\sigma = 5.095 \text{ S/m}$ ;  $\epsilon_r = 34.97$ ;  $\rho = 1000 \text{ kg/m}^3$   
 Phantom section: Flat Section

DASY5 Configuration:

- Probe: EX3DV4 - SN7520; ConvF(5, 5, 5) @ 5800 MHz;
- Sensor-Surface: 4mm (Mechanical Surface Detection)
- Electronics: DAE4 Sn1561; Calibrated: 2019/09/13
- Phantom: SAM-Twin V8.0 P1aP2a; Type: QD 000 P41 AA ; Serial: 1962
- Measurement SW: DASY52, Version 52.10 (2);

**Head 5800MHz Pin=250mW unstandard 4mm /Area Scan (61x61x1):** Interpolated grid: dx=1.000 mm, dy=1.000 mm

Maximum value of SAR (interpolated) = 14.9 W/kg

**Head 5800MHz Pin=250mW 4mm /Zoom Scan (7x7x7)/Cube 0:** Measurement grid: dx=5mm, dy=5mm, dz=5mm

Reference Value = 51.88 V/m; Power Drift = 0.09 dB

Peak SAR (extrapolated) = 42.3 W/kg

**SAR(1 g) = 18.6 W/kg; SAR(10 g) = 4.96 W/kg**

Maximum value of SAR (measured) = 25.6 W/kg

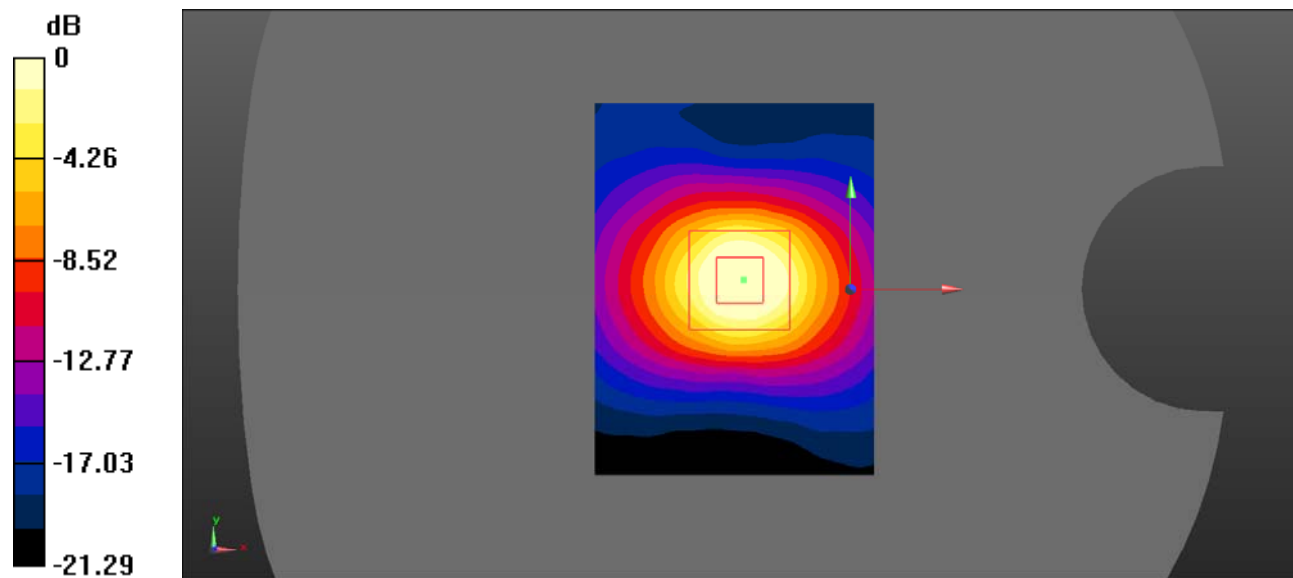

0 dB = 25.6 W/kg = 14.08 dBW/kg

## EUT TEST STRATEGY AND METHODOLOGY

### Test Positions for Device Operating Next to a Person’s Ear

This category includes most wireless handsets with fixed, retractable or internal antennas located toward the top half of the device, with or without a foldout, sliding or similar keypad cover. The handset should have its earpiece located within the upper ¼ of the device, either along the centerline or off-centered, as perceived by its users. This type of handset should be positioned in a normal operating position with the “test device reference point” located along the “vertical centerline” on the front of the device aligned to the “ear reference point”. The “test device reference point” should be located at the same level as the center of the earpiece region. The “vertical centerline” should bisect the front surface of the handset at its top and bottom edges. A “ear reference point” is located on the outer surface of the head phantom on each ear spacer. It is located 1.5 cm above the center of the ear canal entrance in the “phantom reference plane” defined by the three lines joining the center of each “ear reference point” (left and right) and the tip of the mouth.

A handset should be initially positioned with the earpiece region pressed against the ear spacer of a head phantom. For the SCC-34/SC-2 head phantom, the device should be positioned parallel to the “N-F” line defined along the base of the ear spacer that contains the “ear reference point”. For interim head phantoms, the device should be positioned parallel to the cheek for maximum RF energy coupling. The “test device reference point” is aligned to the “ear reference point” on the head phantom and the “vertical centerline” is aligned to the “phantom reference plane”. This is called the “initial ear position”. While maintaining these three alignments, the body of the handset is gradually adjusted to each of the following positions for evaluating SAR:

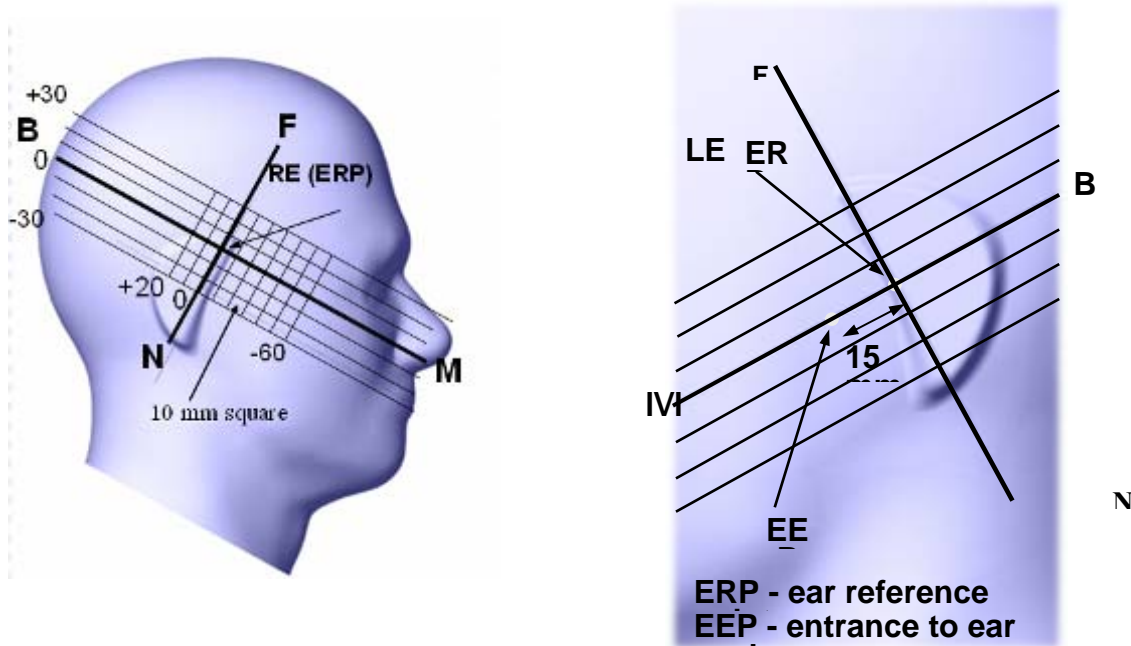

## Cheek/Touch Position

The device is brought toward the mouth of the head phantom by pivoting against the “ear reference point” or along the “N-F” line for the SCC-34/SC-2 head phantom.

This test position is established:

When any point on the display, keypad or mouthpiece portions of the handset is in contact with the phantom.

(or) When any portion of a foldout, sliding or similar keypad cover opened to its intended self-adjusting normal use position is in contact with the cheek or mouth of the phantom.

For existing head phantoms – when the handset loses contact with the phantom at the pivoting point, rotation should continue until the device touches the cheek of the phantom or breaks its last contact from the ear spacer.

### Cheek /Touch Position

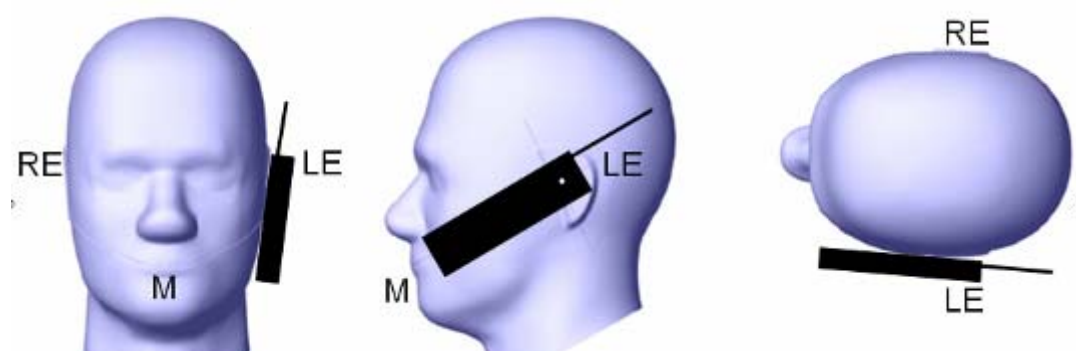

## Ear/Tilt Position

With the handset aligned in the “Cheek/Touch Position”:

1) If the earpiece of the handset is not in full contact with the phantom’s ear spacer (in the “Cheek/Touch position”) and the peak SAR location for the “Cheek/Touch” position is located at the ear spacer region or corresponds to the earpiece region of the handset, the device should be returned to the “initial ear position” by rotating it away from the mouth until the earpiece is in full contact with the ear spacer.

2) (otherwise) The handset should be moved (translated) away from the cheek perpendicular to the line passes through both “ear reference points” (note: one of these ear reference points may not physically exist on a split head model) for approximate 2-3 cm. While it is in this position, the device handset is tilted away from the mouth with respect to the “test device reference point” until the inside angle between the vertical centerline on the front surface of the phone and the horizontal line passing through the ear reference point is by 15 80°. After the tilt, it is then moved (translated) back toward the head perpendicular to the line passes through both “ear reference points” until the device touches the phantom or the ear spacer. If the antenna touches the head first, the positioning process should be repeated with a tilt angle less than 15° so that the device and its antenna would touch the phantom simultaneously. This test position may require a device holder or positioner to achieve the translation and tilting with acceptable positioning repeatability.

If a device is also designed to transmit with its keypad cover closed for operating in the head position, such positions should also be considered in the SAR evaluation. The device should be tested on the left and right side of the head phantom in the “Cheek/Touch” and “Ear/Tilt” positions. When applicable, each configuration should be tested with the antenna in its fully extended and fully retracted positions. These test configurations should be tested at the high, middle and low frequency channels of each operating mode; for example, AMPS, CDMA, and TDMA. If the SAR measured at the middle channel for each test configuration (left, right, Cheek/Touch, Tilt/Ear, extended and retracted) is at least 2.0 dB lower than the SAR limit, testing at the high and low channels is optional for such test configuration(s). If the transmission band of the test device is less than 10 MHz, testing at the high and low frequency channels is optional.

**Ear /Tilt 15° Position**

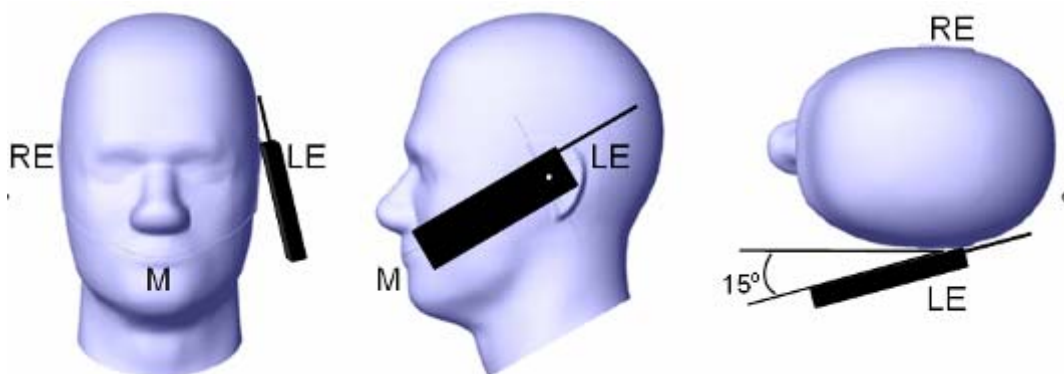

**Test positions for body-worn and other configurations**

Body-worn operating configurations should be tested with the belt-clips and holsters attached to the device and positioned against a flat phantom in normal use configurations. Devices with a headset output should be tested with a headset connected to the device. When multiple accessories that do not contain metallic components are supplied with the device, the device may be tested with only the accessory that dictates the closest spacing to the body. When multiple accessories that contain metallic components are supplied with the device, the device must be tested with each accessory that contains a unique metallic component. If multiple accessories share an identical metallic component (e.g., the same metallic belt-clip used with different holsters with no other metallic components), only the accessory that dictates the closest spacing to the body must be tested.

Body-worn accessories may not always be supplied or available as options for some devices that are intended to be authorized for body-worn use. A separation distance of 1.5 cm between the back of the device and a flat phantom is recommended for testing body-worn SAR compliance under such circumstances. Other separation distances may be used, but they should not exceed 2.5 cm. In these cases, the device may use body-worn accessories that provide a separation distance greater than that tested for the device provided however that the accessory contains no metallic components.

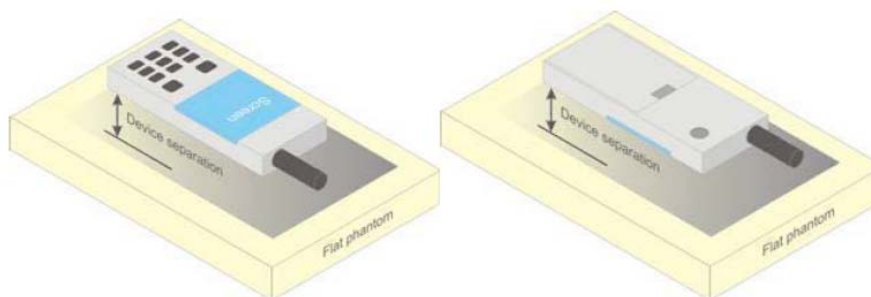

**Figure 5 – Test positions for body-worn devices**

**Test Distance for SAR Evaluation**

For this case the EUT(Equipment Under Test) is set 0mm away from the phantom, the test distance is 0mm.

## SAR Evaluation Procedure

The evaluation was performed with the following procedure:

Step 1: Measurement of the SAR value at a fixed location above the ear point or central position was used as a reference value for assessing the power drop. The SAR at this point is measured at the start of the test and then again at the end of the testing.

Step 2: The SAR distribution at the exposed side of the head was measured at a distance of 4 mm from the inner surface of the shell. The area covered the entire dimension of the head or radiating structures of the EUT, the horizontal grid spacing was 15 mm x 15 mm, and the SAR distribution was determined by integrated grid of 1.5mm x 1.5mm. Based on these data, the area of the maximum absorption was determined by spline interpolation. The first Area Scan covers the entire dimension of the EUT to ensure that the hotspot was correctly identified.

Step 3: Around this point, a volume of 30 mm x 30 mm x 30 mm was assessed by measuring 7x 7 x 7 points. On the basis of this data set, the spatial peak SAR value was evaluated under the following procedure:

- 1) The data at the surface were extrapolated, since the center of the dipoles is 1.2 mm away from the tip of the probe and the distance between the surface and the lowest measuring point is 1.3 mm. The extrapolation was based on a least square algorithm. A polynomial of the fourth order was calculated through the points in z-axes. This polynomial was then used to evaluate the points between the surface and the probe tip.

- 2) The maximum interpolated value was searched with a straightforward algorithm. Around this maximum the SAR values averaged over the spatial volumes (1 g or 10 g) were computed by the 3D-Spline interpolation algorithm. The 3D-Spline is composed of three one dimensional splines with the "Not a knot"-condition (in x, y and z-directions). The volume was integrated with the trapezoidal-algorithm. One thousand points (10 x 10 x 10) were interpolated to calculate the averages.

All neighboring volumes were evaluated until no neighboring volume with a higher average value was found.

Step 4: Re-measurement of the SAR value at the same location as in Step 1. If the value changed by more than 5%, the evaluation was repeated.



## CONDUCTED OUTPUT POWER MEASUREMENT

### Provision Applicable

The measured peak output power should be greater and within 5% than EMI measurement.

### Test Procedure

The RF output of the transmitter was connected to the input of the EMI Test Receiver through Connector.

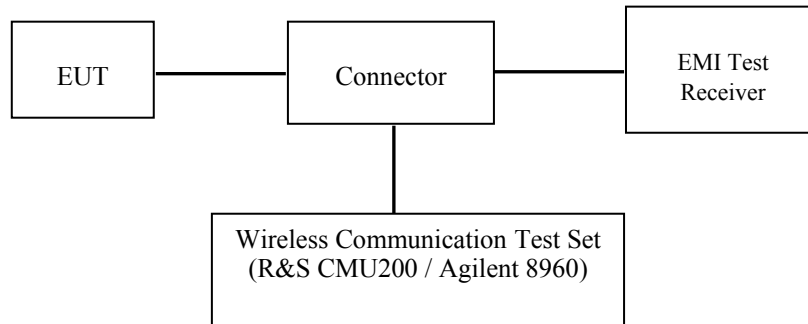

### GSM/WCDMA

#### Radio Configuration

The power measurement was configured by the Wireless Communication Test Set.

#### GSM/GPRS

Function: Menu select > GSM Mobile Station > GSM 850/1900

Press Connection control to choose the different menus

Press RESET > choose all the reset all settings

Connection Press Signal Off to turn off the signal and change settings

Network Support > GSM + GPRS or GSM + EGSM

Main Service > Packet Data

Service selection > Test Mode A – Auto Slot Config. off

MS Signal Press Slot Config Bottom on the right twice to select and change the number of time slots and power setting

> Slot configuration > Uplink/Gamma

> 33 dBm for GPRS 850

> 30 dBm for GPRS 1900

BS Signal Enter the same channel number for TCH channel (test channel) and BCCH channel

Frequency Offset > + 0 Hz

Mode > BCCH and TCH

BCCH Level > -85 dBm (May need to adjust if link is not stable)

BCCH Channel > choose desired test channel [Enter the same channel number for TCH channel (test channel) and BCCH channel]

Channel Type > Off

P0 > 4 dB

Slot Config > Unchanged (if already set under MS signal)

TCH > choose desired test channel

Hopping > Off

Main Timeslot > 3

Network Coding Scheme > CS4 (GPRS)

Bit Stream > 2E9-1 PSR Bit Stream

AF/RF Enter appropriate offsets for Ext. Att. Output and Ext. Att. Input

Connection Press Signal on to turn on the signal and change settings

**WCDMA Release 99**

The following tests were conducted according to the test requirements outlines in section 5.2 of the 3GPP TS34.121-1 specification. The EUT has a nominal maximum output power of 24dBm (+1.7/-3.7).

<b>WCDMA General Settings</b>	Loopback Mode	Test Mode 1
	Rel99 RMC	12.2kbps RMC
	Power Control Algorithm	Algorithm2
	$\beta_c/\beta_d$	8/15

**HSDPA**

The following tests were conducted according to the test requirements outlines in section 5.2 of the 3GPP TS34.121-1 specification.

	Mode	HSDPA	HSDPA	HSDPA	HSDPA
	Subset	1	2	3	4
<b>WCDMA General Settings</b>	Loopback Mode	Test Mode 1			
	Rel99 RMC	12.2kbps RMC			
	HSDPA FRC	H-Set1			
	Power Control Algorithm	Algorithm2			
	$\beta_c$	2/15	12/15	15/15	15/15
	$\beta_d$	15/15	15/15	8/15	4/15
	$\beta_d(SF)$	64			
	$\beta_c/\beta_d$	2/15	12/15	15/8	15/4
	$\beta_{hs}$	4/15	24/15	30/15	30/15
MPR(dB)	0	0	0.5	0.5	
<b>HSDPA Specific Settings</b>	DACK	8			
	DNAK	8			
	DCQI	8			
	Ack-Nack repetition factor	3			
	CQI Feedback	4ms			
	CQI Repetition Factor	2			
	$A_{hs}=\beta_{hs}/\beta_c$	30/15			

**HSUPA**

The following tests were conducted according to the test requirements outlines in section 5.2 of the 3GPP TS34.121-1 specification.

	<b>Mode</b>	<b>HSUPA</b>	<b>HSUPA</b>	<b>HSUPA</b>	<b>HSUPA</b>	<b>HSUPA</b>
	<b>Subset</b>	<b>1</b>	<b>2</b>	<b>3</b>	<b>4</b>	<b>5</b>
<b>WCDMA General Settings</b>	Loopback Mode	Test Mode 1				
	Rel99 RMC	12.2kbps RMC				
	HSDPA FRC	H-Set1				
	HSUPA Test	HSUPA Loopback				
	Power Control Algorithm	Algorithm2				
	$\beta_c$	11/15	6/15	15/15	2/15	15/15
	$\beta_d$	15/15	15/15	9/15	15/15	0
	$\beta_{cc}$	209/225	12/15	30/15	2/15	5/15
	$\beta_c / \beta_d$	11/15	6/15	15/9	2/15	-
	$\beta_{hs}$	22/15	12/15	30/15	4/15	5/15
	CM(dB)	1.0	3.0	2.0	3.0	1.0
MPR(dB)	0	2	1	2	0	
<b>HSDPA Specific Settings</b>	DACK	8				
	DNAK	8				
	DCQI	8				
	Ack-Nack repetition factor	3				
	CQI Feedback	4ms				
	CQI Repetition Factor	2				
	$A_{hs} = \beta_{hs} / \beta_c$	30/15				
<b>HSUPA Specific Settings</b>	DE-DPCCH	6	8	8	5	7
	DHARQ	0	0	0	0	0
	AG Index	20	12	15	17	21
	ETFCI	75	67	92	71	81
	Associated Max UL Data Rate kbps	242.1	174.9	482.8	205.8	308.9
	Reference E_FCI	E-TFCI 11 E-TFCI PO 4 E-TFCI 67 E-TFCI PO 18 E-TFCI 71 E-TFCI PO23 E-TFCI 75 E-TFCI PO26 E-TFCI 81 E-TFCI PO 27	E-TFCI 11 E-TFCI PO4 E-TFCI 92 E-TFCI PO 18	E-TFCI 11 E-TFCI PO 4 E-TFCI 67 E-TFCI PO 18 E-TFCI 71 E-TFCI PO23 E-TFCI 75 E-TFCI PO26 E-TFCI 81 E-TFCI PO 27		

**FDD-LTE**

For UE Power Class 1 and 3, the allowed Maximum Power Reduction (MPR) for the maximum output power in Table 6.2.2-1 due to higher order modulation and transmit bandwidth configuration (resource blocks) is specified in Table 6.2.3-1.

**Table 6.2.3-1: Maximum Power Reduction (MPR) for Power Class 1 and 3**

Modulation	Channel bandwidth / Transmission bandwidth ( $N_{RB}$ )						MPR (dB)
	1.4 MHz	3.0 MHz	5 MHz	10 MHz	15 MHz	20 MHz	
QPSK	> 5	> 4	> 8	> 12	> 16	> 18	≤ 1
16 QAM	≤ 5	≤ 4	≤ 8	≤ 12	≤ 16	≤ 18	≤ 1
16 QAM	> 5	> 4	> 8	> 12	> 16	> 18	≤ 2

For UE Power Class 1 and 3 the specific requirements and identified sub clauses are specified in Table 6.2.4-1 along with the allowed A-MPR values that may be used to meet these requirements. The allowed A-MPR values specified below in Table 6.2.4.-1 to 6.2.4-15 are in addition to the allowed MPR requirements specified in sub clause 6.2.3.

**Table 6.2.4-1: Additional Maximum Power Reduction (A-MPR)**

Network Signalling value	Requirements (subclause)	E-UTRA Band	Channel bandwidth (MHz)	Resources Blocks ( $N_{RB}$ )	A-MPR (dB)
NS_01	6.6.2.1.1	Table 5.5-1	1.4, 3, 5, 10, 15, 20	Table 5.6-1	N/A
NS_03	6.6.2.2.1	2, 4, 10, 23, 25, 35, 36	3	>5	≤ 1
			5	>6	≤ 1
			10	>6	≤ 1
			15	>8	≤ 1
			20	>10	≤ 1
NS_04	6.6.2.2.2	41	5	>6	≤ 1
			10, 15, 20	Table 6.2.4-4	
NS_05	6.6.3.3.1	1	10, 15, 20	≥ 50	≤ 1
NS_06	6.6.2.2.3	12, 13, 14, 17	1.4, 3, 5, 10	Table 5.6-1	N/A
NS_07	6.6.2.2.3 6.6.3.3.2	13	10	Table 6.2.4-2	
NS_08	6.6.3.3.3	19	10, 15	> 44	≤ 3
NS_09	6.6.3.3.4	21	10, 15	> 40	≤ 1
				> 55	≤ 2
				Table 6.2.4-3	
NS_11	6.6.2.2.1	23	1.4, 3, 5, 10, 15, 20	Table 6.2.4-5	
NS_12	6.6.3.3.5	26	1.4, 3, 5	Table 6.2.4-6	
NS_13	6.6.3.3.6	26	5	Table 6.2.4-7	
NS_14	6.6.3.3.7	26	10, 15	Table 6.2.4-8	
NS_15	6.6.3.3.8	26	1.4, 3, 5, 10, 15	Table 6.2.4-9 Table 6.2.4-10	
NS_16	6.6.3.3.9	27	3, 5, 10	Table 6.2.4-11, Table 6.2.4-12, Table 6.2.4-13	
NS_17	6.6.3.3.10	28	5, 10	Table 5.6-1	N/A
NS_18	6.6.3.3.11	28	5	≥ 2	≤ 1
			10, 15, 20	≥ 1	≤ 4
NS_19	6.6.3.3.12	44	10, 15, 20	Table 6.2.4-14	
NS_20	6.2.2 6.6.2.2.1 6.6.3.2	23	5, 10, 15, 20	Table 6.2.4-15	
...					
NS_32	-	-	-	-	-

**Maximum Target Output Power**

<b>Max Target Power(dBm)</b>			
<b>Mode/Band</b>	<b>Channel</b>		
	<b>Low</b>	<b>Middle</b>	<b>High</b>
GSM 850	33.0	33.0	33.0
GPRS 1 TX Slot	33.0	33.0	33.0
GPRS 2 TX Slot	30.0	30.0	30.0
GPRS 3 TX Slot	28.0	28.0	28.0
GPRS 4 TX Slot	27.0	27.0	27.0
EGPRS 1 TX Slot	27.0	27.0	27.0
EGPRS 2 TX Slot	24.0	24.0	24.0
EGPRS 3 TX Slot	23.0	23.0	23.0
EGPRS 4 TX Slot	22.0	22.0	22.0
PCS 1900	31.0	31.0	31.0
GPRS 1 TX Slot	31.0	31.0	31.0
GPRS 2 TX Slot	28.0	28.0	28.0
GPRS 3 TX Slot	26.0	26.0	26.0
GPRS 4 TX Slot	25.0	25.0	25.0
EGPRS 1 TX Slot	27.0	27.0	27.0
EGPRS 2 TX Slot	24.0	24.0	24.0
EGPRS 3 TX Slot	23.0	23.0	23.0
EGPRS 4 TX Slot	25.0	21.0	21.0
WCDMA Band 2	23.5	23.5	23.5
HSDPA	22.0	22.0	22.0
HSUPA	22.5	22.5	22.5
DC-HSDPA	23.0	23.0	23.0
HSPA+	22.5	22.5	22.5
WCDMA Band 4	22.5	23.0	23.0
HSDPA	22.5	22.5	22.5
HSUPA	22.0	22.0	22.0
HSPA+	22.5	22.5	22.5
WCDMA Band 5	24.0	24.0	24.0
HSDPA	23.0	23.0	23.0
HSUPA	22.5	22.5	22.5
DC-HSDPA	22.0	22.0	22.0
HSPA+	22.0	22.0	22.0
LTE Band 2	23.0	23.0	23.0
LTE Band 4	23.5	23.5	23.5
LTE Band 5	24.5	24.5	24.5
LTE Band 7	23.0	23.0	23.0
LTE Band 12	23.5	23.5	23.5
LTE Band 13	24.5	24.5	24.5
LTE Band 17	24.0	24.0	24.0
LTE Band 26	23.5	23.5	23.5
LTE Band 38	23.5	23.5	23.5
LTE Band 41	23.0	23.0	23.0

<b>Max Target Power(dBm)</b>			
<b>Mode/Band</b>	<b>Channel</b>		
	<b>Low</b>	<b>Middle</b>	<b>High</b>
WLAN 2.4G	17.0	17.0	17.0
WLAN 5.2G	10.5	10.5	10.5
WLAN 5.6G	10.6	10.6	10.6
WLAN 5.8G	11.0	11.0	11.0
Bluetooth BDR/EDR	6.0	6.0	6.0
Bluetooth BLE	-3.0	-3.0	-3.0

**Test Results:**

**GSM:**

Band	Channel No.	Frequency (MHz)	RF Output Power (dBm)
GSM 850	128	824.2	<b>32.04</b>
	190	836.6	32.01
	251	848.8	31.91
PCS 1900	512	1850.2	30.19
	661	1880.0	<b>30.26</b>
	810	1909.8	30.16

**GPRS:**

Band	Channel No.	Frequency (MHz)	RF Output Power (dBm)			
			1 slot	2 slots	3 slots	4 slots
GSM 850	128	824.2	32.03	29.19	27.29	26.18
	190	836.6	32.13	29.27	27.47	26.13
	251	848.8	32.05	29.30	27.39	26.18
PCS 1900	512	1850.2	30.19	27.61	25.72	24.47
	661	1880	30.35	27.54	25.63	24.37
	810	1909.8	30.13	27.40	25.63	24.43

**EGPRS:**

Band	Channel No.	Frequency (MHz)	RF Output Power (dBm)			
			1 slot	2 slots	3 slots	4 slots
GSM 850	128	824.2	26.14	23.81	22.33	21.08
	190	836.6	26.11	23.86	22.57	21.03
	251	848.8	26.28	23.94	22.64	21.16
PCS 1900	512	1850.2	26.07	23.85	22.03	24.52
	661	1880	26.10	23.73	21.93	20.65
	810	1909.8	26.17	23.88	22.05	20.75

For SAR, the time based average power is relevant, the difference in between depends on the duty cycle of the TDMA signal.

Number of Time slot	1	2	3	4
Duty Cycle	1:8	1:4	1:2.66	1:2
Time based Ave. power compared to slotted Ave. power	-9 dB	-6 dB	-4.25 dB	-3 dB
Crest Factor	8	4	2.66	2

**The time based average power for GPRS**

Band	Channel No.	Frequency (MHz)	Time based average Power (dBm)			
			1 slot	2 slot	3 slots	4 slots
GSM 850	128	824.2	23.03	23.19	23.04	23.18
	190	836.6	23.13	23.27	23.22	23.13
	251	848.8	23.05	<b>23.30</b>	23.14	23.18
PCS 1900	512	1850.2	21.19	<b>21.61</b>	21.47	21.47
	661	1880	21.35	21.54	21.38	21.37
	810	1909.8	21.13	21.40	21.38	21.43

**The time based average power for EGPRS**

Band	Channel No.	Frequency (MHz)	Time based average Power (dBm)			
			1 slot	2 slot	3 slots	4 slots
GSM 850	128	824.2	17.14	17.81	18.08	18.08
	190	836.6	17.11	17.86	18.32	18.03
	251	848.8	17.28	17.94	18.39	18.16
PCS 1900	512	1850.2	17.07	17.85	17.78	21.52
	661	1880	17.10	17.73	17.68	17.65
	810	1909.8	17.17	17.88	17.80	17.75

**Note:**

1. Rohde & Schwarz Radio Communication Tester (CMU200) was used for the measurement of GSM peak and average output power for active timeslots.
2. For GSM voice, 1 timeslot has been activated with power level 5 (850 MHz band) and 0 (1900 MHz band).
3. For GPRS, 1, 2, 3 and 4 timeslots has been activated separately with power level 3(850 MHz band) and 3(1900 MHz band).



**WCDMA Band 2:**

Test Condition	Test Mode	3GPP Sub Test	Averaged Mean Power (dBm)		
			Low Frequency	Mid Frequency	High Frequency
Normal	RMC12.2k		<b>23.00</b>	22.79	22.96
	HSDPA	1	<b>21.95</b>	21.87	21.93
		2	21.25	21.44	21.51
		3	20.51	20.16	21.12
		4	20.09	20.32	20.57
	HSUPA	1	<b>22.09</b>	21.79	21.96
		2	21.63	21.22	21.32
		3	20.70	21.08	20.41
		4	20.42	20.54	19.84
		5	19.96	20.33	19.40
	DC-HSDPA	1	21.93	20.78	<b>22.85</b>
		2	21.64	22.33	21.75
		3	20.62	22.68	20.02
		4	20.00	21.85	19.96
	HSPA+	1	<b>22.04</b>	21.00	20.61

**WCDMA Band 4:**

Test Condition	Test Mode	3GPP Sub Test	Averaged Mean Power (dBm)		
			Low Frequency	Mid Frequency	High Frequency
Normal	RMC12.2k		22.44	22.90	<b>22.96</b>
	HSDPA	1	21.50	21.76	22.01
		2	21.17	21.35	<b>22.02</b>
		3	20.83	20.91	20.51
		4	20.00	20.72	20.30
	HSUPA	1	21.37	21.80	<b>21.87</b>
		2	21.04	21.47	21.55
		3	20.81	21.03	20.88
		4	20.05	20.68	20.17
		5	19.62	19.80	19.24
	HSPA+	1	21.12	21.42	<b>21.95</b>

**WCDMA Band 5:**

Test Condition	Test Mode	3GPP Sub Test	Averaged Mean Power (dBm)		
			Low Frequency	Mid Frequency	High Frequency
Normal	RMC12.2k		<b>23.51</b>	23.46	23.28
	HSDPA	1	22.48	22.34	22.26
		2	<b>22.59</b>	21.87	21.40
		3	20.85	20.40	20.87
		4	20.29	20.21	19.43
	HSUPA	1	<b>22.34</b>	22.29	22.30
		2	22.16	21.69	22.09
		3	21.45	20.58	20.33
		4	20.58	20.20	19.89
		5	20.46	19.99	19.43
	DC-HSDPA	1	<b>21.87</b>	20.99	20.92
		2	21.57	20.61	20.99
		3	20.70	19.21	19.16
		4	19.69	18.98	18.90
	HSPA+	1	<b>21.75</b>	21.49	21.67

**Note:**

1. The default test configuration is to measure SAR with an established radio link between the EUT and a communication test set using a 12.2 kbps RMC (reference measurement Channel) Configured in Test Loop Model 1.
2. KDB 941225 D01-Body SAR is not required for HSDPA/HSUPA when the maximum average output of each RF channel is less than ¼ dB higher than measured 12.2kbps RMC or the maximum SAR for 12.2kbps RMC is < 75% of SAR limit.

**LTE Band 2:**

BW (MHz)	Modulation	Resource Block Size & Resource Block Offset	Target MPR	Meas MPR	Ave Tx Power (dBm)		
					Low Channel	Mid Channel	High Channel
					1850.7MHz	1880MHz	1909.3MHz
1.4	QPSK	RB Size=1, RB Offset=0	0	0	22.05	22.18	21.85
		RB Size=1, RB Offset=3	0	0	22.13	22.22	21.73
		RB Size=1, RB Offset=5	0	0	22.12	22.19	21.46
		RB Size=3, RB Offset=0	1	1	22.15	22.15	21.63
		RB Size=3, RB Offset=3	1	1	22.13	22.04	21.48
		RB Size=6, RB Offset=0	1	1	20.98	21.09	21.29
	16QAM	RB Size=1, RB Offset=0	1	1	20.61	21.38	21.05
		RB Size=1, RB Offset=3	1	1	20.70	21.48	20.86
		RB Size=1, RB Offset=5	1	1	20.60	21.17	20.73
		RB Size=3, RB Offset=0	2	2	20.79	21.35	20.84
		RB Size=3, RB Offset=3	2	2	20.91	21.20	20.65
		RB Size=6, RB Offset=0	2	2	20.09	20.18	20.13
BW (MHz)	Modulation	Resource Block Size & Resource Block Offset	Target MPR	Meas MPR	Ave Tx Power (dBm)		
					Low Channel	Mid Channel	High Channel
					1851.5MHz	1880MHz	1908.5MHz
3	QPSK	RB Size=1, RB Offset=0	0	0	22.13	22.11	21.89
		RB Size=1, RB Offset=8	0	0	22.01	22.29	21.93
		RB Size=1, RB Offset=14	0	0	21.99	22.46	21.53
		RB Size=6, RB Offset=0	1	1	21.06	21.02	21.02
		RB Size=6, RB Offset=9	1	1	21.00	21.13	21.05
		RB Size=15, RB Offset=0	1	1	20.99	20.96	21.23
	16QAM	RB Size=1, RB Offset=0	1	1	21.26	21.14	20.88
		RB Size=1, RB Offset=8	1	1	21.14	21.15	20.55
		RB Size=1, RB Offset=14	1	1	21.20	21.13	20.69
		RB Size=6, RB Offset=0	2	2	20.16	20.06	20.27
		RB Size=8, RB Offset=9	2	2	20.11	20.36	20.04
		RB Size=15, RB Offset=0	2	2	20.20	20.04	19.87

BW (MHz)	Modulation	Resource Block Size & Resource Block Offset	Target MPR	Meas MPR	Ave Tx Power (dBm)		
					Low Channel	Mid Channel	High Channel
					1852.5MHz	1880MHz	1907.5MHz
5	QPSK	RB Size=1, RB Offset=0	0	0	21.95	22.03	22.02
		RB Size=1, RB Offset=13	0	0	21.97	21.93	21.79
		RB Size=1, RB Offset=24	0	0	21.79	22.20	21.75
		RB Size=15, RB Offset=0	1	1	21.08	21.08	21.06
		RB Size=15, RB Offset=10	1	1	21.15	21.13	21.05
		RB Size=25, RB Offset=0	1	1	21.02	21.04	21.03
	16QAM	RB Size=1, RB Offset=0	1	1	20.88	21.35	21.32
		RB Size=1, RB Offset=13	1	1	20.21	21.33	21.06
		RB Size=1, RB Offset=24	1	1	20.36	21.25	20.57
		RB Size=15, RB Offset=0	2	2	20.08	19.97	20.24
		RB Size=15, RB Offset=10	2	2	20.29	20.01	20.06
RB Size=25, RB Offset=0	2	2	20.01	20.13	20.14		
BW (MHz)	Modulation	Resource Block Size & Resource Block Offset	Target MPR	Meas MPR	Ave Tx Power (dBm)		
					Low Channel	Mid Channel	High Channel
					1855MHz	1880MHz	1905MHz
10	QPSK	RB Size=1, RB Offset=0	0	0	22.20	22.23	22.12
		RB Size=1, RB Offset=25	0	0	22.20	22.20	22.22
		RB Size=1, RB Offset=49	0	0	22.05	22.01	21.29
		RB Size=25, RB Offset=0	1	1	21.03	21.14	21.10
		RB Size=25, RB Offset=25	1	1	21.08	21.05	21.09
		RB Size=50, RB Offset=0	1	1	21.03	21.08	21.14
	16QAM	RB Size=1, RB Offset=0	1	1	21.50	21.17	20.40
		RB Size=1, RB Offset=25	1	1	21.52	21.11	20.64
		RB Size=1, RB Offset=49	1	1	21.16	20.83	20.45
		RB Size=25, RB Offset=0	2	2	20.08	20.14	20.19
		RB Size=25, RB Offset=25	2	2	19.98	20.18	20.14
		RB Size=50, RB Offset=0	2	2	20.07	20.00	20.00

BW (MHz)	Modulation	Resource Block Size & Resource Block Offset	Target MPR	Meas MPR	Ave Tx Power (dBm)		
					Low Channel	Mid Channel	High Channel
					1857.5MHz	1880MHz	1902.5MHz
15	QPSK	RB Size=1, RB Offset=0	0	0	22.08	22.23	22.12
		RB Size=1, RB Offset=38	0	0	21.90	22.16	22.22
		RB Size=1, RB Offset=74	0	0	22.13	22.14	21.77
		RB Size=36, RB Offset=0	1	1	21.14	21.14	21.14
		RB Size=36, RB Offset=39	1	1	21.12	21.18	21.01
		RB Size=75, RB Offset=0	1	1	21.21	21.18	21.20
	16QAM	RB Size=1, RB Offset=0	1	1	21.21	21.10	21.42
		RB Size=1, RB Offset=38	1	1	21.20	21.20	21.38
		RB Size=1, RB Offset=74	1	1	21.30	21.45	21.04
		RB Size=36, RB Offset=0	2	2	20.06	20.10	20.21
		RB Size=36, RB Offset=39	2	2	20.05	20.03	20.08
RB Size=75, RB Offset=0	2	2	20.17	20.06	20.10		
BW (MHz)	Modulation	Resource Block Size & Resource Block Offset	Target MPR	Meas MPR	Ave Tx Power (dBm)		
					Low Channel	Mid Channel	High Channel
					1860MHz	1880MHz	1900MHz
20	QPSK	RB Size=1, RB Offset=0	0	0	22.22	22.21	22.19
		RB Size=1, RB Offset=50	0	0	22.55	22.53	22.29
		RB Size=1, RB Offset=99	0	0	22.47	22.30	21.44
		RB Size=50, RB Offset=0	1	1	21.15	21.26	21.38
		RB Size=50, RB Offset=50	1	1	21.17	21.08	21.12
		RB Size=100, RB Offset=0	1	1	21.06	21.21	21.14
	16QAM	RB Size=1, RB Offset=0	1	1	20.98	21.29	21.77
		RB Size=1, RB Offset=50	1	1	20.86	21.56	21.72
		RB Size=1, RB Offset=99	1	1	20.65	21.56	21.12
		RB Size=50, RB Offset=0	2	2	20.23	20.19	20.42
		RB Size=50, RB Offset=50	2	2	20.33	20.08	20.05
		RB Size=100, RB Offset=0	2	2	20.23	20.00	20.23

**LTE Band 4:**

BW (MHz)	Modulation	Resource Block Size & Resource Block Offset	Target MPR	Meas MPR	Ave Tx Power (dBm)		
					Low Channel	Mid Channel	High Channel
					1711.5MHz	1732.5MHz	1753.5MHz
3	QPSK	RB Size=1, RB Offset=0	0	0	22.80	23.19	23.00
		RB Size=1, RB Offset=8	0	0	22.63	23.01	23.00
		RB Size=1, RB Offset=14	0	0	22.72	23.04	23.13
		RB Size=6, RB Offset=0	1	1	21.81	22.04	22.09
		RB Size=6, RB Offset=9	1	1	21.93	22.09	22.14
		RB Size=15, RB Offset=0	1	1	21.86	22.07	22.13
	16QAM	RB Size=1, RB Offset=0	1	1	22.10	22.24	22.25
		RB Size=1, RB Offset=8	1	1	21.94	22.23	22.21
		RB Size=1, RB Offset=14	1	1	22.05	22.33	22.22
		RB Size=6, RB Offset=0	2	2	20.89	20.89	21.19
		RB Size=6, RB Offset=9	2	2	20.76	21.12	21.23
		RB Size=15, RB Offset=0	2	2	20.77	21.08	21.11

BW (MHz)	Modulation	Resource Block Size & Resource Block Offset	Target MPR	Meas MPR	Ave Tx Power (dBm)		
					Low Channel	Mid Channel	High Channel
					1712.5MHz	1732.5MHz	1752.5MHz
5	QPSK	RB Size=1, RB Offset=0	0	0	22.61	22.86	23.05
		RB Size=1, RB Offset=13	0	0	22.57	22.88	22.83
		RB Size=1, RB Offset=24	0	0	22.62	22.77	22.82
		RB Size=15, RB Offset=0	1	1	21.72	22.06	22.15
		RB Size=15, RB Offset=10	1	1	21.73	22.09	22.04
		RB Size=25, RB Offset=0	1	1	21.78	22.02	22.04
	16QAM	RB Size=1, RB Offset=0	1	1	21.91	21.52	22.08
		RB Size=1, RB Offset=13	1	1	21.76	21.93	22.01
		RB Size=1, RB Offset=24	1	1	21.59	21.82	21.47
		RB Size=15, RB Offset=0	2	2	20.46	20.94	21.09
		RB Size=15, RB Offset=10	2	2	20.73	20.88	20.85
RB Size=25, RB Offset=0	2	2	20.80	20.98	21.16		
BW (MHz)	Modulation	Resource Block Size & Resource Block Offset	Target MPR	Meas MPR	Ave Tx Power (dBm)		
					Low Channel	Mid Channel	High Channel
					1715MHz	1732.5MHz	1750MHz
10	QPSK	RB Size=1, RB Offset=0	0	0	22.79	22.98	23.12
		RB Size=1, RB Offset=25	0	0	22.97	23.13	23.14
		RB Size=1, RB Offset=49	0	0	22.83	22.99	22.98
		RB Size=25, RB Offset=0	1	1	21.86	22.04	22.01
		RB Size=25, RB Offset=25	1	1	21.80	22.01	22.02
		RB Size=50, RB Offset=0	1	1	21.98	22.04	22.10
	16QAM	RB Size=1, RB Offset=0	1	1	22.17	22.21	21.81
		RB Size=1, RB Offset=25	1	1	21.99	22.24	22.05
		RB Size=1, RB Offset=49	1	1	21.76	21.95	21.71
		RB Size=25, RB Offset=0	2	2	20.63	21.05	21.51
		RB Size=25, RB Offset=25	2	2	20.75	20.99	21.01
		RB Size=50, RB Offset=0	2	2	20.88	21.06	21.15

BW (MHz)	Modulation	Resource Block Size & Resource Block Offset	Target MPR	Meas MPR	Ave Tx Power (dBm)		
					Low Channel	Mid Channel	High Channel
					1717.5MHz	1732.5MHz	1747.5MHz
15	QPSK	RB Size=1, RB Offset=0	0	0	22.88	23.19	23.02
		RB Size=1, RB Offset=38	0	0	22.65	23.04	23.10
		RB Size=1, RB Offset=74	0	0	22.92	23.29	23.13
		RB Size=36, RB Offset=0	1	1	21.87	22.02	22.17
		RB Size=36, RB Offset=39	1	1	21.83	22.04	22.12
		RB Size=75, RB Offset=0	1	1	21.91	22.03	22.22
	16QAM	RB Size=1, RB Offset=0	1	1	22.42	22.23	22.48
		RB Size=1, RB Offset=38	1	1	22.30	22.18	22.40
		RB Size=1, RB Offset=74	1	1	22.40	22.42	22.47
		RB Size=36, RB Offset=0	2	2	20.96	21.05	21.23
		RB Size=36, RB Offset=39	2	2	20.95	21.01	21.14
		RB Size=75, RB Offset=0	2	2	20.78	21.03	21.11
BW (MHz)	Modulation	Resource Block Size & Resource Block Offset	Target MPR	Meas MPR	Ave Tx Power (dBm)		
					Low Channel	Mid Channel	High Channel
					1720MHz	1732.5MHz	1745MHz
20	QPSK	RB Size=1, RB Offset=0	0	0	23.27	22.98	23.13
		RB Size=1, RB Offset=50	0	0	22.84	23.27	22.98
		RB Size=1, RB Offset=99	0	0	22.81	23.25	22.84
		RB Size=50, RB Offset=0	1	1	22.04	21.92	22.35
		RB Size=50, RB Offset=50	1	1	21.90	22.08	21.99
		RB Size=100, RB Offset=0	1	1	22.04	22.11	22.07
	16QAM	RB Size=1, RB Offset=0	1	1	22.40	21.90	22.43
		RB Size=1, RB Offset=50	1	1	22.33	22.28	22.45
		RB Size=1, RB Offset=99	1	1	22.37	21.91	22.10
		RB Size=50, RB Offset=0	2	2	20.80	21.04	21.18
		RB Size=50, RB Offset=50	2	2	20.86	21.01	21.10
		RB Size=100, RB Offset=0	2	2	21.01	20.93	21.14



**LTE Band 5:**

BW (MHz)	Modulation	Resource Block Size & Resource Block Offset	Target MPR	Meas MPR	Ave Tx Power (dBm)		
					Low Channel	Mid Channel	High Channel
					824.7MHz	836.5MHz	844MHz
1.4	QPSK	RB Size=1, RB Offset=0	0	0	23.41	23.89	23.43
		RB Size=1, RB Offset=3	0	0	23.34	23.84	23.27
		RB Size=1, RB Offset=5	0	0	23.19	23.84	23.06
		RB Size=3, RB Offset=0	1	1	23.25	23.94	23.37
		RB Size=3, RB Offset=3	1	1	23.26	23.91	23.05
		RB Size=6, RB Offset=0	1	1	22.97	22.94	23.03
	16QAM	RB Size=1, RB Offset=0	1	1	22.29	23.03	22.60
		RB Size=1, RB Offset=3	1	1	22.16	23.31	22.56
		RB Size=1, RB Offset=5	1	1	22.16	23.14	22.41
		RB Size=3, RB Offset=0	2	2	22.35	23.14	22.45
		RB Size=3, RB Offset=3	2	2	22.39	23.04	22.13
		RB Size=6, RB Offset=0	2	2	22.05	22.05	22.17
BW (MHz)	Modulation	Resource Block Size & Resource Block Offset	Target MPR	Meas MPR	Ave Tx Power (dBm)		
					Low Channel	Mid Channel	High Channel
					825.5MHz	836.5MHz	847.5MHz
3	QPSK	RB Size=1, RB Offset=0	0	0	23.70	23.92	23.88
		RB Size=1, RB Offset=8	0	0	23.48	23.92	23.58
		RB Size=1, RB Offset=14	0	0	23.69	23.93	23.29
		RB Size=6, RB Offset=0	1	1	22.96	23.02	22.95
		RB Size=6, RB Offset=8	1	1	22.94	22.94	22.92
		RB Size=15, RB Offset=0	1	1	22.92	22.93	22.95
	16QAM	RB Size=1, RB Offset=0	1	1	22.46	23.24	23.25
		RB Size=1, RB Offset=8	1	1	22.60	23.01	22.79
		RB Size=1, RB Offset=14	1	1	22.60	23.00	22.50
		RB Size=6, RB Offset=0	2	2	22.07	21.86	21.92
		RB Size=6, RB Offset=8	2	2	21.89	21.75	21.86
		RB Size=15, RB Offset=0	2	2	22.11	22.00	21.87

BW (MHz)	Modulation	Resource Block Size & Resource Block Offset	Target MPR	Meas MPR	Ave Tx Power (dBm)		
					Low Channel	Mid Channel	High Channel
					826.5MHz	836.5MHz	846.5MHz
5	QPSK	RB Size=1, RB Offset=0	0	0	23.82	23.81	23.75
		RB Size=1, RB Offset=13	0	0	23.50	23.87	23.88
		RB Size=1, RB Offset=24	0	0	23.97	23.95	23.42
		RB Size=15, RB Offset=0	1	1	23.04	22.99	23.02
		RB Size=15, RB Offset=10	1	1	22.98	23.00	22.89
		RB Size=25, RB Offset=0	1	1	22.88	23.11	22.97
	16QAM	RB Size=1, RB Offset=0	1	1	22.59	22.92	22.90
		RB Size=1, RB Offset=13	1	1	22.61	22.10	22.42
		RB Size=1, RB Offset=24	1	1	23.14	22.28	22.50
		RB Size=15, RB Offset=0	2	2	21.92	21.71	21.61
		RB Size=15, RB Offset=10	2	2	22.07	21.80	21.58
RB Size=25, RB Offset=0	2	2	21.85	21.91	21.71		
BW (MHz)	Modulation	Resource Block Size & Resource Block Offset	Target MPR	Meas MPR	Ave Tx Power (dBm)		
					Low Channel	Mid Channel	High Channel
					829MHz	836.5MHz	844MHz
10	QPSK	RB Size=1, RB Offset=0	0	0	23.28	23.88	23.85
		RB Size=1, RB Offset=25	0	0	24.16	23.92	24.23
		RB Size=1, RB Offset=49	0	0	23.76	23.20	22.66
		RB Size=25, RB Offset=0	1	1	23.05	23.05	22.92
		RB Size=25, RB Offset=25	1	1	22.97	22.94	22.83
		RB Size=50, RB Offset=0	1	1	22.90	22.91	22.96
	16QAM	RB Size=1, RB Offset=0	1	1	22.34	23.03	22.98
		RB Size=1, RB Offset=25	1	1	23.03	23.33	23.15
		RB Size=1, RB Offset=49	1	1	22.01	22.87	21.92
		RB Size=25, RB Offset=0	2	2	22.08	21.90	21.85
		RB Size=25, RB Offset=25	2	2	21.95	21.80	21.72
		RB Size=50, RB Offset=0	2	2	21.87	21.91	21.73

**LTE Band 7:**

BW	Modulation	Resource Block Size & Resource Block Offset	Target MPR	Meas MPR	Ave Tx Power (dBm)		
					Low Channel	Mid Channel	High Channel
					2502.5MHz	2535MHz	2567.5MHz
5M	QPSK	RB Size=1, RB Offset=0	0	0	21.80	21.69	21.83
		RB Size=1, RB Offset=13	0	0	21.70	21.55	22.04
		RB Size=1, RB Offset=24	0	0	21.94	21.71	22.13
		RB Size=15, RB Offset=0	1	1	21.06	21.04	21.04
		RB Size=15, RB Offset=10	1	1	21.17	21.01	20.99
	RB Size=25, RB Offset=0	1	1	21.02	21.05	20.98	
	16QAM	RB Size=1, RB Offset=0	1	1	20.97	20.95	21.33
		RB Size=1, RB Offset=13	1	1	21.01	19.97	20.76
		RB Size=1, RB Offset=24	1	1	21.09	20.02	20.65
		RB Size=15, RB Offset=0	2	2	20.08	19.76	19.93
RB Size=15, RB Offset=10		2	2	20.19	20.12	19.72	
RB Size=25, RB Offset=0	2	2	20.12	19.99	19.79		
BW	Modulation	Resource Block Size & Resource Block Offset	Target MPR	Meas MPR	Ave Tx Power (dBm)		
					Low Channel	Mid Channel	High Channel
					2505MHz	2535MHz	2565MHz
10M	QPSK	RB Size=1, RB Offset=0	0	0	22.02	22.12	21.95
		RB Size=1, RB Offset=25	0	0	22.15	22.13	21.93
		RB Size=1, RB Offset=49	0	0	22.20	21.88	21.94
		RB Size=25, RB Offset=0	1	1	20.98	21.14	21.15
		RB Size=25, RB Offset=25	1	1	21.16	21.01	21.08
	RB Size=50, RB Offset=0	1	1	21.09	21.11	21.30	
	16QAM	RB Size=1, RB Offset=0	1	1	21.30	21.21	20.89
		RB Size=1, RB Offset=25	1	1	21.45	21.27	20.56
		RB Size=1, RB Offset=49	1	1	22.02	21.20	20.55
		RB Size=25, RB Offset=0	2	2	20.16	20.22	20.24
RB Size=25, RB Offset=25		2	2	20.31	20.27	20.29	
RB Size=50, RB Offset=0	2	2	20.17	20.22	20.24		

BW	Modulation	Resource Block Size & Resource Block Offset	Target MPR	Meas MPR	Ave Tx Power (dBm)		
					Low Channel	Mid Channel	High Channel
					2507.5MHz	2535MHz	2562.5MHz
15M	QPSK	RB Size=1, RB Offset=0	0	0	22.29	21.98	22.24
		RB Size=1, RB Offset=38	0	0	21.96	21.63	21.95
		RB Size=1, RB Offset=74	0	0	22.04	21.96	21.71
		RB Size=36, RB Offset=0	1	1	21.17	21.01	21.15
		RB Size=36, RB Offset=38	1	1	21.21	21.12	20.87
		RB Size=75, RB Offset=0	1	1	21.08	21.08	21.07
	16QAM	RB Size=1, RB Offset=0	1	1	21.41	21.55	21.58
		RB Size=1, RB Offset=38	1	1	21.13	20.96	21.26
		RB Size=1, RB Offset=74	1	1	21.16	21.17	20.85
		RB Size=36, RB Offset=0	2	2	20.04	19.88	20.19
		RB Size=36, RB Offset=38	2	2	20.24	19.84	19.91
RB Size=75, RB Offset=0	2	2	19.97	20.14	20.22		
BW	Modulation	Resource Block Size & Resource Block Offset	Target MPR	Meas MPR	Ave Tx Power (dBm)		
					Low Channel	Mid Channel	High Channel
					2510MHz	2535MHz	2560MHz
20M	QPSK	RB Size=1, RB Offset=0	0	0	22.39	22.20	22.35
		RB Size=1, RB Offset=50	0	0	22.55	22.05	22.23
		RB Size=1, RB Offset=99	0	0	22.15	22.29	21.85
		RB Size=50, RB Offset=0	1	1	21.21	21.11	21.27
		RB Size=50, RB Offset=50	1	1	21.10	21.06	20.97
		RB Size=100, RB Offset=0	1	1	21.16	21.05	21.25
	16QAM	RB Size=1, RB Offset=0	1	1	21.51	21.50	22.06
		RB Size=1, RB Offset=50	1	1	21.44	21.45	21.80
		RB Size=1, RB Offset=99	1	1	20.93	21.57	21.31
		RB Size=50, RB Offset=0	2	2	20.22	20.34	20.31
		RB Size=50, RB Offset=50	2	2	20.13	20.21	20.09
		RB Size=100, RB Offset=0	2	2	20.11	20.06	20.18

**LTE Band 12:**

BW (MHz)	Modulation	Resource Block Size & Resource Block Offset	Target MPR	Meas MPR	Ave Tx Power (dBm)		
					Low Channel	Mid Channel	High Channel
					699.7MHz	707.5MHz	715.3MHz
1.4	QPSK	RB Size=1, RB Offset=0	0	0	22.58	22.84	22.83
		RB Size=1, RB Offset=3	0	0	22.71	22.87	23.04
		RB Size=1, RB Offset=5	0	0	22.75	22.83	22.94
		RB Size=3, RB Offset=0	1	1	22.80	22.91	22.81
		RB Size=3, RB Offset=3	1	1	22.80	22.84	22.75
	RB Size=6, RB Offset=0	1	1	21.80	21.91	21.82	
	16QAM	RB Size=1, RB Offset=0	1	1	21.25	21.92	21.89
		RB Size=1, RB Offset=3	1	1	21.64	21.80	22.01
		RB Size=1, RB Offset=5	1	1	21.42	21.92	22.39
		RB Size=3, RB Offset=0	2	2	21.75	21.59	21.85
RB Size=3, RB Offset=3		2	2	21.93	21.44	22.10	
RB Size=6, RB Offset=0	2	2	20.72	20.60	21.02		
BW (MHz)	Modulation	Resource Block Size & Resource Block Offset	Target MPR	Meas MPR	Ave Tx Power (dBm)		
					Low Channel	Mid Channel	High Channel
					700.5MHz	707.5MHz	714.5MHz
3	QPSK	RB Size=1, RB Offset=0	0	0	22.66	22.95	22.92
		RB Size=1, RB Offset=8	0	0	22.59	22.76	22.68
		RB Size=1, RB Offset=14	0	0	22.59	22.89	22.91
		RB Size=6, RB Offset=0	1	1	21.72	21.90	21.76
		RB Size=6, RB Offset=9	1	1	21.84	21.84	21.87
		RB Size=15, RB Offset=0	1	1	21.82	21.80	21.88
	16QAM	RB Size=1, RB Offset=0	1	1	22.11	22.14	21.37
		RB Size=1, RB Offset=8	1	1	21.95	22.45	21.32
		RB Size=1, RB Offset=14	1	1	21.92	22.60	21.43
		RB Size=6, RB Offset=0	2	2	20.94	20.93	20.79
		RB Size=6, RB Offset=9	2	2	20.83	21.21	20.86
		RB Size=15, RB Offset=0	2	2	21.00	21.15	21.13

BW (MHz)	Modulation	Resource Block Size & Resource Block Offset	Target MPR	Meas MPR	Ave Tx Power (dBm)		
					Low Channel	Mid Channel	High Channel
					701.5MHz	707.5MHz	713.5MHz
5	QPSK	RB Size=1, RB Offset=0	0	0	22.39	22.73	22.66
		RB Size=1, RB Offset=13	0	0	22.72	22.80	22.56
		RB Size=1, RB Offset=24	0	0	22.53	22.72	23.03
		RB Size=15, RB Offset=0	1	1	21.99	21.75	21.81
		RB Size=15, RB Offset=10	1	1	21.82	21.93	21.84
		RB Size=25, RB Offset=0	1	1	21.75	21.92	21.72
	16QAM	RB Size=1, RB Offset=0	1	1	20.87	22.04	21.10
		RB Size=1, RB Offset=13	1	1	20.84	21.89	21.53
		RB Size=1, RB Offset=24	1	1	20.79	21.95	21.37
		RB Size=15, RB Offset=0	2	2	20.71	20.47	20.84
		RB Size=15, RB Offset=10	2	2	20.63	20.59	20.86
RB Size=25, RB Offset=0	2	2	20.92	20.67	20.85		
BW (MHz)	Modulation	Resource Block Size & Resource Block Offset	Target MPR	Meas MPR	Ave Tx Power (dBm)		
					Low Channel	Mid Channel	High Channel
					704MHz	707.5MHz	711MHz
10	QPSK	RB Size=1, RB Offset=0	0	0	22.88	22.87	22.73
		RB Size=1, RB Offset=25	0	0	22.84	23.01	22.75
		RB Size=1, RB Offset=49	0	0	22.78	22.70	22.92
		RB Size=25, RB Offset=0	1	1	21.77	21.83	21.87
		RB Size=25, RB Offset=25	1	1	21.96	21.81	21.88
		RB Size=50, RB Offset=0	1	1	21.92	21.86	21.94
	16QAM	RB Size=1, RB Offset=0	1	1	22.29	22.02	21.85
		RB Size=1, RB Offset=25	1	1	22.31	22.05	21.91
		RB Size=1, RB Offset=49	1	1	22.32	22.25	21.58
		RB Size=25, RB Offset=0	2	2	20.79	20.93	20.93
		RB Size=25, RB Offset=25	2	2	20.88	20.67	20.97
		RB Size=50, RB Offset=0	2	2	20.96	20.83	20.81

**LTE Band 13:**

BW (MHz)	Modulation	Resource Block Size & Resource Block Offset	Target MPR	Meas MPR	Ave Tx Power (dBm)		
					Low Channel	Mid Channel	High Channel
					779.5MHz	782MHz	784.5MHz
5	QPSK	RB Size=1, RB Offset=0	0	0	23.64	23.56	23.76
		RB Size=1, RB Offset=13	0	0	23.50	23.46	23.85
		RB Size=1, RB Offset=24	0	0	23.43	23.52	24.18
		RB Size=15, RB Offset=0	1	1	22.98	22.88	22.98
		RB Size=15, RB Offset=10	1	1	22.87	22.88	23.00
		RB Size=25, RB Offset=0	1	1	22.89	22.90	23.03
	16QAM	RB Size=1, RB Offset=0	1	1	22.80	22.25	23.06
		RB Size=1, RB Offset=13	1	1	22.89	21.95	22.66
		RB Size=1, RB Offset=24	1	1	22.86	22.05	22.56
		RB Size=15, RB Offset=0	2	2	22.06	21.84	21.96
		RB Size=15, RB Offset=10	2	2	21.86	21.91	21.78
RB Size=25, RB Offset=0	2	2	22.11	21.92	21.96		
BW (MHz)	Modulation	Resource Block Size & Resource Block Offset	Target MPR	Meas MPR	Ave Tx Power (dBm)		
					Low Channel	Mid Channel	High Channel
					782MHz	782MHz	782MHz
10	QPSK	RB Size=1, RB Offset=0	0	0		23.75	
		RB Size=1, RB Offset=25	0	0		23.78	
		RB Size=1, RB Offset=49	0	0		23.56	
		RB Size=25, RB Offset=0	1	1		23.09	
		RB Size=25, RB Offset=25	1	1		22.91	
		RB Size=50, RB Offset=0	1	1		23.04	
	16QAM	RB Size=1, RB Offset=0	1	1		23.02	
		RB Size=1, RB Offset=25	1	1		23.04	
		RB Size=1, RB Offset=49	1	1		23.22	
		RB Size=25, RB Offset=0	2	2		22.03	
		RB Size=25, RB Offset=25	2	2		21.96	
RB Size=50, RB Offset=0	2	2		21.97			

**LTE Band 17:**

BW (MHz)	Modulation	Resource Block Size & Resource Block Offset	Target MPR	Meas MPR	Ave Tx Power (dBm)		
					Low Channel	Mid Channel	High Channel
					706.5MHz	710MHz	713.5MHz
5	QPSK	RB Size=1, RB Offset=0	0	0	23.70	23.62	23.50
		RB Size=1, RB Offset=13	0	0	23.54	23.54	23.37
		RB Size=1, RB Offset=24	0	0	23.59	23.44	23.83
		RB Size=15, RB Offset=0	1	1	22.67	22.83	22.75
		RB Size=15, RB Offset=10	1	1	22.59	22.83	22.76
		RB Size=25, RB Offset=0	1	1	22.74	22.87	22.74
	16QAM	RB Size=1, RB Offset=0	1	1	22.39	21.75	22.91
		RB Size=1, RB Offset=13	1	1	22.17	21.80	22.23
		RB Size=1, RB Offset=24	1	1	22.13	21.95	22.48
		RB Size=15, RB Offset=0	2	2	21.65	21.70	21.62
		RB Size=15, RB Offset=10	2	2	21.56	21.88	21.66
		RB Size=25, RB Offset=0	2	2	21.54	21.66	21.70
BW (MHz)	Modulation	Resource Block Size & Resource Block Offset	Target MPR	Meas MPR	Ave Tx Power (dBm)		
					Low Channel	Mid Channel	High Channel
					709MHz	710MHz	711MHz
10	QPSK	RB Size=1, RB Offset=0	0	0	23.66	23.89	23.82
		RB Size=1, RB Offset=25	0	0	24.01	23.89	23.97
		RB Size=1, RB Offset=49	0	0	23.56	23.62	23.62
		RB Size=25, RB Offset=0	1	1	22.80	22.98	22.92
		RB Size=25, RB Offset=25	1	1	22.77	22.70	22.73
		RB Size=50, RB Offset=0	1	1	22.78	22.93	22.82
	16QAM	RB Size=1, RB Offset=0	1	1	22.72	23.06	23.11
		RB Size=1, RB Offset=25	1	1	22.84	23.25	23.01
		RB Size=1, RB Offset=49	1	1	21.99	22.92	22.97
		RB Size=25, RB Offset=0	2	2	22.04	21.72	21.84
		RB Size=25, RB Offset=25	2	2	21.60	21.70	21.89
		RB Size=50, RB Offset=0	2	2	21.61	21.77	21.88



**LTE Band 26:**

BW (MHz)	Modulation	Resource Block Size & Resource Block Offset	Target MPR	Meas MPR	Ave Tx Power (dBm)		
					Low Channel	Mid Channel	High Channel
					814.7MHz	831.5MHz	848.3MHz
1.4	QPSK	RB Size=1, RB Offset=0	0	0	22.62	22.89	22.59
		RB Size=1, RB Offset=3	0	0	22.58	22.96	22.58
		RB Size=1, RB Offset=5	0	0	22.60	22.81	22.60
		RB Size=3, RB Offset=0	1	1	22.55	22.85	22.73
		RB Size=3, RB Offset=3	1	1	22.60	22.87	22.50
		RB Size=6, RB Offset=0	1	1	21.76	21.86	21.44
	16QAM	RB Size=1, RB Offset=0	1	1	21.41	22.36	21.73
		RB Size=1, RB Offset=3	1	1	21.18	22.48	21.74
		RB Size=1, RB Offset=5	1	1	21.23	22.08	21.67
		RB Size=3, RB Offset=0	2	2	21.74	21.60	21.71
		RB Size=3, RB Offset=3	2	2	21.49	21.71	21.28
		RB Size=6, RB Offset=0	2	2	20.62	20.81	20.73
BW (MHz)	Modulation	Resource Block Size & Resource Block Offset	Target MPR	Meas MPR	Ave Tx Power (dBm)		
					Low Channel	Mid Channel	High Channel
					815.5MHz	831.5MHz	847.5MHz
3	QPSK	RB Size=1, RB Offset=0	0	0	22.62	22.71	22.42
		RB Size=1, RB Offset=8	0	0	22.64	22.77	22.34
		RB Size=1, RB Offset=14	0	0	22.59	22.85	22.36
		RB Size=6, RB Offset=0	1	1	21.72	21.86	21.68
		RB Size=6, RB Offset=9	1	1	21.75	21.77	21.54
		RB Size=15, RB Offset=0	1	1	21.76	21.75	21.72
	16QAM	RB Size=1, RB Offset=0	1	1	21.84	22.01	21.70
		RB Size=1, RB Offset=8	1	1	21.68	22.20	21.25
		RB Size=1, RB Offset=14	1	1	21.56	21.96	21.04
		RB Size=6, RB Offset=0	2	2	20.64	20.82	20.69
		RB Size=6, RB Offset=9	2	2	20.89	21.01	20.69
		RB Size=15, RB Offset=0	2	2	20.86	20.99	20.93

BW (MHz)	Modulation	Resource Block Size & Resource Block Offset	Target MPR	Meas MPR	Ave Tx Power (dBm)		
					Low Channel	Mid Channel	High Channel
					816.5MHz	831.5MHz	846.5MHz
5	QPSK	RB Size=1, RB Offset=0	0	0	22.56	22.84	22.64
		RB Size=1, RB Offset=13	0	0	22.48	22.65	22.61
		RB Size=1, RB Offset=24	0	0	22.53	22.84	22.45
		RB Size=15, RB Offset=0	1	1	21.91	21.86	21.69
		RB Size=15, RB Offset=10	1	1	21.75	21.82	21.64
		RB Size=25, RB Offset=0	1	1	21.73	21.68	21.74
	16QAM	RB Size=1, RB Offset=0	1	1	20.92	21.86	20.96
		RB Size=1, RB Offset=13	1	1	20.69	21.57	20.93
		RB Size=1, RB Offset=24	1	1	20.76	21.80	20.67
		RB Size=15, RB Offset=0	2	2	20.68	20.47	20.77
		RB Size=15, RB Offset=10	2	2	20.61	20.72	20.47
RB Size=25, RB Offset=0	2	2	20.57	20.72	20.89		
BW (MHz)	Modulation	Resource Block Size & Resource Block Offset	Target MPR	Meas MPR	Ave Tx Power (dBm)		
					Low Channel	Mid Channel	High Channel
					819MHz	831.5MHz	844MHz
10	QPSK	RB Size=1, RB Offset=0	0	0	22.65	22.79	22.60
		RB Size=1, RB Offset=25	0	0	22.73	23.14	22.70
		RB Size=1, RB Offset=49	0	0	22.67	22.76	22.53
		RB Size=25, RB Offset=0	1	1	21.84	21.96	21.81
		RB Size=25, RB Offset=25	1	1	21.85	21.98	21.84
		RB Size=50, RB Offset=0	1	1	21.74	21.98	21.82
	16QAM	RB Size=1, RB Offset=0	1	1	22.14	21.87	21.77
		RB Size=1, RB Offset=25	1	1	21.84	22.30	21.76
		RB Size=1, RB Offset=49	1	1	21.69	21.93	21.33
		RB Size=25, RB Offset=0	2	2	20.82	21.05	20.92
		RB Size=25, RB Offset=25	2	2	20.71	20.99	20.83
		RB Size=50, RB Offset=0	2	2	20.71	20.98	20.88

BW (MHz)	Modulation	Resource Block Size & Resource Block Offset	Target MPR	Meas MPR	Ave Tx Power (dBm)		
					Low Channel	Mid Channel	High Channel
					821.5MHz	831.5MHz	841.5MHz
15	QPSK	RB Size=1, RB Offset=0	0	0	21.91	21.76	21.77
		RB Size=1, RB Offset=38	0	0	21.45	21.82	21.64
		RB Size=1, RB Offset=74	0	0	21.99	21.89	21.48
		RB Size=36, RB Offset=0	1	1	20.86	20.97	20.74
		RB Size=36, RB Offset=39	1	1	20.74	20.86	20.76
		RB Size=75, RB Offset=0	1	1	20.80	20.84	20.76
	16QAM	RB Size=1, RB Offset=0	1	1	21.18	21.17	21.16
		RB Size=1, RB Offset=38	1	1	20.58	21.12	20.73
		RB Size=1, RB Offset=74	1	1	20.76	20.80	20.89
		RB Size=36, RB Offset=0	2	2	19.89	19.96	20.05
		RB Size=36, RB Offset=39	2	2	19.80	19.92	19.78
		RB Size=75, RB Offset=0	2	2	19.72	19.87	19.78

**LTE Band 38:**

BW (MHz)	Modulation	Resource Block Size & Resource Block Offset	Target MPR	Meas MPR	Ave Tx Power (dBm)		
					Low Channel	Mid Channel	High Channel
					2572.5MHz	2595MHz	2617.5MHz
5	QPSK	RB Size=1, RB Offset=0	0	0	23.02	23.10	22.94
		RB Size=1, RB Offset=13	0	0	22.84	22.98	22.64
		RB Size=1, RB Offset=24	0	0	23.11	23.08	22.95
		RB Size=15, RB Offset=0	1	1	22.16	22.00	21.95
		RB Size=15, RB Offset=10	1	1	22.16	22.04	21.96
		RB Size=25, RB Offset=0	1	1	22.05	22.07	22.00
	16QAM	RB Size=1, RB Offset=0	1	1	21.51	22.12	22.48
		RB Size=1, RB Offset=13	1	1	21.20	22.15	22.04
		RB Size=1, RB Offset=24	1	1	21.47	22.18	22.35
		RB Size=15, RB Offset=0	2	2	20.69	21.03	20.76
		RB Size=15, RB Offset=10	2	2	20.95	20.92	20.73
RB Size=25, RB Offset=0	2	2	21.29	20.94	20.90		
BW (MHz)	Modulation	Resource Block Size & Resource Block Offset	Target MPR	Meas MPR	Ave Tx Power (dBm)		
					Low Channel	Mid Channel	High Channel
					2575MHz	2595MHz	2615MHz
10	QPSK	RB Size=1, RB Offset=0	0	0	23.10	23.00	23.01
		RB Size=1, RB Offset=25	0	0	23.07	22.82	23.07
		RB Size=1, RB Offset=49	0	0	23.05	23.06	23.09
		RB Size=25, RB Offset=0	1	1	22.12	22.07	21.96
		RB Size=25, RB Offset=25	1	1	22.00	21.93	21.89
		RB Size=50, RB Offset=0	1	1	22.12	22.16	21.99
	16QAM	RB Size=1, RB Offset=0	1	1	21.88	22.10	22.07
		RB Size=1, RB Offset=25	1	1	22.17	22.01	22.09
		RB Size=1, RB Offset=49	1	1	21.84	21.86	22.02
		RB Size=25, RB Offset=0	2	2	20.94	21.07	21.01
		RB Size=25, RB Offset=25	2	2	21.04	21.05	20.96
RB Size=50, RB Offset=0	2	2	21.03	21.05	20.99		

BW (MHz)	Modulation	Resource Block Size & Resource Block Offset	Target MPR	Meas MPR	Ave Tx Power (dBm)		
					Low Channel	Mid Channel	High Channel
					2577.5MHz	2595MHz	2612.5MHz
15	QPSK	RB Size=1, RB Offset=0	0	0	22.89	23.32	23.08
		RB Size=1, RB Offset=38	0	0	22.87	23.03	22.74
		RB Size=1, RB Offset=74	0	0	22.89	23.04	22.81
		RB Size=36, RB Offset=0	1	1	21.95	22.37	22.09
		RB Size=36, RB Offset=39	1	1	21.99	22.19	21.90
		RB Size=75, RB Offset=0	1	1	21.94	22.16	22.04
	16QAM	RB Size=1, RB Offset=0	1	1	22.43	22.47	22.40
		RB Size=1, RB Offset=38	1	1	22.14	22.10	22.02
		RB Size=1, RB Offset=74	1	1	22.27	22.34	22.06
		RB Size=36, RB Offset=0	2	2	20.99	21.36	21.14
		RB Size=36, RB Offset=39	2	2	20.92	21.19	21.09
RB Size=75, RB Offset=0	2	2	21.16	21.20	20.88		
BW (MHz)	Modulation	Resource Block Size & Resource Block Offset	Target MPR	Meas MPR	Ave Tx Power (dBm)		
					Low Channel	Mid Channel	High Channel
					2580MHz	2595MHz	2610MHz
20	QPSK	RB Size=1, RB Offset=0	0	0	23.02	23.15	23.24
		RB Size=1, RB Offset=50	0	0	23.09	23.18	23.13
		RB Size=1, RB Offset=99	0	0	22.72	23.09	23.07
		RB Size=50, RB Offset=0	1	1	22.11	22.26	22.24
		RB Size=50, RB Offset=50	1	1	22.04	21.95	21.97
		RB Size=100, RB Offset=0	1	1	22.11	22.08	21.97
	16QAM	RB Size=1, RB Offset=0	1	1	22.23	22.13	22.88
		RB Size=1, RB Offset=50	1	1	22.17	22.17	22.17
		RB Size=1, RB Offset=99	1	1	22.11	21.81	22.13
		RB Size=50, RB Offset=0	2	2	21.04	21.31	21.28
		RB Size=50, RB Offset=50	2	2	20.96	21.09	21.13
		RB Size=100, RB Offset=0	2	2	21.09	21.25	21.03

**LTE Band 41:**

BW (MHz)	Modulation	Resource Block Size & Resource Block Offset	Target MPR	Meas MPR	Ave Tx Power (dBm)		
					Low Channel	Mid Channel	High Channel
					2498.5MHz	2593MHz	2687.5MHz
5	QPSK	RB Size=1, RB Offset=0	0	0	21.99	21.85	21.66
		RB Size=1, RB Offset=13	0	0	22.00	21.74	21.71
		RB Size=1, RB Offset=24	0	0	21.84	21.84	21.94
		RB Size=15, RB Offset=0	1	1	20.90	20.76	20.83
		RB Size=15, RB Offset=10	1	1	20.90	20.79	20.80
		RB Size=25, RB Offset=0	1	1	20.67	20.87	20.92
	16QAM	RB Size=1, RB Offset=0	1	1	20.54	20.89	21.07
		RB Size=1, RB Offset=13	1	1	20.49	20.69	21.29
		RB Size=1, RB Offset=24	1	1	20.27	20.72	21.40
		RB Size=15, RB Offset=0	2	2	19.78	19.69	20.10
		RB Size=15, RB Offset=10	2	2	19.75	19.68	19.53
RB Size=25, RB Offset=0	2	2	20.00	19.97	19.64		
BW (MHz)	Modulation	Resource Block Size & Resource Block Offset	Target MPR	Meas MPR	Ave Tx Power (dBm)		
					Low Channel	Mid Channel	High Channel
					2501MHz	2593MHz	2685MHz
10	QPSK	RB Size=1, RB Offset=0	0	0	21.72	22.10	22.00
		RB Size=1, RB Offset=25	0	0	21.78	22.32	21.95
		RB Size=1, RB Offset=49	0	0	21.90	21.98	21.89
		RB Size=25, RB Offset=0	1	1	20.96	20.75	20.85
		RB Size=25, RB Offset=25	1	1	20.81	20.85	20.86
		RB Size=50, RB Offset=0	1	1	20.70	20.75	20.88
	16QAM	RB Size=1, RB Offset=0	1	1	20.93	20.93	20.88
		RB Size=1, RB Offset=25	1	1	20.55	21.12	21.00
		RB Size=1, RB Offset=49	1	1	20.48	20.90	20.59
		RB Size=25, RB Offset=0	2	2	19.93	19.99	19.77
		RB Size=25, RB Offset=25	2	2	19.66	19.77	19.70
		RB Size=50, RB Offset=0	2	2	19.89	19.88	19.85

BW (MHz)	Modulation	Resource Block Size & Resource Block Offset	Target MPR	Meas MPR	Ave Tx Power (dBm)		
					Low Channel	Mid Channel	High Channel
					2503.5MHz	2593MHz	2682.5MHz
15	QPSK	RB Size=1, RB Offset=0	0	0	21.90	22.26	21.98
		RB Size=1, RB Offset=38	0	0	21.55	22.07	21.71
		RB Size=1, RB Offset=74	0	0	21.68	22.11	21.65
		RB Size=36, RB Offset=0	1	1	20.78	20.93	20.89
		RB Size=36, RB Offset=39	1	1	20.73	20.83	20.91
		RB Size=75, RB Offset=0	1	1	20.74	20.81	20.84
	16QAM	RB Size=1, RB Offset=0	1	1	20.91	21.23	20.95
		RB Size=1, RB Offset=38	1	1	20.67	20.83	20.78
		RB Size=1, RB Offset=74	1	1	20.74	21.24	21.04
		RB Size=36, RB Offset=0	2	2	19.98	20.11	19.81
		RB Size=36, RB Offset=39	2	2	19.62	19.88	19.70
RB Size=75, RB Offset=0	2	2	19.88	19.93	19.71		
BW (MHz)	Modulation	Resource Block Size & Resource Block Offset	Target MPR	Meas MPR	Ave Tx Power (dBm)		
					Low Channel	Mid Channel	High Channel
					2506MHz	2593MHz	2680MHz
20	QPSK	RB Size=1, RB Offset=0	0	0	22.06	22.27	22.24
		RB Size=1, RB Offset=50	0	0	22.07	22.61	21.91
		RB Size=1, RB Offset=99	0	0	21.91	22.10	22.04
		RB Size=50, RB Offset=0	1	1	20.74	20.86	20.94
		RB Size=50, RB Offset=50	1	1	20.92	20.86	20.82
		RB Size=100, RB Offset=0	1	1	20.88	20.80	20.73
	16QAM	RB Size=1, RB Offset=0	1	1	20.98	21.45	21.21
		RB Size=1, RB Offset=50	1	1	21.09	21.44	21.19
		RB Size=1, RB Offset=99	1	1	20.72	20.87	21.13
		RB Size=50, RB Offset=0	2	2	19.97	20.08	20.06
		RB Size=50, RB Offset=50	2	2	19.90	19.96	20.01
		RB Size=100, RB Offset=0	2	2	19.98	19.97	19.88

**Note:**

1. SAR for LTE band exposure configurations is measured according to the procedures of KDB 941225 D05 SAR for LTE Devices v02.
2. The CMW500 Wideband Radio Communication tester is used for LTE output power measurements and SAR testing. Closed loop power control is used to keep the radio transmitters the max output power during the test.

**WLAN 2.4G:**

Mode	Channel frequency (MHz)	Data Rate	RF Output Power(dBm)
802.11b	2412	1Mbps	15.20
	2437		<b>16.45</b>
	2462		15.88
802.11g	2412	6Mbps	12.70
	2437		13.46
	2462		13.89
802.11n HT20	2412	MCS0	12.64
	2437		13.54
	2462		14.06
802.11n HT40	2422	MCS0	8.25
	2437		9.32
	2452		8.55

**WLAN 5.2G:**

Mode	Channel frequency (MHz)	Data Rate	RF Output Power(dBm)
802.11a	5180	6Mbps	9.67
	5200		<b>10.14</b>
	5240		9.52
802.11n HT20	5180	MCS0	9.75
	5200		10.39
	5240		9.58
802.11n HT40	5190	MCS0	10.00
	5230		9.82



**WLAN 5.6G:**

Mode	Channel frequency (MHz)	Data Rate	RF Output Power(dBm)
802.11a	5500	6Mbps	<b>10.37</b>
	5580		10.35
	5700		9.76
802.11n HT20	5500	MCS0	10.43
	5580		10.47
	5700		9.77
802.11n HT40	5510	MCS0	9.18
	5550		10.58
	5670		10.30

**WLAN 5.8G:**

Mode	Channel frequency (MHz)	Data Rate	RF Output Power(dBm)
802.11a	5745	6Mbps	10.13
	5785		10.08
	5825		10.39
802.11n HT20	5745	MCS0	10.05
	5785		10.08
	5825		<b>10.47</b>
802.11n HT40	5755	MCS0	10.22
	5795		10.08

**Bluetooth:**

Mode	Channel frequency (MHz)	RF Output Power (dBm)
BDR(GFSK)	2402	4.92
	2441	5.03
	2461	<b>5.59</b>
	2480	4.43
EDR( $\pi/4$ -DQPSK)	2402	4.74
	2441	4.82
	2461	5.48
	2480	4.40
EDR(8-DPSK)	2402	5.23
	2441	5.33
	2461	5.49
	2480	4.79
Bluetooth LE	2402	-3.93
	2440	-3.37
	2480	-4.13

### Standalone SAR test exclusion considerations

**Antennas Location:**

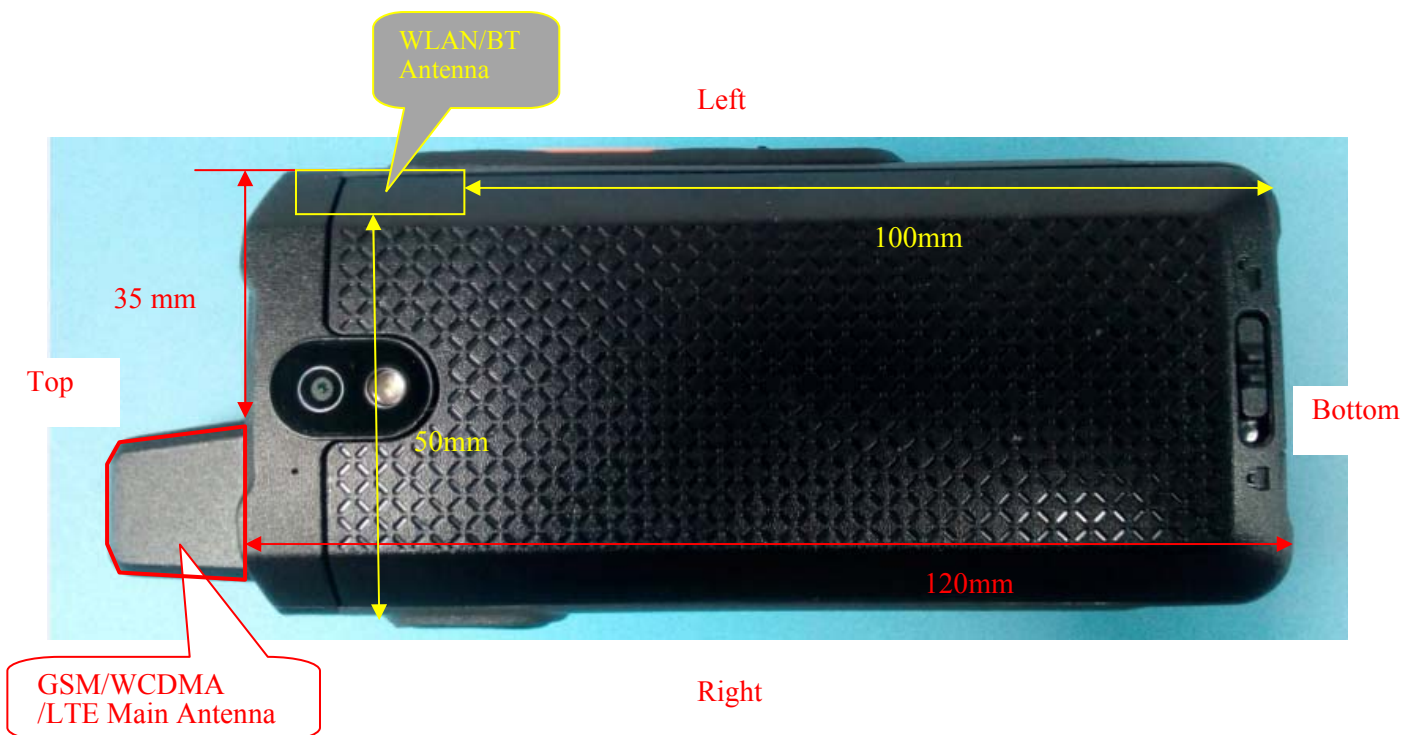

**Antenna Distance To Edge**

Antenna Distance To Edge(mm)					
Antenna	Back with clamp	Left	Right	Top	Bottom
WWAN(GSM/WCDMA/LTE)	10	35	< 5	< 5	120
WLAN/BT Antenna	10	< 5	50	< 5	100

Notes:  
The distance between the antenna and the attachment clamp is 10mm

**Standalone SAR test exclusion considerations**

Mode	Frequency (MHz)	P <sub>avg</sub> (dBm)	P <sub>avg</sub> (mW)	Distance (mm)	Calculated value	Threshold (1-g)	SAR Test Exclusion
WLAN 2.4G Body	2437	17.0	50.12	10	7.8	3	NO
WLAN 2.4G Face Up	2437	17.0	50.12	25	3.1	3	NO
WLAN 5.2G Face Up	5200	10.5	11.22	25	1.0	3	Yes
WLAN 5.6G Face Up	5500	10.6	11.22	25	1.1	3	Yes
WLAN 5.8G Face Up	5825	11.0	12.59	25	1.2	3	Yes
Bluetooth Body	2461	6.0	3.98	10	0.6	3	Yes
Bluetooth Face Up	2461	6.0	3.98	25	0.2	3	Yes

**NOTE:**

The 1-g and 10-g SAR test exclusion thresholds for 100 MHz to 6 GHz at test separation distances  $\leq 50$  mm are determined by:

$[(\text{max. power of channel, including tune-up tolerance, mW}) / (\text{min. test separation distance, mm})] \cdot$

$[\sqrt{f(\text{GHz})}] \leq 3.0$  for 1-g SAR and  $\leq 7.5$  for 10-g extremity SAR, where

1.  $f(\text{GHz})$  is the RF channel transmit frequency in GHz.
2. Power and distance are rounded to the nearest mW and mm before calculation.
3. The result is rounded to one decimal place for comparison.
4. When the minimum test separation distance is  $< 5$  mm, a distance of 5 mm is applied to determine SAR test Exclusion.

**Standalone SAR estimation:**

Mode	Frequency (MHz)	Pavg (dBm)	Pavg (mW)	Distance (mm)	Estimated 1-g (W/kg)
BT Face Up	2461	6.0	3.98	25	0.03
BT Body	2461	6.0	3.98	10	0.08
WLAN5.2G Face Up	5200	10.5	11.22	25	0.14
WLAN5.6G Face Up	5500	10.6	11.48	25	0.14
WLAN5.8G Face Up	5825	11	12.59	25	0.16

When standalone SAR test exclusion applies to an antenna that transmits simultaneously with other antennas, the standalone SAR must be estimated according to following to determine simultaneous transmission SAR test exclusion:

$$[(\text{max. power of channel, including tune-up tolerance, mW}) / (\text{min. test separation distance, mm})] \cdot [\sqrt{f(\text{GHz})} / x]$$

W/kg for test separation distances ≤50 mm;

where x = 7.5 for 1-g SAR.

When the minimum test separation distance is < 5 mm, a distance of 5 mm is applied to determine SAR test Exclusion.

**SAR test exclusion for the EUT edge considerations Result**

Exclusion Result						
Mode	Back	Face up	Left	Right	Top	Bottom
BT	Exclusion*	Exclusion*	Exclusion*	Exclusion*	Exclusion*	Exclusion*
WLAN 2.4G	Required	Required	Exclusion*	Exclusion*	Exclusion*	Exclusion*
WLAN 5G	Required	Exclusion*	Exclusion*	Exclusion*	Exclusion*	Exclusion*
WWAN	Required	Required	Exclusion*	Exclusion*	Exclusion*	Exclusion*

**Note:**

**Required:** The distance to Edge is less than 25mm, testing is required.

**Exclusion\*:** SAR test exclusion evaluation has been done above. testing is not required during its intended use.

**Exclusion:** The distance to Edge is more than 25 mm, testing is not required.

## SAR MEASUREMENT RESULTS

This page summarizes the results of the performed dosimetric evaluation.

### SAR Test Data

#### Environmental Conditions

<b>Temperature:</b>	21.7-23.7 °C	20.7-23.5 °C	21.0-24.1 °C	20.4-24.4 °C
<b>Relative Humidity:</b>	54-65%	51-63 %	50-65 %	54-67 %
<b>ATM Pressure:</b>	101.7 kPa	101.5 kPa	101.3 kPa	100.2 kPa
<b>Test Date:</b>	2020/02/10	2020/02/11	2020/02/12	2020/02/13

Testing was performed by Seven Liang, Yates Li, Ricardo Lan.

### GSM 850:

EUT Position	Frequency (MHz)	Test Mode	Max Power (dBm)		Scaled Factor	1g SAR (W/kg)		Plot
			Meas.	Rated		Meas.	Rated	
FaceUp (25mm)	824.2	GSM	32.04	33.0	1.247	0.273	0.34	1#
	836.6	GSM	32.01	33.0	1.256	0.304	0.38	2#
	848.8	GSM	31.91	33.0	1.285	<b>0.376</b>	<b>0.48</b>	3#
Body Worn Back (0mm)	824.2	GSM	/	/	/	/	/	/
	836.6	GSM	32.01	33.0	1.256	0.333	0.42	4#
	848.8	GSM	/	/	/	/	/	/
Body Back (0mm)	824.2	GPRS	29.19	30.0	1.205	0.336	0.40	5#
	836.6	GPRS	29.27	30.0	1.183	0.388	0.46	6#
	848.8	GPRS	29.30	30.0	1.175	<b>0.425</b>	<b>0.50</b>	7#

#### Note:

1. When the 1-g SAR is  $\leq 0.8\text{W/Kg}$ , testing for other channels are optional.
2. The EUT transmit and receive through the same GSM antenna while testing SAR.
3. When SAR or MPE is not measured at the maximum power level allowed for production units, the results must be scaled to the maximum tune-up tolerance limit according to the power applied to the individual channels tested to determine compliance.
4. When the maximum output power variation across the required test channels is  $> 0.5\text{ dB}$ , instead of the middle channel, the highest output power channel must be used.
5. The Multi-slot Classes of EUT is Class 12 which has maximum 4 Downlink slots and 4 Uplink slots, the maximum active slots is 5, when perform the multiple slots scan, 3DL+2UL is the worst case.

**PCS 1900:**

EUT Position	Frequency (MHz)	Test Mode	Max Power (dBm)		Scaled Factor	1g SAR (W/kg)		Plot
			Meas.	Rated		Meas.	Rated	
FaceUp (25mm)	1850.2	GSM	30.19	31.0	1.205	0.128	0.15	8#
	1880	GSM	30.26	31.0	1.186	<b>0.138</b>	<b>0.16</b>	9#
	1909.8	GSM	30.16	31.0	1.213	0.120	0.15	10#
Body Worn Back (0mm)	1850.2	GSM	/	/	/	/	/	/
	1880	GSM	30.26	31.0	1.186	0.254	0.30	11#
	1909.8	GSM	/	/	/	/	/	/
Body Back (0mm)	1850.2	GPRS	27.61	28.0	1.094	0.265	0.29	12#
	1880	GPRS	27.54	28.0	1.112	0.290	0.32	13#
	1909.8	GPRS	27.40	28.0	1.148	<b>0.287</b>	<b>0.33</b>	14#

**Note:**

1. When the 1-g SAR is  $\leq 0.8\text{W/Kg}$ , testing for other channels are optional.
2. The EUT transmit and receive through the same GSM antenna while testing SAR.
3. When SAR or MPE is not measured at the maximum power level allowed for production units, the results must be scaled to the maximum tune-up tolerance limit according to the power applied to the individual channels tested to determine compliance.
4. When the maximum output power variation across the required test channels is  $> 0.5\text{ dB}$ , instead of the middle channel, the highest output power channel must be used.
5. The Multi-slot Classes of EUT is Class 12 which has maximum 4 Downlink slots and 4 Uplink slots, the maximum active slots is 5, when perform the multiple slots scan, 3DL+2UL is the worst case.

**WCDMA Band 2:**

EUT Position	Frequency (MHz)	Test Mode	Max Power (dBm)		Scaled Factor	1g SAR (W/kg)		Plot
			Meas.	Rated		Meas.	Rated	
FaceUp (25mm)	1852.4	RMC	23.00	23.5	1.122	0.245	0.27	15#
	1880	RMC	22.79	23.5	1.178	<b>0.424</b>	<b>0.50</b>	16#
	1907.6	RMC	22.96	23.5	1.132	0.348	0.39	17#
Body Back (0mm)	1852.4	RMC	23.00	23.5	1.122	<b>0.896</b>	<b>1.01</b>	18#
	1880	RMC	22.79	23.5	1.178	0.771	0.91	19#
	1907.6	RMC	22.96	23.5	1.132	0.730	0.83	20#

**WCDMA Band 4:**

EUT Position	Frequency (MHz)	Test Mode	Max Power (dBm)		Scaled Factor	1g SAR (W/kg)		Plot
			Meas.	Rated		Meas.	Rated	
FaceUp (25mm)	1712.4	RMC	22.44	23.0	1.138	0.232	0.26	21#
	1732.6	RMC	22.90	23.0	1.023	<b>0.535</b>	<b>0.55</b>	22#
	1752.6	RMC	22.96	23.0	1.009	0.400	0.40	23#
Body Back (0mm)	1712.4	RMC	22.44	23.0	1.138	<b>1.17</b>	<b>1.33</b>	24#
	1732.6	RMC	22.90	23.0	1.023	1.11	1.14	25#
	1752.6	RMC	22.96	23.0	1.009	0.894	0.90	26#

**WCDMA Band 5:**

EUT Position	Frequency (MHz)	Test Mode	Max Power (dBm)		Scaled Factor	1g SAR (W/kg)		Plot
			Meas.	Rated		Meas.	Rated	
FaceUp (25mm)	826.4	RMC	23.51	24.0	1.119	0.222	0.25	27#
	836.6	RMC	23.46	24.0	1.132	<b>0.408</b>	<b>0.46</b>	28#
	846.6	RMC	23.28	24.0	1.180	0.348	0.41	29#
Body Back (0mm)	826.4	RMC	23.51	24.0	1.119	0.608	0.68	30#
	836.6	RMC	23.46	24.0	1.132	0.663	0.75	31#
	846.6	RMC	23.28	24.0	1.180	<b>0.717</b>	<b>0.85</b>	32#

**Note:**

1. When the 1-g SAR is  $\leq 0.8$ W/Kg, testing for other channels are optional.
2. The EUT transmit and receive through the same antenna while testing SAR.
3. The default test configuration is to measure SAR with an established radio link between the EUT and a communication test set using a 12.2 kbps RMC (reference measurement Channel) Configured in Test Loop Model.
4. KDB 941225 D01-Body SAR is not required for HSDPA/HSUPA/HSPA+ when the maximum average output of each RF channel is less than ? dB higher than measured 12.2kbps RMC or the maximum SAR for 12.2kbps RMC is < 75% of SAR limit.
5. When SAR or MPE is not measured at the maximum power level allowed for production units, the results must be scaled to the maximum tune-up tolerance limit according to the power applied to the individual channels tested to determine compliance.

**LTE Band 2:**

EUT Position	Frequency (MHz)	Bandwidth (MHz)	Test Mode	Max Power (dBm)		Scaled Factor	1g SAR (W/kg)		Plot
				Meas.	Rated		Meas.	Rated	
FaceUp (25mm)	1860	20	1RB	22.22	23.0	1.197	0.199	0.24	33#
	1880	20	1RB	22.21	23.0	1.199	<b>0.205</b>	<b>0.25</b>	34#
	1900	20	1RB	22.19	23.0	1.205	0.183	0.22	35#
	1880	20	50%RB	21.26	22.0	1.186	0.154	0.18	36#
Body Back (0mm)	1860	20	1RB	22.22	23.0	1.197	0.438	0.52	37#
	1880	20	1RB	22.21	23.0	1.199	<b>0.514</b>	<b>0.62</b>	38#
	1900	20	1RB	22.19	23.0	1.205	0.442	0.53	39#
	1880	20	50%RB	21.26	22.0	1.186	0.421	0.50	40#

**LTE Band 4:**

EUT Position	Frequency (MHz)	Bandwidth (MHz)	Test Mode	Max Power (dBm)		Scaled Factor	1g SAR (W/kg)		Plot
				Meas.	Rated		Meas.	Rated	
FaceUp (25mm)	1720	20	1RB	23.27	23.5	1.054	0.265	0.28	41#
	1732.5	20	1RB	22.98	23.5	1.127	<b>0.285</b>	<b>0.32</b>	42#
	1745	20	1RB	23.13	23.5	1.089	0.263	0.29	43#
	1732.5	20	50%RB	21.92	23.5	1.439	0.209	0.30	44#
Body Back (0mm)	1720	20	1RB	23.27	23.5	1.054	0.737	0.78	45#
	1732.5	20	1RB	22.98	23.5	1.127	0.688	0.78	46#
	1745	20	1RB	23.13	23.5	1.089	<b>0.721</b>	<b>0.79</b>	47#
	1732.5	20	50%RB	21.92	23.5	1.439	0.519	0.75	48#

**LTE Band 5:**

EUT Position	Frequency (MHz)	Bandwidth (MHz)	Test Mode	Max Power (dBm)		Scaled Factor	1g SAR (W/kg)		Plot
				Meas.	Rated		Meas.	Rated	
FaceUp (25mm)	829	10	1RB	23.28	24.5	1.324	0.252	0.33	49#
	836.5	10	1RB	23.88	24.5	1.153	<b>0.382</b>	<b>0.44</b>	50#
	844	10	1RB	23.85	24.5	1.161	0.237	0.28	51#
	836.5	10	50%RB	23.05	24.5	1.396	0.296	0.41	52#
Body Back (0mm)	829	10	1RB	23.28	24.5	1.324	0.512	0.68	53#
	836.5	10	1RB	23.88	24.5	1.153	<b>0.743</b>	<b>0.86</b>	54#
	844	10	1RB	23.85	24.5	1.161	0.467	0.54	55#
	836.5	10	50%RB	23.05	24.5	1.396	0.593	0.83	56#



**LTE Band 7:**

EUT Position	Frequency (MHz)	Bandwidth (MHz)	Test Mode	Max Power (dBm)		Scaled Factor	1g SAR (W/kg)		Plot
				Meas.	Rated		Meas.	Rated	
FaceUp (25mm)	2510	20	1RB	22.39	23.0	1.151	0.159	0.18	57#
	2535	20	1RB	22.20	23.0	1.202	<b>0.230</b>	<b>0.28</b>	58#
	2560	20	1RB	22.35	23.0	1.161	0.207	0.24	59#
	2535	20	50%RB	21.11	22.0	1.227	0.180	0.22	60#
Body Back (0mm)	2510	20	1RB	22.39	23.0	1.151	0.361	0.42	61#
	2535	20	1RB	22.20	23.0	1.202	0.379	0.46	62#
	2560	20	1RB	22.35	23.0	1.161	<b>0.446</b>	<b>0.52</b>	63#
	2535	20	50%RB	21.11	22.0	1.227	0.306	0.38	64#

**LTE Band 12&17:**

EUT Position	Frequency (MHz)	Bandwidth (MHz)	Test Mode	Max Power (dBm)		Scaled Factor	1g SAR (W/kg)		Plot
				Meas.	Rated		Meas.	Rated	
FaceUp (25mm)	704	10	1RB	22.39	23.5	1.291	0.210	0.27	65#
	707.5	10	1RB	22.20	23.5	1.349	<b>0.261</b>	<b>0.35</b>	66#
	711	10	1RB	22.35	23.5	1.303	0.237	0.31	67#
	707.5	10	50%RB	21.11	22.0	1.227	0.217	0.27	68#
Body Back (0mm)	704	10	1RB	22.39	23.5	1.291	0.468	0.60	69#
	707.5	10	1RB	22.20	23.5	1.349	0.493	0.67	70#
	711	10	1RB	22.35	23.5	1.303	<b>0.543</b>	<b>0.71</b>	71#
	707.5	10	50%RB	21.11	22.0	1.227	0.396	0.49	72#

**LTE Band 13:**

EUT Position	Frequency (MHz)	Bandwidth (MHz)	Test Mode	Max Power (dBm)		Scaled Factor	1g SAR (W/kg)		Plot
				Meas.	Rated		Meas.	Rated	
FaceUp (25mm)	782	10	1RB	/	/	/	/	/	/
	782	10	1RB	23.75	24.0	1.059	0.356	0.38	73#
	782	10	1RB	/	/	/	/	/	/
	782	10	50%RB	23.09	24.0	1.233	0.292	0.36	74#
Body Back (0mm)	782	10	1RB	/	/	/	/	/	/
	782	10	1RB	23.75	24.0	1.059	0.609	0.65	75#
	782	10	1RB	/	/	/	/	/	/
	782	10	50%RB	23.09	24.0	1.233	0.489	0.60	76#

**LTE Band 26:**

EUT Position	Frequency (MHz)	Bandwidth (MHz)	Test Mode	Max Power (dBm)		Scaled Factor	1g SAR (W/kg)		Plot
				Meas.	Rated		Meas.	Rated	
FaceUp (25mm)	821.5	15	1RB	/	/	/	/	/	/
	831.5	15	1RB	21.76	23.5	1.493	<b>0.326</b>	<b>0.49</b>	77#
	841.5	15	1RB	/	/	/	/	/	/
	831.5	15	50%RB	20.97	22.0	1.268	0.26	0.33	78#
Body Back (0mm)	821.5	15	1RB	/	/	/	/	/	/
	831.5	15	1RB	21.76	23.5	1.493	<b>0.593</b>	<b>0.89</b>	79#
	841.5	15	1RB	/	/	/	/	/	/
	831.5	15	50%RB	20.97	22.0	1.268	0.455	0.58	80#

**LTE Band 38:**

EUT Position	Frequency (MHz)	Bandwidth (MHz)	Test Mode	Max Power (dBm)		Scaled Factor	1g SAR (W/kg)		Plot
				Meas.	Rated		Meas.	Rated	
FaceUp (25mm)	2580	20	1RB	23.02	23.5	1.117	0.109	0.12	81#
	2595	20	1RB	23.15	23.5	1.059	0.126	<b>0.14</b>	82#
	2610	20	1RB	23.24	23.5	1.062	0.121	0.13	83#
	2595	20	50%RB	22.26	22.5	1.057	0.095	0.10	84#
Body Back (0mm)	2580	20	1RB	23.02	23.5	1.117	0.231	<b>0.26</b>	85#
	2595	20	1RB	23.15	23.5	1.059	0.183	0.19	86#
	2610	20	1RB	23.24	23.5	1.062	0.241	0.26	87#
	2595	20	50%RB	22.26	22.5	1.057	0.144	0.15	88#

**LTE Band 41:**

EUT Position	Frequency (MHz)	Bandwidth (MHz)	Test Mode	Max Power (dBm)		Scaled Factor	1g SAR (W/kg)		Plot
				Meas.	Rated		Meas.	Rated	
FaceUp (25mm)	2506	20	1RB	/	/	/	/	/	/
	2593	20	1RB	22.27	23.0	1.183	<b>0.117</b>	<b>0.14</b>	89#
	2680	20	1RB	/	/	/	/	/	/
	2593	20	50%RB	20.86	21.5	1.159	0.099	0.11	90#
Body Back (0mm)	2506	20	1RB	/	/	/	/	/	/
	2593	20	1RB	22.27	23.0	1.183	<b>0.194</b>	<b>0.23</b>	91#
	2680	20	1RB	/	/	/	/	/	/
	2593	20	50%RB	20.86	21.5	1.159	0.156	0.18	92#

**Note:**

1. When the 1-g SAR is  $\leq 0.8\text{W/Kg}$ , testing for other channels are optional.
2. SAR for LTE band exposure configurations is measured according to the procedures of KDB 941225 D05 SAR for LTE Devices v02.
3. KDB941225D05-SAR for higher order modulation is required only when the highest maximum output power for the configuration in the higher order modulation is  $> 0.5\text{ dB}$  higher than the same configuration in QPSK or when the reported SAR for the QPSK configuration is  $> 1.45\text{ W/kg}$
4. KDB941225D05-For QPSK with 100% RB allocation, when the reported SAR measured for the Highest output power channel is  $< 1.45\text{ W/kg}$ , tests for the remaining required test channels are optional.
5. KDB941225D05- For QPSK with 100% RB allocation, SAR is not required when the highest maximum output power for 100 % RB allocation is less than the highest maximum output power in 50% and 1 RB allocations and the highest reported SAR for 1 RB and 50% RB allocation are  $\leq 0.8\text{ W/kg}$ .
6. KDB941225D05- Start with the largest channel bandwidth and measure SAR for QPSK with 1 RB allocation, using the RB offset and required test channel combination with the highest maximum output power among RB offset the upper edge, middle and lower edge of each required test channel.
7. KDB941225D05- other channel bandwidths SAR test is required when the highest maximum output power of a configuration requiring testing in the smaller channel bandwidth is  $> 0.5\text{ dB}$  higher than the equivalent channel configurations in the largest channel bandwidth configuration or the reported SAR of a configuration for the largest channel bandwidth is  $> 1.45\text{ W/kg}$ .
8. Worst case SAR for 50% RB allocation is selected to be tested.
9. KDB 648474 D04-When the peak SAR located in regions that probe is unable to access, a flat phantom is used for SAR measurement.

**WLAN 2.4G:**

EUT Position	Frequency (MHz)	Test Mode	Max. Meas. Power (dBm)	Max. Rated Power (dBm)	1g SAR (W/kg)			
					Scaled Factor	Meas. SAR	Scaled SAR	Plot
FaceUp (25mm)	2412	802.11b	/	/	/	/	/	/
	2437	802.11b	16.45	17.0	1.135	<b>0.030</b>	<b>0.03</b>	93.#
	2462	802.11b	/	/	/	/	/	/
Body Back (0mm)	2412	802.11a	15.20	17.0	1.514	0.121	<b>0.18</b>	94#
	2437	802.11a	16.45	17.0	1.135	0.134	0.15	95#
	2462	802.11a	15.88	17.0	1.294	0.126	0.16	96#

**WLAN 5.2G:**

EUT Position	Frequency (MHz)	Test Mode	Max. Meas. Power (dBm)	Max. Rated Power (dBm)	1g SAR (W/kg)			
					Scaled Factor	Meas. SAR	Scaled SAR	Plot
Body Back (0mm)	5180	802.11a	9.67	10.5	1.211	0.110	0.13	97#
	5200	802.11a	10.14	10.5	1.086	0.108	0.12	98#
	5240	802.11a	9.52	10.5	1.253	0.112	0.14	99#

**WLAN 5.6G:**

EUT Position	Frequency (MHz)	Test Mode	Max. Meas. Power (dBm)	Max. Rated Power (dBm)	1g SAR (W/kg)			
					Scaled Factor	Meas. SAR	Scaled SAR	Plot
Body Back (0mm)	5500	802.11a	10.37	10.5	1.030	0.166	<b>0.17</b>	100#
	5580	802.11a	10.35	10.5	1.035	0.138	0.14	101#
	5700	802.11a	9.76	10.5	1.186	0.102	0.12	102#

**WLAN 5.8G:**

EUT Position	Frequency (MHz)	Test Mode	Max. Meas. Power (dBm)	Max. Rated Power (dBm)	1g SAR (W/kg)			
					Scaled Factor	Meas. SAR	Scaled SAR	Plot
Body Back (0mm)	5745	802.11a	10.13	11.0	1.222	0.110	0.13	103#
	5785	802.11a	9.95	11.0	1.274	0.124	<b>0.16</b>	104#
	5825	802.11a	10.44	11.0	1.138	0.090	0.10	105#

**Note:**

1. When the 1-g SAR is  $\leq 0.8$  W/Kg, testing for other channels are optional.
2. When the highest *reported* SAR for DSSS is adjusted by the ratio of OFDM to DSSS specified maximum output power and the adjusted SAR is  $\leq 1.2$  W/kg, OFDM SAR is not required.
3. When SAR or MPE is not measured at the maximum power level allowed for production units, the results must be scaled to the maximum tune-up tolerance limit according to the power applied to the individual channels tested to determine compliance.

SAR Measurement Variability

In accordance with published RF Exposure KDB procedure 865664 D01 SAR measurement 100 MHz to 6 GHz v01. These additional measurements are repeated after the completion of all measurements requiring the same head or body tissue-equivalent medium in a frequency band. The test device should be returned to ambient conditions (normal room temperature) with the battery fully charged before it is re-mounted on the device holder for the repeated measurement(s) to minimize any unexpected variations in the repeated results

- 1) Repeated measurement is not required when the original highest measured SAR is < 0.80 W/kg; steps 2) through 4) do not apply.
- 2) When the original highest measured SAR is  $\geq 0.80$  W/kg, repeat that measurement once.
- 3) Perform a second repeated measurement only if the ratio of largest to smallest SAR for the original and first repeated measurements is > 1.20 or when the original or repeated measurement is  $\geq 1.45$  W/kg (~ 10% from the 1-g SAR limit).
- 4) Perform a third repeated measurement only if the original, first or second repeated measurement is  $\geq 1.5$  W/kg and the ratio of largest to smallest SAR for the original, first and second repeated measurements is > 1.20.

*Note: The same procedures should be adapted for measurements according to extremity and occupational exposure limits by applying a factor of 2.5 for extremity exposure and a factor of 5 for occupational exposure to the corresponding SAR thresholds.*

**The Highest Measured SAR Configuration in Each Frequency Band**

**Head**

SAR probe calibration point	Frequency Band	Freq.(MHz)	EUT Position	Meas. SAR (W/kg)		Largest to Smallest SAR Ratio
				Original	Repeated	
/	/	/	/	/	/	/

**Body**

SAR probe calibration point	Frequency Band	Freq.(MHz)	EUT Position	Meas. SAR (W/kg)		Largest to Smallest SAR Ratio
				Original	Repeated	
1900MHz (1810-1920MHz)	WCDMA Band 2	1852.4	Body Back	0.896	0.878	1.02
1800MHz (1650-1810MHz)	WCDMA Band 4	1712.4	Body Back	1.17	1.18	0.99

**Note:**

1. Second Repeated Measurement is not required since the ratio of the largest to smallest SAR for the original and first repeated measurement is not > 1.20.
2. The measured SAR results **do not** have to be scaled to the maximum tune-up tolerance to determine if repeated measurements are required.
3. SAR measurement variability must be assessed for each frequency band, which is determined by the **SAR probe calibration point and tissue-equivalent medium** used for the device measurements..

## SAR SIMULTANEOUS TRANSMISSION DESCRIPTION

### Simultaneous Transmission:

Description of Simultaneous Transmit Capabilities		
Transmitter Combination	Simultaneous?	Hotspot?
WWAN(GSM/WCDMA/LTE) + Bluetooth	√	×
WWAN(GSM/WCDMA/LTE) + WLAN	√	×

### Simultaneous and Hotspot SAR test exclusion considerations:

Mode(SAR1+SAR2)	Position	Reported SAR(W/kg)		ΣSAR < 1.6W/kg
		SAR1	SAR2	
GSM 850+Bluetooth	Face Up	0.48	0.03	0.51
	Body Worn Back	0.42	0.08	0.50
	Body Back	0.5	0.08	0.58
PCS1900 +Bluetooth	Face Up	0.16	0.03	0.19
	Body Worn Back	0.3	0.08	0.38
	Body Back	0.33	0.08	0.41
WCDMA Band 2+Bluetooth	Face Up	0.5	0.03	0.53
	Body Back	1.01	0.08	1.09
WCDMA Band 4+Bluetooth	Face Up	0.55	0.03	<b>0.58</b>
	Body Back	1.33	0.08	<b>1.41</b>
WCDMA Band 5+Bluetooth	Face Up	0.46	0.03	0.49
	Body Back	0.85	0.08	0.93
LTE Band 2+Bluetooth	Face Up	0.25	0.03	0.28
	Body Back	0.62	0.08	0.70
LTE Band 4+Bluetooth	Face Up	0.32	0.03	0.35
	Body Back	0.79	0.08	0.87
LTE Band 5+Bluetooth	Face Up	0.44	0.03	0.47
	Body Back	0.86	0.08	0.94
LTE Band 7+Bluetooth	Face Up	0.28	0.03	0.31
	Body Back	0.52	0.08	0.60
LTE Band 12&17+Bluetooth	Face Up	0.35	0.03	0.38
	Body Back	0.71	0.08	0.79
LTE Band 13+Bluetooth	Face Up	0.38	0.03	0.41
	Body Back	0.65	0.08	0.73
LTE Band 26+Bluetooth	Face Up	0.49	0.03	0.52
	Body Back	0.89	0.08	0.97
LTE Band 38+Bluetooth	Face Up	0.13	0.03	0.16
	Body Back	0.26	0.08	0.44
LTE Band 41+Bluetooth	Face Up	0.14	0.03	0.17
	Body Back	0.23	0.08	0.31

Mode(SAR1+SAR2)	Position	Reported SAR(W/kg)		$\Sigma$ SAR < 1.6W/kg
		SAR1	SAR2	
GSM 850+WLAN(2.4G)	Face Up	0.48	0.03	0.51
	Body Worn Back	0.42	0.18	0.60
	Body Back	0.5	0.18	0.68
PCS1900 +WLAN(2.4G)	Face Up	0.16	0.03	0.19
	Body Worn Back	0.3	0.18	0.48
	Body Back	0.33	0.18	0.51
WCDMA Band 2+WLAN(2.4G)	Face Up	0.5	0.03	0.53
	Body Back	1.01	0.18	1.19
WCDMA Band 4+WLAN(2.4G)	Face Up	0.55	0.03	<b>0.58</b>
	Body Back	1.33	0.18	<b>1.51</b>
WCDMA Band 5+WLAN(2.4G)	Face Up	0.46	0.03	0.49
	Body Back	0.85	0.18	1.03
LTE Band 2+WLAN(2.4G)	Face Up	0.25	0.03	0.28
	Body Back	0.62	0.18	0.80
LTE Band 4+WLAN(2.4G)	Face Up	0.32	0.03	0.35
	Body Back	0.79	0.18	0.97
LTE Band 5+WLAN(2.4G)	Face Up	0.44	0.03	0.47
	Body Back	0.86	0.18	1.04
LTE Band 7+WLAN(2.4G)	Face Up	0.28	0.03	0.31
	Body Back	0.52	0.18	0.70
LTE Band 12&17+WLAN(2.4G)	Face Up	0.35	0.03	0.38
	Body Back	0.71	0.18	0.89
LTE Band 13+WLAN(2.4G)	Face Up	0.38	0.03	0.41
	Body Back	0.65	0.18	0.83
LTE Band 26+WLAN(2.4G)	Face Up	0.49	0.03	0.52
	Body Back	0.89	0.18	1.07
LTE Band 38+WLAN(2.4G)	Face Up	0.13	0.03	0.16
	Body Back	0.26	0.18	0.44
LTE Band 41+WLAN(2.4G)	Face Up	0.14	0.03	0.17
	Body Back	0.23	0.18	0.41

Mode(SAR1+SAR2)	Position	Reported SAR(W/kg)		$\Sigma$ SAR < 1.6W/kg
		SAR1	SAR2	
GSM 850+WLAN(5.2G)	Face Up	0.48	0.14	0.62
	Body Worn Back	0.42	0.14	0.56
	Body Back	0.5	0.14	0.64
PCS1900 +WLAN(5.2G)	Face Up	0.16	0.14	0.30
	Body Worn Back	0.3	0.14	0.44
	Body Back	0.33	0.14	0.47
WCDMA Band 2+WLAN(5.2G)	Face Up	0.5	0.14	0.64
	Body Back	1.01	0.14	1.15
WCDMA Band 4+WLAN(5.2G)	Face Up	0.55	0.14	<b>0.69</b>
	Body Back	1.33	0.14	<b>1.47</b>
WCDMA Band 5+WLAN(5.2G)	Face Up	0.46	0.14	0.60
	Body Back	0.85	0.14	0.99
LTE Band 2+WLAN(5.2G)	Face Up	0.25	0.14	0.39
	Body Back	0.62	0.14	0.76
LTE Band 4+WLAN(5.2G)	Face Up	0.32	0.14	0.46
	Body Back	0.79	0.14	0.93
LTE Band 5+WLAN(5.2G)	Face Up	0.44	0.14	0.58
	Body Back	0.86	0.14	1.00
LTE Band 7+WLAN(5.2G)	Face Up	0.28	0.14	0.42
	Body Back	0.52	0.14	0.66
LTE Band 12&17+WLAN(5.2G)	Face Up	0.35	0.14	0.49
	Body Back	0.71	0.14	0.85
LTE Band 13+WLAN(5.2G)	Face Up	0.38	0.14	0.52
	Body Back	0.65	0.14	0.79
LTE Band 26+WLAN(5.2G)	Face Up	0.49	0.14	0.63
	Body Back	0.89	0.14	1.03
LTE Band 38+WLAN(5.2G)	Face Up	0.13	0.14	0.27
	Body Back	0.26	0.14	0.40
LTE Band 41+WLAN(5.2G)	Face Up	0.14	0.14	0.28
	Body Back	0.23	0.14	0.37



Mode(SAR1+SAR2)	Position	Reported SAR(W/kg)		ΣSAR < 1.6W/kg
		SAR1	SAR2	
GSM 850+WLAN(5.6G)	Face Up	0.48	0.14	0.62
	Body Worn Back	0.42	0.17	0.59
	Body Back	0.5	0.17	0.67
PCS1900 +WLAN(5.6G)	Face Up	0.16	0.14	0.30
	Body Worn Back	0.3	0.17	0.47
	Body Back	0.33	0.17	0.50
WCDMA Band 2+WLAN(5.6G)	Face Up	0.5	0.14	0.64
	Body Back	1.01	0.17	1.18
WCDMA Band 4+WLAN(5.6G)	Face Up	0.55	0.14	<b>0.69</b>
	Body Back	1.33	0.17	<b>1.50</b>
WCDMA Band 5+WLAN(5.6G)	Face Up	0.46	0.14	0.60
	Body Back	0.85	0.17	1.02
LTE Band 2+WLAN(5.6G)	Face Up	0.25	0.14	0.39
	Body Back	0.62	0.17	0.79
LTE Band 4+WLAN(5.6G)	Face Up	0.32	0.14	0.46
	Body Back	0.79	0.17	0.96
LTE Band 5+WLAN(5.6G)	Face Up	0.44	0.14	0.58
	Body Back	0.86	0.17	1.03
LTE Band 7+WLAN(5.6G)	Face Up	0.28	0.14	0.42
	Body Back	0.52	0.17	0.69
LTE Band 12&17+WLAN(5.6G)	Face Up	0.35	0.14	0.49
	Body Back	0.71	0.17	0.88
LTE Band 13+WLAN(5.6G)	Face Up	0.38	0.14	0.52
	Body Back	0.65	0.17	0.82
LTE Band 26+WLAN(5.6G)	Face Up	0.49	0.14	0.63
	Body Back	0.89	0.17	1.06
LTE Band 38+WLAN(5.6G)	Face Up	0.13	0.14	0.27
	Body Back	0.26	0.17	0.43
LTE Band 41+WLAN(5.6G)	Face Up	0.14	0.14	0.28
	Body Back	0.23	0.17	0.40

Mode(SAR1+SAR2)	Position	Reported SAR(W/kg)		$\Sigma$ SAR < 1.6W/kg
		SAR1	SAR2	
GSM 850+WLAN(5.8G)	Face Up	0.48	0.16	0.64
	Body Worn Back	0.42	0.16	0.58
	Body Back	0.5	0.16	0.66
PCS1900 +WLAN(5.8G)	Face Up	0.16	0.16	0.32
	Body Worn Back	0.3	0.16	0.46
	Body Back	0.33	0.16	0.49
WCDMA Band 2+WLAN(5.8G)	Face Up	0.5	0.16	0.66
	Body Back	1.01	0.16	1.17
WCDMA Band 4+WLAN(5.8G)	Face Up	0.55	0.16	<b>0.71</b>
	Body Back	1.33	0.16	<b>1.49</b>
WCDMA Band 5+WLAN(5.8G)	Face Up	0.46	0.16	0.62
	Body Back	0.85	0.16	1.01
LTE Band 2+WLAN(5.8G)	Face Up	0.25	0.16	0.41
	Body Back	0.62	0.16	0.78
LTE Band 4+WLAN(5.8G)	Face Up	0.32	0.16	0.48
	Body Back	0.79	0.16	0.95
LTE Band 5+WLAN(5.8G)	Face Up	0.44	0.16	0.60
	Body Back	0.86	0.16	1.02
LTE Band 7+WLAN(5.8G)	Face Up	0.28	0.16	0.44
	Body Back	0.52	0.16	0.68
LTE Band 12&17+WLAN(5.8G)	Face Up	0.35	0.16	0.51
	Body Back	0.71	0.16	0.87
LTE Band 13+WLAN(5.8G)	Face Up	0.38	0.16	0.54
	Body Back	0.65	0.16	0.81
LTE Band 26+WLAN(5.8G)	Face Up	0.49	0.16	0.65
	Body Back	0.89	0.16	1.05
LTE Band 38+WLAN(5.8G)	Face Up	0.13	0.16	0.29
	Body Back	0.26	0.16	0.42
LTE Band 41+WLAN(5.8G)	Face Up	0.14	0.16	0.30
	Body Back	0.23	0.16	0.39

**Note:**

1. Hotspot mode SAR is measured for all edges and surfaces of the device with a transmitting antenna located within 25 mm from that surface or edge; for the data modes, wireless technologies and frequency bands supporting hotspot mode.
2. Hotspot Mode is not feasible during voice calls.

**Conclusion:**

Sum of SAR:  $\Sigma$ SAR  $\leq$  1.6 W/kg therefore simultaneous transmission SAR with Volume Scans is not required.

## **SAR Plots**

---

**Please Refer to the Attachment.**

## APPENDIX A MEASUREMENT UNCERTAINTY

The uncertainty budget has been determined for the measurement system and is given in the following Table.  
**Measurement uncertainty evaluation for IEEE1528-2013 SAR test**

Source of uncertainty	Tolerance/ uncertainty ± %	Probability distribution	Divisor	ci (1 g)	ci (10 g)	Standard uncertainty ± %, (1 g)	Standard uncertainty ± %, (10 g)
<b>Measurement system</b>							
Probe calibration	6.55	N	1	1	1	6.6	6.6
Axial Isotropy	4.7	R	$\sqrt{3}$	1	1	2.7	2.7
Hemispherical Isotropy	9.6	R	$\sqrt{3}$	0	0	0.0	0.0
Boundary effect	1.0	R	$\sqrt{3}$	1	1	0.6	0.6
Linearity	4.7	R	$\sqrt{3}$	1	1	2.7	2.7
Detection limits	1.0	R	$\sqrt{3}$	1	1	0.6	0.6
Readout electronics	0.3	N	1	1	1	0.3	0.3
Response time	0.0	R	$\sqrt{3}$	1	1	0.0	0.0
Integration time	0.0	R	$\sqrt{3}$	1	1	0.0	0.0
RF ambient conditions – noise	1.0	R	$\sqrt{3}$	1	1	0.6	0.6
RF ambient conditions–reflections	1.0	R	$\sqrt{3}$	1	1	0.6	0.6
Probe positioner mech. Restrictions	0.8	R	$\sqrt{3}$	1	1	0.5	0.5
Probe positioning with respect to phantom shell	6.7	R	$\sqrt{3}$	1	1	3.9	3.9
Post-processing	2.0	R	$\sqrt{3}$	1	1	1.2	1.2
<b>Test sample related</b>							
Test sample positioning	2.8	N	1	1	1	2.8	2.8
Device holder uncertainty	6.3	N	1	1	1	6.3	6.3
Drift of output power	5.0	R	$\sqrt{3}$	1	1	2.9	2.9
<b>Phantom and set-up</b>							
Phantom uncertainty (shape and thickness tolerances)	4.0	R	$\sqrt{3}$	1	1	2.3	2.3
Liquid conductivity target)	5.0	R	$\sqrt{3}$	0.64	0.43	1.8	1.2
Liquid conductivity meas.)	2.5	N	1	0.64	0.43	1.6	1.1
Liquid permittivity target)	5.0	R	$\sqrt{3}$	0.6	0.49	1.7	1.4
Liquid permittivity meas.)	2.5	N	1	0.6	0.49	1.5	1.2
Combined standard uncertainty		RSS				12.2	12.0
Expanded uncertainty 95 % confidence interval)						24.3	23.9

**Measurement uncertainty evaluation for IEC62209-2 SAR test**

Source of uncertainty	Tolerance/ uncertainty ± %	Probability distribution	Divisor	ci (1 g)	ci (10 g)	Standard uncertainty ± %, (1 g)	Standard uncertainty ± %, (10 g)
<b>Measurement system</b>							
Probe calibration	6.55	N	1	1	1	6.6	6.6
Axial Isotropy	4.7	R	√3	1	1	2.7	2.7
Hemispherical Isotropy	9.6	R	√3	0	0	0.0	0.0
Linearity	4.7	R	√3	1	1	2.7	2.7
Modulation Response	0.0	R	√3	1	1	0.0	0.0
Detection limits	1.0	R	√3	1	1	0.6	0.6
Boundary effect	1.0	R	√3	1	1	0.6	0.6
Readout electronics	0.3	N	1	1	1	0.3	0.3
Response time	0.0	R	√3	1	1	0.0	0.0
Integration time	0.0	R	√3	1	1	0.0	0.0
RF ambient conditions – noise	1.0	R	√3	1	1	0.6	0.6
RF ambient conditions–reflections	1.0	R	√3	1	1	0.6	0.6
Probe positioner mech. Restrictions	0.8	R	√3	1	1	0.5	0.5
Probe positioning with respect to phantom shell	6.7	R	√3	1	1	3.9	3.9
Post-processing	2.0	R	√3	1	1	1.2	1.2
<b>Test sample related</b>							
Device holder Uncertainty	6.3	N	1	1	1	6.3	6.3
Test sample positioning	2.8	N	1	1	1	2.8	2.8
Power scaling	4.5	R	√3	1	1	2.6	2.6
Drift of output power	5.0	R	√3	1	1	2.9	2.9
<b>Phantom and set-up</b>							
Phantom uncertainty (shape and thickness tolerances)	4.0	R	√3	1	1	2.3	2.3
Algorithm for correcting SAR for deviations in permittivity and conductivity	1.9	N	1	1	0.84	1.1	0.9
Liquid conductivity (meas.)	2.5	N	1	0.64	0.43	1.6	1.1
Liquid permittivity (meas.)	2.5	N	1	0.6	0.49	1.5	1.2
Temp. unc. - Conductivity	1.7	R	√3	0.78	0.71	0.8	0.7
Temp. unc. - Permittivity	0.3	R	√3	0.23	0.26	0.0	0.0
Combined standard uncertainty		RSS				12.2	12.1
Expanded uncertainty 95 % confidence interval)						24.5	24.2

## **APPENDIX B EUT TEST POSITION PHOTOS**

---

**Please Refer to the Attachment.**

## **APPENDIX C CALIBRATION CERTIFICATES**

---

**Please Refer to the Attachment.**

**\*\*\*\*\* END OF REPORT \*\*\*\*\***