

PDC760 Multi-mode Advanced Radio

User Manual

Preface

Welcome to the world of Hytera and thank you for purchasing this product. This manual includes a description of the functions and step-by-step procedures for use. To avoid bodily injury or property loss caused by incorrect operation, please carefully read the *Safety Information Booklet* before use.

This manual is applicable to the following product:

PDC760 Multi-mode Advanced Radio

Copyright Information

Hytera is the trademark or registered trademark of Hytera Communications Corporation Limited (the Company) in the People's Republic of China (PRC) and/or other countries or areas. The Company retains the ownership of its trademarks and product names. All other trademarks and/or product names that may be used in this manual are properties of their respective owners.

The product described in this manual may include the Company's computer programs stored in memory or other media. Laws in PRC and/or other countries or areas protect the exclusive rights of the Company with respect to its computer programs. The purchase of this product shall not be deemed to grant, either directly or by implication, any rights to the purchaser regarding the Company's computer programs. The Company's computer programs may not be copied, modified, distributed, decompiled, or reverse-engineered in any manner without the prior written consent of the Company.

Disclaimer

The Company endeavors to achieve the accuracy and completeness of this manual, but no warranty of accuracy or reliability is given. All the specifications and designs are subject to change without notice due to continuous technological development. No part of this manual may be copied, modified, translated, or distributed in any manner without the prior written consent of the Company.

We do not guarantee, for any particular purpose, the accuracy, validity, timeliness, legitimacy or completeness of the third-party products and contents involved in this manual.

If you have any suggestions or would like to receive more information, please visit our website at <http://www.hytera.com>.

FCC Statement

This equipment has been tested and found to comply with the limits for a Class B digital device, pursuant to part 15 of FCC Rules. These limits are designed to provide reasonable protection against harmful interference in a residential installation. This equipment generates and can radiate radio frequency energy. If not installed and used in accordance with the instructions, it may cause harmful interference to radio communications. However, there is no guarantee that interference will not occur in a particular installation. Verification of harmful interference by this equipment to radio or television

reception can be determined by turning it off and then on. The user is encouraged to try to correct the interference by one or more of the following measures:

- Reorient or relocate the receiving antenna. Increase the separation between the equipment and receiver.
- Connect the equipment into an outlet on a different circuit to that of the receiver's outlet.
- Consult the dealer or an experienced radio/TV technician for help.

Operation is subject to the following two conditions:

- This device may not cause harmful interference.
- This device must accept any interference received, including interference that may cause undesired operation.

Note: Changes or modifications to this unit not expressly approved by the party responsible for compliance could void the user's authority to operate the equipment.

Compliance with RF Exposure Standards

Hytera's radio complies with the following RF energy exposure standards and guidelines:

- United States Federal Communications Commission, Code of Federal Regulations; 47CFR § 1.1307, 1.1310 and 2.1093
- American National Standards Institute (ANSI)/Institute of Electrical and Electronic Engineers (IEEE) C95.1:2005; Canada RSS102 Issue 5 March 2015
- Institute of Electrical and Electronic Engineers (IEEE) C95.1:2005 Edition

RF Exposure Compliance and Control Guidelines and Operating Instructions

To control your exposure and ensure compliance with the occupational/controlled environmental exposure limits, always adhere to the following procedures.

Guidelines:

- Do not remove the RF Exposure Label from the device.
- User awareness instructions should accompany device when transferred to other users.

- Do not use this device if the operational requirements described herein are not met.

Operating Instructions:

- Transmit no more than the rated duty factor of 50% of the time. To transmit (talk), push the Push-To-Talk (PTT) key. To receive calls, release the PTT key. Transmitting 50% of the time, or less, is important because the radio generates measurable RF energy only when transmitting (in terms of measuring for standards compliance).
- Keep the radio unit at least 2.5 cm away from the face. Keeping the radio at the proper distance is important as RF exposure decreases with distance from the antenna. The antenna should be kept away from the face and eyes.
- When worn on the body, always place the radio in a Hytera-approved holder, holster, case, or body harness or by use of the correct clip for this product. **The** exposure levels **should not** exceed the FCC's occupational/controlled environmental RF exposure limits.
- Use of non-approved antennas, batteries, and accessories causes the radio to exceed the FCC RF exposure guidelines.
- Contact your local dealer for the optional accessories of the product.

This equipment complies with FCC radiation exposure limits set forth for an controlled environment. This equipment should be installed and operated with minimum distance 0cm between the radiator and your body. This transmitter must not be co-located or operating in conjunction with any other antenna or transmitter.

IC Statement

The device has been tested and complies with SAR limits; users can obtain Canadian information on RF exposure and compliance.

Après examen de cematériel aux conformité aux limites DAS et/ou aux limites d'intensité de champ RF, les utilisateurs peuvent sur l'exposition aux radiofréquences et la conformité and compliance d'acquérir les informations correspondantes.

This device complies with Innovation, Science and Economic Development Canada Compliance license-exempt RSS standard(s). Operation is subject to the following two conditions:

- This device may not cause harmful interference.
- This device must accept any interference received, including interference that may cause undesired operation.

Le présent appareil est conforme auxCNR d'Industrie Canada applicables aux appareils radio exempts de licence. L'exploitation est autorisée aux deux conditions suivantes: (1) l'appareil ne doit pas produire de brouillage, et (2) l'utilisateur de l'appareil doit accepter tout brouillage radioélectrique subi, même si le brouillage est susceptible d'en compromettre le fonctionnement.

EU Regulatory Conformance

As certified by the qualified laboratory, the product is in compliance with the essential requirements and other relevant provisions of 2014/53/EU, 2012/19/EU, 2011/65/EU, and 2006/66/EC.

Please note that the above information is applicable to EU countries only.

Contents

Documentation Information	1
1. Packing List	3
2. Product Layout.....	4
3. Before Use	5
3.1 Attaching the Antenna	5
3.2 Installing the Micro-SIM Card and Micro-SD Card	5
3.3 Attaching the Belt Clip	6
3.4 Attaching the Battery.....	7
3.5 Charging the Battery.....	7
4. Basic Operations	9
4.1 Turning the Radio On or Off	9
4.2 Adjusting the Volume	9
4.3 Selecting Channels or Contacts	9
4.4 Understanding the Screens.....	9
4.4.1 Top Screen	10
4.4.2 Main Screen	10
4.5 Locking and Unlocking the Main Screen	14
4.6 Managing the Widgets.....	15
4.7 Switching the Operation Mode.....	16
4.8 Connecting to the Networks	17
4.8.1 Private Network.....	17
4.8.2 Public Network.....	18

4.8.3 WLAN Network	18
4.8.4 Airplane Mode	18
5. Status Indications	20
5.1 LCD Icons.....	20
5.2 LED Indications.....	22
5.2.1 LED Indicator 1.....	22
5.2.2 LED Indicator 2.....	23
6. Call Services.....	24
6.1 Group Calls.....	24
6.1.1 Initiating Group Calls.....	24
6.1.2 Receiving and Responding to Group Calls.....	25
6.1.3 Ending or Exiting Group Calls.....	25
6.2 Private Calls and Phone Calls	25
6.2.1 Initiating Private Calls and Phone Calls.....	25
6.2.2 Receiving and Responding to Private Calls and Phone Calls.....	27
6.2.3 Ending Private Calls and Phone Calls.....	27
6.3 All Calls.....	28
6.3.1 Initiating All Calls	28
6.3.2 Receiving All Calls.....	28
6.3.3 Ending or Exiting All Calls	29
6.4 Broadcast Calls (Trunking Only).....	29
6.4.1 Initiating Broadcast Calls	29
6.4.2 Receiving Broadcast Calls.....	29
6.4.3 Ending or Exiting Broadcast Calls	29



6.5 Calls on Analog Channels	30
6.6 Emergency Calls	30
6.6.1 Initiating Emergency Calls	30
6.6.2 Receiving Emergency Calls	31
6.6.3 Ending or Exiting Emergency Calls	31
7. Message Services.....	32
7.1 Viewing Messages.....	32
7.2 Sending Messages.....	32
7.3 Managing Messages.....	32
8. Supplementary Features	34
8.1 Basic Settings	34
8.2 Programmable Keys	35
8.3 Contact Management	37
8.3.1 Adding Private Contacts.....	37
8.3.2 Adding Contacts to Favorites	38
8.3.3 Deleting Private Contacts	38
8.3.4 Managing Zones	38
8.3.5 Managing Subgroups	39
8.4 Wireless and Network	39
8.4.1 Mobile Network.....	39
8.4.2 WLAN	40
8.4.3 BT	40
8.4.4 Tethering and Portable Hotspot	41
8.4.5 NFC.....	42

8.4.6 VPN	42
8.5 Applications	42
8.5.1 Camera	42
8.5.2 Gallery	45
8.5.3 Clock	47
8.5.4 Calendar.....	50
8.5.5 Browser	52
8.5.6 Calculator	52
8.5.7 Compass	53
8.5.8 Recorder.....	53
8.5.9 App Store	54
8.5.10 File Manager	55
8.6 App Manager.....	55
8.7 Power Level.....	56
8.8 Audio Mode.....	56
8.9 Scan	57
8.9.1 Scanning in Conventional Mode.....	57
8.9.2 Scanning in Trunking Mode.....	57
8.10 Roam	58
8.11 Position	59
8.12 Analog Services.....	59
8.12.1 Turning the Monitor Feature On or Off	59
8.12.2 Turning the Squelch On Feature On or Off.....	59
8.12.3 Setting the Squelch Level	59

8.13 Encryption.....	60
8.14 Stun.....	60
8.15 Kill.....	60
8.16 System Upgrade.....	60
9. Troubleshooting.....	62
10. Care and Cleaning.....	66
11. Optional Accessories.....	67
12. Abbreviations.....	68

Documentation Information

Icon Conventions

Icon	Description
 Note	Indicates references that can further describe the related topics.
 Caution	Indicates situations that could cause data loss or equipment damage.









Notation Conventions

Item	Description	Example
Boldface	Denotes menus, tabs, parameter names, window names, dialogue names, and hardware buttons.	To save the configuration, click Apply .
		The Log Level Settings dialogue appears.
		Press the PTT key.
" "	Denotes messages, directories, file names, folder names, and parameter values.	The screen displays "Invalid Battery!"
		Open "PDT_PSS.exe".
		Go to "D:/opt/local".
		In the Port text box, enter "22".
>	Directs you to access a multi-level menu.	Go to File>New .
<i>Italic</i>	Denotes document titles.	For details about using the DWS, refer to <i>Dispatch Workstation User Guide</i> .
Courier New	Denotes commands and their execution results.	To set the IP address, run the following command: <code>vos-cmd - m name IP</code>

Key Operations

Operation	Description
Short press	Press and release quickly.
Long press	Press and hold for the preset duration.
Double press	Press twice continuously and quickly.
Press and hold	Keep the key pressed.

Main Screen Operations

Operation	Illustration	Description	Example
Tap		Touch an item once with your finger.	Tap  to open the Camera app.
Touch and press		Touch an item with your finger and maintain contact.	Touch and press  until it jiggles.
Swipe		Swipe your finger across the screen.	Swipe down from the top edge of any screen to access the notification panel.
Drag		Touch and press an item, and then move it to a new position.	Touch and press  until it jiggles, and then drag it to the proper position.
Pinch		Move two fingers together on the screen.	Pinch a photo to zoom out.
Spread		Move two fingers apart on the screen.	Spread a photo to zoom in.

1. Packing List

Please unpack carefully and check that you have received the following items. If any item is missing or damaged, please contact your dealer.

Item	Quantity (PCS)	Item	Quantity (PCS)
Radio	1	Color Ring	4
Battery	1	Belt Clip	1
Charger	1	Strap	1
Power Adapter	1	Documentation Kit	1
Antenna	1	/	/

 Note

- Pictures in this manual are for reference only.
 - Check whether the frequency band marked on the antenna label matches that on the radio label. If not, please contact your dealer.
-

2. Product Layout

Top Key (TK)
 Programmable key. You can set the key as shortcut to radio features. Then you can press or hold the key to trigger the assigned features.

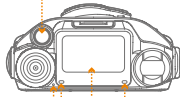

Microphone 3
 LED Indicator 2
 Top Screen
 LED Indicator 1

Smart Key

- When the main screen is on, press and hold to turn the screen off.
- When the main screen is off, press to turn it on, or press and hold to open the camera.
- Press to mute the ringtone or end calls.
- Press to view more or flip the page when viewing the Home screen and App panel or browsing the internet.

Push-to-Talk (PTT) Key

- Press to initiate or answer calls.
- Press and hold to speak during half-duplex calls.

**Side Key 2 (SK2)
 Side Key 3 (SK3)**

Programmable keys. You can set the keys as shortcuts to radio features. Then you can press, double press, or hold the keys to trigger the assigned features.

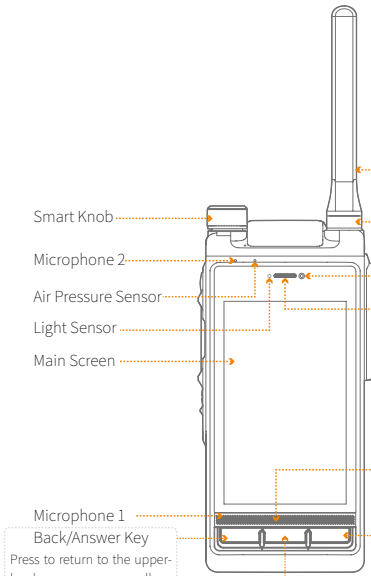
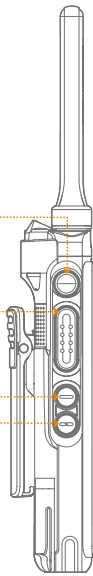

Microphone 1
 Back/Answer Key
 Press to return to the upper-level menu or answer calls.

On-Off/End key

- Press to reject incoming calls or end calls.
- Press and hold to turn the radio or Android Platform (AP) on or off.

Home Key

- When the main screen is off, press to wake the screen.
- When the main screen is on, press to return to the Home screen, or double press to view running apps.

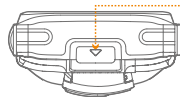

Antenna
 Color Ring
 Front-facing Camera
 Receiver
 Speaker

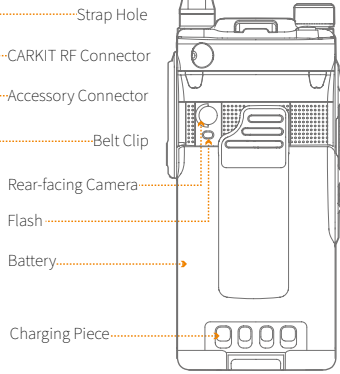
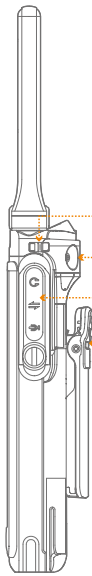

Strap Hole
 CARKIT RF Connector
 Accessory Connector
 Belt Clip
 Rear-facing Camera
 Flash
 Battery
 Charging Piece

3. Before Use

3.1 Attaching the Antenna

1. (Optional) Place the color ring (for identification purpose) on the antenna connector.
2. Put the antenna on the antenna connector.
3. Rotate the antenna clockwise till hand tight.

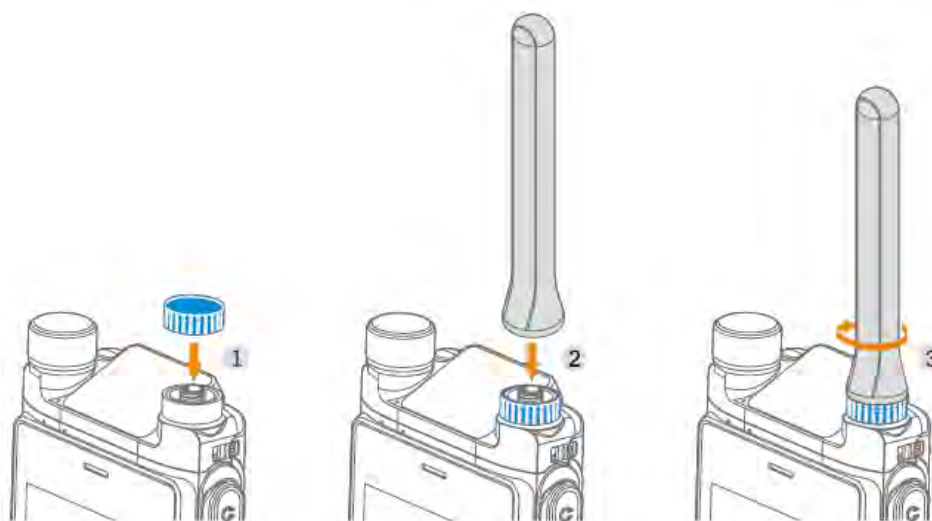

Caution

Do not hold the radio by the antenna, because it may reduce the radio performance and life span of the antenna.

3.2 Installing the Micro-SIM Card and Micro-SD Card

1. Open the card slot cover on the top of the battery compartment.
2. Install the micro-SIM card.
 - a. Pull the micro-SIM card tray out of the slot, and place the micro-SIM card with the gold contacts facing up on the tray.
 - b. Insert the card tray with the micro-SIM card back into the slot.
3. (Optional) Insert the micro-SD card into the corresponding slot.
4. Put the card slot cover back in place.

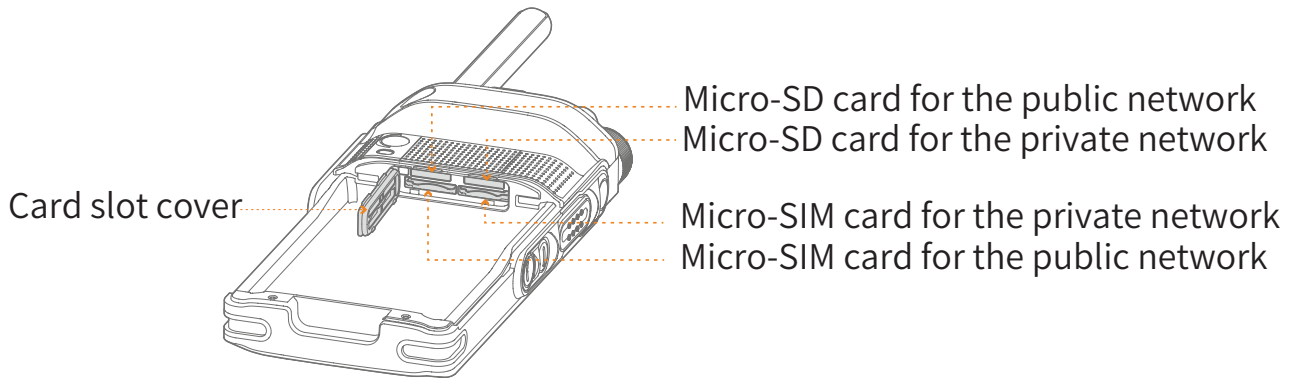

 Note

To re-install the micro-SD card, take the card out completely, and then re-insert it to the slot.

3.3 Attaching the Belt Clip

1. Align the rails on the belt clip with the grooves on the battery.
2. Press the belt clip downwards into place.

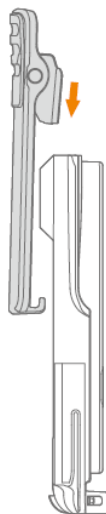

 Note

To remove the belt clip, press and hold the spring when sliding the belt clip out of the grooves on the battery.

3.4 Attaching the Battery

1. Slide the battery into the slot.
2. Press the battery latch until it is fully fitted into the radio.

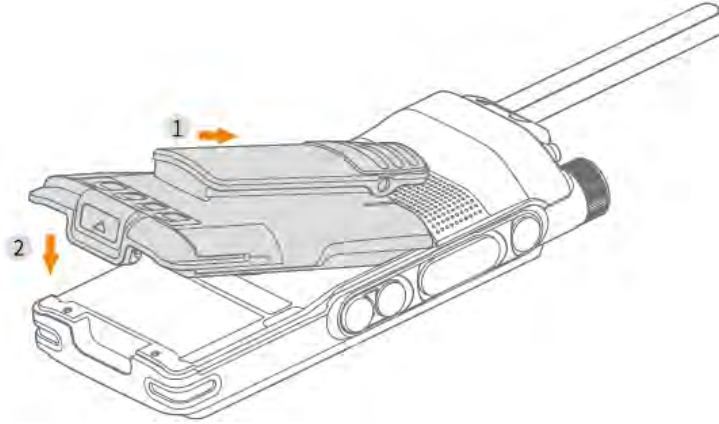

3.5 Charging the Battery

⚠ Caution

- Read the *Safety Information Booklet* before charging.
 - Use the approved charger to charge the battery.
 - The remaining lithium-ion battery power is limited to 30% pursuant to the new lithium battery shipment regulation approved by International Air Transport Association (IATA).
-

Before initial use, fully charge the battery to ensure optimum performance. You can charge the radio with battery attached or charge the battery alone.

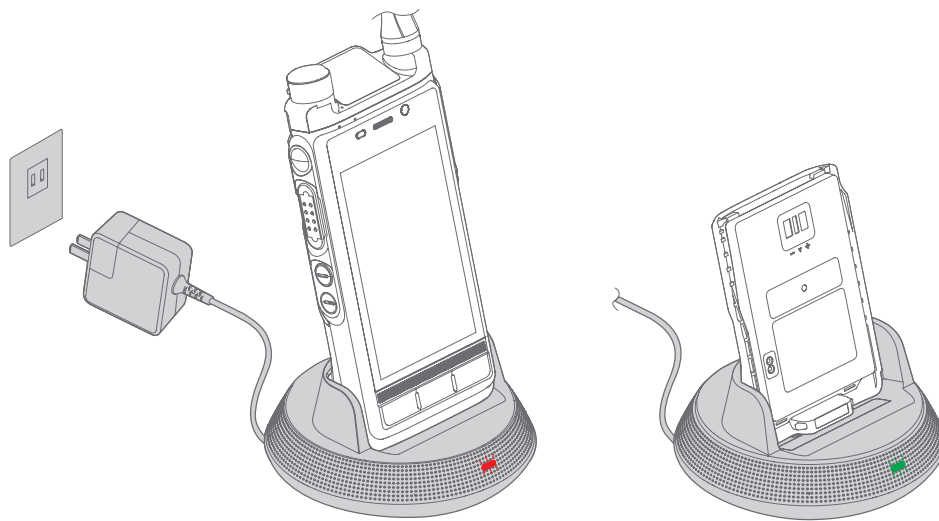

To determine the charging status, check the LED indicator on the charger according to the following table:

LED Indicator	Charging Status
Glows red	The battery is being charged.
Glows green	<ul style="list-style-type: none"> ● When the radio is being charged with the battery attached: The battery is charged to 90% or above. ● When the battery is being charged alone: The battery is charged to 95% or above.
Flashes red rapidly	The battery fails to be charged.

4. Basic Operations

4.1 Turning the Radio On or Off

To turn the radio on, press and hold the **On-Off/End** key until the splash screen appears.

To turn the radio off, do as follows:

1. Press and hold the **On-Off/End** key until the power-off selection screen appears.
2. Tap **Device Power Off**, and then tap **Sure**.

4.2 Adjusting the Volume

To increase the volume, directly rotate the **Smart Knob** clockwise.

To decrease the volume, directly rotate the **Smart Knob** anticlockwise.

Note

You can also go to **Settings > General > Sounds > Volume** to adjust the volume of ringtone, media, alarm, and call.

4.3 Selecting Channels or Contacts

1. Press the **Smart Knob**.
 2. Rotate the knob to select the required channel or contact.
-

Note

If you do not operate the knob for 5s or if you press it again within 5s, it automatically returns to the volume control state.

4.4 Understanding the Screens

The radio has two screens: top screen and main screen.

Caution

The screens may be damaged or broken if they are hit or scraped by sharp or hard objects. All

care must be taken to protect the screens.

4.4.1 Top Screen

The top screen, which shows information about narrow band (NB) services, includes the following three bars:

- Status bar: Shows icons indicating battery power, signal strength and other statuses.
- Content bar: Shows the selected channel or contact and icons related to ongoing calls.
- Information bar: Shows icons indicating the number of unread messages and missed calls, time, and current operation mode.



4.4.2 Main Screen

The main screen is a touch screen where you can manage widgets and apps, and make settings.

Home Screen

The Home screen is the main screen you view upon power-on. It contains the status bar, NB widget, and broadband (BB) widgets.



Apps Panel



To access Apps, do as follows:

1. Swipe right from the left edge of the Home screen.
2. Swipe up or down to view all apps.

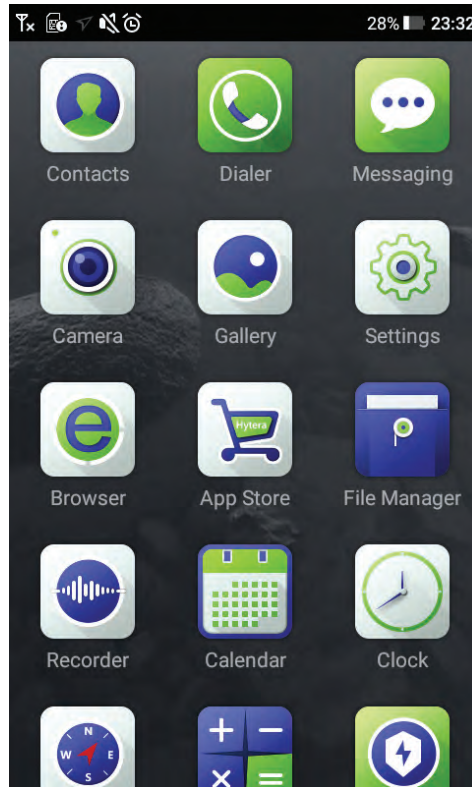
To set your preferred way to access the apps panel, go to **Settings > General > Personalization > App Center**, and then select **Swipe from left edge**, **Swipe from right edge**, or **Swipe from both edges**.



On the apps panel, you can do the following operations:

- Open an app: tap the required app icon.
- Reposition an app: touch and press the required app icon until it jiggles, and drag it to a new location.
- Uninstall an app: touch and press the required app icon until it jiggles, and tap .
- Double press the **Home** key to reveal the multitasking screen, swipe up or down to the required app, and then tap it. To close a running app, swipe the app left or right from the multitasking display. To close all running apps, tap .

Quick Setting Panel

The quick setting panel allows you to access handy features, such as Camera, Flashlight, and Calculator. You can also adjust the brightness, and turn on or off the airplane mode, wireless local area network (WLAN), NB network, etc. To access the quick setting panel, swipe up from the bottom edge of any screen. You can swipe left to view more items.

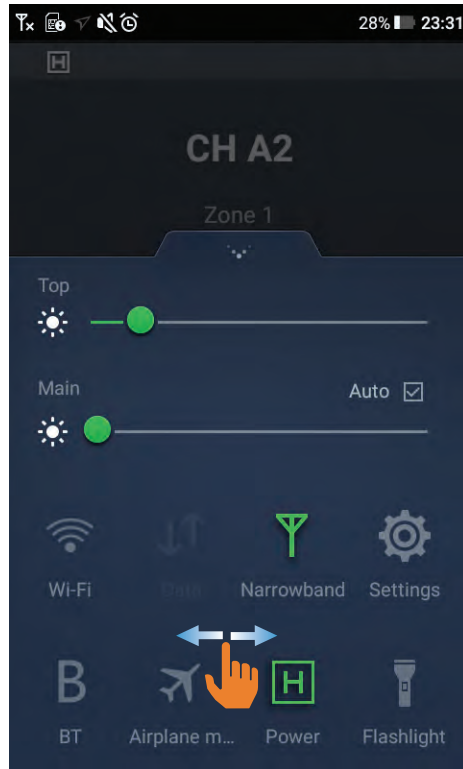

To reposition an item, tap and hold the item until it is highlighted, and drag it to a new location.

Notification Panel

You can access the notification panel to view notifications and search for apps, contacts or messages.

- To view notifications, do as follows:
 1. Swipe down from the top edge of any screen.
 2. Tap a notification to view the details.
- To search for apps, contacts or messages, enter key words in the search box at the top of the screen.
- To clear a notification, swipe the notification left or right. To clear all notifications, tap **Clear** at the bottom of the notification panel.

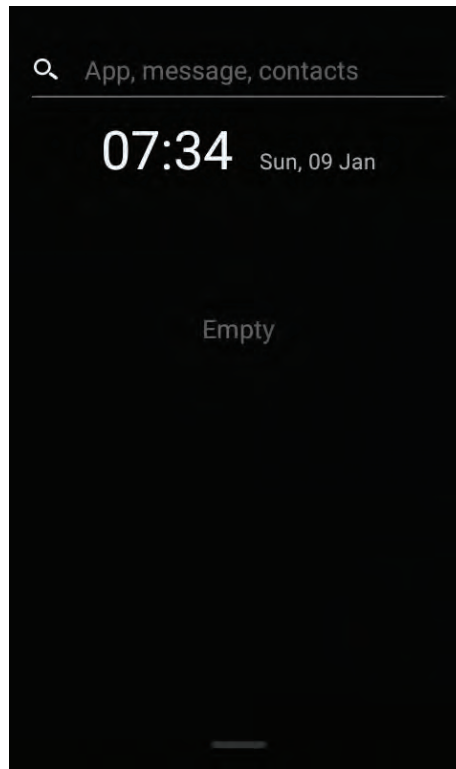

4.5 Locking and Unlocking the Main Screen

When the main screen is not in use, you can lock it to avoid unintended operations and increase battery life.

- To manually lock the screen: press and hold the **Smart Key** when the main screen is on.
- To allow the main screen to be turned off automatically: go to **Settings>General>Device>Display>Main Screen>Sleep**, and then tap the required interval.
- To wake up the screen: press the **Smart Key** or the **Home** key when the main screen is off.

To protect privacy, it is recommended that you secure your radio using a screen lock. The screen lock is triggered after the main screen is turned off.

To set a screen lock, do as follows:

1. Go to **Settings > General > Lock screen > Unlock pattern**.
2. Tap **Unlock pattern**, and then tap one of the following:
 - **None**: The screen will never be locked.
 - **Swipe**: Swipe up to unlock.
 - **Password**: Create a password for unlocking the screen.
 - **Pattern**: Create a pattern that you draw on the screen to unlock it.

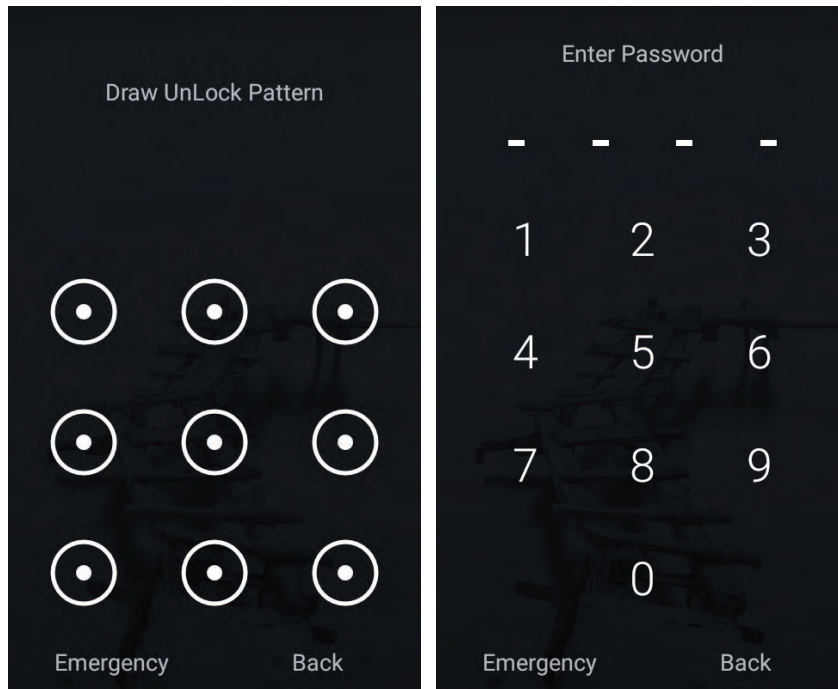

4.6 Managing the Widgets

A widget is a miniature application that allows you to quickly open applications and view updates. On the home screen, you can access, add, delete, or reposition widgets.

 Note

The NB widgets cannot be deleted or repositioned.

Accessing Widgets

On the Home screen, swipe up or down to the required widget, and then tap it.

Adding Widgets

1. Swipe down to the bottom of the Home screen, and tap **Edit**.
2. Tap **Add**, and then tap the required widget.
3. Tap **OK**.

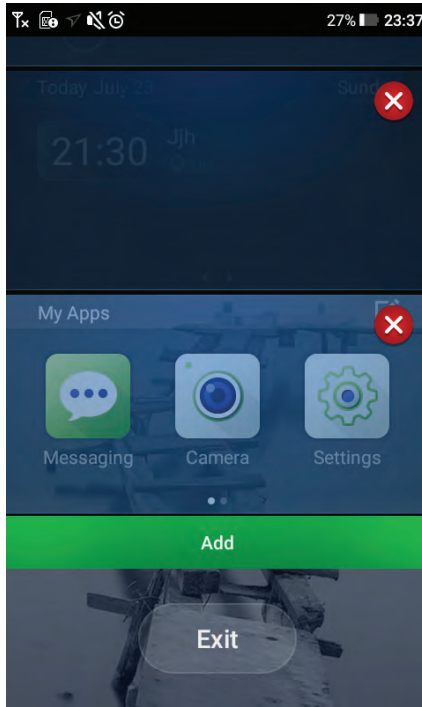

Deleting Widgets

1. Swipe down to the bottom of the Home screen, and tap **Edit**.
2. Tap **X** in the upper right corner of the widget, and then tap **OK**.

Repositioning Widgets

1. Swipe down to the bottom of the Home screen, and tap **Edit**.
2. Press and hold the widget until it is highlighted, drag it up or down to a new location.
3. Press the **Home** key.

4.7 Switching the Operation Mode

The radio can operate in NB & BB mode or NB mode. Upon power-on, the radio operates in NB & BB mode by default.

In NB & BB mode, both the top screen and main screen are on. The radio can access both private and public network services.

In NB mode, only the top screen is on. The radio accesses only private network services. The NB mode includes the following two types:

- Conventional mode: The radio communicates with one or more other radios directly on the fixed channel frequency or through repeaters.

- Trunking mode: The radio communicates with one or more other radios on the channel frequency allocated by the trunking system.

To switch the specific NB mode, go to **Settings>PMR>Work mode**, and then tap **Conventional** or **Trunking**.

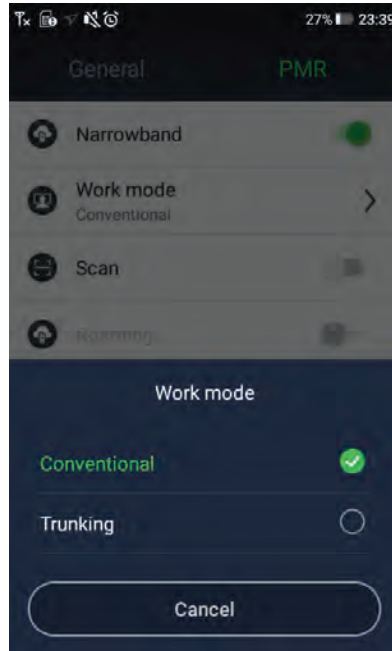

To switch to NB mode, do as follows:

1. Press and hold the **On-Off/End** key until the power-off selection screen appears.
2. Tap **AP Power Off**, and then tap **Sure**.

To switch back to NB & BB mode, do as follows:

1. Press and hold the **On-Off/End** key until the AP Power On selection screen appears.
2. Tap **AP Power On**.

 Note

The trunking mode must be authorized by your dealer.

4.8 Connecting to the Networks

4.8.1 Private Network

To allow the radio to access private network services, do either of the following:

- Swipe up from the bottom edge of any screen, and tap **Narrowband**.

- Go to **Settings > PMR > Narrowband**, and then turn it on.

4.8.2 Public Network

To allow the radio to access the public network services, do either of the following:

- Swipe up from the bottom edge of any screen, and tap **Data**.
- Go to **Settings > General > Mobile network**, and then turn it on.

Note

- Before accessing the public network services, ensure that you have installed the micro-SIM card properly.
- If the data services are not in use, tap to turn it off to decrease data usage and increase battery life.

For more details on public network setting, see [8.4.1 Mobile Network](#).

4.8.3 WLAN Network

The WLAN feature provides Internet access over WLAN network.

To connect to a WLAN network, do as follows:

1. Go to **Settings > General > Wireless & networks > WLAN**.
2. Check whether WLAN is on. If yes, go to the next step. If no, tap **Off** to turn it on.

When WLAN is turned on, the radio automatically scans for available networks and displays them.

3. Tap the network you want to connect to.

When you select an open network, the radio automatically connects to it. Otherwise, enter a password to connect.

For more details on WLAN network setting, see [8.4.2 WLAN](#).

4.8.4 Airplane Mode

You may be required to turn the radio off or make it enter the airplane mode when you are in an airplane or in any other area where making or receiving calls or accessing data is prohibited. In airplane mode, the radio cannot make or receive any calls or access online information or applications. If permitted by the cabin crew, you can turn on WLAN network or BT, or initiate NB services.

















To make the radio enter the airplane mode, do either of the following:

- Swipe up from the bottom edge of any screen, and tap **Airplane mode**.
- Go to Settings > General > Wireless & networks > Airplane mode, and then turn it on.











When airplane mode is on,  appears in the status bar at the top of the main screen.

5. Status Indications

5.1 LCD Icons

Type	Top Screen	Main Screen	Radio Status
Battery power			The battery is fully charged.
			The battery power is low.
Data network	/	G/E/3G/4G	A G /E/3G/4G cellular network is available.
	/		The radio is connected to the WLAN network.
Signal	/		The radio operates in Airplane mode.
	/		The number of bars indicates the signal strength of the BB network.
			The NB network is turned off.
			<ul style="list-style-type: none"> Conventional mode: The radio is in standby state. Trunking mode: The radio detects no signal.
			The number of bars indicates the signal strength of the NB network.
			The number of bars indicates the signal strength when the radio operates under a single site in trunking mode.
Call and data services		/	The digit indicates the number of missed calls.
			The digit indicates the number of unread short messages.
			An emergency call is in progress.
			The radio is transmitting on an analog channel.
			A private call is in progress over the NB network.
			Initiating/receiving a private call over the NB network.

Type	Top Screen	Main Screen	Radio Status
			Establishing a private call in trunking mode over the NB network.
			A group call is in progress over the NB network.
			Initiating/receiving a group call over the NB network.
			Establishing a group call in trunking mode over the NB network.
			An all call is in progress over the NB network.
			Initiating/receiving an all call over the NB network.
			Establishing an all call in trunking mode over the NB network.
			An encrypted private call is in progress over the NB network.
			An encrypted group call is in progress over the NB network.
			An encrypted all call is in progress over the NB network.
			A phone call is in progress over the BB network.
			Initiating/receiving a phone call over the BB network.
			A phone call has been established over the BB network.
NB network			The radio operates in low or high power mode.
			The radio is roaming.
			The radio is scanning.
			The radio stays on an active channel.
			The End-to-End Encryption (E2EE) feature is enabled.
			The Squelch Off feature is enabled.
			The Monitor feature is enabled.
BB network	/		No micro-SIM card is detected.

Type	Top Screen	Main Screen	Radio Status
	/		An error occurs to the micro-SD card.
	/		The radio is downloading.
	/		A hotspot is set up.
	/		The Recorder feature is enabled.
	/		The Alarm feature is enabled.
Accessory			An accessory is connected.
			The BT feature is enabled.
			A BT device is connected.
			The GPS feature is enabled, and the radio is receiving positioning data.
			The GPS feature is enabled, but the radio receives no positioning data.
Others			The radio operates in silent mode.

5.2 LED Indications

5.2.1 LED Indicator 1

LED Indicator	Radio Status
Flashes green	Being turned on.
Flashes green slowly	Standby in trunking mode.
Glowes green	Receiving.
Glowes red	<ul style="list-style-type: none"> ● Transmitting.
Flashes red	<ul style="list-style-type: none"> ● The radio in trunking mode is making a call. This indication is applicable only to the calling radio.

	<ul style="list-style-type: none"> ● The battery is low. Please recharge or replace the battery.
Flashes orange slowly	<ul style="list-style-type: none"> ● Conventional mode: Scanning or roaming ● Trunking mode: Registering
Flashes orange rapidly	<ul style="list-style-type: none"> ● Conventional mode: Operating in emergency mode. ● Trunking mode: Establishing a Full Off Air Call Set-Up (FOACSU) call. This indication is applicable only to the called radio.
Glow orange	Call hang time: No voice is being transmitted or received during a call. Within such a period, you can press and hold the PTT key to speak.

5.2.2 LED Indicator 2

LED Indicator	Radio Status
Flashes blue	A BT device is connected.
Flashes red	There is/are unread message(s) or missed call(s).

6. Call Services

You can initiate and receive various types of calls in different ways. Over the private network, you can initiate and receive NB calls including group calls, private calls, all calls, broadcast calls, and emergency calls. Over the public network, you can initiate and receive phone calls as you do on your mobile phone.

Note

When initiating an NB call by entering the target number, make sure that the number complies with the dial rule. For the detailed dial rule, please consult your dealer.

6.1 Group Calls

A group call is a call from an individual user to all the other members in the group over the private network.

6.1.1 Initiating Group Calls

You can make a group call through one of the following ways:

Preset Contact

1. Press the **Smart Knob**.
2. Do the following:
 - If you are in conventional mode, rotate the knob to select the channel associated with the required group contact.
 - If you are in trunking mode, rotate the knob to select the required group contact.
3. Press and hold the **PTT** key.

Manual Dialing

1. Tap .
2. Enter the required group number.
3. Select "PMR group call".
4. Press and hold the **PTT** key.

Contact list

1. Tap  > **Group**.
2. Tap a group contact.
3. Press and hold the **PTT** key.

6.1.2 Receiving and Responding to Group Calls

You can listen to a received group call without any operation.

To respond to the call, press and hold the **PTT** key or tap and hold the circle on the screen, and then speak into the microphone.

6.1.3 Ending or Exiting Group Calls

In conventional mode and trunking mode, a group call ends automatically when the call hang time expires.

In trunking mode, you can tap  or press the **On-Off/End** key to end an outgoing group call or exit an incoming group call. In addition, a group call also ends in any of the following cases:

- The preset total call time expires.
- A preemptive or emergency call interrupts the call.
- The base station signal is lost.
- You have switched to another contact during the call (in the case that the Clear Down Via Contact Switch feature is enabled by your dealer).

6.2 Private Calls and Phone Calls

A private call is a call initiated by one individual user to another over the private network. A phone call is a call initiated by one individual user to another over the public network.

6.2.1 Initiating Private Calls and Phone Calls

You can make a private call or phone call through one of the following ways:

Preset Contact

1. Press the **Smart Knob**.



2. Do the following:
 - If you are in conventional mode, rotate the knob to select the channel associated with the required private contact.
 - If you are in trunking mode, rotate the knob to select the required private contact.
3. Press and hold the **PTT** key.

Manual Dialing

To make a private call over the private network, do as follows:

1. Tap .
2. Enter a private contact number.
3. Press and hold the **PTT** key.

To make a phone call over the public network, do as follows:



1. Tap .
2. Enter a phone number.
3. Press  or press and hold the **PTT** key.

Contact List

To make a private call over the private network, do as follows:



1. Tap  > **Private**.
2. Tap a private contact.
3. Press and hold the **PTT** key.

To make a phone call over the public network, do as follows:



1. Tap  > **Private**.
2. Tap a phone number.
3. Tap .

Call Logs

To make a private call over the private network, do as follows:

1. Tap  or .
2. Tap **Call logs** at the bottom of the screen.
3. Tap **All** or **Missed** at the top of the screen, and then tap a private contact.
4. Press and hold the **PTT** key.

To make a phone call over the public network, do as follows:

1. Tap  or .
2. Tap **Call logs** at the bottom of the screen.
3. Tap **All** or **Missed** at the top of the screen, and then tap a phone contact.
4. Tap .

6.2.2 Receiving and Responding to Private Calls and Phone Calls

Private Call

In conventional mode, you can listen to a call without any operation.

In trunking mode, you can listen to a call in different ways varying with the setup mode of the call:

- FOACSU
The radio rings and vibrates to indicate the incoming call. You can press the **PTT** key or the **Back/Answer** key to answer the call.
- Off Air Call Set-Up (OACSU)
The call is established automatically. You can listen to it without any operation.

To respond to the call, press and hold the **PTT** key, and then speak into the microphone.

Phone Call

You can tap  or press **Back/Answer** key to answer a call.

6.2.3 Ending Private Calls and Phone Calls

Private Call

In conventional mode and trunking mode, a call ends automatically when the call hang time expires.

In trunking mode, you can also tap  or press the **On-Off/End** key to end a call. For other cases where a call ends, see [6.1.3 Ending or Exiting Group Calls](#).

Phone Call

To end a phone call, tap  or press the **On-Off/End** key.

6.3 All Calls

In conventional mode, an all call is a call from an individual user to all the other users on the current digital channel.

In trunking mode, an all call is a call from an individual user to all the other users in a specific base station, area, or system.

In an all call, only the calling party can speak.

Note

The All Call feature must be authorized by your dealer.

6.3.1 Initiating All Calls

You can make an all call through either of the following ways:

Preset Contact

1. Press the **Smart Knob**.
2. Rotate the knob to select an all call contact.
3. Press and hold the **PTT** key.

Manual Dialing

1. Tap .
2. Enter an all call number.
3. Press and hold the **PTT** key.

6.3.2 Receiving All Calls

You can listen to an all call without any operation.

6.3.3 Ending or Exiting All Calls

In conventional mode and trunking mode, an all call ends when the calling party releases the **PTT** key.

In trunking mode, as the call party, you can tap  or press the **On-Off/End** key to end an all call. In addition, an all call also ends in any of the following cases:

- The preset transmission time expires.
- The preset total call time expires.
- The base station signal is lost.
- You have switched to another contact during the call (in the case that the Clear Down Via Contact Switch feature is enabled by your dealer).

As the called party, you can press the **On-Off/End** key to exit an all call. If the Clear Down Via Contact Switch feature is enabled by your dealer, you can also exit the call by switching to another contact. You can rejoin the call later.

6.4 Broadcast Calls (Trunking Only)



A broadcast call is a special group call. In a broadcast call, only the calling party can speak.

 Note

The Broadcast Call feature must be authorized by your dealer.

6.4.1 Initiating Broadcast Calls

To initiate a broadcast call, do as follows:

1. Tap  > **Favorites/Group**.
2. Tap a group contact, and then tap .

6.4.2 Receiving Broadcast Calls

You can listen to a broadcast call without any operation.

6.4.3 Ending or Exiting Broadcast Calls

As the calling party, you can tap  or press the **On-Off/End** key to end a broadcast call.

A broadcast call also ends in any of the following cases:

- The preset total call time expires.
- The base station signal is lost.
- A preemptive or emergency call interrupts the call.
- You have switched to another contact during the call (in the case that the Clear Down Via Contact Switch feature is enabled by your dealer).

As the called party, you can press the **On-Off/End** key to exit a broadcast call. If the Clear Down Via Contact Switch feature is enabled by your dealer, you can also exit the call by switching to another contact. You can rejoin the call later.

6.5 Calls on Analog Channels

On analog channels, you can initiate calls to all the other users on the channels.

To initiate such a call, do as follows:

1. Press the **Smart Knob**, and then rotate it to select the required channel.
2. Press and hold the **PTT** key, and speak into the microphone.

You can listen to a call on analog channels without any operation.

6.6 Emergency Calls

An emergency call is a call initiated to ask for help in case of emergency.

6.6.1 Initiating Emergency Calls

To initiate an emergency call, press the programmed **Emergency On** key, then press and hold the **PTT** key to speak.

To set a programmable key as the shortcut to initiate an emergency call, go to **Settings > General > Programmable keys**.

Note

If the Alarm w/Call To Follow feature is enabled by your dealer, you can speak into the microphone without holding the **PTT** key.

6.6.2 Receiving Emergency Calls

You can listen to an emergency call without any operation.

6.6.3 Ending or Exiting Emergency Calls

Conventional Mode

As the calling party, you can end an emergency call. However, as the called party, you can only exit an emergency call. Do one of the following to end or exit an emergency call:

- Press the programmed **Emergency Off** key.
- Switch to trunking mode.
- Turn the NB network off.

In addition to the above ways, you can also exit an emergency call by switching to another channel.

Trunking Mode

As the calling party, you can end an emergency call through one of the following ways:

- Press the programmed **Emergency Off** key.
- Switch to conventional mode.
- Turn the NB network off.
- Switch to another contact during the call (in the case that the Clear Down Via Contact Switch feature is enabled by your dealer).

As the called party, you can only exit the emergency call. In addition to the above ways, you can also tap  or press the **On-Off/End** key to exit the emergency call. In the case of an emergency group or all call, you can rejoin the call later.



7. Message Services

The Message feature allows you to send and manage messages.



7.1 Viewing Messages

To view a message, tap , and then tap the required message.

7.2 Sending Messages

1. Tap , and then tap  in the lower right corner.
2. Tap the **To** text box to enter a recipient, or tap **+** to select a recipient from your Contacts.
3. Tap the **Type message** text box to enter the content.
4. (Optional) Tap **+** on the left for more operations.
 - **Quick reply texts:** Add and edit a quick reply text.
 - **Status messages:** Add and edit a status message (trunking mode).
 - **Photo:** Take or select a photo to attach (for phone contacts).
 - **Voice:** Record or select an audio to attach (for phone contacts).
 - **Video:** Record or select a video to attach (for phone contacts).
 - **Subject:** Convert a text message into a multimedia message (for phone contacts).
 - **Timed:** Schedule the message to be sent later automatically
 - **Contact:** Send the contact information.
 - **Emojis:** Select an emoji (for phone contacts).
5. Tap **→** to send the message.

7.3 Managing Messages

1. Tap , and then tap a message to be managed.
2. Tap and hold the message text until  appears.
3. In the managing interface, do one of following:

- To copy the message, tap **Copy text**.
- To forward the message, tap **Forward** and enter a new contact number or tap **+** to select a new contact.
- To delete the message, tap **Delete**.
- To add the message to the favorite list, tap **More > Favorite**.
Then you can view the favorite messages by tapping **Messaging > My favorites**.
- To view the message details such as message type and sending time, tap **More > View details**.

8. Supplementary Features

8.1 Basic Settings

You can go to **Settings > General** and then make the following settings:

If you want to...	Then...
Set SK2 , SK3 , and TK as shortcuts to radio features	Go to Device > Programmable keys > SK2/SK3/TK > Short press/Long press/Double-click , and then tap the required feature. See 8.2 Programmable Keys for details. Note: The double-press operation is applicable only to SK2 and SK3.
Set the language	Go to System > Language & input > Language , and then tap the required language.
Set the wallpaper	<ol style="list-style-type: none">1. Go to Device > Personalization > Wallpaper.2. Tap the required photo, and then tap confirm.
Adjust the brightness of backlight	Go to Device > Display > Main/Top , and then drag the brightness slider. Tap Auto-brightness to let the radio to automatically adjust the brightness. Tap Timed off to set the duration after which the screen will be turned off automatically.
Turn the LED indicator on or off	Go to Device > Display , and then tap LED .
Turn vibration on or off	Go to Device > Sounds , and then tap Vibrate on ring or Vibrate on silent .
Set the profile	Go to Device > Sounds > Profiles , and then tap Ring or Silent .
Set the ring, media, alarm, and call volume	Go to Device > Sounds > Volume , and then drag the corresponding slider.
Select tones for call, message and notification services	<ol style="list-style-type: none">1. Go to Device > Sounds > Sounds and vibrations.

If you want to...	Then...
	2. Tap the corresponding tone, and then set tap the required alert tone.
Turn system tone on or off	Go to Device > Sounds > System Tone , and then tap the required alert tone.
Clear cached data	Go to Device > Storage > Internal storage > Cached data , and then tap OK .
Set whether the main screen displays battery percentage in the status bar	Go to Device > Battery , and then tap Battery percentage .
Turn the glove mode on or off	Go to Device > Assistance , and then tap Glove mode . In this mode, the radio increases the touch screen sensitivity for your convenient operation when wearing a glove.
Set the date and time	Go to System > Date & time .

8.2 Programmable Keys

The radio has three programmable keys including **SK2**, **SK3**, and **TK**. When you assign a specific feature to one key, you can press, hold or double press this key to quickly activate the feature.

To make the settings, go to **Settings > General > Device > Programmable keys**.

The table below lists the assignable features.

Feature	Description
Camera	Opens the camera to take photos.
Emergency on	Initiates an emergency call.
Emergency call	

Emergency off	Ends or exits an emergency call.	
Cancel emergency call		
Encryption	Enables or disables the E2EE feature.	
Adjust power level	Switches the operating power between high and low.	
Video	Records a video.	
Audio path switch	Selects the audio mode. See 8.8 Audio Mode for details.	
Control Center	Accesses or closes the quick setting panel.	
Screenshot	Takes a screenshot.	
Zone up	Conventional mode	Switches to the previous zone.
Zone down		Switches to the next zone.
Squelch on		Enables or disables the Squelch On feature for the current analog channel. See 8.12.2 Turning the Squelch On Feature On or Off for details.
Monitor		Enables or disables the Monitor feature for the current analog channel. See 8.12.1 Turning the Monitor Feature On or Off for details.
Nuisance delete		Removes the current channel from the scan list. See 8.9.1 Scan in Conventional Mode for details.
Subgroup up		Trunking mode
Subgroup down	Switches to the next subgroup.	
Background hunt	Enables or disables the Background Hunt feature. See 8.9.2 Scan in Trunking Mode for details.	
Handover	Enables or disables the Handover feature. See 8.9.2 Scan in Trunking Mode for details.	
Manual scan	Enables the Scan feature. See 8.9.2 Scan in Trunking Mode	

		for details.
--	--	--------------

8.3 Contact Management



The Contact feature allows you to manage contacts.

 Note

Only phone contact and private contact can be edited, deleted or added.

8.3.1 Adding Private Contacts

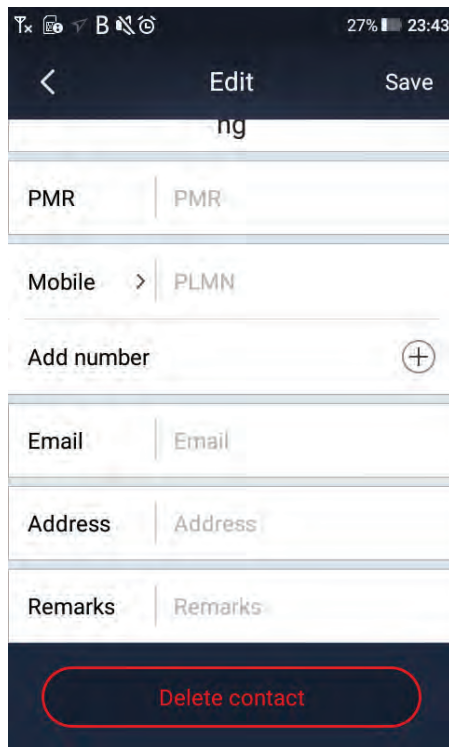

To add a private contact, do as follows:

1. Tap  > Private > .
2. Tap  and assign a photo to the contact by choosing one the following options:
 - **Take photo:** use the camera to take a photo.
 - **Choose photo:** choose a photo from the Gallery.
3. Tap the **Name** text box, and enter the contact name.
4. Tap the **PMR** text box, and enter the Private Mobile Radio (PMR) number of the contact.
5. Tap **>**, and then tap the required type of phone number.
6. Tap the **Mobile** text box and enter the phone number.
7. (Optional) Tap **Add number** to add another phone number.
8. Tap the **Email**, **Address**, and **Remarks** text boxes and enter the related information.
9. Tap **Save** in the upper right corner.



8.3.2 Adding Contacts to Favorites

To add frequently used contacts to the **Favorites** list, do as follows:

1. Tap  > Favorites > .
2. Tap the required contacts, and then tap **OK**.



8.3.3 Deleting Private Contacts

1. Tap , and then tap **Private**.
2. Tap **Edit** in the upper right corner.
3. Swipe up to the bottom, and then tap **Delete contact**.
4. Tap **OK**.

8.3.4 Managing Zones

In conventional mode, the radio receives and transmits data and voice on the selected channel. A zone is a group of channels within the same operational area.

To switch the current channel, do as follows:

1. Tap , and then tap **Manage** in the upper right corner.
2. Tap the required zone, and then tap  on the right of the required channel.



To edit a channel, do as follows:

3. Tap , and tap **Manage** in the upper right corner.
4. Tap the required channel, and then tap **Edit** in the upper right corner.
5. On the editing interface, make the related settings as required.
6. Tap **Save**.

8.3.5 Managing Subgroups

In trunking mode, a subgroup consists of several contacts.

To switch the current contact, do as follows:

1. Tap , and then tap **Manage** in the upper right corner.
2. Tap the required subgroup, and then tap  on the right of the required contact.

To edit a private contact, do as follows:

1. Tap , and tap **Manage** in the upper right corner.
2. Tap the required contact, and then tap **Edit** in the upper right corner.
3. On the editing interface, make the related settings as required.
4. Tap **Save**.

8.4 Wireless and Network

8.4.1 Mobile Network

Setting the Mobile Network

Go to **Settings > General > Mobile network**, and make the following settings:

- To set the preferred network type, tap **Network > Preferred network type > 4G/3G/2G**.
- To use LTE services to improve voice and other communications, tap **Network > Enhanced 4G LTE Mode**, and then turn it on.
- To connect to data services when roaming, tap **Network > Data roaming**, and then turn it on.

Managing the Data Usage

You may pay additional charges if the data usage exceeds the cellular data plan. To avoid additional charges, you can set a data plan by tapping **Cellular data > Data limit**. The cellular data will be turned off automatically once the data usage reaches the limit you set.

You can tap **Data usage** to check the data usage for each app.

8.4.2 WLAN

To set the WLAN, go to **Settings > General > WLAN**, tap  in the upper right corner of the screen, and do the following operations:

Adding WLAN Networks

To add a WLAN network not displayed on the available network list, do as follows:

1. Tap **Add network**.
2. Set the parameters as required.
3. Tap **Save**.

Advanced WLAN Settings

You can tap **Advanced** to make the following advanced settings:

- To receive notification when a public network is available, tap **Network notification** to turn it on.
- To transfer files to a nearby device directly through WLAN connection, tap **WLAN Direct > Peer devices**, and then tap the required device.
- To connect to WLAN network using WLAN Protected Setup (WPS), do either of the following:
 - Tap **WPS Push Button**, and then press the WLAN Protected Setup button on your router.
 - Tap **WPS Pin Entry** to enter the pin code displayed on the screen on your router.

8.4.3 BT

The BT feature allows the radio to exchange data with another BT-enable device over short distances.

To pair the radio with another BT device, do as follows:

1. Go to **Settings > General > Wireless & networks > BT**.

2. Check whether BT is on.
 - If yes, go to the next step.
 - If no, tap **Off** to turn it on.
3. Tap the name of the target device.

After successful pairing and connection, the radio can exchange information (e.g., files, photos, and videos) with other BT-enabled devices.

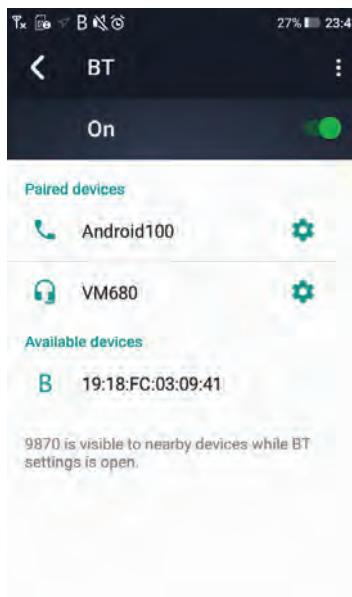

8.4.4 Tethering and Portable Hotspot

The Personal Hotspot feature allows you to share the radio's data connection with nearby devices.

Setting up a Portable Hotspot

To set up a hotspot, do as follows:

1. Go to **Settings > General > Wireless & networks > Tethering & portable hotspot**.
2. Tap **Portable WLAN hotspot** to turn it on.
3. Tap **Set up WLAN hotspot**, and enter the related information.
4. Tap **Save**.

Using BT Tethering

BT Tethering allows the radio to share data connection with nearby devices through BT.

To turn the BT tethering feature on or off, go to **Settings > General > Wireless & networks > Tethering & portable hotspot**, and tap **BT tethering**.

8.4.5 NFC

The Near Field Communication (NFC) feature allows the radio to recognize nearby NFC-capable devices.

To turn NFC on or off, go to **Settings > General > Wireless & networks > More**, and then tap **NFC**.

8.4.6 VPN

A virtual private network (VPN) extends a private network across a public network. Applications running across the VPN may benefit from the functionality, security, and management of the private network.

To set up a VPN, do as follows:

1. Go to **Settings > General > Wireless & networks > More > VPN**, and then tap **VPN** to turn it on.
2. Tap **VPN settings**.
3. Tap **+** to edit and save VPN profile.
4. Tap the configured VPN, enter the username and password, and then tap **Connect**.

Note

- Set a screen lock (pattern or password) before editing VPN profile.
 - Consult your dealer for detailed configurations.
-

8.5 Applications









On the apps panel, you can use embedded apps as you do on your mobile phone. To open an app, tap the related app icon. Besides embedded apps, you can also download and install more apps using APP Store. For details, see [8.5.9 App Store](#).

8.5.1 Camera

The app allows you to take photos and record videos. To switch between taking photos and recording videos, swipe left or right on the screen or double press the **Smart Key** after opening the camera.

Taking Photos





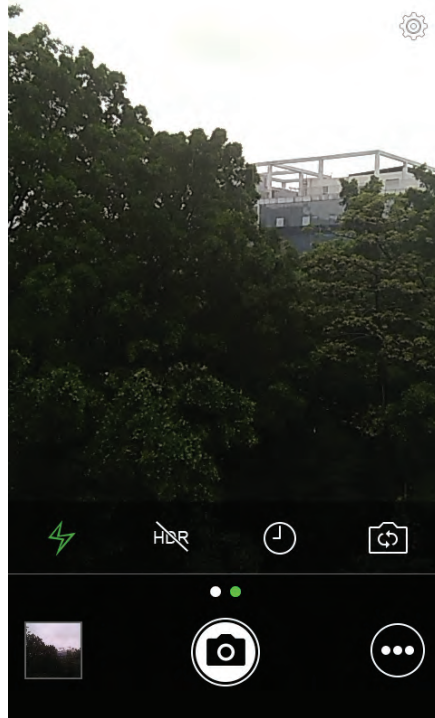





To take a photo, do as follows:

1. Tap .
2. Swipe left or right to the tab with .
3. Tap  to do the following basic settings:
 -  : Turn the flash on or off, or allows the camera to turn the flash on automatically depending on the ambient light.
 - HDR: High Dynamic Range helps you get a brighter and richer photo.
 -  : Take time-delayed photos
 -  : Switch between the front-facing and rear-facing camera.
4. Tap  in the upper right corner to do other settings, such as resolution, watermark, and face detection.
5. Aim the camera at the subject, and pinch the screen to zoom out or spread the screen to zoom in if required.
6. Tap  or press the **Smart Key**.
7. Tap the thumbnail in the lower left corner to view the full photo you have taken.
8. Press the **Back/Answer** key to switch back to photo taking.



Recording Videos

To record a video, do as follows:



1. Tap .
2. Swipe left or right to the tab with .
3. Tap  to do the following basic settings:
 -  : Turn the flash on or off.
 -  : Switch between the front-facing and rear-facing camera.
4. Tap  in the upper right corner to do other settings, such as resolution and watermark.
5. Aim the camera at the subject, and pinch the screen to zoom out or spread the screen to zoom in if required.
6. Tap  or press the **Smart Key** to start recording.
7. (Optional) Tap  to pause, and then tap  to continue.
8. (Optional) Tap  to take a photo.
9. Tap  or press the **Smart Key** to stop recording.
10. Tap the thumbnail in the lower left corner to view the video you have shot.
11. Press the **Back/Answer** key to switch back to video recording.

8.5.2 Gallery

The app allows you to manage photos and videos.

Viewing Photos and Watching Videos





To view a photo or watch a video, do as follows:

1. Tap .
2. Tap , and then tap one of the following options to select the view mode:
 - **All:** View photos and videos organized by date.
 - **Albums:** View photos and videos organized by album.
3. Depending on the view mode, either tap a photo or video to view it, or first tap an album or folder and then tap a photo or video.
4. (Optional) Swipe left or right to view the next or previous photo or video.

While viewing a photo, you can tap the screen, and then tap **More** to do the following operations:

- **To Folder:** Move the photo into an existing or a new folder.
- **Set picture as:** Set the photo as a contact photo or the wallpaper.
- **Slideshow:** Start a slideshow with the photos and videos in the current folder.
- **Details:** View information about the photo, including the title, time, and other properties.

While watching a video, you can tap the screen, and then do the following operations:

- Tap  to watch the videos in the current folder one by one.
- Tap  to watch the current video repeatedly.
- Tap  to pause.
- Tap  to watch the video in full screen.

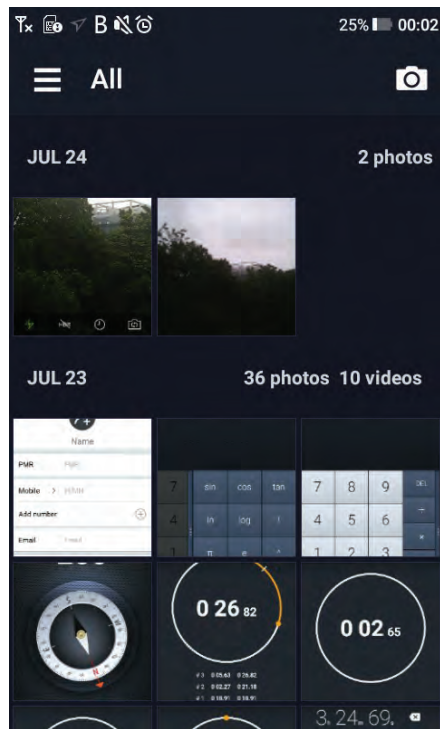

Zooming In and Out

To zoom in or out a photo, do one of the following:

- Double-tap anywhere on the screen.
- Spread two fingers apart on any place to zoom in, and pinch the screen to zoom out.

Sharing Photos and Videos

To share a photo or a video, tap **Share** while viewing it, and then tap the required tools such as BT and Messaging.

To share all photos and videos in a folder, do as follows:

1. Tap **≡**, and then tap **Albums**.
2. Touch and press the folder to be shared until it is selected.
3. Tap **Share**, and then tap the required tools such as BT.

Deleting Photos and Videos

To delete a photo or a video, tap **Delete** while viewing it.

To delete all photos and videos in a folder, do as follows:

1. Tap **≡**, and then tap **Albums**.
2. Touch and press the folder to be deleted until it is selected.

3. Tap **Delete**, and then tap **OK**.

8.5.3 Clock



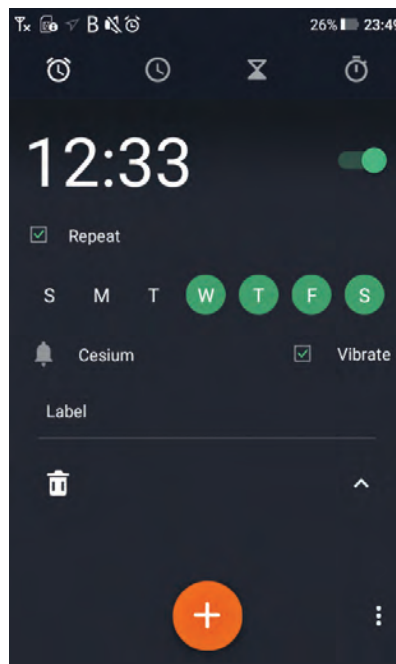

The app allows you to use the alarm, view the world clock, set a stopwatch, and use a timer.

Using the Alarm

The Alarm feature allows you to set an alarm to alert yourself at specified time.



To create an alarm, do as follows:

1. Tap .
2. At the top of the screen, tap .
3. Tap , and then drag the pointer to set the time for the alarm to sound.
4. Tap **OK**, and then tap the following items to set the alarm:
 - **Repeat**: Tap the days on which you want the alarm to ring.
 - : Set the alarm tone.
 - **Vibrate**: Enable or disable alarm vibration.
 - **Label**: Add a label for the alarm.
5. Tap  > **Settings** to set the following options:
 - **Silence after**: Set the period after which the alarm stops ringing.

- **Snooze length:** Set the period after which the alarm rings again.
- **Volume switch buttons:** Set the function of the **Smart Knob** when the alarm sounds. The following three options are available:
- **Snooze:** Let the alarm ring again after the period set in Snooze length expires.
- **Dismiss:** Let the alarm stop ringing immediately.
- **Do nothing:** Rotating the knob does not affect the alarm at all.
- **Start week on:** Set the beginning day of the week. The following three options are available: **Saturday, Sunday, and Monday.**



When the alarm sounds, swipe left to temporarily stop the sounds or swipe right to dismiss the alarm.

To delete an alarm, tap , and then tap . If you want to cancel the deletion, tap **UNDO**.

Using the World Clock

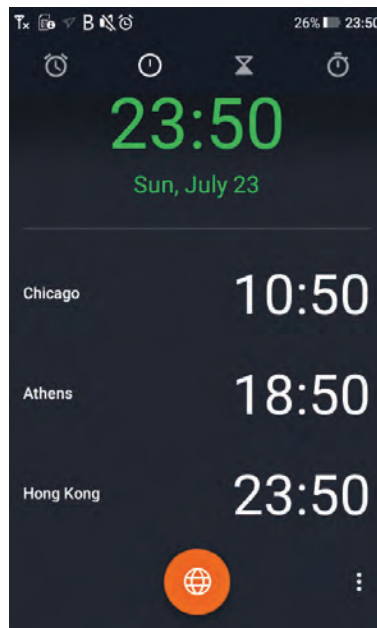
The World Clock feature displays the time for various cities around the world.





- To access the world clock, open the Clock app, and then tap .
- To list a city on the world clock screen, tap , and then tap the city to select it.
- To remove a city from the list, tap , and then tap the city to deselect it.

Using the Timer

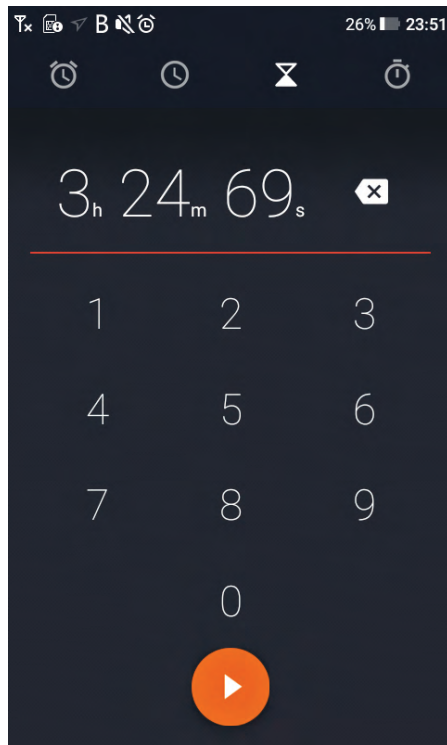

The Timer feature allows you to count down to a particular event based on a preset interval.



To use a timer, do as follows:

1. Tap .
2. At the top of the screen, tap .
3. Tap the digits on the screen to set the length.
4. Tap  to start the timer.

After the timer starts, you can do the following operations:

- Tap  to pause the timer.
- Tap  to delete the timer.
- Tap  to add another timer.





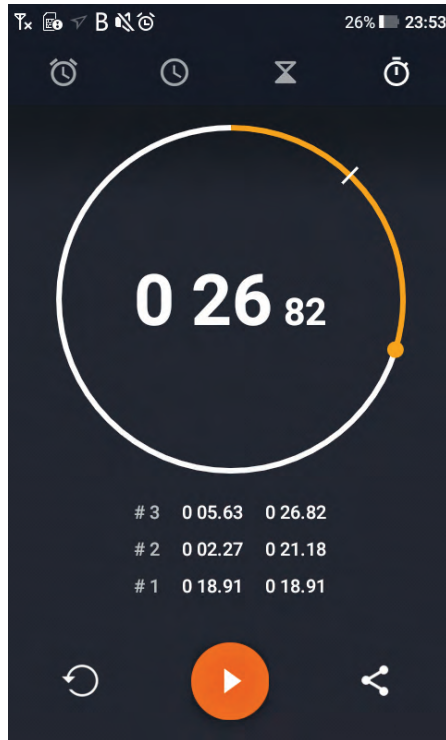

If you create more than one timers, swipe up or down to view them.

Using the Stopwatch

The stopwatch feature allows you to measure intervals of time.



To use the stopwatch, do as follows:

1. Tap .
2. At the top of the screen, tap .
3. Tap  to begin timing.
4. (Optional) Tap  to measure another interval of time.
5. Tap  to stop timing.
6. View the timing result on the screen, or tap  to share the result.
7. Click  to reset the stopwatch.

8.5.4 Calendar

The app allows you to view the calendar by day, week, or month, and manage your important events.

Viewing the Calendar

To set the calendar view, do as follows:

1. Tap .
2. Tap the date in the upper left corner of the screen to select the view options:
 - **Day:** Display the day view.
 - **Week:** Display the week view.

- **Month:** Display the month view.
- **Agenda:** Display the all tasks.

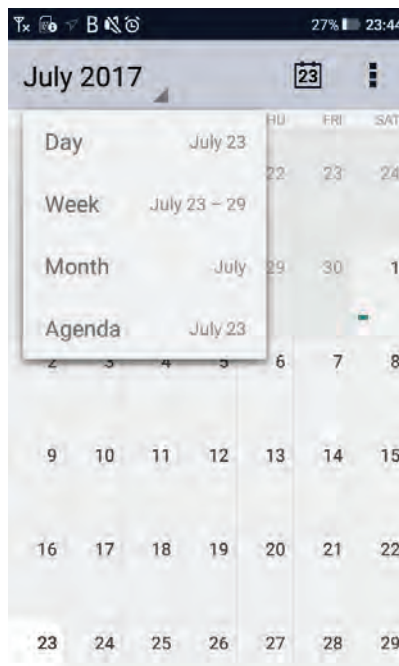

Setting the Calendar

To set the calendar, do as follows:

1. Tap **☰** > **Settings** > **General settings**.
2. Set the related options following on-screen instructions.

Creating an Event

To create an event on the calendar, do as follows:

1. Tap **☰** > **New event**.
2. Set the parameters as required.
3. Tap **Done** in the upper right corner.







Deleting an Event

To delete an event from the calendar, do as follows:

1. Tap **☰** > **Delete events**.
2. Tap the event to be deleted.
3. Tap **🗑**, and then tap **OK**.

8.5.5 Browser

The app allows you to browse the web.

- To set the browser, tap  > **Settings**, and set the parameters following on-screen instructions.
- To access a web site, tap the address bar, enter the web address, and then tap **Go** on the on-screen keypad.
- To open a new tab, tap  > **+**, and enter the new web address.
- To close a tab, tap , swipe up or down to view the tab, and then tap .
- To bookmark the current web page, tap  > **Save to bookmarks**.
- To view bookmarks, tap  > **Bookmarks**.

8.5.6 Calculator

The Calculator app facilitates basic and advanced arithmetic calculations.

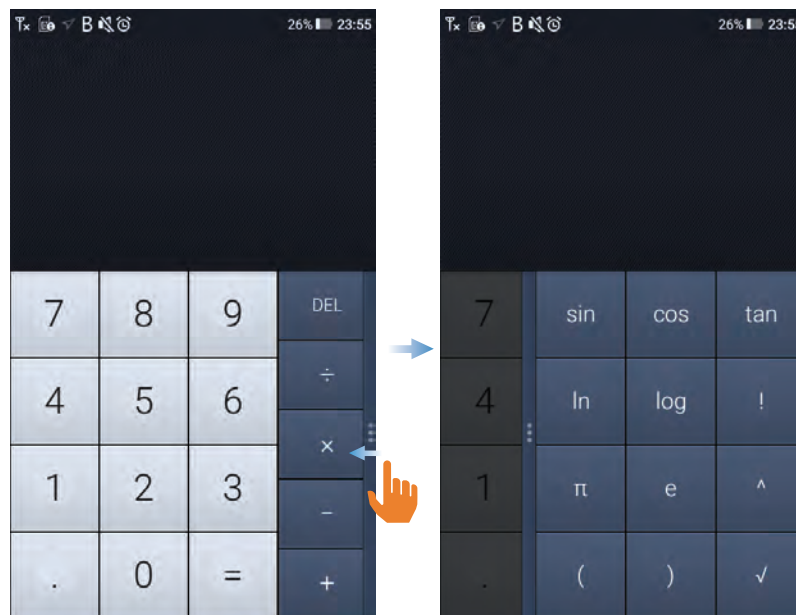

To perform basic arithmetic calculations, do as follows:

1. Tap .
2. Enter the first number using the on-screen numeric keypad.
3. Tap the appropriate arithmetic function key.
4. Enter the next number.

5. Tap the equal sign to view the result.

To perform advanced arithmetic operations, swipe left from the edge of the calculator screen.

8.5.7 Compass

The app shows you a direction, latitude, longitude, and altitude.

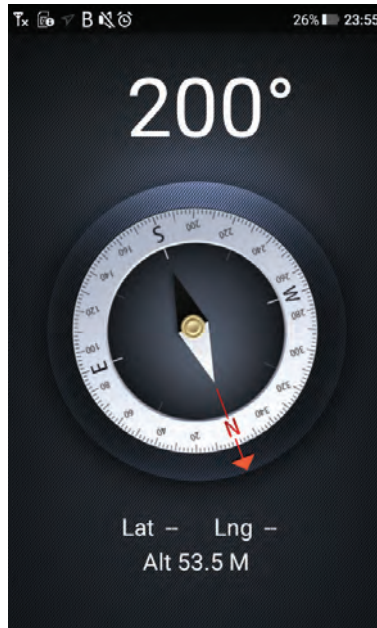

To use the compass, do as follows:

1. Tap .
2. Hold the radio flat in your palm.
3. Follow the on-screen instructions when prompted to calibrate.
4. View the information on the compass screen.





8.5.8 Recorder

The app allows you to record the voice and manage the audio files.



Recording Audio Files

To record an audio file, do as follows:

1. Tap .
2. Tap , and then speak into the microphone.
During recording, tap  to pause, and then tap  to continue.
3. Tap  to stop recording.

Playing Audio Files

To listen to an audio file, tap , and then tap the required audio file.







Managing Audio Files

Tap , and then tap and hold the required file until  appears.

- To share the file, tap **Share** and select the required tools or applications to share the file.
- To rename the file, tap **Rename**, enter a new name and tap **Confirm**.
- To delete the file, tap **Delete > OK**.





8.5.9 App Store

The App Store allows you to download apps to your radio.

- To view app messages, tap .
- To view apps, tap , tap **CAT** in the upper left corner, and then tap **All**, **Top charts**, or **Latest** as required.
- To search an app, tap  > , and enter the keyword.
- To manage downloaded apps, tap  to do the following operations:
- To open the app directly after downloading and installation, tap .
- To uninstall the app, tap  > **OK**.
- To update the app, tap **Update** in the upper right corner.

8.5.10 File Manager

The File Manger allows you to view, download, and manage notices sent by the mobile device management (MDM) server.

- To view app messages, tap .
- To view latest notices, tap **Flies**.
- To download the attachments, tap the required attachment and tap .
- To search a notice, tap , and enter the keyword.
- To manage downloaded apps, tap  to do the following operations:
- To open the attachment, tap **Open**.
- To delete the attachment, select it and tap  in the upper right corner, and tap **OK**.

8.6 App Manager

App Manager allows you to manage apps downloaded and installed in the radio.

Go to **Settings > General > System > App management**, and tap **App manager**:

- To forcibly stop a running app, tap **Running**, select the required app, and then tap **Force stop**.
- To uninstall an app, tap **Download** or **All**, select the required app, and then tap **Uninstall**.
- To manage the authorization granted to an app for accessing other apps or your radio information, tap **Download** or **All**, select the required app, and then tap **Control**.

8.7 Power Level

The radio can operate at either of the following power levels:

- **High Power:** Enables communication with radios far away from you but consumes more battery power.
- **Low Power:** Enables communication with radios close to you and saves battery power.

In trunking mode, to set the power level, go to **Settings > General > PMR > Power level**, and then tap **Low** or **High**.

In conventional mode, to set the power level for a channel, do as follows:

1. Go to **Contacts > Manage**.
2. Tap the channel.
3. Tap **Edit** in the upper right corner.
4. Tap **TX power > High / Low**.
5. Tap **Save** in the upper right corner.

8.8 Audio Mode

The radio applies internal speaker and receiver as well as external wired or wireless audio devices to process audio. If multiple audio devices are available, you can press the programmed **Audio path switch** key or tap the on-screen icons to set the audio mode during a call.

The table below describes the priority in which the radio sets the audio mode depending on the device availability.

Call Type	Wireless Audio Device	Wired Audio Device	Priority
Full duplex call	√	×	Wireless/Wired audio device > Receiver > Speaker
	×	√	
	×	×	Receiver>Speaker
	√	√	Wireless audio device > Wired audio device > Receiver > Speaker

Call Type	Wireless Audio Device	Wired Audio Device	Priority
Half duplex call	√	×	Wireless/Wired audio device > Speaker
	×	√	
	×	×	Speaker
	√	√	Wireless audio device > Wired audio device > Speaker

 Note

If both wireless and wired audio devices are available, the later connected one takes priority.

8.9 Scan

8.9.1 Scanning in Conventional Mode

In conventional mode, the Scan feature allows you to listen to activities on other channels, keeping track of your team members. With this feature enabled, the radio searches the scan list preset for the current channel and remains on the active channel.

To turn the Scan feature on or off, go to **Settings > PMR**, and then tap **Scan**.

To select a scan list for a channel, do as follows:

1. Go to **Contacts > Manage**, and then tap the target channel.
2. Tap **Edit** in the upper right corner.
3. Tap **Scan list**, and then tap the required scan list.
4. Tap **OK**.
5. Tap **Save** in the upper right corner.

8.9.2 Scanning in Trunking Mode

In trunking mode, the radio must register with a base station (BS) for normal operation. The Scan feature allows the radio to do the followings:

- Hunt through the Trunked Station Control Channels (TSCCs) for an available BS for registration.

- Always work under a BS with a higher RSSI value after registration to ensure smooth communication.

Turning the Background Hunt Feature On or Off

The Background Hunt feature allows the radio in standby mode to keep detecting the signal strength of the current BS. If the signal strength drops below the preset threshold, the radio switches to another BS with higher signal strength.

To turn this feature on or off, go to **Settings > PMR > Scan > Handover**, and then tap **Background hunt**.

Turning the Handover Feature On or Off

The Handover feature allows the radio to automatically switch to another BS with higher signal strength if the signal strength of the current BS drops below the preset threshold during a call. This prevents dropouts or discontinuous voice caused by low signal strength.

To turn this feature on or off, go to **Settings > PMR > Scan > Handover**, and then tap **Handover**.

8.10 Roam

The Roam feature allows you to enjoy seamless communication across sites or networks.

In conventional mode, you can turn this feature on or off as follows: go to **Settings > PMR**, and then tap **Roaming**.

To select a roam list for a channel, do as follows:

1. Go to **Contacts > Manage**, and then tap the target channel.
2. Tap **Edit** in the upper right corner.
3. Tap **Roam list**, and then tap the required roam list.
4. Tap **OK**.
5. Tap **Save** in the upper right corner.

Note

- The Scan and Roam feature cannot be enabled for the same digital channel simultaneously.
 - The roam list setting is not applicable to a direct channel.
-

In trunking mode, this feature needs to be turned on or off by your dealer.

8.11 Position

The Position feature provides location information.

To turn this feature on or off, go to **Settings > General > Privacy & Security > Security > Location**, and then tap **GPS**.

To view your location information, go to **Settings > General > Privacy & Security > Security > Location > Location Service**.

8.12 Analog Services

The following features are available only on analog channels in conventional mode.

8.12.1 Turning the Monitor Feature On or Off

The Monitor feature allows the radio to receive weak signals.

To turn this feature on or off, press the preset **Monitor** key.

8.12.2 Turning the Squelch On Feature On or Off

The Squelch On feature allows the radio's speaker to keep turned on no matter whether the squelch condition is satisfied.

To turn this feature on or off, press the preset **Squelch On** key.

8.12.3 Setting the Squelch Level

The squelch level refers to the squelch threshold required for the radio's speaker to be turned on.

To set the squelch level for a channel, do as follows:

1. Go to **Contacts > Manage**, and then tap the target channel.
2. Tap Squelch level, and then tap **Open**, **Normal**, or **Tight** (from low to high) as required.

Generally, a higher squelch level requires a higher RSSI value. If the squelch level is set to **Open**, the speaker will always keep turned on.

8.13 Encryption

The Encryption feature prevents eavesdropping on calls and interception of data.

To turn this feature on or off, do one of the following:

- Swipe up from the bottom edge of any screen to access the quick setting panel, and tap **Encryption**.
- Go to Settings > PMR, and then tap Encryption.

Note

In conventional mode, when you turn on the Encryption feature, voice and data on the current channel are encrypted. The Encryption feature will be turned on automatically whenever you switch back to this channel.

8.14 Stun

In trunking mode, when the radio is stunned, the  icon appears on both the top and main screens. In this case, the radio provides all functions except call or message services.

To restore normal operation, request your dealer to reprogram the radio or send a revive command. For details, contact your dealer.

This feature needs to be turned on or off by your dealer.

8.15 Kill

In trunking mode, when the radio is killed, the  icon appears on both the top and main screens. In this case, the radio is incapable of any function.

To restore normal operation, request your dealer to burn the radio firmware. For details, contact your dealer.

This feature needs to be turned on or off by your dealer.

8.16 System Upgrade

Caution

Before upgrading, ensure that the battery power is more than 30%. Power outage during upgrade may cause radio failure.

The radio receives a upgrade notification from MDM server when the latest software version becomes available.

To upgrade the radio, do as follows:

1. Swipe up from the bottom edge of any screen, and tap **Data** or .
2. Tap **Settings > General > System upgrade** to upgrade the broadband system or narrowband system.

The radio restarts automatically when the upgrade is complete.

 Note

- It is recommended that you use a WLAN connection to download the software.
 - Do not operate the radio during upgrade.
-

9. Troubleshooting

Phenomena	Analysis	Solution
The radio cannot be turned on.	The battery may be installed improperly.	Remove and reattach the battery.
	The battery power may run out.	Recharge or replace the battery.
	The battery may suffer from poor contact caused by dirtied or damaged battery contacts.	Clean the battery contacts or replace the battery.
The touch screen fails to respond to any taps quickly.	Too many apps are running.	Forcibly stop some running apps or restart the radio.
The keys do not work normally.	The keypad may fail to function temporarily.	Restart the radio.
The LCD does not display any information.	The LCD may fail to function temporarily.	Restart the radio.
The touch screen fails to be unlocked.	The unlock pattern or password is incorrect.	Contact your dealer or Hytera technician to reset the unlock pattern or password remotely.
The radio cannot register.	The radio may not detect signals from the BS.	Make sure the radio is within the coverage of the BS.
	The radio may not be authorised.	Contact the BS manager to check if the radio is authorised in the network management system.
The radio registers repeatedly.	The signal may be intermittent.	Make sure the radio is within the coverage of the BS.
The radio cannot	The signal may be weak.	Make sure the radio is within the

Phenomena	Analysis	Solution
establish a call.		coverage of the BS.
You cannot hear any voices after the call is established.	The called radio ID is not unique.	Contact the BS manager to check if the called radio ID is unique.
The called party disconnects repeatedly during communication.	The signal may be intermittent or weak.	Make sure the radio is within the coverage of the BS.
The voice is unclear.	The signal may be weak.	Make sure call participants are within the communication range.
During receiving, the voice is weak, discontinuous or totally inactive.	The battery voltage may be low.	Recharge or replace the battery.
	The volume level may be low.	Increase the volume or contact your dealer to turn the Mic AGC feature off.
	The antenna may be loose or may be installed incorrectly.	Turn the radio off, and then remove and reattach the antenna.
	The speaker may be blocked.	Clean the surface of the speaker.
You cannot communicate with group members.	The frequency or signaling type may be inconsistent with that of other members.	Verify your TX/RX frequency and signaling type are correct.
	The channel type (digital or analog) may be set incorrectly.	Verify you are on the correct digital or analog channel.
	You may be too far away from other members.	Move towards other members.
	The signal may be weak.	Make sure all members are within the communication range.
You hear unknown voices or noise.	You may be interrupted by radios using the same frequency.	Change the frequency, or adjust the squelch level.

Phenomena	Analysis	Solution
	The radio in analog mode may be set with no signaling.	Set signaling for all radios operating at the same frequency to avoid interference.
You are unable to hear anyone because of too much noise and hiss.	The signal may be weak.	Make sure call participants are within the communication range.
	You may be located in an unfavorable position. For example, your communication may be blocked by high buildings or blocked in an underground area.	Move to an open and flat area, restart the radio, and try contacting again.
	It could be the result of external disturbance (such as electromagnetic interference).	Stay away from equipment that may cause interference.
The GPS cannot locate your position.	GPS signals may not be received due to unfavorable position.	Move to an open and flat area, and try again.
The camera does not work.	The radio does not detect the front-facing or rear-facing camera.	Restart the radio.
	The storage space is not sufficient.	Clear up the storage space.
The radio fails to detect the micro-SIM card or micro-SD card.	The micro-SIM card or micro-SD card may be installed improperly	Remove and reattach the micro-SIM card or micro-SD card.
	The micro-SIM card or micro-SD card may suffer from poor contact caused by dirtied or damaged metal contacts.	Clean the metal contacts.
You cannot use the data connection.	The micro-SIM card fails to function properly or is out of service because of unpaid charges.	Make sure micro-SIM card functions properly or pay the charges.
	The data connection feature is not	Contact the carrier to enable the

Phenomena	Analysis	Solution
	enabled for the micro-SIM card.	data connection feature.
	The data signal may be weak.	Make sure the radio is within the network coverage.
	Both Data and WLAN are turned on, but the WLAN connection is unstable.	Turn WLAN off.
The battery fails to be charged.	The battery may be placed into the charger improperly.	Remove and reinsert the battery.
	The power adapter plug may be inserted into the socket improperly.	Remove and reinsert the plug.

If the above solutions cannot fix your problems, or you may have some other queries, please contact your local dealer for more technical support.

10. Care and Cleaning

To guarantee optimal performance as well as a long service life of the product, please follow these tips.

Product Care

- Do not pierce or scrape the product.
- Keep the product far away from substances that can corrode the circuitry.
- Do not hold the product by the antenna or earpiece cable.
- Close the accessory connector cover when no accessory is in use.

Product Cleaning

 Caution

Turn the product off and remove the battery before cleaning.

- Clean up the dust and fine particles on the product surface and charging piece with a clean and dry lint-free cloth or a brush regularly.
- Use neutral cleanser and a non-woven fabric to clean the keys, knobs, and front case after long-time use. Do not use chemical preparations such as stain removers, alcohol, sprays or oil preparations, so as to avoid surface case damage.
- If the radio is used in a harsh environment (such as sea and salt fog), periodically clean and dry the radio.
- Make sure the product is completely dry before use.

11. Optional Accessories

Contact your local dealer for the optional accessories used with the product.

Caution

Use the approved accessories only. We will not be liable for any loss or damage arising out of the use of any unauthorised accessories.

12. Abbreviations

Abbreviations	Full Names
F	
FOACSU	Full Off Air Call Set-Up
G	
GPS	Global Positioning System
H	
HDR	High-Dynamic Range
I	
ISO	International Standardization Organization
L	
LCD	Liquid-Crystal Display
LED	Light-Emitting Diode
M	
MDM	Mobile Device Management
N	
NFC	Near Field Communication
O	
OACSU	Off Air Call Set-Up
P	
PTT	Push-To-Talk
S	
SK	Side Key

Abbreviations	Full Names
T	
TK	Top Key
V	
VoLTE	Voice over LTE
VPN	Virtual Private Network
W	
WLAN	Wireless Local Area Networks
WPS	WLAN Protected Setup



is the trademark or registered trademark of Hytera Communications Corporation Limited.

© 2017 Hytera Communications Corporation Limited. All Rights Reserved.

Address: Hytera Tower, Hi-Tech Industrial Park North, 9108# Beihuan Road, Nanshan District,
Shenzhen, People's Republic of China

Postcode: 518057

[http:// www.hytera.com](http://www.hytera.com)