

Preface



Thanks for your favor in our product. This manual provides guidance for you to quickly know how to use the product. For detailed features and operations, see the *DMR Conventional Radio Feature Description and Operation Manual* along with the product.

To avoid bodily injury or property loss caused by misoperations, please carefully read the *Safety Information Booklet* before using the product.

This manual is applicable to the following product:

PD98Xi Digital Portable Radio (X may represent 2, 5, 6 or 8)

Icon Conventions

- : indicates features that are available in digital mode only.
- : indicates features that are available in analog mode only.

Features with no icon marked are available in both analog mode and digital mode.

Copyright Information

Hytera is the trademark or registered trademark of Hytera Communications Corporation Limited (the Company) in PRC and/or other countries or areas. The Company retains the ownership of its trademarks and product names. All other trademarks and/or product names that may be used in this manual are properties of their respective owners.

The product described in this manual may include the Company's computer programs stored in memory or other media. Laws in PRC and/or other countries or areas protect the exclusive rights of the Company with respect to its computer programs. The purchase of this product shall not be deemed to grant, either directly or by implication, any rights to the purchaser regarding the Company's computer programs. Any of the Company's computer programs may not be copied, modified, distributed, decompiled, or reverse-engineered in any manner without the prior written consent of the Company.

Disclaimer

The Company endeavors to achieve the accuracy and completeness of this manual, but no warranty of accuracy or reliability is given. All the specifications and designs are subject to change without notice due to continuous technology development. No part of this manual may be copied, modified, translated, or distributed in any manner without the prior written consent of the Company.

We do not guarantee, for any particular purpose, the accuracy, validity, timeliness, legitimacy or completeness of the Third Party products and contents involved in this manual.

If you have any suggestions or would like to learn more details, please visit our website at:

<http://www.hytera.com>.

FCC Regulations

Federal Communication Commission (FCC) requires that all radio communication products should meet the requirements set forth in the FCC Radio Frequency (RF) exposure limits before they can be marketed in the U.S., and the manufacturer shall post an RF label on the product to inform users of operational instructions, so as to enhance their occupational health against exposure to RF energy.

FCC Statement

This equipment has been tested and found to comply with the limits for a Class B digital device, pursuant to part 15 of FCC Rules. These limits are designed to provide reasonable protection against harmful interference in a residential installation. This equipment generates and can radiate radio frequency energy. If not installed and used in accordance with the instructions, it may cause harmful interference to radio communications. However, there is no

guarantee that interference will not occur in a particular installation. Verification of harmful interference by this equipment to radio or television reception can be determined by turning it off and then on. The user is encouraged to try to correct the interference by one or more of the following measures:

- Reorient or relocate the receiving antenna. Increase the separation between the equipment and receiver.
- Connect the equipment into an outlet on a different circuit to that of the receiver's outlet.
- Consult the dealer or an experienced radio/TV technician for help.

Operation is subject to the following two conditions:

- This device may not cause harmful interference.
- This device must accept any interference received, including interference that may cause undesired operation.

Note: Changes or modifications to this unit not expressly approved by the party responsible for compliance could void the user's authority to operate the equipment.

RF Exposure Compliance and Control Guidelines and Operating Instructions

To control your exposure and ensure compliance with the occupational/controlled environmental exposure limits, always adhere to the following procedures.

Guidelines:

- Do not remove the RF Exposure Label from the device.
- User awareness instructions should accompany device when transferred to other users.
- Do not use this device if the operational requirements described herein are not met.

Operating Instructions:

- Transmit no more than the rated duty factor of 50% of the time. To transmit (talk), push the Push-To-Talk (PTT) key. To receive calls, release the PTT key. Transmitting 50% of the time, or less, is important because the radio generates measurable RF energy only when transmitting (in terms of measuring for standards compliance).
- Keep the radio unit at least 2.5 cm away from the face. Keeping the radio at the proper distance is important as RF exposure decreases with distance from the antenna. The antenna should be kept away from the face and eyes.
- When worn on the body, always place the radio in a Hytera-approved holder, holster, case, or body harness or by use of the correct clip for this product. Use of non-approved accessories may result in exposure levels which exceed the FCC's occupational/controlled environmental RF exposure limits.
- Use of non-approved antennas, batteries, and accessories causes the radio to exceed the FCC RF exposure guidelines.
- Contact your local dealer for the optional accessories of the product.





EU Regulatory Conformance

As certified by the qualified laboratory, the product is in compliance with the essential requirements and other relevant provisions of the following directives:

- 1999/5/EC or 2014/53/EU
- 2006/66/EC
- 2011/65/EU
- 2012/19/EU



Please note that the above information is applicable to EU countries only.

Contents

1. Items in the Package	1
2. Product Overview	2
2.1 Product Controls	2
2.2 LCD Icon	3
2.3 LED Indicator	4
3. Before Use	6
3.1 Attaching the Antenna.....	6
3.2 Installing the TF Card.....	6
3.3 Attaching the Battery.....	7
3.4 Attaching the Belt Clip.....	7
3.5 Attaching the Accessories.....	7
3.6 Charging the Battery	8
4. Basic Operations	10
4.1 Turning On/Off the Radio.....	10
4.2 Checking the Battery.....	10
4.3 Checking the Battery Power	10
4.4 Adjusting the Volume	11
4.5 Selecting a Zone	11
4.6 Selecting a Channel.....	11
4.7 Inputting via Keypad	11
4.8 Locking or Unlocking Keys and Knobs.....	12
4.9 Creating a Private Contact 	12
5. Call Services	13
5.1 Private Call 	13
5.2 Group Call 	13
5.3 Call on Analog Channel without Signaling 	14
5.4 Emergency Call	14
6. Message Services 	15
7. Troubleshooting	16
8. Care and Cleaning	18
9. Optional Accessories	19

1. Items in the Package

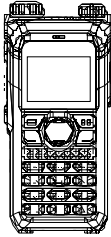
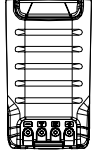
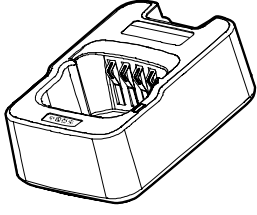
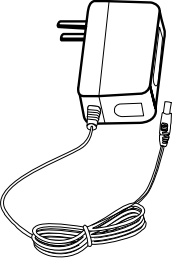
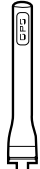
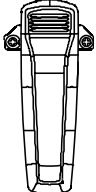
Please unpack carefully and check if all items listed below are received. If any item is missing or damaged, please contact your dealer.

		
Radio	Battery	Charger
		
Power Adapter	Antenna	Belt Clip
		
Strap	Documentation Kit	

Note

- The pictures in this manual are for reference only.
- The frequency band is marked on the label of antenna; if it is unavailable there, see the label on the radio.

2. Product Overview

2.1 Product Controls

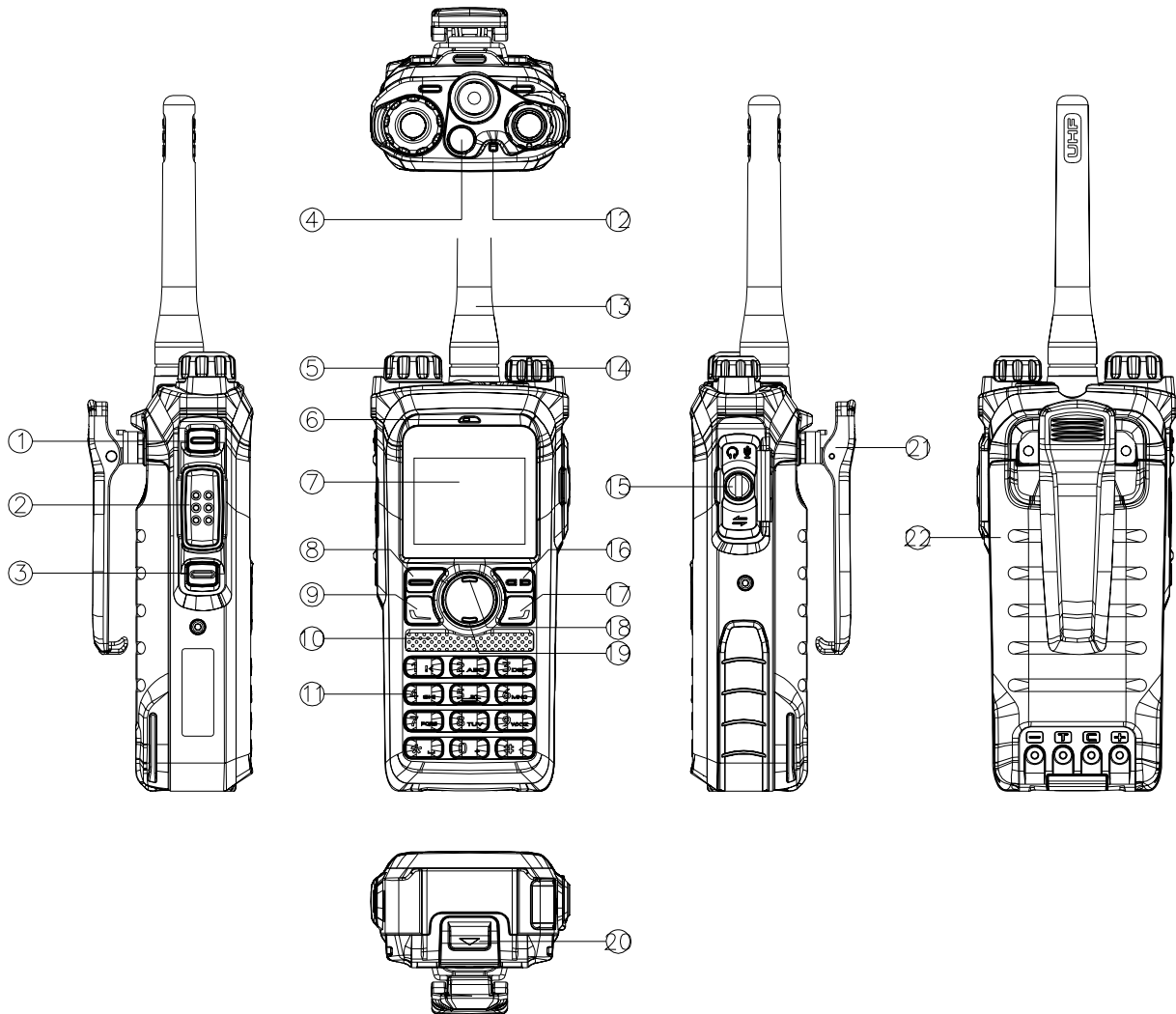











No.	Part Name	No.	Part Name
1	Side Key 1 (SK1)	12	LED Indicator
2	Push-to-Talk (PTT) Key	13	Antenna
3	Side Key 2 (SK2)	14	On-Off/Volume Control Knob
4	Top Key (TK)	15	Accessory Connector
5	Channel Selector Knob	16	Back Key
6	Microphone	17	P2 Key
7	LCD Display	18	Up Key

















No.	Part Name	No.	Part Name
8	OK/Menu Key	19	Down Key
9	P1 Key	20	Battery Latch
10	Speaker	21	Belt Clip
11	Numeric Keypad	22	Battery

Note

For enhanced convenience, you may request your dealer to program the **TK**, **SK1**, **SK2**, **P1**, and **P2** as shortcuts to radio features. For the detailed introduction, see the *DMR Conventional Radio Feature Description and Operation Manual* along with the product.

2.2 LCD Icon

Icon	Radio Status
	The DTMF keypad is enabled.
	The GPS feature is enabled, and the radio receives GPS data.
	The GPS feature is enabled, but the radio receives no GPS data.
	The number of bars (0–3) indicates the charge remaining in the battery.
	The radio is set at Low power.
	The radio is set at High power.
	An accessory is connected.
	One or more new work orders are received.
	The maximum number of saved work orders is reached.
DM	Direct Mode: In this mode, radios communicate with each other directly.
RM	Repeater Mode: In this mode, radios communicate with each other via a repeater.
	The Monitor feature is enabled.
	The radio is in emergency mode (excluding silent emergency

Icon	Radio Status
	mode) or an emergency call is received.
	The radio is roaming.
	The Scrambler or Encrypt feature is enabled.
	The radio is scanning.
	The radio stays on a non-priority channel.
P ₁	The radio stays on priority channel 1.
P ₂	The radio stays on priority channel 2.
	The VOX feature is enabled.
	There is/are missed call(s).
	There is/are unread message(s).
	The Inbox is full.
	The BT feature is enabled.
B	The wireless device is connected.
	There is no signal.
	The number of bars (1–4) indicates the radio signal strength.
	The speaker is unmuted.
	The radio operates in silent mode.
Q	The LQO feature is enabled.
	No TF card is detected.
	A private call is in progress or a private contact is in the contact list.
	A group call is in progress or a group contact is in the contact list.
	An all call is in progress or an all call contact is in the contact list.

2.3 LED Indicator

LED Indication	Radio Status
----------------	--------------

LED Indication	Radio Status
Flashes green	Being turned on.
Glow green	Receiving.
Glow red	Transmitting.
Flashes orange slowly	Scanning or roaming.
Flashes orange rapidly	Working in emergency mode.
Glow orange	Call hang time: No voice is being transmitted or received on the channel during a call. Within such a period, you can hold down the PTT key to speak.
Glow blue	The BT feature is being enabled.
Flashes blue every 3s	The BT feature is enabled, but no wireless device is connected.
Flashes blue every 1.5s	The wireless device is connected.
Flashes blue every 0.1s	The BT feature is being disabled.

3. Before Use

3.1 Attaching the Antenna

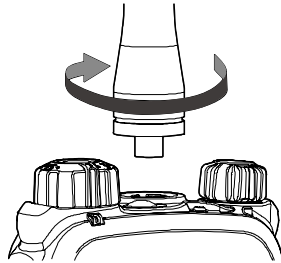

Caution

Do not hold the radio by its antenna; otherwise, the radio performance may be reduced and the life span of the antenna may be shortened.

3.2 Installing the TF Card

Install the TF card as follows if required:

Step 1 Loosen the screw fixing the TF card cover, remove the cover, and then place the card in the holder properly as shown below.

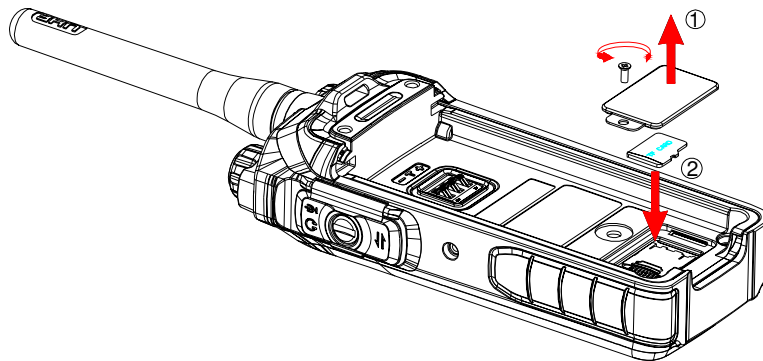

Step 2 Replace the cover and tighten the screw as shown below.

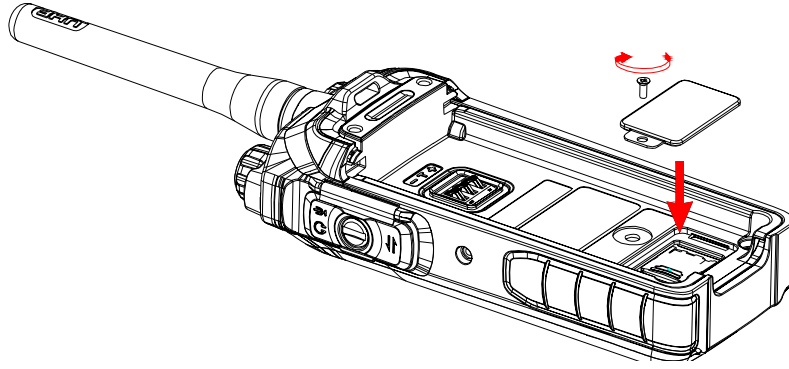

3.3 Attaching the Battery

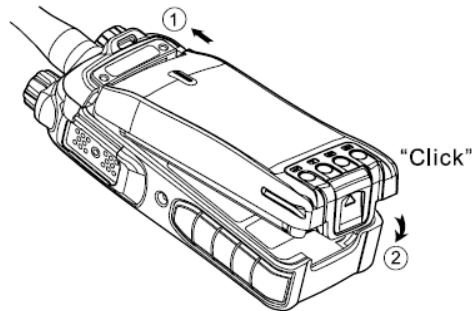

Note

To remove the battery, make sure that the radio is turned off, and then slide the battery latch upwards to unlock the battery.

3.4 Attaching the Belt Clip

Step 1 Unfasten the two screws on the back of the radio.

Step 2 Align the screw holes on the belt clip with those on the back of the radio, as shown below.

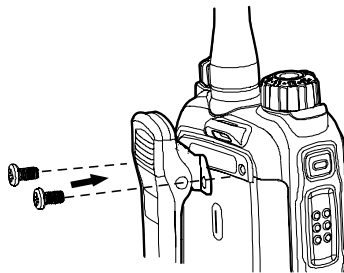

Step 3 Tighten the screws.

3.5 Attaching the Accessories

Caution

For optimal waterproof and dustproof performance:

- Do not scrape the silicone waterproof pad surrounding the screw hold of the accessory connector.
- Do close the accessory connector cover and fasten the screw after removing the accessory.

Step 1 Loosen the screw fixing the accessory connector cover, and open the cover as shown below.

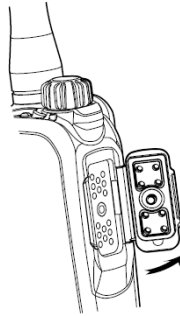

Step 2 Align the accessory (such as an audio accessory or a programming cable) plug with the accessory connector.

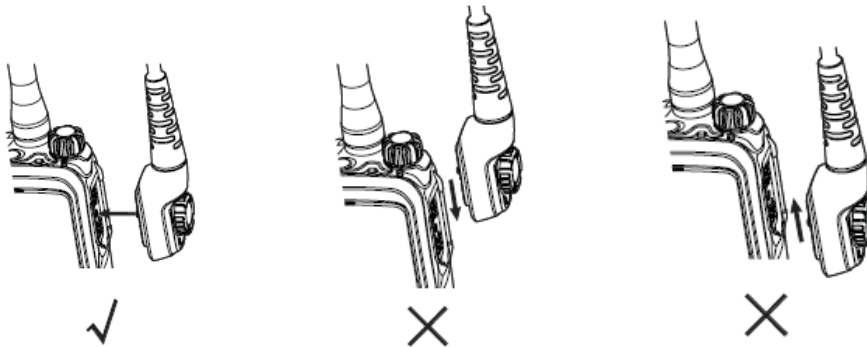

Step 3 Tighten the screw on the accessory plug.

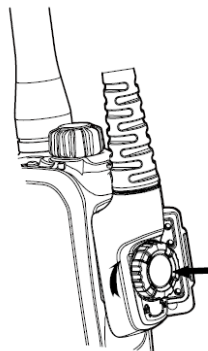

3.6 Charging the Battery

Caution

Use the charger specified by the Company to charge the battery.

Be sure to charge the battery fully before initial use, since reduction of state of charge (SoC) may lead to low battery alarm. You can charge the standalone battery or the radio with battery attached. It is

recommended that your radio remain powered off during charging.

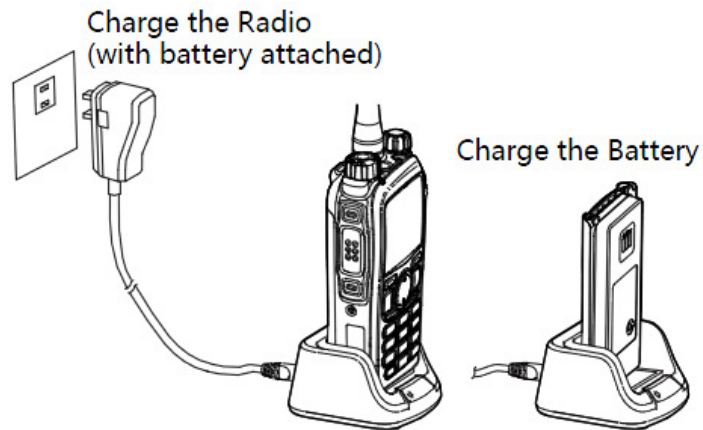

The LED indicator on the charger shows the charging status. For details, see the following table.

LED Indication	Charging Status
Flashes red slowly	The battery is inserted incorrectly.
Glowes red	The battery is charging.
Glowes orange	The battery is charged to 90% or more.
Glowes green	The battery is fully charged.
Flashes red rapidly	The battery fails to be charged.

4. Basic Operations

4.1 Turning On/Off the Radio

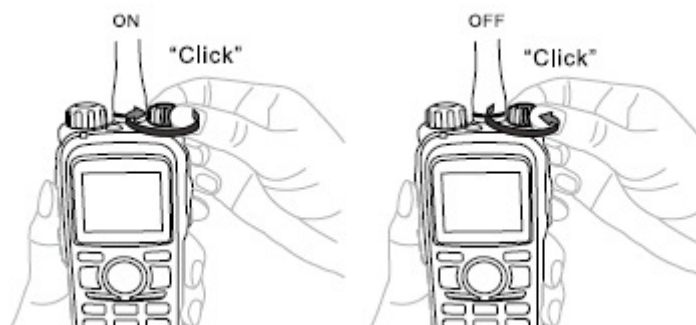

Note

Upon power-on, the radio automatically checks whether the battery is approved by the Company. If yes, "Certificated Battery" (for an anti-fake battery) or "Smart Battery" (for a smart battery) appears on the screen; if no, "Not Certificated Battery" appears.





4.2 Checking the Battery

Using a battery not approved by the Company disables the Battery Save feature, makes the battery power indication inaccurate, and reduces the radio performance.

To check the battery, go to "Menu -> Settings -> Radio Set -> Battery". If "Not Certificated Battery" appears, it is recommended that you replace the battery with one approved by the Company.

4.3 Checking the Battery Power

You can check the current battery power by holding down the **Battery Power Indicator** key programmed by your dealer, and release the key to exit. Battery power indications and alert tone are listed below:

LED Indication/Tone	Icon
The LED indicator glows green.	
The LED indicator glows orange.	
The LED indicator glows red.	
The LED indicator glows red and an alert tone sounds.	 The battery runs low. Please recharge or replace the battery.

4.4 Adjusting the Volume



4.5 Selecting a Zone

A zone is a group of channels with the same property. The radio supports up to 64 zones, with a maximum of 128 channels per zone.

To select a zone, do one of the following:

- **Menu:** Go to "Menu -> Zone", press the **Up** or **Down** key to select an appropriate zone, and then press the **OK/Menu** key to switch to the selected zone.
- **Shortcut key:** Switch to an appropriate zone by pressing the **Zone Up** or **Zone Down** key programmed by your dealer.





4.6 Selecting a Channel

Data and voices are received and transmitted on a channel. You can rotate the **Channel Selector** knob to select the channel.



4.7 Inputting via Keypad

You can use the keypad to enter user aliases or IDs and text messages. Here are some useful tips:

- To switch the input method between alphabetic mode and numeric mode, press .
- To enter special characters, press  in the alphabetic mode or  in the numeric mode.
- To enter the space, press  in the alphabetic mode.

4.8 Locking or Unlocking Keys and Knobs

When the keypad is not in use, it is recommended that you lock it to avoid misoperations. To lock or unlock the keypad, do one of the following:

- Automatically lock or unlock the keypad

The Keypad Lock feature allows the keypad to be locked automatically if no operation is performed within the preset time period.

To enable this feature, go to "Menu -> Settings -> Radio Set -> Keypad Lock", select "Enable", and set "Delay Time(s)" by pressing the **Up** or **Down** key.

To disable this feature, select "Disable" under the "Keypad Lock" menu.

- Manually lock or unlock the keypad

To manually lock or unlock the keypad, do one of the following on the home screen:

- Press the **Keypad Lock** key programmed by your dealer.
- Press the **OK/Menu** key and then press .

Note

You can go to "Menu -> Settings -> Radio Set -> Optional Key" to set whether the following keys and knobs will be locked when the keypad is locked: **TK**, **P1**, **P2**, **SK1**, **SK2**, **Channel Selector** knob, **On-Off/Volume Control** knob, and **PTT**.

4.9 Creating a Private Contact

To add a new contact to the private contact list, go to "Menu -> Contact -> New Contact", enter the ID and alias of the new contact, and save it.

Note

- The ID and alias of a new contact must be unique.
- You can also save the IDs from the Call Logs into the contact list.

5. Call Services

Once you have selected the required channel, you can make or receive calls on that channel. To ensure optimal voice quality of the receiving radio, keep the microphone about 2.5 to 5 centimeters away from your mouth when the radio is transmitting.

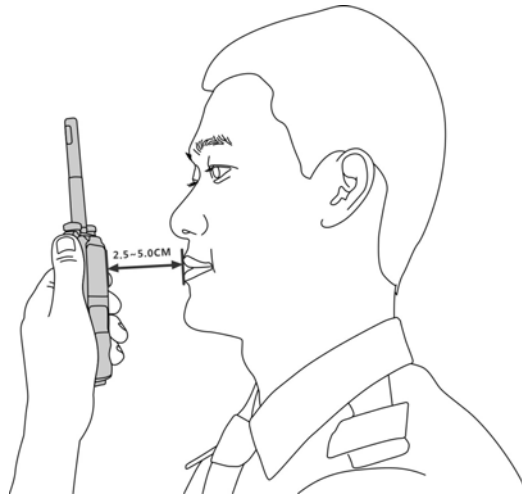

5.1 Private Call

A private call is a call from an individual user to another individual user.

5.1.1 Initiating a Private Call

On the home screen, hold down the **PTT** key to initiate a call to the private contact preset for the current channel. In this case, the radio displays  on the screen.

For other ways to initiate a private call, see the *DMR Conventional Radio Feature Description and Operation Manual* along with the product.

5.1.2 Receiving and Responding to a Private Call

When you receive a private call, the radio displays  on the screen. Then you can listen to it without any operation.

You can hold down the **PTT** key to speak within the preset time period. Otherwise, the call ends and the radio displays missed call indications.

5.2 Group Call

A group call is a call from an individual user to a group of users.

5.2.1 Initiating a Group Call

On the home screen, hold down the **PTT** key to initiate a group call to the group contact preset for the current channel. In this case, the radio displays  on the screen.

For other ways to initiate a group call, see the *DMR Conventional Radio Feature Description and Operation Manual* along with the product.

5.2.2 Receiving and Responding to a Group Call

When you receive a group call, the radio displays  on the screen. Then you can listen to it without any operation.

You can hold down the **PTT** key to speak within the preset time period. If there is no voice activity within the preset time period, the call ends.

5.3 Call on Analog Channel without Signaling

To transmit on the analog channel, hold down the **PTT** key and speak into the microphone. To receive, release the **PTT** key.

For descriptions and operations of calls on the analog channel with signaling, see the *DMR Conventional Radio Feature Description and Operation Manual* along with the product.

5.4 Emergency Call

In case of emergency, you can use the Emergency Call feature to ask for help from your companion or the control center.

This feature needs to be configured and enabled by your dealer. For details, see the *DMR Conventional Radio Feature Description and Operation Manual* along with the product.

6. Message Services

Message services allow you to edit a new message and send it directly or save it to the Drafts, directly send a quick text message, and forward the messages saved in the Inbox and Outbox.

New Message

New Message allows you to create a message. You can send the new message to a private contact or group contact, or save it to the Drafts.

Quick Text

Quick Text allows you to send the frequently used messages preset by your dealer. You can send the quick text message directly or edit it before sending it.

Inbox

The Inbox saves the received messages and marks each message with a corresponding icon to indicate its status.

When the Inbox is full, the earliest message will be overwritten by the latest one automatically.

Outbox

The Outbox saves the sent messages and marks each message with a corresponding icon to indicate its status.

When the Outbox is full, the earliest message will be overwritten by the latest one automatically.

Drafts

The Drafts saves the edited messages. When the Drafts is full, the earliest message will be overwritten by the latest one automatically.

If the message in the Drafts is sent successfully, it will be moved from the Drafts to the Outbox.

Otherwise, the message will remain in the Drafts and be saved into the Outbox as well.

7. Troubleshooting

Phenomena	Analysis	Solution
The radio cannot be turned on.	The battery may be installed improperly.	Remove and reattach the battery.
	The battery power may run out.	Recharge or replace the battery.
	The battery may suffer from poor contact caused by dirtied or damaged battery contacts.	Clean the battery contacts or replace the battery.
During receiving, the voice is weak, discontinuous or totally inactive.	The battery voltage may be low.	Recharge or replace the battery.
	The volume level may be low.	Increase the volume by rotating the Volume Control knob.
	The antenna may get loose or may be installed improperly.	Turn off the radio, and remove and reattach the antenna.
	The speaker may be blocked.	Clean the surface of the speaker.
You cannot communicate with other group members.	The frequency or signaling may be inconsistent with that of other members.	Set your TX/RX frequency and signaling to the same as those of other members.
	The channel type (digital or analog) may be set inconsistently.	Make sure all members are on the same digital or analog channel.
	You may be too far away from other members.	Move towards other members.
Irrelevant voices or noise is heard on the channel.	You may be interrupted by radios using the same frequency.	Change the frequency, or adjust the squelch level.
	The radio in analog mode may be set with no signaling.	Set signaling for all radios operating at the same frequency to avoid interference.
The noise is too	You may be too far away from	Move towards other members.

Phenomena	Analysis	Solution
loud.	other members.	
	You may locate in an unfavorable position. For example, your communication may be blocked by high buildings or frustrated in the underground areas.	Move to an open and flat area, and restart the radio to try again.
	You may suffer from external disturbance (such as electromagnetic interference).	Stay away from equipment that may cause interference.
The GPS cannot locate your position.	GPS signals may not be received due to unfavorable position.	Move to an open and flat area, and try again.
You cannot use the keys.	The keypad may fail to function temporarily.	Restart the radio.
The LCD does not display any information.	The LCD may fail to function temporarily.	Restart the radio.

If the above solutions cannot fix your problems, or you may have some other queries, please contact us or your local dealer for more technical support.

8. Care and Cleaning

To guarantee optimal performance as well as a long service life of the product, please follow the tips below.

Product Care

- Do not pierce or scrape the product.
- Keep the product far away from substances that can corrode the circuit.
- Do not hold the product by its antenna or earpiece cable.
- Close the accessory connector cover when no accessory is in use.

Product Cleaning



Caution: Turn off the product and remove the battery before cleaning.

- Clean up the dust and fine particles on the product surface and charging piece with a clean and dry lint-free cloth or a brush regularly.
- Use neutral cleanser and a non-woven fabric to clean the keys, knobs and front case after long-time use. Do not use chemical preparations such as stain removers, alcohol, sprays or oil preparations, so as to avoid surface case damage.
- Make sure the product is completely dry before use.

9. Optional Accessories

Contact your local dealer for the optional accessories of the product.

 **Caution:** Use the accessories specified by the Company only; otherwise, the Company shall not be liable for any loss or damage arising out of use of unauthorized accessories.