

Test Plot 1#: Antenna 1_PTT_FM 12.5kHz_Face Up_136.0125 MHz**DUT: Digital Portable Radio; Type: PD782iG VHF; Serial: 18081600720**

Communication System:FM; Frequency: 136.012 MHz;Duty Cycle: 1:1

Medium parameters used: $f = 136.012$ MHz; $\sigma = 0.748$ S/m; $\epsilon_r = 52.931$; $\rho = 1000$ kg/m³

Phantom section: Flat Section

DASY5 Configuration:

- Probe: EX3DV4 - SN7329; ConvF(12.88, 12.88, 12.88); Calibrated: 2018/1/22;
- Sensor-Surface: 1.4mm (Mechanical Surface Detection)
- Electronics: DAE4 Sn1459; Calibrated: 2017/9/15
- Phantom: ELI v8.0; Type: QDOVA004AA; Serial: 2051
- Measurement SW: DASY52, Version 52.8 (8);

Area Scan (61x151x1): Interpolated grid: dx=1.500 mm, dy=1.500 mm

Maximum value of SAR (interpolated) = 3.01 W/kg

Zoom Scan (5x5x7)/Cube 0: Measurement grid: dx=8mm, dy=8mm, dz=5mm

Reference Value = 52.00 V/m; Power Drift = 0.12 dB

Peak SAR (extrapolated) = 3.37 W/kg

SAR(1 g) = 2.17 W/kg; SAR(10 g) = 1.64 W/kg

Maximum value of SAR (measured) = 2.79 W/kg

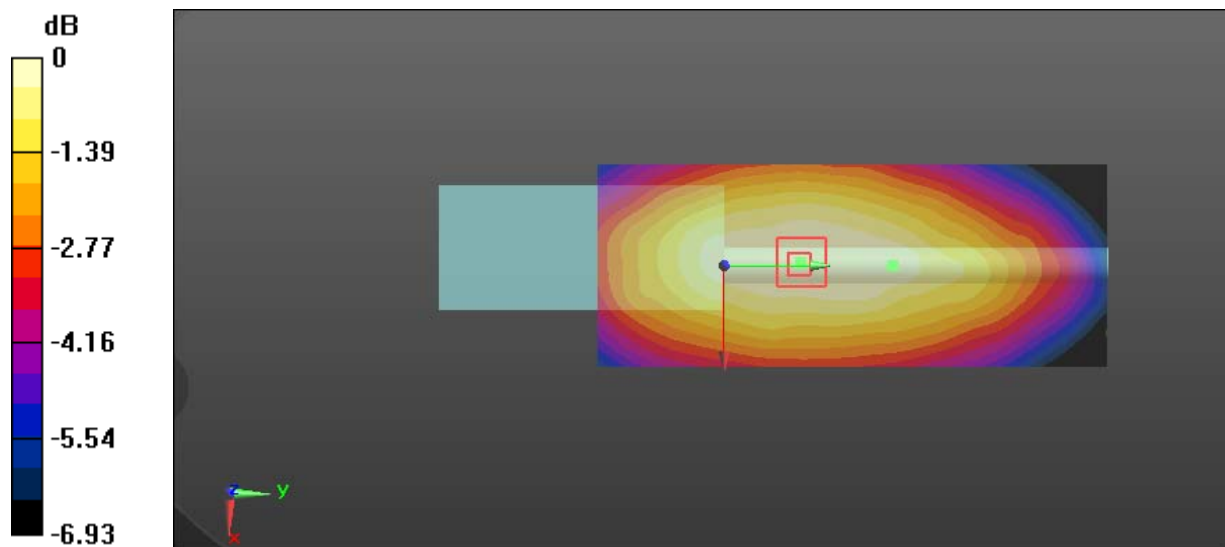

0 dB = 2.79 W/kg = 4.46 dBW/kg

Test Plot 2#: Antenna 1_PTT_FM 12.5kHz_Face Up_141 MHz**DUT: Digital Portable Radio; Type: PD782iG VHF; Serial: 18081600720**

Communication System:FM; Frequency: 141 MHz;Duty Cycle: 1:1

Medium parameters used: $f = 141$ MHz; $\sigma = 0.751$ S/m; $\epsilon_r = 53.16$; $\rho = 1000$ kg/m³

Phantom section: Flat Section

DASY5 Configuration:

- Probe: EX3DV4 - SN7329; ConvF(12.88, 12.88, 12.88); Calibrated: 2018/1/22;
- Sensor-Surface: 1.4mm (Mechanical Surface Detection)
- Electronics: DAE4 Sn1459; Calibrated: 2017/9/15
- Phantom: ELI v8.0; Type: QDOVA004AA; Serial: 2051
- Measurement SW: DASY52, Version 52.8 (8);

Area Scan (61x151x1): Interpolated grid: dx=1.500 mm, dy=1.500 mm

Maximum value of SAR (interpolated) = 2.63 W/kg

Zoom Scan (5x6x7)/Cube 0: Measurement grid: dx=8mm, dy=8mm, dz=5mm

Reference Value = 47.75 V/m; Power Drift = 0.14 dB

Peak SAR (extrapolated) = 3.15 W/kg

SAR(1 g) = 1.98 W/kg; SAR(10 g) = 1.5 W/kg

Maximum value of SAR (measured) = 2.64 W/kg

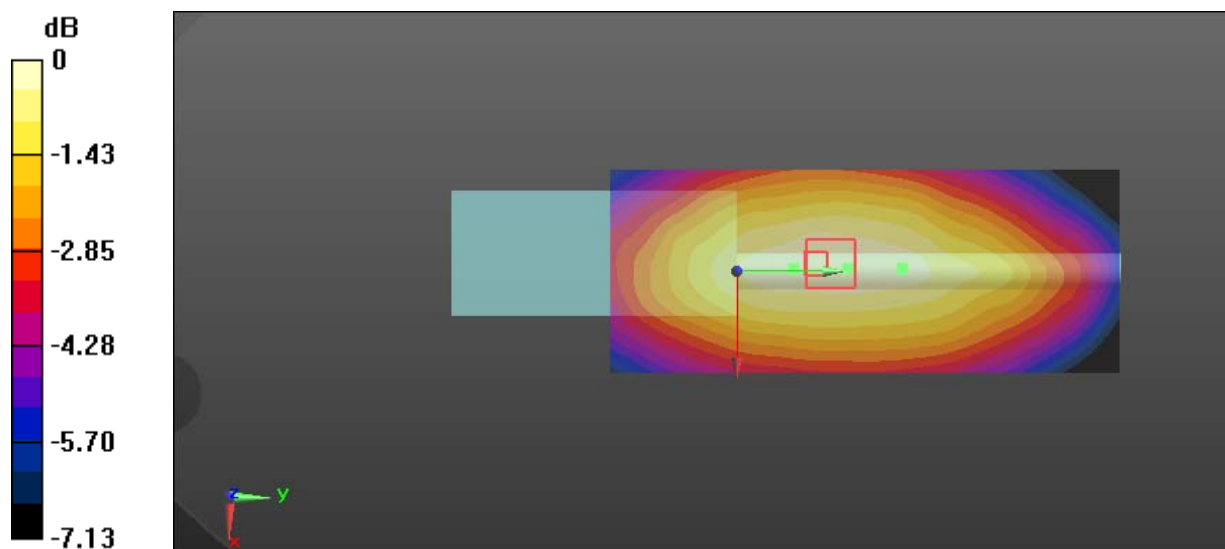

0 dB = 2.64 W/kg = 4.22 dBW/kg

Test Plot 3#: Antenna 1_PTT_FM 12.5kHz_Face Up_146.9875 MHz**DUT: Digital Portable Radio; Type: PD782iG VHF; Serial: 18081600720**

Communication System:FM; Frequency: 146.988 MHz;Duty Cycle: 1:1

Medium parameters used: $f = 146.988$ MHz; $\sigma = 0.769$ S/m; $\epsilon_r = 51.83$; $\rho = 1000$ kg/m³

Phantom section: Flat Section

DASY5 Configuration:

- Probe: EX3DV4 - SN7329; ConvF(12.88, 12.88, 12.88); Calibrated: 2018/1/22;
- Sensor-Surface: 1.4mm (Mechanical Surface Detection)
- Electronics: DAE4 Sn1459; Calibrated: 2017/9/15
- Phantom: ELI v8.0; Type: QDOVA004AA; Serial: 2051
- Measurement SW: DASY52, Version 52.8 (8);

Area Scan (61x151x1): Interpolated grid: dx=1.500 mm, dy=1.500 mm

Maximum value of SAR (interpolated) = 1.15 W/kg

Zoom Scan (5x5x7)/Cube 0: Measurement grid: dx=8mm, dy=8mm, dz=5mm

Reference Value = 33.34 V/m; Power Drift = -0.12 dB

Peak SAR (extrapolated) = 1.38 W/kg

SAR(1 g) = 0.850 W/kg; SAR(10 g) = 0.641 W/kg

Maximum value of SAR (measured) = 1.13 W/kg

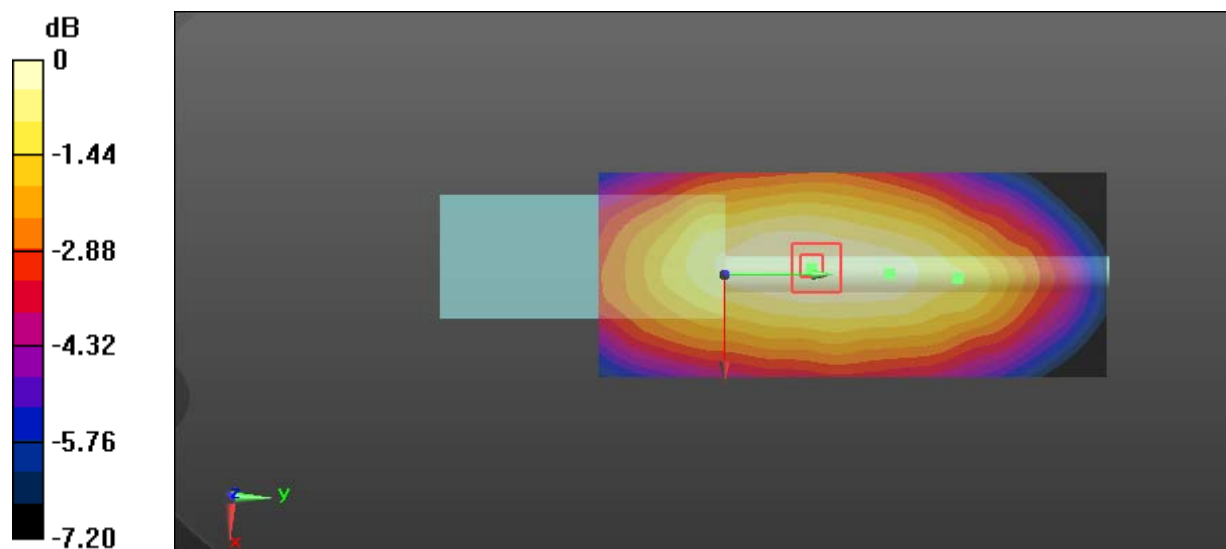

0 dB = 1.13 W/kg = 0.53 dBW/kg

Test Plot 4#: Antenna 1_PTT_FM 25kHz_Face Up_136.0125 MHz**DUT: Digital Portable Radio; Type: PD782iG VHF; Serial: 18081600720**

Communication System:FM; Frequency: 136.012 MHz;Duty Cycle: 1:1

Medium parameters used: $f = 136.012$ MHz; $\sigma = 0.748$ S/m; $\epsilon_r = 52.931$; $\rho = 1000$ kg/m³

Phantom section: Flat Section

DASY5 Configuration:

- Probe: EX3DV4 - SN7329; ConvF(12.88, 12.88, 12.88); Calibrated: 2018/1/22;
- Sensor-Surface: 1.4mm (Mechanical Surface Detection)
- Electronics: DAE4 Sn1459; Calibrated: 2017/9/15
- Phantom: ELI v8.0; Type: QDOVA004AA; Serial: 2051
- Measurement SW: DASY52, Version 52.8 (8);

Area Scan (61x151x1): Interpolated grid: dx=1.500 mm, dy=1.500 mm

Maximum value of SAR (interpolated) = 2.51 W/kg

Zoom Scan (5x5x7)/Cube 0: Measurement grid: dx=8mm, dy=8mm, dz=5mm

Reference Value = 45.73 V/m; Power Drift = -0.12 dB

Peak SAR (extrapolated) = 2.95 W/kg

SAR(1 g) = 1.88 W/kg; SAR(10 g) = 1.43 W/kg

Maximum value of SAR (measured) = 2.46 W/kg

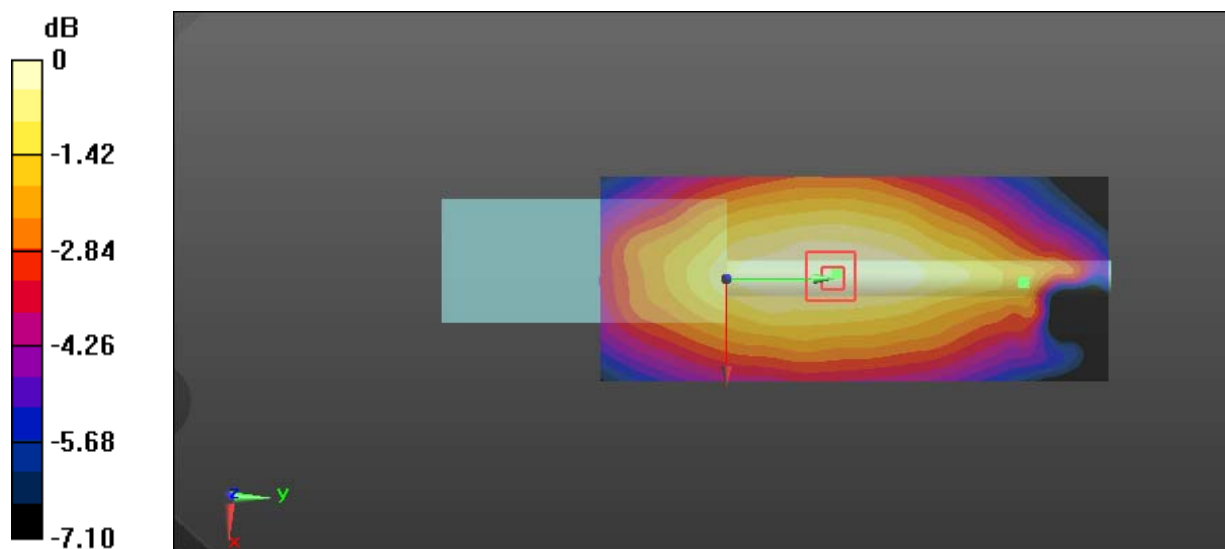

0 dB = 2.46 W/kg = 3.91 dBW/kg

Test Plot 5#: Antenna 1_PTT_4FSK 12.5kHz_Face Up_136.0125 MHz**DUT: Digital Portable Radio; Type: PD782iG VHF; Serial: 18081600720**

Communication System: 4FSK; Frequency: 136.012 MHz; Duty Cycle: 1:2

Medium parameters used: $f = 136.012$ MHz; $\sigma = 0.748$ S/m; $\epsilon_r = 52.931$; $\rho = 1000$ kg/m³

Phantom section: Flat Section

DASY5 Configuration:

- Probe: EX3DV4 - SN7329; ConvF(12.88, 12.88, 12.88); Calibrated: 2018/1/22;
- Sensor-Surface: 1.4mm (Mechanical Surface Detection)
- Electronics: DAE4 Sn1459; Calibrated: 2017/9/15
- Phantom: ELI v8.0; Type: QDOVA004AA; Serial: 2051
- Measurement SW: DASY52, Version 52.8 (8);

Area Scan (61x151x1): Interpolated grid: dx=1.500 mm, dy=1.500 mm

Maximum value of SAR (interpolated) = 1.22 W/kg

Zoom Scan (5x7x7)/Cube 0: Measurement grid: dx=8mm, dy=8mm, dz=5mm

Reference Value = 33.11 V/m; Power Drift = -0.12 dB

Peak SAR (extrapolated) = 1.55 W/kg

SAR(1 g) = 0.943 W/kg; SAR(10 g) = 0.712 W/kg

Maximum value of SAR (measured) = 1.26 W/kg

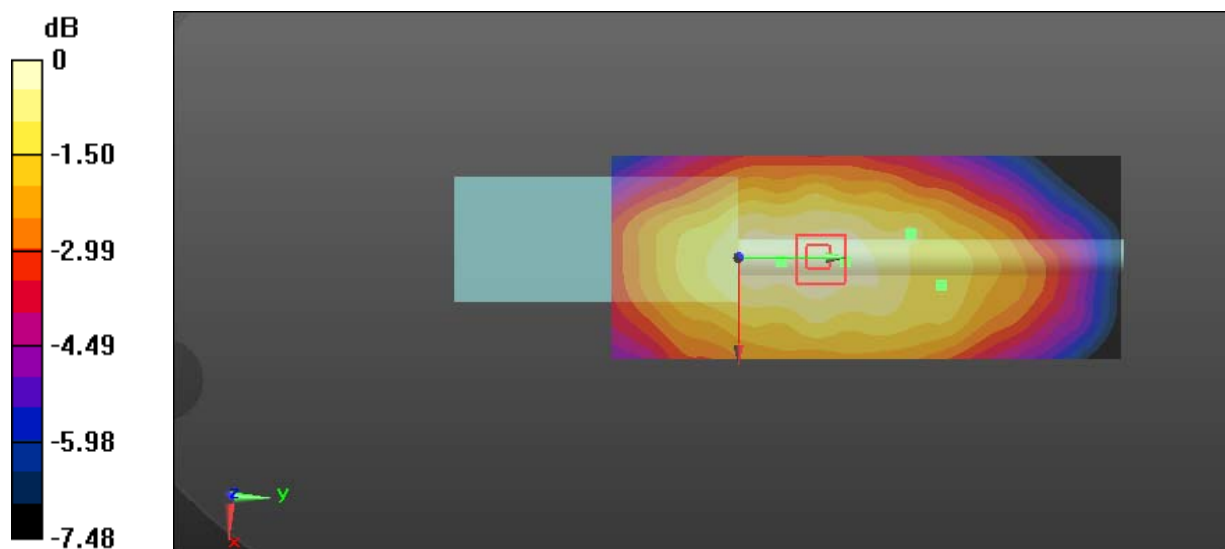

0 dB = 1.26 W/kg = 1.00 dBW/kg

Test Plot 6#: Antenna 1_PTT_FM 12.5kHz_Face Up_136.0125 MHz**DUT: Digital Portable Radio; Type: PD752iG VHF; Serial: 18081600721**

Communication System:FM; Frequency: 136.012 MHz;Duty Cycle: 1:1

Medium parameters used: $f = 136.012$ MHz; $\sigma = 0.748$ S/m; $\epsilon_r = 52.931$; $\rho = 1000$ kg/m³

Phantom section: Flat Section

DASY5 Configuration:

- Probe: EX3DV4 - SN7329; ConvF(12.88, 12.88, 12.88); Calibrated: 2018/1/22;
- Sensor-Surface: 1.4mm (Mechanical Surface Detection)
- Electronics: DAE4 Sn1459; Calibrated: 2017/9/15
- Phantom: ELI v8.0; Type: QDOVA004AA; Serial: 2051
- Measurement SW: DASY52, Version 52.8 (8);

Area Scan (61x151x1): Interpolated grid: dx=1.500 mm, dy=1.500 mm

Maximum value of SAR (interpolated) = 2.71 W/kg

Zoom Scan (5x5x7)/Cube 0: Measurement grid: dx=8mm, dy=8mm, dz=5mm

Reference Value = 47.41 V/m; Power Drift = 0.02 dB

Peak SAR (extrapolated) = 3.23 W/kg

SAR(1 g) = 2.04 W/kg; SAR(10 g) = 1.55 W/kg

Maximum value of SAR (measured) = 2.69 W/kg

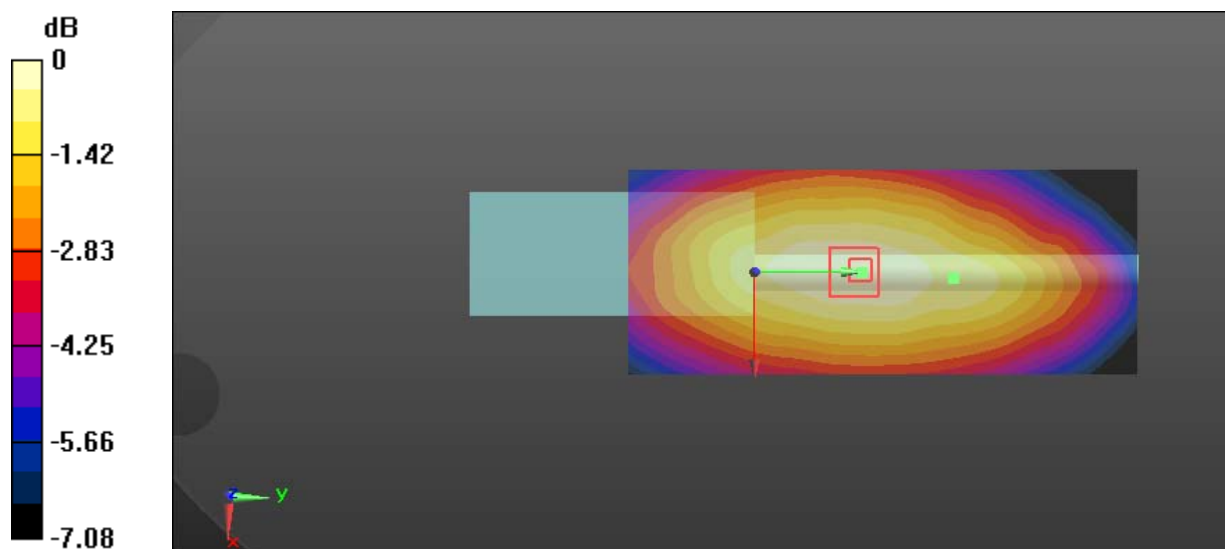

0 dB = 2.69 W/kg = 4.30 dBW/kg

Test Plot 7#: Antenna 1_PTT_FM 12.5kHz_Face Up_136.0125 MHz**DUT: Digital Portable Radio; Type: PD702iG VHF; Serial: 18081600722**

Communication System:FM; Frequency: 136.012 MHz;Duty Cycle: 1:1

Medium parameters used: $f = 136.012$ MHz; $\sigma = 0.748$ S/m; $\epsilon_r = 52.931$; $\rho = 1000$ kg/m³

Phantom section: Flat Section

DASY5 Configuration:

- Probe: EX3DV4 - SN7329; ConvF(12.88, 12.88, 12.88); Calibrated: 2018/1/22;
- Sensor-Surface: 1.4mm (Mechanical Surface Detection)
- Electronics: DAE4 Sn1459; Calibrated: 2017/9/15
- Phantom: ELI v8.0; Type: QDOVA004AA; Serial: 2051
- Measurement SW: DASY52, Version 52.8 (8);

Area Scan (61x151x1): Interpolated grid: dx=1.500 mm, dy=1.500 mm

Maximum value of SAR (interpolated) = 2.50 W/kg

Zoom Scan (6x6x7)/Cube 0: Measurement grid: dx=8mm, dy=8mm, dz=5mm

Reference Value = 48.14 V/m; Power Drift = -0.08 dB

Peak SAR (extrapolated) = 3.03 W/kg

SAR(1 g) = 1.91 W/kg; SAR(10 g) = 1.45 W/kg

Maximum value of SAR (measured) = 2.53 W/kg

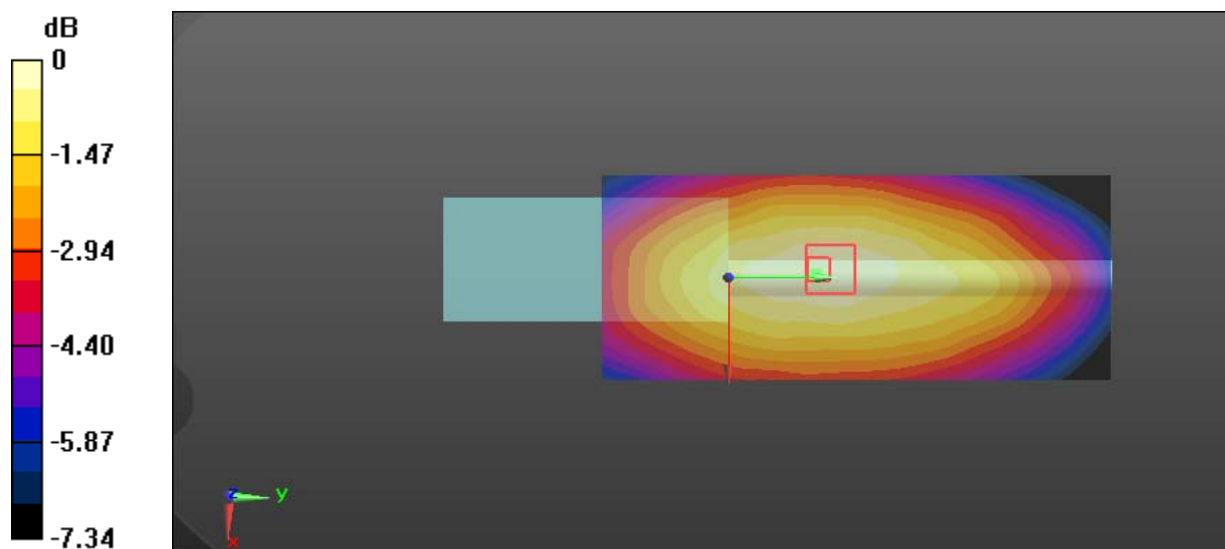

0 dB = 2.53 W/kg = 4.03 dBW/kg

Test Plot 8#: Antenna 1_PTT_FM 12.5kHz_Body Back_136.0125 MHz**DUT: Digital Portable Radio; Type: PD782iG VHF; Serial: 18081600720**

Communication System:FM; Frequency: 136.012 MHz;Duty Cycle: 1:1

Medium parameters used: $f = 136.012$ MHz; $\sigma = 0.81$ S/m; $\epsilon_r = 61.89$; $\rho = 1000$ kg/m³

Phantom section: Flat Section

DASY5 Configuration:

- Probe: EX3DV4 - SN7329; ConvF(12.56, 12.56, 12.56); Calibrated: 2018/1/22;
- Sensor-Surface: 1.4mm (Mechanical Surface Detection)
- Electronics: DAE4 Sn1459; Calibrated: 2017/9/15
- Phantom: ELI v8.0; Type: QDOVA004AA; Serial: 2051
- Measurement SW: DASY52, Version 52.8 (8);

Area Scan (61x151x1): Interpolated grid: dx=1.500 mm, dy=1.500 mm

Maximum value of SAR (interpolated) = 8.70 W/kg

Zoom Scan (5x5x7)/Cube 0: Measurement grid: dx=8mm, dy=8mm, dz=5mm

Reference Value = 71.23 V/m; Power Drift = -0.07 dB

Peak SAR (extrapolated) = 16.7 W/kg

SAR(1 g) = 5.86 W/kg; SAR(10 g) = 3.26 W/kg

Maximum value of SAR (measured) = 10.6 W/kg

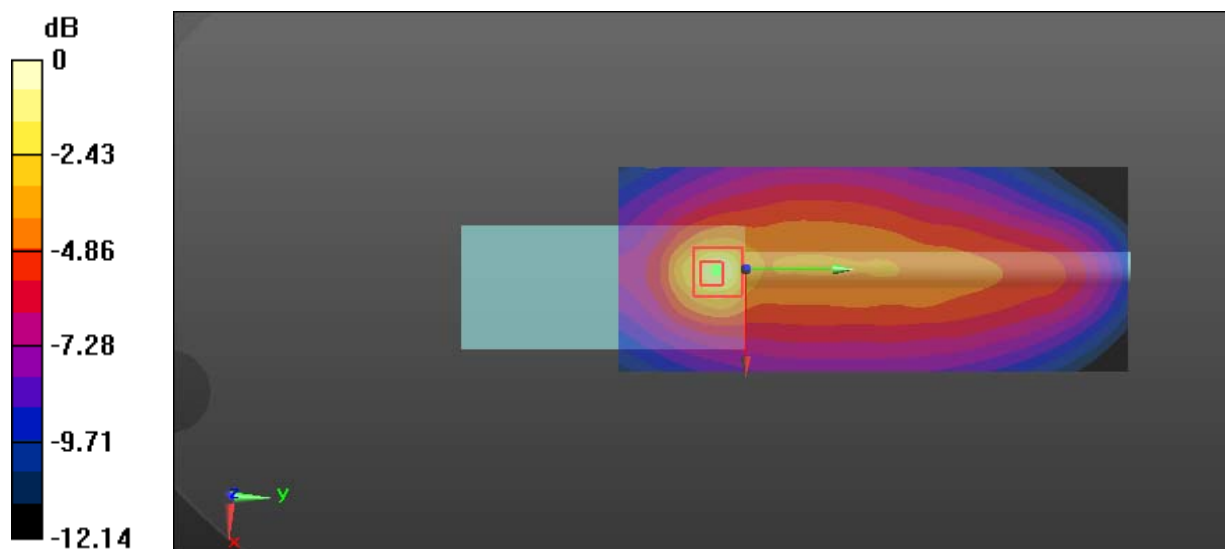

0 dB = 10.6 W/kg = 10.25 dBW/kg

Test Plot 9#: Antenna 1_PTT_FM 12.5kHz_Body Back_141 MHz**DUT: Digital Portable Radio; Type: PD782iG VHF; Serial: 18081600720**

Communication System: FM; Frequency: 141 MHz; Duty Cycle: 1:1

Medium parameters used: $f = 141$ MHz; $\sigma = 0.794$ S/m; $\epsilon_r = 61.993$; $\rho = 1000$ kg/m³

Phantom section: Flat Section

DASY5 Configuration:

- Probe: EX3DV4 - SN7329; ConvF(12.56, 12.56, 12.56); Calibrated: 2018/1/22;
- Sensor-Surface: 1.4mm (Mechanical Surface Detection)
- Electronics: DAE4 Sn1459; Calibrated: 2017/9/15
- Phantom: ELI v8.0; Type: QDOVA004AA; Serial: 2051
- Measurement SW: DASY52, Version 52.8 (8);

Area Scan (61x151x1): Interpolated grid: dx=1.500 mm, dy=1.500 mm

Maximum value of SAR (interpolated) = 7.52 W/kg

Zoom Scan (5x5x7)/Cube 0: Measurement grid: dx=8mm, dy=8mm, dz=5mm

Reference Value = 62.46 V/m; Power Drift = -0.13 dB

Peak SAR (extrapolated) = 11.4 W/kg

SAR(1 g) = 4.16 W/kg; SAR(10 g) = 2.36 W/kg

Maximum value of SAR (measured) = 7.53 W/kg

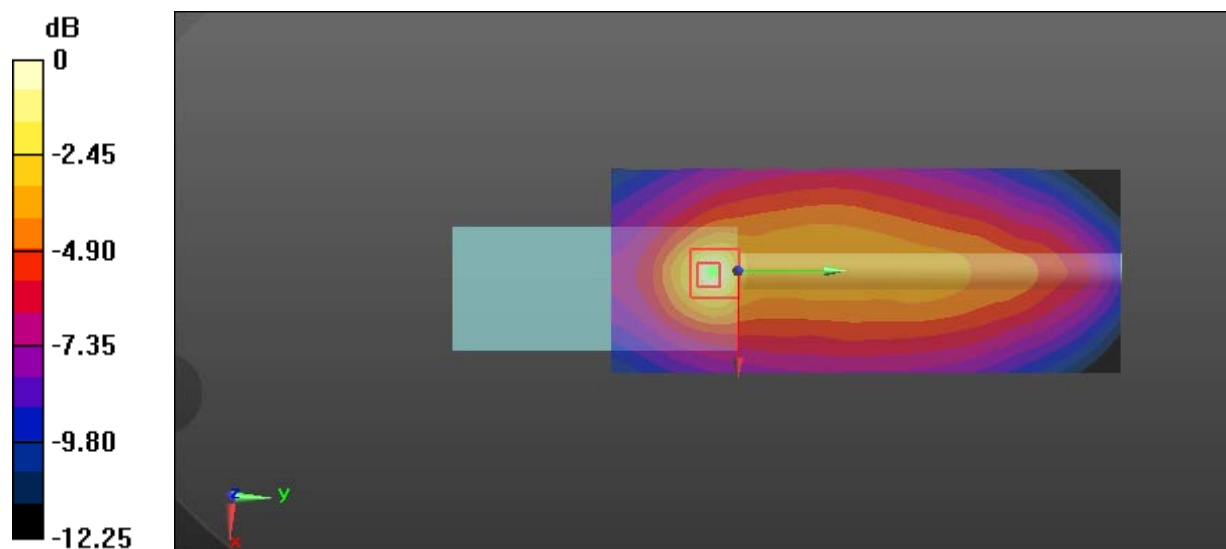

0 dB = 7.53 W/kg = 8.77 dBW/kg

Test Plot 10#: Antenna 1_PTT_FM 12.5kHz_Body Back_146.9875 MHz**DUT: Digital Portable Radio; Type: PD782iG VHF; Serial: 18081600720**

Communication System:FM; Frequency: 146.988 MHz;Duty Cycle: 1:1

Medium parameters used: $f = 146.988$ MHz; $\sigma = 0.807$ S/m; $\epsilon_r = 61.95$; $\rho = 1000$ kg/m³

Phantom section: Flat Section

DASY5 Configuration:

- Probe: EX3DV4 - SN7329; ConvF(12.56, 12.56, 12.56); Calibrated: 2018/1/22;
- Sensor-Surface: 1.4mm (Mechanical Surface Detection)
- Electronics: DAE4 Sn1459; Calibrated: 2017/9/15
- Phantom: ELI v8.0; Type: QDOVA004AA; Serial: 2051
- Measurement SW: DASY52, Version 52.8 (8);

Area Scan (61x151x1): Interpolated grid: dx=1.500 mm, dy=1.500 mm

Maximum value of SAR (interpolated) = 6.54 W/kg

Zoom Scan (5x5x7)/Cube 0: Measurement grid: dx=8mm, dy=8mm, dz=5mm

Reference Value = 47.26 V/m; Power Drift = 0.07 dB

Peak SAR (extrapolated) = 9.58 W/kg

SAR(1 g) = 3.38 W/kg; SAR(10 g) = 1.93 W/kg

Maximum value of SAR (measured) = 6.22 W/kg

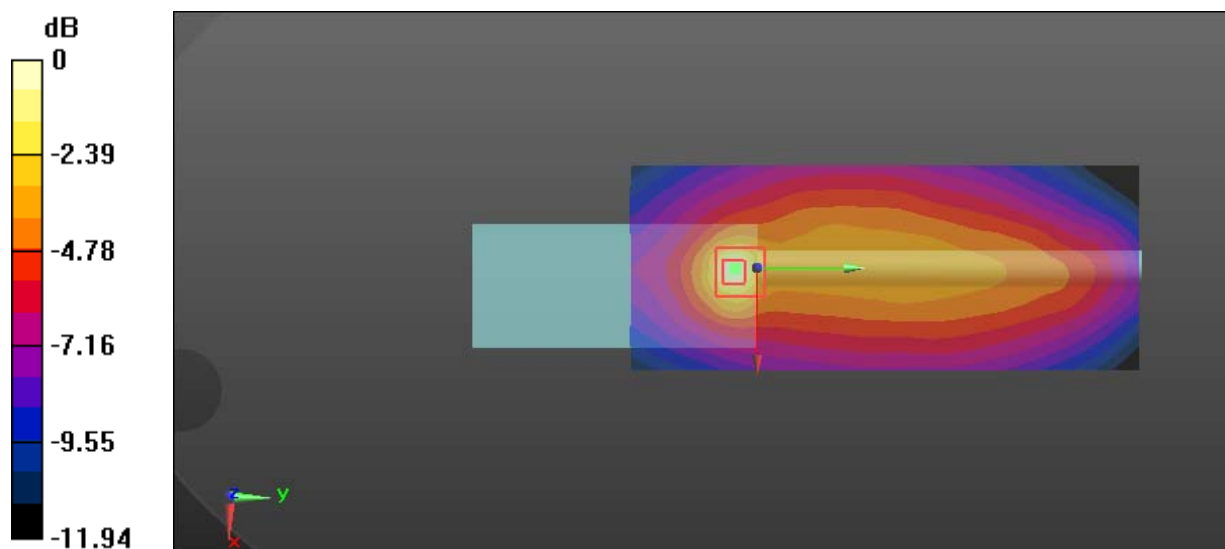

0 dB = 6.22 W/kg = 7.94 dBW/kg

Test Plot 11#: Antenna 1_PTT_FM 25kHz_Body Back_136.0125 MHz**DUT: Digital Portable Radio; Type: PD782iG VHF; Serial: 18081600720**

Communication System:FM; Frequency: 136.012 MHz;Duty Cycle: 1:1

Medium parameters used: $f = 136.012$ MHz; $\sigma = 0.81$ S/m; $\epsilon_r = 61.89$; $\rho = 1000$ kg/m³

Phantom section: Flat Section

DASY5 Configuration:

- Probe: EX3DV4 - SN7329; ConvF(12.56, 12.56, 12.56); Calibrated: 2018/1/22;
- Sensor-Surface: 1.4mm (Mechanical Surface Detection)
- Electronics: DAE4 Sn1459; Calibrated: 2017/9/15
- Phantom: ELI v8.0; Type: QDOVA004AA; Serial: 2051
- Measurement SW: DASY52, Version 52.8 (8);

Area Scan (61x151x1): Interpolated grid: dx=1.500 mm, dy=1.500 mm

Maximum value of SAR (interpolated) = 9.37 W/kg

Zoom Scan (5x5x7)/Cube 0: Measurement grid: dx=8mm, dy=8mm, dz=5mm

Reference Value = 66.79 V/m; Power Drift = 0.02 dB

Peak SAR (extrapolated) = 14.9 W/kg

SAR(1 g) = 5.24 W/kg; SAR(10 g) = 2.9 W/kg

Maximum value of SAR (measured) = 9.55 W/kg

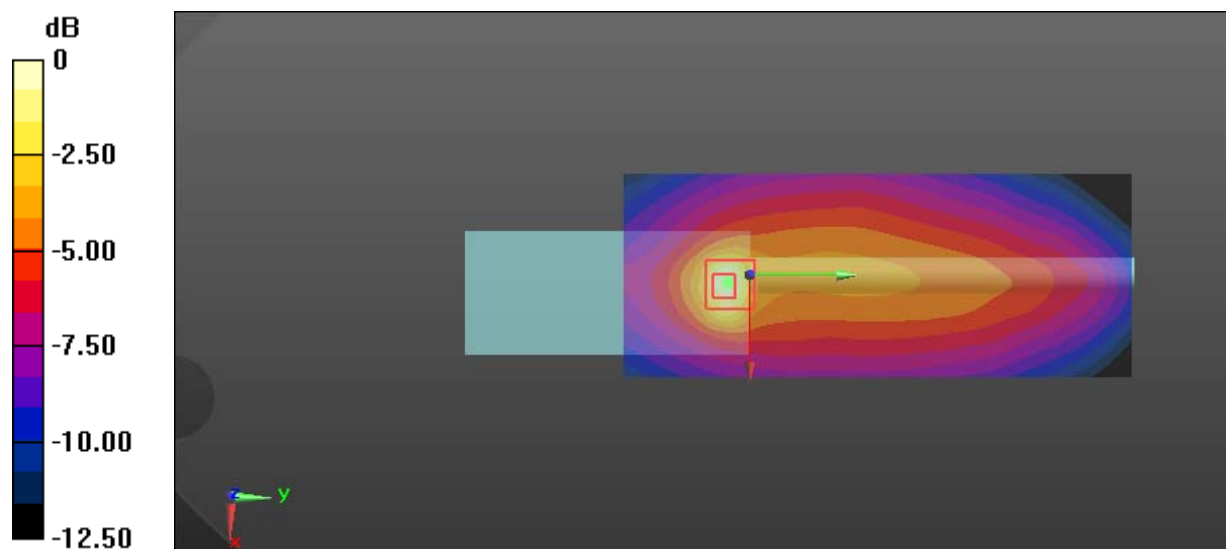

0 dB = 9.55 W/kg = 9.80 dBW/kg

Test Plot 12#: Antenna 1_PTT_4FSK 12.5kHz_Body Back_136.0125 MHz**DUT: Digital Portable Radio; Type: PD782iG VHF; Serial: 18081600720**

Communication System: 4FSK; Frequency: 136.012 MHz; Duty Cycle: 1:2

Medium parameters used: $f = 136.012$ MHz; $\sigma = 0.81$ S/m; $\epsilon_r = 61.89$; $\rho = 1000$ kg/m³

Phantom section: Flat Section

DASY5 Configuration:

- Probe: EX3DV4 - SN7329; ConvF(12.56, 12.56, 12.56); Calibrated: 2018/1/22;
- Sensor-Surface: 1.4mm (Mechanical Surface Detection)
- Electronics: DAE4 Sn1459; Calibrated: 2017/9/15
- Phantom: ELI v8.0; Type: QDOVA004AA; Serial: 2051
- Measurement SW: DASY52, Version 52.8 (8);

Area Scan (61x151x1): Interpolated grid: dx=1.500 mm, dy=1.500 mm

Maximum value of SAR (interpolated) = 5.33 W/kg

Zoom Scan (5x5x7)/Cube 0: Measurement grid: dx=8mm, dy=8mm, dz=5mm

Reference Value = 48.02 V/m; Power Drift = -0.14 dB

Peak SAR (extrapolated) = 8.14 W/kg

SAR(1 g) = 2.68 W/kg; SAR(10 g) = 1.47 W/kg

Maximum value of SAR (measured) = 5.15 W/kg

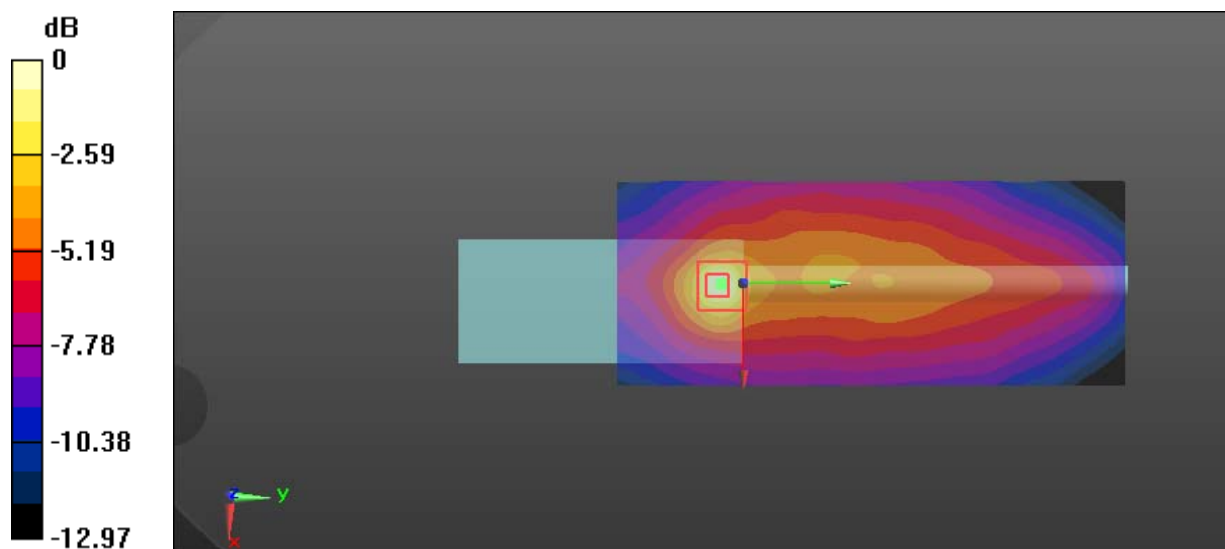

0 dB = 5.15 W/kg = 7.12 dBW/kg

Test Plot 13#: Antenna 1_PTT_FM 12.5kHz_Body Back_136.0125 MHz**DUT: Digital Portable Radio; Type: PD752iG VHF; Serial: 18081600721**

Communication System:FM; Frequency: 136.012 MHz;Duty Cycle: 1:1

Medium parameters used: $f = 136.012$ MHz; $\sigma = 0.81$ S/m; $\epsilon_r = 61.89$; $\rho = 1000$ kg/m³

Phantom section: Flat Section

DASY5 Configuration:

- Probe: EX3DV4 - SN7329; ConvF(12.56, 12.56, 12.56); Calibrated: 2018/1/22;
- Sensor-Surface: 1.4mm (Mechanical Surface Detection)
- Electronics: DAE4 Sn1459; Calibrated: 2017/9/15
- Phantom: ELI v8.0; Type: QDOVA004AA; Serial: 2051
- Measurement SW: DASY52, Version 52.8 (8);

Area Scan (61x151x1): Interpolated grid: dx=1.500 mm, dy=1.500 mm

Maximum value of SAR (interpolated) = 10.3 W/kg

Zoom Scan (5x5x7)/Cube 0: Measurement grid: dx=8mm, dy=8mm, dz=5mm

Reference Value = 67.98 V/m; Power Drift = 0.04 dB

Peak SAR (extrapolated) = 16.6 W/kg

SAR(1 g) = 5.75 W/kg; SAR(10 g) = 3.18 W/kg

Maximum value of SAR (measured) = 10.4 W/kg

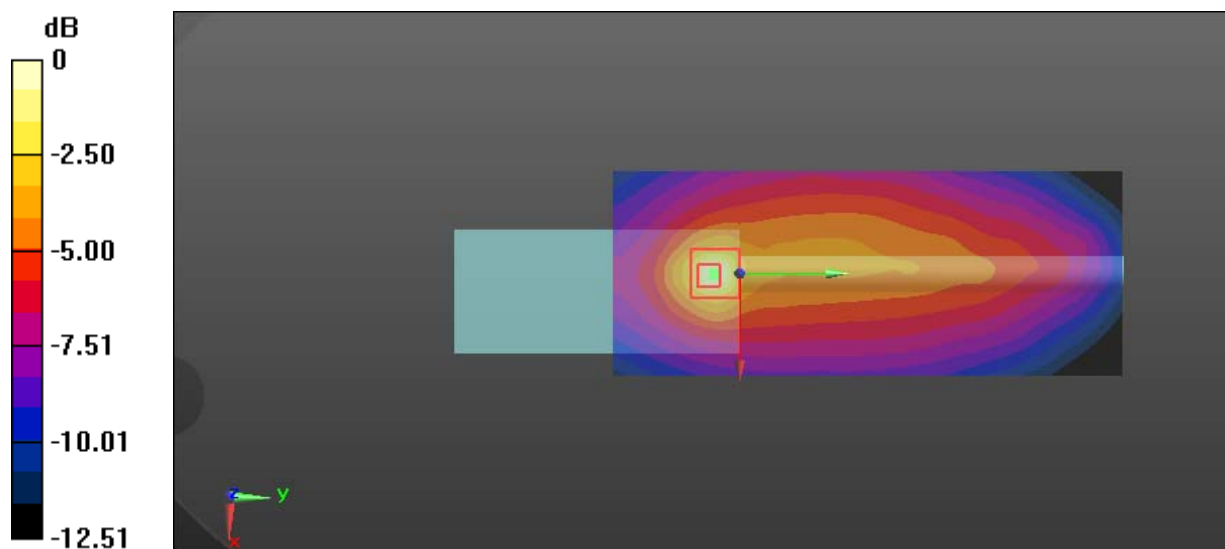

0 dB = 10.4 W/kg = 10.17 dBW/kg

Test Plot 14#: Antenna 1_PTT_FM 12.5kHz_Body Back_136.0125 MHz**DUT: Digital Portable Radio; Type: PD702iG VHF; Serial: 18081600722**

Communication System:FM; Frequency: 136.012 MHz;Duty Cycle: 1:1

Medium parameters used: $f = 136.012$ MHz; $\sigma = 0.81$ S/m; $\epsilon_r = 61.89$; $\rho = 1000$ kg/m³

Phantom section: Flat Section

DASY5 Configuration:

- Probe: EX3DV4 - SN7329; ConvF(12.56, 12.56, 12.56); Calibrated: 2018/1/22;
- Sensor-Surface: 1.4mm (Mechanical Surface Detection)
- Electronics: DAE4 Sn1459; Calibrated: 2017/9/15
- Phantom: ELI v8.0; Type: QDOVA004AA; Serial: 2051
- Measurement SW: DASY52, Version 52.8 (8);

Area Scan (61x151x1): Interpolated grid: dx=1.500 mm, dy=1.500 mm

Maximum value of SAR (interpolated) = 10.5 W/kg

Zoom Scan (5x5x7)/Cube 0: Measurement grid: dx=8mm, dy=8mm, dz=5mm

Reference Value = 67.42 V/m; Power Drift = -0.01 dB

Peak SAR (extrapolated) = 18.0 W/kg

SAR(1 g) = 5.77 W/kg; SAR(10 g) = 3.15 W/kg

Maximum value of SAR (measured) = 11.0 W/kg

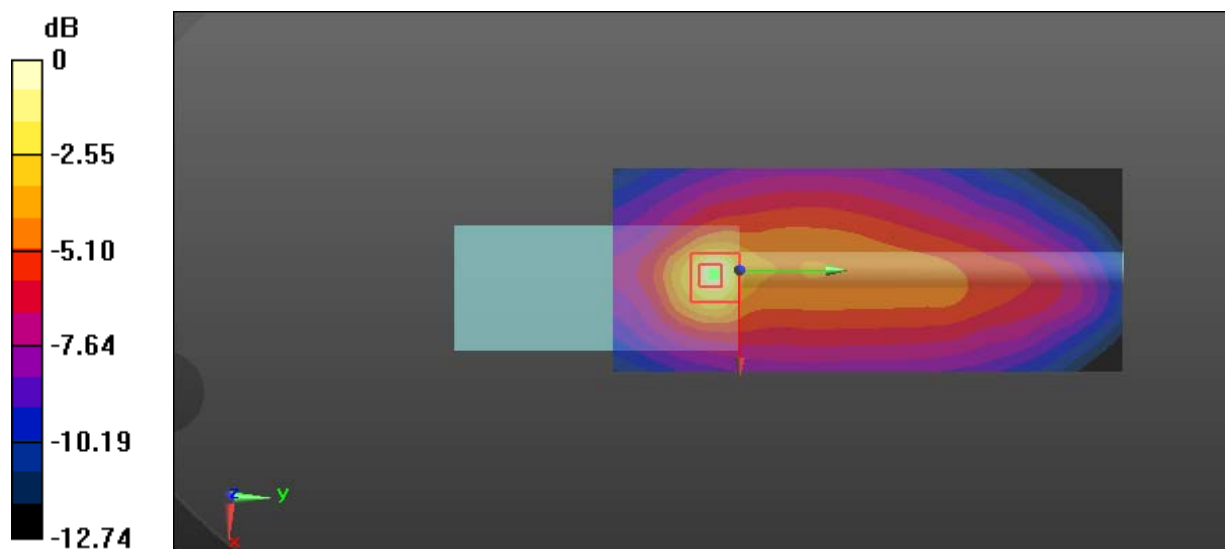

0 dB = 11.0 W/kg = 10.41 dBW/kg

Test Plot 15#: Antenna 2_PTT_FM 12.5kHz_Face Up_147.0125 MHz**DUT: Digital Portable Radio; Type: PD782iG VHF; Serial: 18081600720**

Communication System:FM; Frequency: 147.012 MHz;Duty Cycle: 1:1

Medium parameters used: $f = 147.012$ MHz; $\sigma = 0.757$ S/m; $\epsilon_r = 51.828$; $\rho = 1000$ kg/m³

Phantom section: Flat Section

DASY5 Configuration:

- Probe: EX3DV4 - SN7329; ConvF(12.88, 12.88, 12.88); Calibrated: 2018/1/22;
- Sensor-Surface: 1.4mm (Mechanical Surface Detection)
- Electronics: DAE4 Sn1459; Calibrated: 2017/9/15
- Phantom: ELI v8.0; Type: QDOVA004AA; Serial: 2051
- Measurement SW: DASY52, Version 52.8 (8);

Area Scan (61x151x1): Interpolated grid: dx=1.500 mm, dy=1.500 mm

Maximum value of SAR (interpolated) = 3.55 W/kg

Zoom Scan (5x5x7)/Cube 0: Measurement grid: dx=8mm, dy=8mm, dz=5mm

Reference Value = 58.30 V/m; Power Drift = -0.14 dB

Peak SAR (extrapolated) = 4.15 W/kg

SAR(1 g) = 2.64 W/kg; SAR(10 g) = 2.01 W/kg

Maximum value of SAR (measured) = 3.45 W/kg

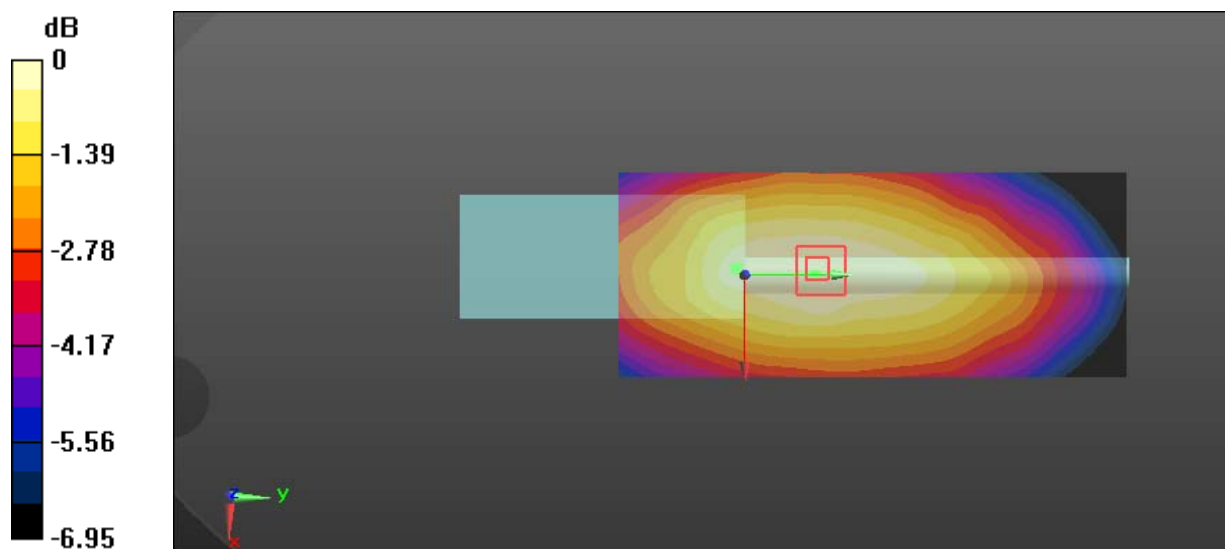

0 dB = 3.45 W/kg = 5.38 dBW/kg

Test Plot 16#: Antenna 2_PTT_FM 12.5kHz_ Face Up _154 MHz**DUT: Digital Portable Radio; Type: PD782iG VHF; Serial: 18081600720**

Communication System:FM; Frequency: 154 MHz;Duty Cycle: 1:1

Medium parameters used: $f = 154$ MHz; $\sigma = 0.754$ S/m; $\epsilon_r = 51.016$; $\rho = 1000$ kg/m³

Phantom section: Flat Section

DASY5 Configuration:

- Probe: EX3DV4 - SN7329; ConvF(12.88, 12.88, 12.88); Calibrated: 2018/1/22;
- Sensor-Surface: 1.4mm (Mechanical Surface Detection)
- Electronics: DAE4 Sn1459; Calibrated: 2017/9/15
- Phantom: ELI v8.0; Type: QDOVA004AA; Serial: 2051
- Measurement SW: DASY52, Version 52.8 (8);

Area Scan (61x151x1): Interpolated grid: dx=1.500 mm, dy=1.500 mm

Maximum value of SAR (interpolated) = 2.10 W/kg

Zoom Scan (5x6x7)/Cube 0: Measurement grid: dx=8mm, dy=8mm, dz=5mm

Reference Value = 33.84 V/m; Power Drift = -0.19 dB

Peak SAR (extrapolated) = 2.60 W/kg

SAR(1 g) = 1.67 W/kg; SAR(10 g) = 1.28 W/kg

Maximum value of SAR (measured) = 2.17 W/kg

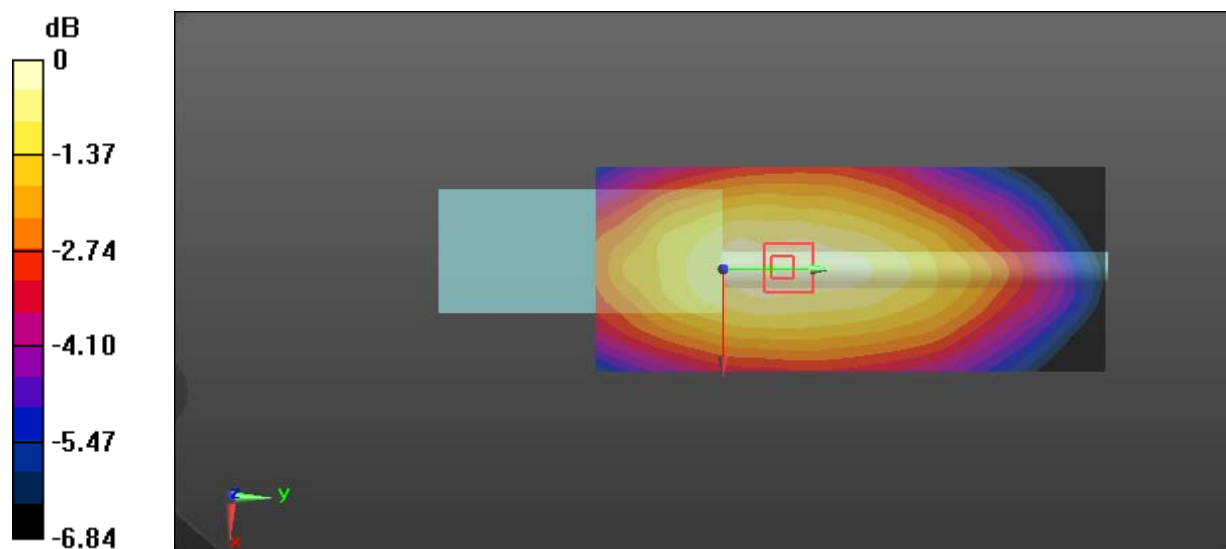

0 dB = 2.17 W/kg = 3.36 dBW/kg

Test Plot 17#: Antenna 2_PTT_FM 12.5kHz_Face Up_159.9875 MHz**DUT: Digital Portable Radio; Type: PD782iG VHF; Serial: 18081600720**

Communication System:FM; Frequency: 159.988 MHz;Duty Cycle: 1:1

Medium parameters used: $f = 159.988$ MHz; $\sigma = 0.79$ S/m; $\epsilon_r = 51.241$; $\rho = 1000$ kg/m³

Phantom section: Flat Section

DASY5 Configuration:

- Probe: EX3DV4 - SN7329; ConvF(12.88, 12.88, 12.88); Calibrated: 2018/1/22;
- Sensor-Surface: 1.4mm (Mechanical Surface Detection)
- Electronics: DAE4 Sn1459; Calibrated: 2017/9/15
- Phantom: ELI v8.0; Type: QDOVA004AA; Serial: 2051
- Measurement SW: DASY52, Version 52.8 (8);

Area Scan (61x151x1): Interpolated grid: dx=1.500 mm, dy=1.500 mm

Maximum value of SAR (interpolated) = 2.41 W/kg

Zoom Scan (5x7x7)/Cube 0: Measurement grid: dx=8mm, dy=8mm, dz=5mm

Reference Value = 46.07 V/m; Power Drift = 0.00 dB

Peak SAR (extrapolated) = 2.95 W/kg

SAR(1 g) = 1.93 W/kg; SAR(10 g) = 1.48 W/kg

Maximum value of SAR (measured) = 2.50 W/kg

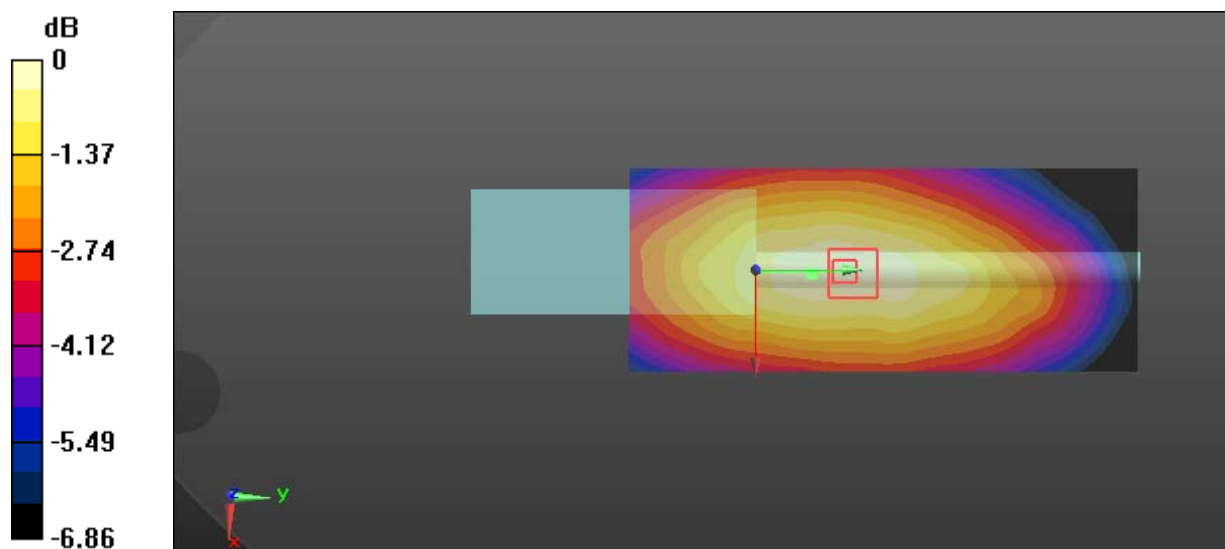

0 dB = 2.50 W/kg = 3.98 dBW/kg

Test Plot 18#: Antenna 2_PTT_FM 25kHz_ Face Up _147.0125 MHz**DUT: Digital Portable Radio; Type: PD782iG VHF; Serial: 18081600720**

Communication System:FM; Frequency: 147.012 MHz;Duty Cycle: 1:1

Medium parameters used: $f = 147.012$ MHz; $\sigma = 0.757$ S/m; $\epsilon_r = 51.828$; $\rho = 1000$ kg/m³

Phantom section: Flat Section

DASY5 Configuration:

- Probe: EX3DV4 - SN7329; ConvF(12.88, 12.88, 12.88); Calibrated: 2018/1/22;
- Sensor-Surface: 1.4mm (Mechanical Surface Detection)
- Electronics: DAE4 Sn1459; Calibrated: 2017/9/15
- Phantom: ELI v8.0; Type: QDOVA004AA; Serial: 2051
- Measurement SW: DASY52, Version 52.8 (8);

Area Scan (61x151x1): Interpolated grid: dx=1.500 mm, dy=1.500 mm

Maximum value of SAR (interpolated) = 3.54 W/kg

Zoom Scan (5x5x7)/Cube 0: Measurement grid: dx=8mm, dy=8mm, dz=5mm

Reference Value = 53.23 V/m; Power Drift = 0.12 dB

Peak SAR (extrapolated) = 4.00 W/kg

SAR(1 g) = 2.59 W/kg; SAR(10 g) = 1.98 W/kg

Maximum value of SAR (measured) = 3.36 W/kg

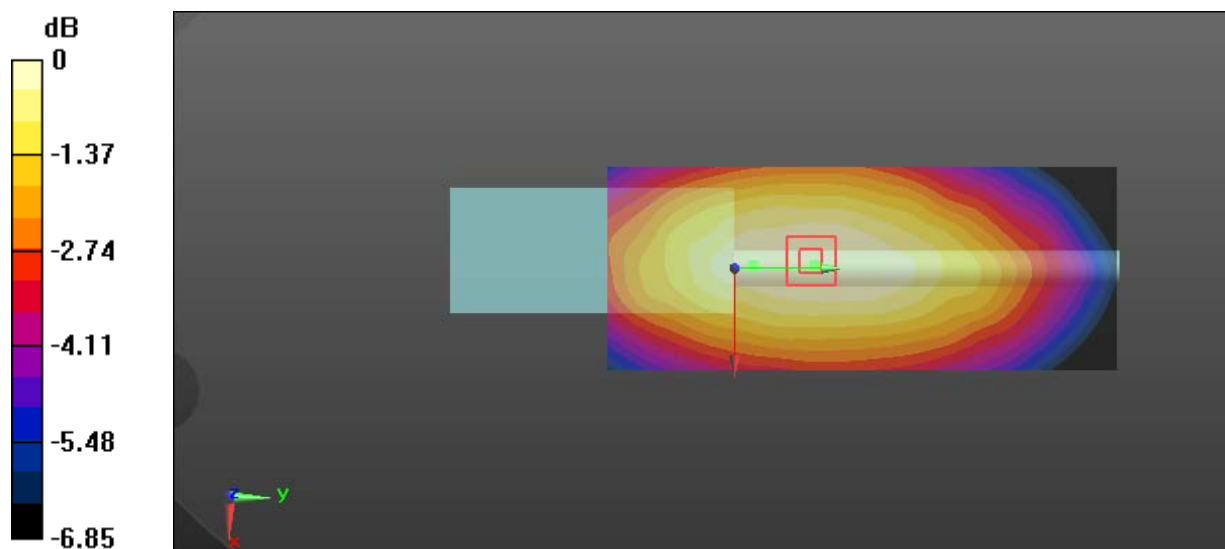

0 dB = 3.36 W/kg = 5.26 dBW/kg

Test Plot 19#: Antenna 2_PTT_4FSK 12.5kHz_ Face Up _147.0125 MHz**DUT: Digital Portable Radio; Type: PD782iG VHF; Serial: 18081600720**

Communication System: 4FSK; Frequency: 147.012 MHz; Duty Cycle: 1:2

Medium parameters used: $f = 147.012$ MHz; $\sigma = 0.757$ S/m; $\epsilon_r = 51.828$; $\rho = 1000$ kg/m³

Phantom section: Flat Section

DASY5 Configuration:

- Probe: EX3DV4 - SN7329; ConvF(12.88, 12.88, 12.88); Calibrated: 2018/1/22;
- Sensor-Surface: 1.4mm (Mechanical Surface Detection)
- Electronics: DAE4 Sn1459; Calibrated: 2017/9/15
- Phantom: ELI v8.0; Type: QDOVA004AA; Serial: 2051
- Measurement SW: DASY52, Version 52.8 (8);

Area Scan (61x151x1): Interpolated grid: dx=1.500 mm, dy=1.500 mm

Maximum value of SAR (interpolated) = 2.26 W/kg

Zoom Scan (5x5x7)/Cube 0: Measurement grid: dx=8mm, dy=8mm, dz=5mm

Reference Value = 44.91 V/m; Power Drift = -0.14 dB

Peak SAR (extrapolated) = 2.65 W/kg

SAR(1 g) = 1.65 W/kg; SAR(10 g) = 1.25 W/kg

Maximum value of SAR (measured) = 2.19 W/kg

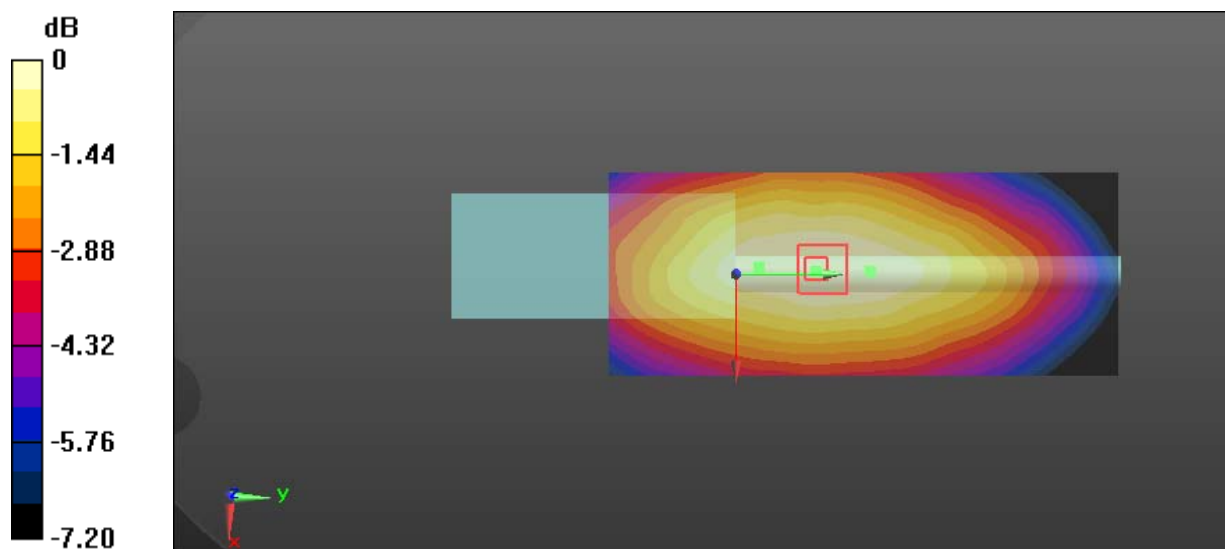

0 dB = 2.19 W/kg = 3.40 dBW/kg

Test Plot 20#: Antenna 2_PTT_FM 12.5kHz_Face Up_147.0125 MHz**DUT: Digital Portable Radio; Type: PD752iG VHF; Serial: 18081600721**

Communication System:FM; Frequency: 147.012 MHz;Duty Cycle: 1:1

Medium parameters used: $f = 147.012$ MHz; $\sigma = 0.757$ S/m; $\epsilon_r = 51.828$; $\rho = 1000$ kg/m³

Phantom section: Flat Section

DASY5 Configuration:

- Probe: EX3DV4 - SN7329; ConvF(12.88, 12.88, 12.88); Calibrated: 2018/1/22;
- Sensor-Surface: 1.4mm (Mechanical Surface Detection)
- Electronics: DAE4 Sn1459; Calibrated: 2017/9/15
- Phantom: ELI v8.0; Type: QDOVA004AA; Serial: 2051
- Measurement SW: DASY52, Version 52.8 (8);

Area Scan (61x151x1): Interpolated grid: dx=1.500 mm, dy=1.500 mm

Maximum value of SAR (interpolated) = 3.45 W/kg

Zoom Scan (6x6x7)/Cube 0: Measurement grid: dx=8mm, dy=8mm, dz=5mm

Reference Value = 56.29 V/m; Power Drift = -0.16 dB

Peak SAR (extrapolated) = 3.96 W/kg

SAR(1 g) = 2.56 W/kg; SAR(10 g) = 1.97 W/kg

Maximum value of SAR (measured) = 3.32 W/kg

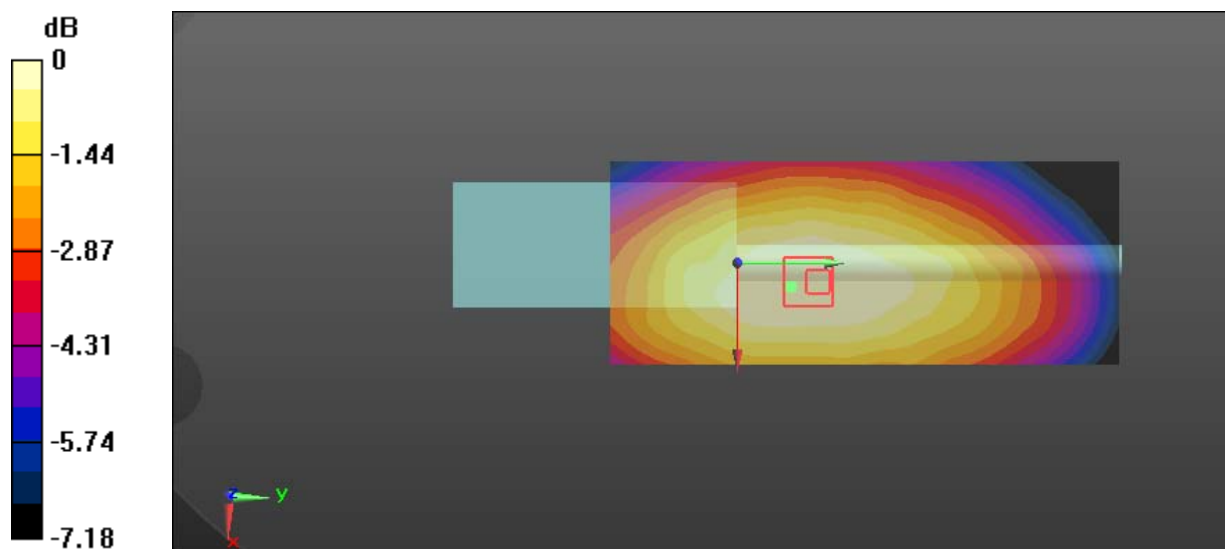

0 dB = 3.32 W/kg = 5.21 dBW/kg

Test Plot 21#: Antenna 2_PTT_FM 12.5kHz_ Face Up _147.0125 MHz**DUT: Digital Portable Radio; Type: PD702iG VHF; Serial: 18081600722**

Communication System:FM; Frequency: 147.012 MHz;Duty Cycle: 1:1

Medium parameters used: $f = 147.012$ MHz; $\sigma = 0.757$ S/m; $\epsilon_r = 51.828$; $\rho = 1000$ kg/m³

Phantom section: Flat Section

DASY5 Configuration:

- Probe: EX3DV4 - SN7329; ConvF(12.88, 12.88, 12.88); Calibrated: 2018/1/22;
- Sensor-Surface: 1.4mm (Mechanical Surface Detection)
- Electronics: DAE4 Sn1459; Calibrated: 2017/9/15
- Phantom: ELI v8.0; Type: QDOVA004AA; Serial: 2051
- Measurement SW: DASY52, Version 52.8 (8);

Area Scan (61x151x1): Interpolated grid: dx=1.500 mm, dy=1.500 mm

Maximum value of SAR (interpolated) = 3.16 W/kg

Zoom Scan (6x6x7)/Cube 0: Measurement grid: dx=8mm, dy=8mm, dz=5mm

Reference Value = 54.33 V/m; Power Drift = -0.12 dB

Peak SAR (extrapolated) = 3.59 W/kg

SAR(1 g) = 2.34 W/kg; SAR(10 g) = 1.8 W/kg

Maximum value of SAR (measured) = 3.03 W/kg

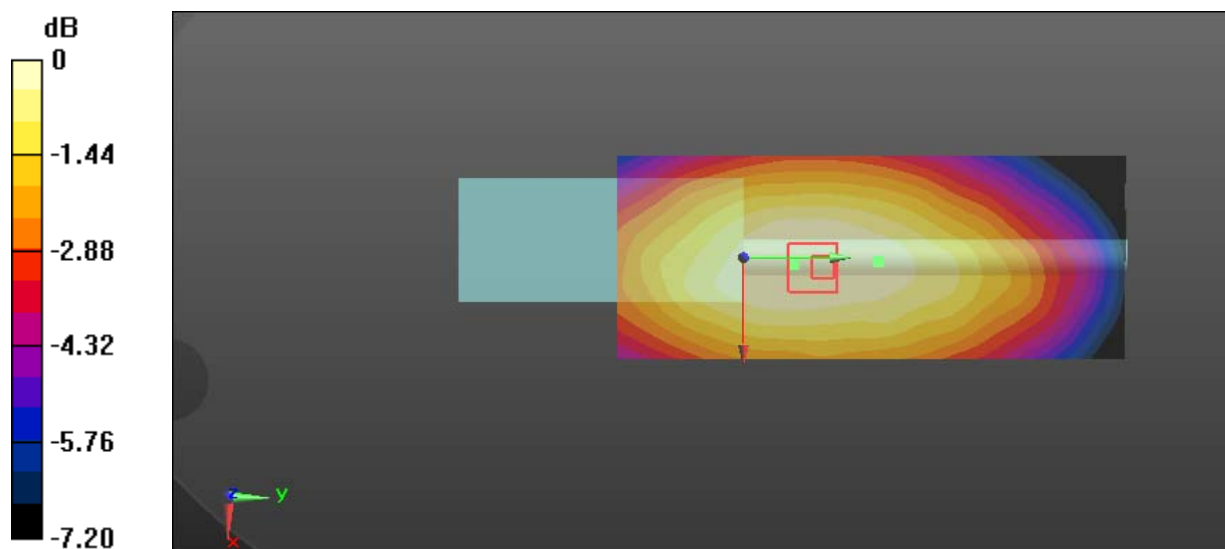

0 dB = 3.03 W/kg = 4.81 dBW/kg

Test Plot 22#: Antenna 2_PTT_FM 12.5kHz_Body Back_147.0125 MHz**DUT: Digital Portable Radio; Type: PD782iG VHF; Serial: 18081600720**

Communication System:FM; Frequency: 147.012 MHz;Duty Cycle: 1:1

Medium parameters used: $f = 147.012$ MHz; $\sigma = 0.819$ S/m; $\epsilon_r = 61.603$; $\rho = 1000$ kg/m³

Phantom section: Flat Section

DASY5 Configuration:

- Probe: EX3DV4 - SN7329; ConvF(12.56, 12.56, 12.56); Calibrated: 2018/1/22;
- Sensor-Surface: 1.4mm (Mechanical Surface Detection)
- Electronics: DAE4 Sn1459; Calibrated: 2017/9/15
- Phantom: ELI v8.0; Type: QDOVA004AA; Serial: 2051
- Measurement SW: DASY52, Version 52.8 (8);

Area Scan (61x151x1): Interpolated grid: dx=1.500 mm, dy=1.500 mm

Maximum value of SAR (interpolated) = 11.8 W/kg

Zoom Scan (5x5x7)/Cube 0: Measurement grid: dx=8mm, dy=8mm, dz=5mm

Reference Value = 76.37 V/m; Power Drift = 0.02 dB

Peak SAR (extrapolated) = 19.3 W/kg

SAR(1 g) = 6.58 W/kg; SAR(10 g) = 3.71 W/kg

Maximum value of SAR (measured) = 12.9 W/kg

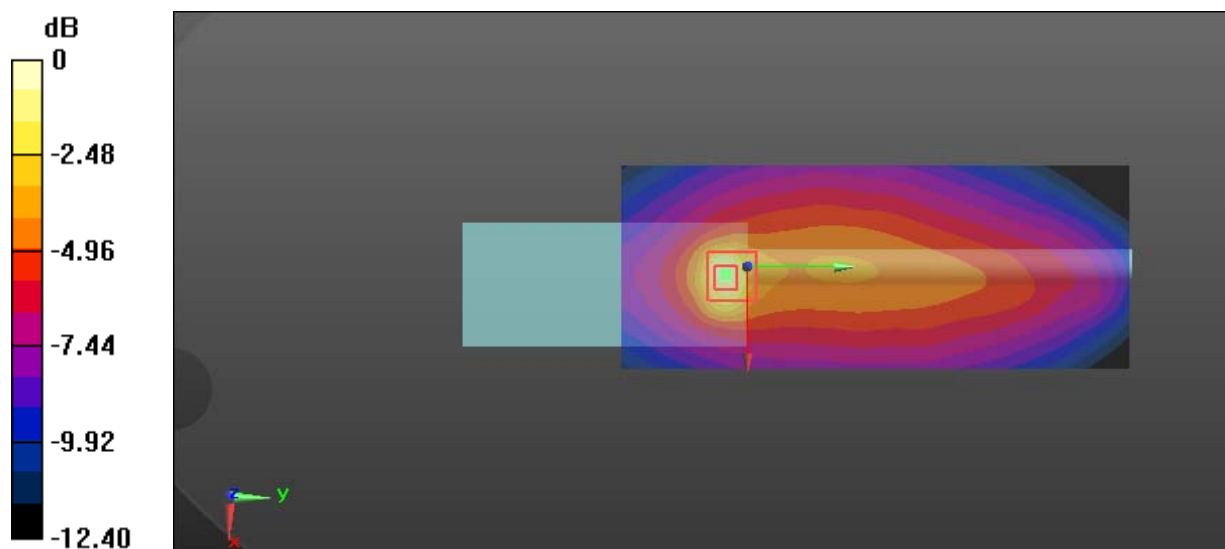

0 dB = 12.9 W/kg = 11.11 dBW/kg

Test Plot 23#: Antenna 2_PTT_FM 12.5kHz_Body Back_154 MHz**DUT: Digital Portable Radio; Type: PD782iG VHF; Serial: 18081600720**

Communication System:FM; Frequency: 154 MHz;Duty Cycle: 1:1

Medium parameters used: $f = 154$ MHz; $\sigma = 0.788$ S/m; $\epsilon_r = 61.6$; $\rho = 1000$ kg/m³

Phantom section: Flat Section

DASY5 Configuration:

- Probe: EX3DV4 - SN7329; ConvF(12.56, 12.56, 12.56); Calibrated: 2018/1/22;
- Sensor-Surface: 1.4mm (Mechanical Surface Detection)
- Electronics: DAE4 Sn1459; Calibrated: 2017/9/15
- Phantom: ELI v8.0; Type: QDOVA004AA; Serial: 2051
- Measurement SW: DASY52, Version 52.8 (8);

Area Scan (61x151x1): Interpolated grid: dx=1.500 mm, dy=1.500 mm

Maximum value of SAR (interpolated) = 8.01 W/kg

Zoom Scan (5x5x7)/Cube 0: Measurement grid: dx=8mm, dy=8mm, dz=5mm

Reference Value = 55.88 V/m; Power Drift = -0.19 dB

Peak SAR (extrapolated) = 11.4 W/kg

SAR(1 g) = 4.41 W/kg; SAR(10 g) = 2.59 W/kg

Maximum value of SAR (measured) = 7.48 W/kg

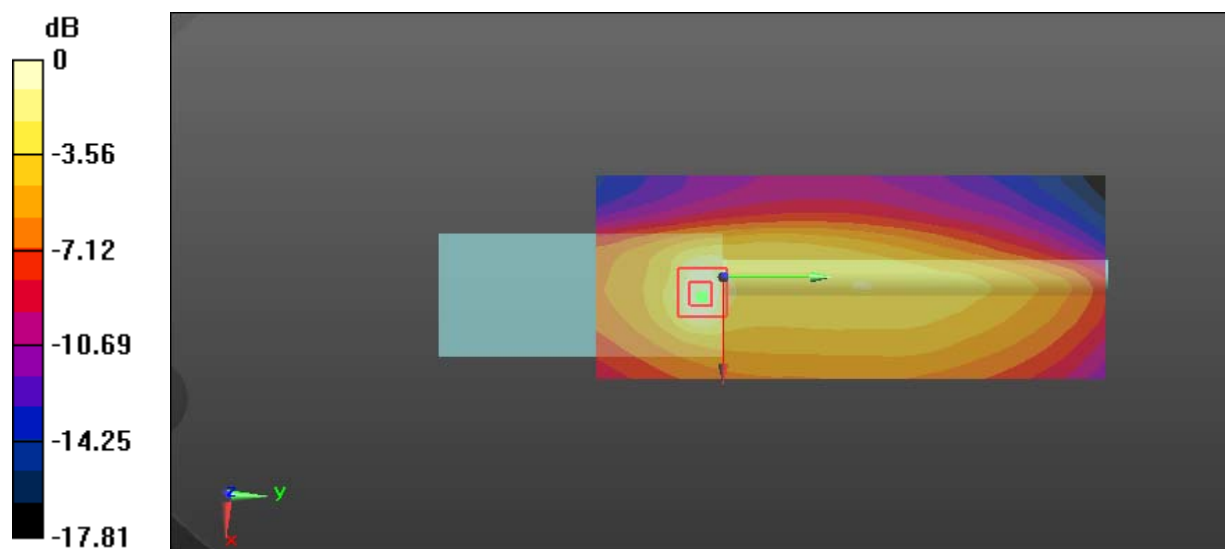

0 dB = 7.48 W/kg = 8.74 dBW/kg

Test Plot 24#: Antenna 2_PTT_FM 12.5kHz_Body Back_159.9875 MHz**DUT: Digital Portable Radio; Type: PD782iG VHF; Serial: 18081600720**

Communication System:FM; Frequency: 159.988 MHz;Duty Cycle: 1:1

Medium parameters used: $f = 159.988$ MHz; $\sigma = 0.821$ S/m; $\epsilon_r = 61.226$; $\rho = 1000$ kg/m³

Phantom section: Flat Section

DASY5 Configuration:

- Probe: EX3DV4 - SN7329; ConvF(12.56, 12.56, 12.56); Calibrated: 2018/1/22;
- Sensor-Surface: 1.4mm (Mechanical Surface Detection)
- Electronics: DAE4 Sn1459; Calibrated: 2017/9/15
- Phantom: ELI v8.0; Type: QDOVA004AA; Serial: 2051
- Measurement SW: DASY52, Version 52.8 (8);

Area Scan (61x151x1): Interpolated grid: dx=1.500 mm, dy=1.500 mm

Maximum value of SAR (interpolated) = 5.38 W/kg

Zoom Scan (6x6x7)/Cube 0: Measurement grid: dx=8mm, dy=8mm, dz=5mm

Reference Value = 43.61 V/m; Power Drift = -0.15 dB

Peak SAR (extrapolated) = 8.53 W/kg

SAR(1 g) = 3.18 W/kg; SAR(10 g) = 1.90 W/kg

Maximum value of SAR (measured) = 5.82 W/kg

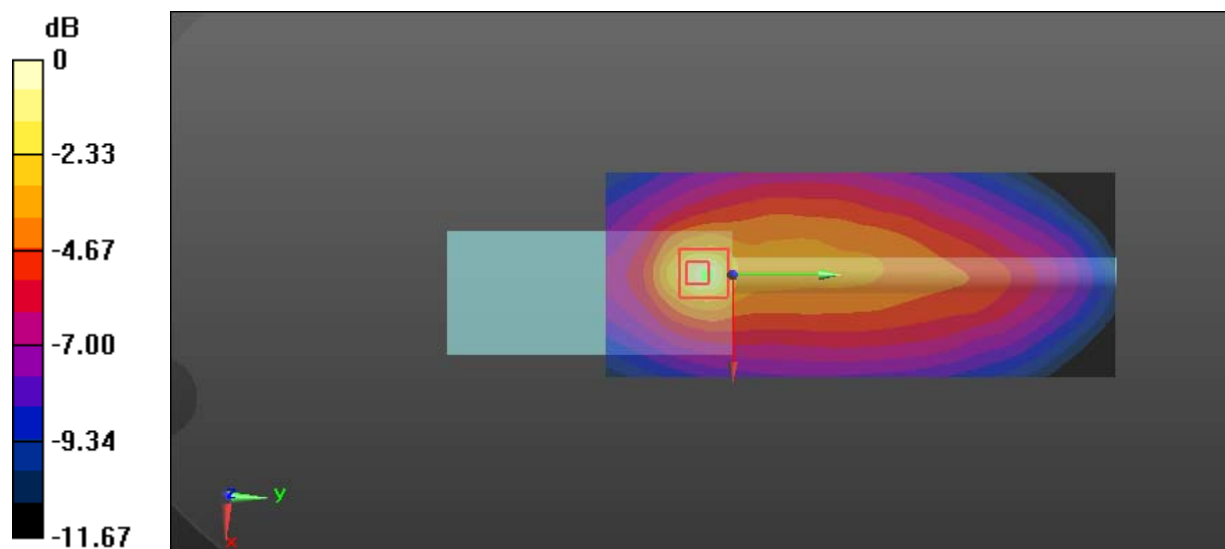

0 dB = 5.82 W/kg = 7.65 dBW/kg

Test Plot 25#: Antenna 2_PTT_FM 25kHz_Body Back_147.0125 MHz**DUT: Digital Portable Radio; Type: PD782iG VHF; Serial: 18081600720**

Communication System:FM; Frequency: 147.012 MHz;Duty Cycle: 1:1

Medium parameters used: $f = 147.012$ MHz; $\sigma = 0.819$ S/m; $\epsilon_r = 61.603$; $\rho = 1000$ kg/m³

Phantom section: Flat Section

DASY5 Configuration:

- Probe: EX3DV4 - SN7329; ConvF(12.56, 12.56, 12.56); Calibrated: 2018/1/22;
- Sensor-Surface: 1.4mm (Mechanical Surface Detection)
- Electronics: DAE4 Sn1459; Calibrated: 2017/9/15
- Phantom: ELI v8.0; Type: QDOVA004AA; Serial: 2051
- Measurement SW: DASY52, Version 52.8 (8);

Area Scan (61x151x1): Interpolated grid: dx=1.500 mm, dy=1.500 mm

Maximum value of SAR (interpolated) = 11.8 W/kg

Zoom Scan (5x5x7)/Cube 0: Measurement grid: dx=8mm, dy=8mm, dz=5mm

Reference Value = 76.93 V/m; Power Drift = 0.03 dB

Peak SAR (extrapolated) = 17.9 W/kg

SAR(1 g) = 6.56 W/kg; SAR(10 g) = 3.75 W/kg

Maximum value of SAR (measured) = 12.0 W/kg

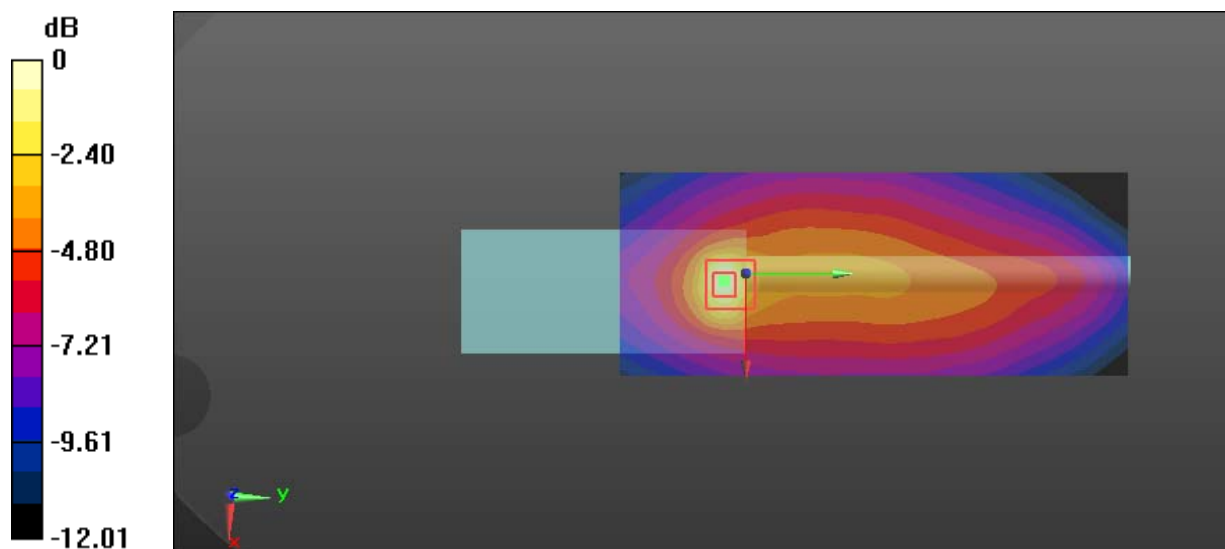

0 dB = 12.0 W/kg = 10.79 dBW/kg

Test Plot 26#: Antenna 2_PTT_4FSK 12.5kHz_Body Back_147.0125 MHz**DUT: Digital Portable Radio; Type: PD782iG VHF; Serial: 18081600720**

Communication System: 4FSK; Frequency: 147.012 MHz; Duty Cycle: 1:2

Medium parameters used: $f = 147.012$ MHz; $\sigma = 0.819$ S/m; $\epsilon_r = 61.603$; $\rho = 1000$ kg/m³

Phantom section: Flat Section

DASY5 Configuration:

- Probe: EX3DV4 - SN7329; ConvF(12.56, 12.56, 12.56); Calibrated: 2018/1/22;
- Sensor-Surface: 1.4mm (Mechanical Surface Detection)
- Electronics: DAE4 Sn1459; Calibrated: 2017/9/15
- Phantom: ELI v8.0; Type: QDOVA004AA; Serial: 2051
- Measurement SW: DASY52, Version 52.8 (8);

Area Scan (61x151x1): Interpolated grid: dx=1.500 mm, dy=1.500 mm

Maximum value of SAR (interpolated) = 4.47 W/kg

Zoom Scan (5x5x7)/Cube 0: Measurement grid: dx=8mm, dy=8mm, dz=5mm

Reference Value = 52.03 V/m; Power Drift = -0.10 dB

Peak SAR (extrapolated) = 7.48 W/kg

SAR(1 g) = 2.77 W/kg; SAR(10 g) = 1.61 W/kg

Maximum value of SAR (measured) = 5.07 W/kg

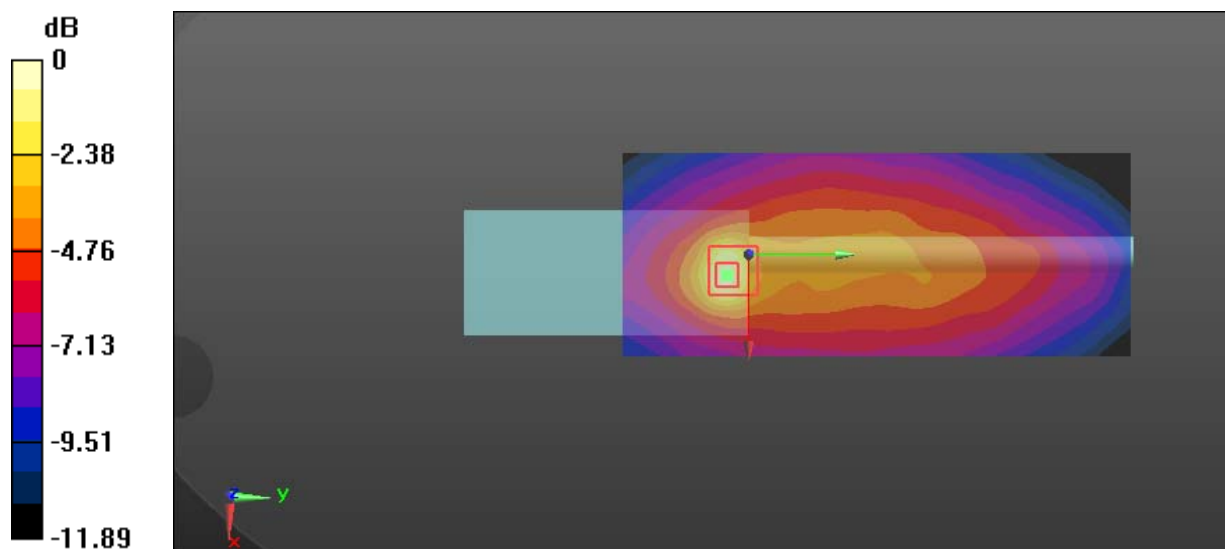

0 dB = 5.07 W/kg = 7.05 dBW/kg

Test Plot 27#: Antenna 2_PTT_FM 12.5kHz_Body Back_147.0125 MHz**DUT: Digital Portable Radio; Type: PD752iG VHF; Serial: 18081600721**

Communication System:FM; Frequency: 147.012 MHz;Duty Cycle: 1:1

Medium parameters used: $f = 147.012$ MHz; $\sigma = 0.819$ S/m; $\epsilon_r = 61.603$; $\rho = 1000$ kg/m³

Phantom section: Flat Section

DASY5 Configuration:

- Probe: EX3DV4 - SN7329; ConvF(12.56, 12.56, 12.56); Calibrated: 2018/1/22;
- Sensor-Surface: 1.4mm (Mechanical Surface Detection)
- Electronics: DAE4 Sn1459; Calibrated: 2017/9/15
- Phantom: ELI v8.0; Type: QDOVA004AA; Serial: 2051
- Measurement SW: DASY52, Version 52.8 (8);

Area Scan (61x151x1): Interpolated grid: dx=1.500 mm, dy=1.500 mm

Maximum value of SAR (interpolated) = 9.14 W/kg

Zoom Scan (5x5x7)/Cube 0: Measurement grid: dx=8mm, dy=8mm, dz=5mm

Reference Value = 68.96 V/m; Power Drift = -0.09 dB

Peak SAR (extrapolated) = 14.9 W/kg

SAR(1 g) = 5.56 W/kg; SAR(10 g) = 3.24 W/kg

Maximum value of SAR (measured) = 10.2 W/kg

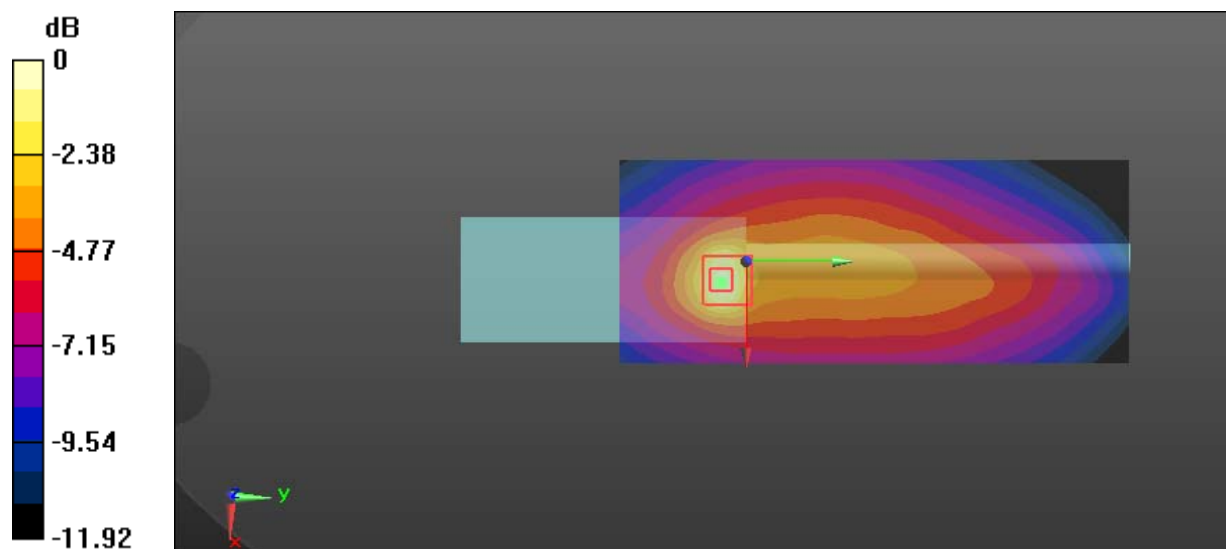

0 dB = 10.2 W/kg = 10.09 dBW/kg

Test Plot 28#: Antenna 2_PTT_FM 12.5kHz_Body Back_147.0125 MHz**DUT: Digital Portable Radio; Type: PD702iG VHF; Serial: 18081600722**

Communication System:FM; Frequency: 147.012 MHz;Duty Cycle: 1:1

Medium parameters used: $f = 147.012$ MHz; $\sigma = 0.819$ S/m; $\epsilon_r = 61.603$; $\rho = 1000$ kg/m³

Phantom section: Flat Section

DASY5 Configuration:

- Probe: EX3DV4 - SN7329; ConvF(12.56, 12.56, 12.56); Calibrated: 2018/1/22;
- Sensor-Surface: 1.4mm (Mechanical Surface Detection)
- Electronics: DAE4 Sn1459; Calibrated: 2017/9/15
- Phantom: ELI v8.0; Type: QDOVA004AA; Serial: 2051
- Measurement SW: DASY52, Version 52.8 (8);

Area Scan (61x151x1): Interpolated grid: dx=1.500 mm, dy=1.500 mm

Maximum value of SAR (interpolated) = 7.69 W/kg

Zoom Scan (5x5x7)/Cube 0: Measurement grid: dx=8mm, dy=8mm, dz=5mm

Reference Value = 62.53 V/m; Power Drift = -0.01 dB

Peak SAR (extrapolated) = 12.1 W/kg

SAR(1 g) = 4.68 W/kg; SAR(10 g) = 2.78 W/kg

Maximum value of SAR (measured) = 7.99 W/kg

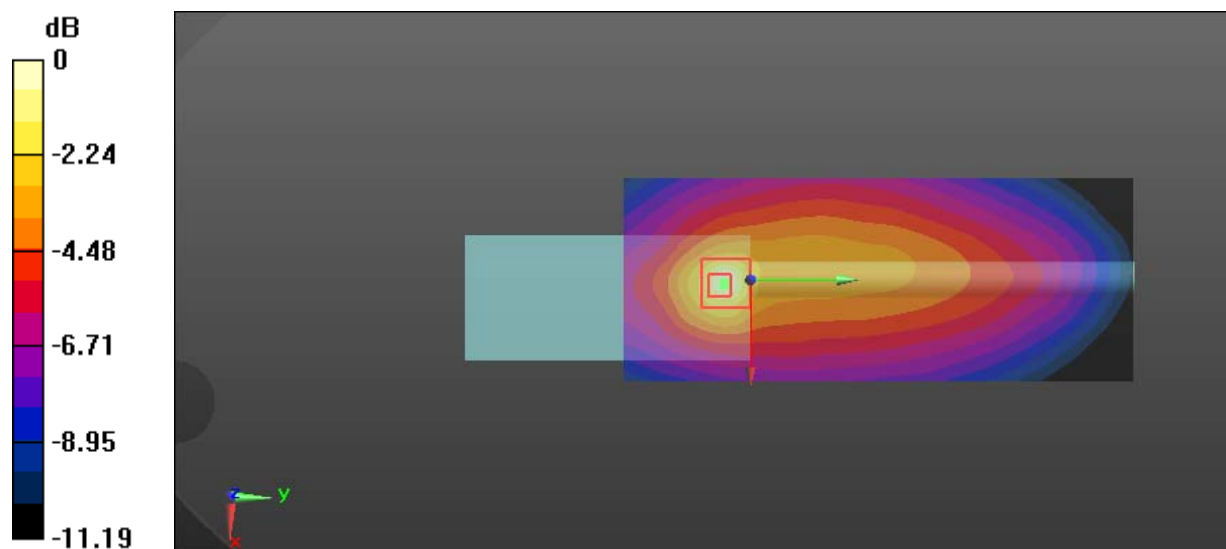

0 dB = 7.99 W/kg = 9.03 dBW/kg

Test Plot 29#: Antenna 3_PTT_FM 12.5kHz_Face Up_160.0125 MHz**DUT: Digital Portable Radio; Type: PD782iG VHF; Serial: 18081600720**

Communication System:FM; Frequency: 160.012 MHz;Duty Cycle: 1:1

Medium parameters used: $f = 160.012$ MHz; $\sigma = 0.752$ S/m; $\epsilon_r = 51.243$; $\rho = 1000$ kg/m³

Phantom section: Flat Section

DASY5 Configuration:

- Probe: EX3DV4 - SN7329; ConvF(12.88, 12.88, 12.88); Calibrated: 2018/1/22;
- Sensor-Surface: 1.4mm (Mechanical Surface Detection)
- Electronics: DAE4 Sn1459; Calibrated: 2017/9/15
- Phantom: ELI v8.0; Type: QDOVA004AA; Serial: 2051
- Measurement SW: DASY52, Version 52.8 (8);

Area Scan (61x151x1): Interpolated grid: dx=1.500 mm, dy=1.500 mm

Maximum value of SAR (interpolated) = 4.11 W/kg

Zoom Scan (5x5x7)/Cube 0: Measurement grid: dx=8mm, dy=8mm, dz=5mm

Reference Value = 63.42 V/m; Power Drift = -0.07 dB

Peak SAR (extrapolated) = 4.72 W/kg

SAR(1 g) = 3.06 W/kg; SAR(10 g) = 2.34 W/kg

Maximum value of SAR (measured) = 3.96 W/kg

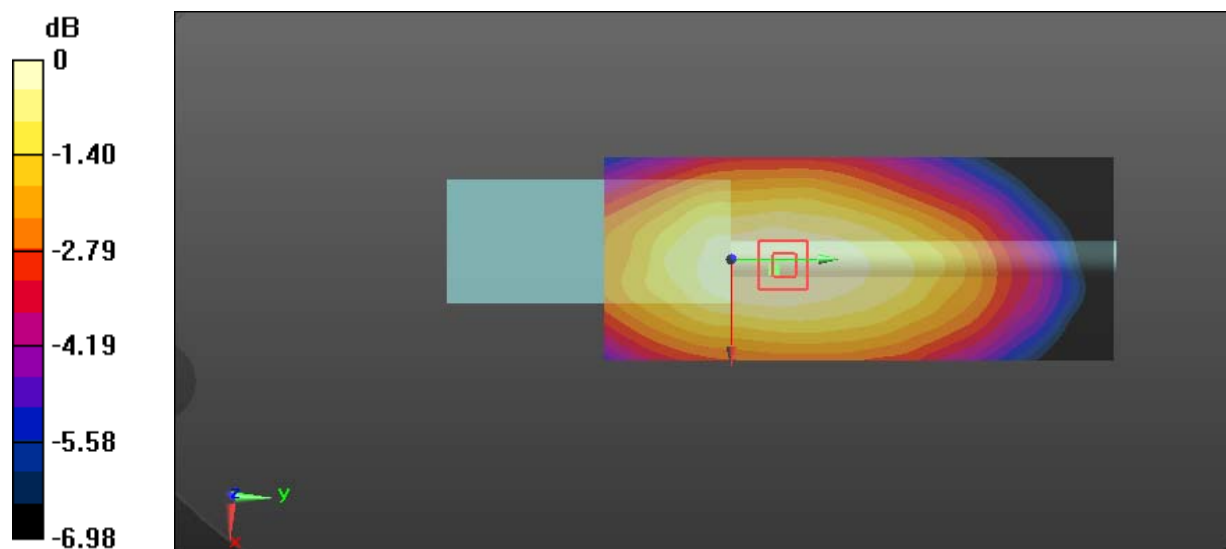

0 dB = 3.96 W/kg = 5.98 dBW/kg

Test Plot 30#: Antenna 3_PTT_FM 12.5kHz_Face Up_167 MHz**DUT: Digital Portable Radio; Type: PD782iG VHF; Serial: 18081600720**

Communication System: FM; Frequency: 167 MHz; Duty Cycle: 1:1

Medium parameters used: $f = 167$ MHz; $\sigma = 0.792$ S/m; $\epsilon_r = 50.381$; $\rho = 1000$ kg/m³

Phantom section: Flat Section

DASY5 Configuration:

- Probe: EX3DV4 - SN7329; ConvF(12.88, 12.88, 12.88); Calibrated: 2018/1/22;
- Sensor-Surface: 1.4mm (Mechanical Surface Detection)
- Electronics: DAE4 Sn1459; Calibrated: 2017/9/15
- Phantom: ELI v8.0; Type: QDOVA004AA; Serial: 2051
- Measurement SW: DASY52, Version 52.8 (8);

Area Scan (61x151x1): Interpolated grid: dx=1.500 mm, dy=1.500 mm

Maximum value of SAR (interpolated) = 2.71 W/kg

Zoom Scan (5x5x7)/Cube 0: Measurement grid: dx=8mm, dy=8mm, dz=5mm

Reference Value = 49.13 V/m; Power Drift = 0.14 dB

Peak SAR (extrapolated) = 3.21 W/kg

SAR(1 g) = 2.07 W/kg; SAR(10 g) = 1.57 W/kg

Maximum value of SAR (measured) = 2.71 W/kg

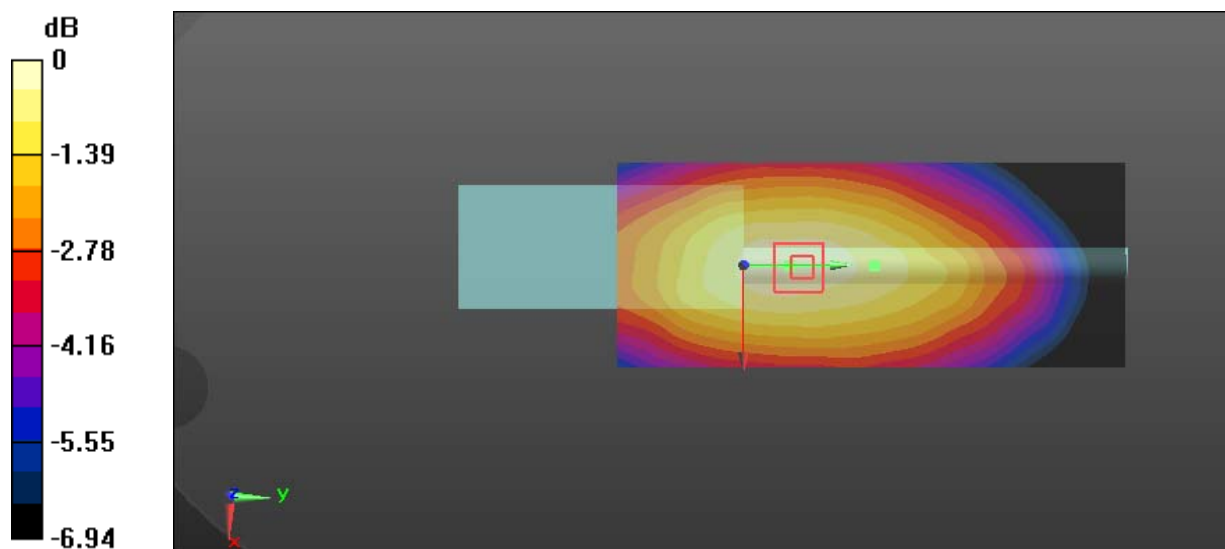

0 dB = 2.71 W/kg = 4.33 dBW/kg

Test Plot 31#: Antenna 3_PTT_FM 12.5kHz_Face Up_173.9875 MHz**DUT: Digital Portable Radio; Type: PD782iG VHF; Serial: 18081600720**

Communication System:FM; Frequency: 173.988 MHz;Duty Cycle: 1:1

Medium parameters used: $f = 173.988$ MHz; $\sigma = 0.793$ S/m; $\epsilon_r = 50.341$; $\rho = 1000$ kg/m³

Phantom section: Flat Section

DASY5 Configuration:

- Probe: EX3DV4 - SN7329; ConvF(12.88, 12.88, 12.88); Calibrated: 2018/1/22;
- Sensor-Surface: 1.4mm (Mechanical Surface Detection)
- Electronics: DAE4 Sn1459; Calibrated: 2017/9/15
- Phantom: ELI v8.0; Type: QDOVA004AA; Serial: 2051
- Measurement SW: DASY52, Version 52.8 (8);

Area Scan (61x151x1): Interpolated grid: dx=1.500 mm, dy=1.500 mm

Maximum value of SAR (interpolated) = 2.68 W/kg

Zoom Scan (6x6x7)/Cube 0: Measurement grid: dx=8mm, dy=8mm, dz=5mm

Reference Value = 47.69 V/m; Power Drift = -0.14 dB

Peak SAR (extrapolated) = 2.75 W/kg

SAR(1 g) = 1.77 W/kg; SAR(10 g) = 1.35 W/kg

Maximum value of SAR (measured) = 2.30 W/kg

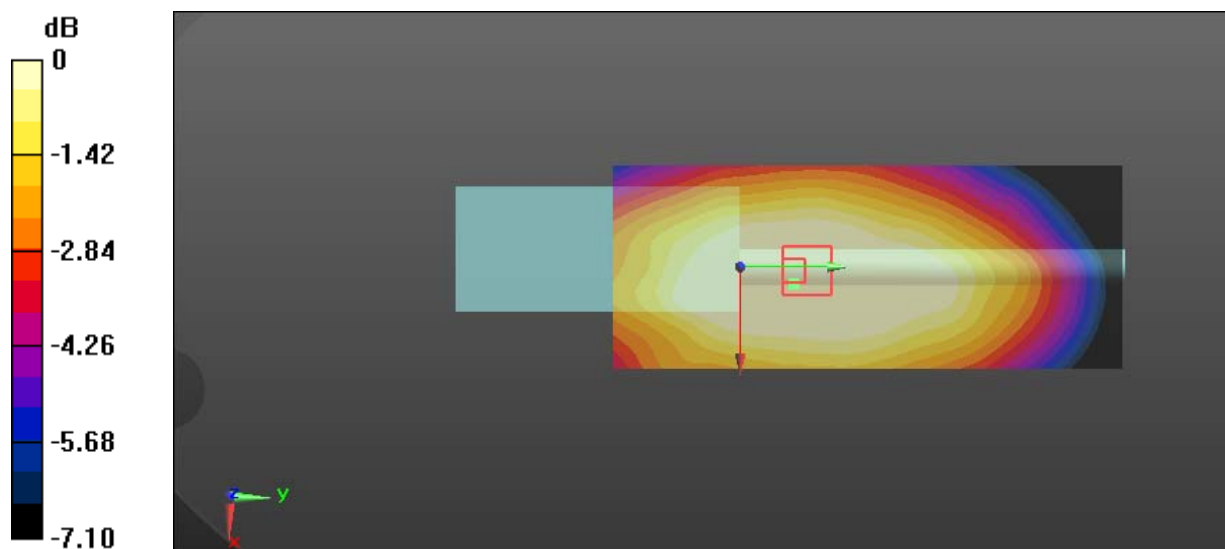

0 dB = 2.30 W/kg = 3.62 dBW/kg

Test Plot 32#: Antenna 3_PTT_FM 25kHz_Face Up_160.0125 MHz**DUT: Digital Portable Radio; Type: PD782iG VHF; Serial: 18081600720**

Communication System:FM; Frequency: 160.012 MHz;Duty Cycle: 1:1

Medium parameters used: $f = 160.012$ MHz; $\sigma = 0.752$ S/m; $\epsilon_r = 51.243$; $\rho = 1000$ kg/m³

Phantom section: Flat Section

DASY5 Configuration:

- Probe: EX3DV4 - SN7329; ConvF(12.88, 12.88, 12.88); Calibrated: 2018/1/22;
- Sensor-Surface: 1.4mm (Mechanical Surface Detection)
- Electronics: DAE4 Sn1459; Calibrated: 2017/9/15
- Phantom: ELI v8.0; Type: QDOVA004AA; Serial: 2051
- Measurement SW: DASY52, Version 52.8 (8);

Area Scan (61x151x1): Interpolated grid: dx=1.500 mm, dy=1.500 mm

Maximum value of SAR (interpolated) = 3.89 W/kg

Zoom Scan (5x6x7)/Cube 0: Measurement grid: dx=8mm, dy=8mm, dz=5mm

Reference Value = 60.97 V/m; Power Drift = -0.15 dB

Peak SAR (extrapolated) = 4.36 W/kg

SAR(1 g) = 2.84 W/kg; SAR(10 g) = 2.17 W/kg

Maximum value of SAR (measured) = 3.69 W/kg

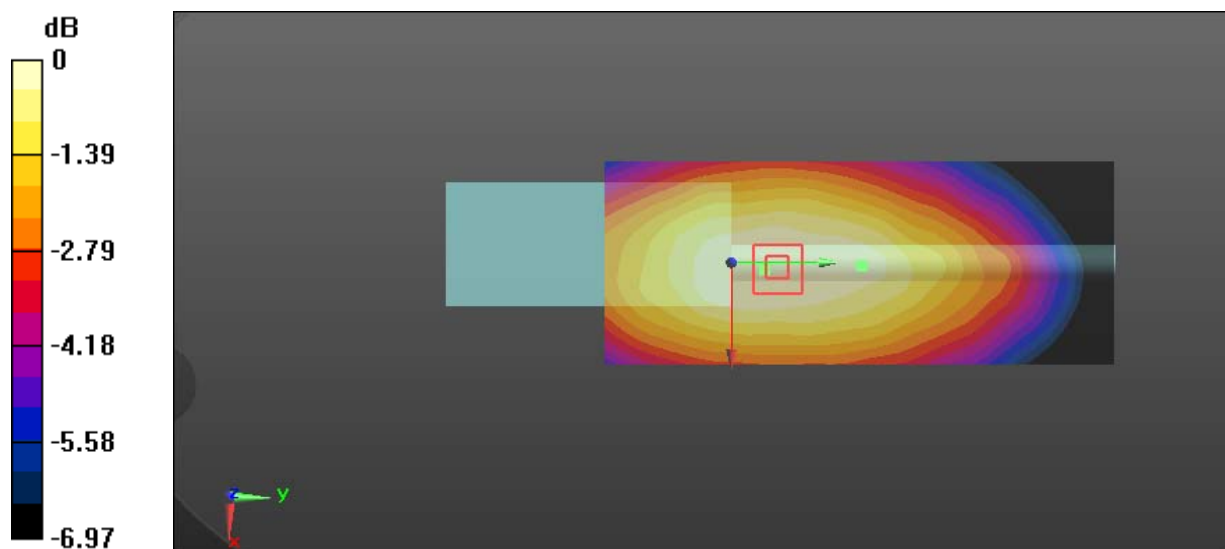

0 dB = 3.69 W/kg = 5.67 dBW/kg

Test Plot 33#: Antenna 3_PTT_4FSK 12.5kHz_Face Up_160.0125 MHz**DUT: Digital Portable Radio; Type: PD782iG VHF; Serial: 18081600720**

Communication System: 4FSK; Frequency: 160.012 MHz; Duty Cycle: 1:2

Medium parameters used: $f = 160.012$ MHz; $\sigma = 0.752$ S/m; $\epsilon_r = 51.243$; $\rho = 1000$ kg/m³

Phantom section: Flat Section

DASY5 Configuration:

- Probe: EX3DV4 - SN7329; ConvF(12.88, 12.88, 12.88); Calibrated: 2018/1/22;
- Sensor-Surface: 1.4mm (Mechanical Surface Detection)
- Electronics: DAE4 Sn1459; Calibrated: 2017/9/15
- Phantom: ELI v8.0; Type: QDOVA004AA; Serial: 2051
- Measurement SW: DASY52, Version 52.8 (8);

Area Scan (61x151x1): Interpolated grid: dx=1.500 mm, dy=1.500 mm

Maximum value of SAR (interpolated) = 2.14 W/kg

Zoom Scan (5x6x7)/Cube 0: Measurement grid: dx=8mm, dy=8mm, dz=5mm

Reference Value = 45.75 V/m; Power Drift = -0.13 dB

Peak SAR (extrapolated) = 2.57 W/kg

SAR(1 g) = 1.65 W/kg; SAR(10 g) = 1.25 W/kg

Maximum value of SAR (measured) = 2.16 W/kg

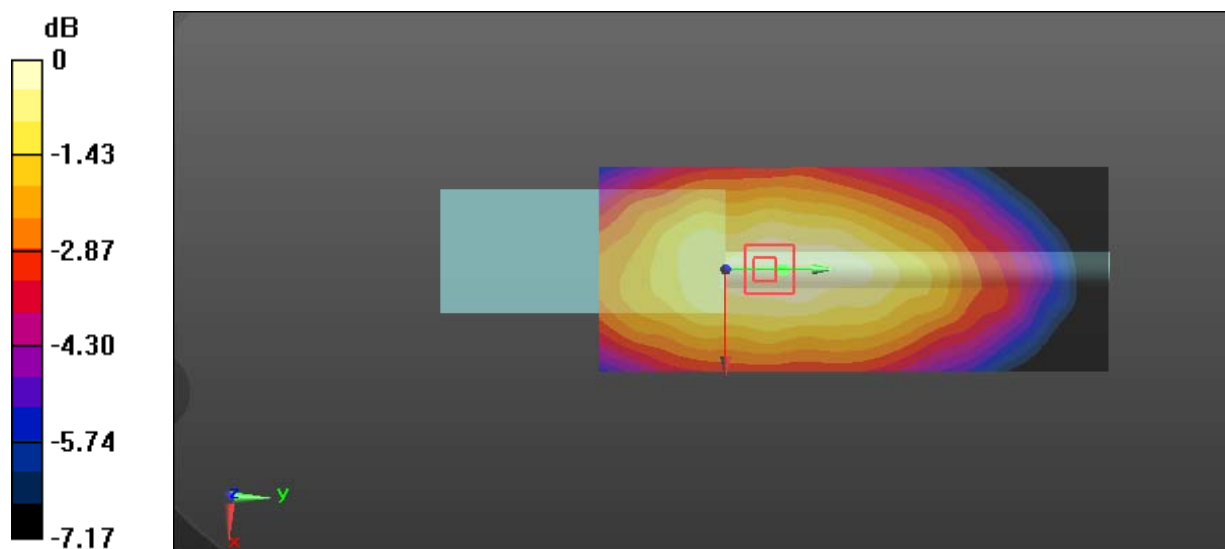

0 dB = 2.16 W/kg = 3.34 dBW/kg

Test Plot 34#: Antenna 3_PTT_FM 12.5kHz_Face Up_160.0125 MHz**DUT: Digital Portable Radio; Type: PD752iG VHF; Serial: 18081600721**

Communication System:FM; Frequency: 160.012 MHz;Duty Cycle: 1:1

Medium parameters used: $f = 160.012$ MHz; $\sigma = 0.752$ S/m; $\epsilon_r = 51.243$; $\rho = 1000$ kg/m³

Phantom section: Flat Section

DASY5 Configuration:

- Probe: EX3DV4 - SN7329; ConvF(12.88, 12.88, 12.88); Calibrated: 2018/1/22;
- Sensor-Surface: 1.4mm (Mechanical Surface Detection)
- Electronics: DAE4 Sn1459; Calibrated: 2017/9/15
- Phantom: ELI v8.0; Type: QDOVA004AA; Serial: 2051
- Measurement SW: DASY52, Version 52.8 (8);

Area Scan (61x151x1): Interpolated grid: dx=1.500 mm, dy=1.500 mm

Maximum value of SAR (interpolated) = 4.27 W/kg

Zoom Scan (5x5x7)/Cube 0: Measurement grid: dx=8mm, dy=8mm, dz=5mm

Reference Value = 64.32 V/m; Power Drift = -0.03 dB

Peak SAR (extrapolated) = 4.92 W/kg

SAR(1 g) = 3.18 W/kg; SAR(10 g) = 2.43 W/kg

Maximum value of SAR (measured) = 4.13 W/kg

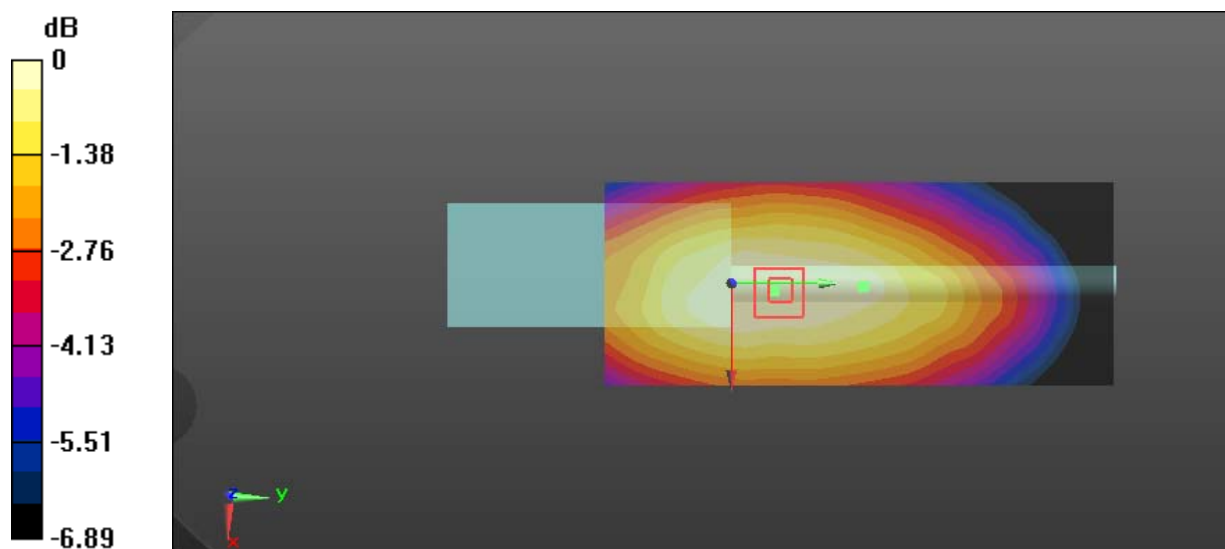

0 dB = 4.13 W/kg = 6.16 dBW/kg

Test Plot 35#: Antenna 3_PTT_FM 12.5kHz_Face Up_160.0125 MHz**DUT: Digital Portable Radio; Type: PD702iG VHF; Serial: 18081600722**

Communication System:FM; Frequency: 160.012 MHz;Duty Cycle: 1:1

Medium parameters used: $f = 160.012$ MHz; $\sigma = 0.752$ S/m; $\epsilon_r = 51.243$; $\rho = 1000$ kg/m³

Phantom section: Flat Section

DASY5 Configuration:

- Probe: EX3DV4 - SN7329; ConvF(12.88, 12.88, 12.88); Calibrated: 2018/1/22;
- Sensor-Surface: 1.4mm (Mechanical Surface Detection)
- Electronics: DAE4 Sn1459; Calibrated: 2017/9/15
- Phantom: ELI v8.0; Type: QDOVA004AA; Serial: 2051
- Measurement SW: DASY52, Version 52.8 (8);

Area Scan (61x151x1): Interpolated grid: dx=1.500 mm, dy=1.500 mm

Maximum value of SAR (interpolated) = 4.03 W/kg

Zoom Scan (5x5x7)/Cube 0: Measurement grid: dx=8mm, dy=8mm, dz=5mm

Reference Value = 61.39 V/m; Power Drift = -0.15 dB

Peak SAR (extrapolated) = 4.72 W/kg

SAR(1 g) = 3.03 W/kg; SAR(10 g) = 2.31 W/kg

Maximum value of SAR (measured) = 3.95 W/kg

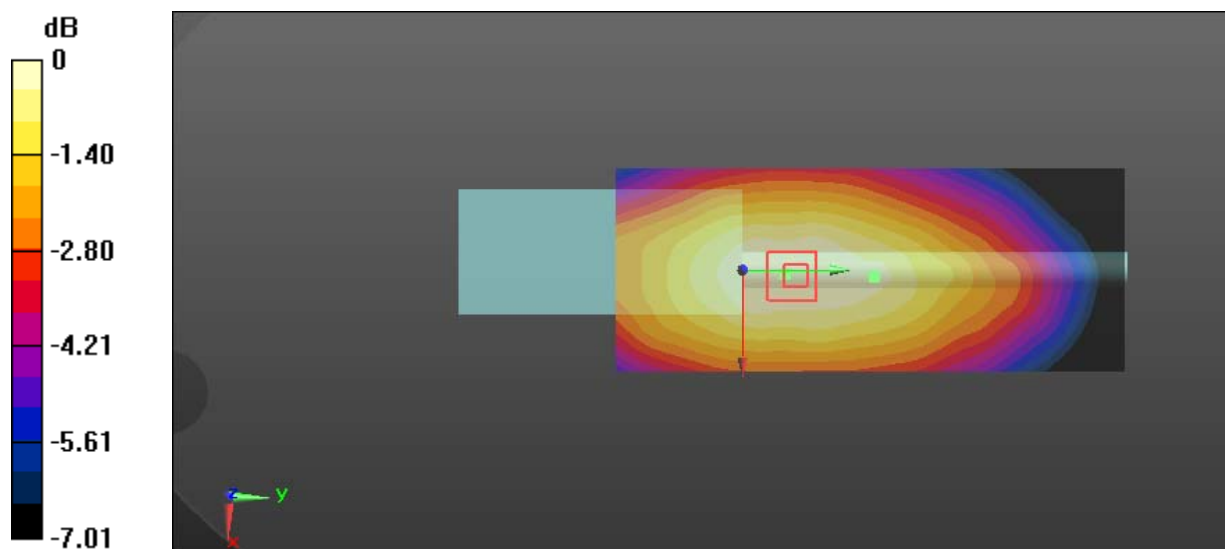

0 dB = 3.95 W/kg = 5.97 dBW/kg

Test Plot 36#: Antenna 3_PTT_FM 12.5kHz_Body Back_160.0125 MHz**DUT: Digital Portable Radio; Type: PD782iG VHF; Serial: 18081600720**

Communication System:FM; Frequency: 160.012 MHz;Duty Cycle: 1:1

Medium parameters used: $f = 160.012$ MHz; $\sigma = 0.823$ S/m; $\epsilon_r = 60.746$; $\rho = 1000$ kg/m³

Phantom section: Flat Section

DASY5 Configuration:

- Probe: EX3DV4 - SN7329; ConvF(12.56, 12.56, 12.56); Calibrated: 2018/1/22;
- Sensor-Surface: 1.4mm (Mechanical Surface Detection)
- Electronics: DAE4 Sn1459; Calibrated: 2017/9/15
- Phantom: ELI v8.0; Type: QDOVA004AA; Serial: 2051
- Measurement SW: DASY52, Version 52.8 (8);

Area Scan (61x151x1): Interpolated grid: dx=1.500 mm, dy=1.500 mm

Maximum value of SAR (interpolated) = 10.7 W/kg

Zoom Scan (5x5x7)/Cube 0: Measurement grid: dx=8mm, dy=8mm, dz=5mm

Reference Value = 89.60 V/m; Power Drift = -0.09 dB

Peak SAR (extrapolated) = 17.2 W/kg

SAR(1 g) = 7.19 W/kg; SAR(10 g) = 4.4 W/kg

Maximum value of SAR (measured) = 11.7 W/kg

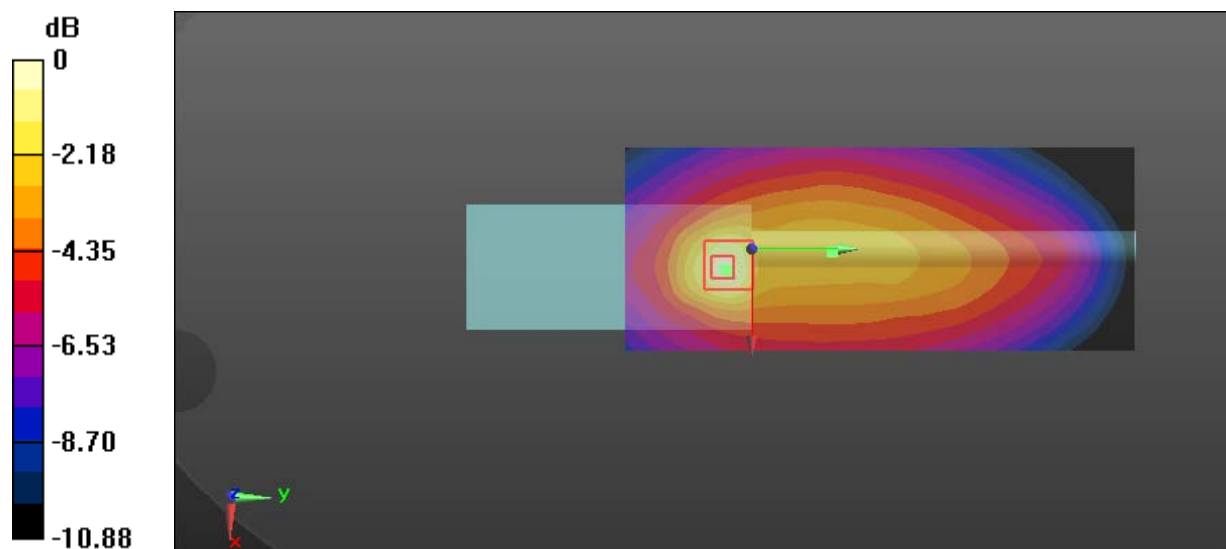

0 dB = 11.7 W/kg = 10.68 dBW/kg

Test Plot 37#: Antenna 3_PTT_FM 12.5kHz_Body Back_167 MHz**DUT: Digital Portable Radio; Type: PD782iG VHF; Serial: 18081600720**

Communication System: FM; Frequency: 167 MHz; Duty Cycle: 1:1

Medium parameters used: $f = 167$ MHz; $\sigma = 0.822$ S/m; $\epsilon_r = 60.44$; $\rho = 1000$ kg/m³

Phantom section: Flat Section

DASY5 Configuration:

- Probe: EX3DV4 - SN7329; ConvF(12.56, 12.56, 12.56); Calibrated: 2018/1/22;
- Sensor-Surface: 1.4mm (Mechanical Surface Detection)
- Electronics: DAE4 Sn1459; Calibrated: 2017/9/15
- Phantom: ELI v8.0; Type: QDOVA004AA; Serial: 2051
- Measurement SW: DASY52, Version 52.8 (8);

Area Scan (61x151x1): Interpolated grid: dx=1.500 mm, dy=1.500 mm

Maximum value of SAR (interpolated) = 8.31 W/kg

Zoom Scan (5x5x7)/Cube 0: Measurement grid: dx=8mm, dy=8mm, dz=5mm

Reference Value = 99.79 V/m; Power Drift = -0.06 dB

Peak SAR (extrapolated) = 14.2 W/kg

SAR(1 g) = 5.45 W/kg; SAR(10 g) = 3.32 W/kg

Maximum value of SAR (measured) = 9.85 W/kg

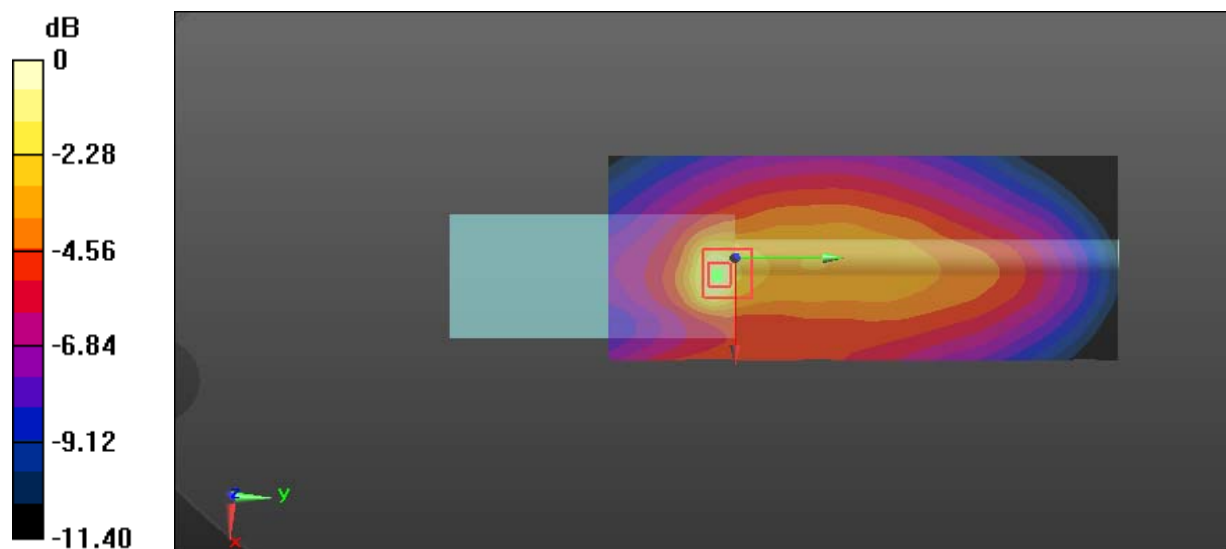

0 dB = 9.85 W/kg = 9.93 dBW/kg

Test Plot 38#: Antenna 3_PTT_FM 12.5kHz_Body Back_173.9875 MHz**DUT: Digital Portable Radio; Type: PD782iG VHF; Serial: 18081600720**

Communication System:FM; Frequency: 173.988 MHz;Duty Cycle: 1:1

Medium parameters used: $f = 173.988$ MHz; $\sigma = 0.841$ S/m; $\epsilon_r = 60.117$; $\rho = 1000$ kg/m³

Phantom section: Flat Section

DASY5 Configuration:

- Probe: EX3DV4 - SN7329; ConvF(12.56, 12.56, 12.56); Calibrated: 2018/1/22;
- Sensor-Surface: 1.4mm (Mechanical Surface Detection)
- Electronics: DAE4 Sn1459; Calibrated: 2017/9/15
- Phantom: ELI v8.0; Type: QDOVA004AA; Serial: 2051
- Measurement SW: DASY52, Version 52.8 (8);

Area Scan (61x151x1): Interpolated grid: dx=1.500 mm, dy=1.500 mm

Maximum value of SAR (interpolated) = 6.23 W/kg

Zoom Scan (5x5x7)/Cube 0: Measurement grid: dx=8mm, dy=8mm, dz=5mm

Reference Value = 60.25 V/m; Power Drift = 0.09 dB

Peak SAR (extrapolated) = 9.22 W/kg

SAR(1 g) = 3.93 W/kg; SAR(10 g) = 2.46 W/kg

Maximum value of SAR (measured) = 6.33 W/kg

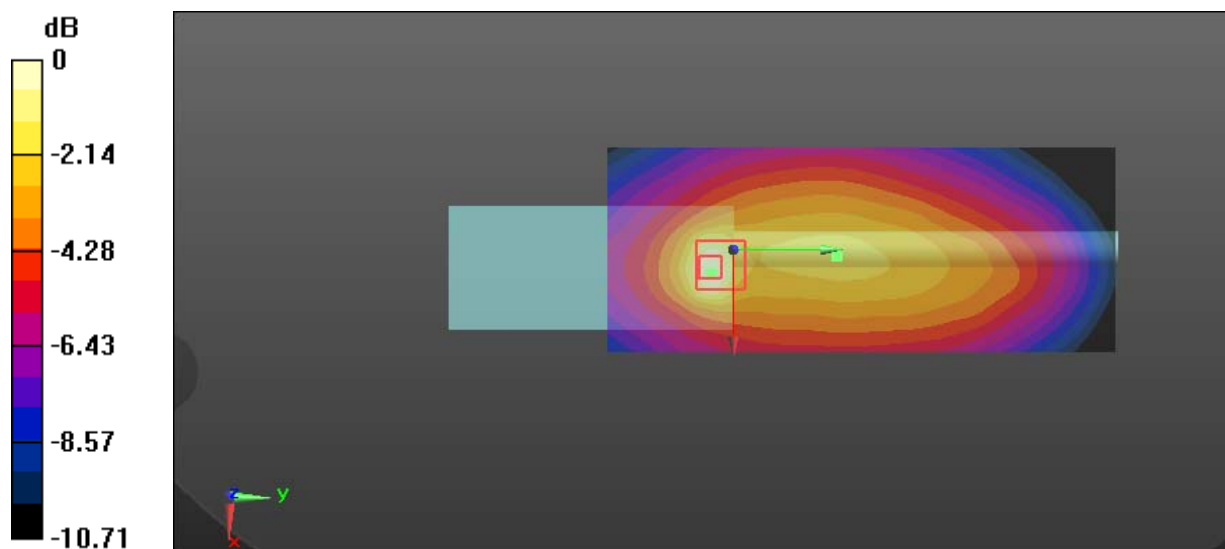

0 dB = 6.33 W/kg = 8.01 dBW/kg

Test Plot 39#: Antenna 3_PTT_FM 25kHz_Body Back_160.0125 MHz**DUT: Digital Portable Radio; Type: PD782iG VHF; Serial: 18081600720**

Communication System:FM; Frequency: 160.012 MHz;Duty Cycle: 1:1

Medium parameters used: $f = 160.012$ MHz; $\sigma = 0.823$ S/m; $\epsilon_r = 60.746$; $\rho = 1000$ kg/m³

Phantom section: Flat Section

DASY5 Configuration:

- Probe: EX3DV4 - SN7329; ConvF(12.56, 12.56, 12.56); Calibrated: 2018/1/22;
- Sensor-Surface: 1.4mm (Mechanical Surface Detection)
- Electronics: DAE4 Sn1459; Calibrated: 2017/9/15
- Phantom: ELI v8.0; Type: QDOVA004AA; Serial: 2051
- Measurement SW: DASY52, Version 52.8 (8);

Area Scan (61x151x1): Interpolated grid: dx=1.500 mm, dy=1.500 mm

Maximum value of SAR (interpolated) = 10.2 W/kg

Zoom Scan (5x5x7)/Cube 0: Measurement grid: dx=8mm, dy=8mm, dz=5mm

Reference Value = 75.94 V/m; Power Drift = 0.01 dB

Peak SAR (extrapolated) = 15.7 W/kg

SAR(1 g) = 6.33 W/kg; SAR(10 g) = 3.86 W/kg

Maximum value of SAR (measured) = 11.0 W/kg

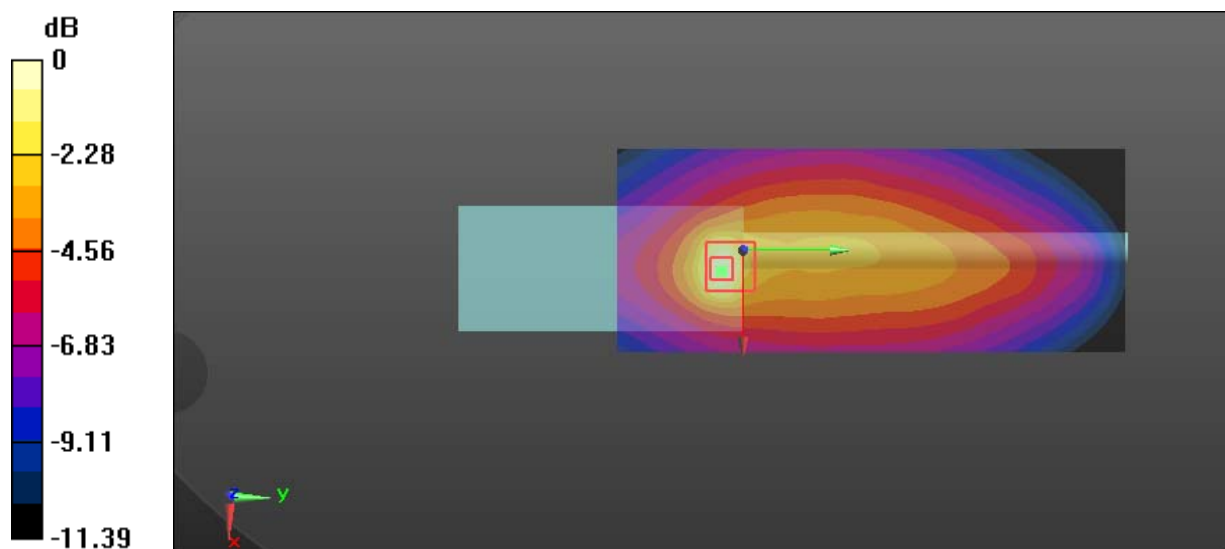

0 dB = 11.0 W/kg = 10.41 dBW/kg

Test Plot 40#: Antenna 3_PTT_4FSK 12.5kHz_Body Back_160.0125 MHz**DUT: Digital Portable Radio; Type: PD782iG VHF; Serial: 18081600720**

Communication System: 4FSK; Frequency: 160.012 MHz; Duty Cycle: 1:2

Medium parameters used: $f = 160.012$ MHz; $\sigma = 0.823$ S/m; $\epsilon_r = 60.746$; $\rho = 1000$ kg/m³

Phantom section: Flat Section

DASY5 Configuration:

- Probe: EX3DV4 - SN7329; ConvF(12.56, 12.56, 12.56); Calibrated: 2018/1/22;
- Sensor-Surface: 1.4mm (Mechanical Surface Detection)
- Electronics: DAE4 Sn1459; Calibrated: 2017/9/15
- Phantom: ELI v8.0; Type: QDOVA004AA; Serial: 2051
- Measurement SW: DASY52, Version 52.8 (8);

Area Scan (61x151x1): Interpolated grid: dx=1.500 mm, dy=1.500 mm

Maximum value of SAR (interpolated) = 5.63 W/kg

Zoom Scan (5x5x7)/Cube 0: Measurement grid: dx=8mm, dy=8mm, dz=5mm

Reference Value = 57.80 V/m; Power Drift = 0.01 dB

Peak SAR (extrapolated) = 8.30 W/kg

SAR(1 g) = 3.44 W/kg; SAR(10 g) = 2.09 W/kg

Maximum value of SAR (measured) = 5.80 W/kg

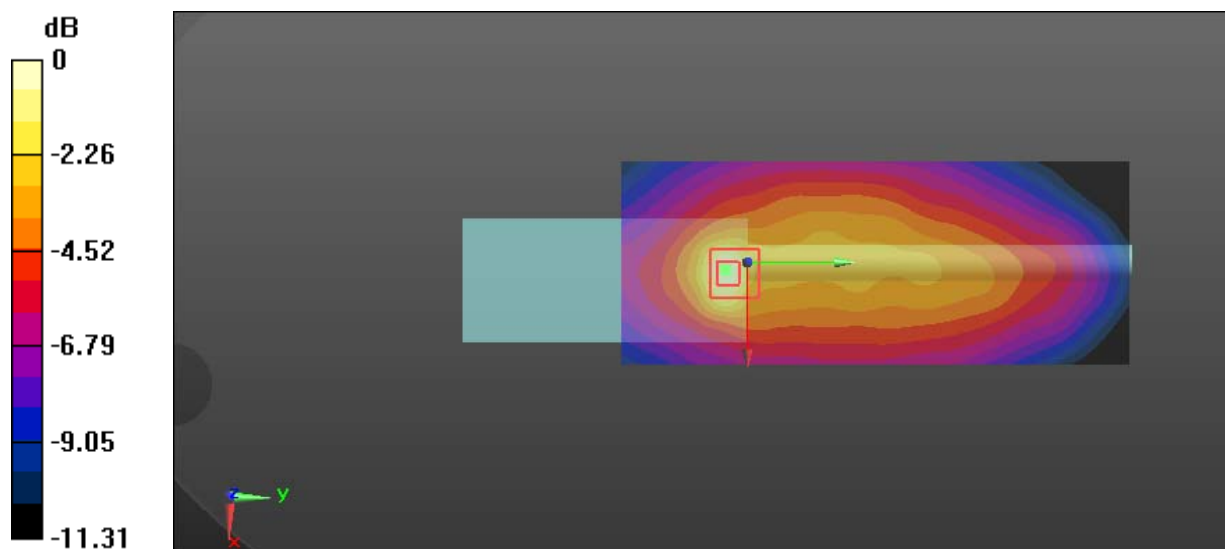

0 dB = 5.80 W/kg = 7.63 dBW/kg

Test Plot 41#: Antenna 3_PTT_FM 12.5kHz_Body Back_160.0125 MHz**DUT: Digital Portable Radio; Type: PD752iG VHF; Serial: 18081600721**

Communication System:FM; Frequency: 160.012 MHz;Duty Cycle: 1:1

Medium parameters used: $f = 160.012$ MHz; $\sigma = 0.823$ S/m; $\epsilon_r = 60.746$; $\rho = 1000$ kg/m³

Phantom section: Flat Section

DASY5 Configuration:

- Probe: EX3DV4 - SN7329; ConvF(12.56, 12.56, 12.56); Calibrated: 2018/1/22;
- Sensor-Surface: 1.4mm (Mechanical Surface Detection)
- Electronics: DAE4 Sn1459; Calibrated: 2017/9/15
- Phantom: ELI v8.0; Type: QDOVA004AA; Serial: 2051
- Measurement SW: DASY52, Version 52.8 (8);

Area Scan (61x151x1): Interpolated grid: dx=1.500 mm, dy=1.500 mm

Maximum value of SAR (interpolated) = 12.3 W/kg

Zoom Scan (5x5x7)/Cube 0: Measurement grid: dx=8mm, dy=8mm, dz=5mm

Reference Value = 84.26 V/m; Power Drift = -0.14 dB

Peak SAR (extrapolated) = 18.9 W/kg

SAR(1 g) = 7.5 W/kg; SAR(10 g) = 4.51 W/kg

Maximum value of SAR (measured) = 12.5 W/kg

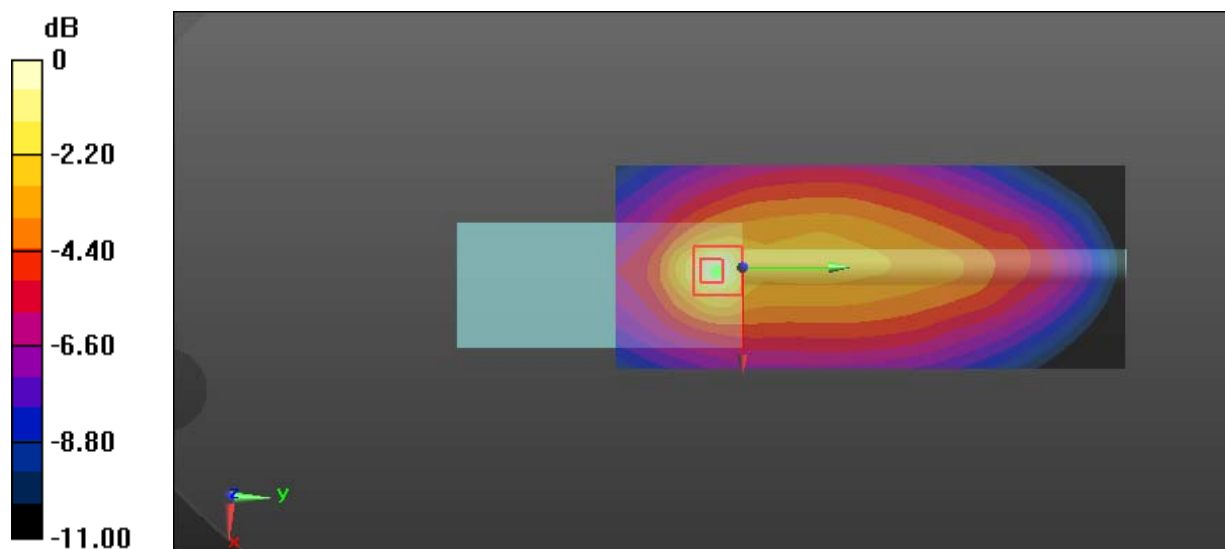

0 dB = 12.5 W/kg = 10.97 dBW/kg

Test Plot 42#: Antenna 3_PTT_FM 12.5kHz_Body Back_160.0125 MHz**DUT: Digital Portable Radio; Type: PD702iG VHF; Serial: 18081600722**

Communication System:FM; Frequency: 160.012 MHz;Duty Cycle: 1:1

Medium parameters used: $f = 160.012$ MHz; $\sigma = 0.823$ S/m; $\epsilon_r = 60.746$; $\rho = 1000$ kg/m³

Phantom section: Flat Section

DASY5 Configuration:

- Probe: EX3DV4 - SN7329; ConvF(12.56, 12.56, 12.56); Calibrated: 2018/1/22;
- Sensor-Surface: 1.4mm (Mechanical Surface Detection)
- Electronics: DAE4 Sn1459; Calibrated: 2017/9/15
- Phantom: ELI v8.0; Type: QDOVA004AA; Serial: 2051
- Measurement SW: DASY52, Version 52.8 (8);

Area Scan (61x151x1): Interpolated grid: dx=1.500 mm, dy=1.500 mm

Maximum value of SAR (interpolated) = 11.8 W/kg

Zoom Scan (5x5x7)/Cube 0: Measurement grid: dx=8mm, dy=8mm, dz=5mm

Reference Value = 81.13 V/m; Power Drift = -0.10 dB

Peak SAR (extrapolated) = 19.2 W/kg

SAR(1 g) = 7.16 W/kg; SAR(10 g) = 4.26 W/kg

Maximum value of SAR (measured) = 11.8 W/kg

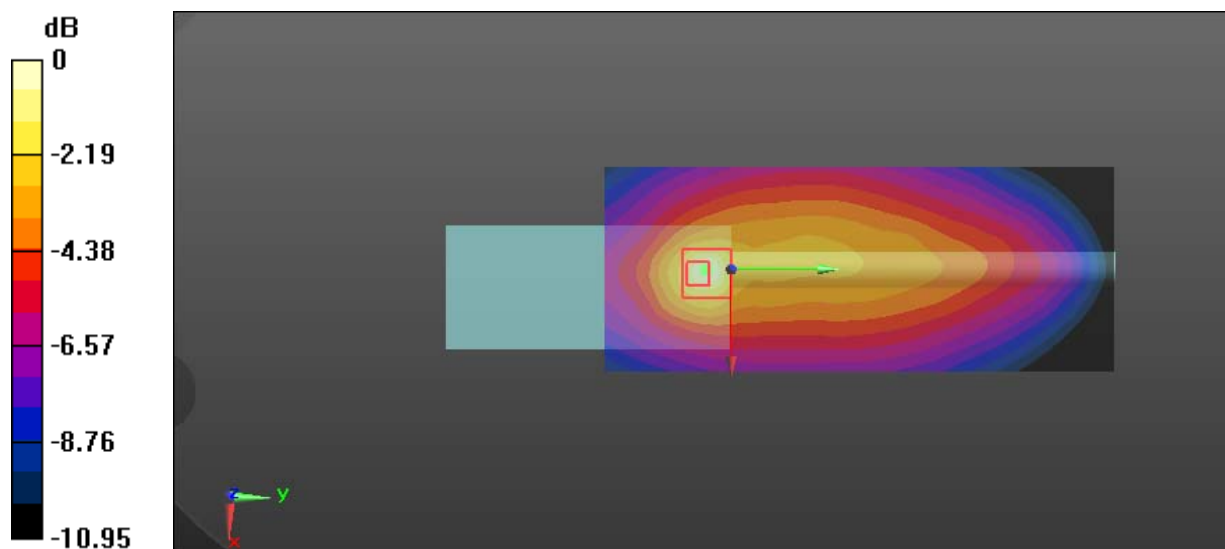

0 dB = 11.8 W/kg = 10.72 dBW/kg

Test Plot 43#: Antenna 4_PTT_FM 12.5kHz_Face Up_136.0125 MHz**DUT: Digital Portable Radio; Type: PD782iG VHF; Serial: 18081600720**

Communication System:FM; Frequency: 136.012 MHz;Duty Cycle: 1:1

Medium parameters used: $f = 136.012$ MHz; $\sigma = 0.748$ S/m; $\epsilon_r = 52.931$; $\rho = 1000$ kg/m³

Phantom section: Flat Section

DASY5 Configuration:

- Probe: EX3DV4 - SN7329; ConvF(12.88, 12.88, 12.88); Calibrated: 2018/1/22;
- Sensor-Surface: 1.4mm (Mechanical Surface Detection)
- Electronics: DAE4 Sn1459; Calibrated: 2017/9/15
- Phantom: ELI v8.0; Type: QDOVA004AA; Serial: 2051
- Measurement SW: DASY52, Version 52.8 (8);

Area Scan (61x171x1): Interpolated grid: dx=1.500 mm, dy=1.500 mm

Maximum value of SAR (interpolated) = 1.19 W/kg

Zoom Scan (5x7x7)/Cube 0: Measurement grid: dx=8mm, dy=8mm, dz=5mm

Reference Value = 27.81 V/m; Power Drift = -0.09 dB

Peak SAR (extrapolated) = 1.43 W/kg

SAR(1 g) = 0.92 W/kg; SAR(10 g) = 0.72 W/kg

Maximum value of SAR (measured) = 1.20 W/kg

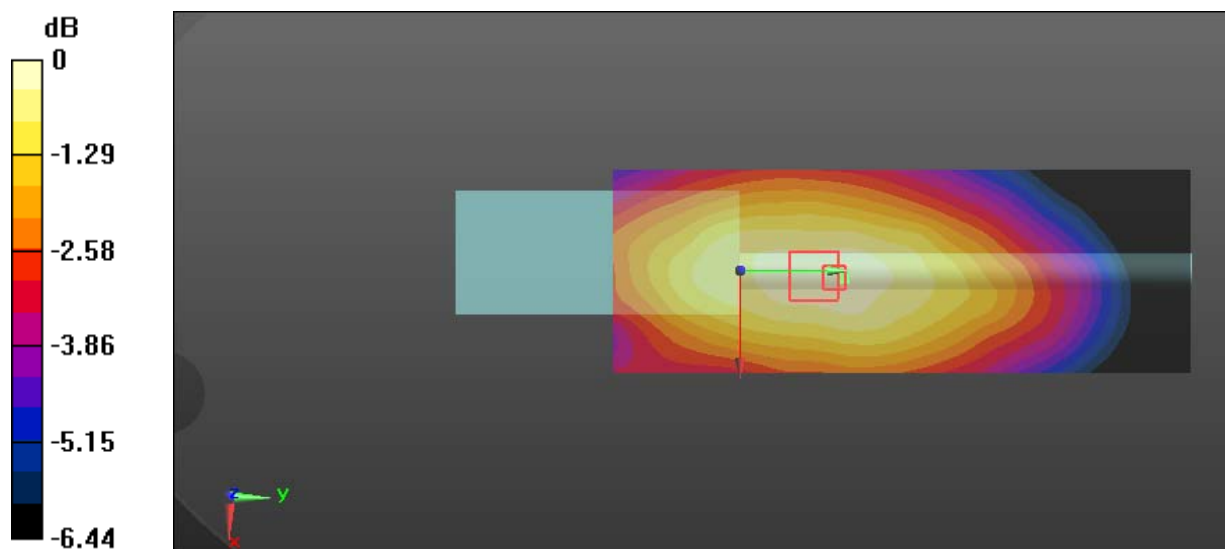

0 dB = 1.20 W/kg = 0.79 dBW/kg

Test Plot 44#: Antenna 4_PTT_FM 12.5kHz_Face Up_147.0125 MHz**DUT: Digital Portable Radio; Type: PD782iG VHF; Serial: 18081600720**

Communication System:FM; Frequency: 147.012 MHz;Duty Cycle: 1:1

Medium parameters used: $f = 147.012$ MHz; $\sigma = 0.757$ S/m; $\epsilon_r = 51.828$; $\rho = 1000$ kg/m³

Phantom section: Flat Section

DASY5 Configuration:

- Probe: EX3DV4 - SN7329; ConvF(12.88, 12.88, 12.88); Calibrated: 2018/1/22;
- Sensor-Surface: 1.4mm (Mechanical Surface Detection)
- Electronics: DAE4 Sn1459; Calibrated: 2017/9/15
- Phantom: ELI v8.0; Type: QDOVA004AA; Serial: 2051
- Measurement SW: DASY52, Version 52.8 (8);

Area Scan (61x171x1): Interpolated grid: dx=1.500 mm, dy=1.500 mm

Maximum value of SAR (interpolated) = 4.34 W/kg

Zoom Scan (6x6x7)/Cube 0: Measurement grid: dx=8mm, dy=8mm, dz=5mm

Reference Value = 65.83 V/m; Power Drift = -0.09 dB

Peak SAR (extrapolated) = 5.11 W/kg

SAR(1 g) = 3.24 W/kg; SAR(10 g) = 2.46 W/kg

Maximum value of SAR (measured) = 4.25 W/kg

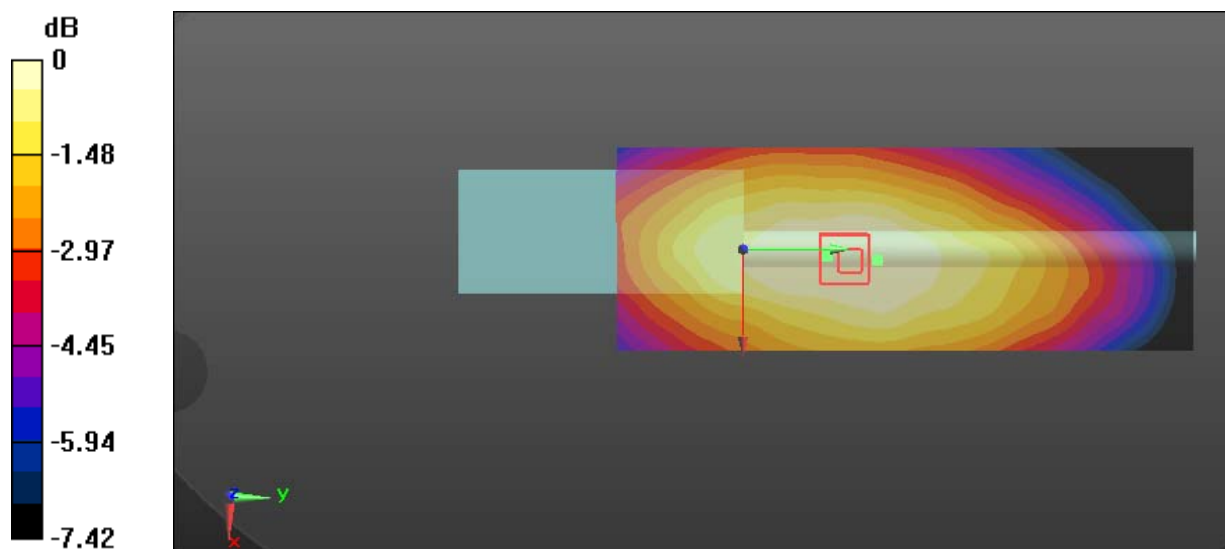

0 dB = 4.25 W/kg = 6.28 dBW/kg

Test Plot 45#: Antenna 4_PTT_FM 12.5kHz_Face Up_154 MHz**DUT: Digital Portable Radio; Type: PD782iG VHF; Serial: 18081600720**

Communication System:FM; Frequency: 154 MHz;Duty Cycle: 1:1

Medium parameters used: $f = 154$ MHz; $\sigma = 0.754$ S/m; $\epsilon_r = 51.016$; $\rho = 1000$ kg/m³

Phantom section: Flat Section

DASY5 Configuration:

- Probe: EX3DV4 - SN7329; ConvF(12.88, 12.88, 12.88); Calibrated: 2018/1/22;
- Sensor-Surface: 1.4mm (Mechanical Surface Detection)
- Electronics: DAE4 Sn1459; Calibrated: 2017/9/15
- Phantom: ELI v8.0; Type: QDOVA004AA; Serial: 2051
- Measurement SW: DASY52, Version 52.8 (8);

Area Scan (61x171x1): Interpolated grid: dx=1.500 mm, dy=1.500 mm

Maximum value of SAR (interpolated) = 4.75 W/kg

Zoom Scan (6x6x7)/Cube 0: Measurement grid: dx=8mm, dy=8mm, dz=5mm

Reference Value = 48.42 V/m; Power Drift = -0.16 dB

Peak SAR (extrapolated) = 5.89 W/kg

SAR(1 g) = 3.75 W/kg; SAR(10 g) = 2.89 W/kg

Maximum value of SAR (measured) = 4.89 W/kg

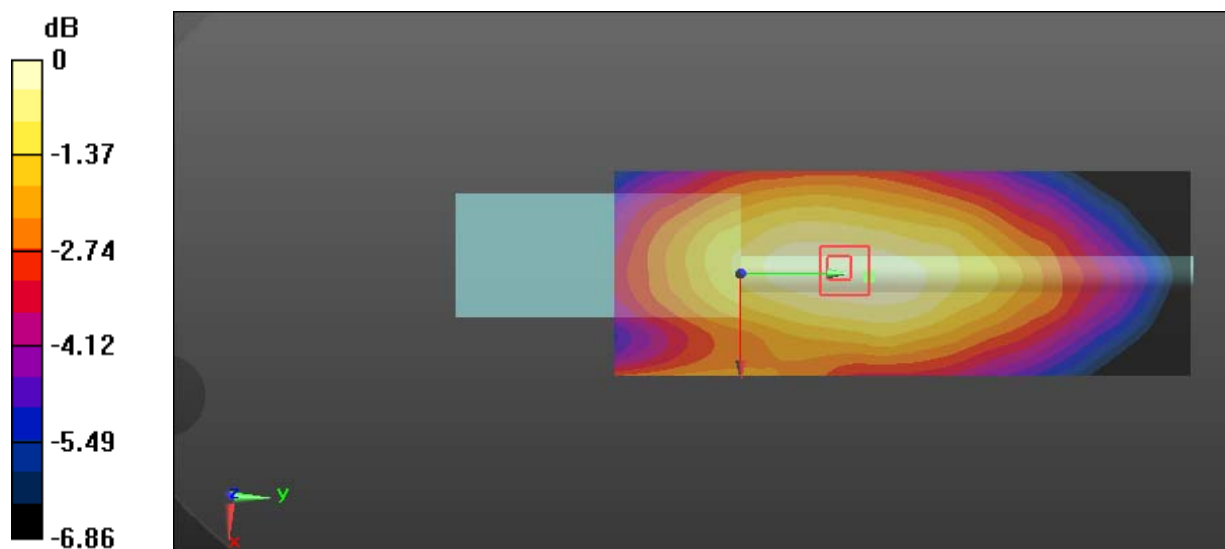

0 dB = 4.89 W/kg = 6.89 dBW/kg

Test Plot 46#: Antenna 4_PTT_FM 12.5kHz_Face Up_160.0125 MHz**DUT: Digital Portable Radio; Type: PD782iG VHF; Serial: 18081600720**

Communication System:FM; Frequency: 160.012 MHz;Duty Cycle: 1:1

Medium parameters used: $f = 160.012$ MHz; $\sigma = 0.752$ S/m; $\epsilon_r = 51.243$; $\rho = 1000$ kg/m³

Phantom section: Flat Section

DASY5 Configuration:

- Probe: EX3DV4 - SN7329; ConvF(12.88, 12.88, 12.88); Calibrated: 2018/1/22;
- Sensor-Surface: 1.4mm (Mechanical Surface Detection)
- Electronics: DAE4 Sn1459; Calibrated: 2017/9/15
- Phantom: ELI v8.0; Type: QDOVA004AA; Serial: 2051
- Measurement SW: DASY52, Version 52.8 (8);

Area Scan (61x171x1): Interpolated grid: dx=1.500 mm, dy=1.500 mm

Maximum value of SAR (interpolated) = 5.90 W/kg

Zoom Scan (6x6x7)/Cube 0: Measurement grid: dx=8mm, dy=8mm, dz=5mm

Reference Value = 71.19 V/m; Power Drift = -0.02 dB

Peak SAR (extrapolated) = 7.02 W/kg

SAR(1 g) = 4.48 W/kg; SAR(10 g) = 3.39 W/kg

Maximum value of SAR (measured) = 5.84 W/kg

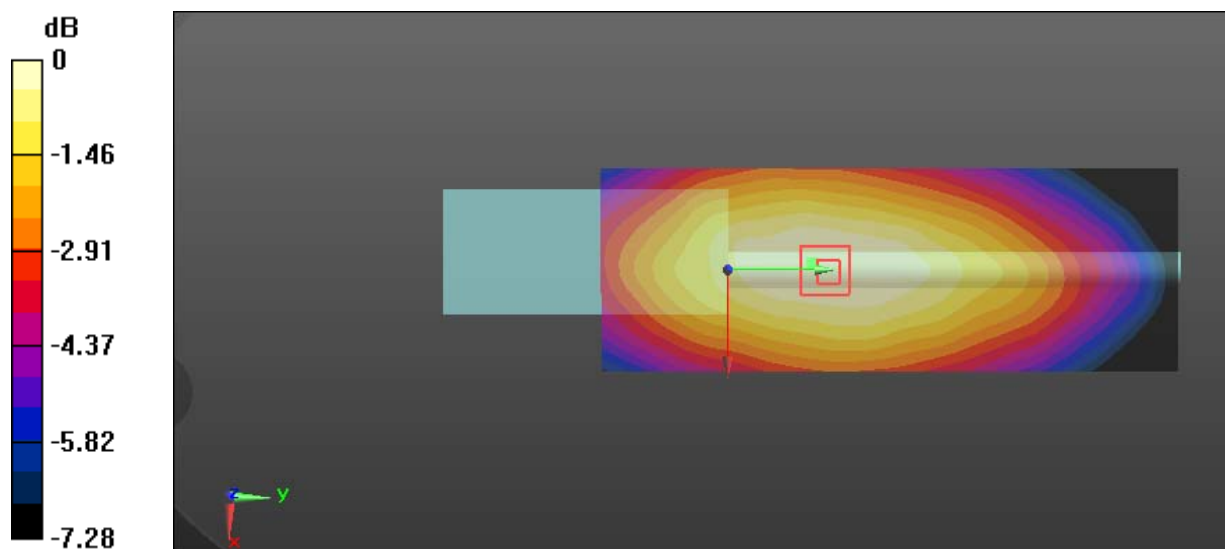

0 dB = 5.84 W/kg = 7.66 dBW/kg

Test Plot 47#: Antenna 4_PTT_FM 12.5kHz_Face Up_173.9875 MHz**DUT: Digital Portable Radio; Type: PD782iG VHF; Serial: 18081600720**

Communication System:FM; Frequency: 173.988 MHz;Duty Cycle: 1:1

Medium parameters used: $f = 173.988$ MHz; $\sigma = 0.793$ S/m; $\epsilon_r = 50.341$; $\rho = 1000$ kg/m³

Phantom section: Flat Section

DASY5 Configuration:

- Probe: EX3DV4 - SN7329; ConvF(12.88, 12.88, 12.88); Calibrated: 2018/1/22;
- Sensor-Surface: 1.4mm (Mechanical Surface Detection)
- Electronics: DAE4 Sn1459; Calibrated: 2017/9/15
- Phantom: ELI v8.0; Type: QDOVA004AA; Serial: 2051
- Measurement SW: DASY52, Version 52.8 (8);

Area Scan (61x171x1): Interpolated grid: dx=1.500 mm, dy=1.500 mm

Maximum value of SAR (interpolated) = 5.03 W/kg

Zoom Scan (6x6x7)/Cube 0: Measurement grid: dx=8mm, dy=8mm, dz=5mm

Reference Value = 64.40 V/m; Power Drift = -0.18 dB

Peak SAR (extrapolated) = 6.11 W/kg

SAR(1 g) = 3.93 W/kg; SAR(10 g) = 3.01 W/kg

Maximum value of SAR (measured) = 5.09 W/kg

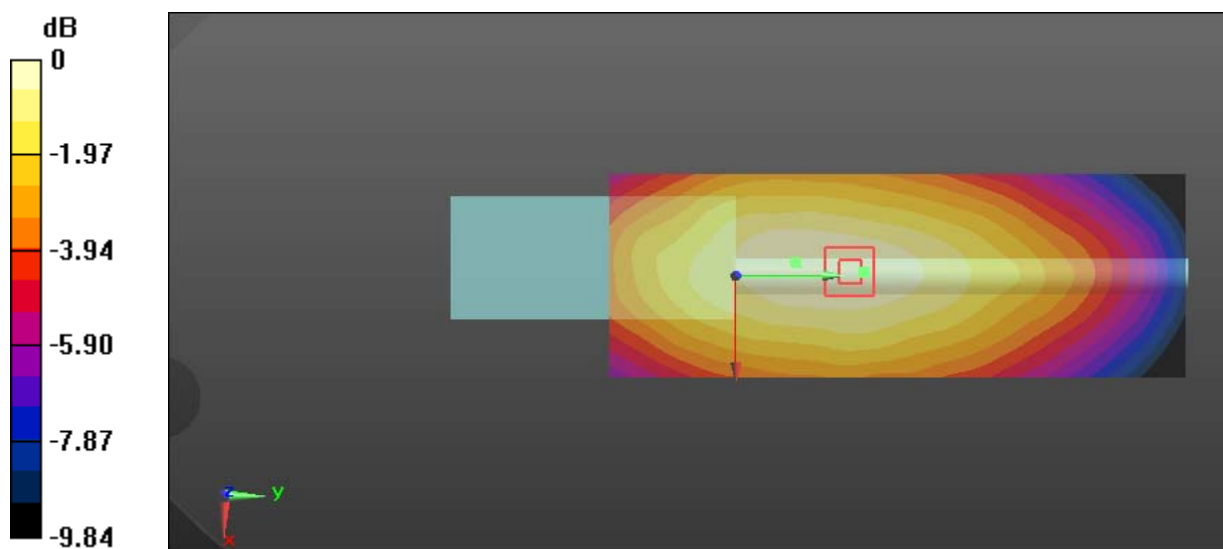

0 dB = 5.09 W/kg = 7.07 dBW/kg

Test Plot 48#: Antenna 4_PTT_FM 25kHz_Face Up_160.0125 MHz**DUT: Digital Portable Radio; Type: PD782iG VHF; Serial: 18081600720**

Communication System:FM; Frequency: 160.012 MHz;Duty Cycle: 1:1

Medium parameters used: $f = 160.012$ MHz; $\sigma = 0.752$ S/m; $\epsilon_r = 51.243$; $\rho = 1000$ kg/m³

Phantom section: Flat Section

DASY5 Configuration:

- Probe: EX3DV4 - SN7329; ConvF(12.88, 12.88, 12.88); Calibrated: 2018/1/22;
- Sensor-Surface: 1.4mm (Mechanical Surface Detection)
- Electronics: DAE4 Sn1459; Calibrated: 2017/9/15
- Phantom: ELI v8.0; Type: QDOVA004AA; Serial: 2051
- Measurement SW: DASY52, Version 52.8 (8);

Area Scan (61x171x1): Interpolated grid: dx=1.500 mm, dy=1.500 mm

Maximum value of SAR (interpolated) = 6.00 W/kg

Zoom Scan (5x7x7)/Cube 0: Measurement grid: dx=8mm, dy=8mm, dz=5mm

Reference Value = 71.92 V/m; Power Drift = -0.02 dB

Peak SAR (extrapolated) = 6.98 W/kg

SAR(1 g) = 4.4 W/kg; SAR(10 g) = 3.36 W/kg

Maximum value of SAR (measured) = 5.85 W/kg

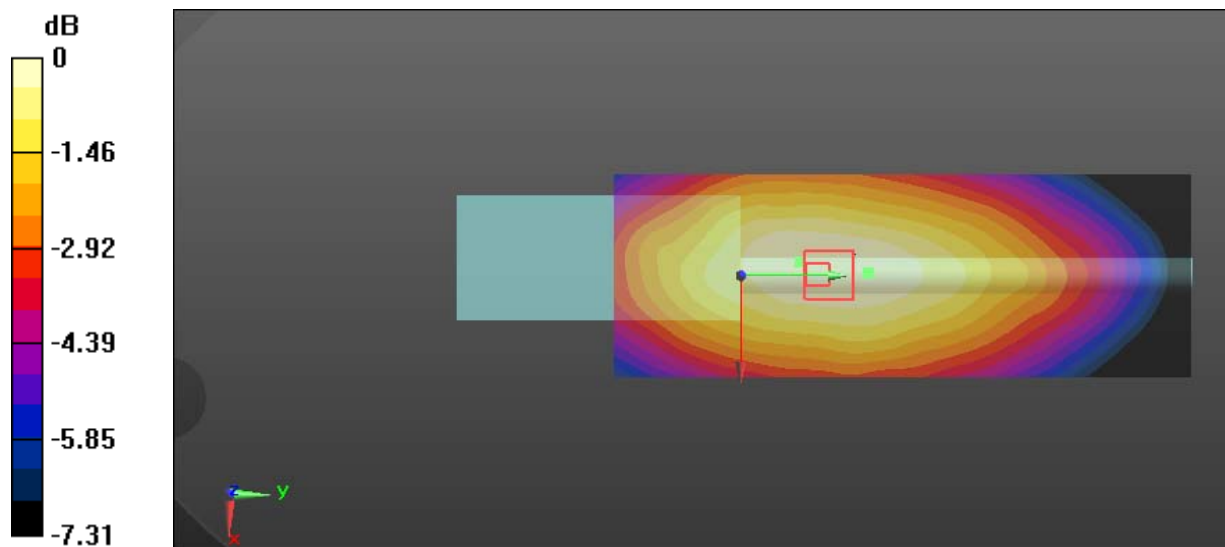

0 dB = 5.85 W/kg = 7.67 dBW/kg

Test Plot 49#: Antenna 4_PTT_4FSK 12.5kHz_Face Up_160.0125 MHz**DUT: Digital Portable Radio; Type: PD782iG VHF; Serial: 18081600720**

Communication System: 4FSK; Frequency: 160.012 MHz; Duty Cycle: 1:2

Medium parameters used: $f = 160.012$ MHz; $\sigma = 0.752$ S/m; $\epsilon_r = 51.243$; $\rho = 1000$ kg/m³

Phantom section: Flat Section

DASY5 Configuration:

- Probe: EX3DV4 - SN7329; ConvF(12.88, 12.88, 12.88); Calibrated: 2018/1/22;
- Sensor-Surface: 1.4mm (Mechanical Surface Detection)
- Electronics: DAE4 Sn1459; Calibrated: 2017/9/15
- Phantom: ELI v8.0; Type: QDOVA004AA; Serial: 2051
- Measurement SW: DASY52, Version 52.8 (8);

Area Scan (61x171x1): Interpolated grid: dx=1.500 mm, dy=1.500 mm

Maximum value of SAR (interpolated) = 3.27 W/kg

Zoom Scan (5x5x7)/Cube 0: Measurement grid: dx=8mm, dy=8mm, dz=5mm

Reference Value = 53.11 V/m; Power Drift = -0.06 dB

Peak SAR (extrapolated) = 3.89 W/kg

SAR(1 g) = 2.43 W/kg; SAR(10 g) = 1.85 W/kg

Maximum value of SAR (measured) = 3.18 W/kg

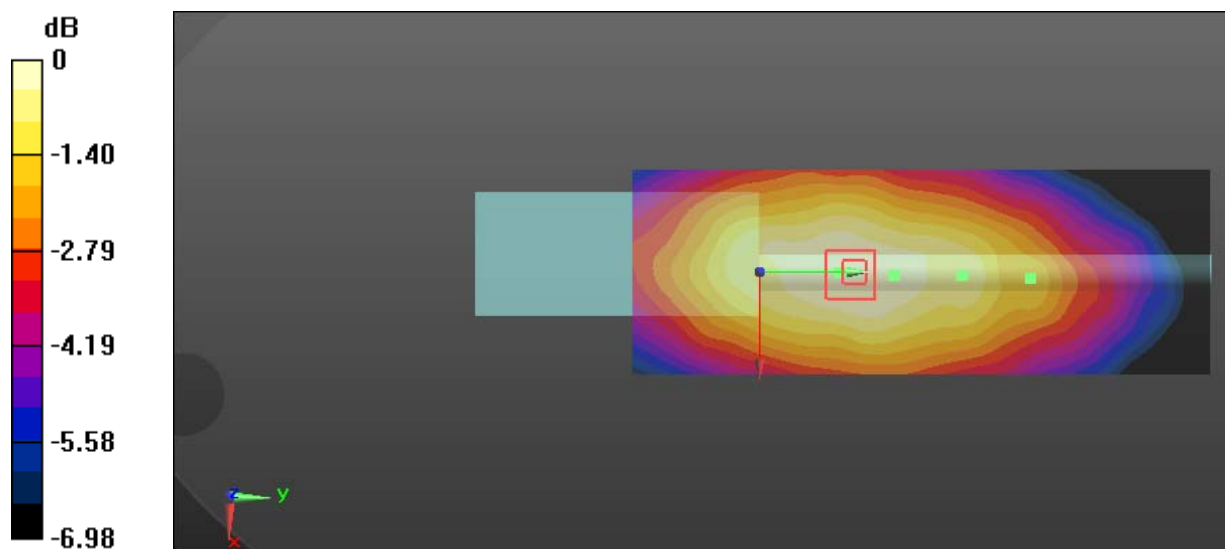

0 dB = 3.18 W/kg = 5.02 dBW/kg

Test Plot 50#: Antenna 4_PTT_FM 12.5kHz_Face Up_160.0125 MHz**DUT: Digital Portable Radio; Type: PD752iG VHF; Serial: 18081600721**

Communication System:FM; Frequency: 160.012 MHz;Duty Cycle: 1:1

Medium parameters used: $f = 160.012$ MHz; $\sigma = 0.752$ S/m; $\epsilon_r = 51.243$; $\rho = 1000$ kg/m³

Phantom section: Flat Section

DASY5 Configuration:

- Probe: EX3DV4 - SN7329; ConvF(12.88, 12.88, 12.88); Calibrated: 2018/1/22;
- Sensor-Surface: 1.4mm (Mechanical Surface Detection)
- Electronics: DAE4 Sn1459; Calibrated: 2017/9/15
- Phantom: ELI v8.0; Type: QDOVA004AA; Serial: 2051
- Measurement SW: DASY52, Version 52.8 (8);

Area Scan (61x171x1): Interpolated grid: $dx=1.500$ mm, $dy=1.500$ mm

Maximum value of SAR (interpolated) = 5.21 W/kg

Zoom Scan (5x5x7)/Cube 0: Measurement grid: $dx=8$ mm, $dy=8$ mm, $dz=5$ mm

Reference Value = 77.27 V/m; Power Drift = -0.18 dB

Peak SAR (extrapolated) = 6.14 W/kg

SAR(1 g) = 3.97 W/kg; SAR(10 g) = 3.07 W/kg

Maximum value of SAR (measured) = 5.17 W/kg

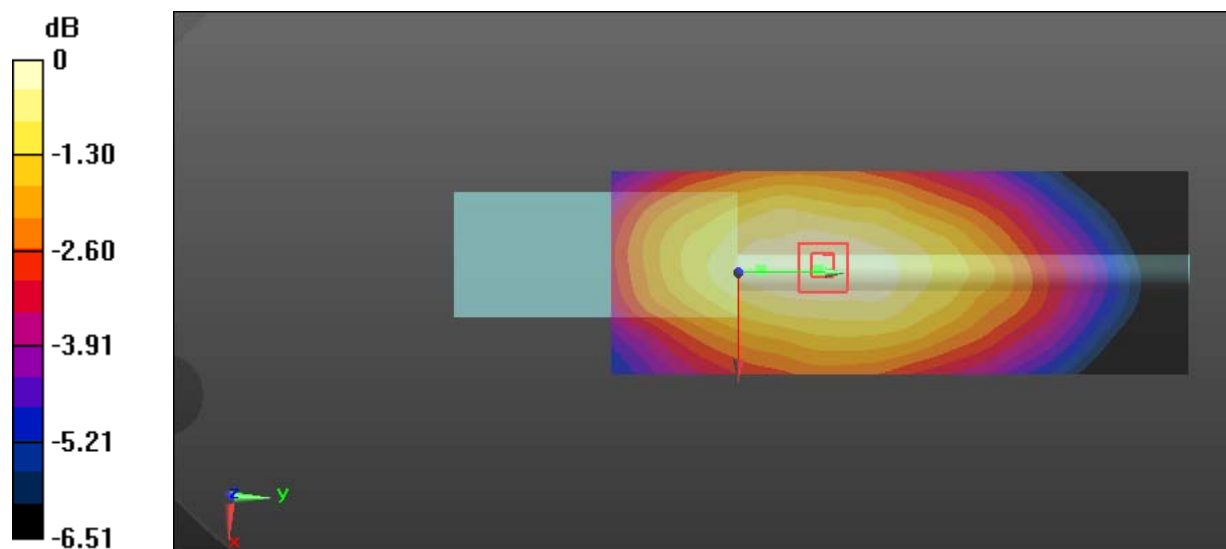

0 dB = 5.17 W/kg = 7.13 dBW/kg

Test Plot 51#: Antenna 4_PTT_FM 12.5kHz_Face Up_160.0125 MHz**DUT: Digital Portable Radio; Type: PD702iG VHF; Serial: 18081600722**

Communication System:FM; Frequency: 160.012 MHz;Duty Cycle: 1:1

Medium parameters used: $f = 160.012$ MHz; $\sigma = 0.752$ S/m; $\epsilon_r = 51.243$; $\rho = 1000$ kg/m³

Phantom section: Flat Section

DASY5 Configuration:

- Probe: EX3DV4 - SN7329; ConvF(12.88, 12.88, 12.88); Calibrated: 2018/1/22;
- Sensor-Surface: 1.4mm (Mechanical Surface Detection)
- Electronics: DAE4 Sn1459; Calibrated: 2017/9/15
- Phantom: ELI v8.0; Type: QDOVA004AA; Serial: 2051
- Measurement SW: DASY52, Version 52.8 (8);

Area Scan (61x171x1): Interpolated grid: dx=1.500 mm, dy=1.500 mm

Maximum value of SAR (interpolated) = 5.56 W/kg

Zoom Scan (7x7x7)/Cube 0: Measurement grid: dx=8mm, dy=8mm, dz=5mm

Reference Value = 69.90 V/m; Power Drift = -0.08 dB

Peak SAR (extrapolated) = 6.53 W/kg

SAR(1 g) = 4.16 W/kg; SAR(10 g) = 3.17 W/kg

Maximum value of SAR (measured) = 5.45 W/kg

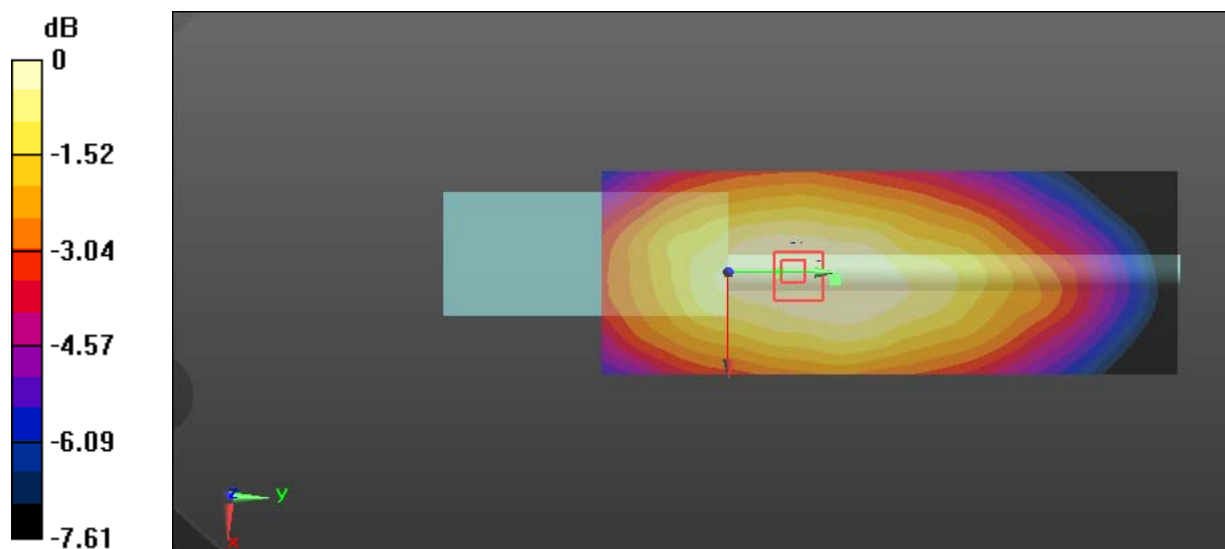

0 dB = 5.45 W/kg = 7.36 dBW/kg

Test Plot 52#: Antenna 4_PTT_FM 12.5kHz_Body Back_136.0125 MHz**DUT: Digital Portable Radio; Type: PD782iG VHF; Serial: 18081600720**

Communication System:FM; Frequency: 136.012 MHz;Duty Cycle: 1:1

Medium parameters used: $f = 136.012$ MHz; $\sigma = 0.81$ S/m; $\epsilon_r = 61.89$; $\rho = 1000$ kg/m³

Phantom section: Flat Section

DASY5 Configuration:

- Probe: EX3DV4 - SN7329; ConvF(12.56, 12.56, 12.56); Calibrated: 2018/1/22;
- Sensor-Surface: 1.4mm (Mechanical Surface Detection)
- Electronics: DAE4 Sn1459; Calibrated: 2017/9/15
- Phantom: ELI v8.0; Type: QDOVA004AA; Serial: 2051
- Measurement SW: DASY52, Version 52.8 (8);

Area Scan (61x171x1): Interpolated grid: dx=1.500 mm, dy=1.500 mm

Maximum value of SAR (interpolated) = 3.52 W/kg

Zoom Scan (6x6x7)/Cube 0: Measurement grid: dx=8mm, dy=8mm, dz=5mm

Reference Value = 37.53 V/m; Power Drift = -0.14 dB

Peak SAR (extrapolated) = 5.96 W/kg

SAR(1 g) = 2.07 W/kg; SAR(10 g) = 1.15 W/kg

Maximum value of SAR (measured) = 3.90 W/kg

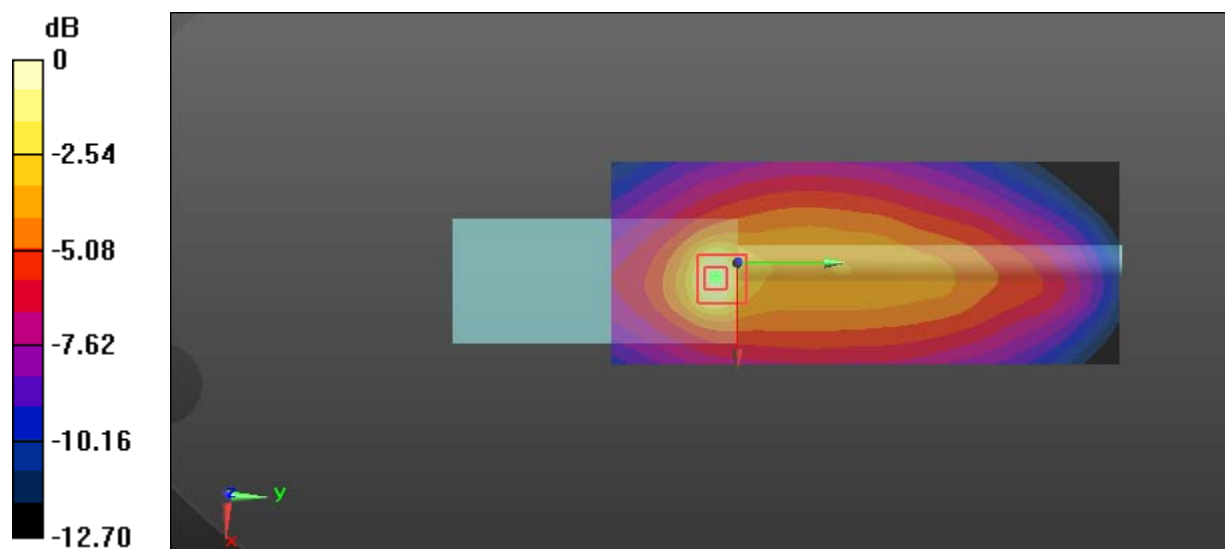

0 dB = 3.90 W/kg = 5.91 dBW/kg

Test Plot 53#: Antenna 4_PTT_FM 12.5kHz_Body Back_147.0125 MHz**DUT: Digital Portable Radio; Type: PD782iG VHF; Serial: 18081600720**

Communication System:FM; Frequency: 147.012 MHz;Duty Cycle: 1:1

Medium parameters used: $f = 147.012$ MHz; $\sigma = 0.819$ S/m; $\epsilon_r = 61.603$; $\rho = 1000$ kg/m³

Phantom section: Flat Section

DASY5 Configuration:

- Probe: EX3DV4 - SN7329; ConvF(12.56, 12.56, 12.56); Calibrated: 2018/1/22;
- Sensor-Surface: 1.4mm (Mechanical Surface Detection)
- Electronics: DAE4 Sn1459; Calibrated: 2017/9/15
- Phantom: ELI v8.0; Type: QDOVA004AA; Serial: 2051
- Measurement SW: DASY52, Version 52.8 (8);

Area Scan (61x171x1): Interpolated grid: dx=1.500 mm, dy=1.500 mm

Maximum value of SAR (interpolated) = 6.61 W/kg

Zoom Scan (5x5x7)/Cube 0: Measurement grid: dx=8mm, dy=8mm, dz=5mm

Reference Value = 60.03 V/m; Power Drift = -0.18 dB

Peak SAR (extrapolated) = 10.3 W/kg

SAR(1 g) = 3.66 W/kg; SAR(10 g) = 2.20 W/kg

Maximum value of SAR (measured) = 6.98 W/kg

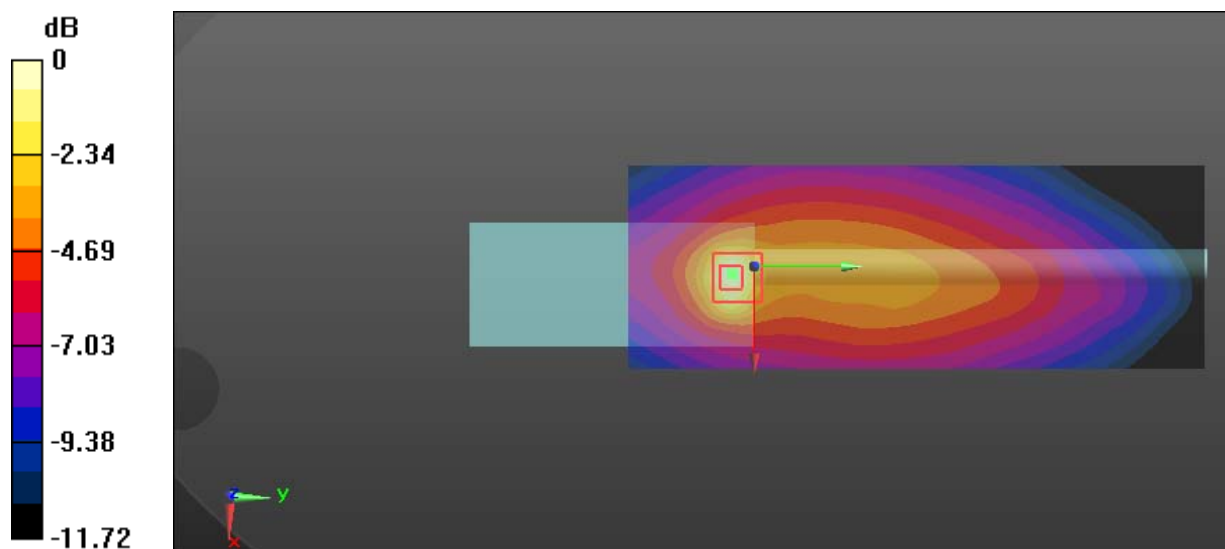

0 dB = 6.98 W/kg = 8.44 dBW/kg

Test Plot 54#: Antenna 4_PTT_FM 12.5kHz_Body Back_154 MHz**DUT: Digital Portable Radio; Type: PD782iG VHF; Serial: 18081600720**

Communication System: FM; Frequency: 154 MHz; Duty Cycle: 1:1

Medium parameters used: $f = 154 \text{ MHz}$; $\sigma = 0.788 \text{ S/m}$; $\epsilon_r = 61.6$; $\rho = 1000 \text{ kg/m}^3$

Phantom section: Flat Section

DASY5 Configuration:

- Probe: EX3DV4 - SN7329; ConvF(12.56, 12.56, 12.56); Calibrated: 2018/1/22;
- Sensor-Surface: 1.4mm (Mechanical Surface Detection)
- Electronics: DAE4 Sn1459; Calibrated: 2017/9/15
- Phantom: ELI v8.0; Type: QDOVA004AA; Serial: 2051
- Measurement SW: DASY52, Version 52.8 (8);

Area Scan (61x171x1): Interpolated grid: $dx=1.500 \text{ mm}$, $dy=1.500 \text{ mm}$

Maximum value of SAR (interpolated) = 6.32 W/kg

Zoom Scan (5x5x7)/Cube 0: Measurement grid: $dx=8\text{mm}$, $dy=8\text{mm}$, $dz=5\text{mm}$

Reference Value = 38.10 V/m; Power Drift = 0.08 dB

Peak SAR (extrapolated) = 11.5 W/kg

SAR(1 g) = 4.12 W/kg; SAR(10 g) = 2.42 W/kg

Maximum value of SAR (measured) = 7.66 W/kg

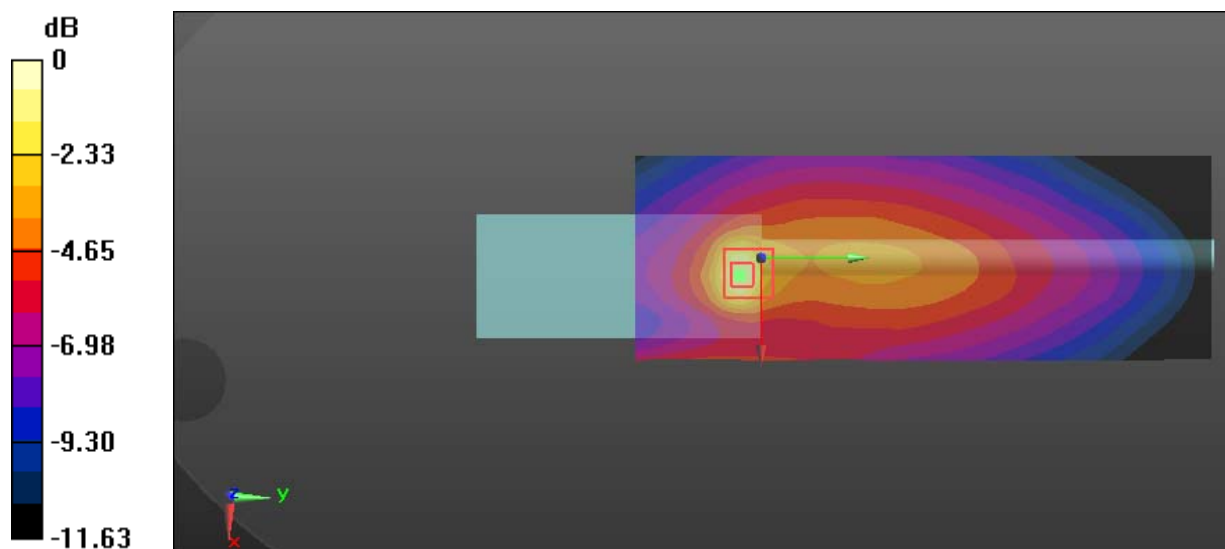

0 dB = 7.66 W/kg = 8.84 dBW/kg

Test Plot 55#: Antenna 4_PTT_FM 12.5kHz_Body Back_160.0125 MHz**DUT: Digital Portable Radio; Type: PD782iG VHF; Serial: 18081600720**

Communication System:FM; Frequency: 160.012 MHz;Duty Cycle: 1:1

Medium parameters used: $f = 160.012$ MHz; $\sigma = 0.823$ S/m; $\epsilon_r = 60.746$; $\rho = 1000$ kg/m³

Phantom section: Flat Section

DASY5 Configuration:

- Probe: EX3DV4 - SN7329; ConvF(12.56, 12.56, 12.56); Calibrated: 2018/1/22;
- Sensor-Surface: 1.4mm (Mechanical Surface Detection)
- Electronics: DAE4 Sn1459; Calibrated: 2017/9/15
- Phantom: ELI v8.0; Type: QDOVA004AA; Serial: 2051
- Measurement SW: DASY52, Version 52.8 (8);

Area Scan (61x171x1): Interpolated grid: dx=1.500 mm, dy=1.500 mm

Maximum value of SAR (interpolated) = 9.54 W/kg

Zoom Scan (5x5x7)/Cube 0: Measurement grid: dx=8mm, dy=8mm, dz=5mm

Reference Value = 75.83 V/m; Power Drift = -0.12 dB

Peak SAR (extrapolated) = 15.1 W/kg

SAR(1 g) = 5.96 W/kg; SAR(10 g) = 3.6 W/kg

Maximum value of SAR (measured) = 10.6 W/kg

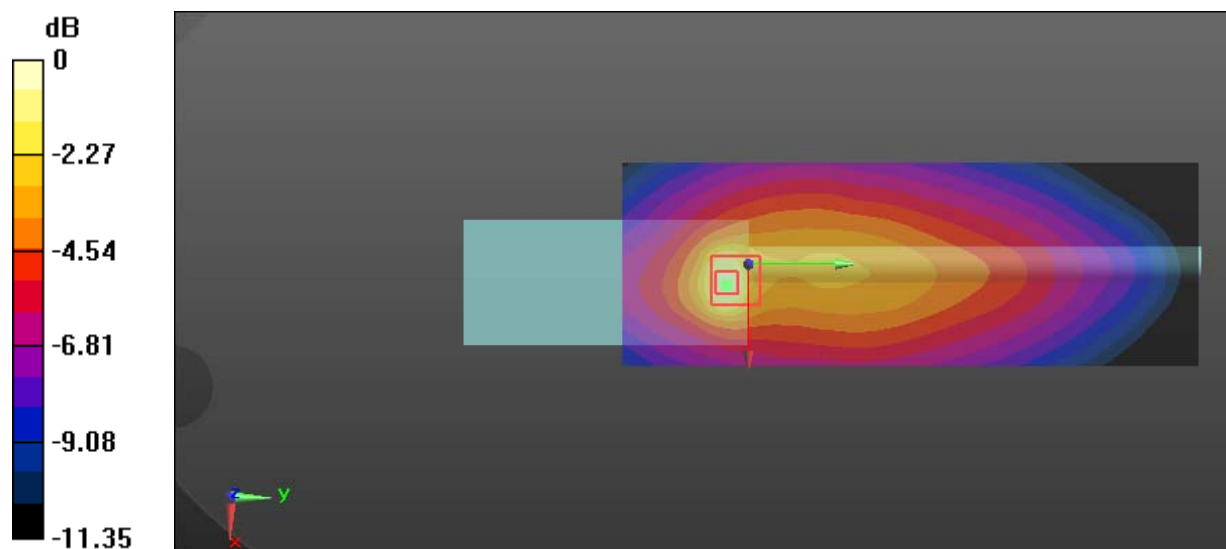

0 dB = 10.6 W/kg = 10.25 dBW/kg

Test Plot 56#: Antenna 4_PTT_FM 12.5kHz_Body Back_173.9875 MHz**DUT: Digital Portable Radio; Type: PD782iG VHF; Serial: 18081600720**

Communication System:FM; Frequency: 173.988 MHz;Duty Cycle: 1:1

Medium parameters used: $f = 173.988$ MHz; $\sigma = 0.841$ S/m; $\epsilon_r = 60.117$; $\rho = 1000$ kg/m³

Phantom section: Flat Section

DASY5 Configuration:

- Probe: EX3DV4 - SN7329; ConvF(12.56, 12.56, 12.56); Calibrated: 2018/1/22;
- Sensor-Surface: 1.4mm (Mechanical Surface Detection)
- Electronics: DAE4 Sn1459; Calibrated: 2017/9/15
- Phantom: ELI v8.0; Type: QDOVA004AA; Serial: 2051
- Measurement SW: DASY52, Version 52.8 (8);

Area Scan (61x171x1): Interpolated grid: dx=1.500 mm, dy=1.500 mm

Maximum value of SAR (interpolated) = 8.64 W/kg

Zoom Scan (5x5x7)/Cube 0: Measurement grid: dx=8mm, dy=8mm, dz=5mm

Reference Value = 76.34 V/m; Power Drift = -0.14 dB

Peak SAR (extrapolated) = 15.1 W/kg

SAR(1 g) = 4.36 W/kg; SAR(10 g) = 1.77 W/kg

Maximum value of SAR (measured) = 9.82 W/kg

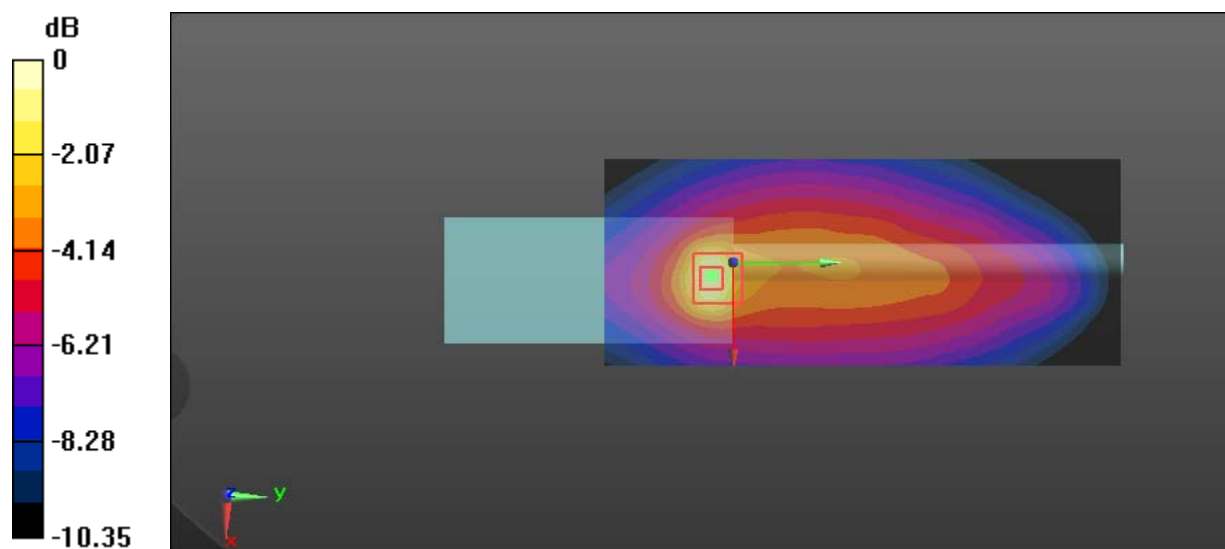

0 dB = 9.82 W/kg = 9.92 dBW/kg

Test Plot 57#: Antenna 4_PTT_FM 25kHz_Body Back_160.0125 MHz**DUT: Digital Portable Radio; Type: PD782iG VHF; Serial: 18081600720**

Communication System:FM; Frequency: 160.012 MHz;Duty Cycle: 1:1

Medium parameters used: $f = 160.012$ MHz; $\sigma = 0.823$ S/m; $\epsilon_r = 60.746$; $\rho = 1000$ kg/m³

Phantom section: Flat Section

DASY5 Configuration:

- Probe: EX3DV4 - SN7329; ConvF(12.56, 12.56, 12.56); Calibrated: 2018/1/22;
- Sensor-Surface: 1.4mm (Mechanical Surface Detection)
- Electronics: DAE4 Sn1459; Calibrated: 2017/9/15
- Phantom: ELI v8.0; Type: QDOVA004AA; Serial: 2051
- Measurement SW: DASY52, Version 52.8 (8);

Area Scan (61x171x1): Interpolated grid: dx=1.500 mm, dy=1.500 mm

Maximum value of SAR (interpolated) = 9.76 W/kg

Zoom Scan (5x5x7)/Cube 0: Measurement grid: dx=8mm, dy=8mm, dz=5mm

Reference Value = 74.33 V/m; Power Drift = -0.17 dB

Peak SAR (extrapolated) = 14.6 W/kg

SAR(1 g) = 5.72 W/kg; SAR(10 g) = 3.45 W/kg

Maximum value of SAR (measured) = 9.90 W/kg

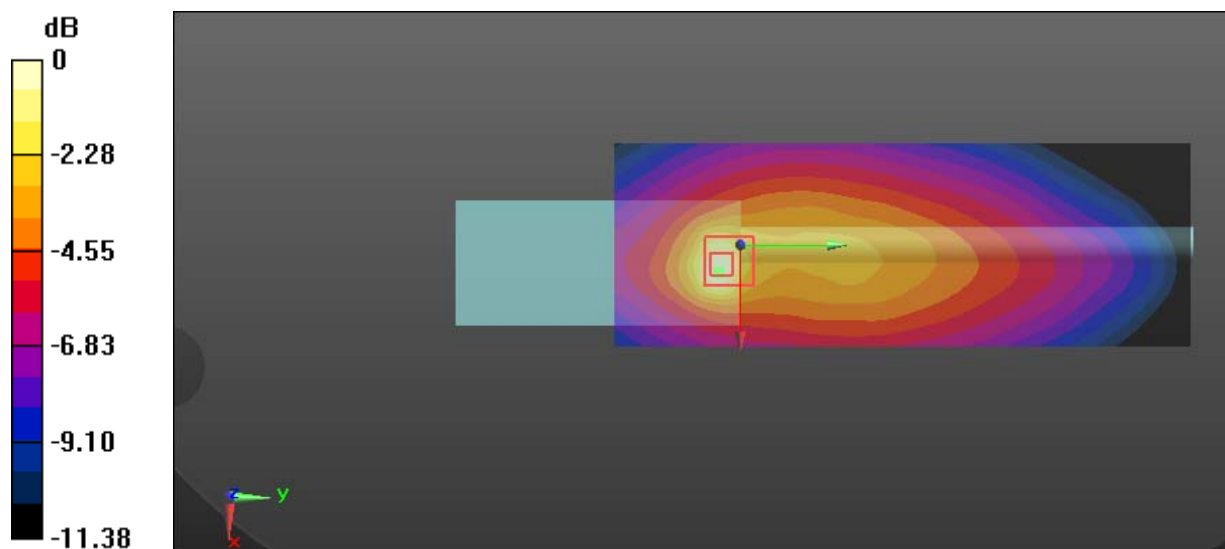

0 dB = 9.90 W/kg = 9.96 dBW/kg

Test Plot 58#: Antenna 4_PTT_4FSK 12.5kHz_Body Back_160.0125 MHz**DUT: Digital Portable Radio; Type: PD782iG VHF; Serial: 18081600720**

Communication System: 4FSK; Frequency: 160.012 MHz; Duty Cycle: 1:2

Medium parameters used: $f = 160.012$ MHz; $\sigma = 0.823$ S/m; $\epsilon_r = 60.746$; $\rho = 1000$ kg/m³

Phantom section: Flat Section

DASY5 Configuration:

- Probe: EX3DV4 - SN7329; ConvF(12.56, 12.56, 12.56); Calibrated: 2018/1/22;
- Sensor-Surface: 1.4mm (Mechanical Surface Detection)
- Electronics: DAE4 Sn1459; Calibrated: 2017/9/15
- Phantom: ELI v8.0; Type: QDOVA004AA; Serial: 2051
- Measurement SW: DASY52, Version 52.8 (8);

Area Scan (61x171x1): Interpolated grid: dx=1.500 mm, dy=1.500 mm

Maximum value of SAR (interpolated) = 4.80 W/kg

Zoom Scan (5x5x7)/Cube 0: Measurement grid: dx=8mm, dy=8mm, dz=5mm

Reference Value = 52.41 V/m; Power Drift = -0.16 dB

Peak SAR (extrapolated) = 7.55 W/kg

SAR(1 g) = 3.04 W/kg; SAR(10 g) = 1.86 W/kg

Maximum value of SAR (measured) = 5.28 W/kg

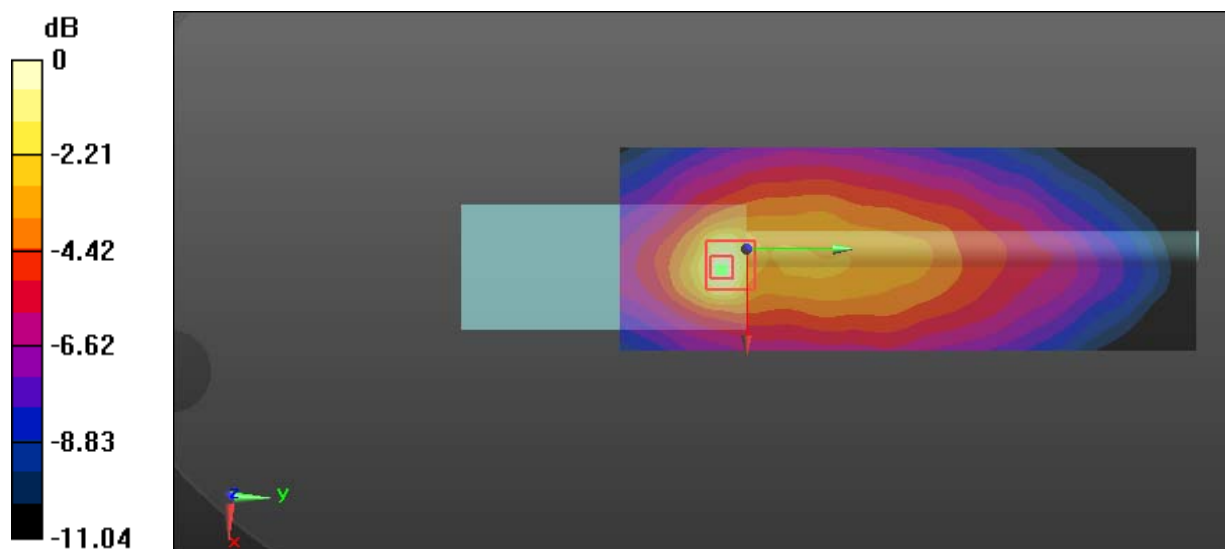

0 dB = 5.28 W/kg = 7.23 dBW/kg

Test Plot 59#: Antenna 4_PTT_FM 12.5kHz_Body Back_160.0125 MHz**DUT: Digital Portable Radio; Type: PD752iG VHF; Serial: 18081600721**

Communication System:FM; Frequency: 160.012 MHz;Duty Cycle: 1:1

Medium parameters used: $f = 160.012$ MHz; $\sigma = 0.823$ S/m; $\epsilon_r = 60.746$; $\rho = 1000$ kg/m³

Phantom section: Flat Section

DASY5 Configuration:

- Probe: EX3DV4 - SN7329; ConvF(12.56, 12.56, 12.56); Calibrated: 2018/1/22;
- Sensor-Surface: 1.4mm (Mechanical Surface Detection)
- Electronics: DAE4 Sn1459; Calibrated: 2017/9/15
- Phantom: ELI v8.0; Type: QDOVA004AA; Serial: 2051
- Measurement SW: DASY52, Version 52.8 (8);

Area Scan (61x171x1): Interpolated grid: dx=1.500 mm, dy=1.500 mm

Maximum value of SAR (interpolated) = 11.3 W/kg

Zoom Scan (5x5x7)/Cube 0: Measurement grid: dx=8mm, dy=8mm, dz=5mm

Reference Value = 76.11 V/m; Power Drift = -0.15 dB

Peak SAR (extrapolated) = 15.0 W/kg

SAR(1 g) = 6.03 W/kg; SAR(10 g) = 3.66 W/kg

Maximum value of SAR (measured) = 10.4 W/kg

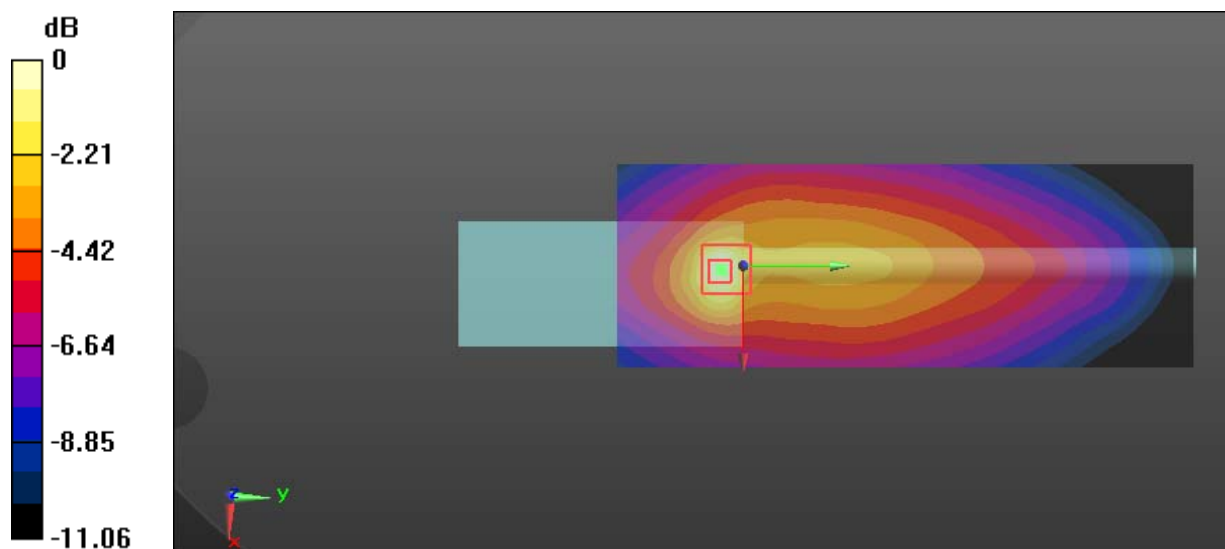

0 dB = 10.4 W/kg = 10.17 dBW/kg

Test Plot 60#: Antenna 4_PTT_FM 12.5kHz_Body Back_160.0125 MHz**DUT: Digital Portable Radio; Type: PD702iG VHF; Serial: 18081600722**

Communication System:FM; Frequency: 160.012 MHz;Duty Cycle: 1:1

Medium parameters used: $f = 160.012$ MHz; $\sigma = 0.823$ S/m; $\epsilon_r = 60.746$; $\rho = 1000$ kg/m³

Phantom section: Flat Section

DASY5 Configuration:

- Probe: EX3DV4 - SN7329; ConvF(12.56, 12.56, 12.56); Calibrated: 2018/1/22;
- Sensor-Surface: 1.4mm (Mechanical Surface Detection)
- Electronics: DAE4 Sn1459; Calibrated: 2017/9/15
- Phantom: ELI v8.0; Type: QDOVA004AA; Serial: 2051
- Measurement SW: DASY52, Version 52.8 (8);

Area Scan (61x171x1): Interpolated grid: dx=1.500 mm, dy=1.500 mm

Maximum value of SAR (interpolated) = 11.6 W/kg

Zoom Scan (5x5x7)/Cube 0: Measurement grid: dx=8mm, dy=8mm, dz=5mm

Reference Value = 75.44 V/m; Power Drift = -0.12 dB

Peak SAR (extrapolated) = 14.8 W/kg

SAR(1 g) = 5.84 W/kg; SAR(10 g) = 3.53 W/kg

Maximum value of SAR (measured) = 10.1 W/kg

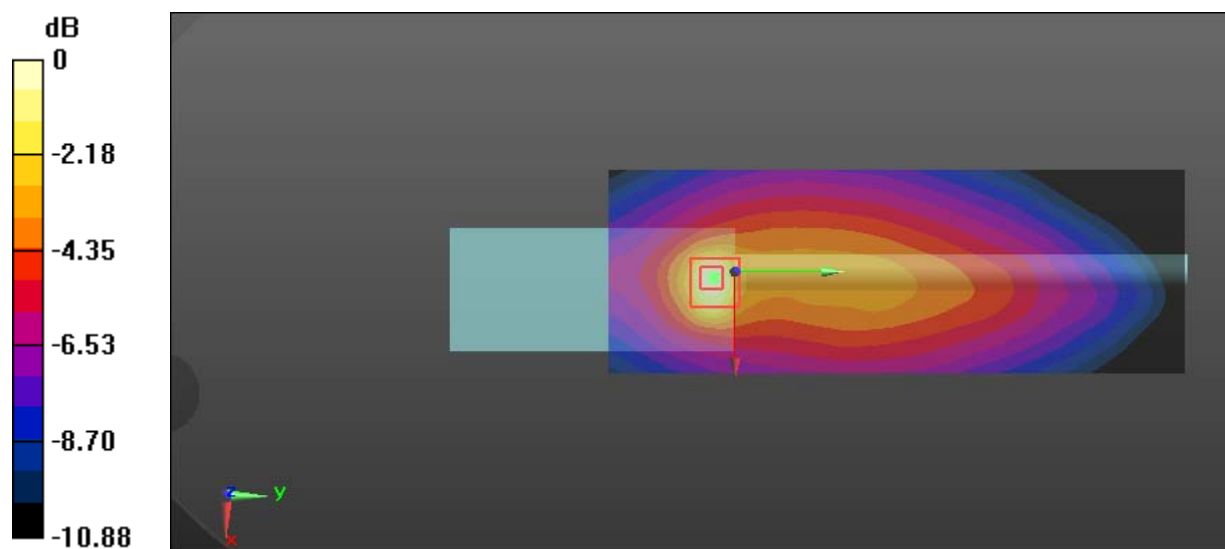

0 dB = 10.1 W/kg = 10.04 dBW/kg