



FCC PART 90 TEST REPORT

FCC Part 90

Report Reference No.	WE10090026
FCC ID	YAMPD78XVHF
Compiled by (position+printed name+signature)...	File administrators Xiankun Ding 
Supervised by (position+printed name+signature)...	Test Engineer Wenliang Li 
Approved by (position+printed name+signature)...	Manager Jimmy Li 
Date of issue.....	Oct 17, 2010
Testing Laboratory Name	Shenzhen Huatongwei International Inspection Co., Ltd
Address	Keji Nan No.12 Road, Hi-tech Park, Shenzhen, China
Applicant's name	Hytera Communications Corporation Ltd.
Address	HYT Tower, Hi-Tech Industrial Park North, Nanshan District, Shenzhen China. 518057
Test specification:	
Standard	FCC Part 90: PRIVATE LAND MOBILE RADIO SERVICES
TRF Originator	Shenzhen Huatongwei International Inspection CO., Ltd
Master TRF	Dated 2006-06
Shenzhen Huatongwei International Inspection Co., Ltd. All rights reserved.	
This publication may be reproduced in whole or in part for non-commercial purposes as long as the Shenzhen Huatongwei International Inspection Co., Ltd is acknowledged as copyright owner and source of the material. Shenzhen Huatongwei International Inspection Co., Ltd takes no responsibility for and will not assume liability for damages resulting from the reader's interpretation of the reproduced material due to its placement and context.	
Test item description	Digital Portable Radio
Trade Mark	
Manufacturer	Hytera Communications Corporation Ltd.
Model/Type reference.....	PD782 VHF/ PD785 VHF/ PD786 VHF/ PD788 VHF/HD785 VHF
Listed Models	/
Ratings	DC 7.40 V
Modulation	FM&4FSK
Channel Separation.....	12.5KHz&25KHz
Rated Power	5Watts(36.99dBm)/1Watts(30 dBm)
Operation Frequency Range	From 136 MHz to 174 MHz
Result.....	Positive

TEST REPORT

Test Report No. :	WE10090026	Oct 17, 2010
		Date of issue

Equipment under Test : Digital Portable Radio

Model /Type : PD782 VHF/ PD785 VHF/ PD786 VHF/ PD788 VHF
/HD785 VHF

Listed Models : /

Applicant : **Hytera Communications Corporation Ltd.**

Address : HYT Tower,Hi-Tech Industrial Park North,Nanshan
District,Shenzhen China.518057

Manufacturer : **Hytera Communications Corporation Ltd.**

Address : HYT Tower,Hi-Tech Industrial Park North,Nanshan
District,Shenzhen China.518057

Test Result according to the standards on page 4:	Positive
--	-----------------

The test report merely corresponds to the test sample.
It is not permitted to copy extracts of these test result without the written permission of the test laboratory.

Contents

1.	<u>TEST STANDARDS</u>	4
2.	<u>SUMMARY</u>	5
2.1.	General Remarks	5
2.2.	Product Description	5
2.3.	Equipment under Test	5
2.4.	Short description of the Equipment under Test (EUT)	6
2.5.	EUT Configuration	6
2.6.	EUT operation mode	6
2.7.	EUT configuration	6
2.8.	Related Submittal(s) / Grant (s)	6
2.9.	Modifications	6
2.10.	Note	7
3.	<u>TEST ENVIRONMENT</u>	8
3.1.	Address of the test laboratory	8
3.2.	Test Facility	8
3.3.	Environmental conditions	9
3.4.	Configuration of Tested System	9
3.5.	Discription of Tested Modes	9
3.6.	Statement of the measurement uncertainty	9
3.7.	Test Description	10
3.8.	Equipments Used during the Test	10
4.	<u>TEST CONDITIONS AND RESULTS</u>	12
4.1.	Conducted Emissions Test	12
4.2.	Occupied Bandwidth and Emission Mask Test	19
4.3.	Transmitter Radiated Spurious Emssion	35
4.4.	Spurious Emssion on Antenna Port	56
4.5.	Modulation Charcateristics	76
4.6.	Frequency Stability Test	81
4.7.	Maximum Transmitter Power	83
4.8.	Transmitter Frequency Behavior	93
4.9.	Receiver Radiated Spurious Emssion	97
4.10.	Receiver Conducted Spurious Emssion	105
5.	<u>TEST SETUP PHOTOS OF THE EUT</u>	115
6.	<u>EXTERNAL AND INTERNAL PHOTOS OF THE EUT</u>	118

1. TEST STANDARDS

The tests were performed according to following standards:

FCC Rules Part 90: PRIVATE LAND MOBILE RADIO SERVICES.

TIA/EIA 603: Land Mobile FM or PM Communications Equipment Measurement and Performance Standards.

ANSI C63.4-2009: American National Standard for Methods of Measurement of Radio-Noise Emissions from Low-Voltage Electrical and Electronic Equipment in the Range of 9 kHz to 40 GHz.

2. SUMMARY

2.1. General Remarks

Date of receipt of test sample	:	Sep 14, 2010
Testing commenced on	:	Sep 14, 2010
Testing concluded on	:	Oct 17, 2010

2.2. Product Description

The Hytera Communications Corporation Ltd.'s Model: PD782 VHF/ PD785 VHF/ PD786 VHF/ PD788 VHF/HD785 VHF or the "EUT" as referred to in this report; more general information as follows, for more details, refer to the user's manual of the EUT.

Name of EUT	Digital Portable Radio	
Model Number	PD782 VHF/ PD785 VHF/ PD786 VHF/ PD788 VHF/HD785 VHF	
FCC ID	YAMPD78XVHF	
Rated Output Power	5 Watts(36.99 dBm)/1 Watts(30.00 dBm)	
Modulation Type	FM for Analog Voice	
	4FSK for Digital Voice/Digital Data	
	4FSK for Digital Data	
Emission Designator	Analog	16K0F3E for 25KHz Channel Separation
		11K0F3E for 12.5KHz Channel Separation
	Digital	7K60FXD for Digital Data only
		7K60FXW for Digital Data & Digital Voice
Channel Separation	Analog Voice	12.5KHz&25KHz
	Digital Voice/Data	12.5KHz
	Digital Data	12.5KHz
Antenna Type	External	
Frequency Range	From 136 MHz to 174 MHz	
Maximum Transmitter Power	Analog	4.80 W for 25 KHz Channel Separation
		4.88 W for 12.5 KHz Channel Separation
	Digital	4.84 W for 12.5 KHz Channel Separation

Note: The product has the same digital working characters when operating in both two digitized voice/data mode (7K60FXD and 7K60FXW). So only one set of test results for digital modulation modes are provided in this test report.

2.3. Equipment under Test

Power supply system utilised

Power supply voltage	:	<input type="radio"/> 120V / 60 Hz	<input type="radio"/> 115V / 60Hz
		<input type="radio"/> 12 V DC	<input type="radio"/> 24 V DC
		<input checked="" type="radio"/> Other (specified in blank below)	

DC 7.40V from battery

Test frequency list

Modulation Type	Test Channel	Test Frequency
Analog/FM	Low Channel	136.1220 MHz
	Middle Channel	152.1220 MHz
	High Channel	173.9220 MHz
Digital/4FSK	Low Channel	136.1220 MHz
	Middle Channel	152.1220 MHz
	High Channel	173.9220 MHz

2.4. Short description of the Equipment under Test (EUT)

136-174 MHz V frequency band Digital Portable Radio (PD782 VHF/ PD785 VHF/ PD786 VHF/ PD788 VHF/HD785 VHF).

For more details, refer to the user’s manual of the EUT.

Serial number: Prototype

2.5. EUT Configuration

The EUT configuration for testing is installed on RF field strength measurement to meet the Commission’s requirement and operating in a manner which intends to maximize its emission characteristics in a continuous normal application.

2.6. EUT operation mode

The EUT has been tested under typical operating condition and The Transmitter was operated in the normal operating mode. The TX frequency was fixed which was for the purpose of the measurements.

2.7. EUT configuration

The following peripheral devices and interface cables were connected during the measurement:

- supplied by the manufacturer
- supplied by the lab

<input type="radio"/>	Power Cable	Length (m) :	/
		Shield :	/
		Detachable :	/
<input type="radio"/>	Multimeter	Manufacturer :	/
		Model No. :	/

2.8. Related Submittal(s) / Grant (s)

This submittal(s) (test report) is intended for FCC ID: **YAMPD78XVHF** filing to comply with FCC Part 90 Rules

2.9. Modifications

No modifications were implemented to meet testing criteria.

2.10. Note

1. The EUT is is a V frequency band (136-174MHz) Digital Portable Radio,The functions of the EUT listed as below:
- 2.

	Test Standards	Reference Report
Radio	FCC Part 90	WE10090016

3. TEST ENVIRONMENT

3.1. Address of the test laboratory

Shenzhen Huatongwei International Inspection Co., Ltd
Keji Nan No.12 Road, Hi-tech Park, Shenzhen, China
Phone: 86-755-26715686 Fax: 86-755-26748089

The sites are constructed in conformance with the requirements of ANSI C63.7, ANSI C63.4 (2009) and CISPR Publication 22.

3.2. Test Facility

The test facility is recognized, certified, or accredited by the following organizations:

CNAS-Lab Code: L1225

Shenzhen Huatongwei International Inspection Co., Ltd has been assessed and proved to be in compliance with CNAS-CL01 Accreditation Criteria for Testing and Calibration Laboratories (identical to ISO/IEC 17025: 2005 General Requirements) for the Competence of Testing and Calibration Laboratories, Date of Registration: August 02, 2007. Valid time is until March 29, 2012.

A2LA-Lab Cert. No. 2243.01

Shenzhen Huatongwei International Inspection Co., Ltd, EMC Laboratory has been accredited by A2LA for technical competence in the field of electrical testing, and proved to be in compliance with ISO/IEC 17025: 2005 General Requirements for the Competence of Testing and Calibration Laboratories and any additional program requirements in the identified field of testing. Valid time to Sep 30, 2011.

FCC-Registration No.: 662850

Shenzhen Huatongwei International Inspection Co., Ltd, EMC Laboratory has been registered and fully described in a report filed with the FCC (Federal Communications Commission). The acceptance letter from the FCC is maintained in our files. Registration 662850, Renewal date July 01, 2009.

IC-Registration No.: 5377

The 3m Alternate Test Site of Shenzhen Huatongwei International Inspection Co., Ltd has been registered by Certification and Engineering Bureau of Industry Canada for the performance of radiated measurements with Registration No. 5377 on February 13th, 2009.

ACA

Shenzhen Huatongwei International Inspection Co., Ltd, EMC Laboratory can also perform testing for the Australian C-Tick mark as a result of our A2LA accreditation.

NEMKO-Aut. No.: ELA125

Shenzhen Huatongwei International Inspection Co., Ltd has been assessed the quality assurance system, the testing facilities, qualifications and testing practices of the relevant parts of the organization. The quality assurance system of the Laboratory has been validated against ISO/IEC 17025:2005 or equivalent. The laboratory also fulfils the conditions described in Nemko Document NLA-10; the Authorization is valid through July 07, 2011.

VCCI

The 3m Semi-anechoic chamber (12.2m×7.95m×6.7m) and Shielded Room (8m×4m×3m) of Shenzhen Huatongwei International Inspection Co., Ltd has been registered in accordance with the Regulations for Voluntary Control Measures with Registration No.: R-2484. Date of Registration: December 20, 2009. Valid time is until December 19, 2012.

Main Ports Conducted Interference Measurement of Shenzhen Huatongwei International Inspection Co., Ltd has been registered in accordance with the Regulations for Voluntary Control Measures with Registration No.: C-2726. Date of Registration: December 20, 2009. Valid time is until December 19, 2012.

DNV

Shenzhen Huatongwei International Inspection Co Ltd has been found to comply with the requirements of DNV towards subcontractor of EMC and safety testing services in conjunction with the EMC and Low voltage Directives and in the voluntary field. The acceptance is based on a formal quality Audit and follow-ups according to relevant parts of ISO/IEC Guide 17025(2005), in accordance with the requirements of the DNV Laboratory Quality Manual towards subcontractors. Valid time is until 24 August, 2013.

3.3. Environmental conditions

During the measurement the environmental conditions were within the listed ranges:

Temperature:	15-35 ° C
Humidity:	30-60 %
Atmospheric pressure:	950-1050mbar

3.4. Configuration of Tested System

Fig. 2-1 Configuration of Tested System

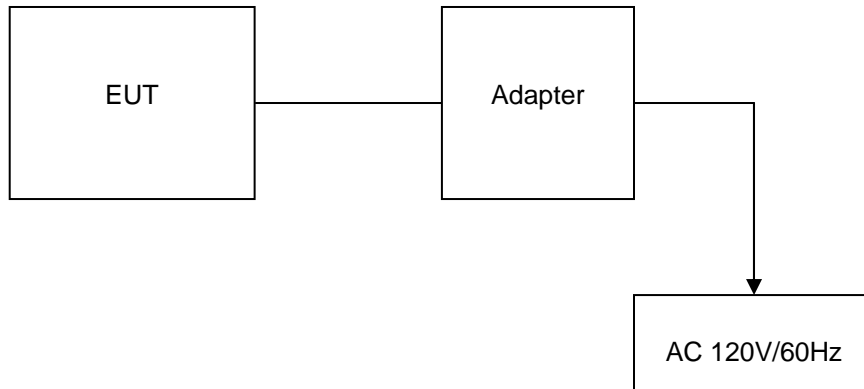

Table 2-1 Equipment Used in Tested System

Adapter: P/N: PS1014
 Model: DSA-15P-12 US 120120
 Input:100-240V~50/60Hz 0.5A
 Output: +12V DC 1A
 Power Cable: 180cm
 ◇ Shielded ◆ Unshielded

3.5. Discription of Tested Modes

The EUT (Didital Portable Radio) has been tested under normal operating condition. Three channels (the high, the middle and the low) are chosen for testing at each channel separation (12.5 KHz/ 25KHz).

3.6. Statement of the measurement uncertainty

The data and results referenced in this document are true and accurate. The reader is cautioned that there may be errors within the calibration limits of the equipment and facilities. The measurement uncertainty was calculated for all measurements listed in this test report acc. to CISPR 16 - 4 „Specification for radio disturbance and immunity measuring apparatus and methods – Part 4: Uncertainty in EMC Measurements“ and is documented in the Shenzhen Huatongwei International Inspection Co., Ltd quality system acc. to DIN EN ISO/IEC 17025. Furthermore, component and process variability of devices similar to that tested may result in additional deviation. The manufacturer has the sole responsibility of continued compliance of the device.

Hereafter the best measurement capability for Shenzhen Huatongwei laboratory is reported:

Test	Range	Measurement Uncertainty	Notes
Radiated Emission	30~1000MHz	4.24 dB	(1)
Radiated Emission	1~18GHz	5.16 dB	(1)
Radiated Emission	18-40GHz	5.54 dB	(1)
Conducted Disturbance	0.15~30MHz	3.39 dB	(1)

(1) This uncertainty represents an expanded uncertainty expressed at approximately the 95% confidence level using a coverage factor of k=2.

3.7. Test Description

FCC Rules	Description of Test	Test Result
§ 15.107	Conducted Emission	Complies
§ 15.109	Receiver Radiated Spurious Emssion	Complies
§ 15.109	Receiver Conducted Spurious Emssion	Complies
§ 90.205	Maximum Transmitter Power	Complies
§ 90.207	Modulation Characteristic	Complies
§ 90.209	Occupied Bandwidth	Complies
§ 90.210	Emission Mask	Complies
§ 90.213	Frequency Stability	Complies
§ 90.214	Transmitter Frequency Behavior	Complies
§ 90.210	Transmitter Radiated Spurious Emssion	Complies
§ 90.210	Spurious Emssion On Antenna Port	Complies

3.8. Equipments Used during the Test

AC Power Conducted Emission				
Name of Equipment	Manufacturer	Model	Serial Number	Calibration Due
Artificial Mains	Rohde&Schwarz	ESH2-Z5	100028	11/2010
EMI Test Receiver	Rohde&Schwarz	ESCS 30	100038	11/2010
Pulse Limiter	Rohde&Schwarz	ESHSZ2	100044	11/2010
EMI Test Software	Rohde&Schwarz	ES-K1 V1.71	N/A	11/2010

Modulation Characteristic				
Name of Equipment	Manufacturer	Model	Serial Number	Calibration Due
Modulation Analyzer	HP	8901B	3104A03367	11/2010
Signal Generator	Rohde&Schwarz	SMT03	100059	11/2010
RF COMMUNICATION TEST SET	HP	8920A	3813A10206	11/2010

Transmitter Radiated Spurious Emission & Occupied Bandwidth & Emission Mask & Receiver Radiated Spurious Emission				
Name of Equipment	Manufacturer	Model	Serial Number	Calibration Due
Ultra-Broadband Antenna	Rohde&Schwarz	HL562	100015	11/2010
EMI Test Receiver	Rohde&Schwarz	ESI 26	100009	11/2010
RF Test Panel	Rohde&Schwarz	TS / RSP	335015/ 0017	N/A
HORN ANTENNA	Rohde&Schwarz	HF906	100039	11/2010
Turntable	ETS	2088	2149	N/A
Antenna Mast	ETS	2075	2346	N/A
EMI Test Software	Rohde&Schwarz	ES-K1 V1.71	N/A	11/2010
RF COMMUNICATION TEST SET	HP	8920A	3813A10206	11/2010

Frequency Stability				
Name of Equipment	Manufacturer	Model	Serial Number	Calibration Due
Communication Test Set	HP	HP8920B	US35010135	11/2010
Signal Generator	Rohde&Schwarz	SMT03	100059	11/2010
Climate Chamber	ESPEC	EL-10KA	05107008	11/2010

Maximum Transmitter Power & Spurious Emission On Antenna Port				
Name of Equipment	Manufacturer	Model	Serial Number	Calibration Due
Receiver	Rohde&Schwarz	ESI 26	100009	11/2010
Attenuator	R&S	ESH3-22	100449	11/2010
RF COMMUNICATION TEST SET	HP	8920A	3813A10206	11/2010
High-Pass Filter	Anritsu	MP526B	6220875256	11/2010
High-Pass Filter	Anritsu	MP526D	6220878392	11/2010

Transient Frequency Behavior				
Name of Equipment	Manufacturer	Model	Serial Number	Calibration Due
Signal Generator	Rohde&Schwarz	SMT03	100059	11/2010
Storage Oscilloscope	Tektronix	TDS3054B	B033027	11/2010
RF COMMUNICATION TEST SET	HP	8920A	3813A10206	11/2010

4. TEST CONDITIONS AND RESULTS

4.1. Conducted Emissions Test

TEST APPLICABLE

The EUT was tested according to ANSI C63.4 - 2009. The frequency spectrum from 0.15 MHz to 30 MHz was investigated. The LISN used was 50 ohm / 50 u Henry as specified by section 5.1 of ANSI C63.4 - 2009. Cables and peripherals were moved to find the maximum emission levels for each frequency.

TEST CONFIGURATION

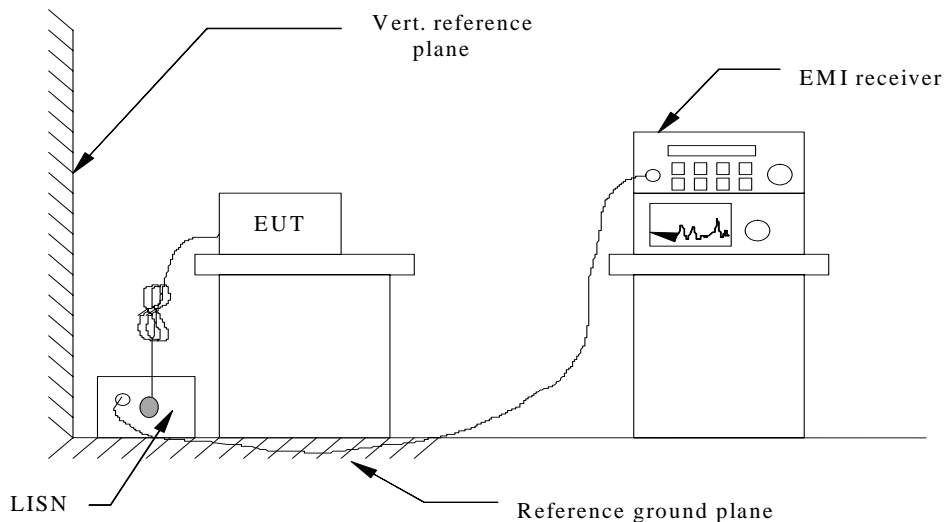

TEST PROCEDURE

- 1 The equipment was set up as per the test configuration to simulate typical actual usage per the user's manual. The EUT is a tabletop system; a wooden table with a height of 0.8 meters is used and is placed on the ground plane as per ANSI C63.4-2009.
- 2 Support equipment, if needed, was placed as per ANSI C63.4-2009.
- 3 All I/O cables were positioned to simulate typical actual usage as per ANSI C63.4-2009.
- 4 If a EUT received DC power from the adapter, the adapter received AC120V/60Hz power through a Line Impedance Stabilization Network (LISN) which supplied power source and was grounded to the ground plane.
- 5 All support equipments received AC power from a second LISN, if any.
- 6 The EUT test program was started. Emissions were measured on each current carrying line of the EUT using a spectrum Analyzer / Receiver connected to the LISN powering the EUT. The LISN has two monitoring points: Line 1 (Hot Side) and Line 2 (Neutral Side). Two scans were taken: one with Line 1 connected to Analyzer / Receiver and Line 2 connected to a 50 ohm load; the second scan had Line 1 connected to a 50 ohm load and Line 2 connected to the Analyzer / Receiver.
- 7 Analyzer / Receiver scanned from 150 KHz to 30MHz for emissions in each of the test modes.
- 8 During the above scans, the emissions were maximized by cable manipulation.

Conducted Power Line Emission Limit

For unintentional device, according to § 15.107(a) Line Conducted Emission Limits is as following :

Frequency (MHz)	Maximum RF Line Voltage (dBµV)			
	CLASS A		CLASS B	
	Q.P.	Ave.	Q.P.	Ave.
0.15 - 0.50	79	66	66-56*	56-46*
0.50 - 5.00	73	60	56	46
5.00 - 30.0	73	60	60	50

* Decreasing linearly with the logarithm of the frequency

For intentional device, according to §15.207(a) Line Conducted Emission Limit is same as above table.

TEST RESULTS

For FM Modulation @ 12.5 KHz

SCAN TABLE: "Voltage (9K-30M) FIN"

Short Description: 150K-30M Voltage

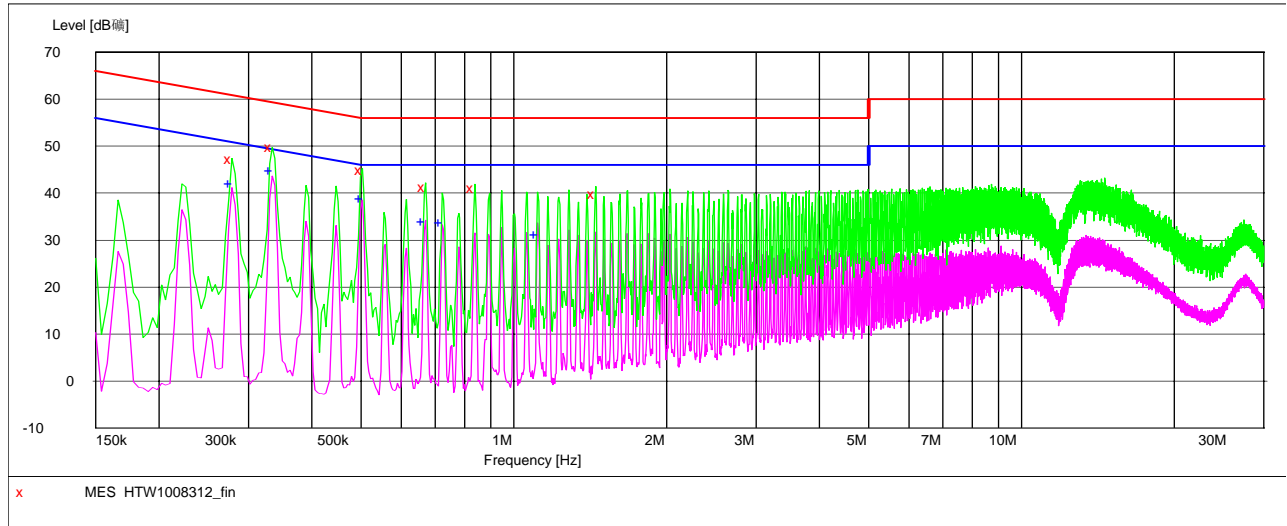

MEASUREMENT RESULT: "HTW1008312_fin"

10/8/2010 10:25AM

Frequency MHz	Level dBµV	Transd dB	Limit dBµV	Margin dB	Detector	Line	PE
0.278000	47.10	10.5	61	13.8	QP	L1	GND
0.334000	49.80	10.5	59	9.6	QP	L1	GND
0.502000	44.80	10.4	56	11.2	QP	L1	GND
0.670000	41.30	10.4	56	14.7	QP	L1	GND
0.834000	41.10	10.4	56	14.9	QP	L1	GND
1.446000	39.70	10.5	56	16.3	QP	L1	GND

MEASUREMENT RESULT: "HTW1008312_fin2"

10/8/2010 10:25AM

Frequency MHz	Level dBµV	Transd dB	Limit dBµV	Margin dB	Detector	Line	PE
0.278000	42.20	10.5	51	8.7	AV	L1	GND
0.334000	44.80	10.5	49	4.6	AV	L1	GND
0.502000	38.90	10.4	46	7.1	AV	L1	GND
0.666000	34.10	10.4	46	11.9	AV	L1	GND
0.722000	33.90	10.4	46	12.1	AV	L1	GND
1.114000	31.40	10.5	46	14.6	AV	L1	GND

SCAN TABLE: "Voltage (9K-30M) FIN"

Short Description: 150K-30M Voltage

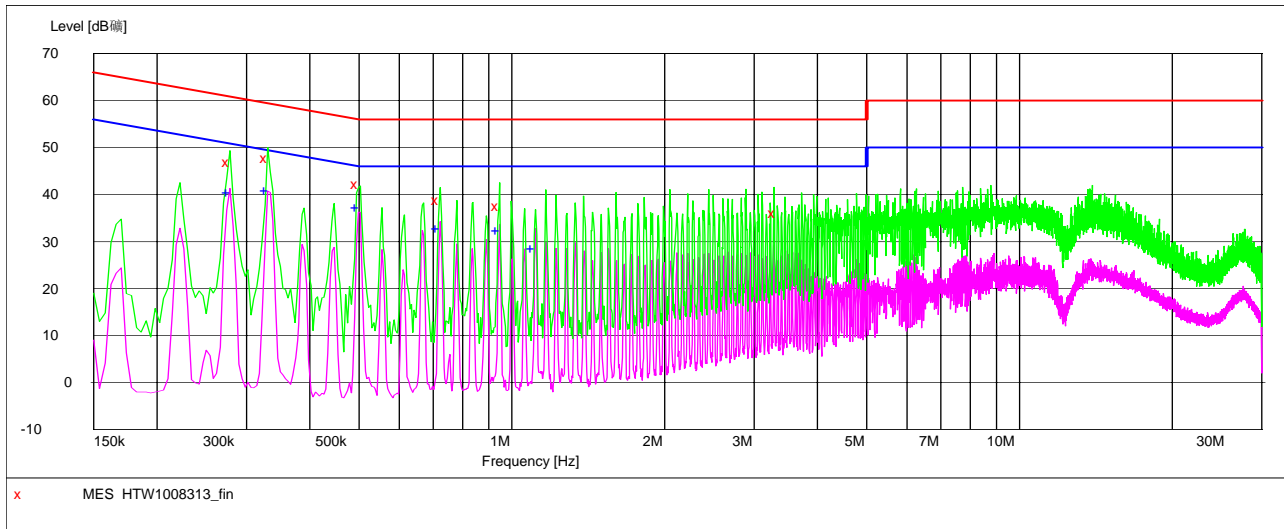

MEASUREMENT RESULT: "HTW1008313_fin"

10/8/2010 10:27AM

Frequency MHz	Level dBμV	Transd dB	Limit dBμV	Margin dB	Detector	Line	PE
0.278000	46.90	10.5	61	14.0	QP	N	GND
0.330000	47.80	10.5	60	11.7	QP	N	GND
0.498000	42.30	10.4	56	13.7	QP	N	GND
0.718000	38.90	10.4	56	17.1	QP	N	GND
0.942000	37.50	10.5	56	18.5	QP	N	GND
3.310000	36.10	10.5	56	19.9	QP	N	GND

MEASUREMENT RESULT: "HTW1008313_fin2"

10/8/2010 10:27AM

Frequency MHz	Level dBμV	Transd dB	Limit dBμV	Margin dB	Detector	Line	PE
0.278000	40.50	10.5	51	10.4	AV	N	GND
0.330000	41.00	10.5	50	8.5	AV	N	GND
0.498000	37.40	10.4	46	8.6	AV	N	GND
0.718000	32.80	10.4	46	13.2	AV	N	GND
0.942000	32.50	10.5	46	13.5	AV	N	GND
1.106000	28.70	10.5	46	17.3	AV	N	GND

For FM Modulation @ 25 KHz

SCAN TABLE: "Voltage (9K-30M) FIN"

Short Description: 150K-30M Voltage

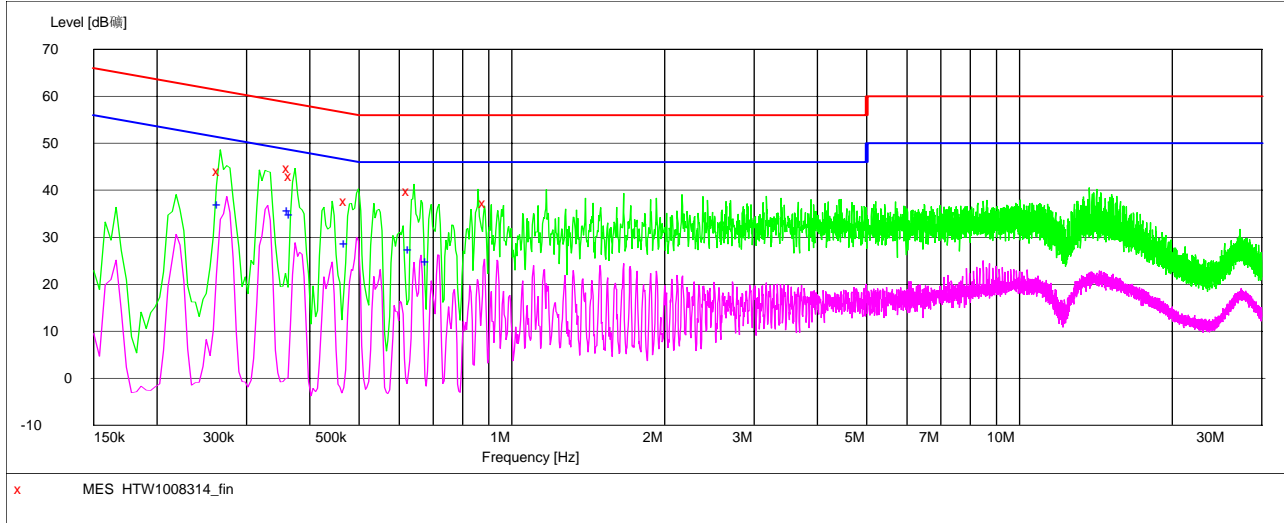

MEASUREMENT RESULT: "HTW1008314_fin"

10/8/2010 10:31AM

Frequency MHz	Level dBμV	Transd dB	Limit dBμV	Margin dB	Detector	Line	PE
0.266000	44.10	10.5	61	17.1	QP	N	GND
0.366000	44.70	10.5	59	13.9	QP	N	GND
0.370000	42.90	10.5	59	15.6	QP	N	GND
0.474000	37.70	10.4	56	18.7	QP	N	GND
0.630000	39.80	10.4	56	16.2	QP	N	GND
0.890000	37.20	10.4	56	18.8	QP	N	GND

MEASUREMENT RESULT: "HTW1008314_fin2"

10/8/2010 10:31AM

Frequency MHz	Level dBμV	Transd dB	Limit dBμV	Margin dB	Detector	Line	PE
0.266000	37.00	10.5	51	14.2	AV	N	GND
0.366000	35.80	10.5	49	12.8	AV	N	GND
0.370000	35.00	10.5	49	13.5	AV	N	GND
0.474000	28.70	10.4	46	17.7	AV	N	GND
0.634000	27.40	10.4	46	18.6	AV	N	GND
0.686000	24.90	10.4	46	21.1	AV	N	GND

SCAN TABLE: "Voltage (9K-30M) FIN"

Short Description: 150K-30M Voltage

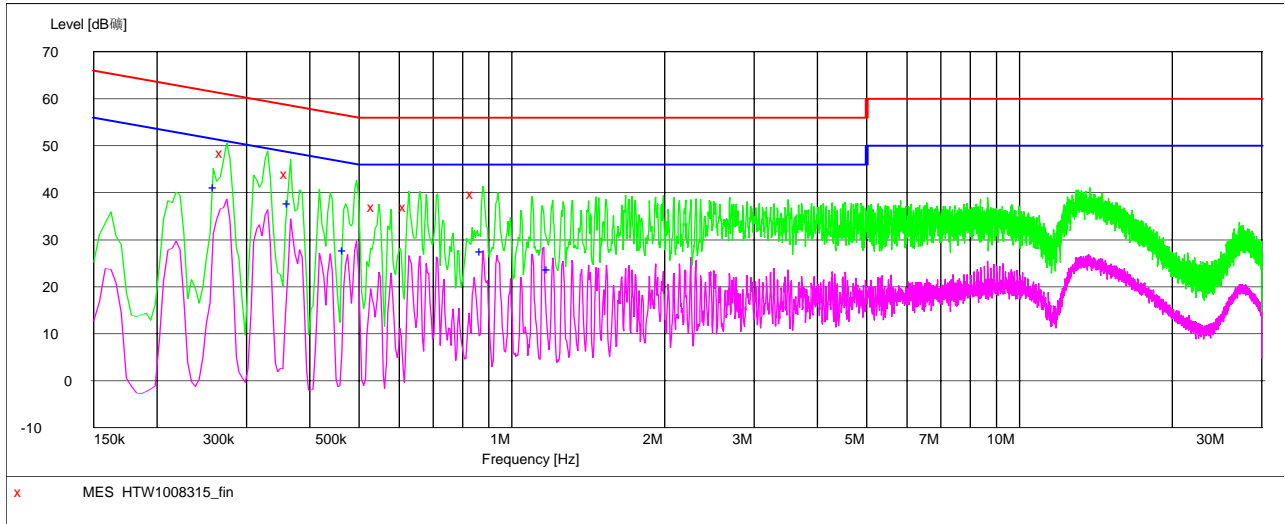

MEASUREMENT RESULT: "HTW1008315_fin"

10/8/2010 10:33AM

Frequency MHz	Level dBμV	Transd dB	Limit dBμV	Margin dB	Detector	Line	PE
0.270000	48.50	10.5	61	12.6	QP	L1	GND
0.362000	44.00	10.5	59	14.7	QP	L1	GND
0.538000	36.90	10.4	56	19.1	QP	L1	GND
0.622000	36.90	10.4	56	19.1	QP	L1	GND
0.842000	39.80	10.4	56	16.2	QP	L1	GND

MEASUREMENT RESULT: "HTW1008315_fin2"

10/8/2010 10:33AM

Frequency MHz	Level dBμV	Transd dB	Limit dBμV	Margin dB	Detector	Line	PE
0.262000	41.30	10.5	51	10.1	AV	L1	GND
0.366000	37.80	10.5	49	10.8	AV	L1	GND
0.470000	27.90	10.4	47	18.6	AV	L1	GND
0.878000	27.50	10.4	46	18.5	AV	L1	GND
1.190000	23.80	10.5	46	22.2	AV	L1	GND

For FSK Modulation @ 12.5 KHz

SCAN TABLE: "Voltage (9K-30M) FIN"

Short Description: 150K-30M Voltage

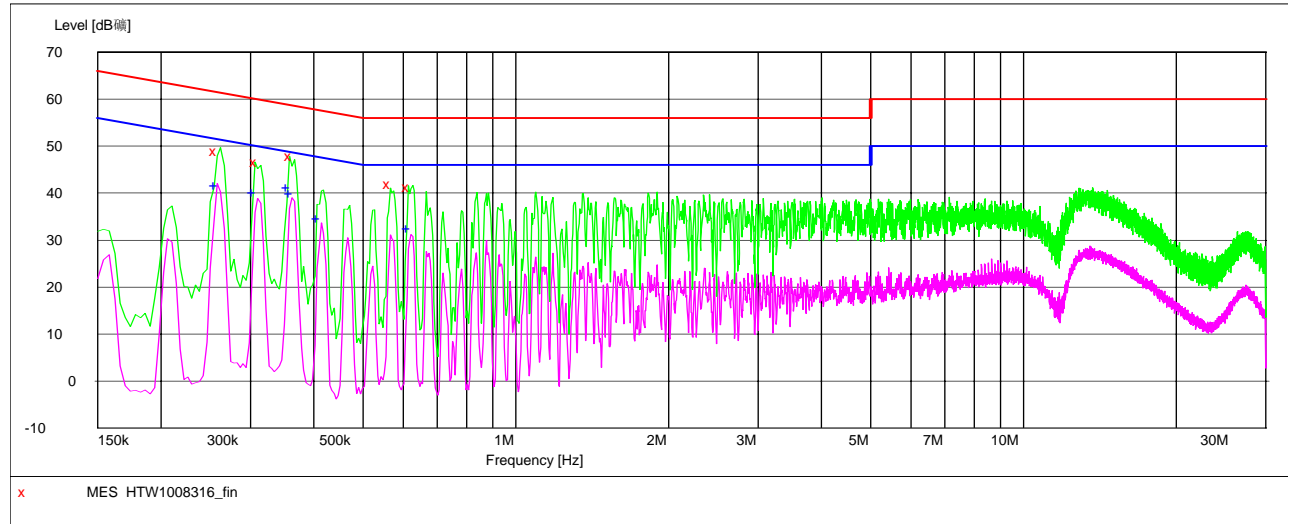

MEASUREMENT RESULT: "HTW1008316_fin"

10/8/2010 10:36AM

Frequency MHz	Level dBμV	Transd dB	Limit dBμV	Margin dB	Detector	Line	PE
0.258000	48.90	10.5	62	12.6	QP	L1	GND
0.310000	46.50	10.5	60	13.5	QP	L1	GND
0.362000	47.90	10.5	59	10.8	QP	L1	GND
0.566000	41.90	10.4	56	14.1	QP	L1	GND
0.618000	41.20	10.4	56	14.8	QP	L1	GND

MEASUREMENT RESULT: "HTW1008316_fin2"

10/8/2010 10:36AM

Frequency MHz	Level dBμV	Transd dB	Limit dBμV	Margin dB	Detector	Line	PE
0.258000	41.80	10.5	52	9.7	AV	L1	GND
0.306000	40.20	10.5	50	9.9	AV	L1	GND
0.358000	41.20	10.5	49	7.6	AV	L1	GND
0.362000	40.00	10.5	49	8.7	AV	L1	GND
0.410000	34.70	10.4	48	12.9	AV	L1	GND
0.618000	32.50	10.4	46	13.5	AV	L1	GND

SCAN TABLE: "Voltage (9K-30M) FIN"

Short Description: 150K-30M Voltage

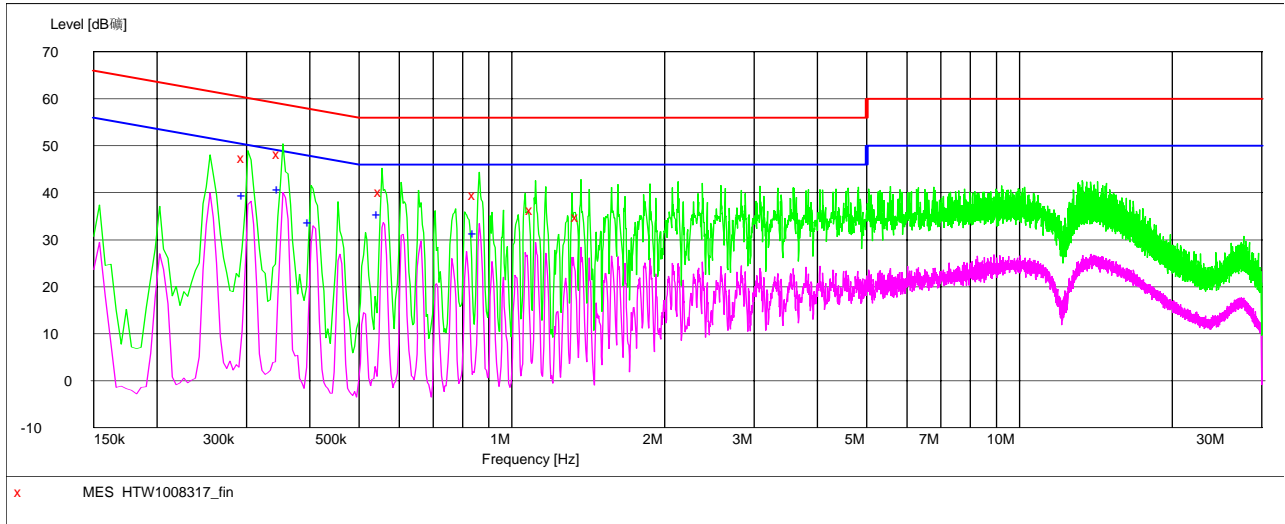

MEASUREMENT RESULT: "HTW1008317_fin"

10/8/2010 10:40AM

Frequency MHz	Level dBμV	Transd dB	Limit dBμV	Margin dB	Detector	Line	PE
0.298000	47.30	10.5	60	13.0	QP	N	GND
0.350000	48.30	10.5	59	10.7	QP	N	GND
0.554000	40.10	10.4	56	15.9	QP	N	GND
0.850000	39.50	10.4	56	16.5	QP	N	GND
1.102000	36.20	10.5	56	19.8	QP	N	GND
1.354000	34.90	10.5	56	21.1	QP	N	GND

MEASUREMENT RESULT: "HTW1008317_fin2"

10/8/2010 10:40AM

Frequency MHz	Level dBμV	Transd dB	Limit dBμV	Margin dB	Detector	Line	PE
0.298000	39.40	10.5	50	10.9	AV	N	GND
0.350000	40.80	10.5	49	8.2	AV	N	GND
0.402000	33.80	10.5	48	14.0	AV	N	GND
0.550000	35.40	10.4	46	10.6	AV	N	GND
0.850000	31.40	10.4	46	14.6	AV	N	GND

4.2. Occupied Bandwidth and Emission Mask Test

TEST APPLICABLE

- (a). Occupied Bandwidth: The EUT was connected to the audio signal generator and the spectrum analyzer via the main RF connector, and through an appropriate attenuator. The EUT was controlled to transmit its maximum power. Then the bandwidth of 99% power can be measured by the spectrum analyzer.
- (b). Emission Mask B: For transmitters that are equipped with an audio low-pass filter pursuant to §90.211(a), the power of any emission must be below the unmodulated carrier power (P) as follows:
- (1) On any frequency removed from the assigned frequency by more than 50 percent, but not more than 100 percent of the authorized bandwidth: At least 25 dB.
 - (2) On any frequency removed from the assigned frequency by more than 100 percent, but not more than 250 percent of the authorized bandwidth: At least 35 dB.
 - (3) On any frequency removed from the assigned frequency by more than 250 percent of the authorized bandwidth: At least $43 + 10 \log (P)$ dB.
- (c). Emission Mask D, 12.5 kHz channel bandwidth equipment: For transmitters designed to operate with a 12.5 kHz channel bandwidth, any emission must be attenuated below the power (P) of the highest emission contained within the authorized bandwidth as follows:
- (1) On any frequency from the center of the authorized bandwidth f_0 to 5.625 kHz removed from f_0 : Zero dB.
 - (2) On any frequency removed from the center of the authorized bandwidth by a displacement frequency (f_d in kHz) of more than 5.625 kHz but no more than 12.5 kHz: At least $7.27(f_d - 2.88 \text{ kHz})$ dB.
 - (3) On any frequency removed from the center of the authorized bandwidth by a displacement frequency (f_d in kHz) of more than 12.5 kHz: At least $50 + 10 \log (P)$ dB or 70 dB, whichever is the lesser attenuation.

TEST CONFIGURATION

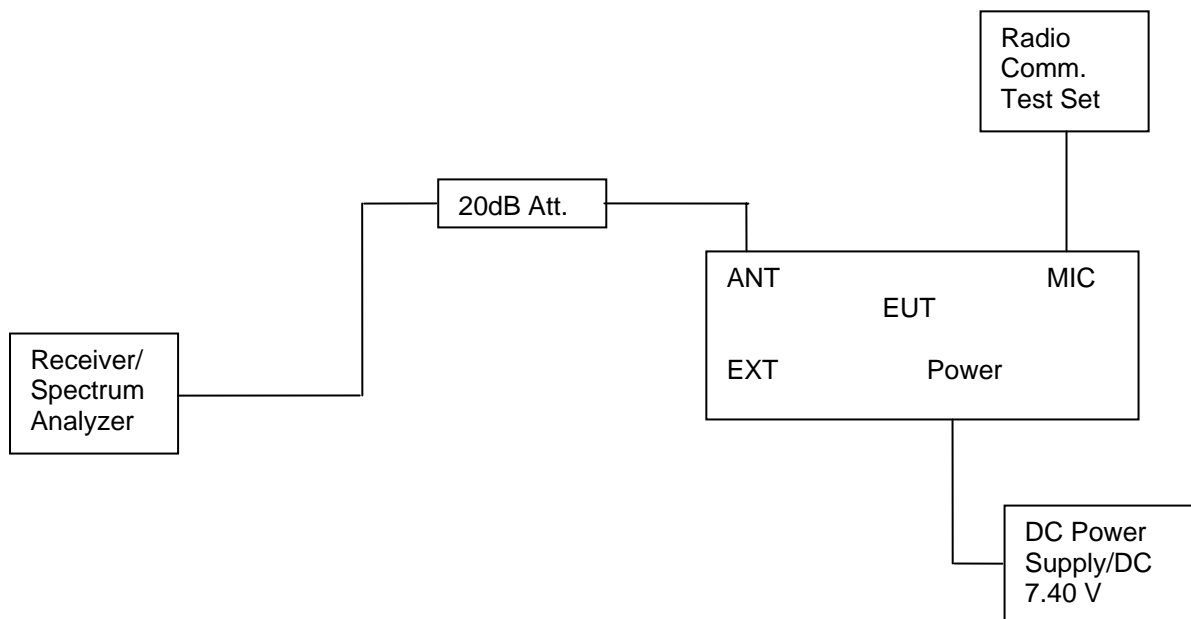

TEST PROCEDURE

- 1 The EUT was placed on a turn table which is 0.8m above ground plane.
- 2 The EUT was modulated by 2.5 KHz Sine wave audio signal; the level of the audio signal employed is 16 dB greater than that necessary to produce 50% of rated system deviation. Rated system deviation is 2.5 kHz (12.5 kHz channel spacing) and 5 kHz (25 kHz channel spacing).
- 3 Set EUT as normal operation.
- 4 Set SPA Center Frequency = fundamental frequency, RBW=300Hz, VBW= 3 KHz, span =50 KHz.
- 5 Set SPA Max hold. Mark peak, Set 99% Occupied Bandwidth and 26dB Occupied Bandwidth.
- 6 Set SPA Center Frequency=fundamental frequency, RBW=300Hz, VBW=3 KHz span=50 KHz for 25 KHz channel spacing, while RBW=100Hz, VBW=300Hz, span=50 KHz for 12.5 channel spacing.

TEST RESULTS

4.2.1 Occupied Bandwidth

Modulation Type	Channel Separation	Test Channel	Test Frequency	99% Occupied Bandwidth	26dB Occupied Band width
FM	25KHz	Low	136.1220 MHz	15.73 KHz	16.63 KHz
		Middle	152.1220 MHz	15.63 KHz	16.63 KHz
		High	173.9220 MHz	15.73 KHz	16.63 KHz
	12.5KHz	Low	136.1220 MHz	9.82 KHz	10.62 KHz
		Middle	152.1220 MHz	9.82 KHz	10.62 KHz
		High	173.9220 MHz	9.92 KHz	10.52 KHz
4FSK	12.5KHz	Low	136.1220 MHz	7.41 KHz	9.12 KHz
		Middle	152.1220 MHz	7.41 KHz	9.52 KHz
		High	173.9220 MHz	7.52 KHz	9.02 KHz
Limit		20kHz for 25KHz Channel Separation			
Limit		11.25KHz for 12.5KHz Channel Separation			
Test Results		Compliance			

Plots of 99% and 26dB Bandwidth Measurement

Modulation Type	Channel Separation	Freq.(MHz)	99% Bandwidth (KHz)	26dB Bandwidth (KHz)	FCC Limit (KHz)	Results
FM	25 KHz	136.1220	15.73	16.63	20	Compliance

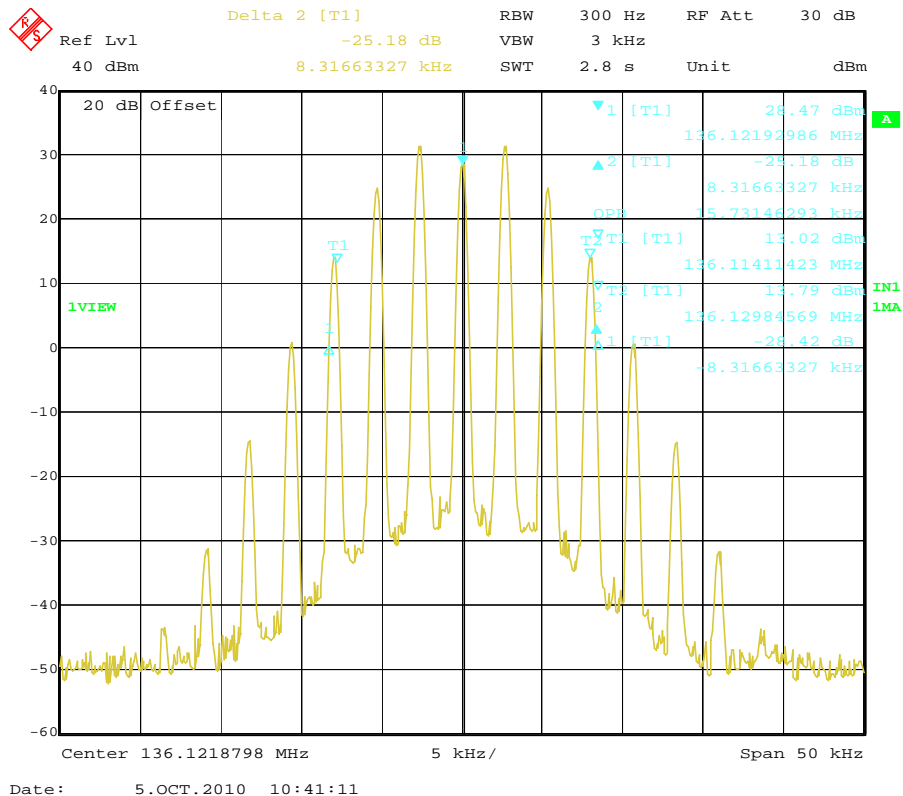

Modulation Type	Channel Separation	Freq.(MHz)	99% Bandwidth (KHz)	26dB Bandwidth (KHz)	FCC Limit (KHz)	Results
FM	25 KHz	152.1220	15.63	16.63	20	Compliance

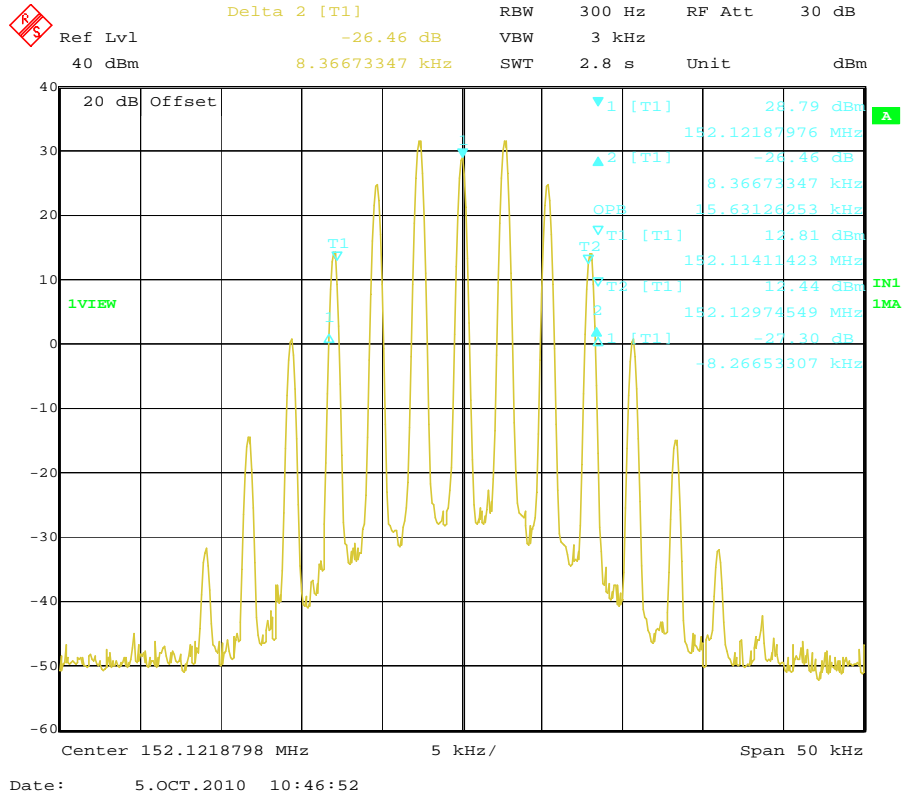

Modulation Type	Channel Separation	Freq.(MHz)	99% Bandwidth (KHz)	26dB Bandwidth (KHz)	FCC Limit (KHz)	Results
FM	25 KHz	173.9220	15.73	16.63	20	Compliance

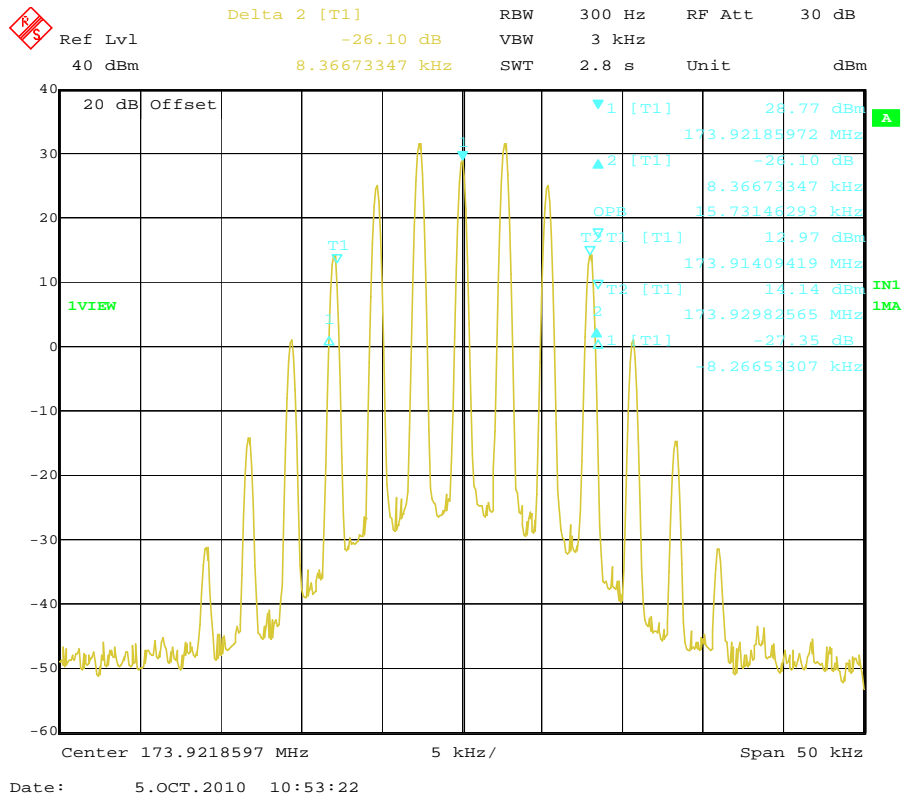

Modulation Type	Channel Separation	Freq.(MHz)	99% Bandwidth (KHz)	26dB Bandwidth (KHz)	FCC Limit (KHz)	Results
FM	12.5 KHz	136.1220	9.82	10.62	11.25	Compliance

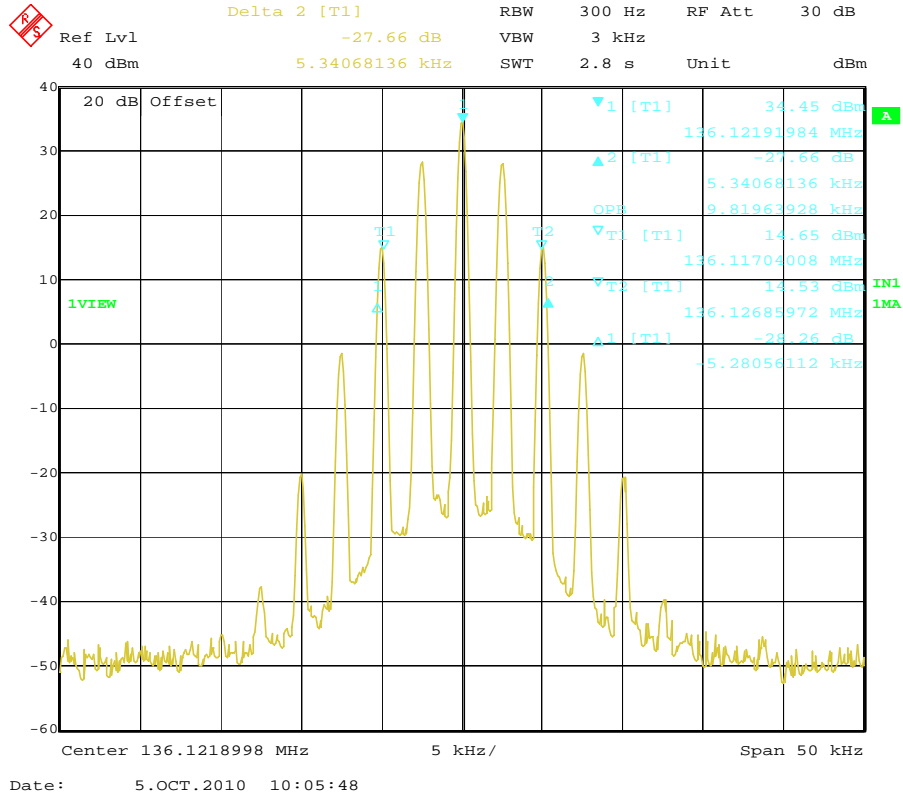

Modulation Type	Channel Separation	Freq.(MHz)	99% Bandwidth (KHz)	26dB Bandwidth (KHz)	FCC Limit (KHz)	Results
FM	12.5 KHz	152.1220	9.82	10.62	11.25	Compliance

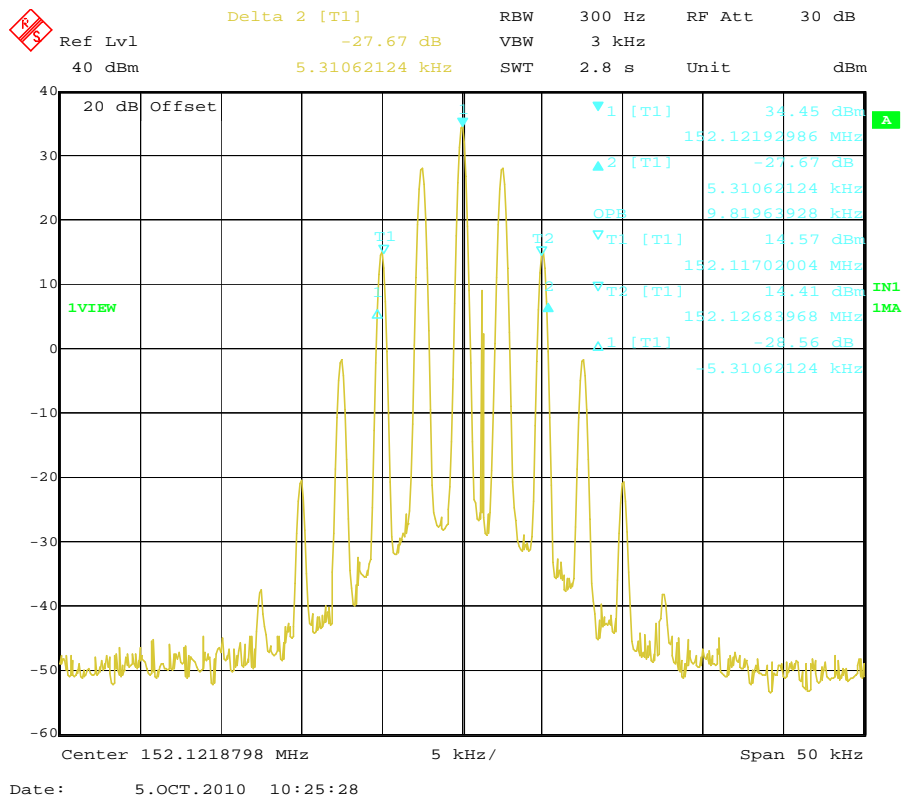

Modulation Type	Channel Separation	Freq.(MHz)	99% Bandwidth (KHz)	26dB Bandwidth (KHz)	FCC Limit (KHz)	Results
FM	12.5 KHz	173.9220	9.92	10.52	11.25	Compliance

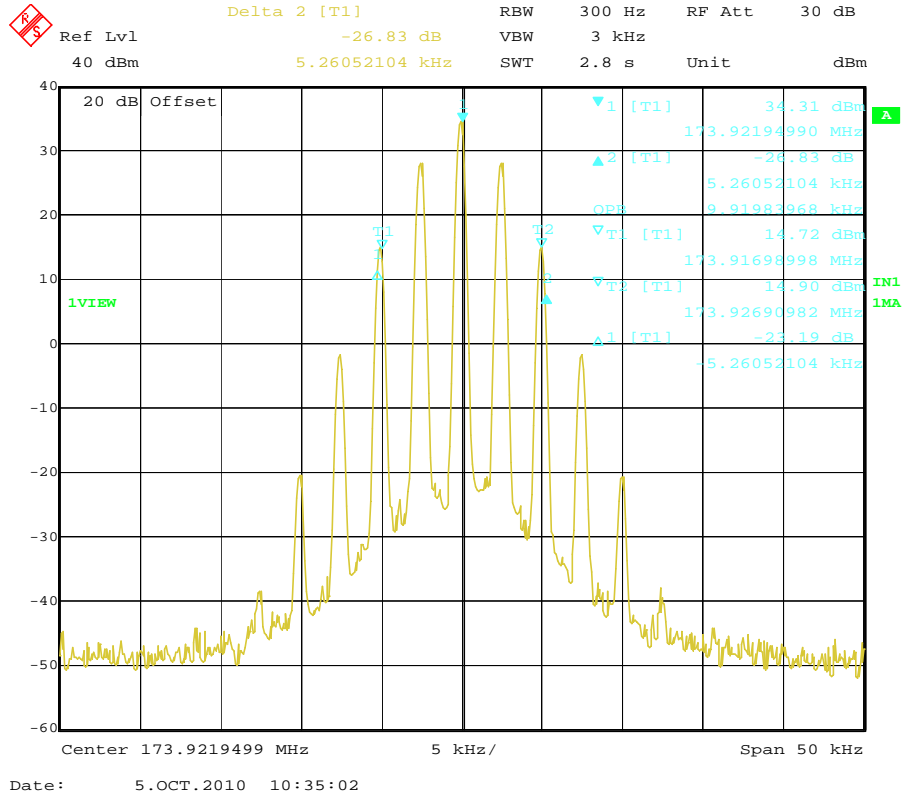

Modulation Type	Channel Separation	Freq.(MHz)	99% Bandwidth (KHz)	26dB Bandwidth (KHz)	FCC Limit (KHz)	Results
4FSK	12.5 KHz	136.1220	7.41	9.12	11.25	Compliance

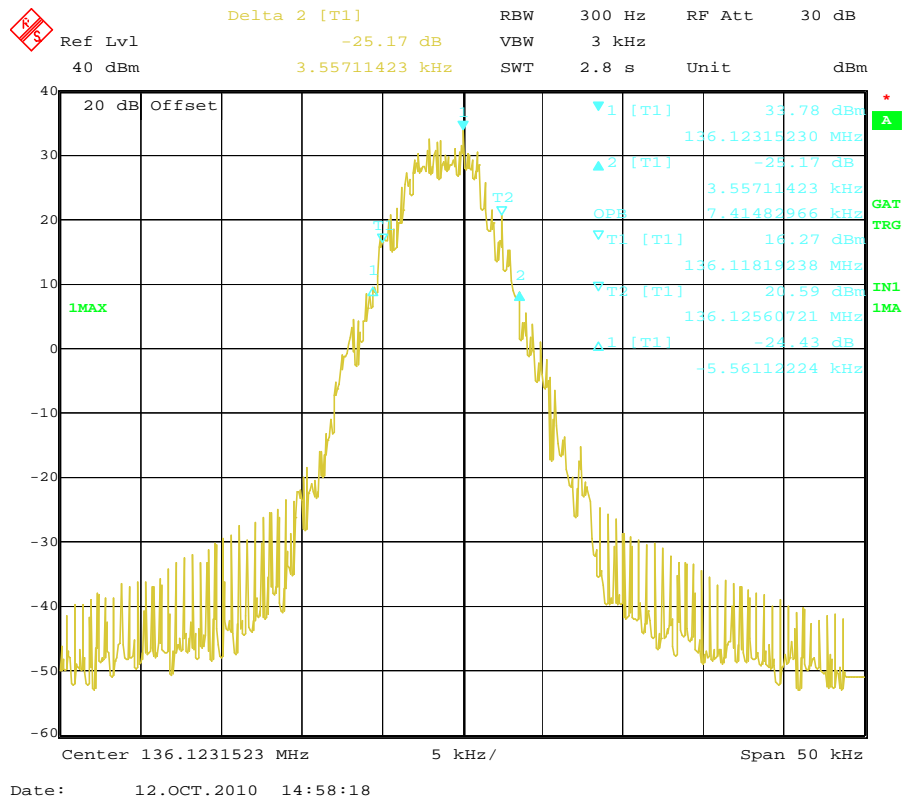

Modulation Type	Channel Separation	Freq.(MHz)	99% Bandwidth (KHz)	26dB Bandwidth (KHz)	FCC Limit (KHz)	Results
4FSK	12.5 KHz	152.1220	7.41	9.52	11.25	Compliance

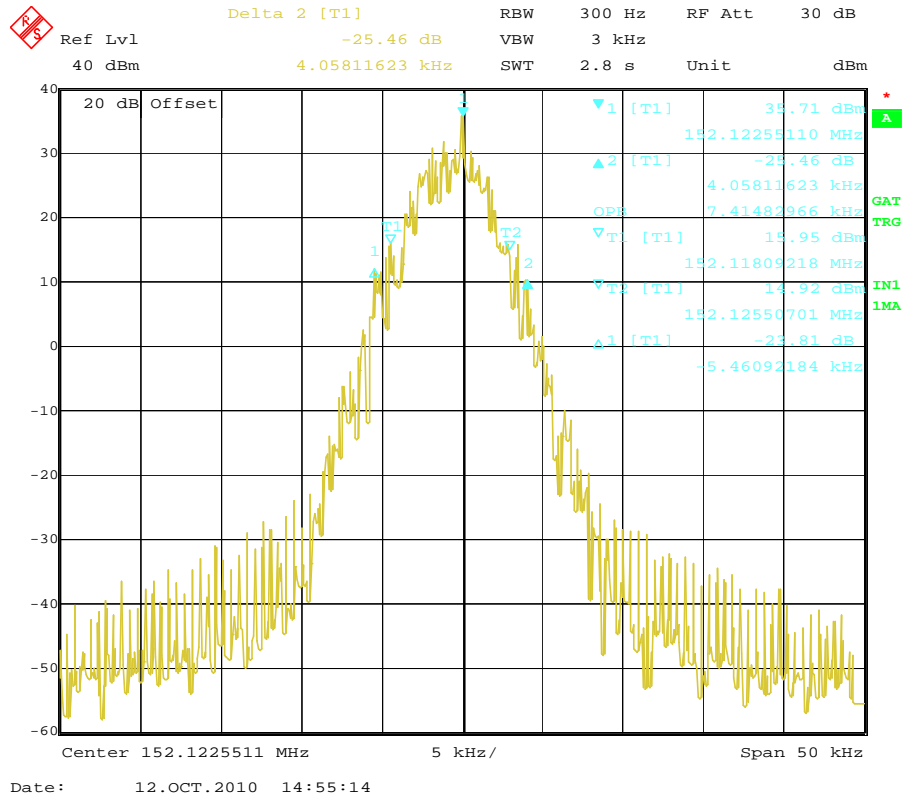

Modulation Type	Channel Separation	Freq.(MHz)	99% Bandwidth (KHz)	26dB Bandwidth (KHz)	FCC Limit (KHz)	Results
4FSK	12.5 KHz	173.9220	7.52	9.02	11.25	Compliance

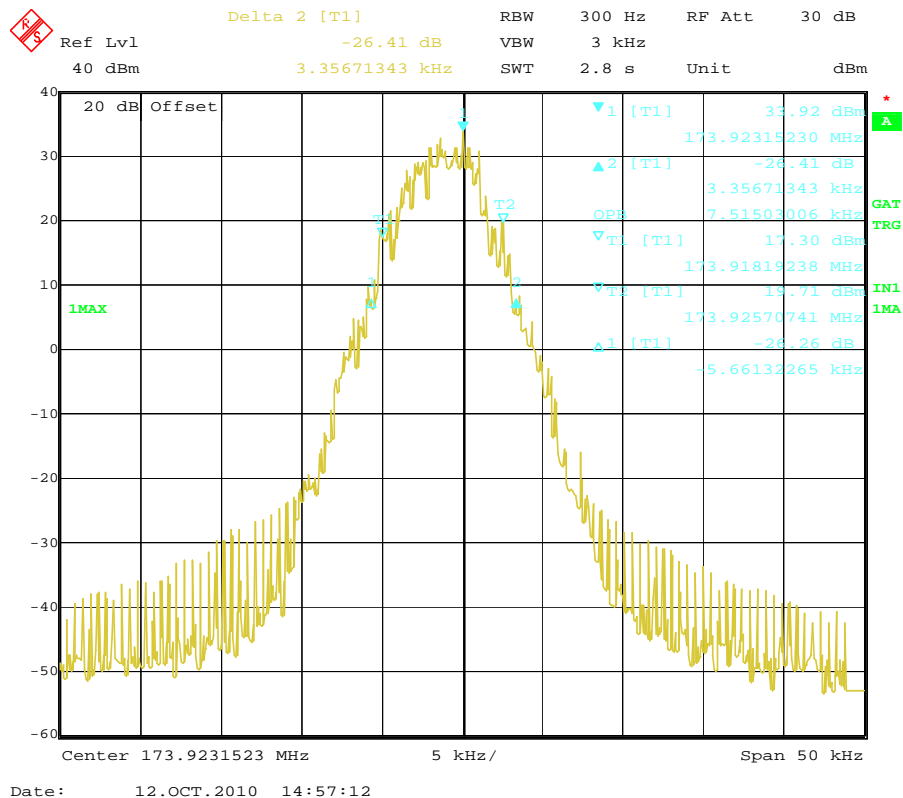

4.2.2 Emission Mask

Modulation Type	Channel Separation	Test Channel	Test Frequency	FCC Applicable Mask	RBW
FM	25KHz	Low	136.1220 MHz	B	300 Hz
		Middle	152.1220 MHz	B	300 Hz
		High	173.9220 MHz	B	300 Hz
	12.5KHz	Low	136.1220 MHz	D	100 Hz
		Middle	152.1220 MHz	D	100 Hz
		High	173.9220 MHz	D	100 Hz
4FSK	12.5KHz	Low	136.1220 MHz	D	100 Hz
		Middle	152.1220 MHz	D	100 Hz
		High	173.9220 MHz	D	100 Hz
Test Results		Compliance			

Plots of Emission Mask Measurement

Referred as the attached plot hereinafter

Note: The yellow curve represents unmodulated signal.

The green curve represents modulated signal.

Modulation Type	Channel Separation	Freq.(MHz)	FCC Applicable Mask	RBW	Audio Freq. (KHz)	Results
FM	25 KHz	136.1220	B	300Hz	2.5	Compliance

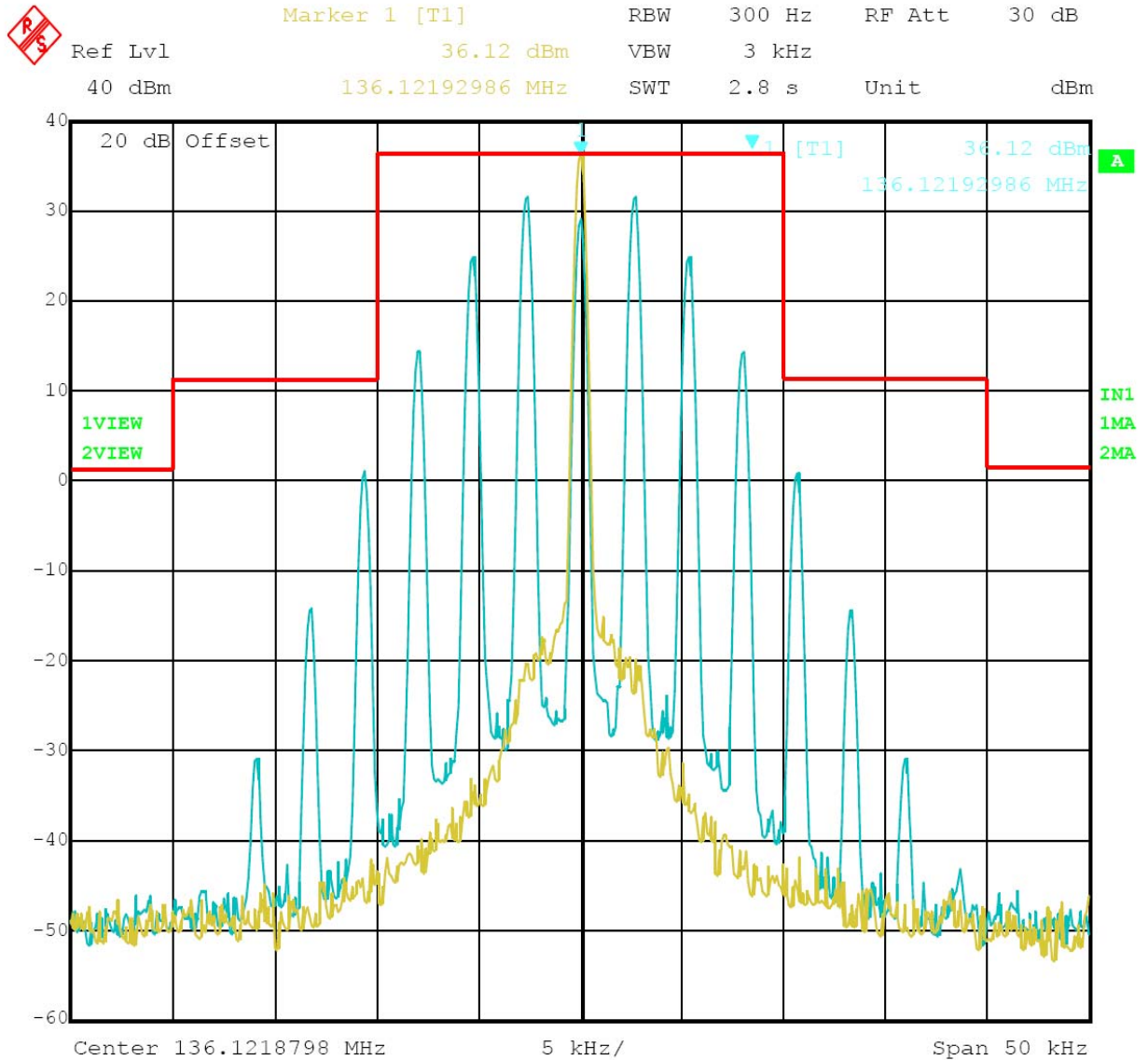

Date: 5.OCT.2010 10:42:19
 25 kHz Channel Spacing, 136.1220 MHz, 2500 Hz Audio Modulation Only

Modulation Type	Channel Separation	Freq.(MHz)	FCC Applicable Mask	RBW	Audio Freq. (KHz)	Results
FM	25 KHz	152.1220	B	300Hz	2.5	Compliance

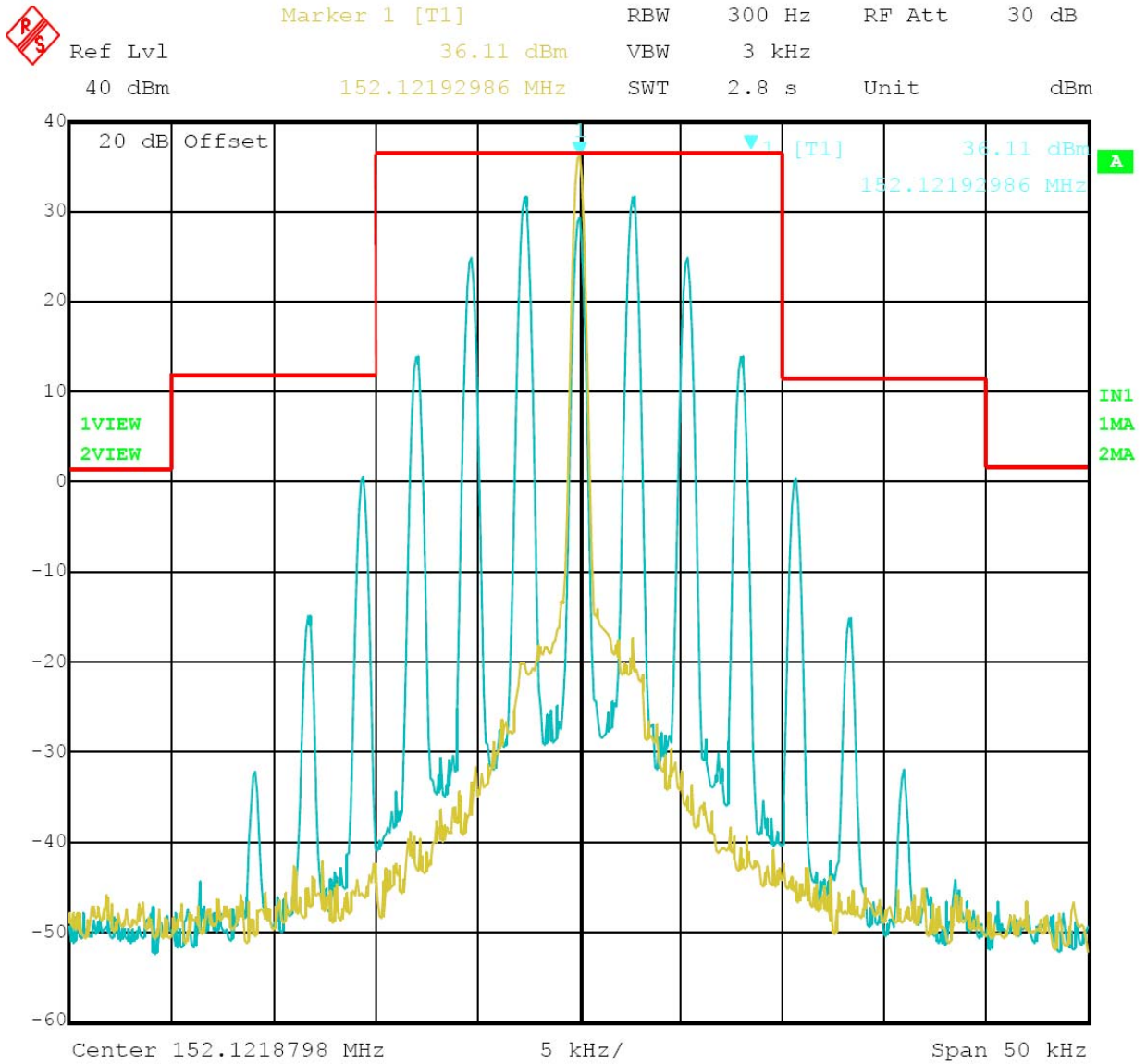

Date: 5.OCT.2010 10:50:07

25 kHz Channel Spacing, 152.1220 MHz, 2500 Hz Audio Modulation Only

Modulation Type	Channel Separation	Freq.(MHz)	FCC Applicable Mask	RBW	Audio Freq. (KHz)	Results
FM	25 KHz	173.9220	B	300Hz	2.5	Compliance

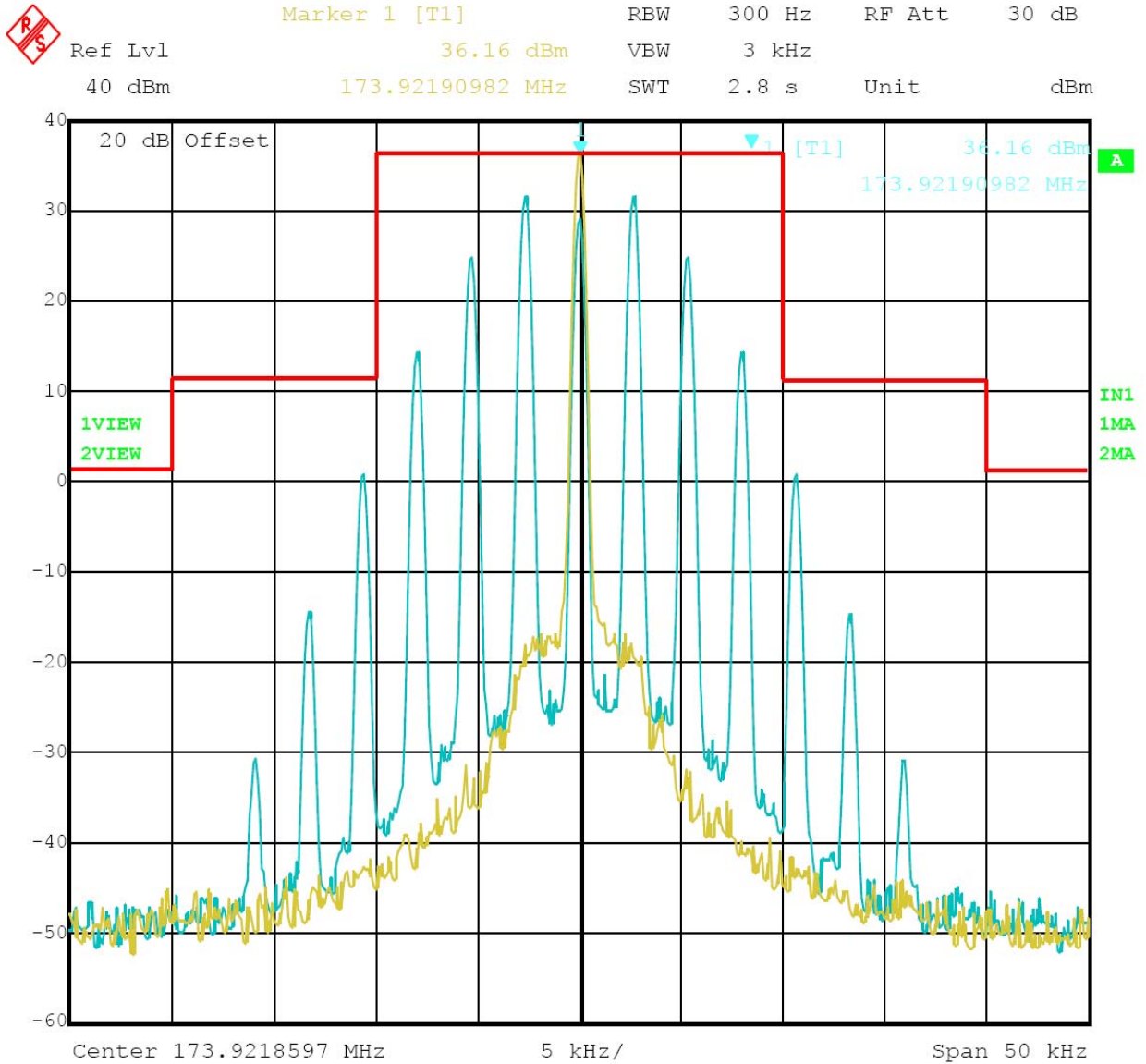

Date: 5.OCT.2010 10:54:40

25 kHz Channel Spacing, 173.9220 MHz, 2500 Hz Audio Modulation Only

Modulation Type	Channel Separation	Freq.(MHz)	FCC Applicable Mask	RBW	Audio Freq. (KHz)	Results
FM	12.5 KHz	136.1220	D	100Hz	2.5	Compliance

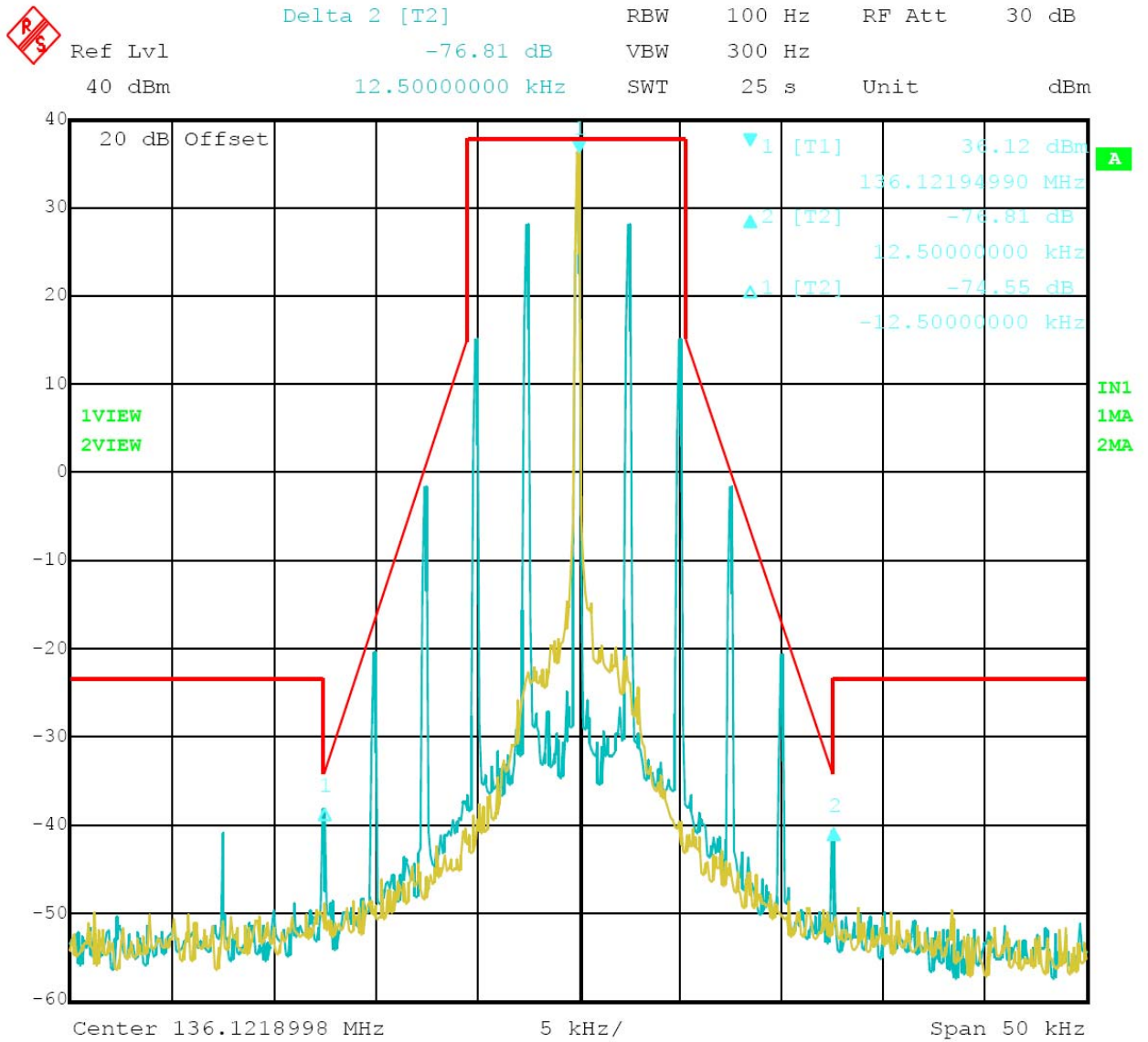

Date: 5.OCT.2010 10:10:42

12.5 kHz Channel Spacing, 136.1220 MHz, 2500 Hz Audio Modulation Only

Modulation Type	Channel Separation	Freq.(MHz)	FCC Applicable Mask	RBW	Audio Freq. (KHz)	Results
FM	12.5 KHz	152.1220	D	100Hz	2.5	Compliance

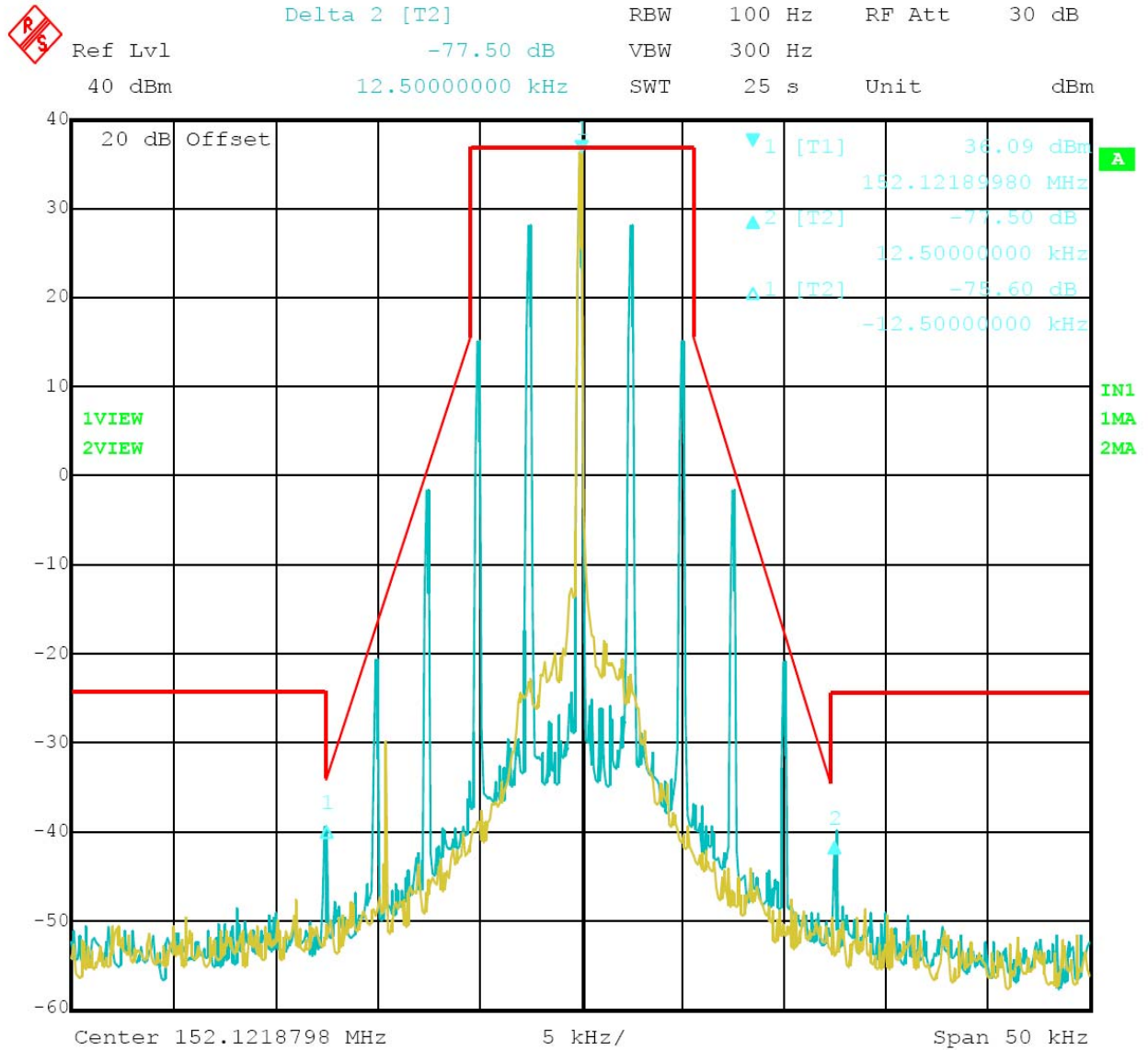

Date: 5.OCT.2010 10:22:22

12.5 kHz Channel Spacing, 152.1220 MHz, 2500 Hz Audio Modulation Only

Modulation Type	Channel Separation	Freq.(MHz)	FCC Applicable Mask	RBW	Audio Freq. (KHz)	Results
FM	12.5 KHz	173.9220	D	100Hz	2.5	Compliance

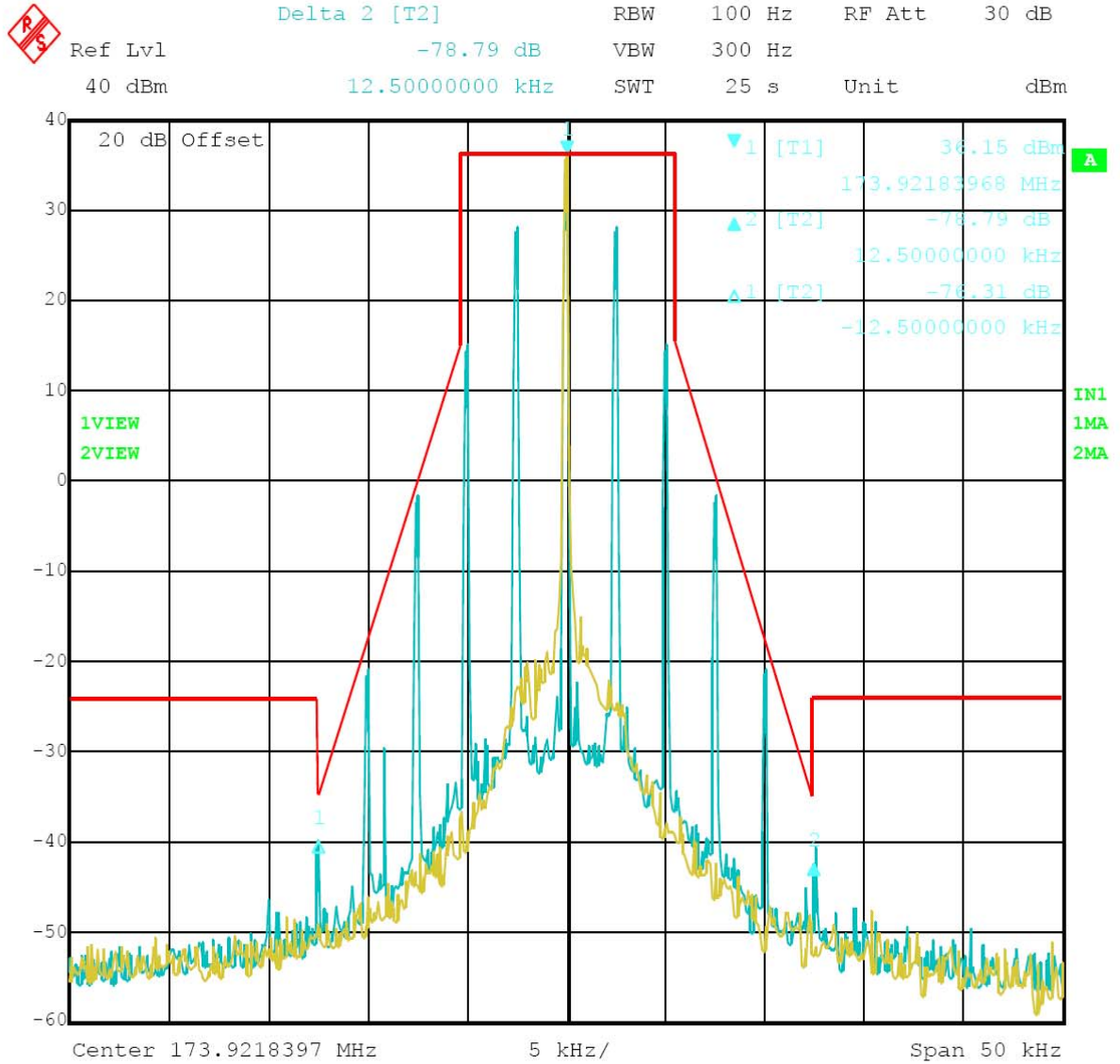

Date: 5.OCT.2010 10:31:33

12.5 kHz Channel Spacing, 173.9220 MHz, 2500 Hz Audio Modulation Only

Modulation Type	Channel Separation	Freq.(MHz)	FCC Applicable Mask	RBW	Audio Freq. (KHz)	Results
4FSK	12.5 KHz	136.1220	D	100Hz	/	Compliance

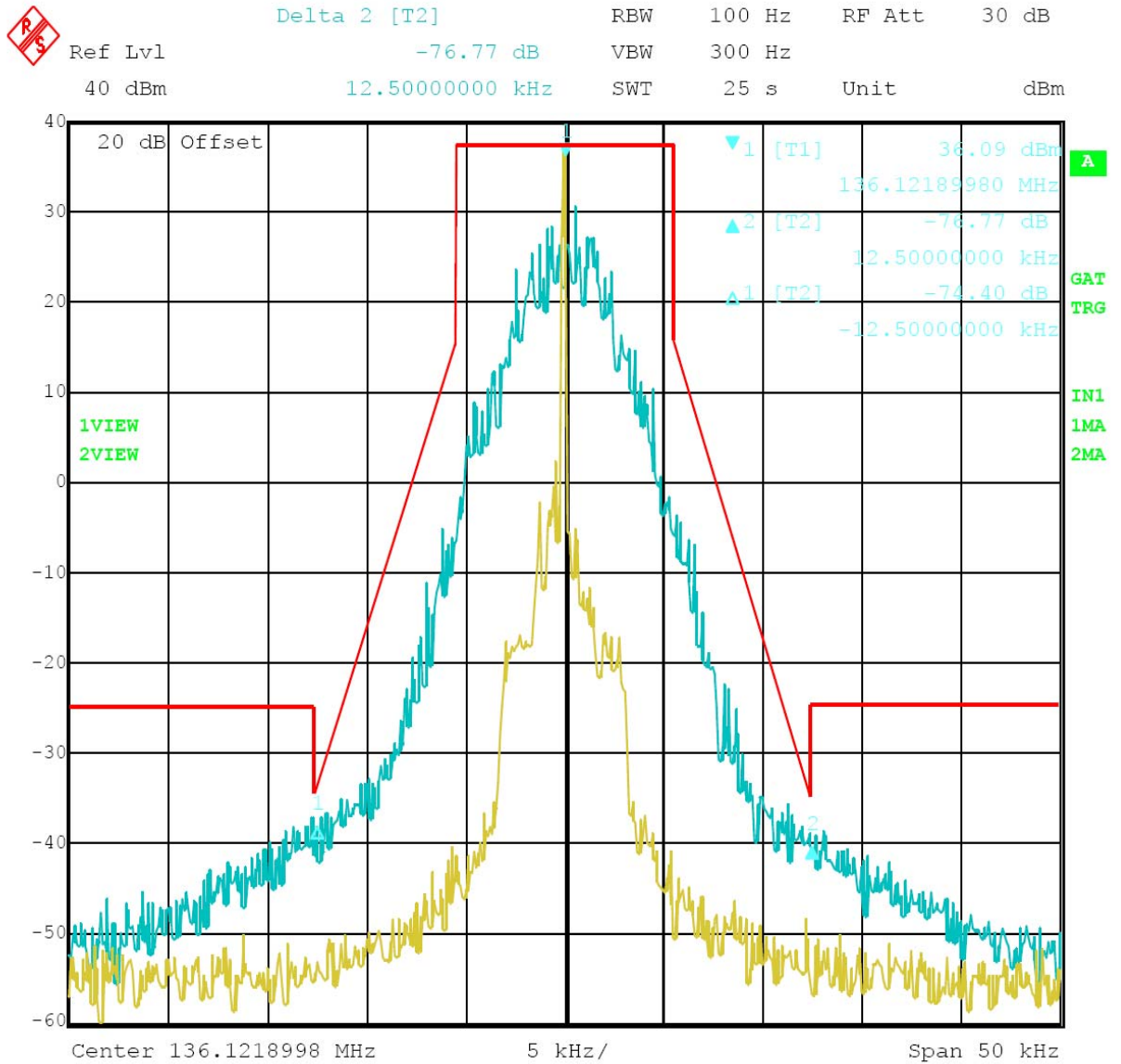

Date: 12.OCT.2010 15:01:27

12.5 kHz Channel Spacing, 136.1220 MHz, 4FSK Modulation Only

Modulation Type	Channel Separation	Freq.(MHz)	FCC Applicable Mask	RBW	Audio Freq. (KHz)	Results
4FSK	12.5 KHz	152.1220	D	100Hz	/	Compliance

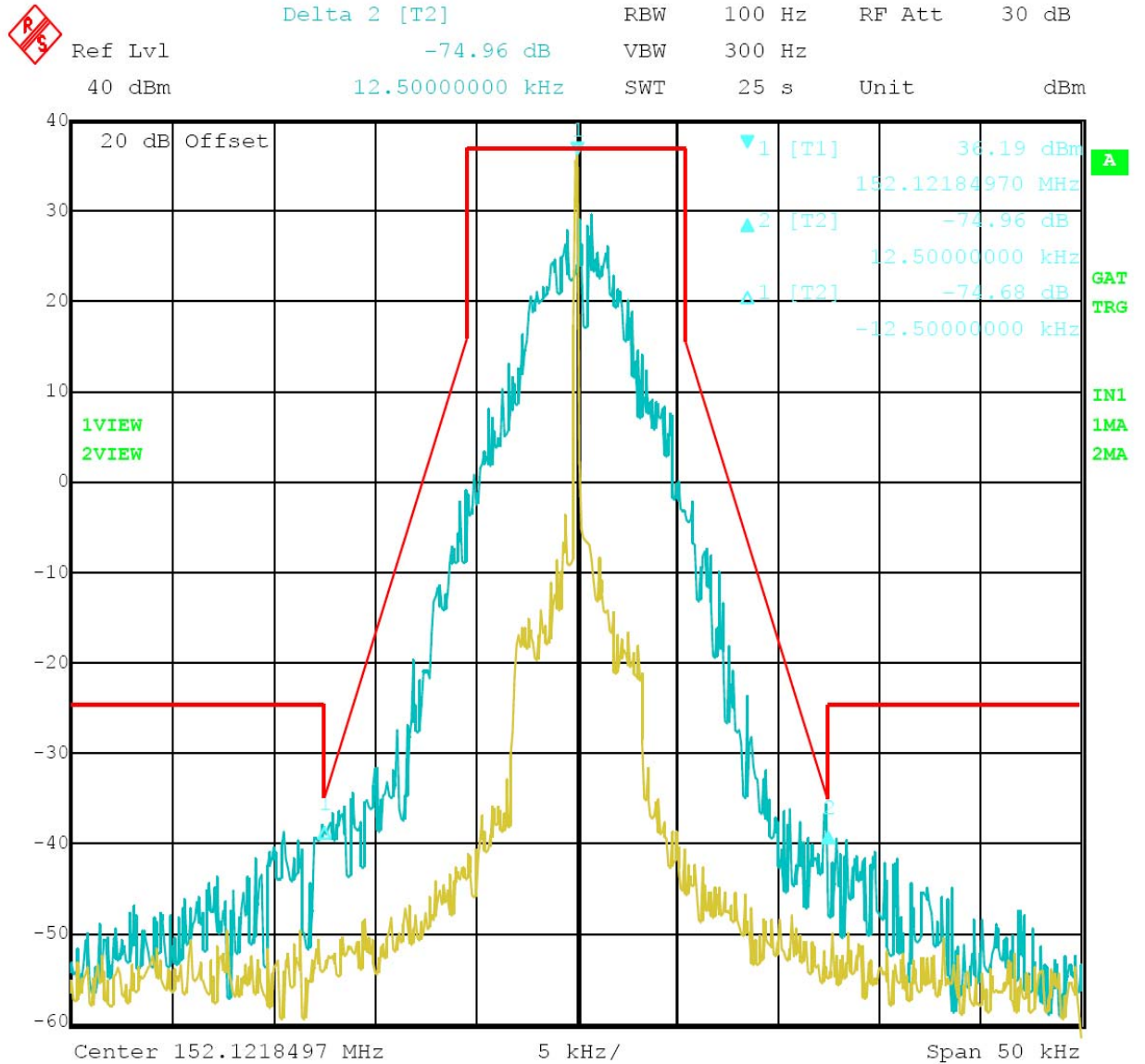

Date: 12.OCT.2010 15:07:27

12.5 kHz Channel Spacing, 152.1220 MHz, 4FSK Modulation Only

Modulation Type	Channel Separation	Freq.(MHz)	FCC Applicable Mask	RBW	Audio Freq. (KHz)	Results
4FSK	12.5 KHz	173.9220	D	100Hz	/	Compliance

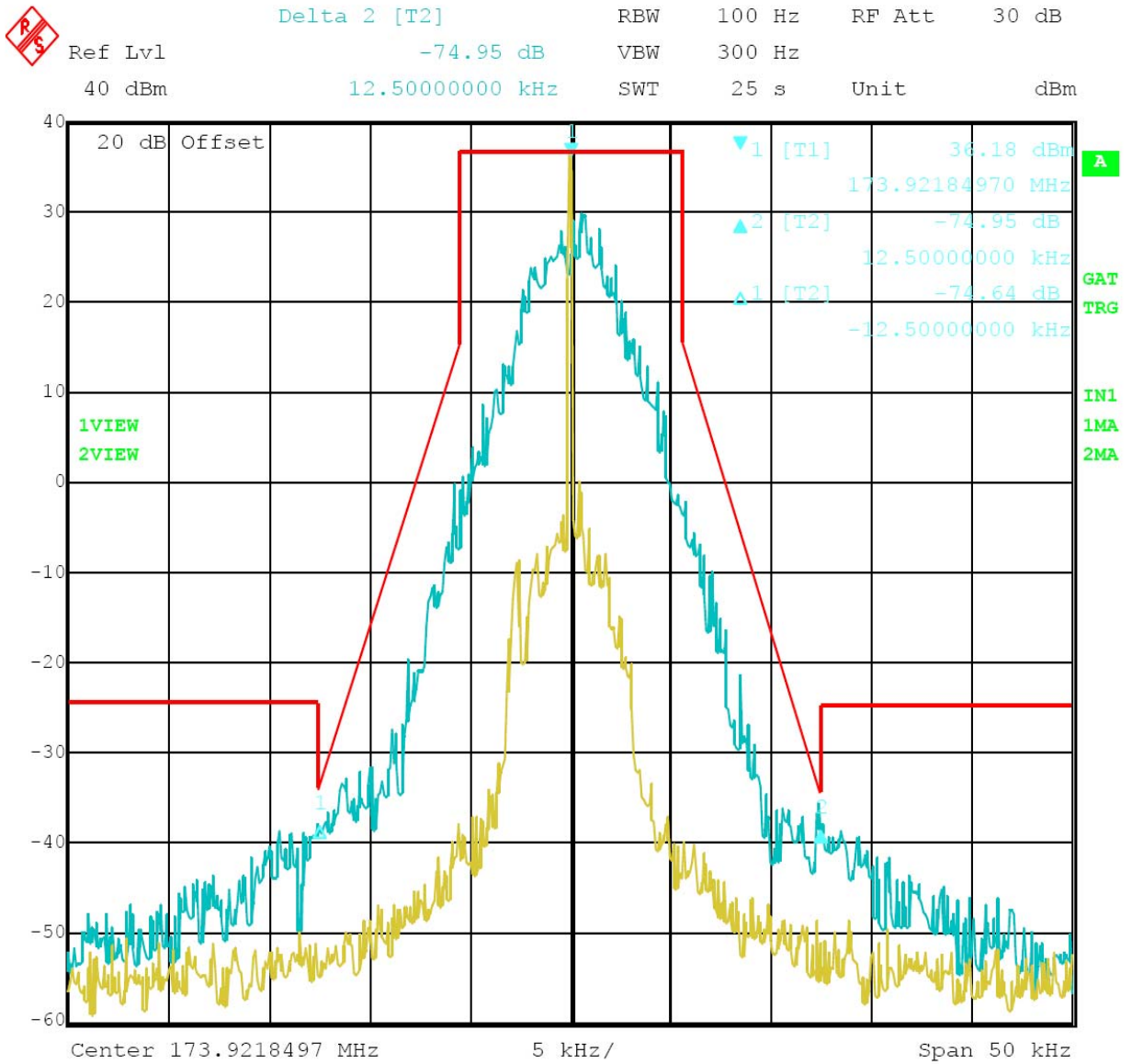

Date: 12.OCT.2010 15:10:43

12.5 kHz Channel Spacing, 173.9220 MHz, 4FSK Modulation Only

4.3. Transmitter Radiated Spurious Emission

TEST APPLICABLE

According to the TIA/EIA 603 test method, and according to Section 90.210, the power of each unwanted emission shall be less than Transmitted Power as specified below for transmitters designed to operate with 12.5 KHz channel bandwidth:

- 1 On any frequency removed from the center of the authorized bandwidth f_0 to 5.625 KHz removed from f_0 : Zero dB
 - 2 On any frequency removed from the center of the authorized bandwidth by a displacement frequency (f_d in KHz) f_0 of more than 5.625 KHz but no more than 12.5 KHz: At least 7.27dB
 - 3 On any frequency removed from the center of the authorized bandwidth by a displacement frequency (f_d in KHz) f_0 of more than 12.5 KHz: At least $50 + 10 \log(P)$ dB or 70 dB, which ever is lesser attenuation.
- For transmitters designed to transmit with 25 KHz channel separation and equipped with an audio low-pass filter, the power of any emission must be attenuated below the unmodulated carrier power (P) as following:

- 1 On any frequency removed from the assigned frequency by more than 50 percent, but no more than 100 percent of the authorized bandwidth: At least 25 dB.
- 2 On any frequency removed from the assigned frequency by more than 100 percent, but no more than 250 percent of the authorized bandwidth: At least 35 dB.
- 3 On any frequency removed from the assigned frequency by more than 250 percent of the authorized bandwidth: At least $43 + 10 \log(P)$ dB.

TEST CONFIGURATION

Below 1GHz

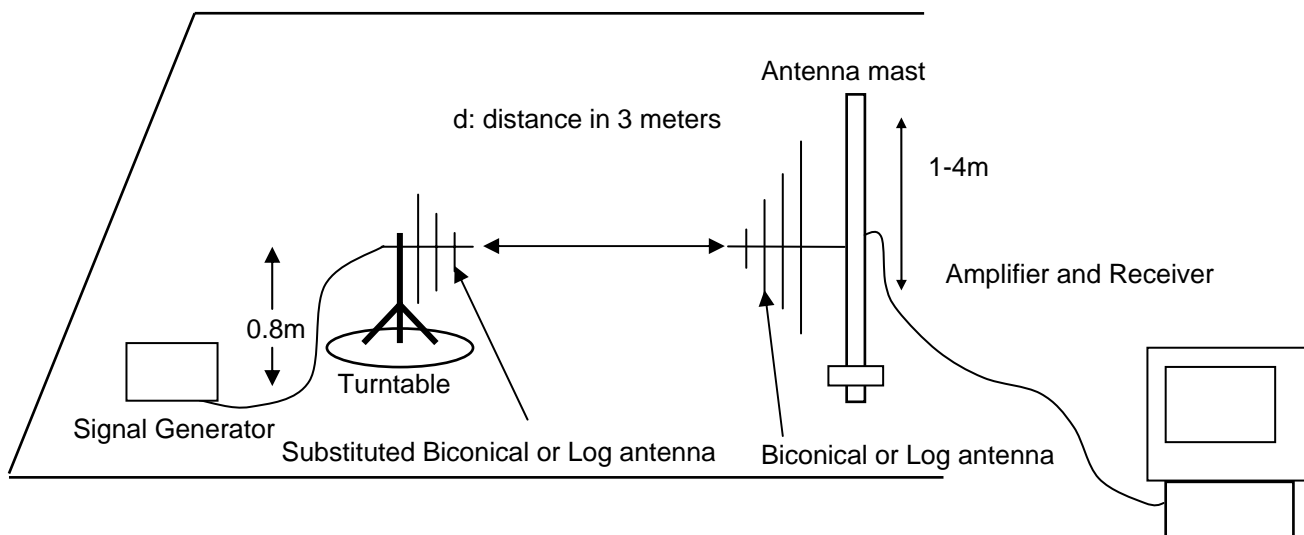
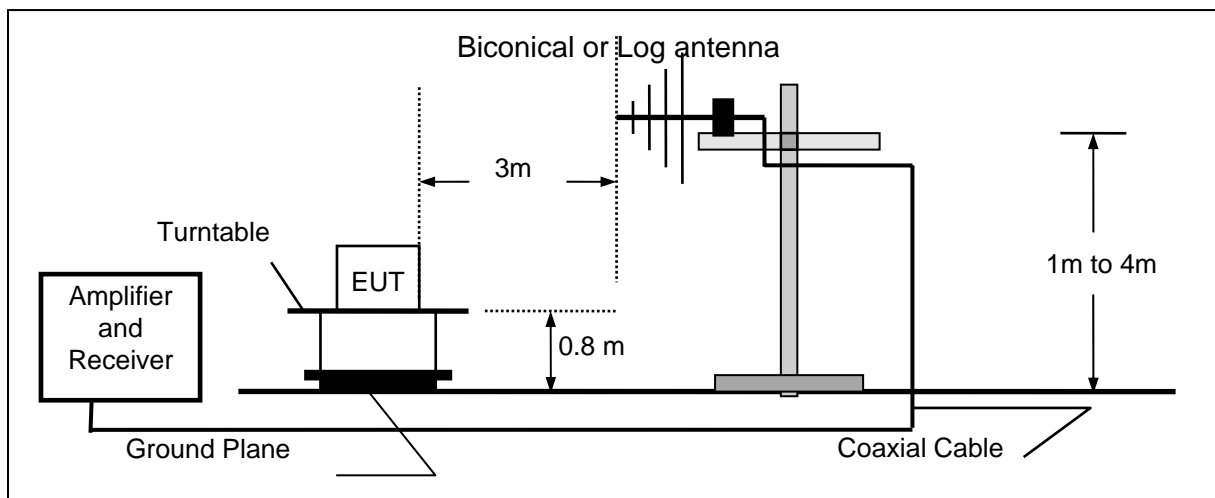

Above 1GHz

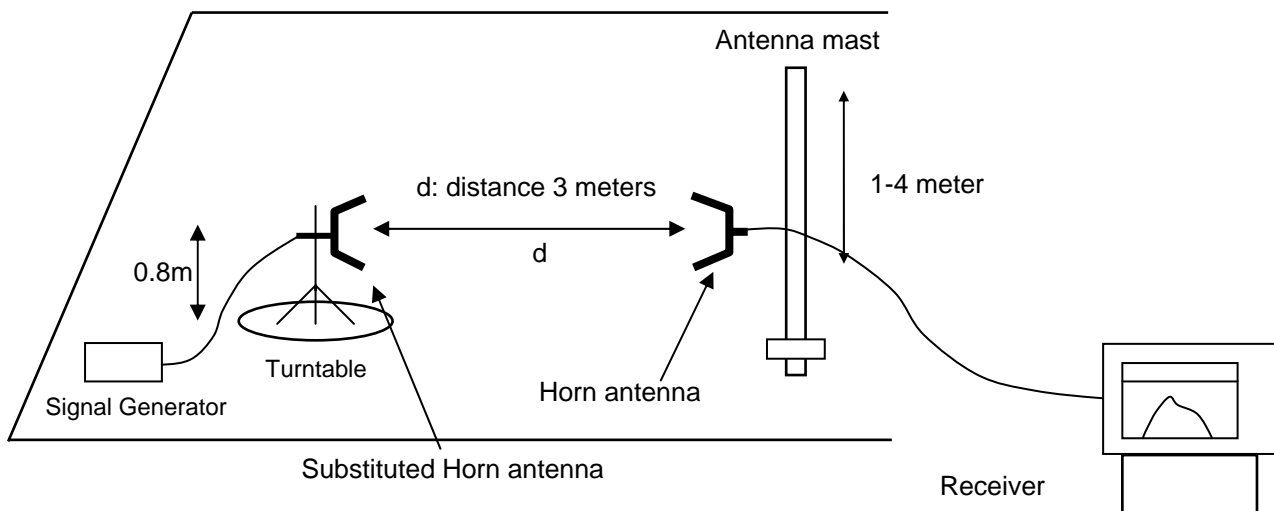
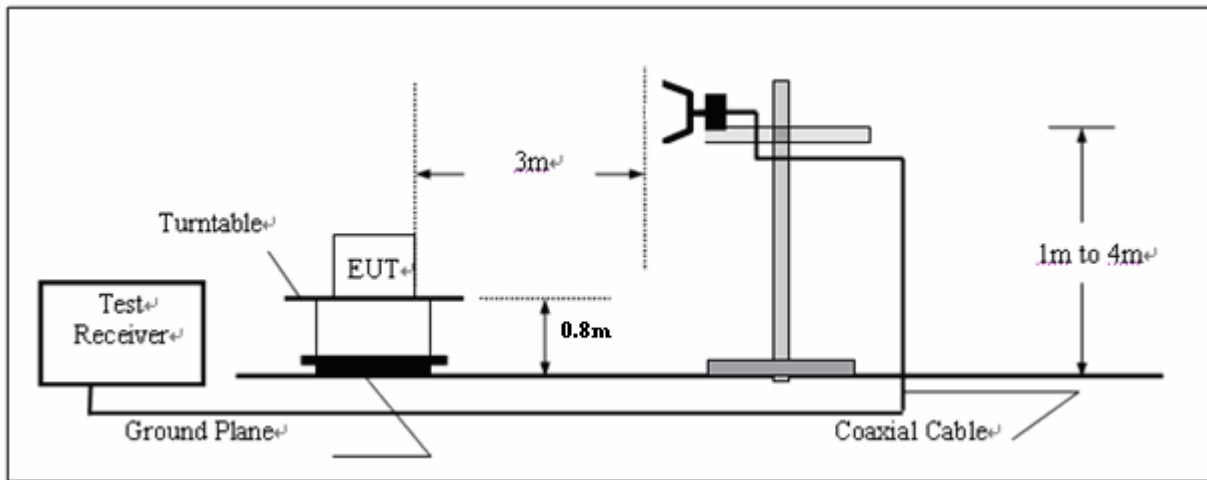
**TEST PROCEDURE**

- 1 On a test site, the EUT shall be placed on a turntable and in the position closest to the normal use as declared by the user.
- 2 The test antenna shall be oriented initially for vertical polarization located 3m from the EUT to correspond to the transmitter.
- 3 The output of the antenna shall be connected to the measuring receiver and either a peak or quasi-peak detector was used for the measurement as in dicated on the report. The detector selection is based on how close the emission level was approaching the limit.
- 4 The transmitter shall be switched on; if possible, without the modulation and the measurement receiver shall be tuned to the frequency of the transmitter under test.
- 5 The test antenna shall be raised and lowered through the specified range of height until the measuring receiver detects a maximum signal level.
- 6 The transmitter shall than be rotated through 360° in the horizontal plane, until the maximum signal level is detected by the measuring receiver.
- 7 The test antenna shall be raised and lowered again through the specified range of height until the measuring receiver detects a maximum signal level.
- 8 The maximum signal level detected by the measuring receiver shall be noted.
- 9 The measurement shall be repeated with the test antenna set to horizontal polarization.
- 10 Replace the antenna with a proper Antenna (substitution antenna).
- 11 The substitution antenna shall be oriented for vertical polarization and, if necessary, the length of the substitution antenna shall be adjusted to correspond to the frequency of transmitting.
- 12 The substitution antenna shall be connected to a calibrated signal generator.

- 13 If necessary, the input attenuator setting of the measuring receiver shall be adjusted in order to increase the sensitivity of the measuring receiver.
- 14 The test antenna shall be raised and lowered through the specified range of the height to ensure that the maximum signal is received.
- 15 The input signal to substitution antenna shall be adjusted to the level that produces a level detected by the measuring receiver, that is equal to the level noted while the transmitter radiated power was measured, corrected for the change of input attenuation setting of the measuring receiver.
- 16 The input level to the substitution antenna shall be recorded as power level in dBm, corrected for any change of input attenuator setting of the measuring receiver.
- 17 The measurement shall be repeated with the test antenna and the substitution antenna oriented for horizontal polarization

TEST RESULTS

The Transmitter Radiated Spurious Emission was performed to the Rated high power (5Watt) and Rated low power (1Watt) the datum that reported below is the worst case (Rated high power) of the two rated power conditions.

Modulation Type: FM

FCC Part 22.359, 74.462, 80.211 and 90.210 and RSS Gen, RSS 119 Issue 9 (25 kHz bandwidth only):
On any frequency removed from the center of the assigned channel by more than 250 percent at least:

Low: $43 + 10 \log (P_{\text{watts}}) = 43 + 10 \log (4.69) = 49.71 \text{ dB}$

High: $43 + 10 \log (P_{\text{watts}}) = 43 + 10 \log (4.80) = 49.81 \text{ dB}$

Calculation: Limit (dBm) = $EL - 43 - 10 \log_{10} (TP)$

Notes: EL is the emission level of the Output Power expressed in dBm,
In this application, the EL is 36.99 dBm.

Limit (dBm) = $36.99 - 43 - 10 \log_{10} (4.80) = -13 \text{ dBm}$

FCC Part 22.359, 74.462, 80.211 and 90.210 and RSS Gen, RSS 119 Issue 9 (25 kHz bandwidth only): On any frequency removed from the center of the authorized bandwidth by a displacement frequency (f d in kHz) of more than 12.5 kHz at least:

Low: $50 + 10 \log (P_{\text{watts}}) = 50 + 10 \log (4.72) = 56.74 \text{ dB}$

High: $50 + 10 \log (P_{\text{watts}}) = 50 + 10 \log (4.88) = 56.88 \text{ dB}$

Note: In general, the worse case attenuation requirement shown above was applied.

Calculation: Limit (dBm) = $EL - 50 - 10 \log_{10} (TP)$

Notes: EL is the emission level of the Output Power expressed in dBm,
In this application, the EL is 36.99 dBm.

Limit (dBm) = $36.99 - 50 - 10 \log_{10} (4.88) = -20 \text{ dBm}$

Modulation Type: 4FSK

FCC Part 22.359, 74.462, 80.211 and 90.210 and RSS Gen, RSS 119 Issue 9 (12.5 kHz Bandwidth only):

On any frequency removed from the center of the authorized bandwidth by a displacement frequency (f d in kHz) of more than 12.5 kHz at least:

Low: $50 + 10 \log (P_{\text{watts}}) = 50 + 10 \log (4.69) = 56.71 \text{ dB}$

High: $50 + 10 \log (P_{\text{watts}}) = 50 + 10 \log (4.84) = 56.85 \text{ dB}$

Note: In general, the worse case attenuation requirement shown above was applied.

Calculation: Limit (dBm) = $EL - 50 - 10 \log_{10} (TP)$

Notes: EL is the emission level of the Output Power expressed in dBm,
In this application, the EL is 36.99 dBm.

Limit (dBm) = $36.99 - 50 - 10 \log_{10} (4.84) = -20 \text{ dBm}$

Note: 1. In general, the worse case attenuation requirement shown above was applied.

2. The measurement frequency range from 30 MHz to 4 GHz.

3. *** means that the emission level is too low to be measured or at least 20 dB down than the limit.

4. Corrected Power (dBm) = SG O/P-Cable + Ant Gain

Plots of Transmitter Radiated Spurious Emission Measurement

Modulation Type: FM

The Low channel for 25 KHz Channel Separation @ Horizontal

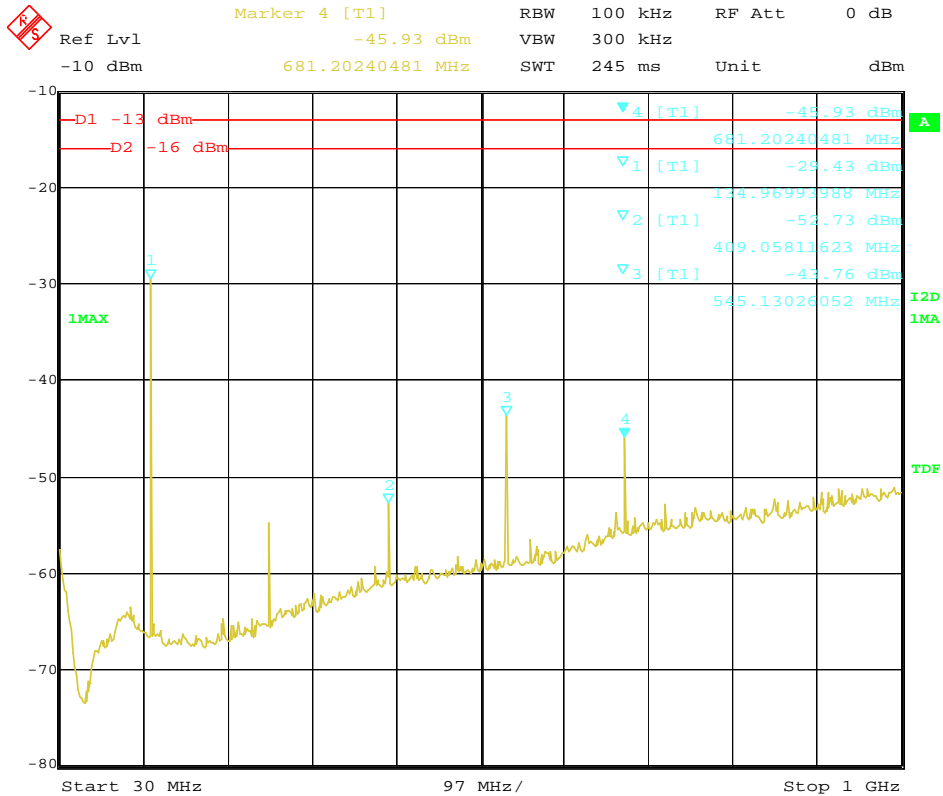

Date: 17.OCT.2010 18:14:38

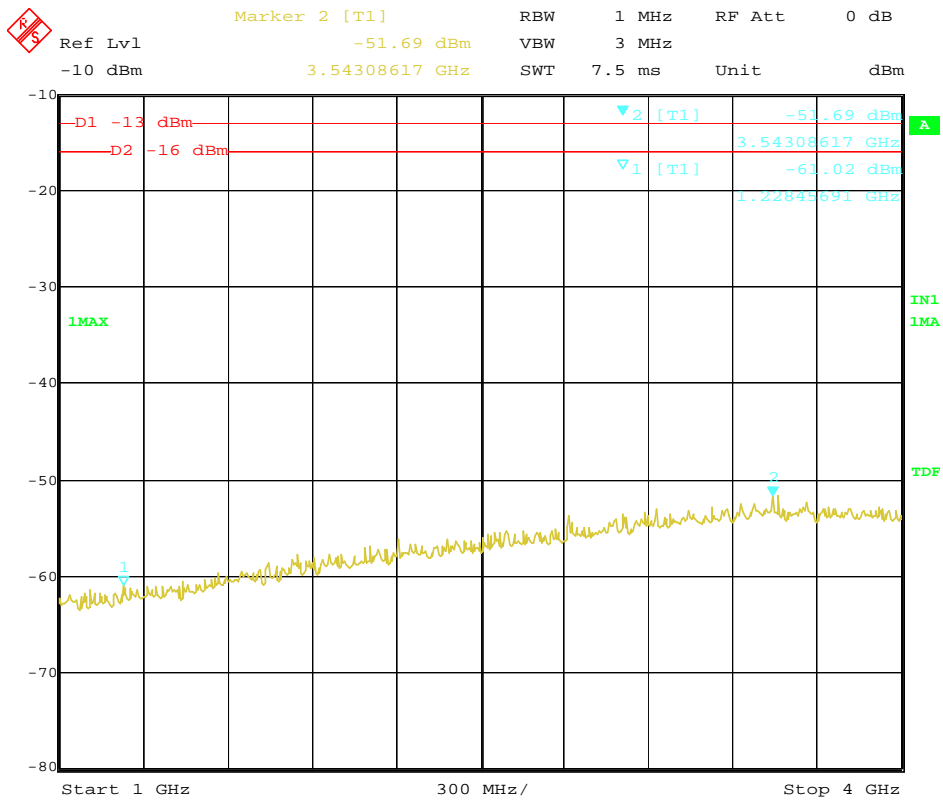

Date: 17.OCT.2010 19:07:53

The Low channel for 25 KHz Channel Separation@ Vertical

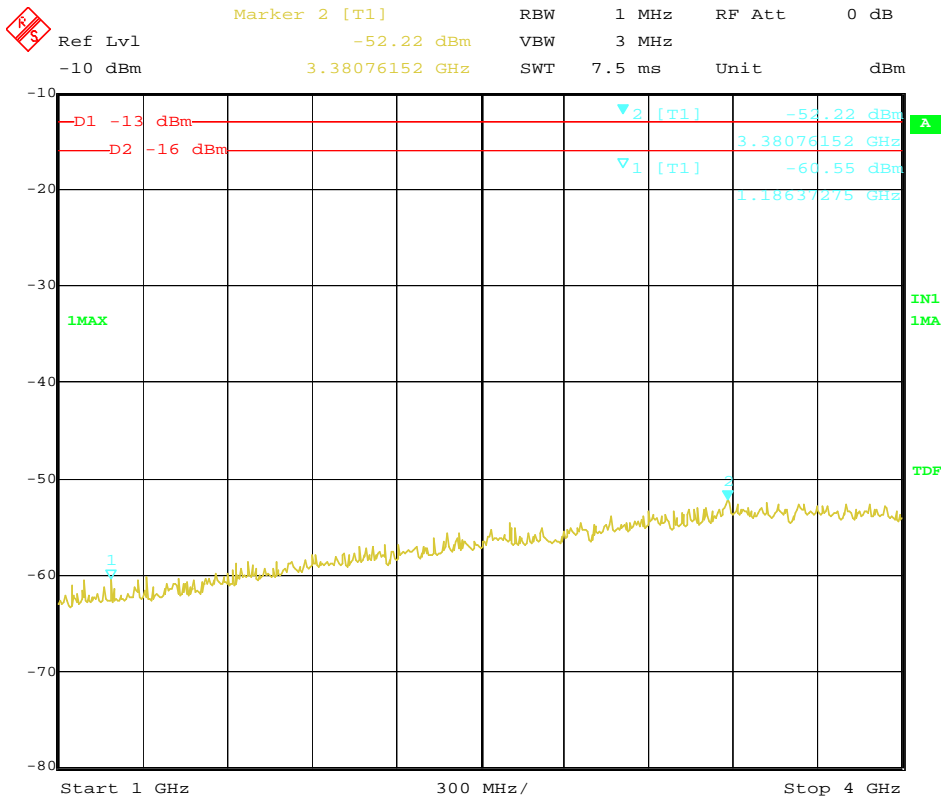
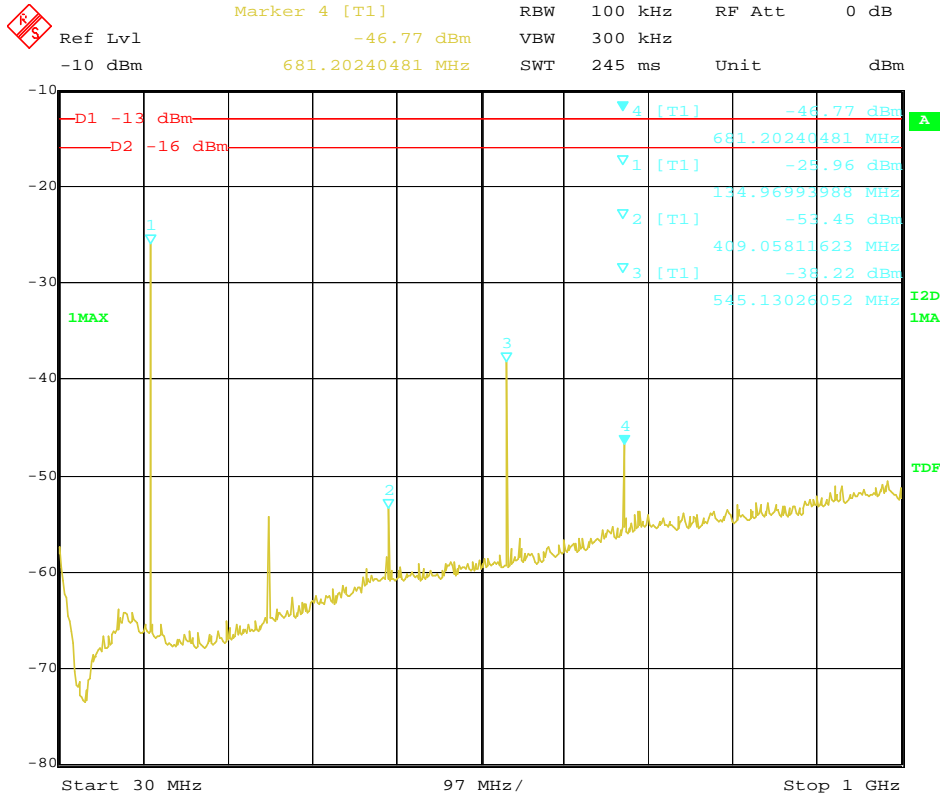

The Middle channel for 25 KHz Channel Separation @ Horizontal

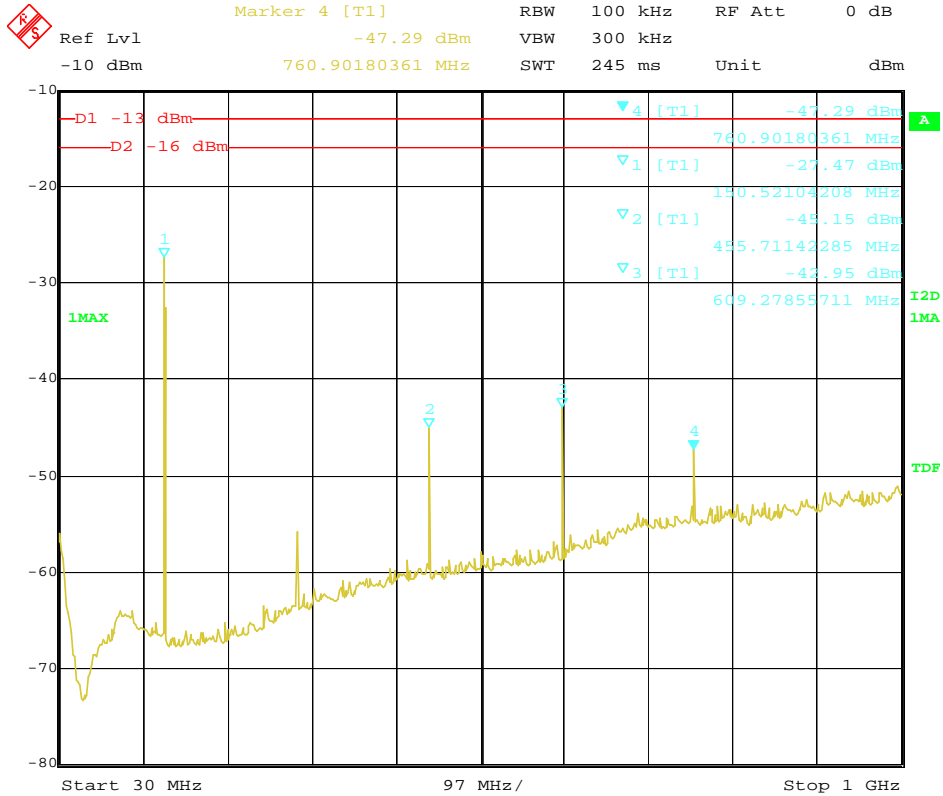

Date: 17.OCT.2010 18:16:21

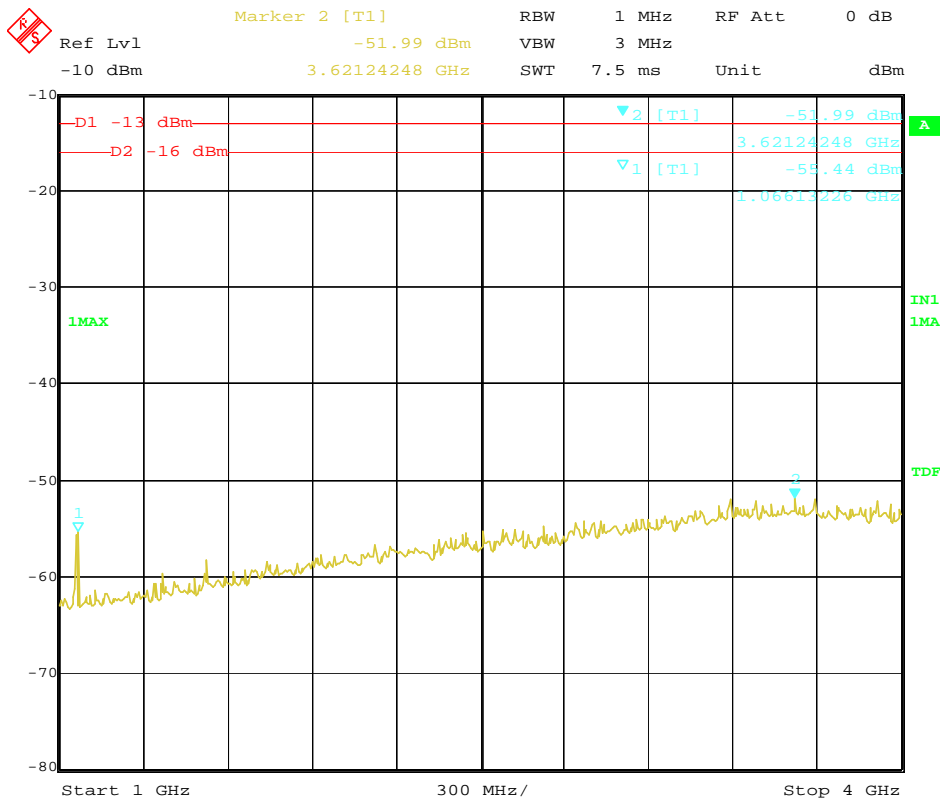

Date: 17.OCT.2010 19:02:48

The Middle channel for 25 KHz Channel Separation@ Vertical

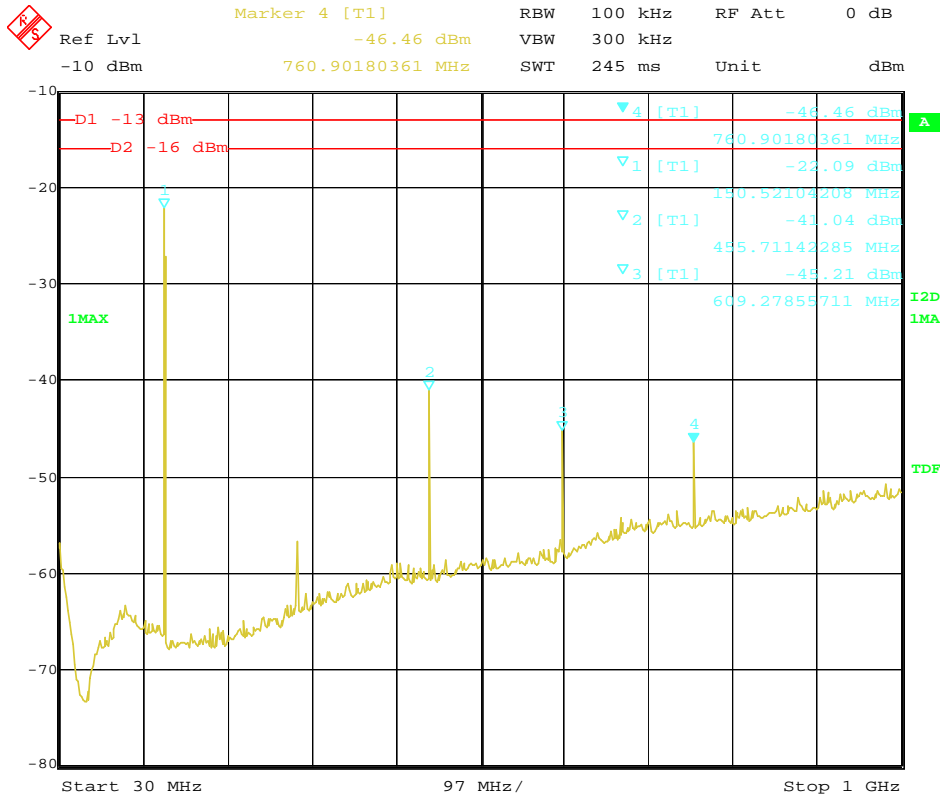

Date: 17.OCT.2010 18:17:30

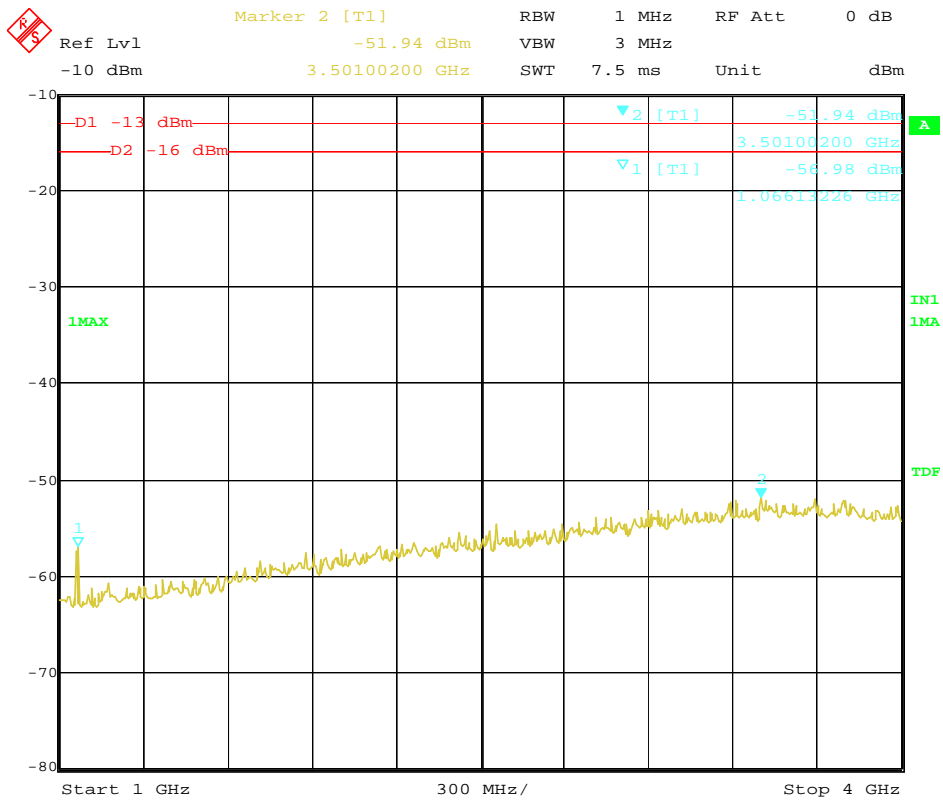

Date: 17.OCT.2010 19:04:26

The High channel for 25 KHz Channel Separation @ Horizontal

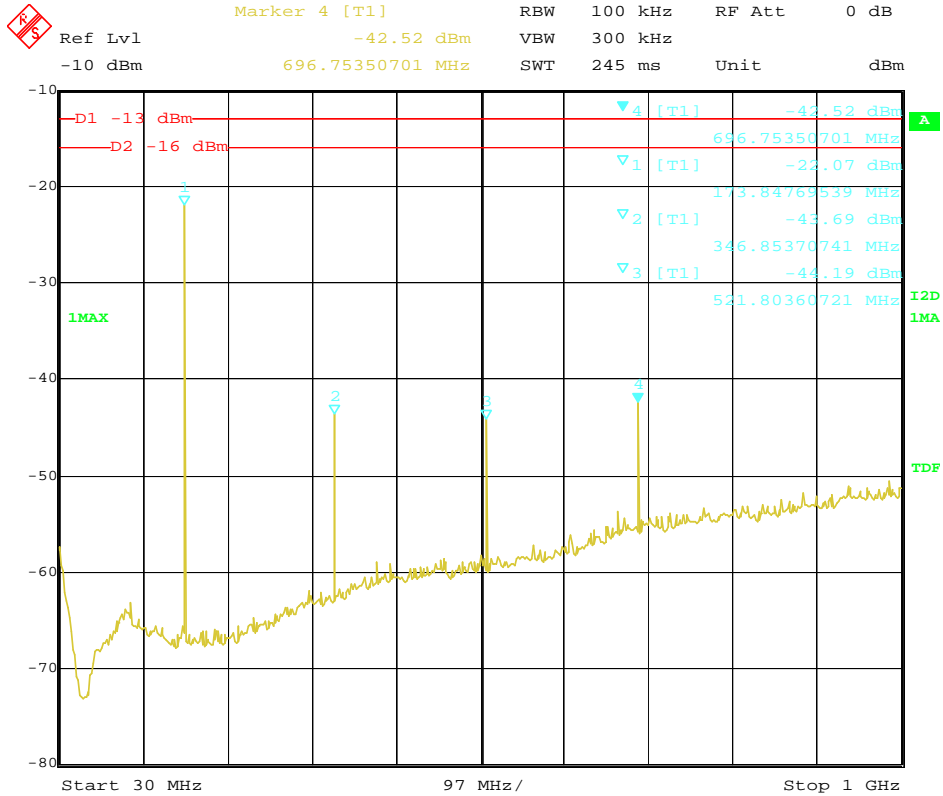

Date: 17.OCT.2010 18:20:23

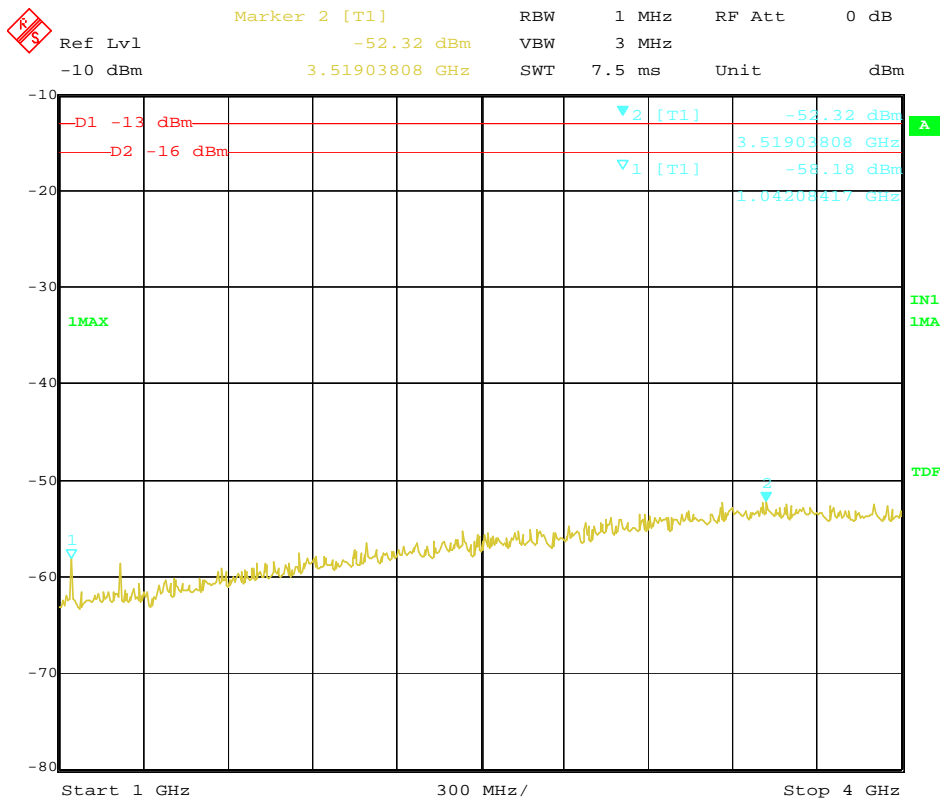

Date: 17.OCT.2010 18:56:38

The High channel for 25 KHz Channel Separation@ Vertical

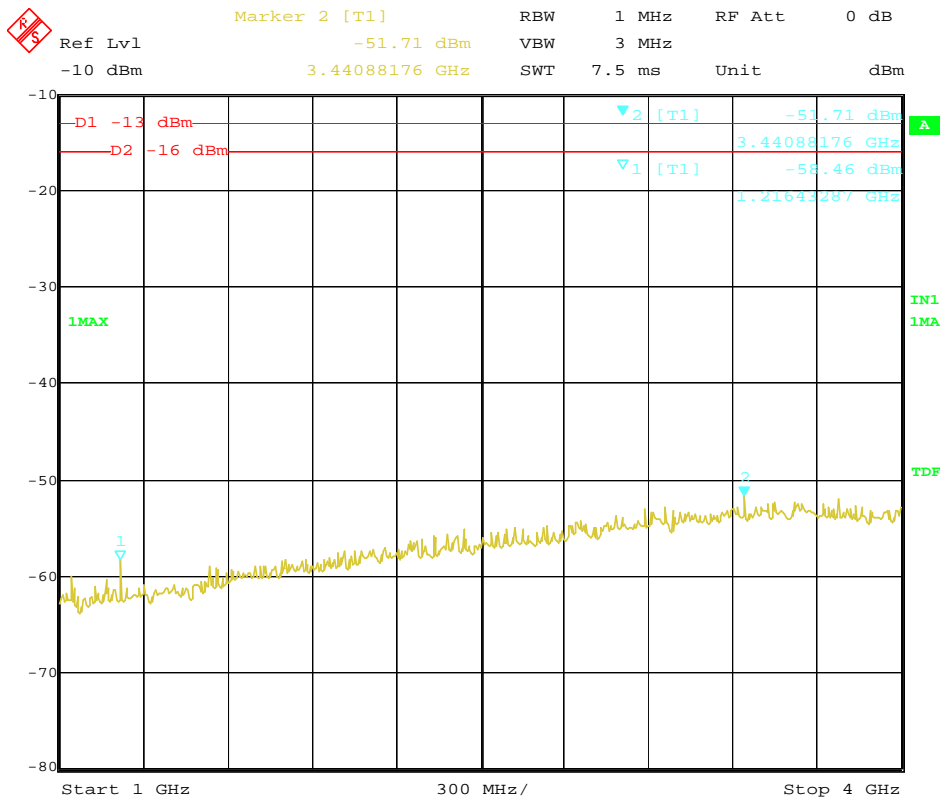
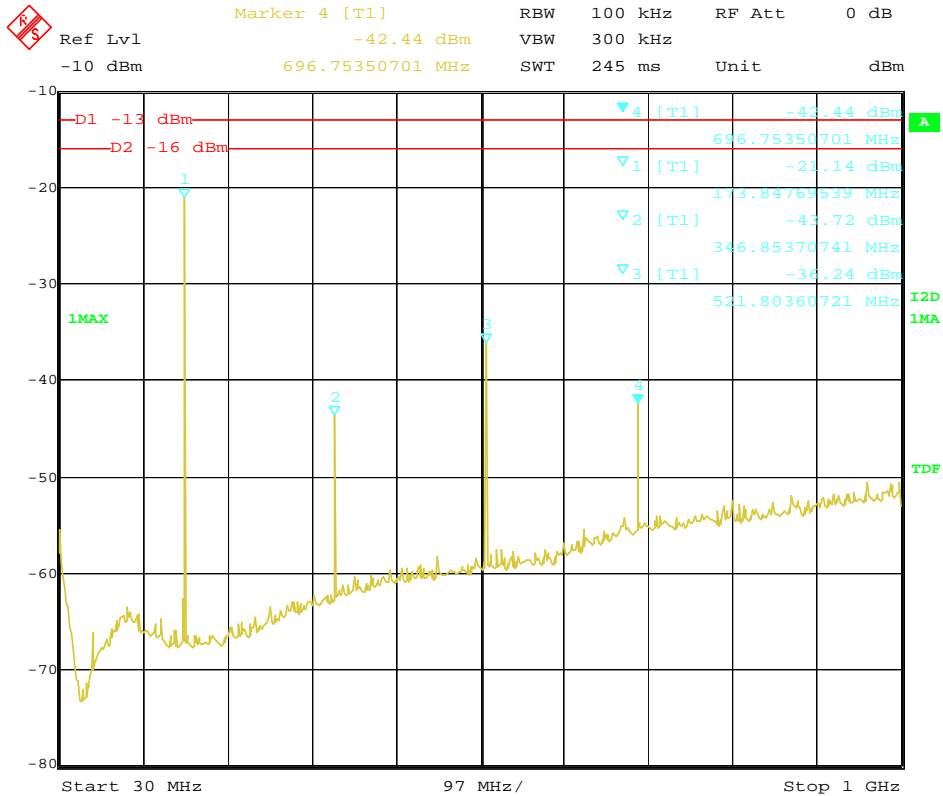

The Low channel for 12.5 KHz Channel Separation @ Horizontal

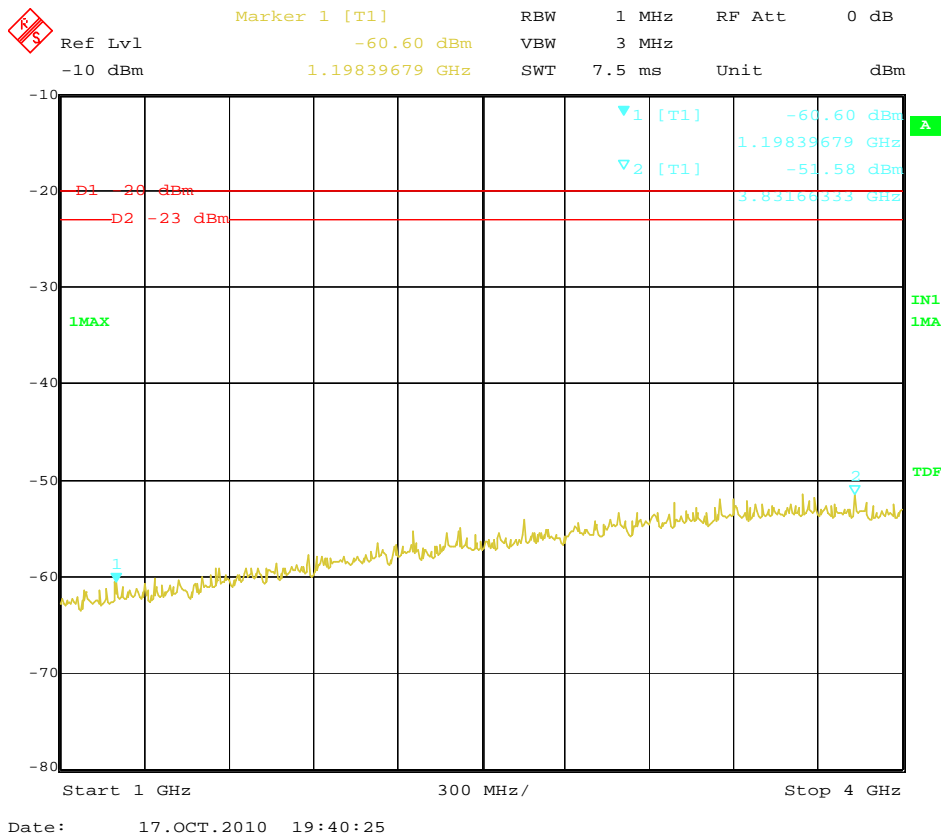
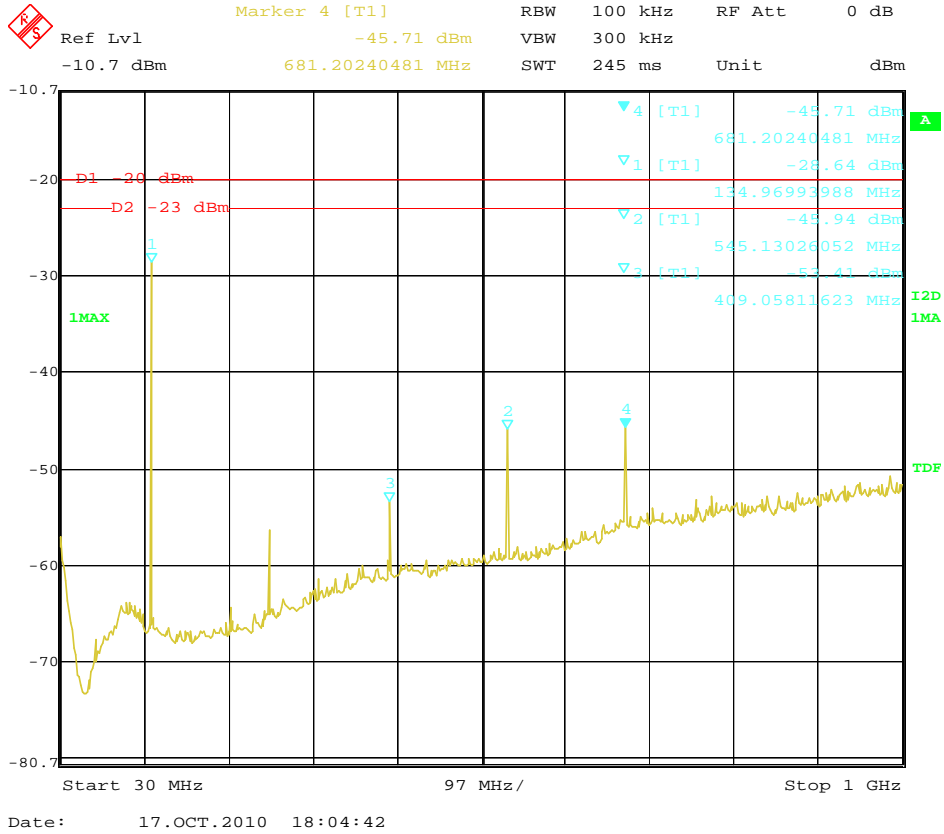

The Low channel for 12.5 KHz Channel Separation@ Vertical

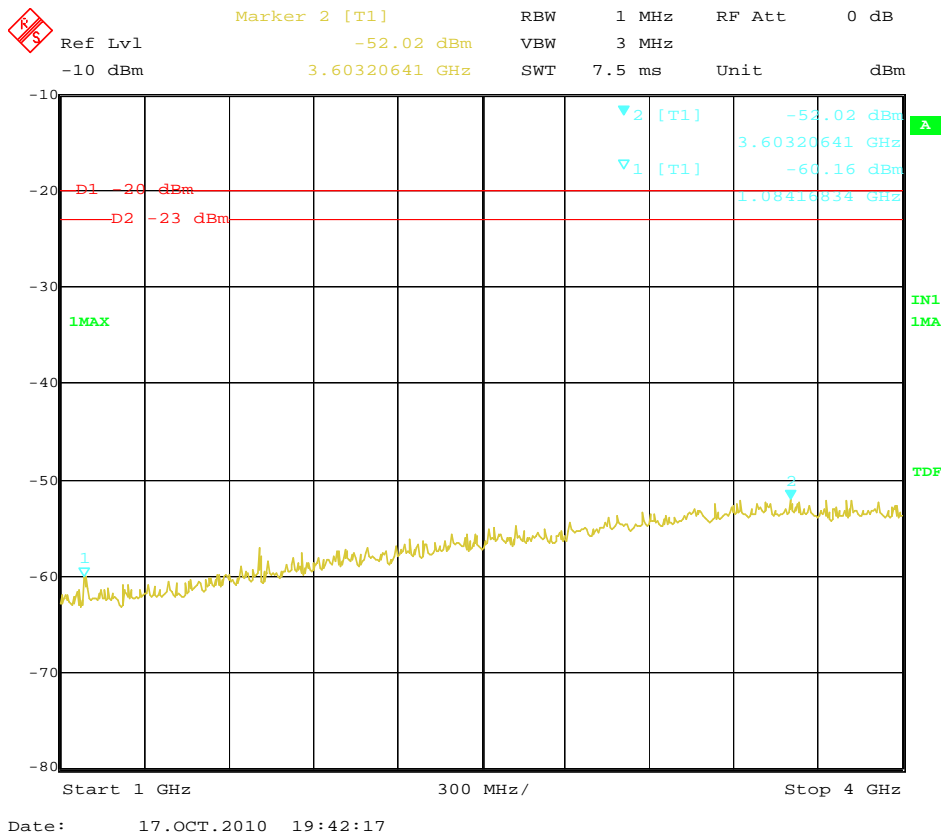
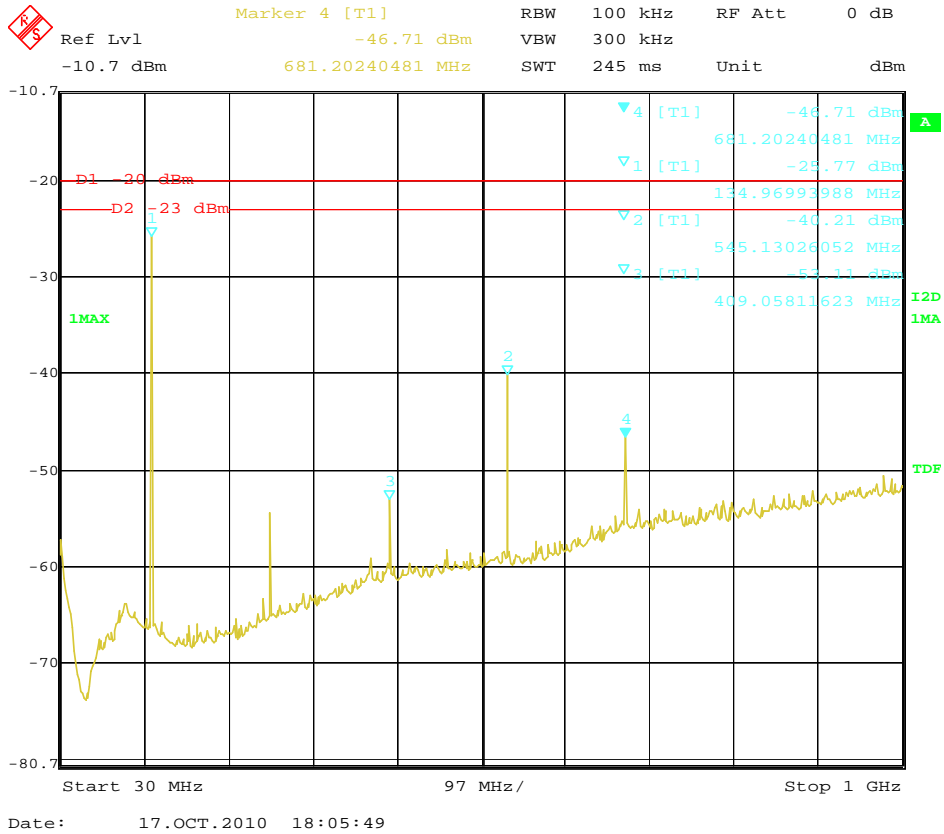

The Middle channel for 12.5 KHz Channel Separation @ Horizontal

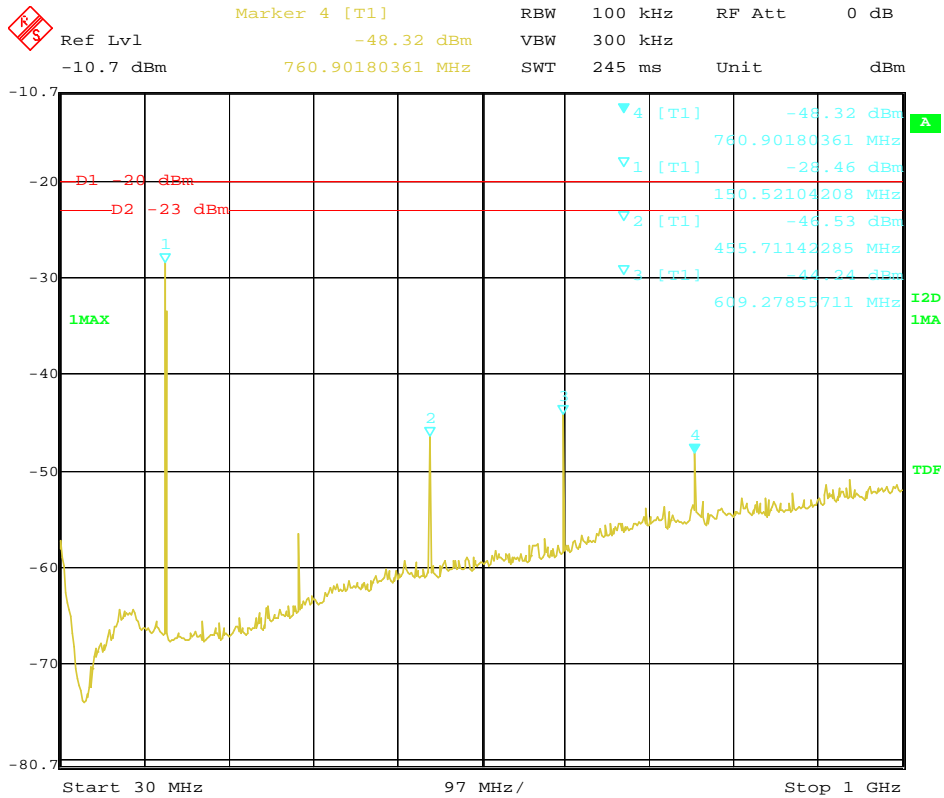

Date: 17.OCT.2010 18:08:48

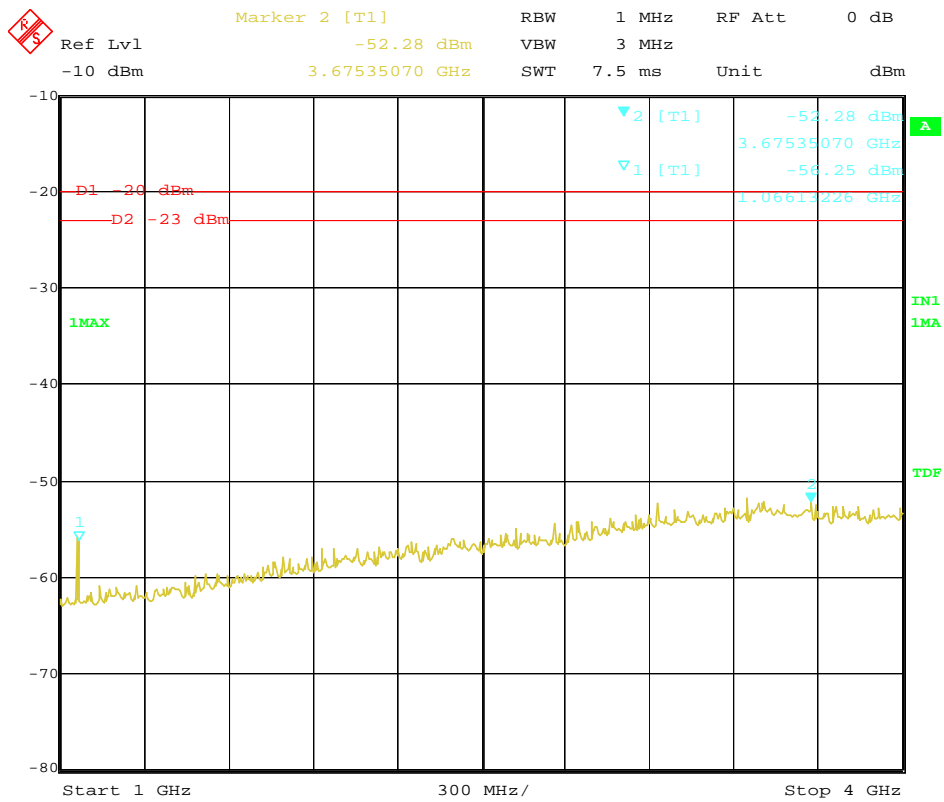

Date: 17.OCT.2010 19:38:32

The Middle channel for 12.5 KHz Channel Separation@ Vertical

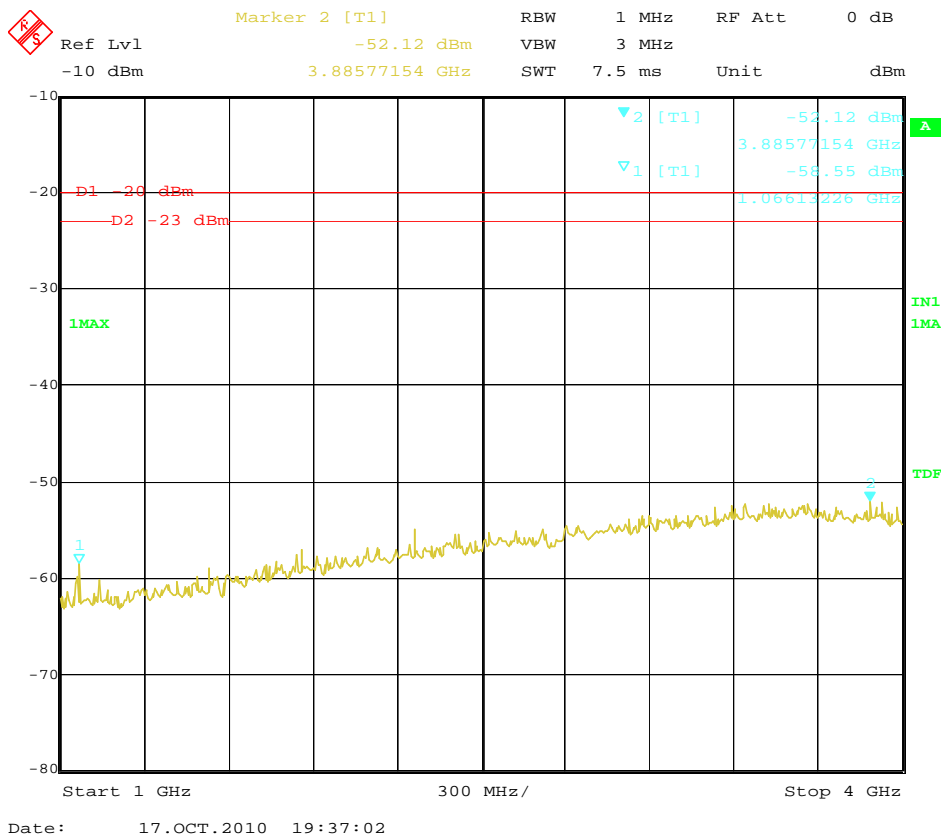
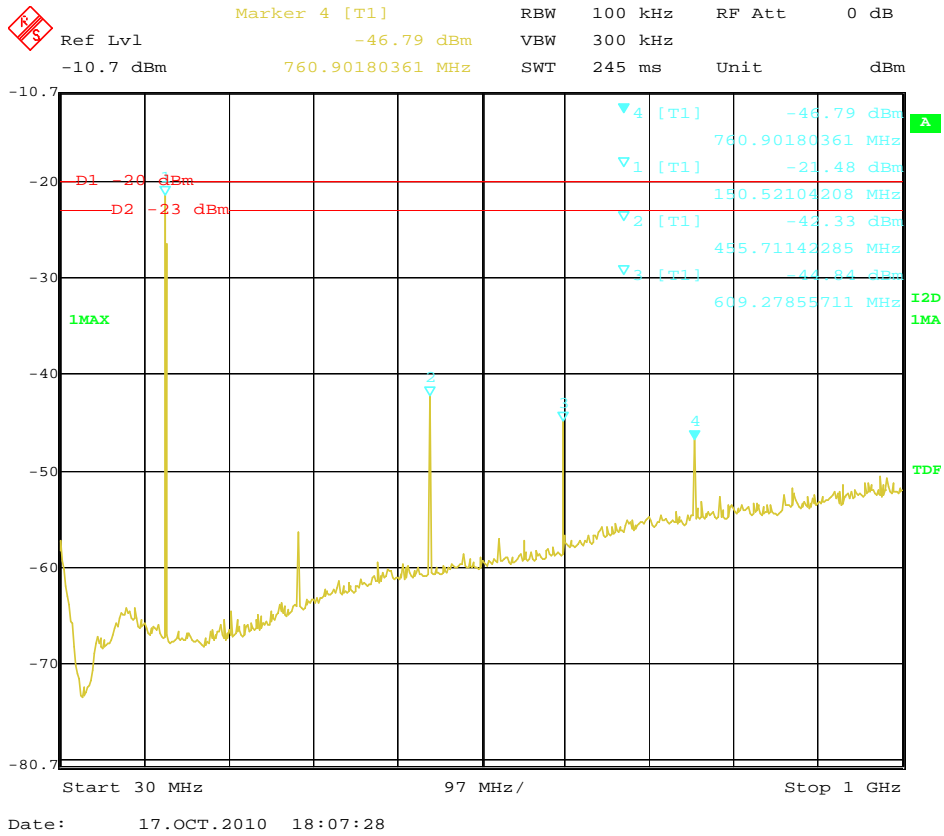

The High channel for 12.5 KHz Channel Separation @ Horizontal

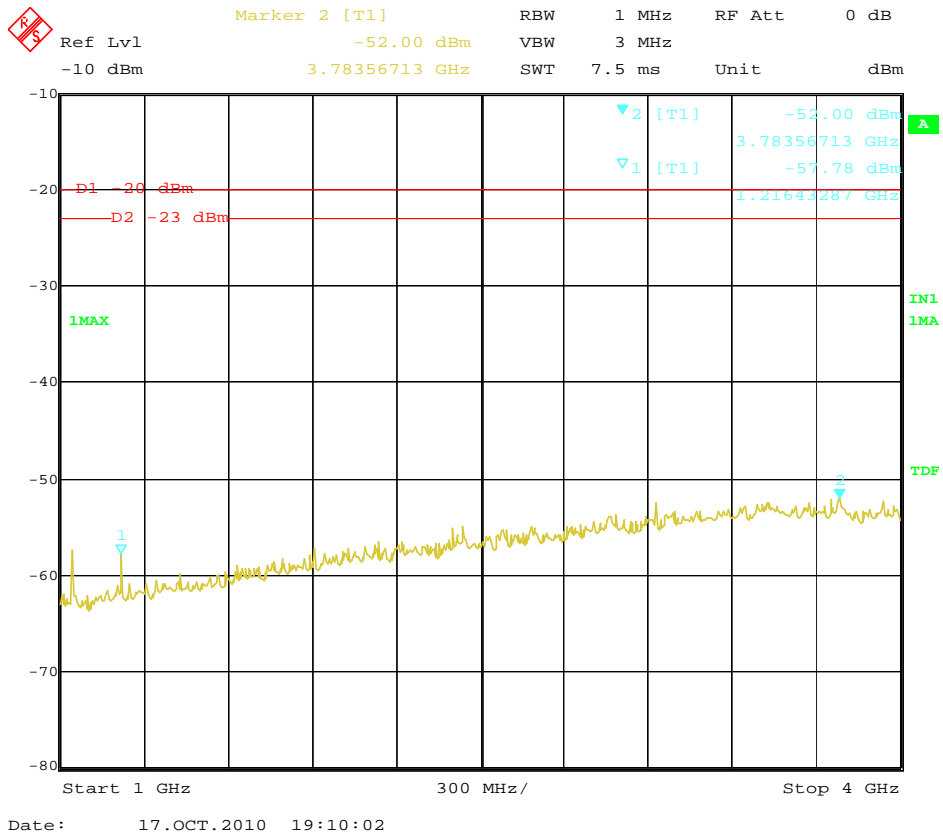
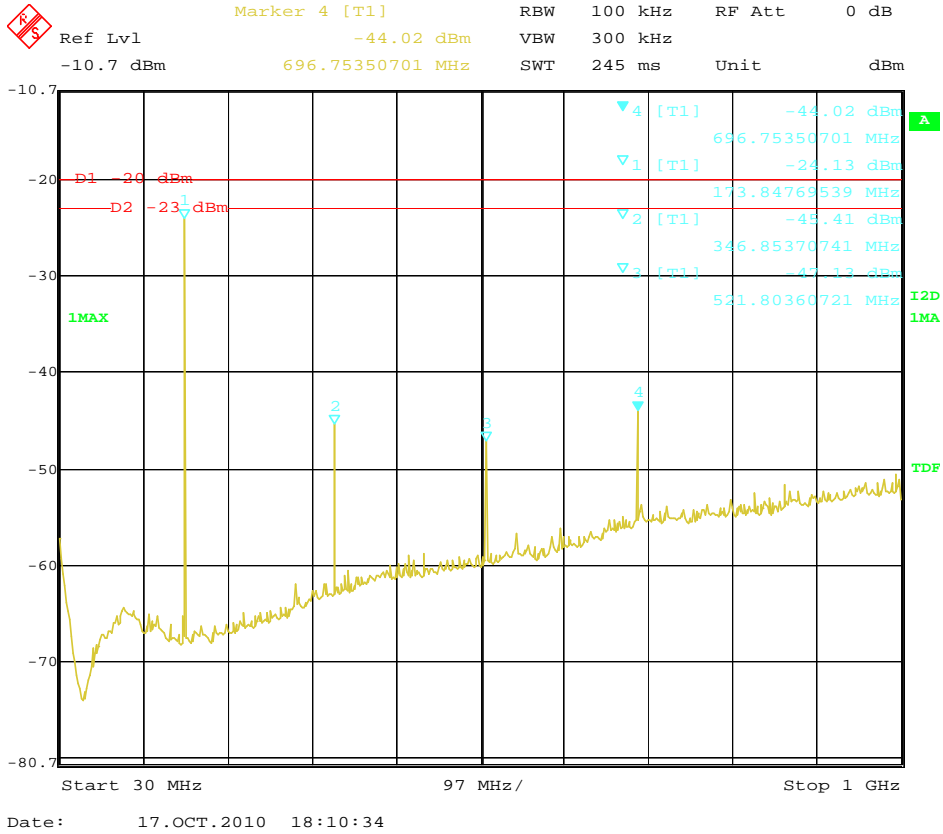

The High channel for 12.5 KHz Channel Separation @ Vertical

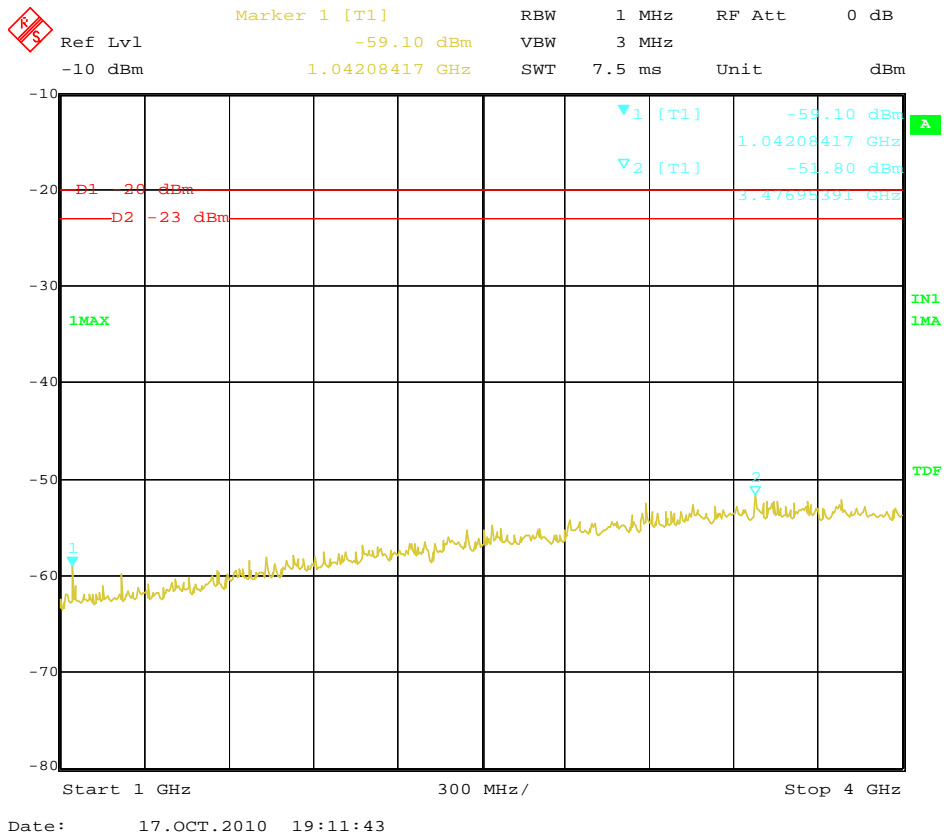
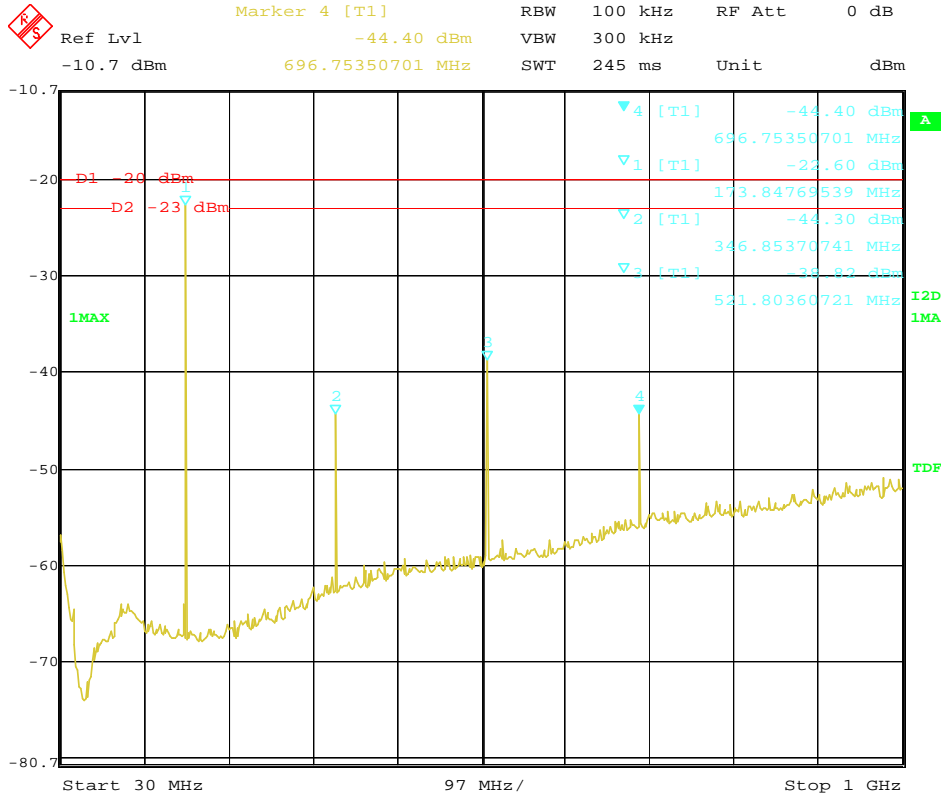

Modulation Type: 4FSK

The Low channel for 12.5 KHz Channel Separation @ Horizontal

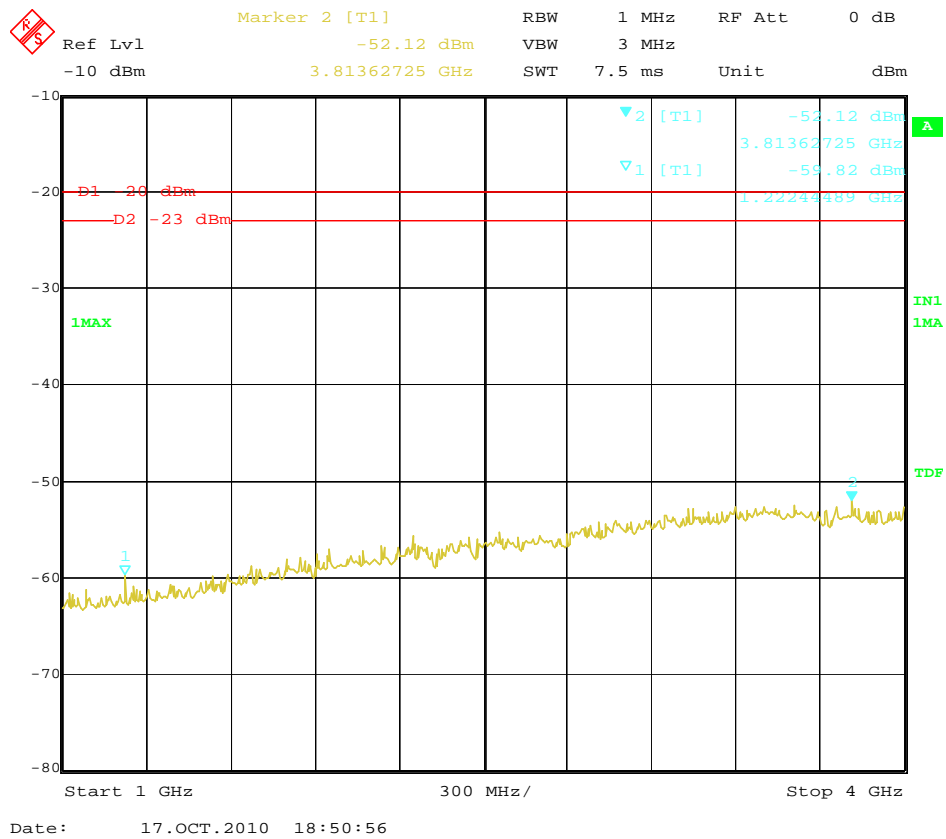
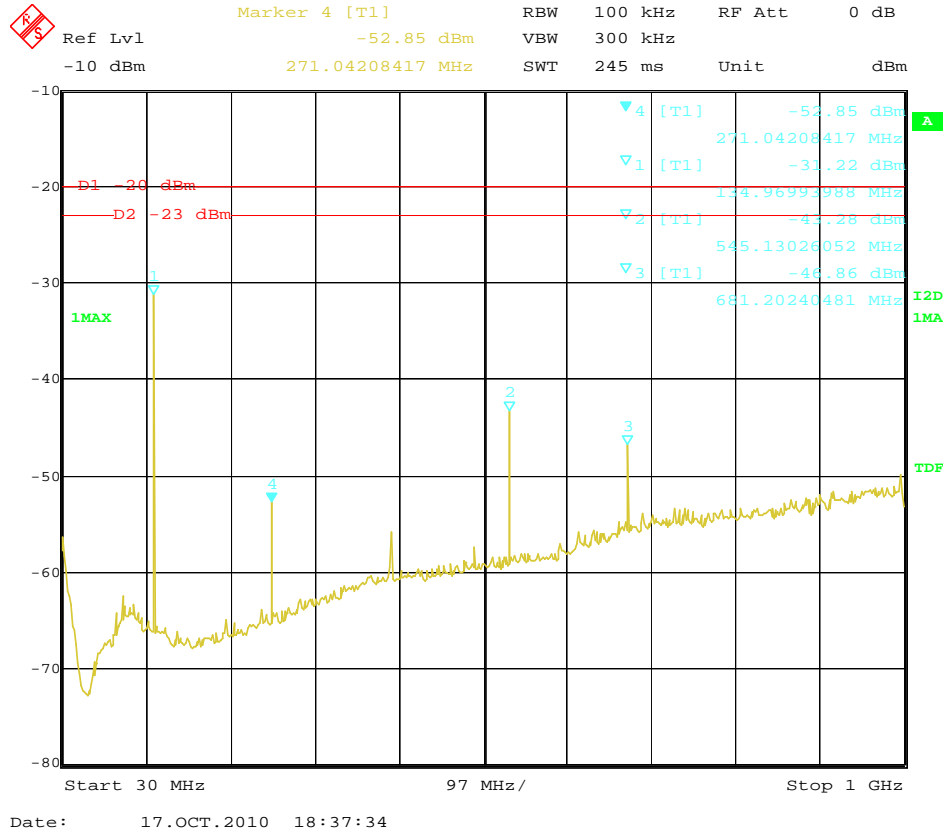

The Low channel for 12.5 KHz Channel Separation@ Vertical

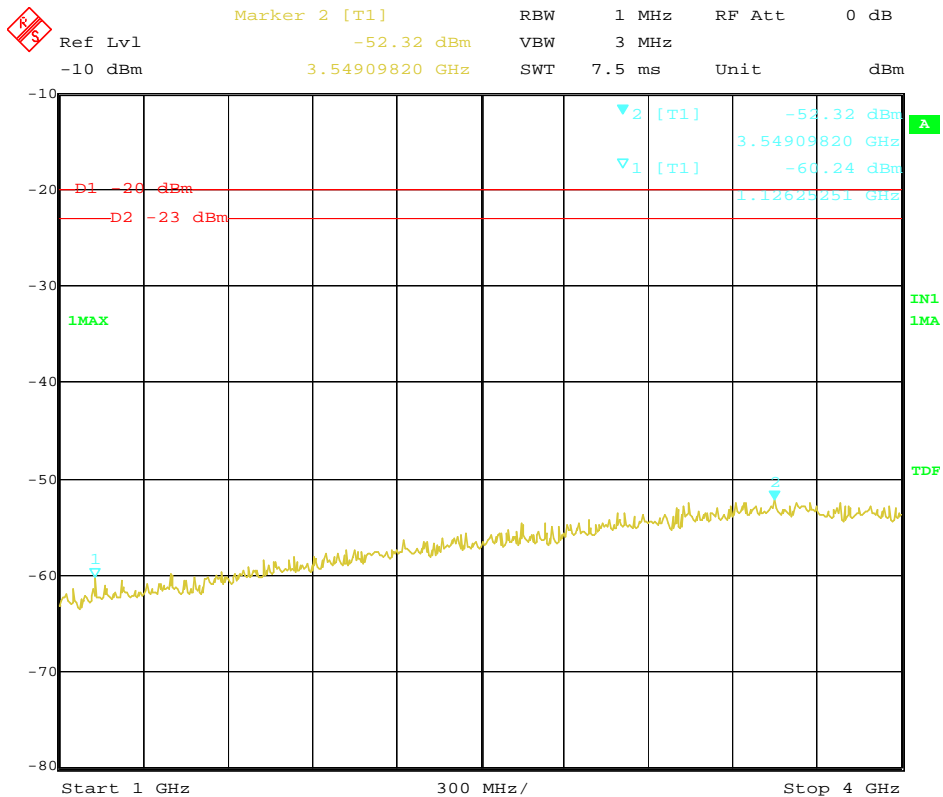
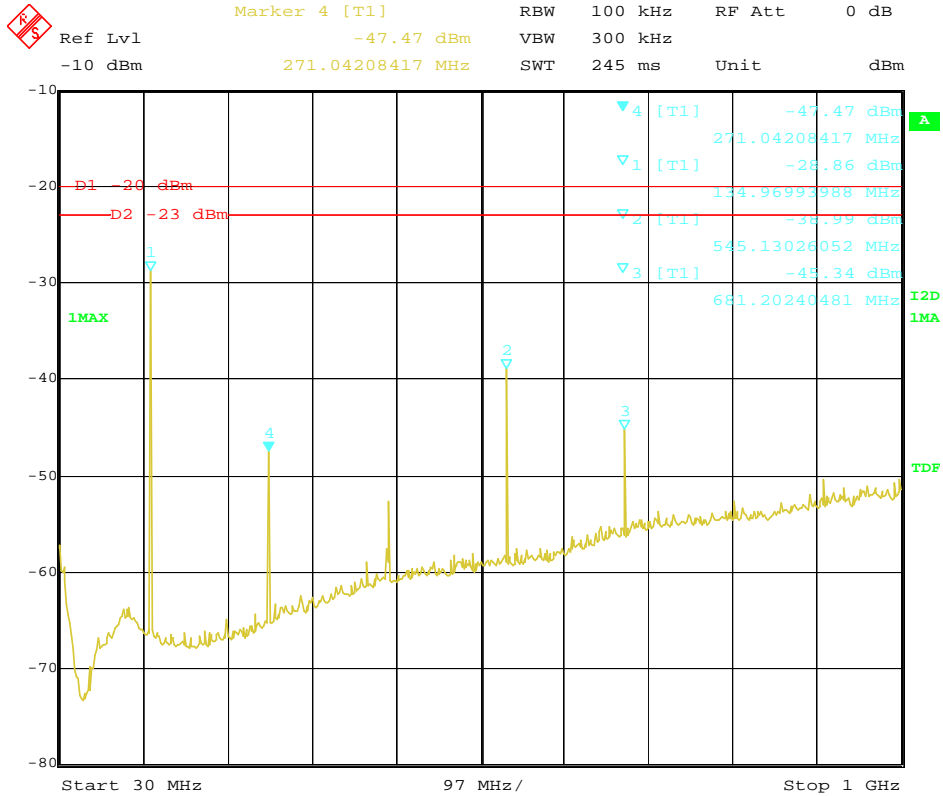

The Middle channel for 12.5 KHz Channel Separation @ Horizontal

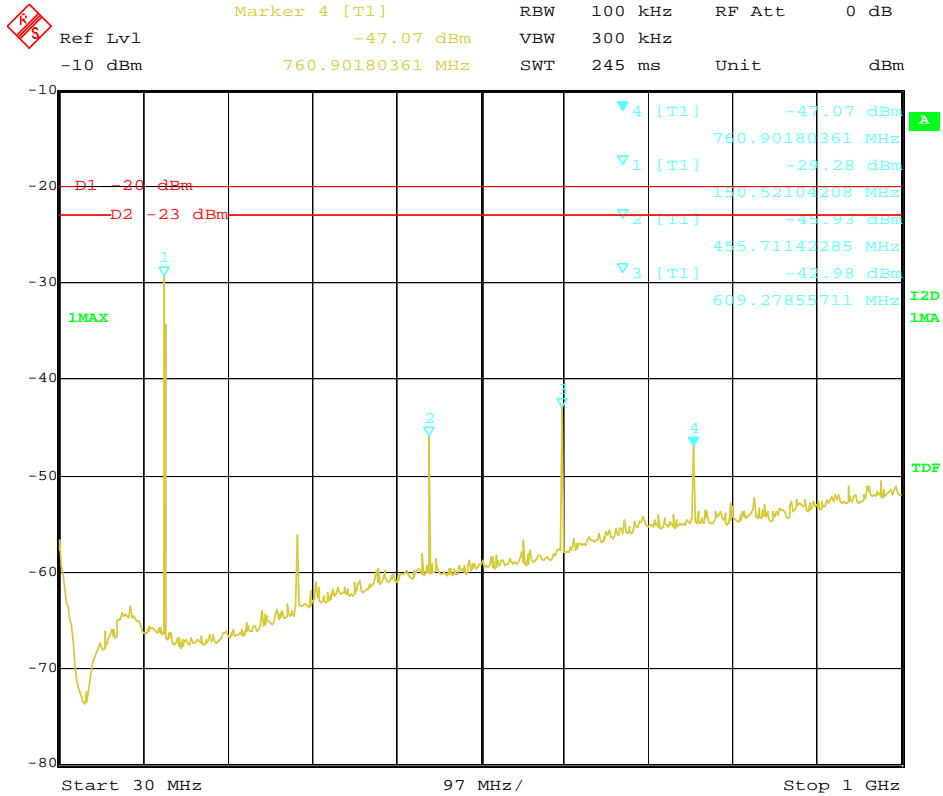

Date: 17.OCT.2010 18:33:02

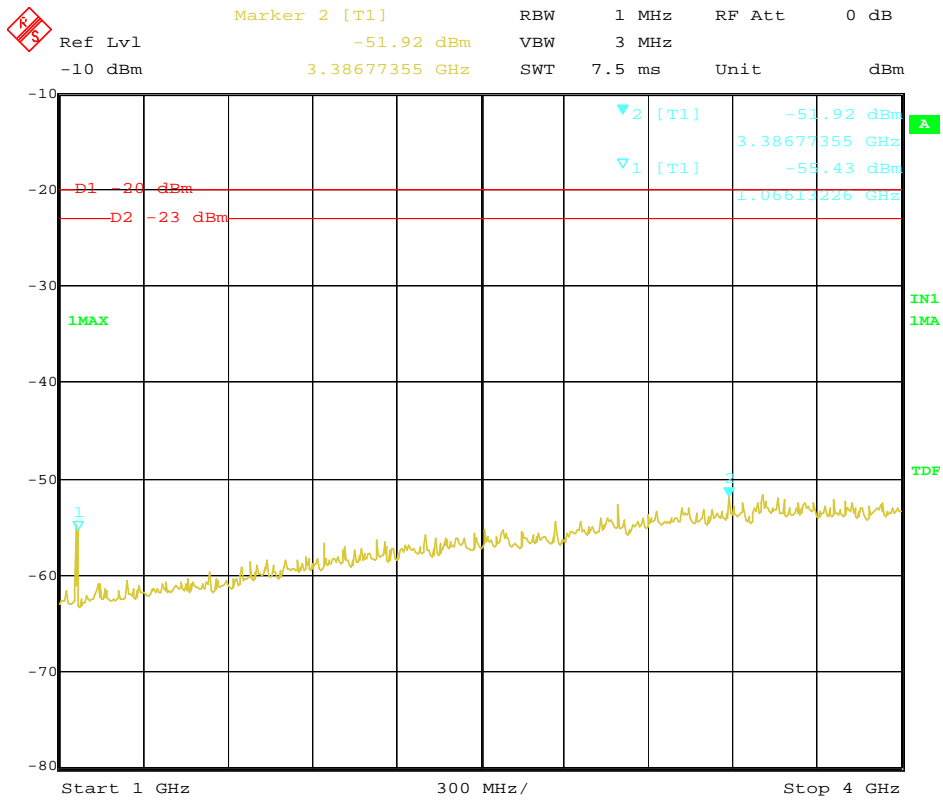

Date: 17.OCT.2010 18:49:10

The Middle channel for 12.5 KHz Channel Separation@ Vertical

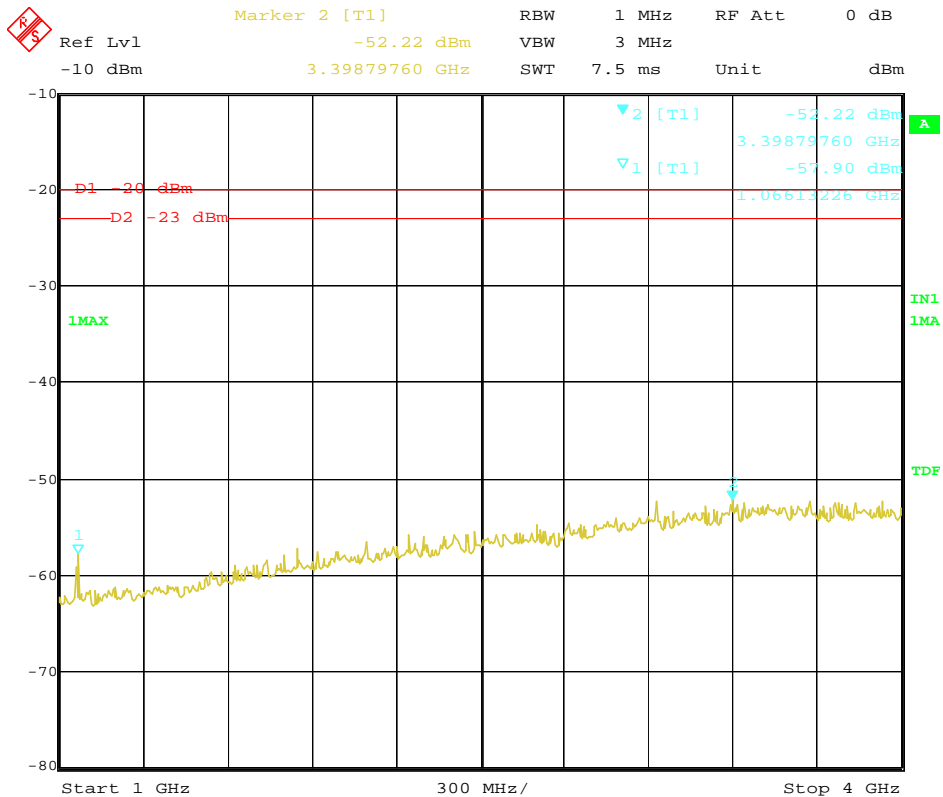
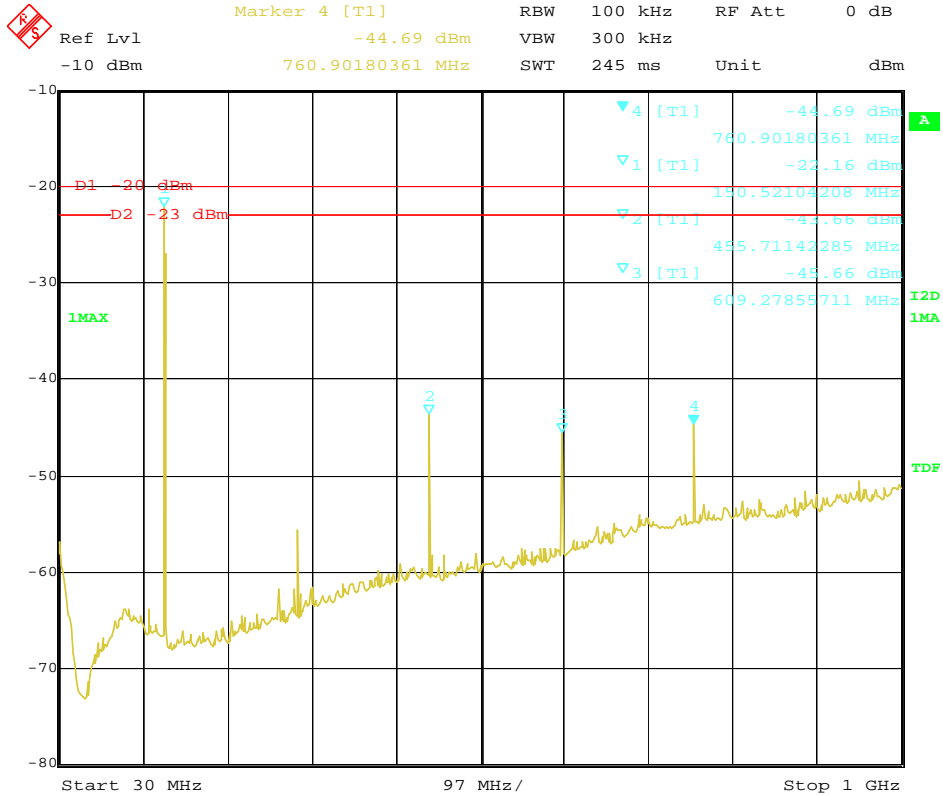

The High channel for 12.5 KHz Channel Separation @ Horizontal

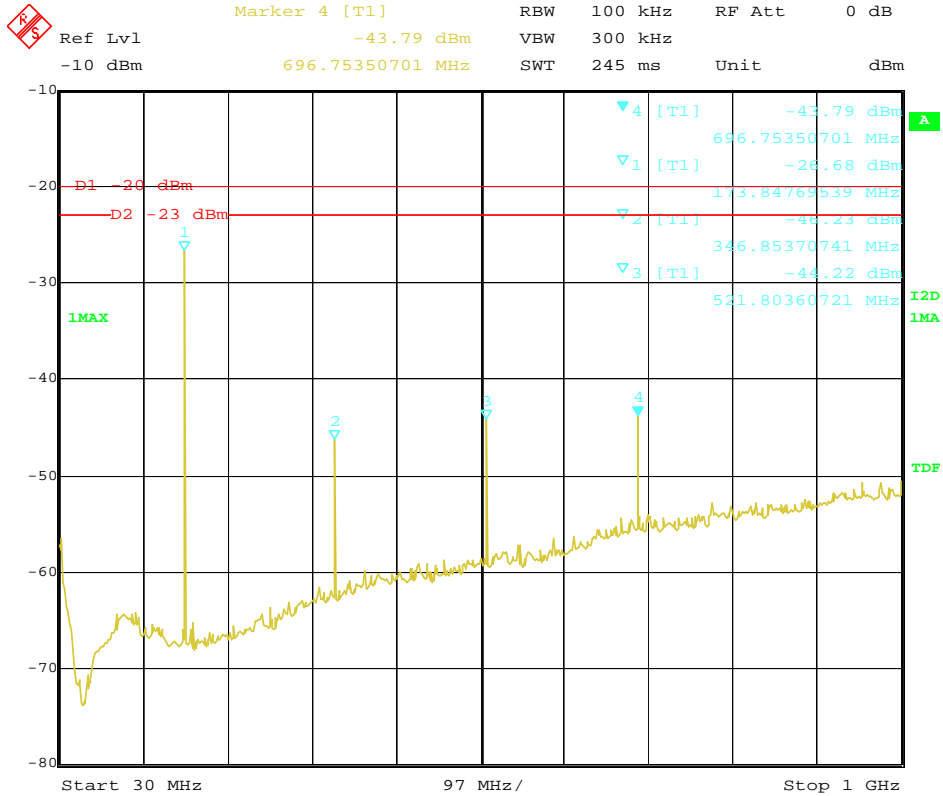

Date: 17.OCT.2010 18:31:13

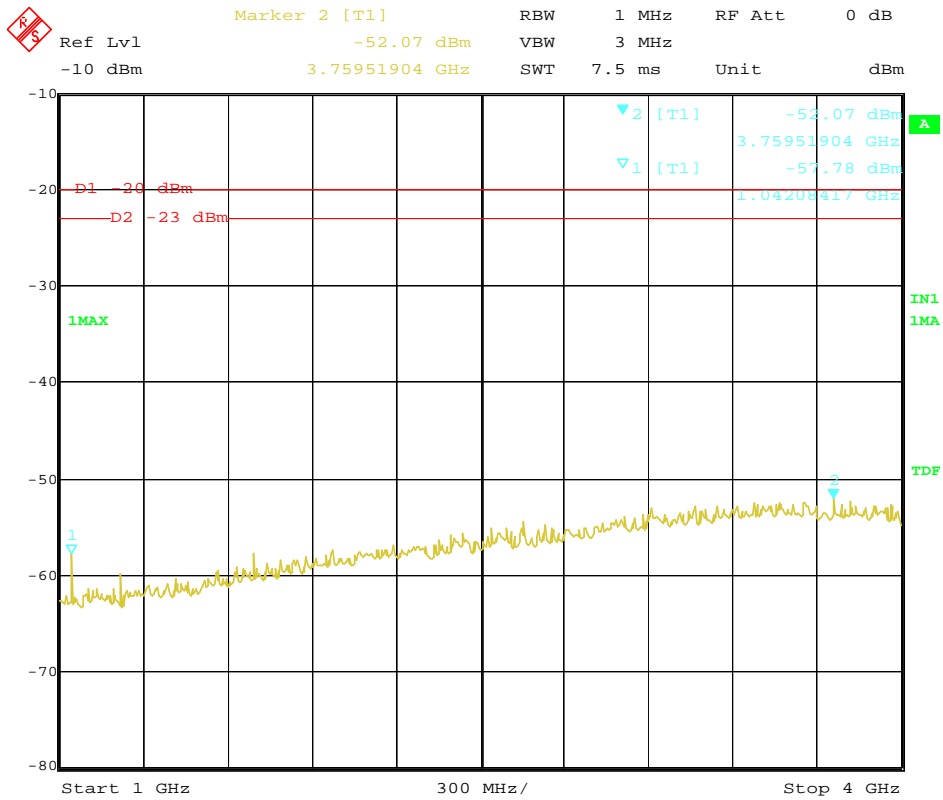

Date: 17.OCT.2010 18:44:05

The High channel for 12.5 KHz Channel Separation@Vertical

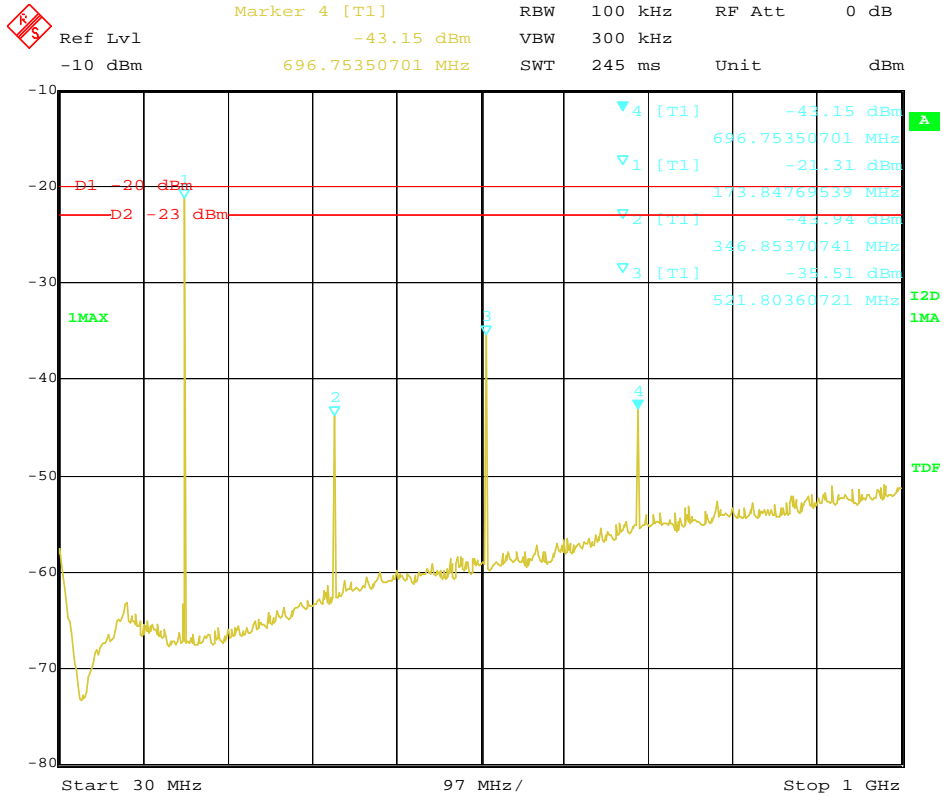

Date: 17.OCT.2010 18:29:57

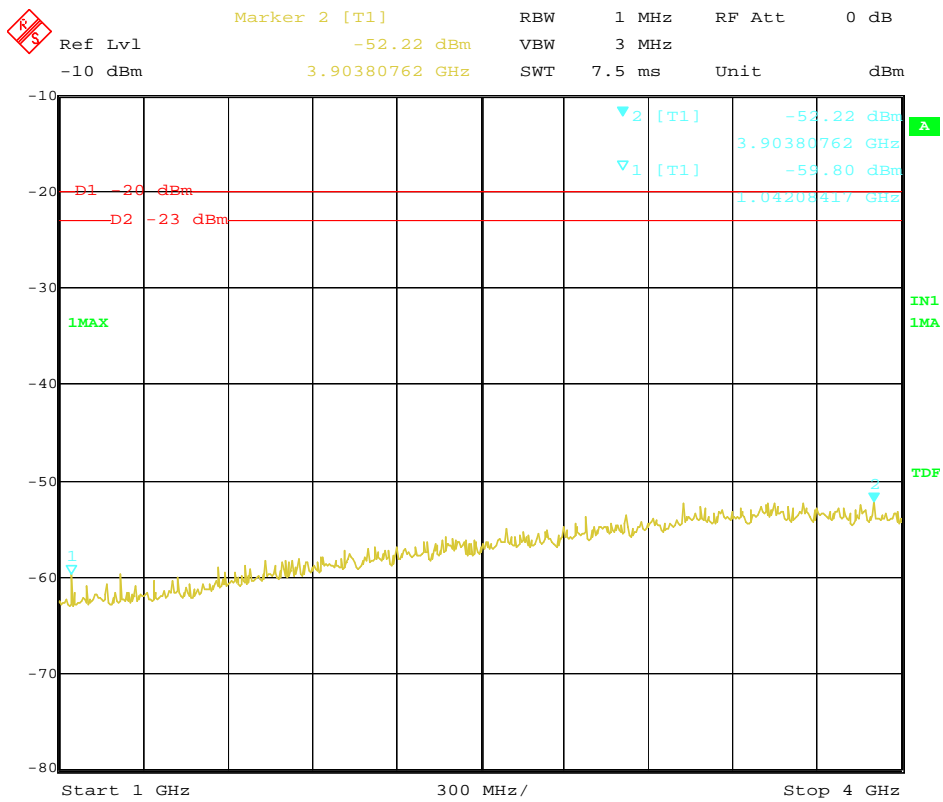

Date: 17.OCT.2010 18:45:40

4.4. Spurious Emssion on Antenna Port

TEST APPLICABLE

The same as Section 4.3

TEST PROCEDURE

The RF output of the EUT was connected to a spectrum analyzer through appropriate attenuation. The resolution bandwidth of the spectrum analyzer was set to 100 kHz. Sufficient scans were taken to show any out of band emission up to 10th. Harmonic for the lower and the highest frequency range. Set RBW 100 kHz, VBW 300 kHz in the frequency band 30MHz to 1GHz,while set RBW=1MHz.VBW=3MHz from the 1GHz to 10th Harmonic.

The audio input was set to 0 to get the unmodulated carrier, the resulting picture is print out for each channel separation.

TEST CONFIGURATION

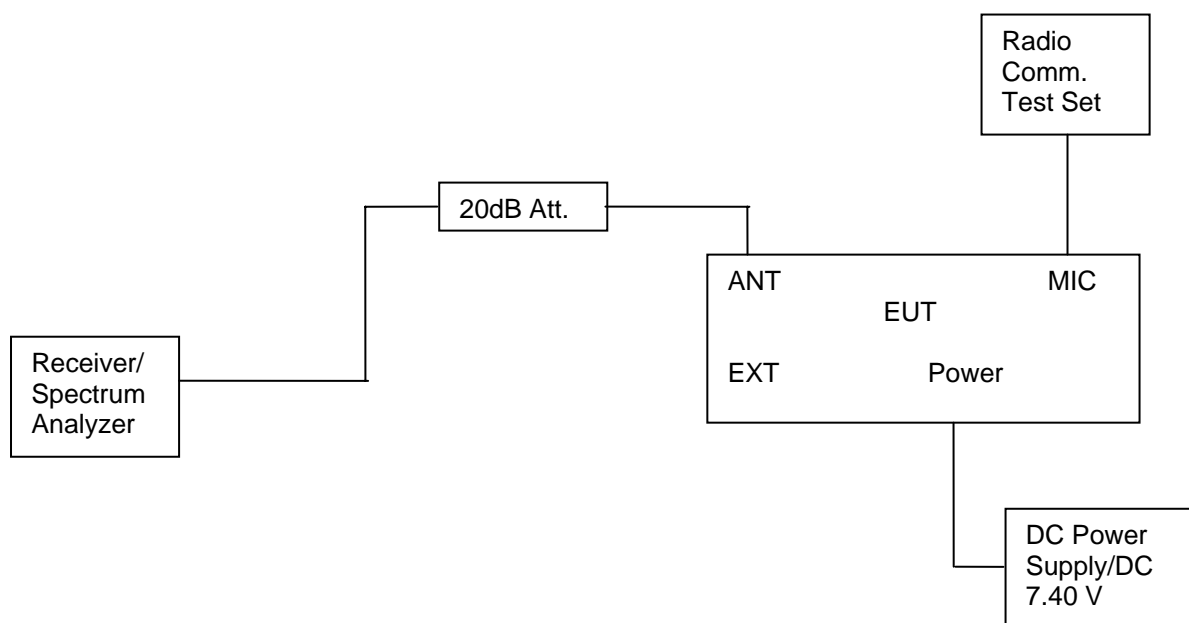

TEST RESULTS

Modulation Type: FM

FCC Part 22.359, 74.462, 80.211 and 90.210 and RSS Gen, RSS 119 Issue 9 (25 kHz bandwidth only): On any frequency removed from the center of the assigned channel by more than 250 percent at least:

Low: $43 + 10 \log (P_{watts}) = 43 + 10 \log (4.69) = 49.71 \text{ dB}$

High: $43 + 10 \log (P_{watts}) = 43 + 10 \log (4.80) = 49.81 \text{ dB}$

Calculation: Limit (dBm) = EL-43-10log10 (TP)

Notes: EL is the emission level of the Output Power expressed in dBm,
In this application, the EL is 36.99 dBm.

Limit (dBm) = $36.99 - 43 - 10 \log_{10} (4.80) = -13 \text{ dBm}$

FCC Part 22.359, 74.462, 80.211 and 90.210 and RSS Gen, RSS 119 Issue 9 (25 kHz bandwidth only): On any frequency removed from the center of the authorized bandwidth by a displacement frequency (f d in kHz) of more than 12.5 kHz at least:

Low: $50 + 10 \log (P_{watts}) = 50 + 10 \log (4.72) = 56.74 \text{ dB}$

High: $50 + 10 \log (P_{watts}) = 50 + 10 \log (4.88) = 56.88 \text{ dB}$

Note: In general, the worse case attenuation requirement shown above was applied.

Calculation: Limit (dBm) = EL-50-10log10 (TP)

Notes: EL is the emission level of the Output Power expressed in dBm,
In this application, the EL is 36.99 dBm.

Limit (dBm) = $36.99 - 50 - 10 \log_{10} (4.88) = -20 \text{ dBm}$

Modulation Type: 4FSK

FCC Part 22.359, 74.462, 80.211 and 90.210 and RSS Gen, RSS 119 Issue 9 (12.5 kHz Bandwidth only):
On any frequency removed from the center of the authorized bandwidth by a displacement frequency (f_d in kHz) of more than 12.5 kHz at least:

Low: $50 + 10 \log(P_{\text{watts}}) = 50 + 10 \log(4.69) = 56.71 \text{ dB}$

High: $50 + 10 \log(P_{\text{watts}}) = 50 + 10 \log(4.84) = 56.85 \text{ dB}$

Note: In general, the worse case attenuation requirement shown above was applied.

Calculation: Limit (dBm) = EL-50-10log10 (TP)

Notes: EL is the emission level of the Output Power expressed in dBm,

In this application, the EL is 36.99 dBm.

Limit (dBm) = $36.99 - 50 - 10 \log_{10}(4.84) = -20 \text{ dBm}$

Note: 1. In general, the worse case attenuation requirement shown above was applied.

2. The measurement frequency range from 30MHz to 4 GHz.

For Rated High Power (5Watt)

Modulation Type	Channel Separation	Test Channel	Test Frequency (MHz)	Maximum Conducted Spurious Emissions Below 1GHz		Maximum Conducted Spurious Emissions Above 1GHz	
				Frequency (MHz)	Datum (dBm)	Frequency (MHz)	Datum (dBm)
FM	25KHz	Low	136.1220	271.04	-24.70	2382.77	-27.69
		Middle	152.1220	304.09	-23.85	2941.88	-27.49
		High	173.9220	346.85	-24.80	2941.19	-26.79
	12.5KHz	Low	136.1220	271.04	-24.85	2653.31	-26.50
		Middle	152.1220	304.09	-24.05	3074.15	-27.43
		High	173.9220	346.85	-24.78	3308.62	-27.66
4FSK	12.5KHz	Low	136.1220	271.04	-24.66	2629.26	-26.69
		Middle	152.1220	304.09	-23.88	2521.04	-27.45
		High	173.9220	346.85	-23.55	3765.53	-27.54
Limit		-13dBm for 25KHz Channel Separation					
		-20dBm for 12.5KHz Channel Separation					
Test Results		Compliance					

For Rated Low Power (1Watt)

Modulation Type	Channel Separation	Test Channel	Test Frequency (MHz)	Maximum Conducted Spurious Emissions Below 1GHz		Maximum Conducted Spurious Emissions Above 1GHz	
				Frequency (MHz)	Datum (dBm)	Frequency (MHz)	Datum (dBm)
FM	25KHz	Low	136.1220	271.04	-34.33	2971.94	-27.78
		Middle	152.1220	304.09	-33.38	2923.85	-26.86
		High	173.9220	346.85	-33.70	3032.06	-27.19
	12.5KHz	Low	136.1220	271.04	-34.25	2527.05	-26.99
		Middle	152.1220	304.09	-32.75	2196.39	-26.37
		High	173.9220	346.85	-33.67	3092.18	-27.72
4FSK	12.5KHz	Low	136.1220	271.04	-33.90	2941.88	-27.64
		Middle	152.1220	304.09	-33.38	3458.92	-27.29
		High	173.9220	346.85	-34.37	2911.82	-26.72
Limit		-13dBm for 25KHz Channel Separation					
		-20dBm for 12.5KHz Channel Separation					
Test Results		Compliance					

Plots of Spurious Emission on Antenna Port Measurement**For Rated High Power (5Watt)**

Modulation Type	Channel SpARATION	Test Channel	Test Frequency (MHz)	Maximum Conducted Spurious Emissions Below 1GHz		Maximum Conducted Spurious Emissions Above 1GHz		FCC Limit
				Frequency (MHz)	Datum (dBm)	Frequency (MHz)	Datum (dBm)	
FM	25KHz	Low	136.1220	271.04	-24.70	2382.77	-27.69	-13dBm
Test Results				Compliance				

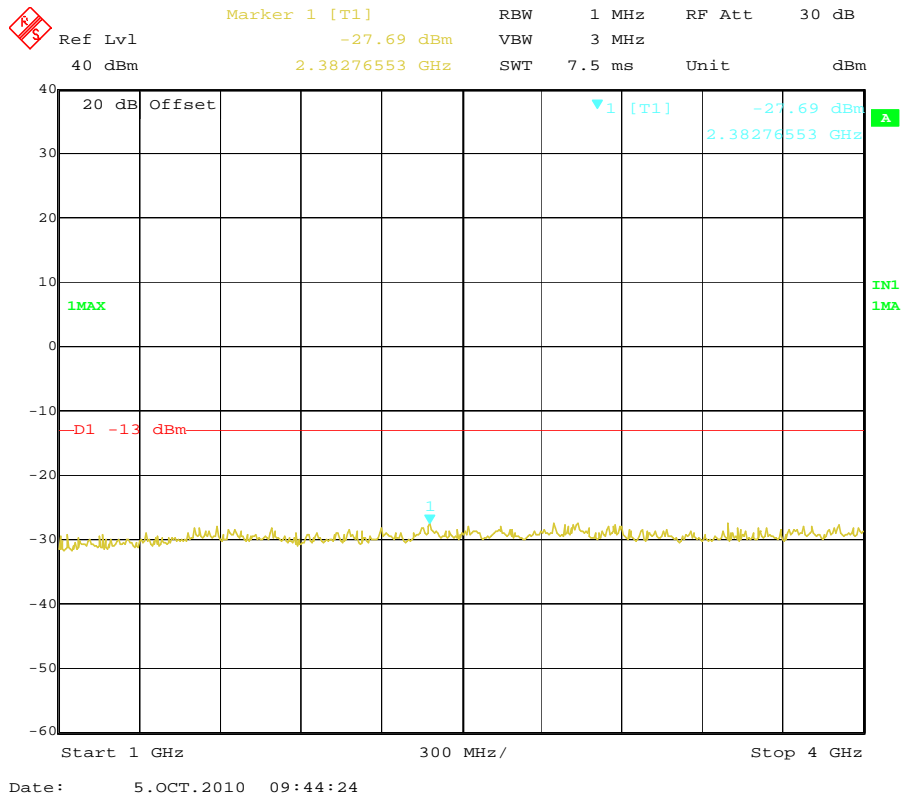
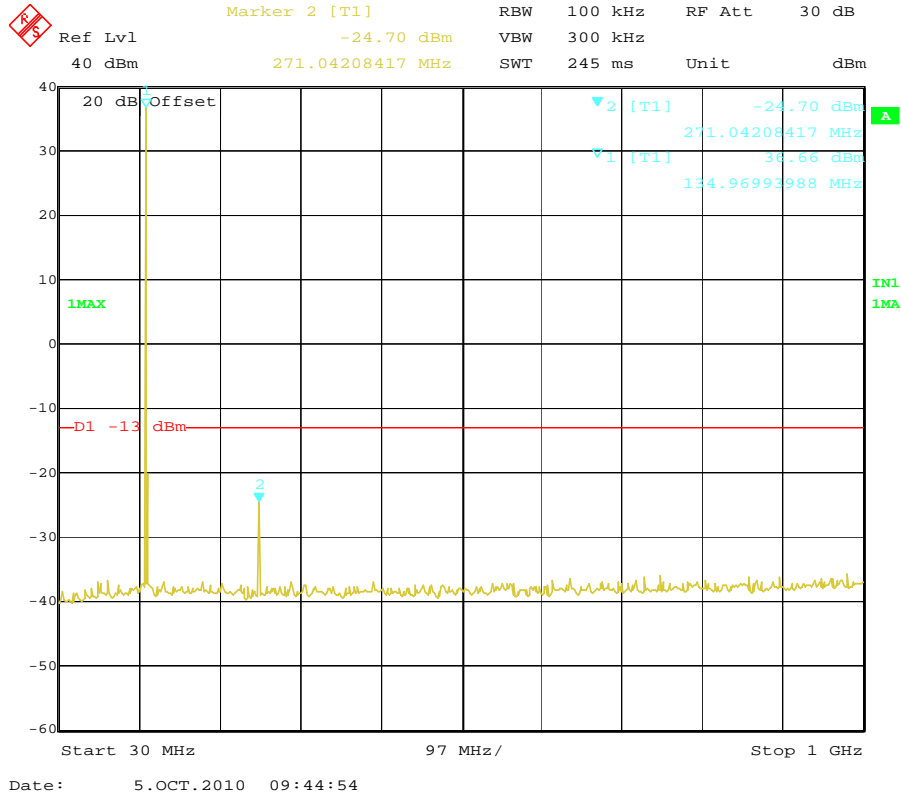

Modulation Type	Channel SpARATION	Test Channel	Test Frequency (MHz)	Maximum Conducted Spurious Emissions Below 1GHz		Maximum Conducted Spurious Emissions Above 1GHz		FCC Limit
				Frequency (MHz)	Datum (dBm)	Frequency (MHz)	Datum (dBm)	
FM	25KHz	Middle	152.1220	304.09	-23.85	2941.88	-27.49	-13dBm
Test Results				Compliance				

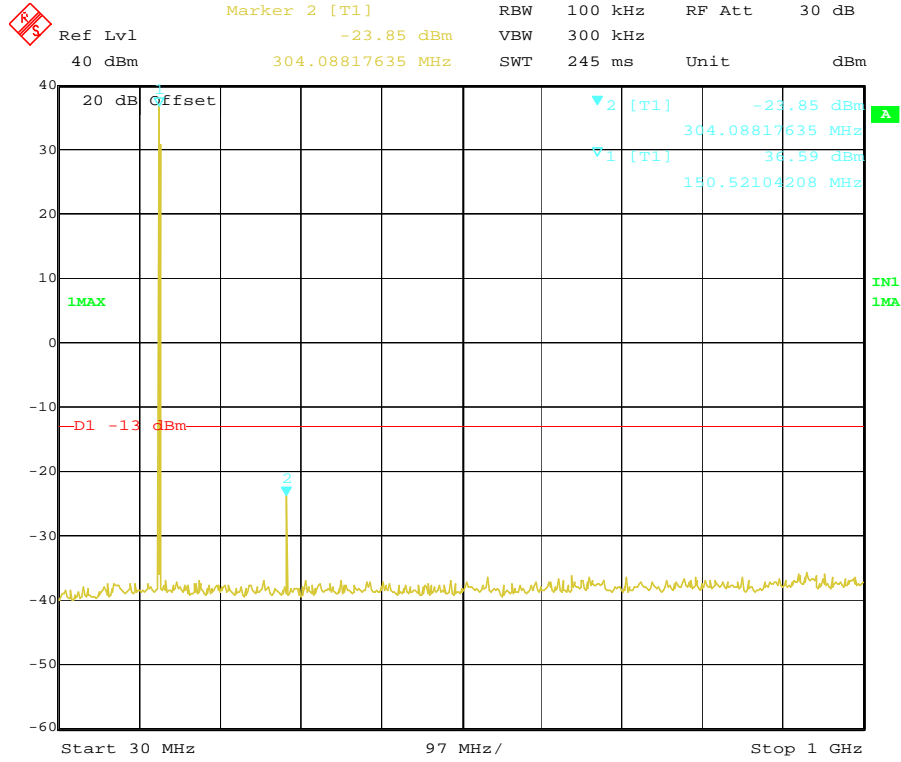

Date: 5.OCT.2010 09:45:15

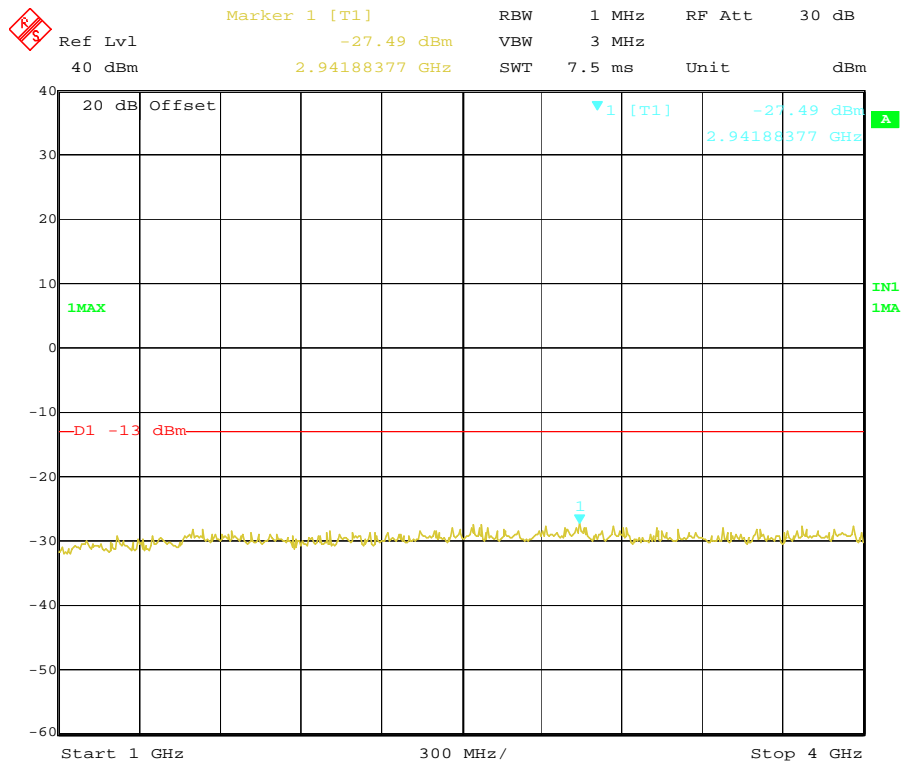

Date: 5.OCT.2010 09:45:48

Modulation Type	Channel Separation	Test Channel	Test Frequency (MHz)	Maximum Conducted Spurious Emissions Below 1GHz		Maximum Conducted Spurious Emissions Above 1GHz		FCC Limit
				Frequency (MHz)	Datum (dBm)	Frequency (MHz)	Datum (dBm)	
FM	25KHz	High	173.9220	346.85	-24.80	2941.19	-26.79	-13dBm
Test Results				Compliance				

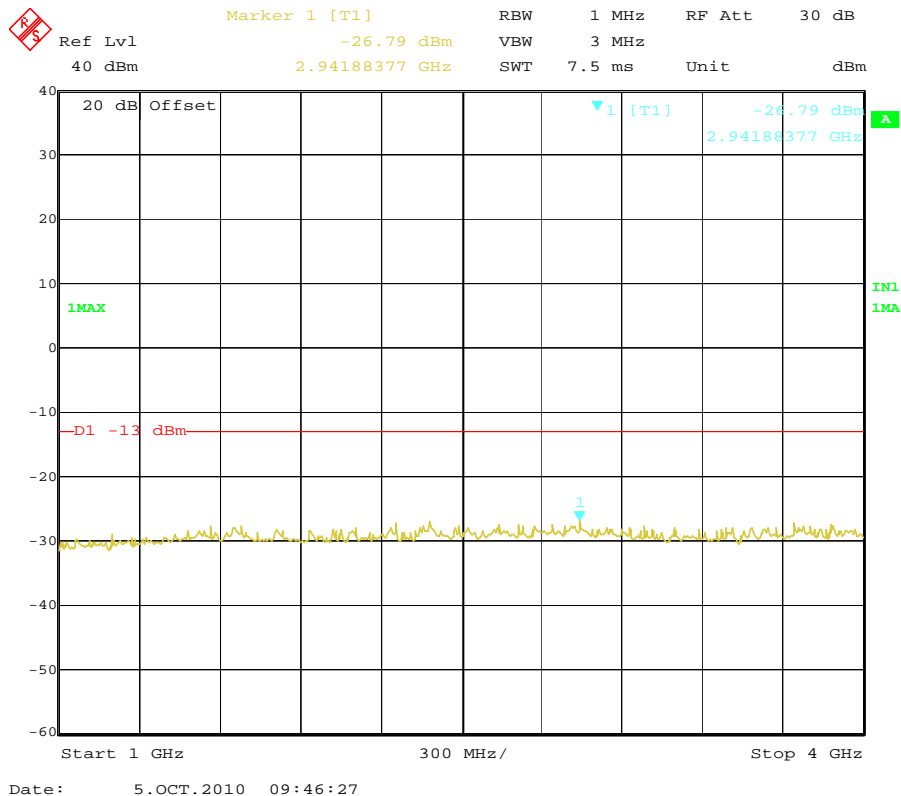
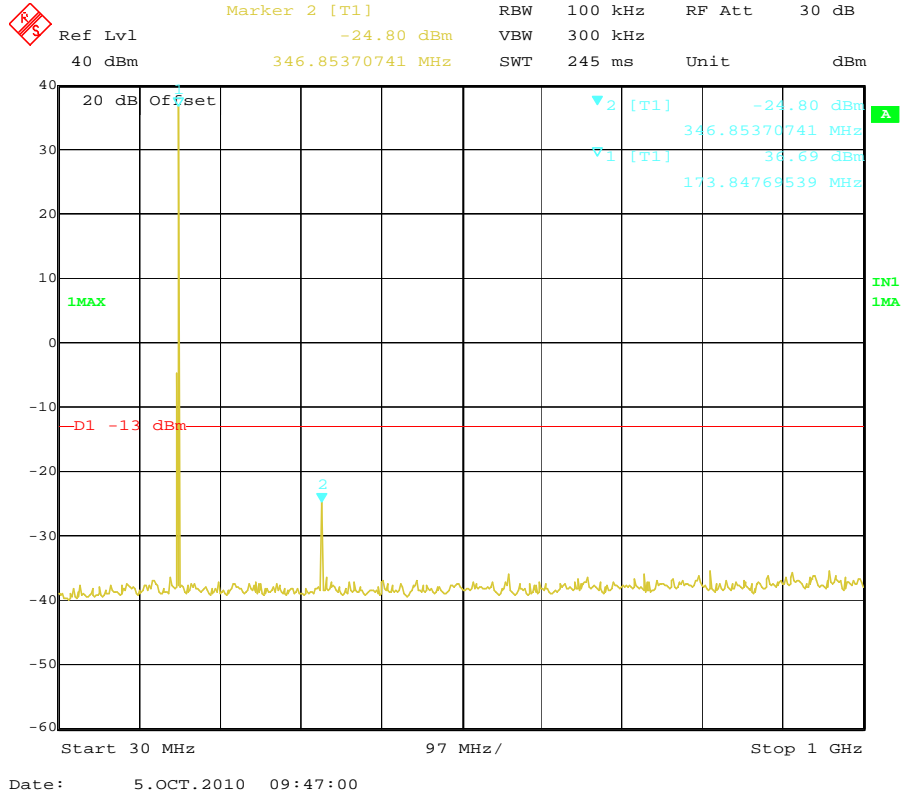

Modulation Type	Channel SpARATION	Test Channel	Test Frequency (MHz)	Maximum Conducted Spurious Emissions Below 1GHz		Maximum Conducted Spurious Emissions Above 1GHz		FCC Limit
				Frequency (MHz)	Datum (dBm)	Frequency (MHz)	Datum (dBm)	
FM	12.5KHz	Low	136.1220	271.04	-24.85	2653.31	-26.50	-20dBm
Test Results				Compliance				

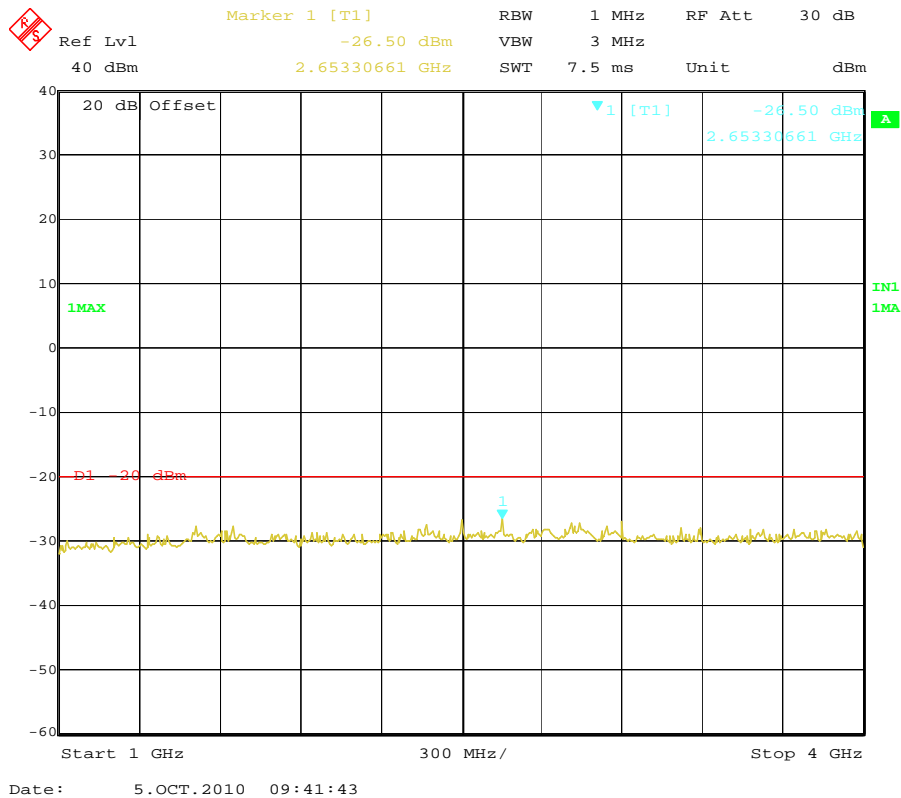
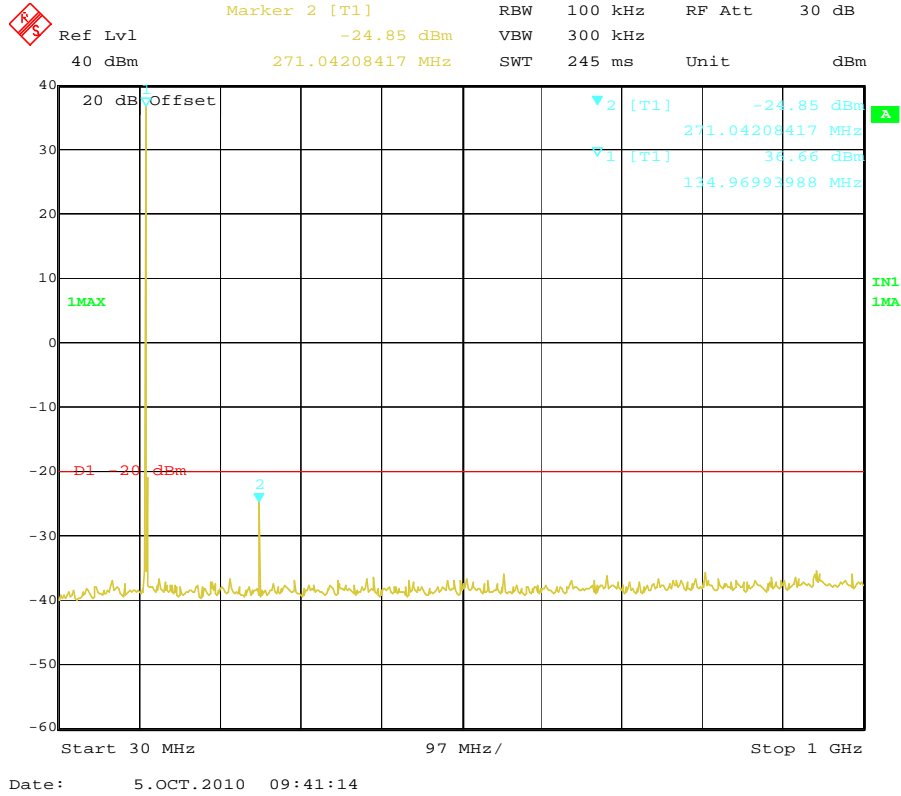

Modulation Type	Channel SpARATION	Test Channel	Test Frequency (MHz)	Maximum Conducted Spurious Emissions Below 1GHz		Maximum Conducted Spurious Emissions Above 1GHz		FCC Limit
				Frequency (MHz)	Datum (dBm)	Frequency (MHz)	Datum (dBm)	
FM	12.5KHz	Middle	152.1220	304.09	-24.05	3074.15	-27.43	-20dBm
Test Results				Compliance				

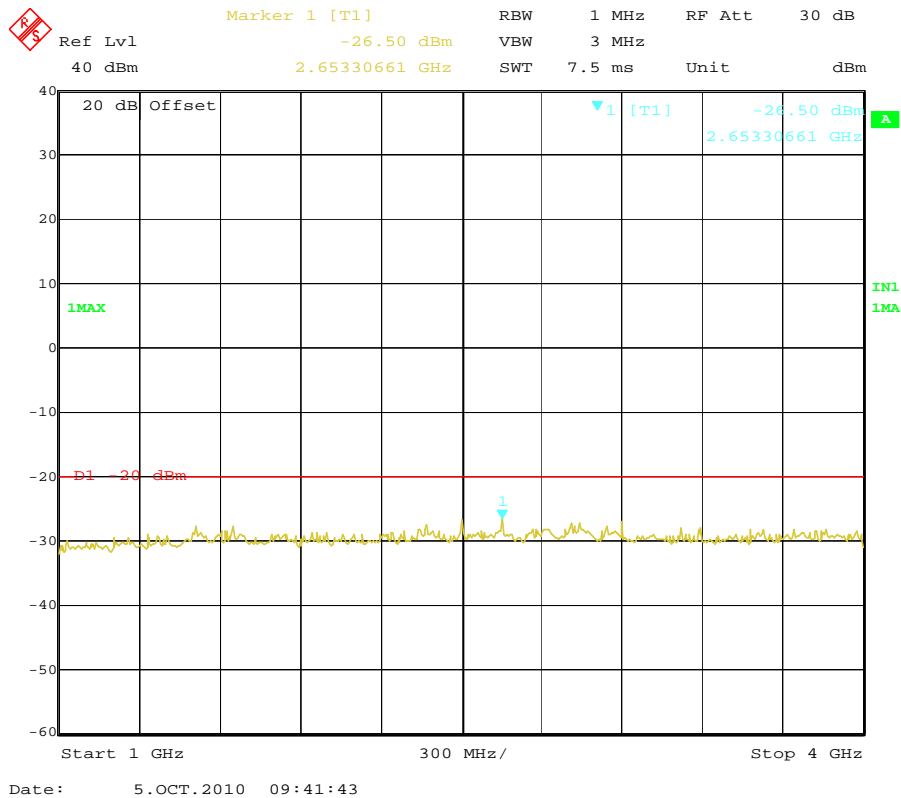
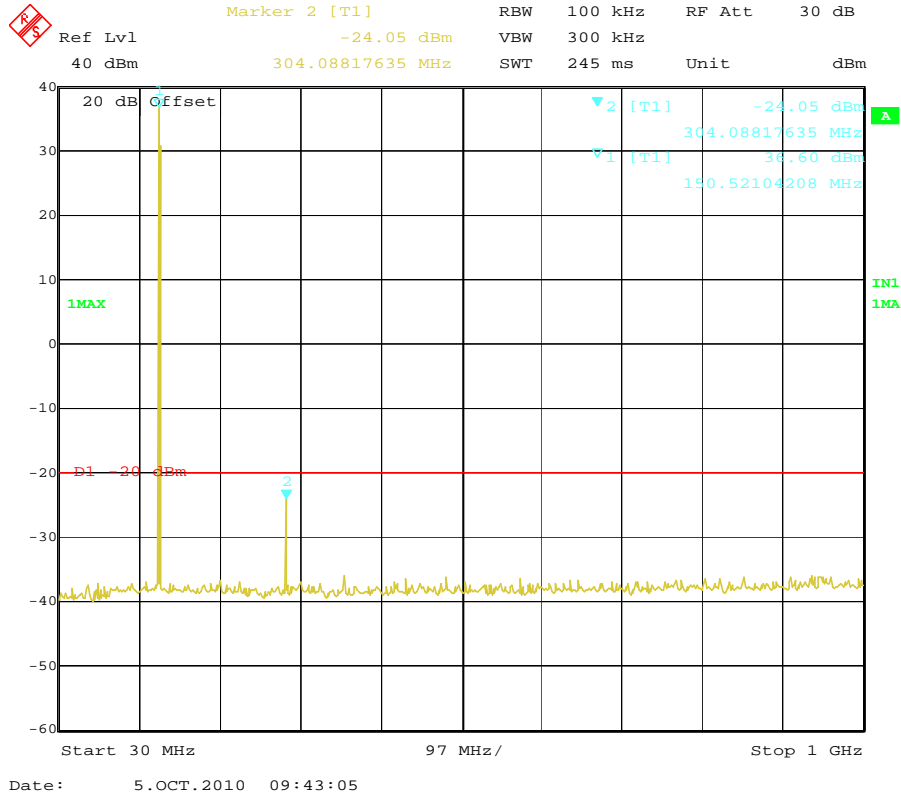

Modulation Type	Channel Separation	Test Channel	Test Frequency (MHz)	Maximum Conducted Spurious Emissions Below 1GHz		Maximum Conducted Spurious Emissions Above 1GHz		FCC Limit
				Frequency (MHz)	Datum (dBm)	Frequency (MHz)	Datum (dBm)	
FM	12.5KHz	High	173.9220	346.85	-24.78	3308.62	-27.66	-20dBm
Test Results				Compliance				

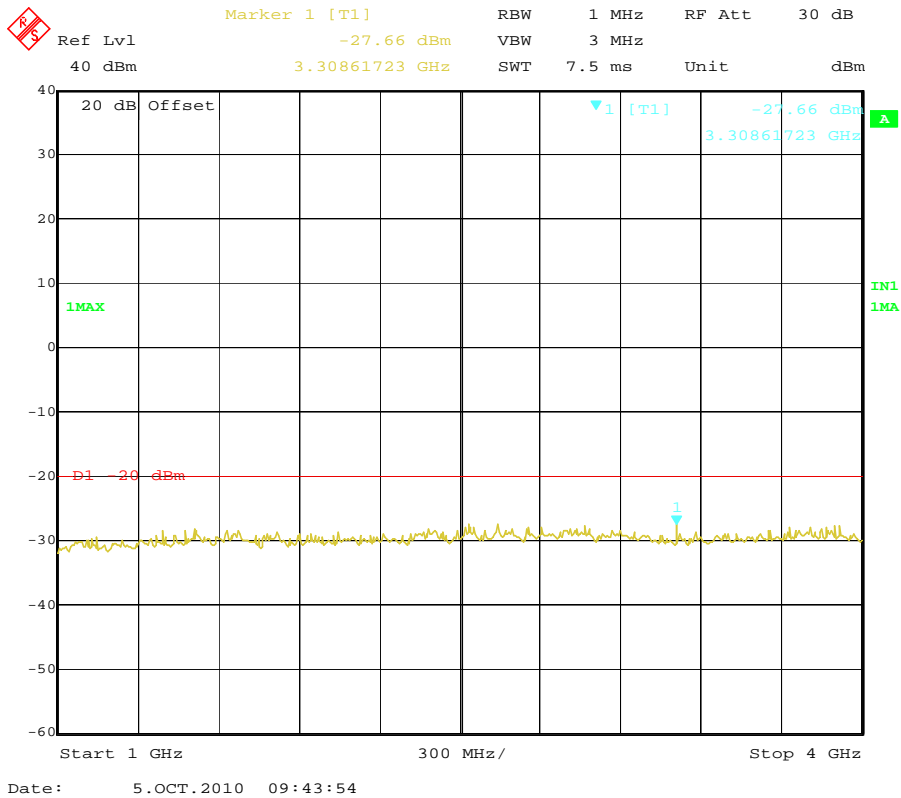
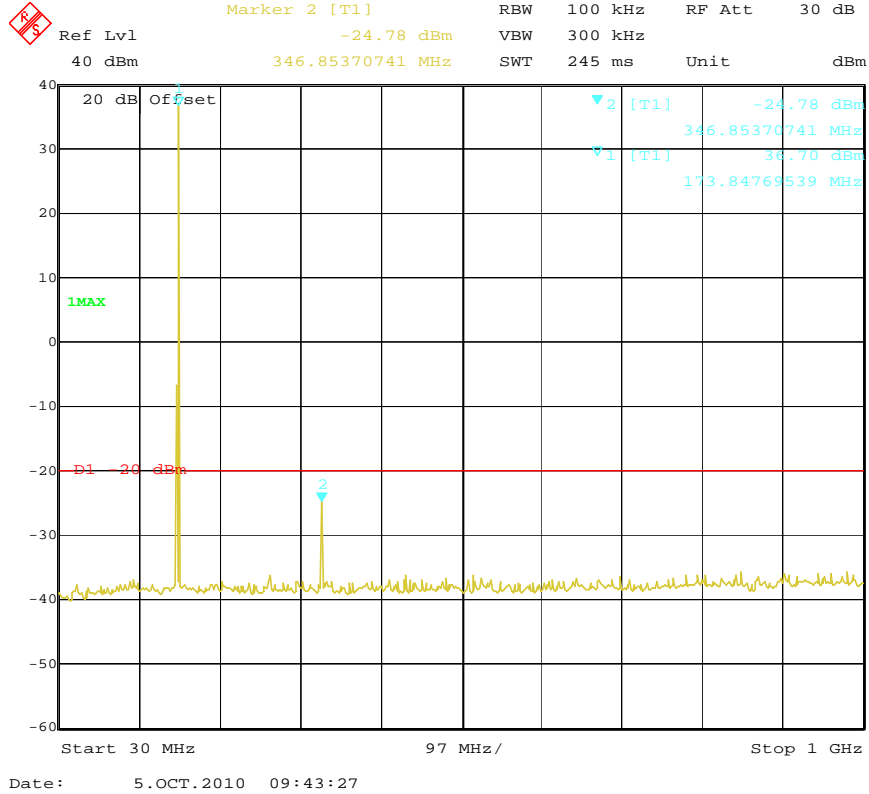

Modulation Type	Channel SpARATION	Test Channel	Test Frequency (MHz)	Maximum Conducted Spurious Emissions Below 1GHz		Maximum Conducted Spurious Emissions Above 1GHz		FCC Limit
				Frequency (MHz)	Datum (dBm)	Frequency (MHz)	Datum (dBm)	
4FSK	12.5KHz	Low	136.1220	271.04	-24.66	2629.26	-26.69	-20dBm
Test Results				Compliance				

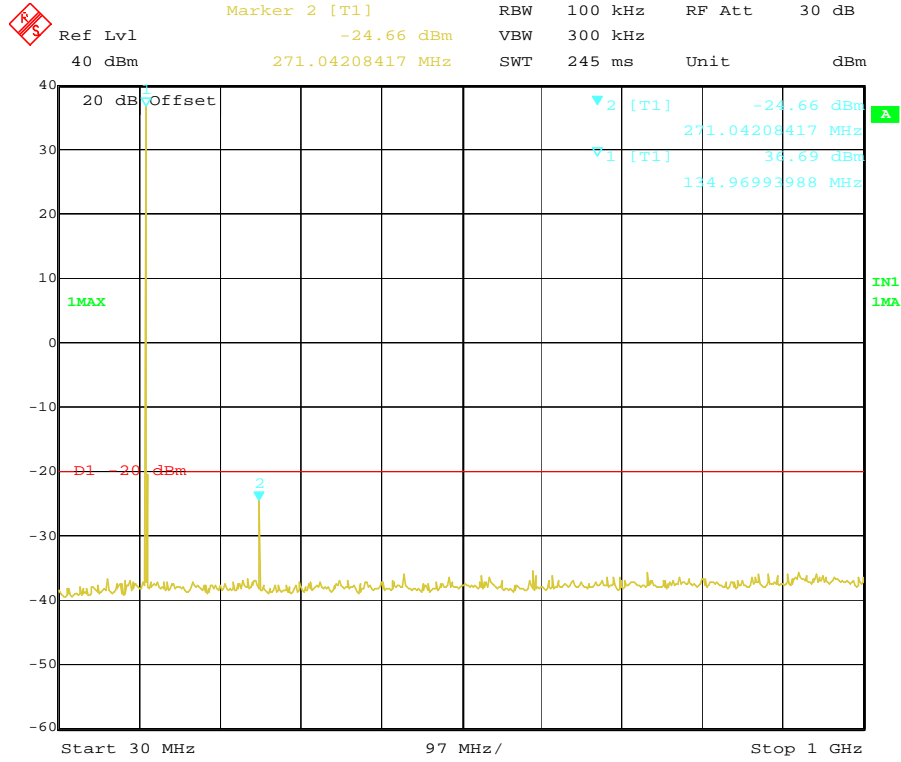

Date: 5.OCT.2010 09:48:19

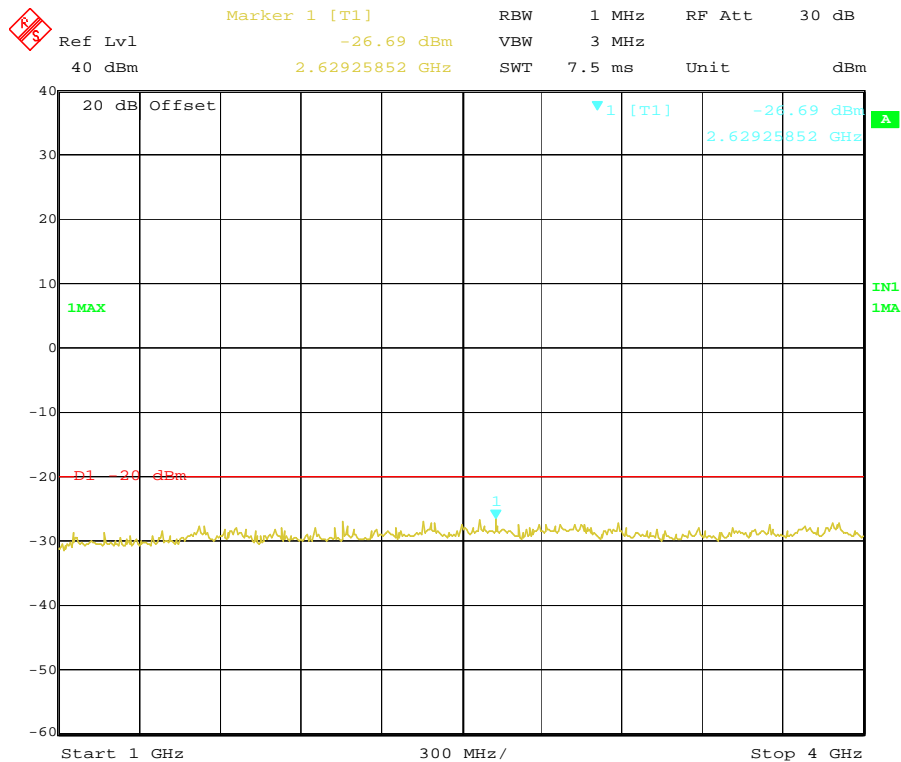

Date: 5.OCT.2010 09:49:16

Modulation Type	Channel SpARATION	Test Channel	Test Frequency (MHz)	Maximum Conducted Spurious Emissions Below 1GHz		Maximum Conducted Spurious Emissions Above 1GHz		FCC Limit
				Frequency (MHz)	Datum (dBm)	Frequency (MHz)	Datum (dBm)	
4FSK	12.5KHz	Middle	152.1220	304.09	-23.88	2521.04	-27.45	-20dBm
Test Results				Compliance				

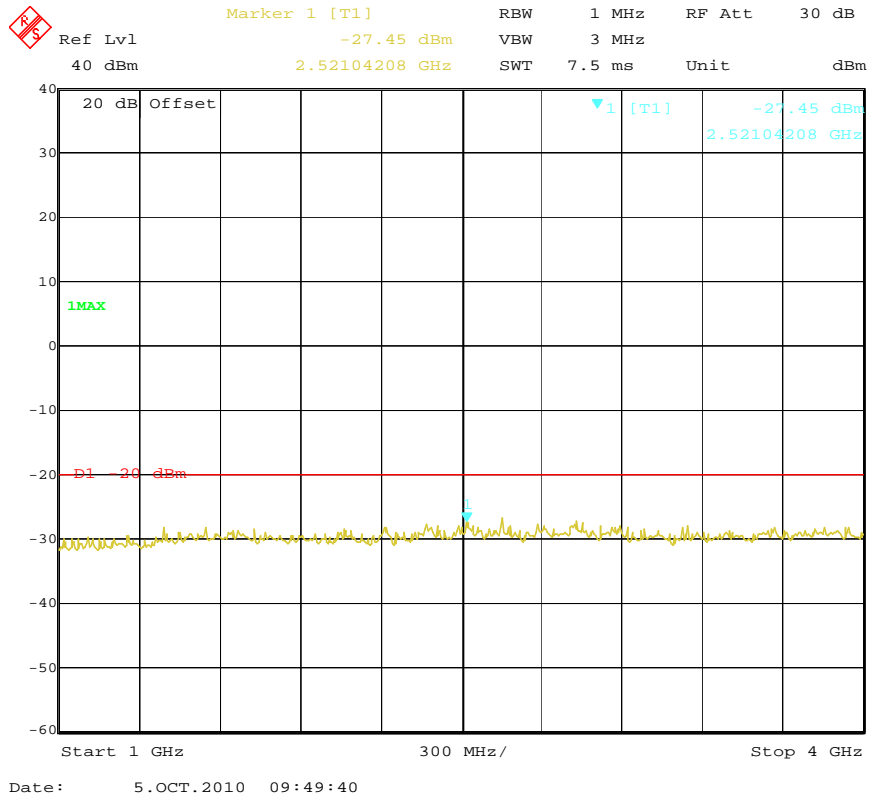
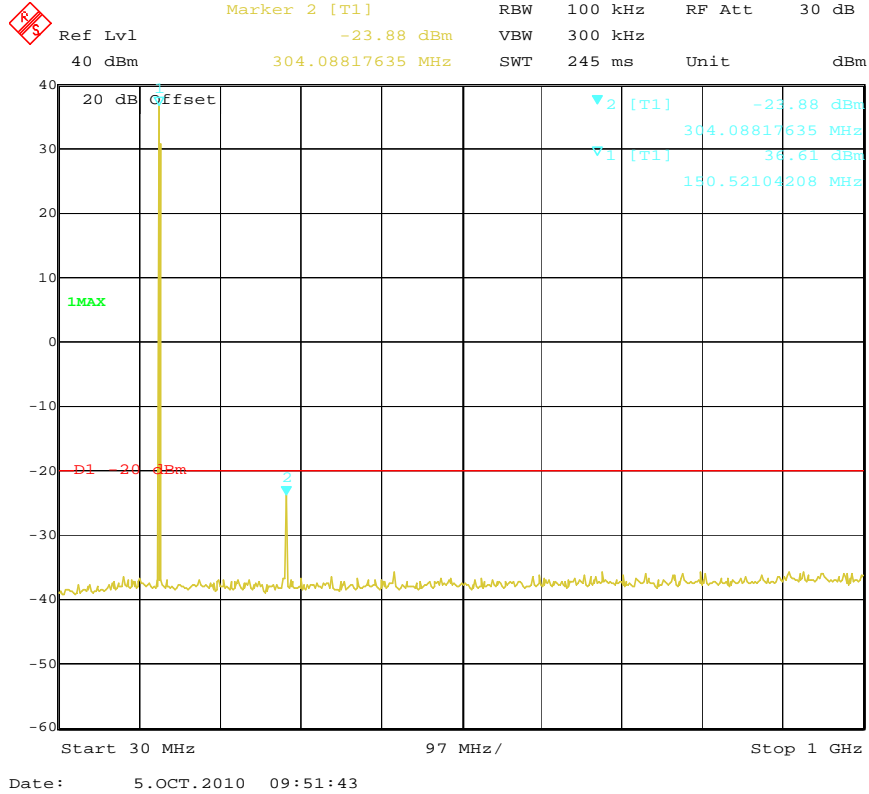

Modulation Type	Channel Separation	Test Channel	Test Frequency (MHz)	Maximum Conducted Spurious Emissions Below 1GHz		Maximum Conducted Spurious Emissions Above 1GHz		FCC Limit
				Frequency (MHz)	Datum (dBm)	Frequency (MHz)	Datum (dBm)	
4FSK	12.5KHz	High	173.9220	346.85	-23.55	3765.53	-27.54	-20dBm
Test Results				Compliance				

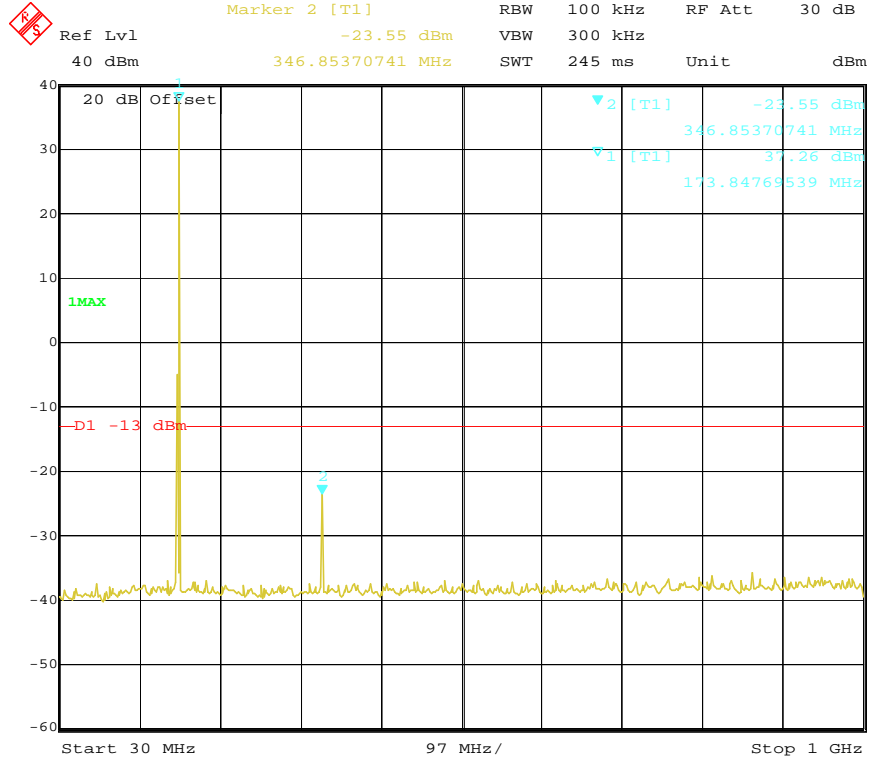

Date: 17.OCT.2010 22:17:00

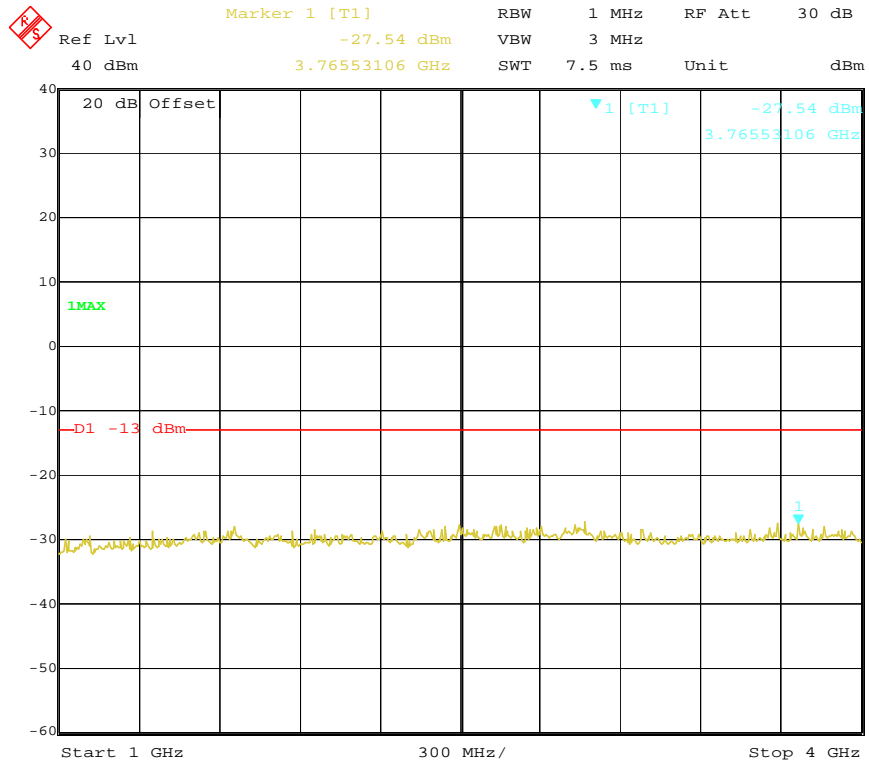

Date: 17.OCT.2010 22:17:24

For Rated Low Power (1Watt)

Modulation Type	Channel Separation	Test Channel	Test Frequency (MHz)	Maximum Conducted Spurious Emissions Below 1GHz		Maximum Conducted Spurious Emissions Above 1GHz		FCC Limit
				Frequency (MHz)	Datum (dBm)	Frequency (MHz)	Datum (dBm)	
FM	25KHz	Low	136.1220	271.04	-34.33	2971.94	-27.78	-13dBm
Test Results				Compliance				

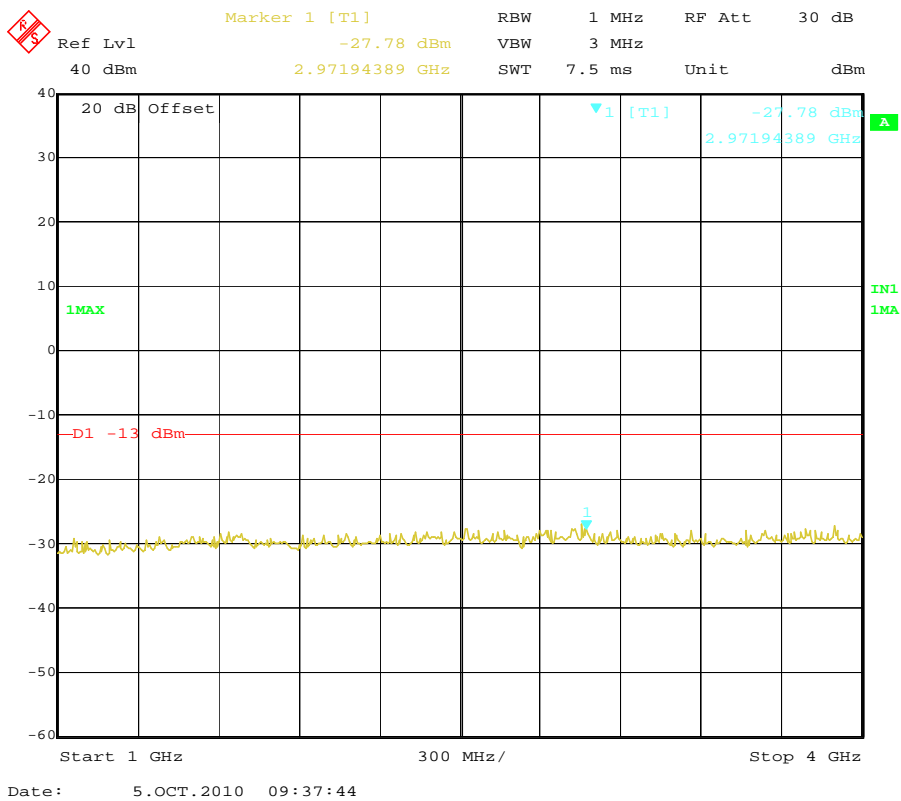
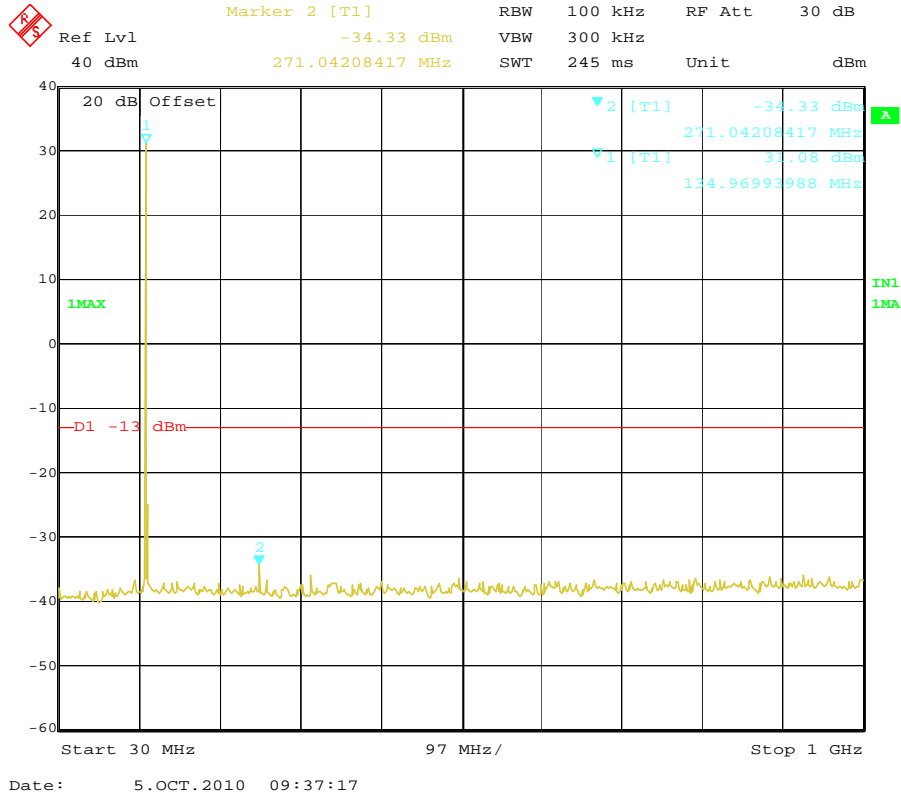

Modulation Type	Channel SpARATION	Test Channel	Test Frequency (MHz)	Maximum Conducted Spurious Emissions Below 1GHz		Maximum Conducted Spurious Emissions Above 1GHz		FCC Limit
				Frequency (MHz)	Datum (dBm)	Frequency (MHz)	Datum (dBm)	
FM	25KHz	Middle	152.1220	304.09	-33.38	2923.85	-26.86	-13dBm
Test Results				Compliance				

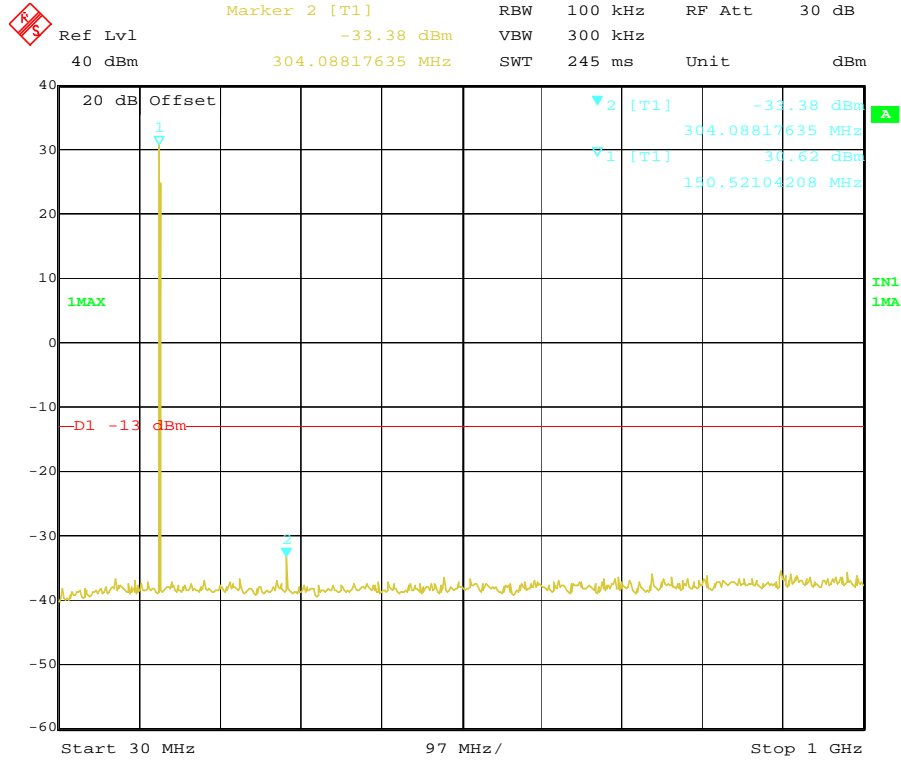

Date: 5.OCT.2010 09:36:50

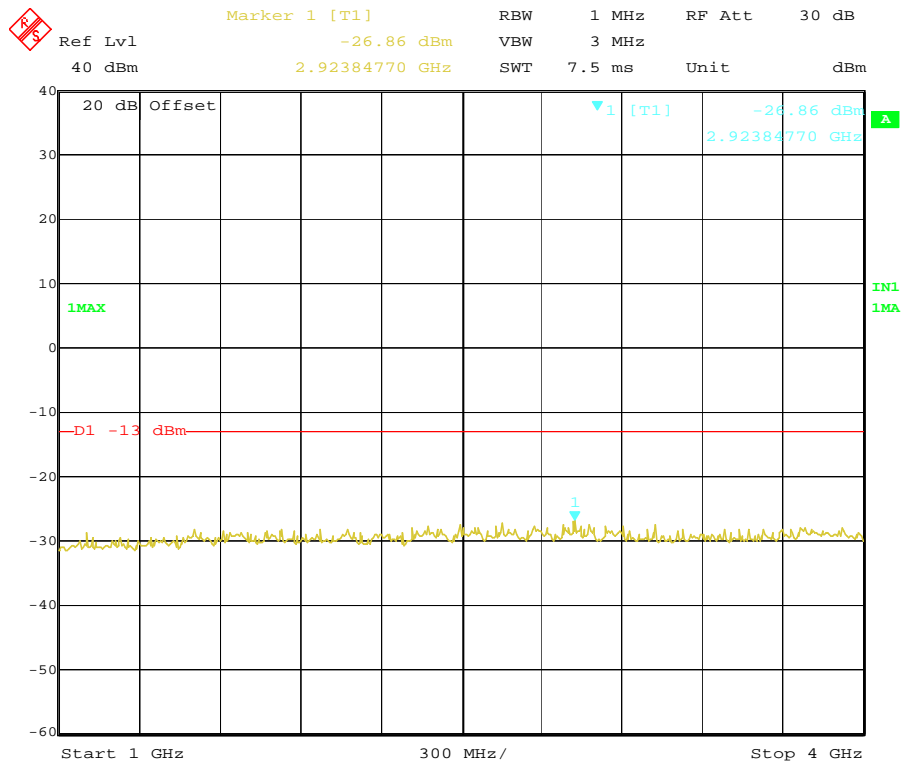

Date: 5.OCT.2010 09:36:17

Modulation Type	Channel SpARATION	Test Channel	Test Frequency (MHz)	Maximum Conducted Spurious Emissions Below 1GHz		Maximum Conducted Spurious Emissions Above 1GHz		FCC Limit
				Frequency (MHz)	Datum (dBm)	Frequency (MHz)	Datum (dBm)	
FM	25KHz	High	173.9220	346.85	-33.70	3032.06	-27.19	-13dBm
Test Results				Compliance				

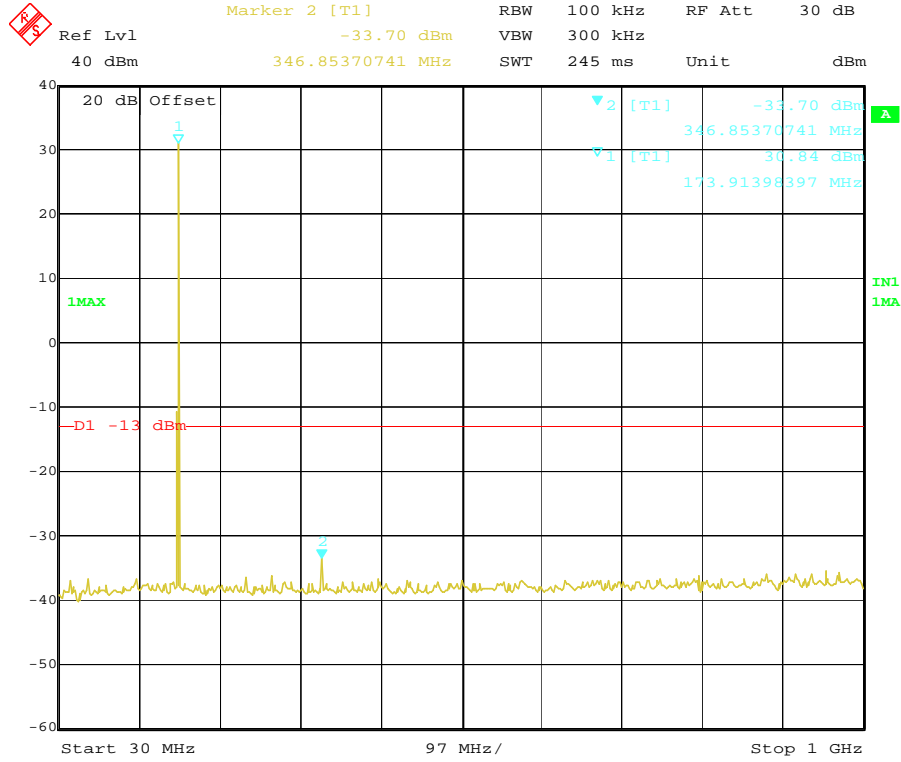

Date: 5.OCT.2010 09:35:07

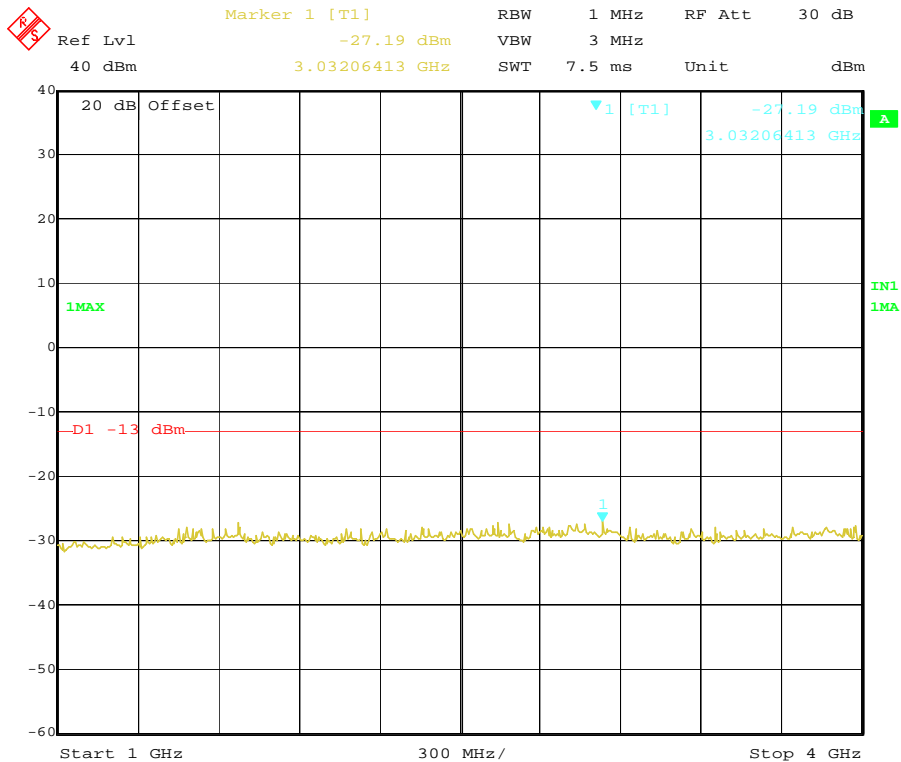

Date: 5.OCT.2010 09:35:39

Modulation Type	Channel Separation	Test Channel	Test Frequency (MHz)	Maximum Conducted Spurious Emissions Below 1GHz		Maximum Conducted Spurious Emissions Above 1GHz		FCC Limit
				Frequency (MHz)	Datum (dBm)	Frequency (MHz)	Datum (dBm)	
FM	12.5KHz	Low	136.1220	271.04	-34.25	2527.05	-26.99	-20dBm
Test Results				Compliance				

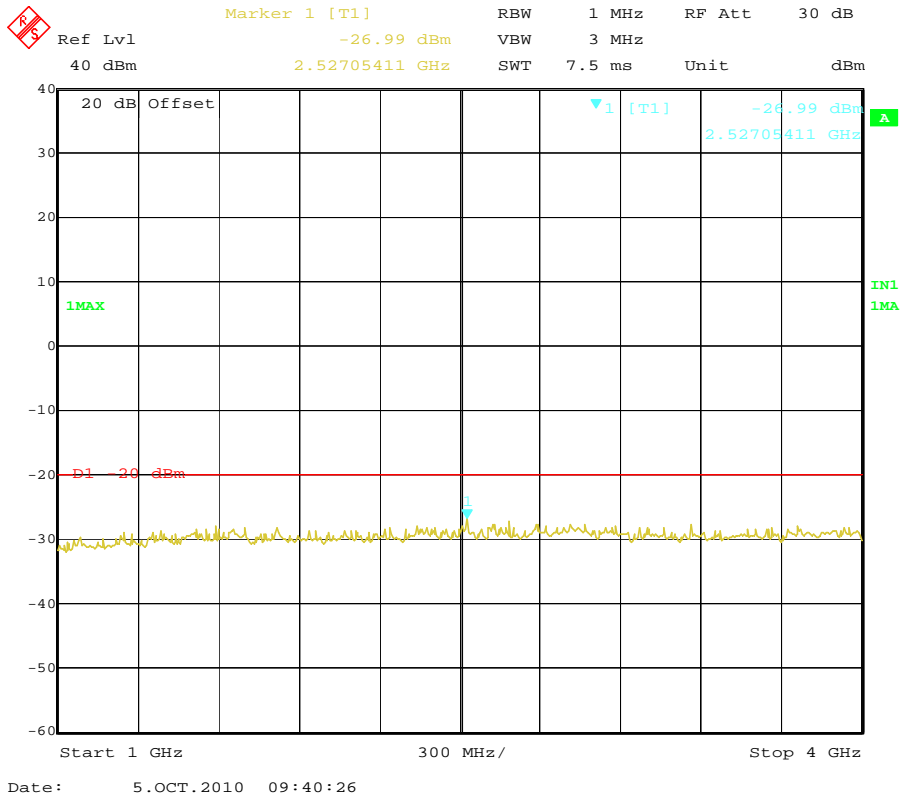
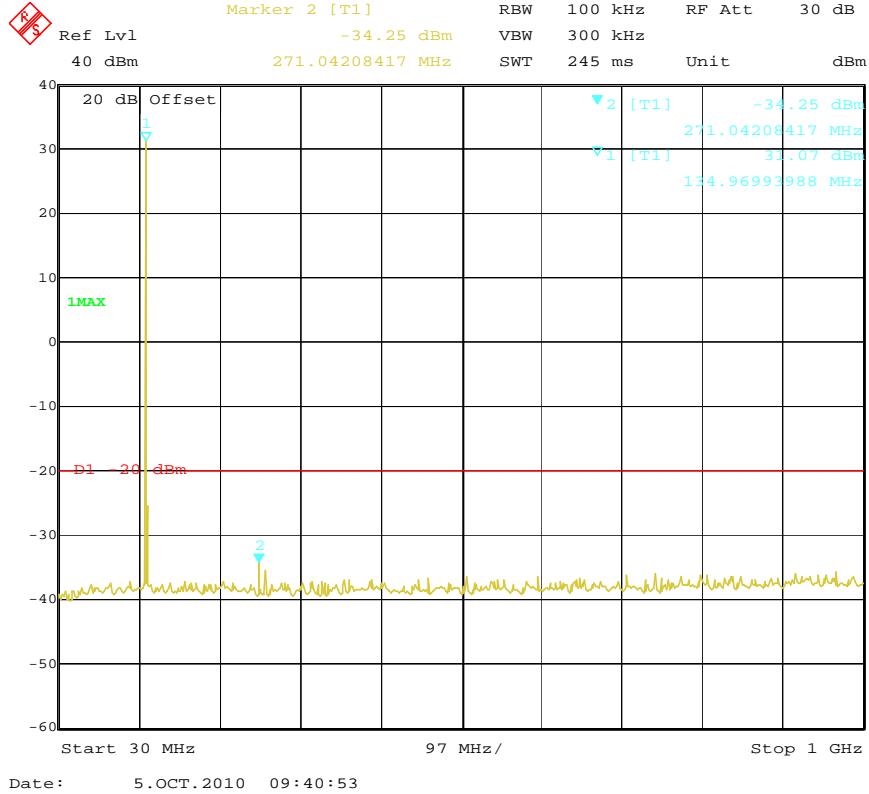

Modulation Type	Channel SpARATION	Test Channel	Test Frequency (MHz)	Maximum Conducted Spurious Emissions Below 1GHz		Maximum Conducted Spurious Emissions Above 1GHz		FCC Limit
				Frequency (MHz)	Datum (dBm)	Frequency (MHz)	Datum (dBm)	
FM	12.5KHz	Middle	152.1220	304.09	-32.75	2196.39	-26.37	-20dBm
Test Results				Compliance				

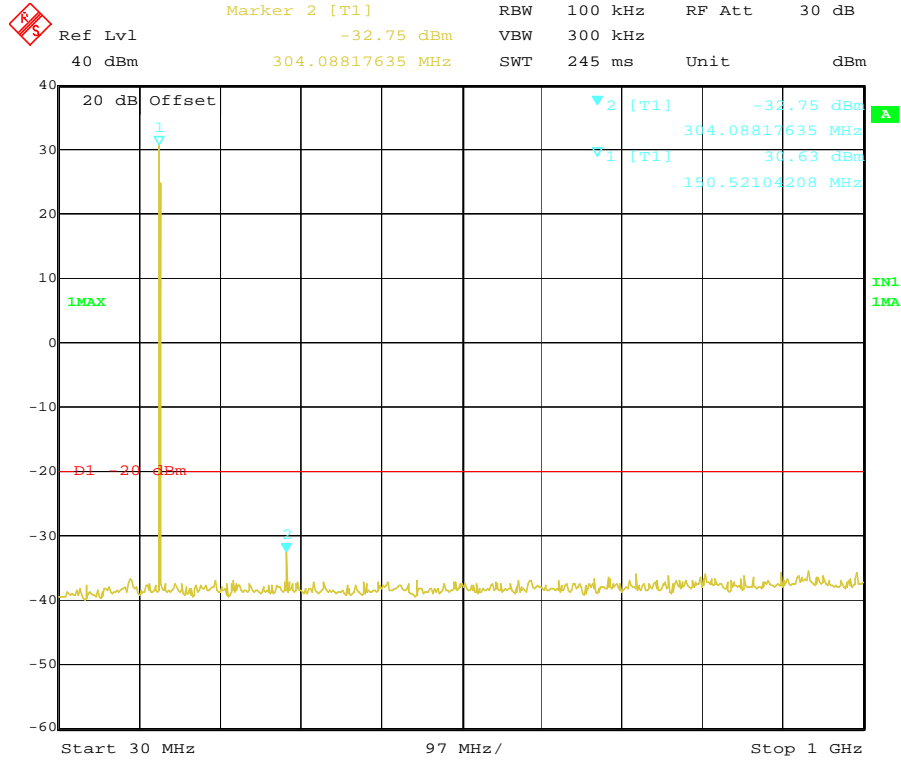

Date: 5.OCT.2010 09:39:16

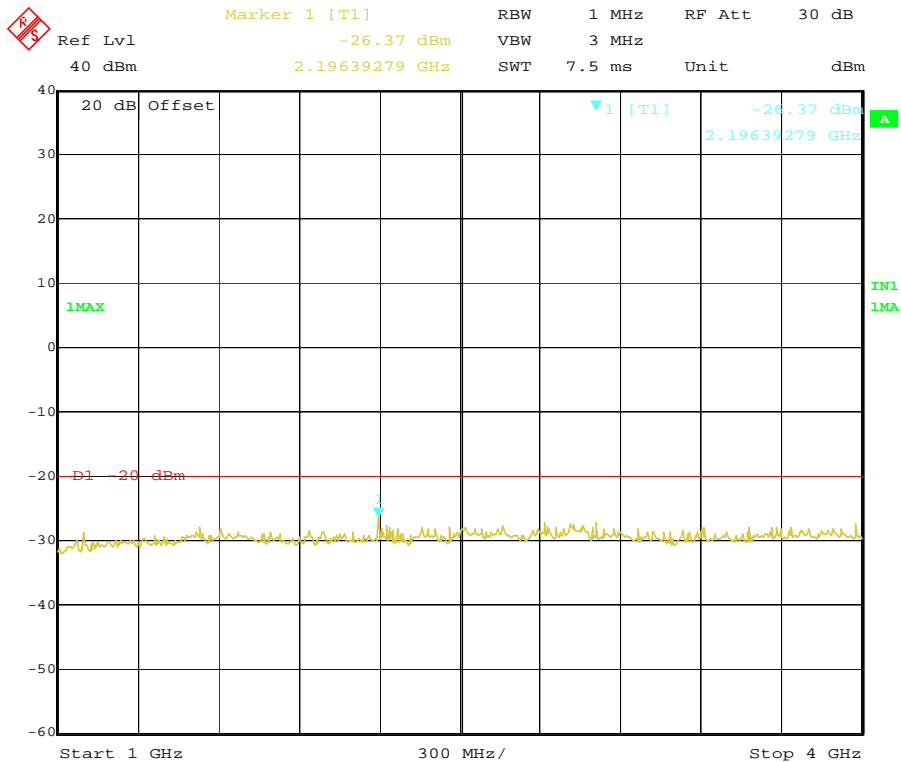

Date: 5.OCT.2010 09:39:54

Modulation Type	Channel SpARATION	Test Channel	Test Frequency (MHz)	Maximum Conducted Spurious Emissions Below 1GHz		Maximum Conducted Spurious Emissions Above 1GHz		FCC Limit
				Frequency (MHz)	Datum (dBm)	Frequency (MHz)	Datum (dBm)	
FM	12.5KHz	High	173.9220	346.85	-33.67	3092.18	-27.72	-20dBm
Test Results				Compliance				

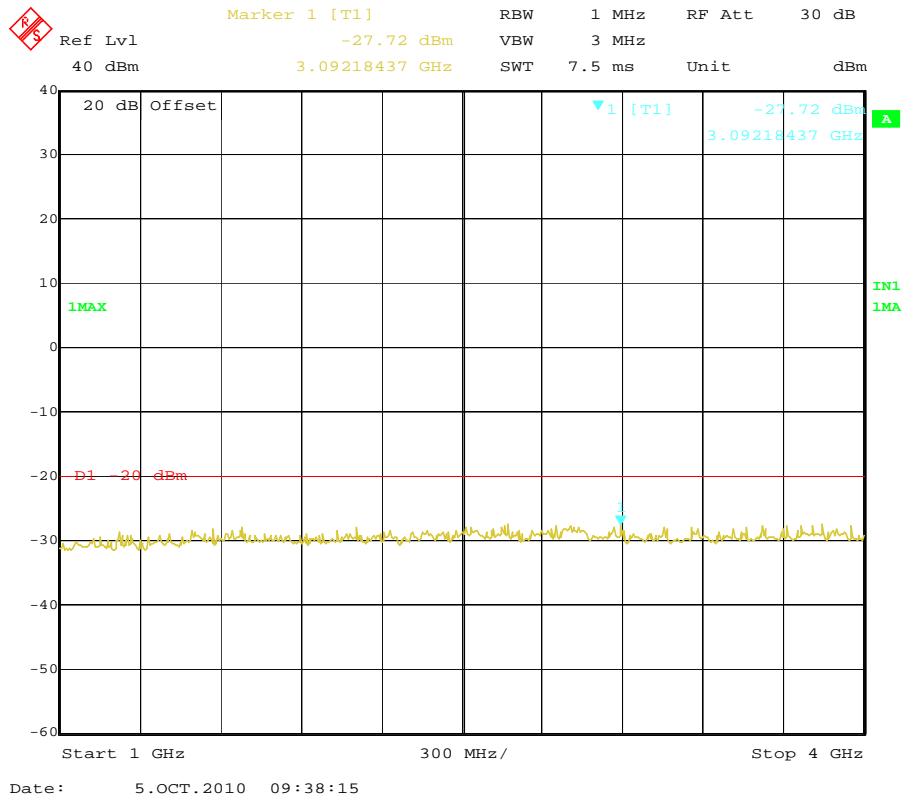
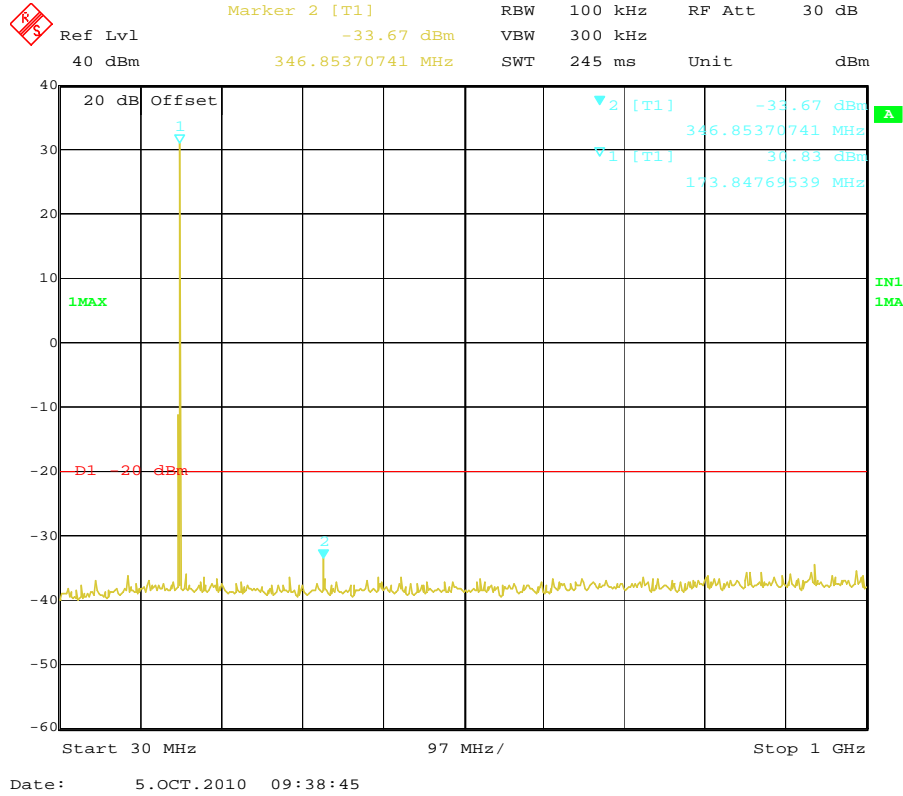

Modulation Type	Channel Separation	Test Channel	Test Frequency (MHz)	Maximum Conducted Spurious Emissions Below 1GHz		Maximum Conducted Spurious Emissions Above 1GHz		FCC Limit
				Frequency (MHz)	Datum (dBm)	Frequency (MHz)	Datum (dBm)	
4FSK	12.5KHz	Low	136.1220	271.04	-33.90	2941.88	-27.64	-20dBm
Test Results				Compliance				

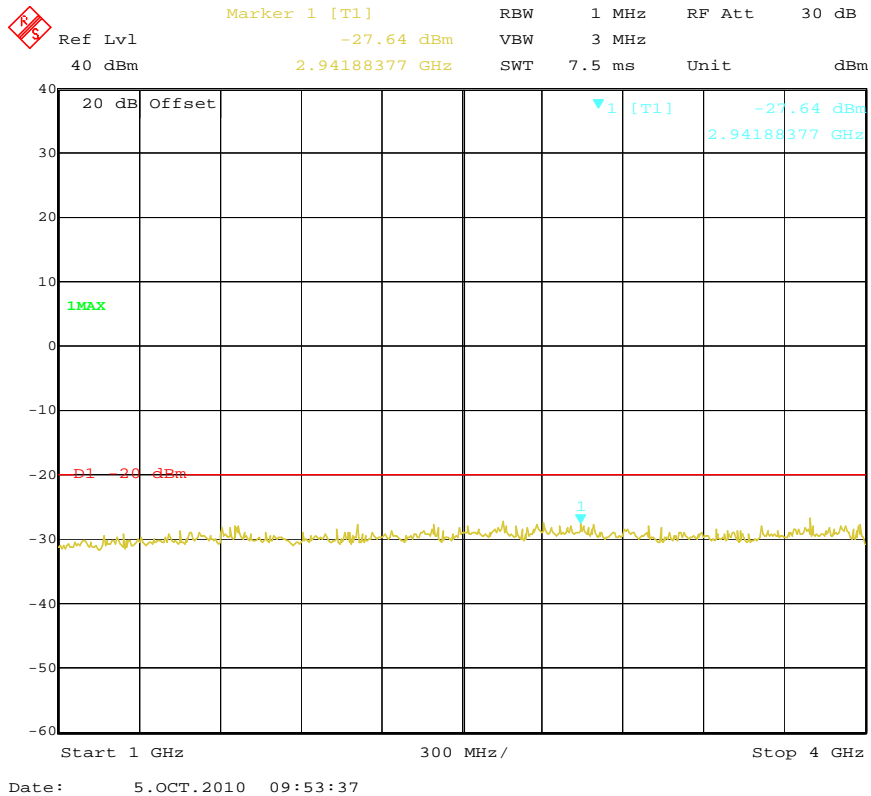
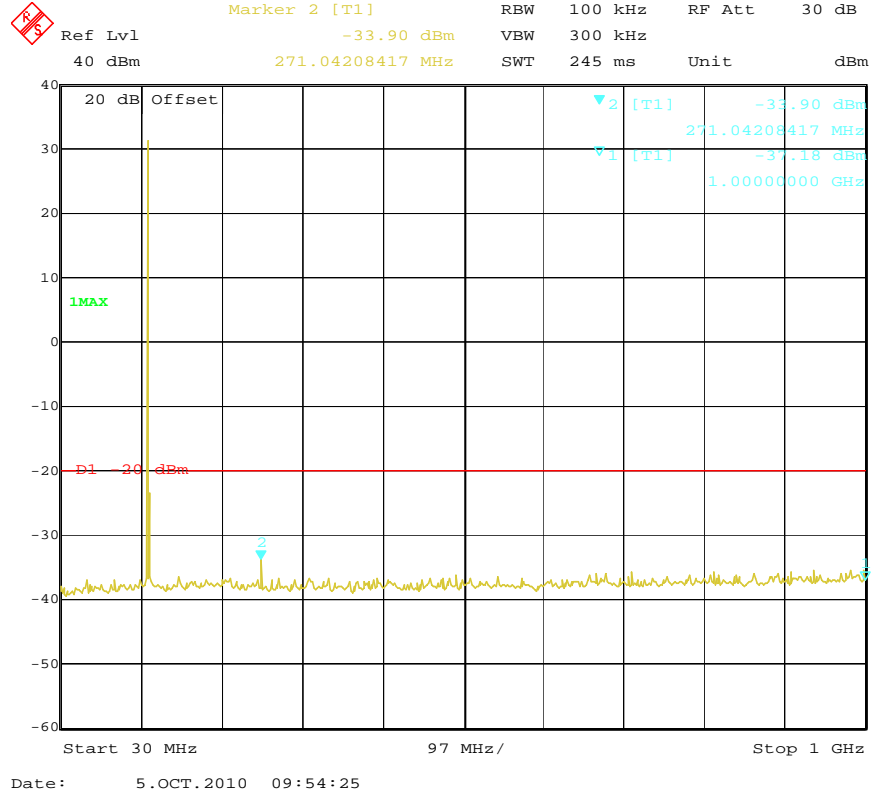

Modulation Type	Channel SpARATION	Test Channel	Test Frequency (MHz)	Maximum Conducted Spurious Emissions Below 1GHz		Maximum Conducted Spurious Emissions Above 1GHz		FCC Limit
				Frequency (MHz)	Datum (dBm)	Frequency (MHz)	Datum (dBm)	
4FSK	12.5KHz	Middle	152.1220	304.09	-33.38	3458.92	-27.29	-20dBm
Test Results				Compliance				

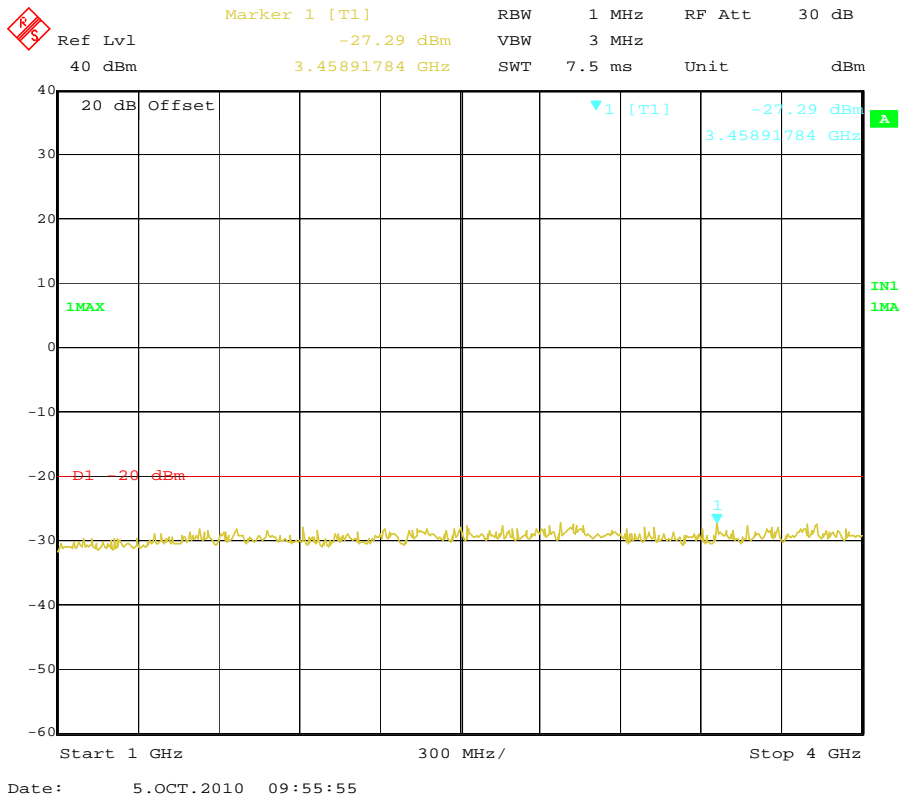
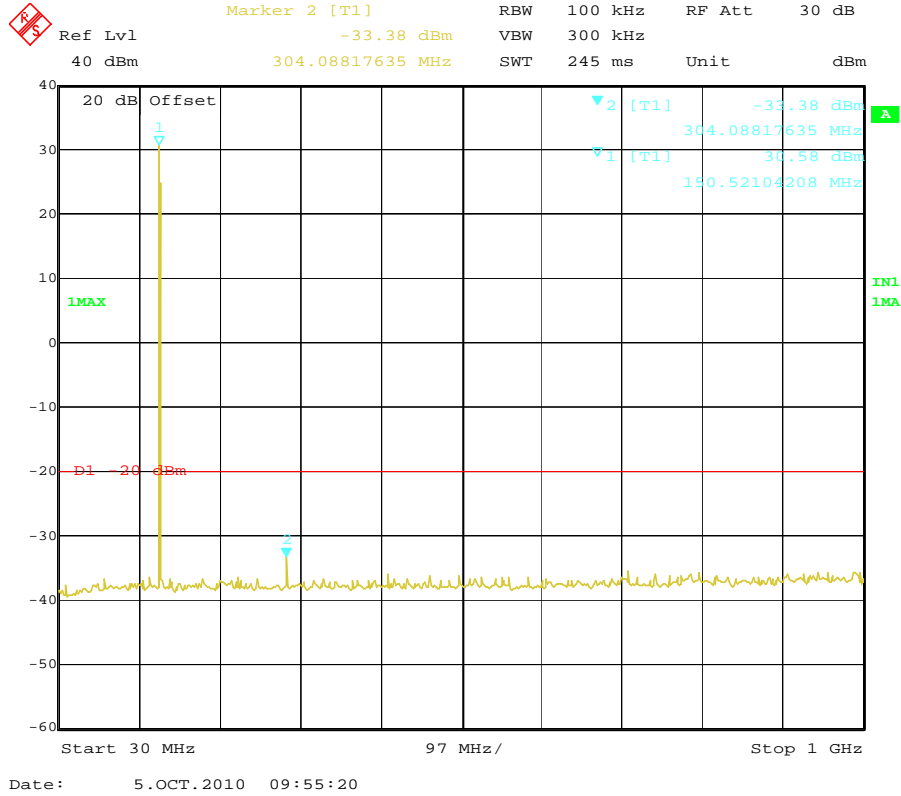

Modulation Type	Channel Separation	Test Channel	Test Frequency (MHz)	Maximum Conducted Spurious Emissions Below 1GHz		Maximum Conducted Spurious Emissions Above 1GHz		FCC Limit
				Frequency (MHz)	Datum (dBm)	Frequency (MHz)	Datum (dBm)	
4FSK	12.5KHz	High	173.9220	346.85	-34.37	2911.82	-26.72	-20dBm
Test Results				Compliance				

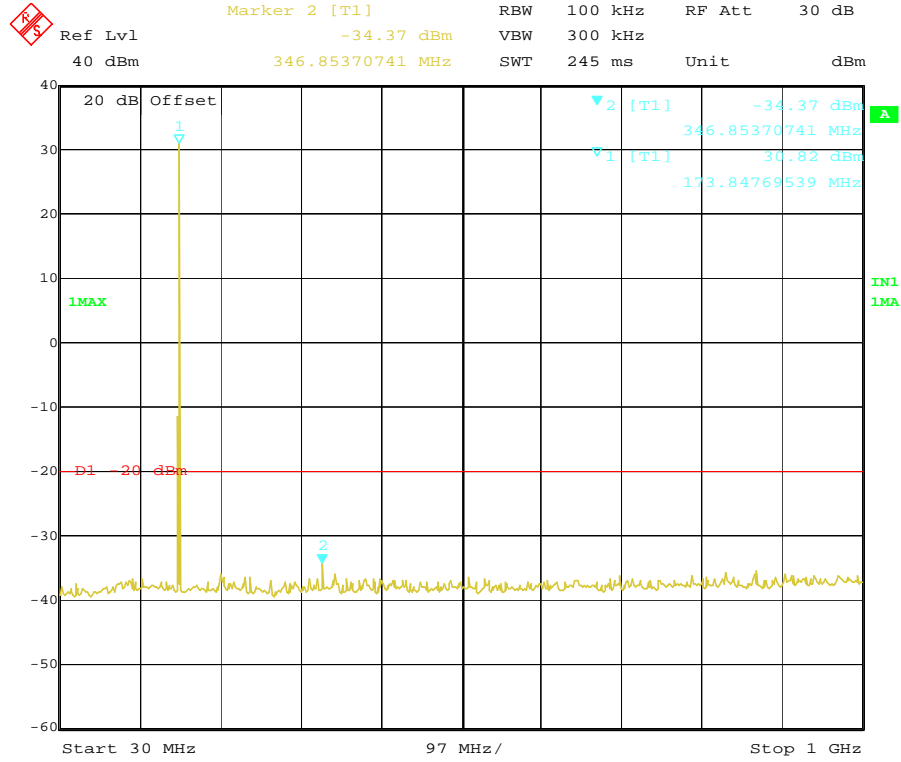

Date: 5.OCT.2010 09:57:14

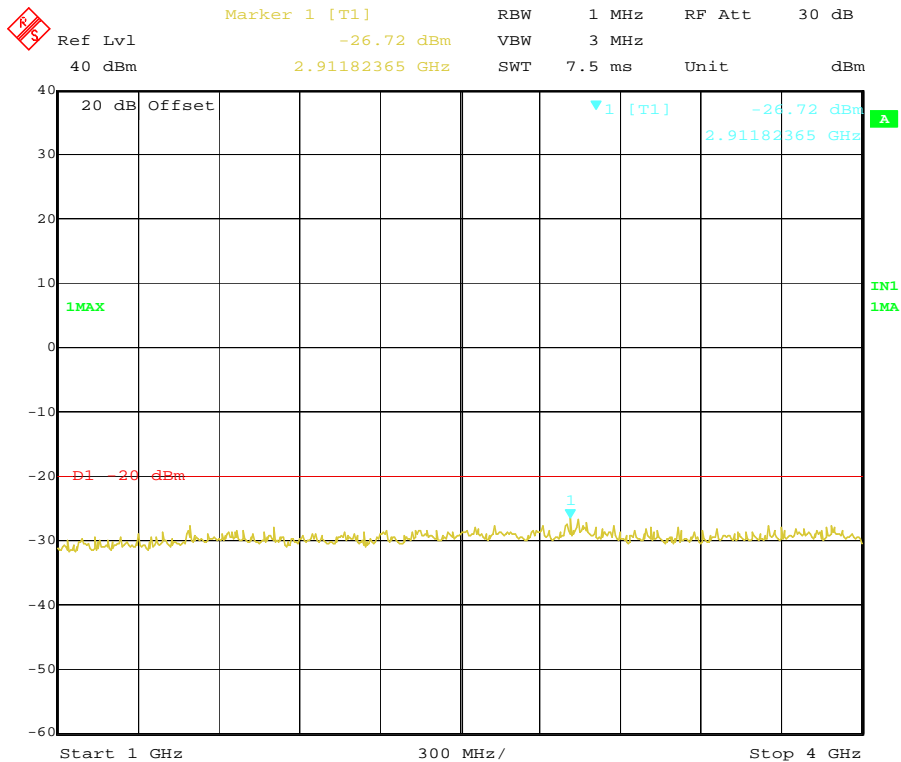

Date: 5.OCT.2010 09:56:37

4.5. Modulation Characteristics

TEST APPLICABLE

According to CFR47 section 2.1047(a), for Voice Modulation Communication Equipment, the frequency response of the audio modulation circuit over a range of 100 to 5000Hz shall be measured.

TEST PROCEDURE

Modulation Limit

- 1 Configure the EUT as shown in figure 1, adjust the audio input for 60% of rated system deviation at 1 KHz using this level as a reference (0dB) and vary the input level from -20 to +20dB. Record the frequency deviation obtained as a function of the input level.
- 2 Repeat step 1 with input frequency changing to 300, 1004, 1500 and 2500Hz in sequence.

Audio Frequency Response

- 1 Configure the EUT as shown in figure 1.
- 2 Adjust the audio input for 20% of rated system deviation at 1 KHz using this level as a reference (0dB).
- 3 Vary the Audio frequency from 100 Hz to 3 KHz and record the frequency deviation.
- 4 Audio Frequency Response = $20 \log_{10} (\text{Deviation of test frequency} / \text{Deviation of 1 KHz reference})$.

TEST CONFIGURATION

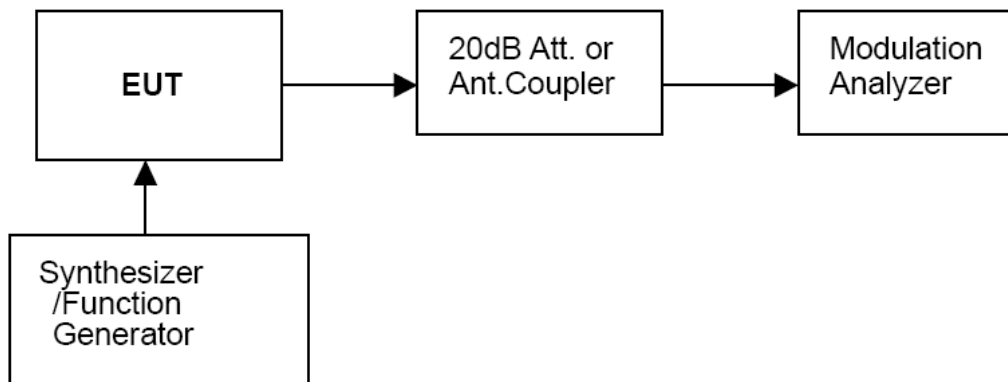

TEST RESULTS

Modulation Type: FM

25 KHz Channel Separation

Modulation Level(dB)	Peak Freq. Deviation At 300 Hz(KHz)	Peak Freq. Deviation At 1004 Hz(KHz)	Peak Freq. Deviation At 1500 Hz(KHz)	Peak Freq. Deviation At 2500 Hz(KHz)
-20	0.12	0.39	0.53	0.88
-15	0.17	0.55	0.79	1.29
-10	0.28	0.97	1.41	2.31
-5	0.44	1.70	2.49	4.04
0	0.77	3.00	4.35	4.31
+5	1.35	4.41	4.38	4.30
+10	2.37	4.40	4.38	4.30
+15	4.18	4.38	4.38	4.30
+20	4.41	4.38	4.38	4.30

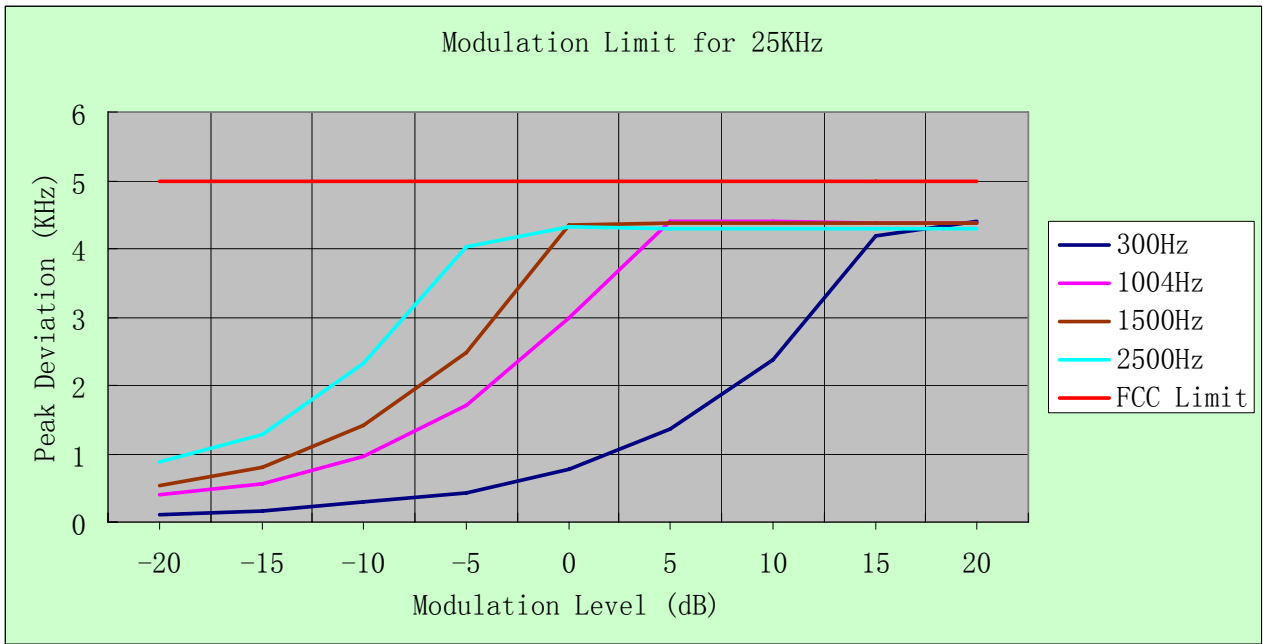

12.5 KHz Channel Separation

Modulation Level(dB)	Peak Freq. Deviation At 300 Hz(KHz)	Peak Freq. Deviation At 1004 H(KHz)	Peak Freq. Deviation At 1500 Hz(KHz)	Peak Freq. Deviation At 2500 Hz(KHz)
-20	0.09	0.21	0.29	0.45
-15	0.11	0.29	0.41	0.69
-10	0.17	0.50	0.72	1.16
-5	0.24	0.86	1.27	2.04
0	0.40	1.50	2.20	2.18
+5	0.69	2.23	2.23	2.19
+10	1.21	2.23	2.23	2.19
+15	2.11	2.23	2.23	2.19
+20	2.16	2.23	2.23	2.19

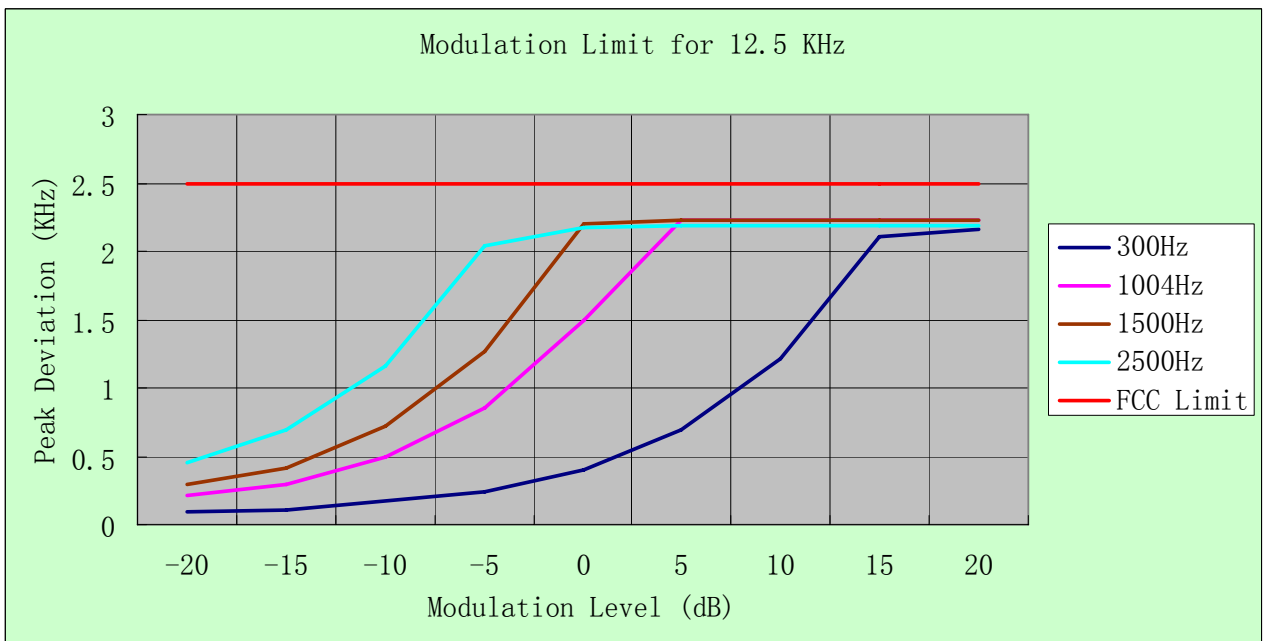

Modulation type: 4FSK

Channel bandwidth: 12.5 kHz

It is not applicable for devices which operate with the digitized voice/data modulation type.

b). Audio Frequency Response:

Rule Part No.: Part 2.1407(a) (b)

Method of Measurement:

The audio frequency response was measured in accordance with TIA/EIA Specification 603 with no exception. A curve or equivalent data showing the frequency response of the audio modulating circuit over a range of 300-3000Hz shall be submitted and Audio Post Limiter Low Pass Filter Response from 3.0 KHz to 50KHz. However, the audio frequency response should test from 100Hz to 5.0 KHz according to FCC Part 90.

Modulation Type: FM

The audio frequency response curve is show below.and

Test Audio Level (1 KHz and 20% maximum deviation) for 25 KHz channel separation is 2.80mv and 2.70mv for 12.5 KHz channel separation.

Note:

- 1 Not applicable to new standard. However, tests are conducted under FCC's recommendation.
- 2 The Audio Frequency Response is identical for 12.5 KHz and 25 KHz channel separation

For 25 KHz

Frequency (KHz)	Frequency Deviation (KHz)	1KHz Reference Deviation (KHz)	Audio Frequency Response (dB)
0.1	0.05	1.02	-26.19
0.2	0.05	1.02	-26.19
0.3	0.28	1.02	-11.23
0.4	0.40	1.02	-8.13
0.5	0.51	1.02	-6.02
0.6	0.61	1.02	-4.47
0.7	0.69	1.02	-3.40
0.8	0.78	1.02	-2.33
0.9	0.89	1.02	-1.18
1.0	1.02	1.02	0.00
1.2	1.15	1.02	1.04
1.4	1.38	1.02	2.63
1.6	1.53	1.02	3.52
1.8	1.78	1.02	4.84
2.0	1.91	1.02	5.45
2.2	2.15	1.02	6.48
2.4	2.26	1.02	6.91
2.6	2.51	1.02	7.82
2.7	2.57	1.02	8.03
2.8	2.64	1.02	8.26
3.0	2.73	1.02	8.55
3.5	0.05	1.02	-26.19
4.0	0.05	1.02	-26.19
4.5	0.05	1.02	-26.19
5.0	0.05	1.02	-26.19



For 12.5 KHz

Frequency (KHz)	Frequency Deviation (KHz)	1KHz Reference Deviation (KHz)	Audio Frequency Response (dB)
0.1	0.04	0.50	-21.94
0.2	0.03	0.50	-24.44
0.3	0.15	0.50	-10.46
0.4	0.22	0.50	-7.13
0.5	0.27	0.50	-5.35
0.6	0.31	0.50	-4.15
0.7	0.35	0.50	-3.10
0.8	0.39	0.50	-2.16
0.9	0.45	0.50	-0.92
1.0	0.50	0.50	0.00
1.2	0.57	0.50	1.14
1.4	0.69	0.50	2.80
1.6	0.76	0.50	3.64
1.8	0.87	0.50	4.82
2.0	0.93	0.50	5.39
2.2	1.05	0.50	6.44
2.4	1.10	0.50	6.85
2.6	1.23	0.50	7.82
2.7	1.24	0.50	7.89
2.8	1.26	0.50	8.03
3.0	1.29	0.50	8.23
3.5	0.04	0.50	-21.94
4.0	0.03	0.50	-24.44
4.5	0.03	0.50	-24.44
5.0	0.03	0.50	-24.44

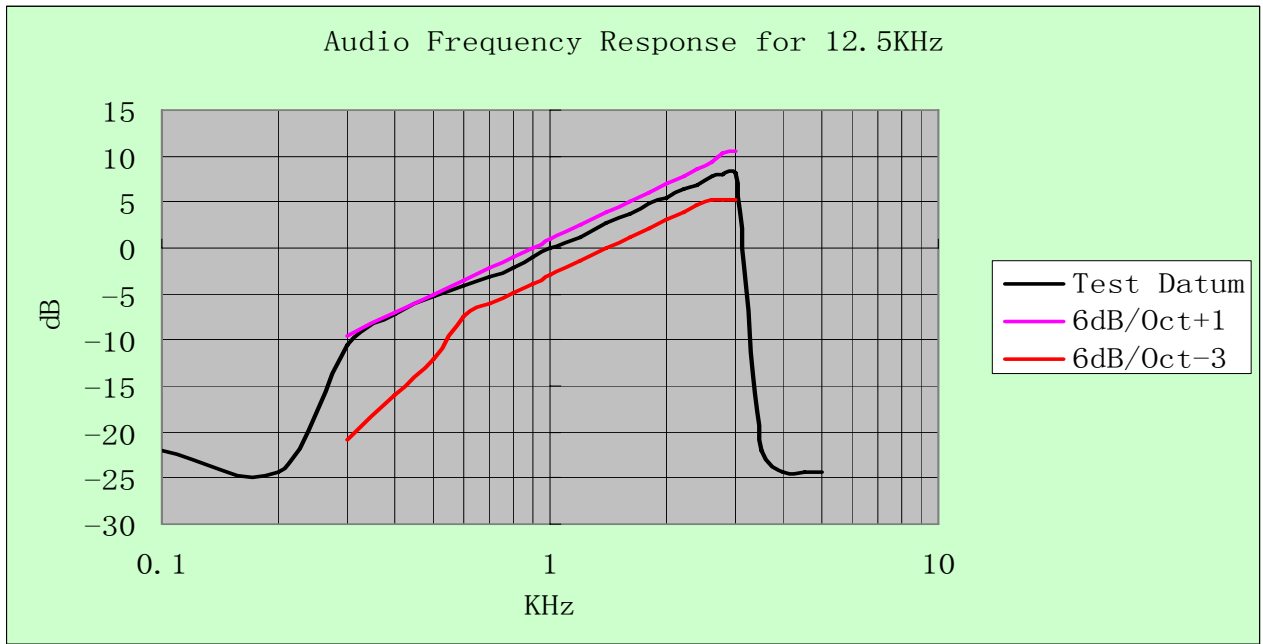

Modulation type: 4FSK

Channel bandwidth: 12.5 kHz

It is not applicable for devices which operate with the digitized voice/data modulation type.

4.6. Frequency Stability Test

TEST APPLICABLE

- 1 According to FCC Part 2 Section 2.1055 (a)(1), the frequency stability shall be measured with variation of ambient temperature from -30°C to +60°C centigrade.
- 2 According to FCC Part 2 Section 2.1055 (a) (2), for battery powered equipment, the frequency stability shall be measured with reducing primary supply voltage to the battery operating end point, which is specified by the manufacture.
- 3 Vary primary supply voltage from 85 to 115 percent of the nominal value for other than hand carried battery equipment.
- 4 According to §90.213, the frequency stability limit is 5.0 ppm for 12.5KHz channel separation and 5 ppm for 25KHz channel separation.

TEST PROCEDURE

The EUT was set in the climate chamber and connected to an external DC power supply. The RF output was directly connected to Spectrum Analyzer ESI 26. The coupling loss of the additional cables was recorded and taken in account for all the measurements. After temperature stabilization (approx. 20 min for each stage), the frequency for the lower, the middle and the highest frequency range was recorded. For Frequency stability Vs. Voltage the EUT was connected to a DC power supply and the voltage was adjusted in the required ranges. The result was recorded.

TEST CONFIGURATION

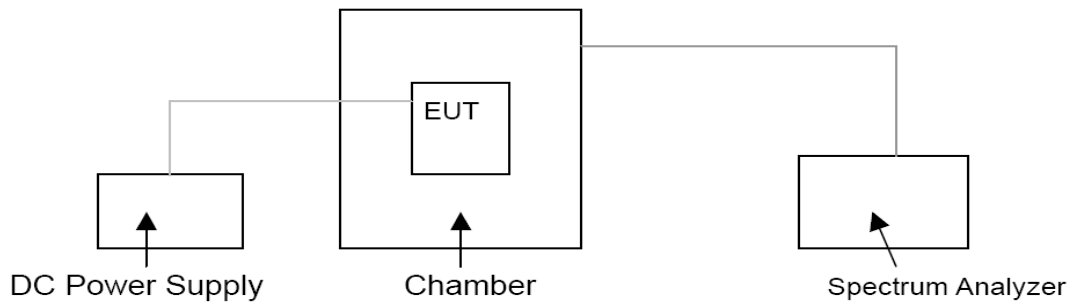

TEST LIMITS

According to 90.213, Transmitters used must have minimum frequency stability as specified in the following table.

Frequency Range (MHz)	Channel Bandwidth (KHz)	Frequency Tolerance (ppm)		
		Fixed and Base Stations	Mobile Stations	
			> 2 W	≤ 2 W
150-174 MHz	6.25	1.0	2.0	2.0
	12.5	2.5	5.0	5.0
	25	5.0	5.0	50.0*
421-512 MHz	6.25	0.5	1.0	1.0
	12.5	1.5	2.5	2.5
	25	2.5	5.0	5.0

- Stations operating in the 154.45 to 154.49 MHz or the 173.2 to 173.4 MHz bands must have a frequency stability of 5 ppm.
- Paging transmitters operating on paging-only frequencies must operate with frequency stability of 5 ppm in the 150-174 MHz band and 2.5 ppm in the 421-512 MHz band.

TEST RESULTS

Modulation Type	Channel Separation	Test conditions		Frequency error (ppm)		
		Voltage(V)	Temp(°C)	Low Channel	Middle Channel	High Channel
Analog/FM	25KHz	7.40	-30	-1.88	-1.80	-1.71
			-20	-1.51	-1.57	-1.49
			-10	-1.51	-1.38	-1.49
			0	-1.32	-1.23	-1.25
			10	-1.05	-0.99	-0.94
			20	-0.74	-0.87	-0.82
			30	-0.74	-0.79	-0.69
			40	-0.93	-0.90	-0.80
			50	-1.22	-1.15	-0.95
		6.67 (End point)	20	-0.88	-0.79	-0.78
		6.29 (85% Rated)	20	-0.88	-0.79	-0.69
		8.51 (115% Rated)	20	-0.88	-0.79	-0.81
Limit			5.0 ppm			
Conclusion			Complies			

Modulation Type	Channel Separation	Test conditions		Frequency error (ppm)		
		Voltage(V)	Temp(°C)	Low Channel	Middle Channel	High Channel
Analog/FM	12.5KHz	7.40	-30	-1.91	-1.80	-1.71
			-20	-1.55	-1.52	-1.56
			-10	-1.51	-1.38	-1.41
			0	-1.35	-1.29	-1.25
			10	-1.00	-1.03	-0.99
			20	-0.94	-0.92	-0.82
			30	-0.88	-0.92	-0.69
			40	-1.05	-0.92	-0.69
			50	-1.22	-1.15	-0.95
		6.67 (End point)	20	-0.88	-0.79	-0.69
		6.29 (85% Rated)	20	-0.88	-0.76	-0.69
		8.51 (115% Rated)	20	-0.88	-0.79	-0.81
Limit			5.0 ppm			
Conclusion			Complies			

Modulation Type	Channel Separation	Test conditions		Frequency error (ppm)		
		Voltage(V)	Temp(°C)	Low Channel	Middle Channel	High Channel
Digital/4FSK	12.5KHz	7.40	-30	-1.98	-1.80	-1.67
			-20	-1.67	-1.55	-1.56
			-10	-1.50	-1.33	-1.34
			0	-1.35	-1.33	-1.20
			10	-1.02	-1.03	-1.01
			20	-0.94	-0.90	-0.82
			30	-0.88	-0.79	-0.81
			40	-1.00	-0.92	-0.96
			50	-1.25	-1.15	-0.96
		6.67 (End point)	20	-0.88	-0.79	-0.89
		6.29 (85% Rated)	20	-0.88	-0.79	-0.89
		8.51 (115% Rated)	20	-0.88	-0.79	-0.89
Limit			5.0 ppm			
Conclusion			Complies			

4.7. Maximum Transmitter Power

TEST APPLICABLE

Per FCC «2.1046 and «90.205: Maximum ERP is dependent upon the station’s antenna HAAT and required service area.

TEST PROCEDURE

Measurements shall be made to establish the radio frequency power delivered by the transmitter the standard output termination. The power output shall be monitored and recorded and no adjustment shall be made to the transmitter after the test has begun, except as noted below:

If the power output is adjustable, measurements shall be made for the highest and lowest power levels.

The EUT connect to the Receiver through 20 dB attenuator.

Measurement with Spectrum Analyzer ESI 26 conducted, external power supply with 7.40 V stabilized supply voltage.

TEST CONFIGURATION

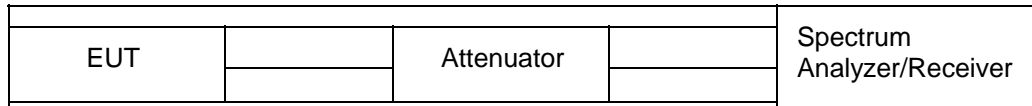

The EUT was directly connected to a RF Communication Test set by a 20 dB attenuator

TEST RESULTS

Modulation Type	Channel Separation	Test Channel	Test Frequency	Maximum Transmitter Power at Rated High Power Level(dBm)	Maximum Transmitter Power at Rated Low Power Level(dBm)
Analog/FM	25KHz	Low Channel	136.1220 MHz	36.78	31.13
		Middle Channel	152.1220 MHz	36.71	30.71
		High Channel	173.9220 MHz	36.81	30.97
	12.5KHz	Low Channel	136.1220 MHz	36.88	31.14
		Middle Channel	152.1220 MHz	36.74	30.69
		High Channel	173.9220 MHz	36.84	30.98
Digital/4FSK	12.5KHz	Low Channel	136.1220 MHz	36.78	31.12
		Middle Channel	152.1220 MHz	36.71	30.69
		High Channel	173.9220 MHz	36.85	31.02
Limit		The limit is dependent upon the station’s antenna HAAT and required service area.			
Test Results		Complicance			

Plots of Maximum Transmitter Power Measurement

Modulation Type	Channel Separation	Freq.(MHz)	Rated Power (Watt)	Measurement (dBm)	FCC Limit	Results
FM	25 KHz	136.1220	5	36.78	Varies	Complicance

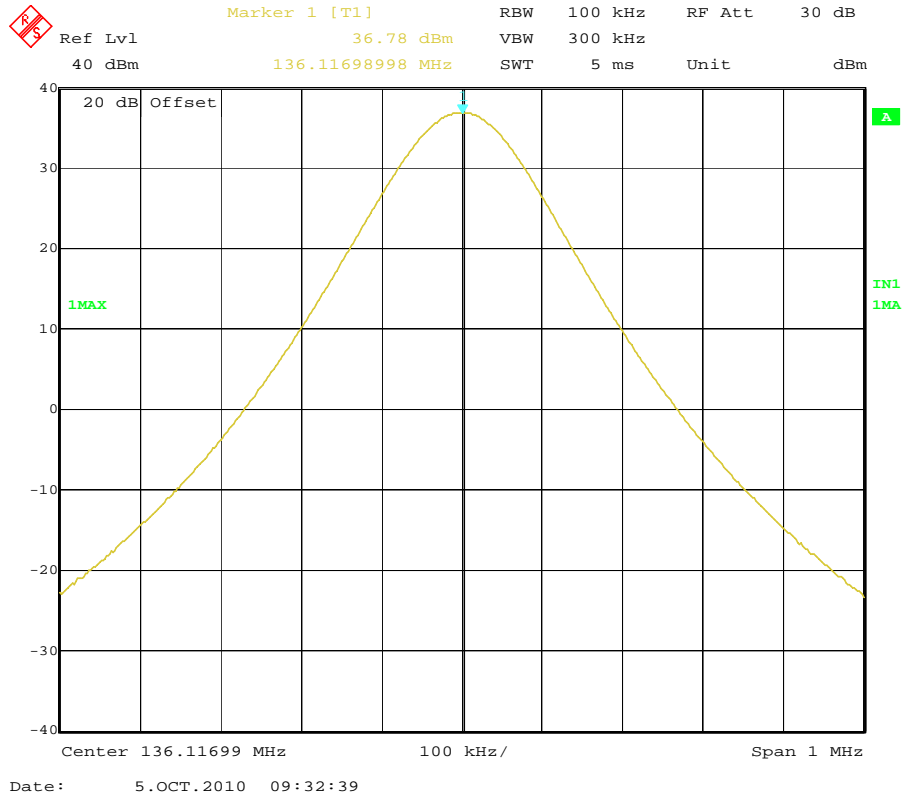

Modulation Type	Channel Separation	Freq.(MHz)	Rated Power (Watt)	Measurement (dBm)	FCC Limit	Results
FM	25 KHz	152.1220	5	36.71	Varies	Complicance

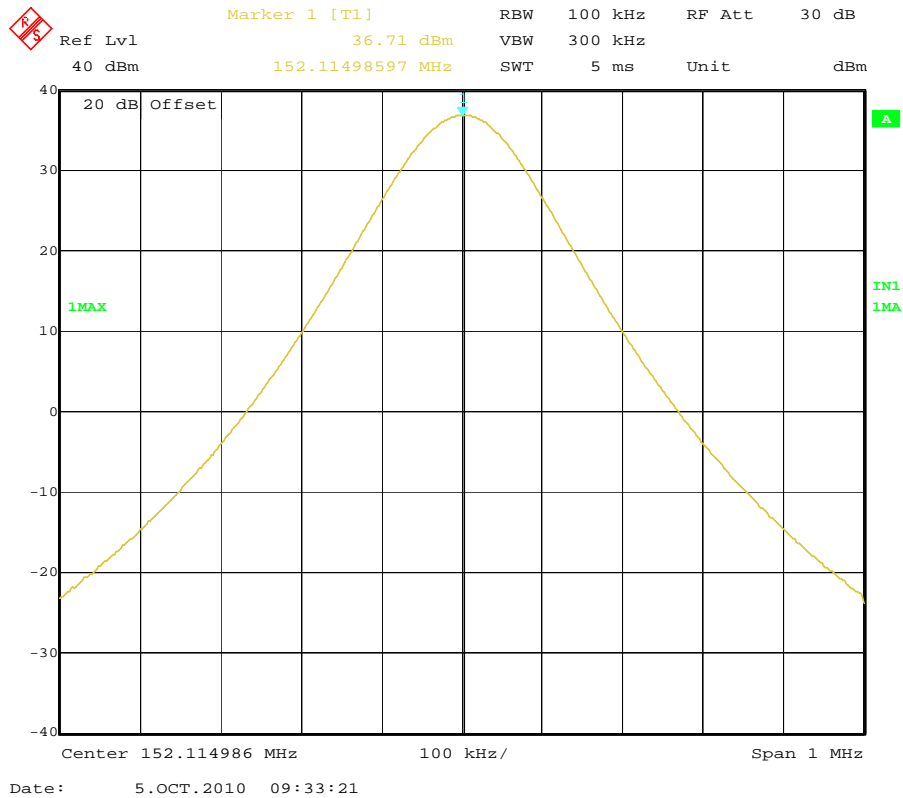

Modulation Type	Channel Separation	Freq.(MHz)	Rated Power (Watt)	Measurement (dBm)	FCC Limit	Results
FM	25 KHz	173.9220	5	36.81	Varies	Complicance

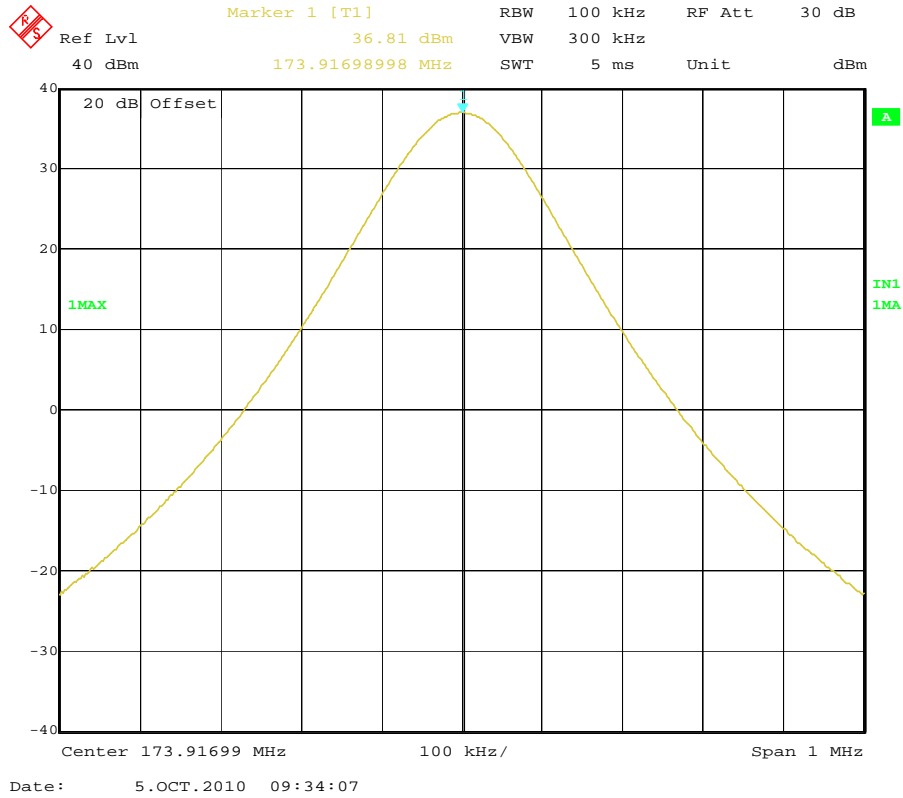

Modulation Type	Channel Separation	Freq.(MHz)	Rated Power (Watt)	Measurement (dBm)	FCC Limit	Results
FM	12.5 KHz	136.1220	5	36.88	Varies	Complicance

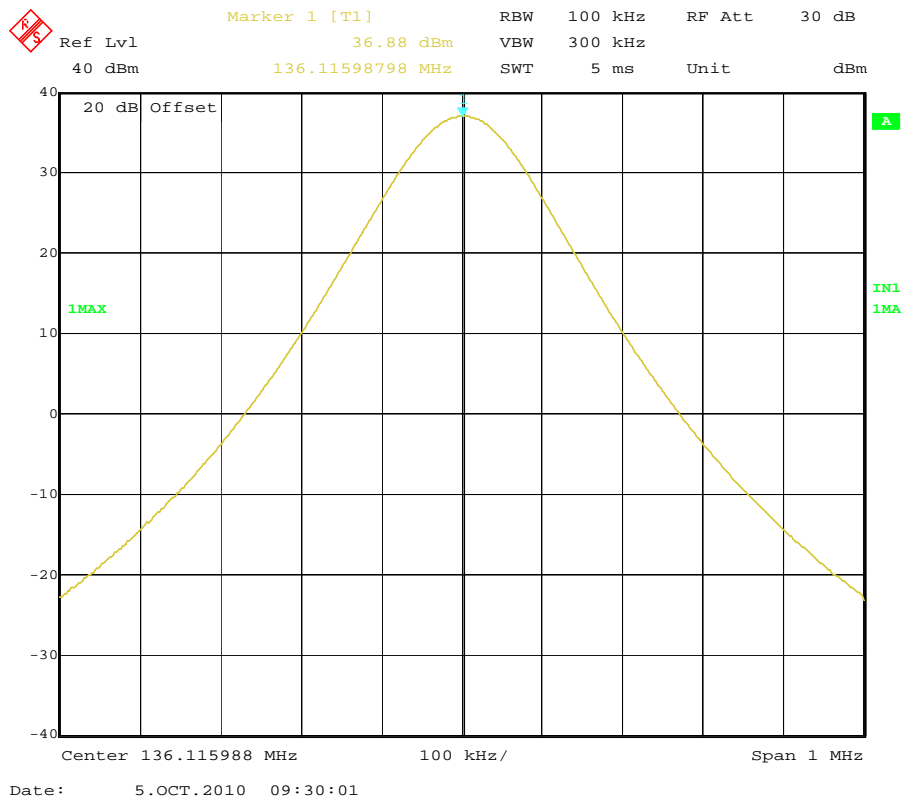

Modulation Type	Channel Separation	Freq.(MHz)	Rated Power (Watt)	Measurement (dBm)	FCC Limit	Results
FM	12.5 KHz	152.1220	5	36.74	Varies	Complicance

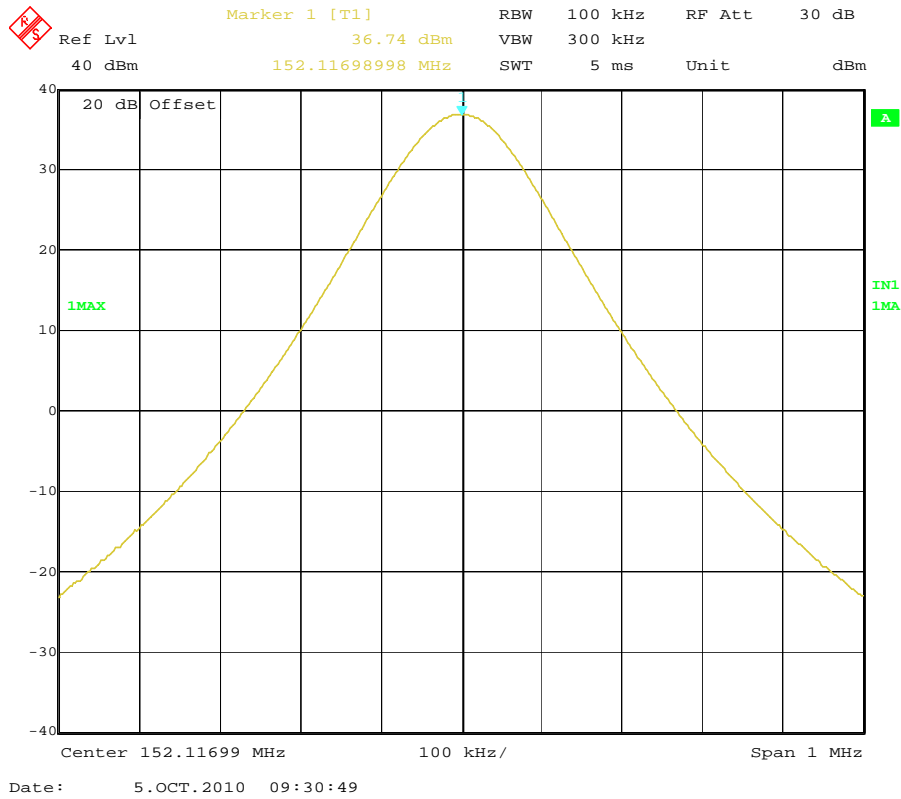

Modulation Type	Channel Separation	Freq.(MHz)	Rated Power (Watt)	Measurement (dBm)	FCC Limit	Results
FM	12.5 KHz	173.9220	5	36.84	Varies	Complicance

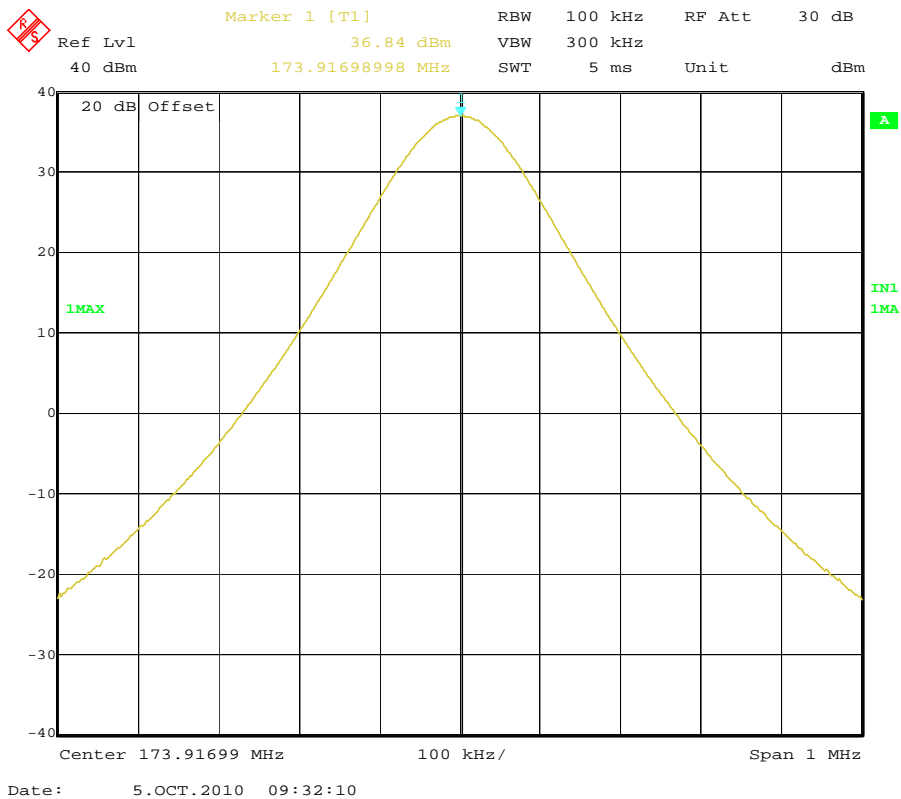

Modulation Type	Channel Separation	Freq.(MHz)	Rated Power (Watt)	Measurement (dBm)	FCC Limit	Results
4FSK	12.5 KHz	136.1220	5	36.78	Varies	Compliance

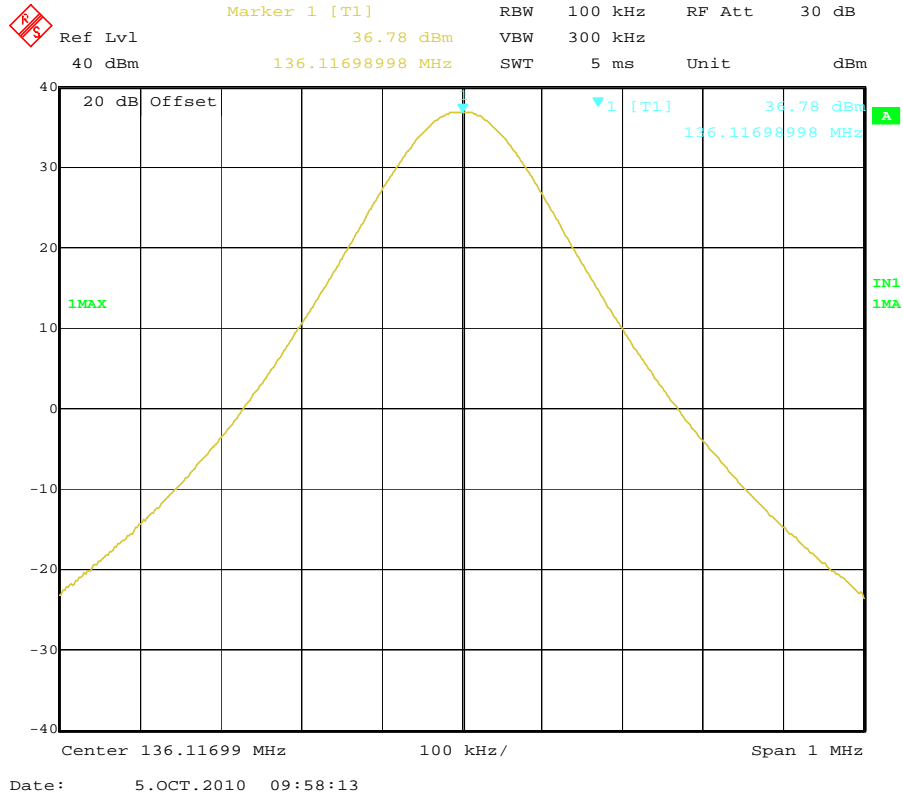

Modulation Type	Channel Separation	Freq.(MHz)	Rated Power (Watt)	Measurement (dBm)	FCC Limit	Results
4FSK	12.5 KHz	152.1220	5	36.71	Varies	Compliance

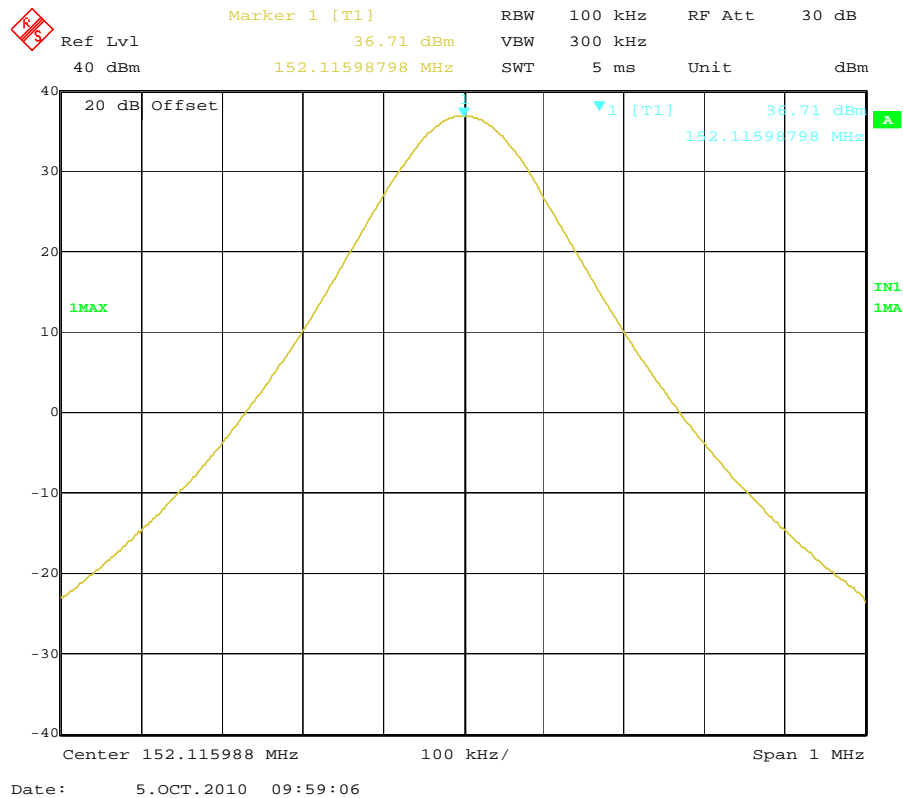

Modulation Type	Channel Separation	Freq.(MHz)	Rated Power (Watt)	Measurement (dBm)	FCC Limit	Results
4FSK	12.5 KHz	173.9220	5	36.85	Varies	Compliance

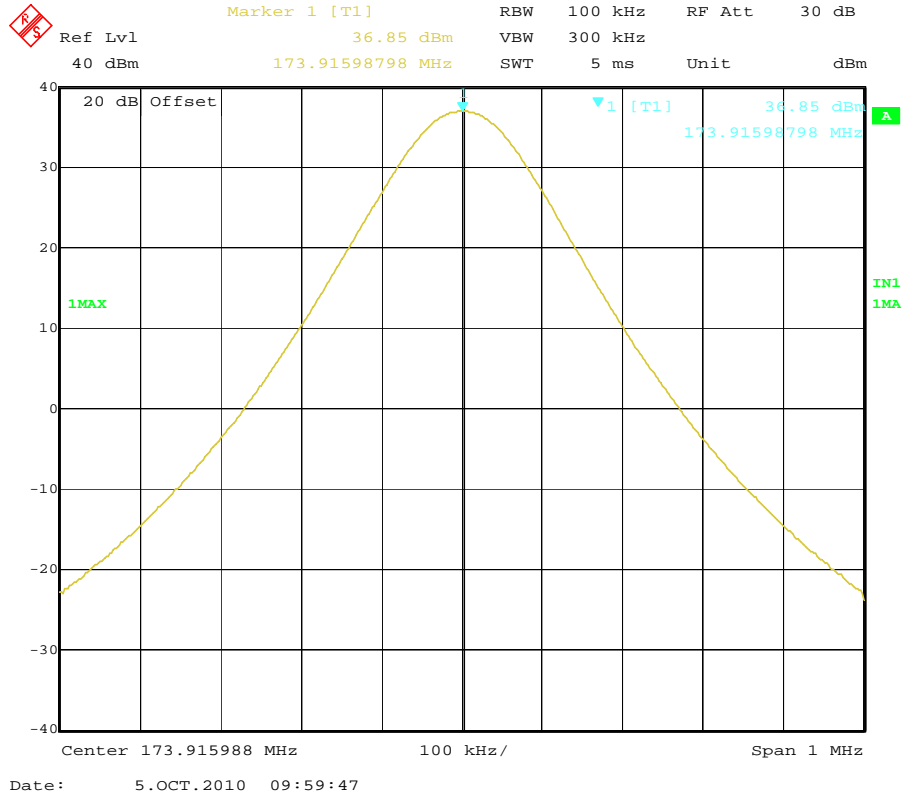

Modulation Type	Channel Separation	Freq.(MHz)	Rated Power (Watt)	Measurement (dBm)	FCC Limit	Results
FM	25 KHz	136.1220	1	31.13	Varies	Compliance

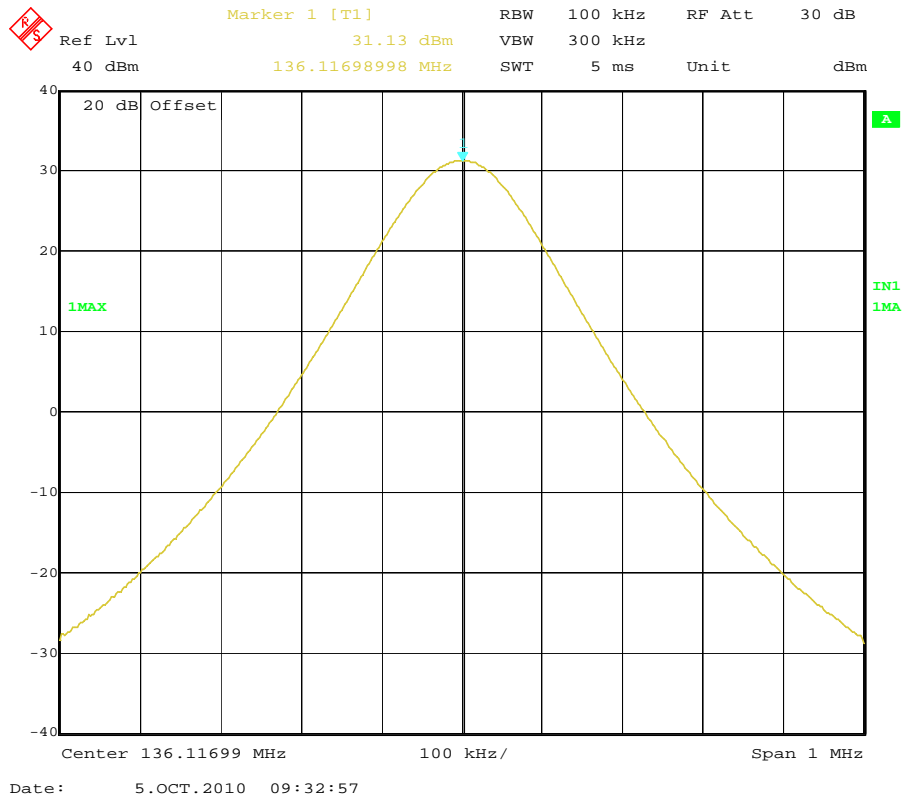

Modulation Type	Channel Separation	Freq.(MHz)	Rated Power (Watt)	Measurement (dBm)	FCC Limit	Results
FM	25 KHz	152.1220	1	30.71	Varies	Complicance

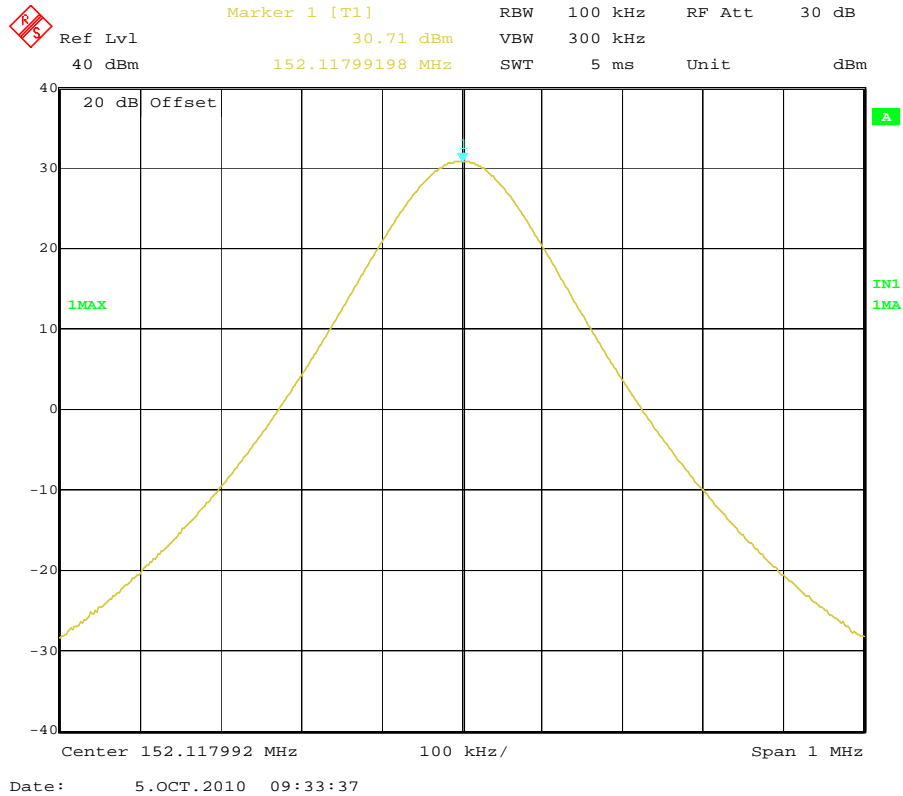

Modulation Type	Channel Separation	Freq.(MHz)	Rated Power (Watt)	Measurement (dBm)	FCC Limit	Results
FM	25 KHz	173.9220	1	30.97	Varies	Complicance

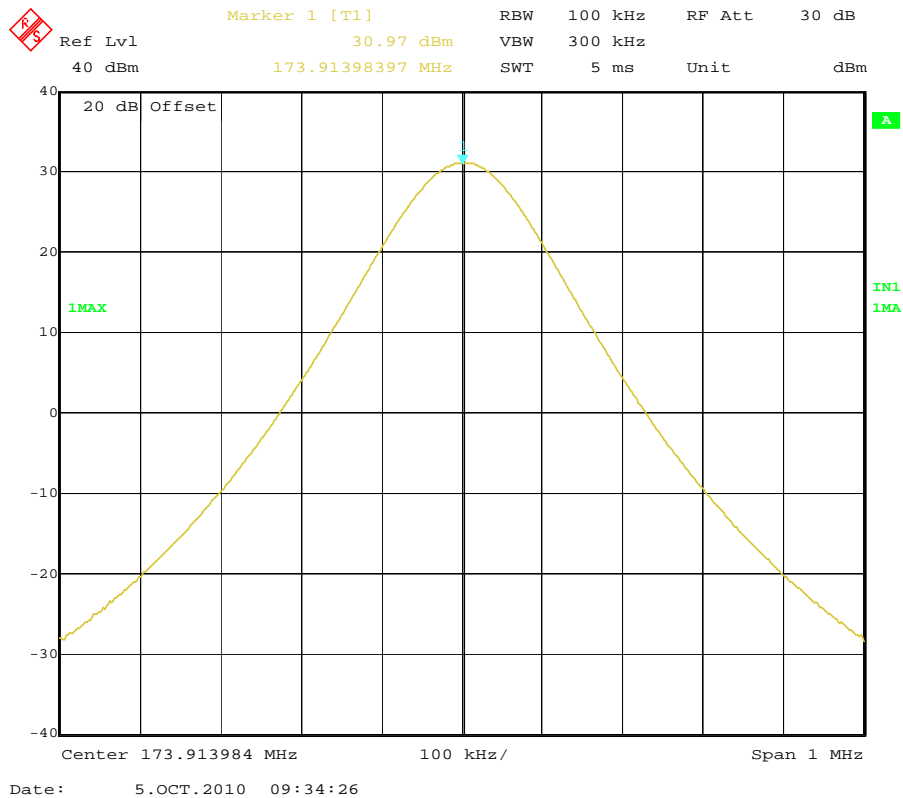

Modulation Type	Channel Separation	Freq.(MHz)	Rated Power (Watt)	Measurement (dBm)	FCC Limit	Results
FM	12.5 KHz	136.1220	1	31.14	Varies	Complicance

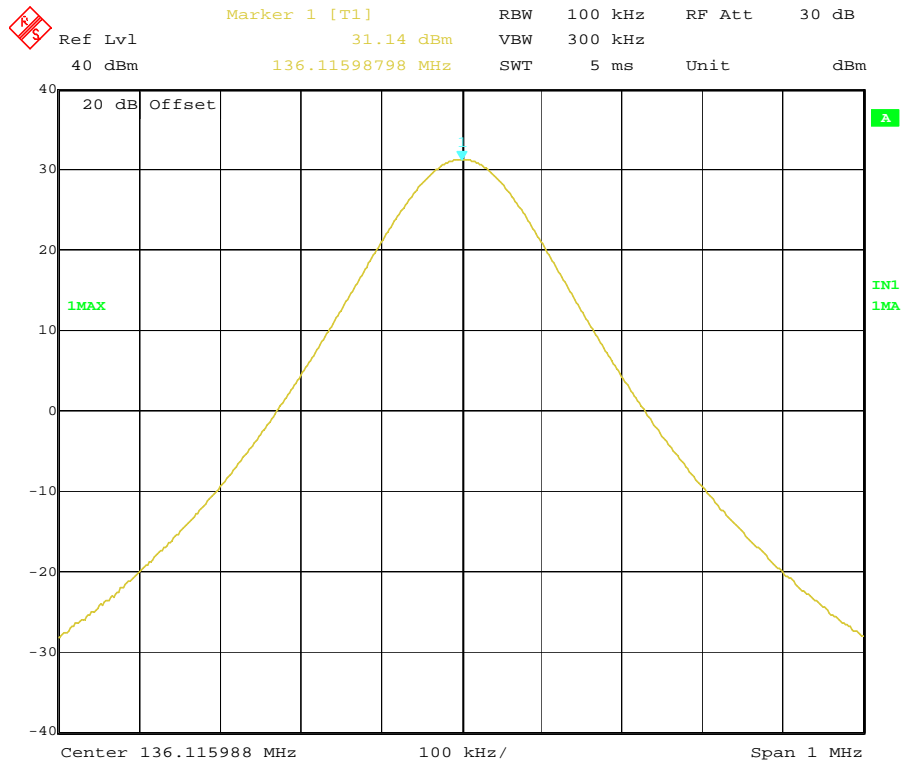

Date: 5.OCT.2010 09:30:24

Modulation Type	Channel Separation	Freq.(MHz)	Rated Power (Watt)	Measurement (dBm)	FCC Limit	Results
FM	12.5 KHz	152.1220	1	30.69	Varies	Complicance

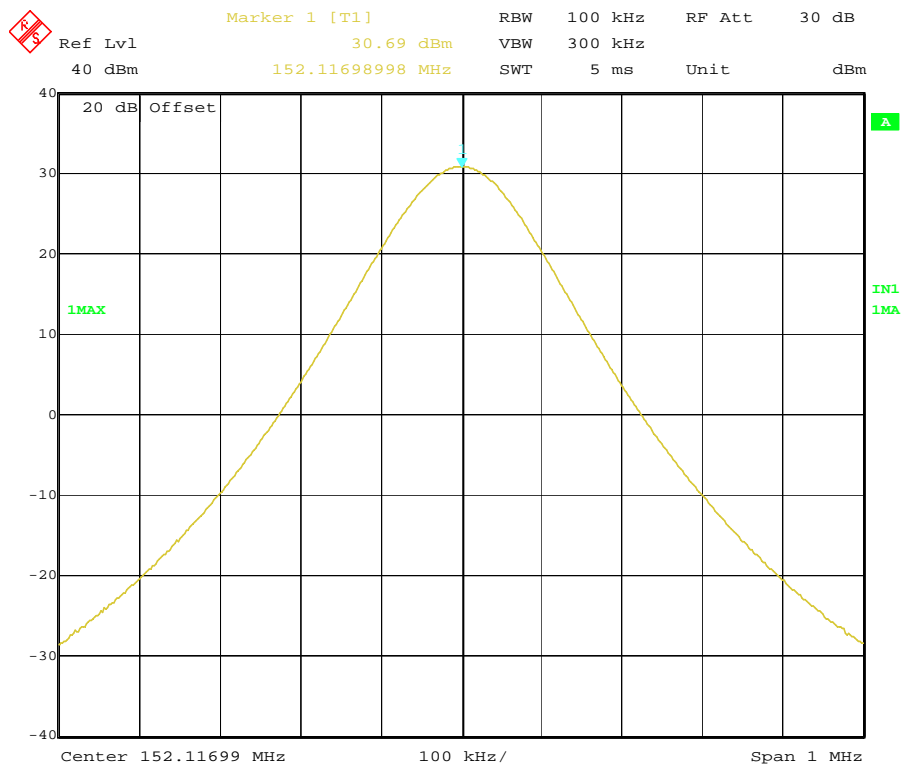

Date: 5.OCT.2010 09:31:05

Modulation Type	Channel Separation	Freq.(MHz)	Rated Power (Watt)	Measurement (dBm)	FCC Limit	Results
FM	12.5 KHz	173.9220	1	30.98	Varies	Compliance

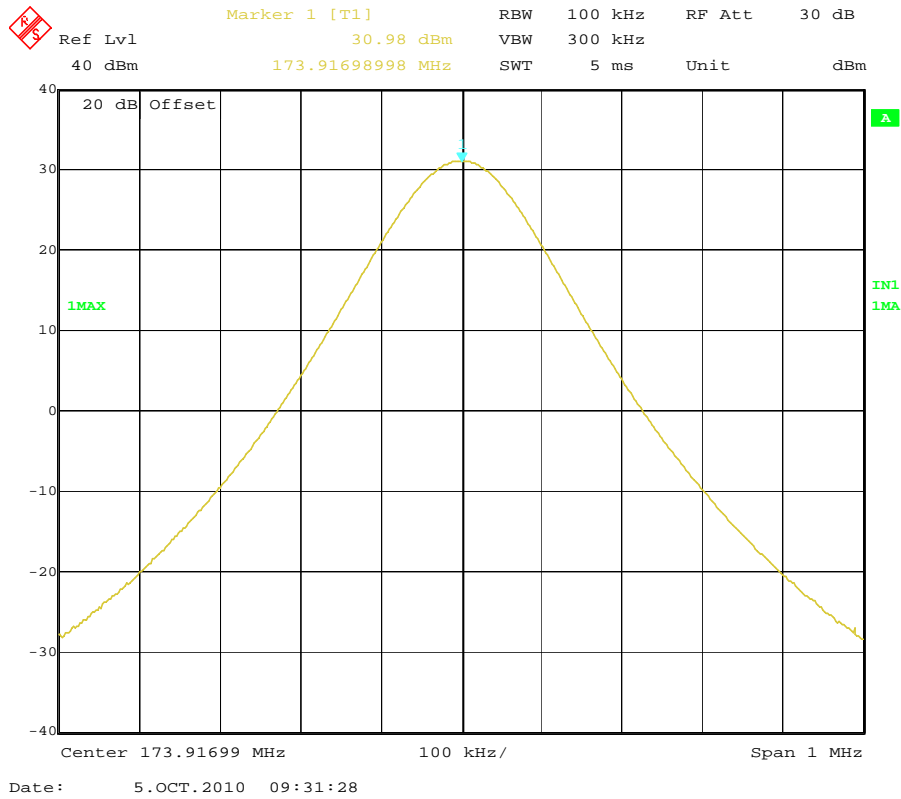

Modulation Type	Channel Separation	Freq.(MHz)	Rated Power (Watt)	Measurement (dBm)	FCC Limit	Results
4FSK	12.5 KHz	136.1220	1	31.12	Varies	Compliance

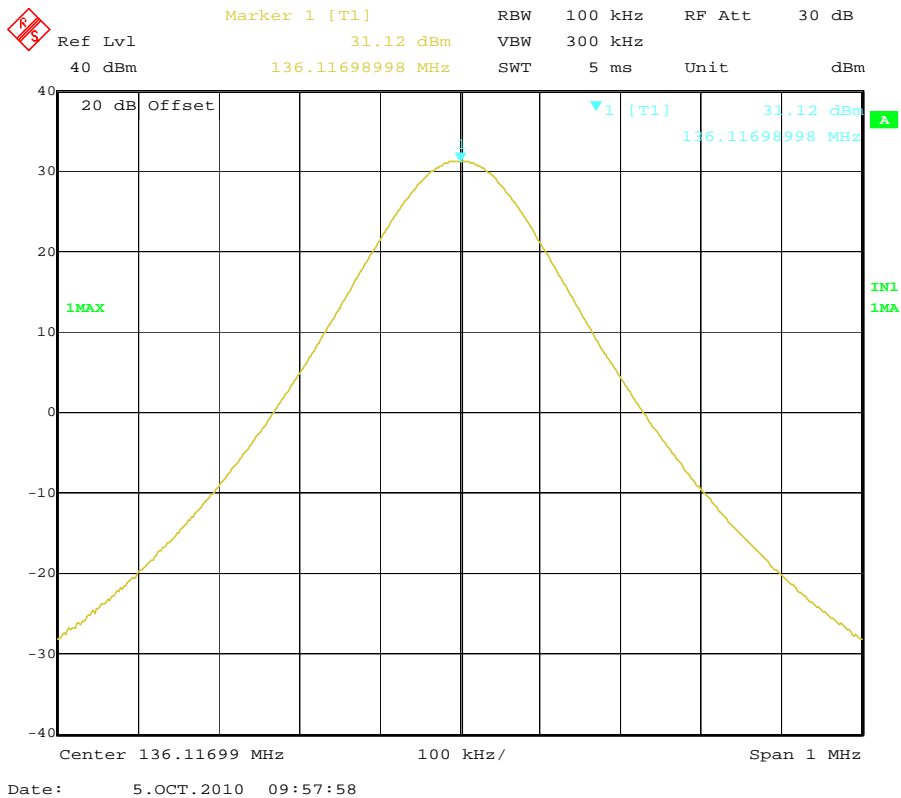

Modulation Type	Channel Separation	Freq.(MHz)	Rated Power (Watt)	Measurement (dBm)	FCC Limit	Results
4FSK	12.5 KHz	152.1220	1	30.69	Varies	Complicance

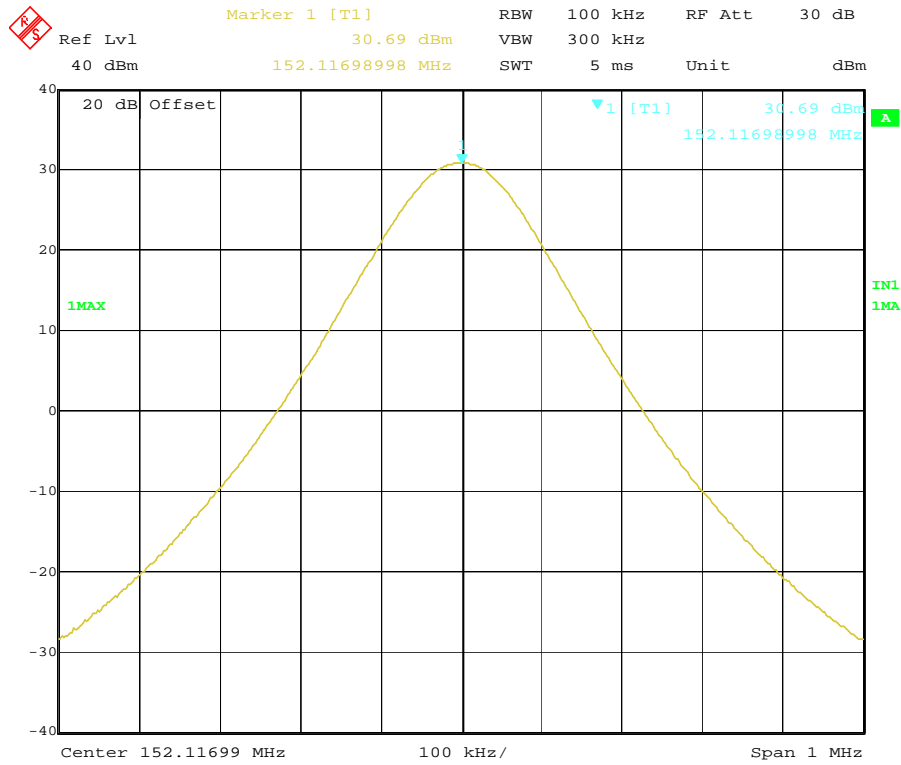

Date: 5.OCT.2010 09:58:51

Modulation Type	Channel Separation	Freq.(MHz)	Rated Power (Watt)	Measurement (dBm)	FCC Limit	Results
4FSK	12.5 KHz	173.9220	1	31.02	Varies	Complicance

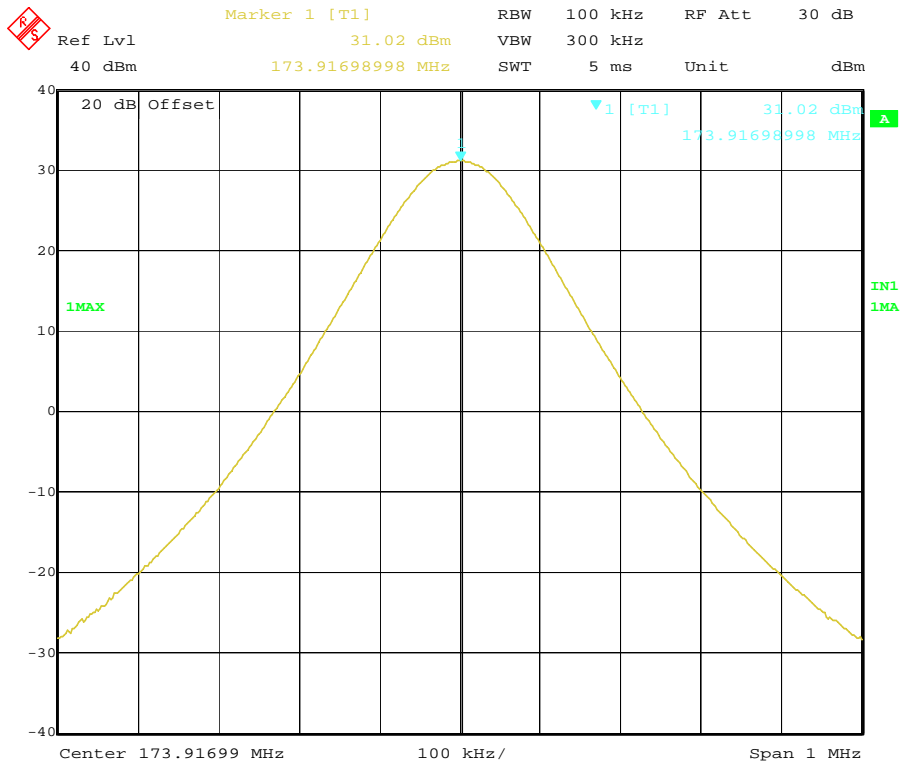

Date: 5.OCT.2010 09:59:27

4.8. Transmitter Frequency Behavior

TEST APPLICABLE

Section 90.214

Transient frequencies must be within the maximum frequency difference limits during the time intervals indicated:

Time intervals ^{1, 2}	Maximum frequency difference ³	All equipment	
		150 to 174 MHz	421 to 512MHz
Transient Frequency Behavior for Equipment Designed to Operate on 25 KHz Channels			
t_1 ⁴	± 25.0 KHz	5.0 ms	10.0 ms
t_2	± 12.5 KHz	20.0 ms	25.0 ms
t_3 ⁴	± 25.0 KHz	5.0 ms	10.0 ms
Transient Frequency Behavior for Equipment Designed to Operate on 12.5 KHz Channels			
t_1 ⁴	± 12.5 KHz	5.0 ms	10.0 ms
t_2	± 6.25 KHz	20.0 ms	25.0 ms
t_3 ⁴	± 12.5 KHz	5.0 ms	10.0 ms
Transient Frequency Behavior for Equipment Designed to Operate on 6.25 KHz Channels			
t_1 ⁴	±6.25 KHz	5.0 ms	10.0 ms
t_2	±3.125 KHz	20.0 ms	25.0 ms
t_3 ⁴	±6.25 KHz	5.0 ms	10.0 ms

- t_{on} is the instant when a 1 KHz test signal is completely suppressed, including any capture time due to phasing.
 t_1 is the time period immediately following t_{on} .
 t_2 is the time period immediately following t_1 .
 t_3 is the time period from the instant when the transmitter is turned off until t_{off} .
 t_{off} is the instant when the 1 KHz test signal starts to rise.
- During the time from the end of t_2 to the beginning of t_3 , the frequency difference must not exceed the limits specified in § 90.213.
- Difference between the actual transmitter frequency and the assigned transmitter frequency.
- If the transmitter carrier output power rating is 6 watts or less, the frequency difference during this time period may exceed the maximum frequency difference for this time period.

TEST PROCEDURE

TIA/EIA-603 2.2.19

TEST CONFIGURATION

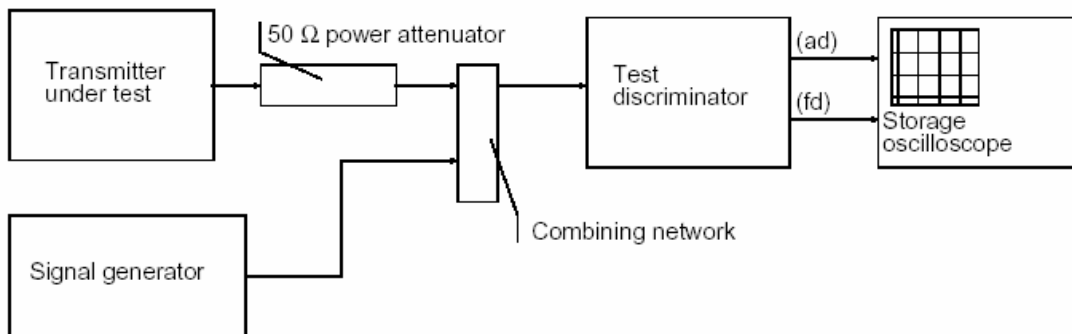

TEST RESULTS

Please refer to the following plots.

Modulation Type: FM

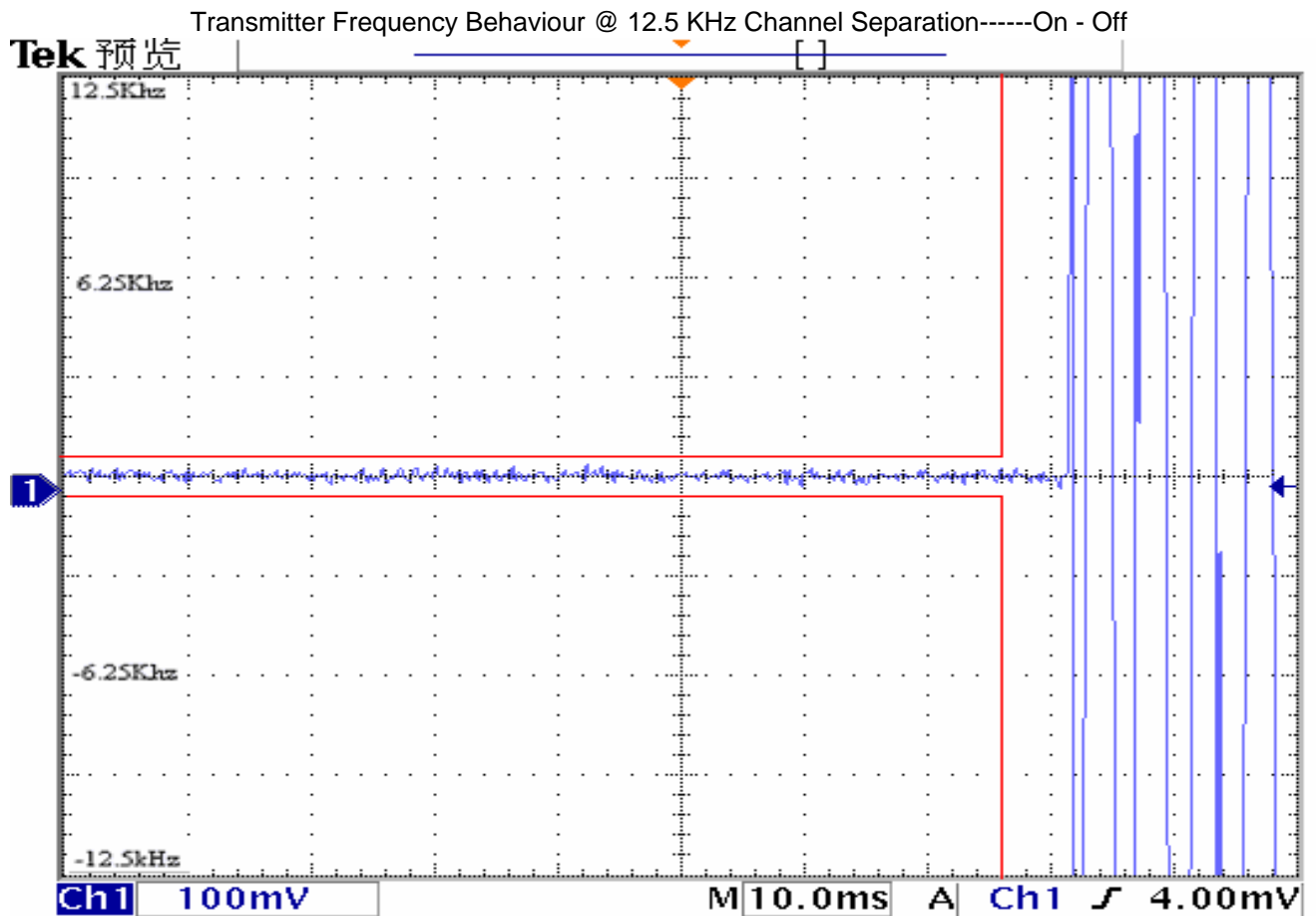
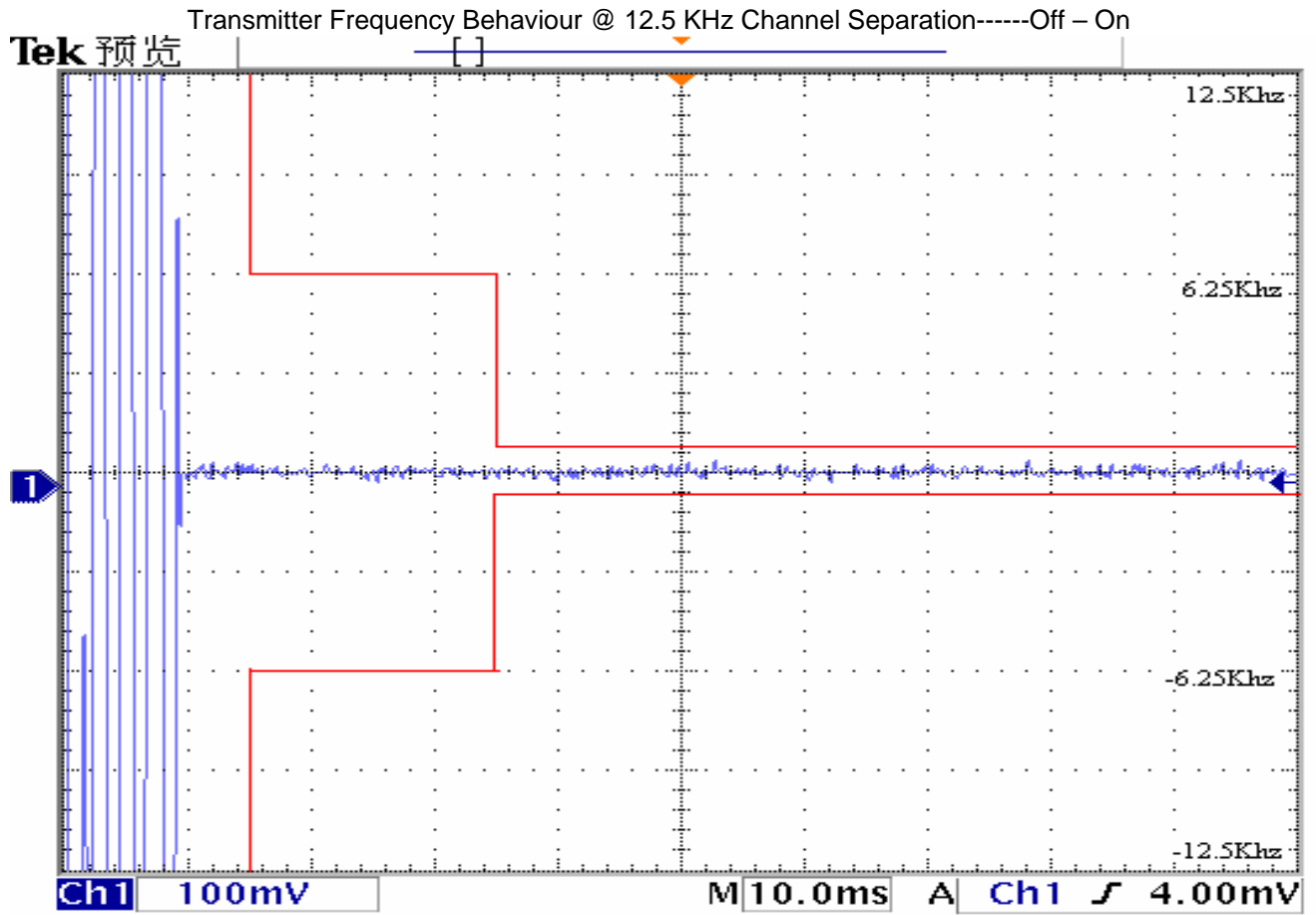

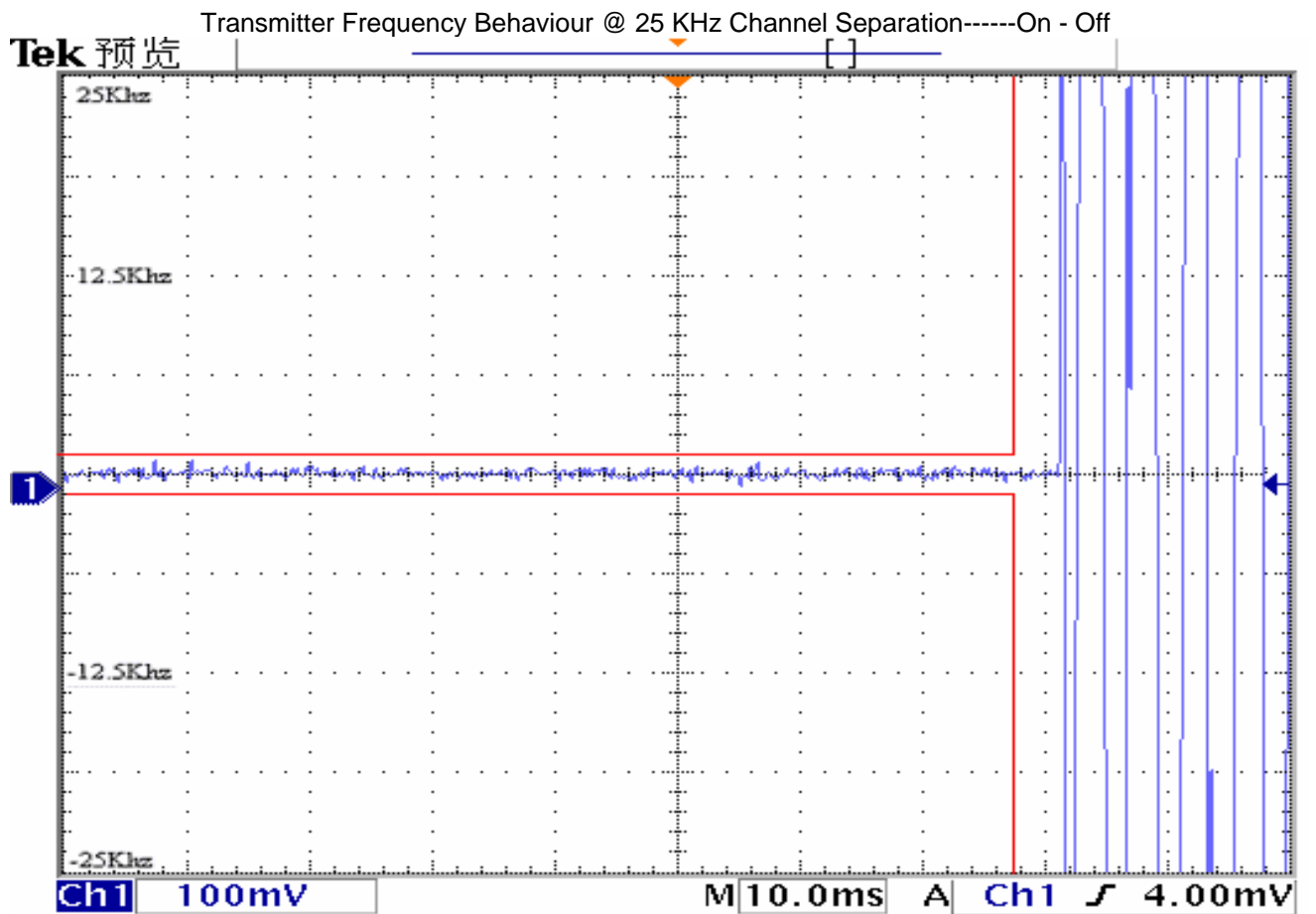
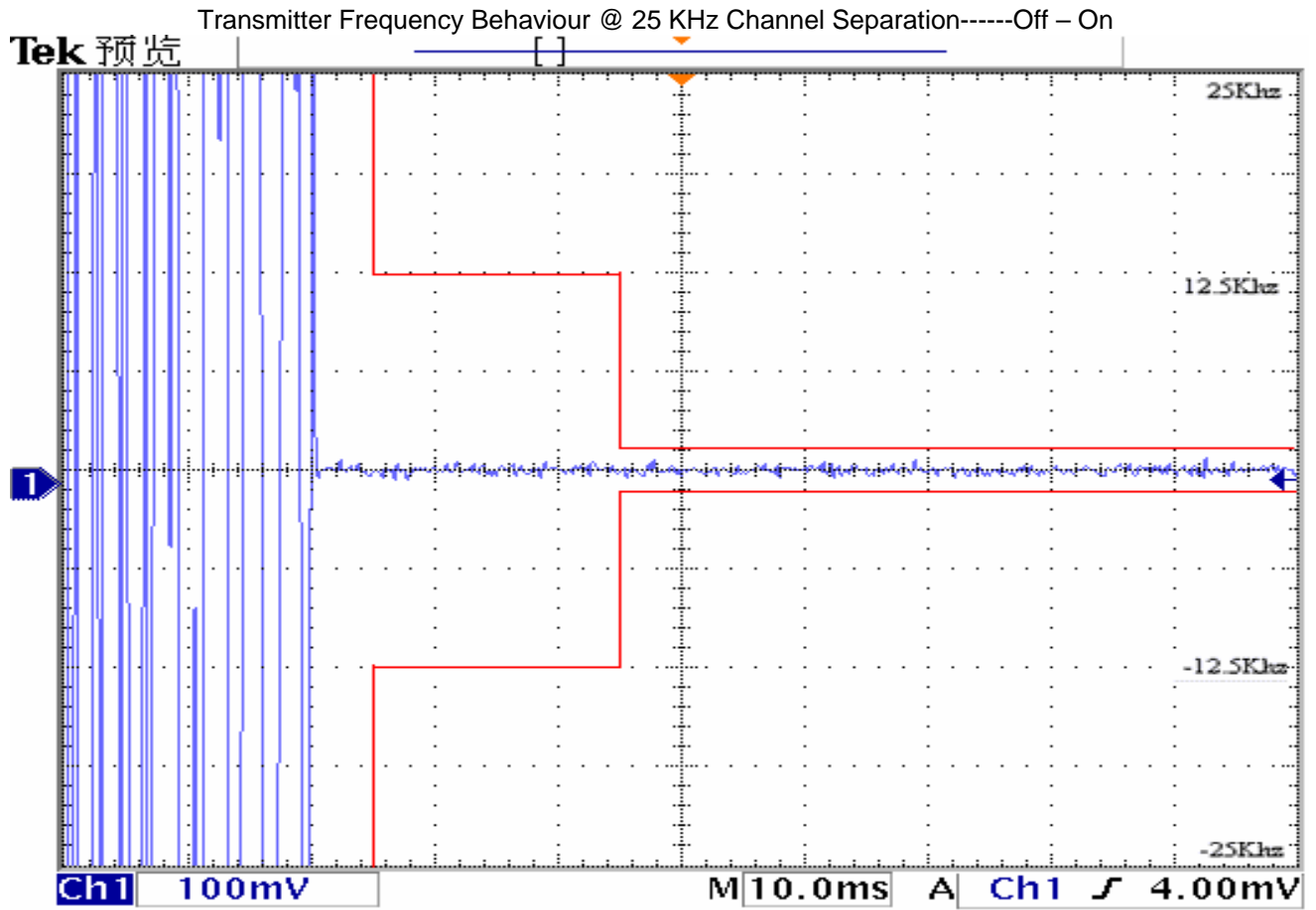

Modulation Type: 4FSK

FCC ID: YAMPD78XVHF

Transmitter Frequency Behaviour @ 12.5 KHz Channel Separation-----Off – On

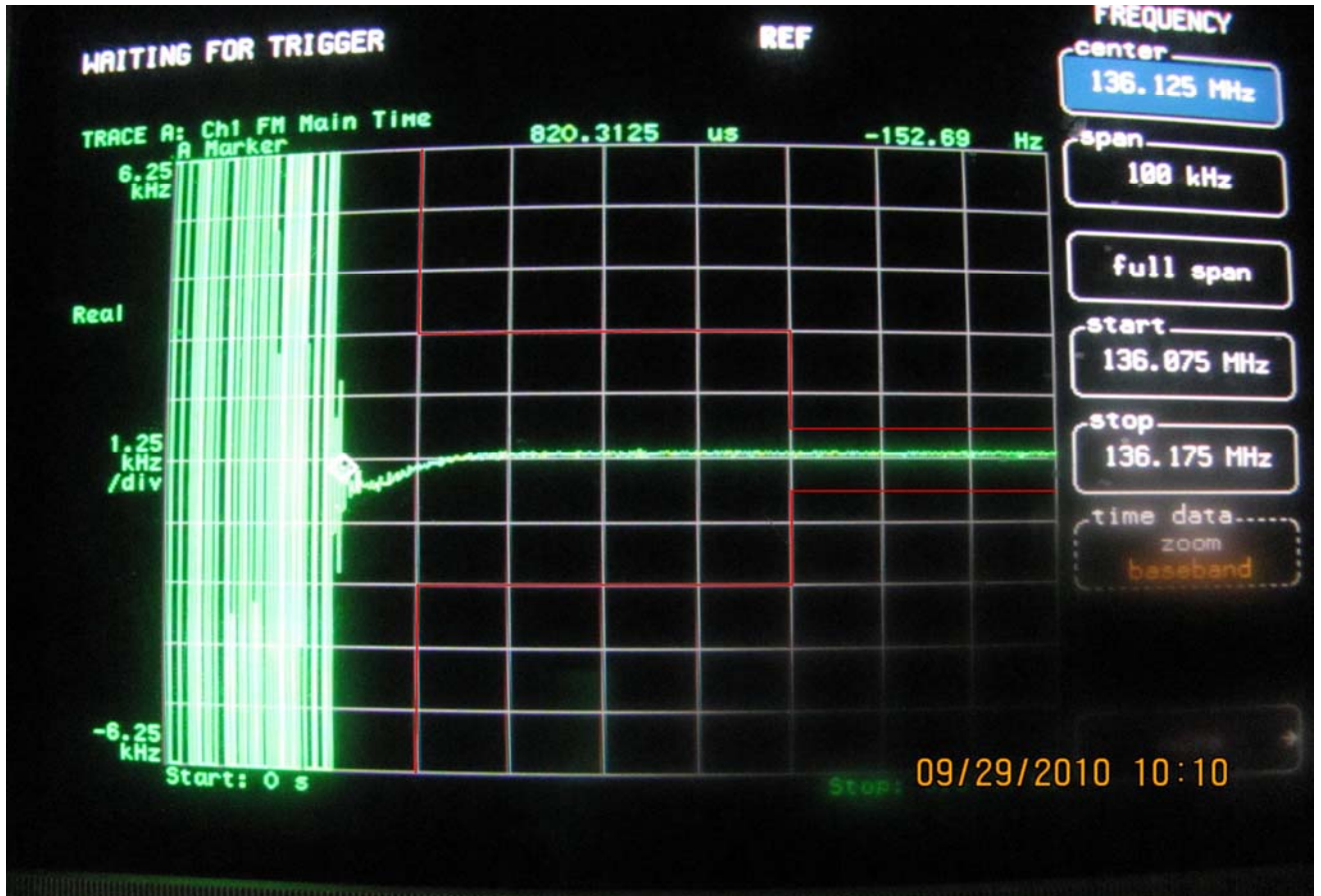

Transmitter Frequency Behaviour @ 12.5 KHz Channel Separation-----On - Off

