

Preface

Thank you for purchasing Hytera DMR Digital Portable Radio. As a product built to the DMR standard, it is endowed with ergonomic design, all-round digital functions and remarkable quality to refresh your experience and enable you to be responsive to emergent situations.

To derive optimum performance from your product, please read this manual and the supplied Safety Information Booklet carefully before use.

This manual is applicable to the following model:

PD78X

PD78XG

Instructional Icons

This radio is not intended for use by general population in an uncontrolled environment. It is only for occupational use and only applied to work-related conditions.

The radio must be only used by users, who are fully aware of the hazards of the exposure and who are able to exercise control over their RF exposure to qualify for the higher exposure limits.

The following icons are available through this manual:

Alert Icons



Caution: indicates situations that could cause damage to your product.



Note: indicates tips that can help you make better use of your product.

Function Icons



: indicates functions that are available on digital channel only.



: indicates functions that are available on analog channel only.

Functions marked with no function icons are available on both analog and digital channels.

Term Explanation

Key Operation

Short press: to press a key and release it quickly.

Long press: to press a key and remain holding it down for a predefined period (2 seconds by default).

Hold down: to press a key and remain holding it down.

Private Call

Private Call is a call initiated by a single user to another user.

Group Call

Group Call is a call initiated by a single user to a group.

All Call

All Call is a call initiated by a single user to all the other users on a channel.

Squelch

This technology can remove excessive background noises, improving your communication quality.

PTT ID

PTT ID, namely radio identity, allows a radio with display or the control center to identify the calling party.

Copyright Information

Hytera and HYT are trademarks or registered trademarks of Hytera Communications Co., Ltd. (“Hytera”) in PRC and/or other countries or areas. Hytera retains the ownership of its trademarks and product names. All other trademarks and/or product names that may be used in this manual are properties of their respective owners.

The Hytera product described in this manual may include Hytera computer programs stored in memory or other media. Laws in PRC and/or other countries or areas protect the exclusive rights of Hytera with respect to its computer programs. The purchase of this product shall not be deemed to grant, either directly or by implication, any rights to the purchaser with respect to Hytera computer programs. Any Hytera computer programs may not be copied, modified, distributed, decompiled, or reverse-engineered in any manner without the prior written consent of Hytera.

The AMBE+2™ voice coding technology embodied in this product is protected by intellectual property rights including patent rights, copyrights and trade secrets of Digital Voice Systems, Inc.

This voice coding technology is licensed solely for use within this product. The user of this technology is explicitly prohibited from attempting to decompile, reverse engineer, or disassemble the Object Code or in any other way convert the Object Code into a human readable form.

U.S. Patent Nos. #6,912,495 B2, #6,199,037 B1, #5,870,405, #5,826,222, #5,754,974, #5,701,390, #5,715,365, #5,649,050, #5,630,011, #5,581,656, #5,517,511, #5,491,772, #5,247,579, #5,226,084 and #5,195,166.

Disclaimer

Hytera endeavors to achieve the accuracy and completeness of this manual, but no warranty of accuracy or reliability is given. All the specifications and designs are subject to change without prior notice due to continuous technology development. No part of this manual may be copied, modified, translated, or distributed in any manner without the express written permission of Hytera.

If you have any suggestions or would like to learn more details, please visit our website at: <http://www.hytera.cn>.

RF Energy Exposure Compliance

Your radio is designed and tested to comply with a number of national and international standards and guidelines (listed below) regarding human exposure to radio frequency electromagnetic energy. This radio complies with the IEEE and ICNIRP exposure limits for occupational/controlled RF exposure environment at operating duty factors of up to 50% transmitting and is authorized by the FCC for occupational use only. In terms of measuring RF energy for compliance with the FCC exposure guidelines, your radio radiates measurable RF energy only while it is transmitting (during talking in PTT mode), not when it is receiving (listening) or in standby mode.

The device complies with SAR and/or RF field strength limits of RSS-102 requirement and contact information where the user can obtain Canadian information on RF exposure and compliance.

The highest reported SAR value are-Head: 2.121W/kg;Body-worn:4.02W/kg.

Your radio complies with the following of RF energy exposure standards and guidelines

- United States Federal Communications Commission, Code of Federal Regulations; 47CFR part 2 sub-part J
- American National Standards Institute (ANSI)/Institute of Electrical and Electronic Engineers (IEEE) C95. 1-1992
- Institute of Electrical and Electronic Engineers (IEEE) C95. 1-1999 Edition
- International Commission on Non-Ionizing Radiation Protection (ICNIRP) 1998

Operational Instructions and Training Guidelines

To ensure optimal performance and compliance with the occupational/controlled environment RF energy exposure limits in the above standards and guidelines, users should transmit no more than 50% of the time and always adhere to the following procedures; and should transmit no more than 50% of the time, although the hardware support transmission up to 100% of the time in analog mode and up to 50% in digital mode.

Transmit and Receive

To transmit (talk), push the Push-To-Talk (PTT) key; to receive, release the PTT key.

EU Regulatory Conformance

The equipment is in compliance with the essential requirements and other relevant provisions of the Directive 1999/5/EC.



Note: The above information is applicable to EU countries only.

FCC Licensing Information

Part 15 Compliance







This equipment has been tested and found to comply with the limits for a Class B digital device, pursuant to part 15 of the FCC Rules. These limits are designed to provide reasonable protection against harmful interference in a residential installation. This equipment generates, uses and can radiate radio frequency energy and, if not installed and used in accordance with the instructions, may cause harmful interference to radio communications. However, there is no guarantee that interference will not occur in a particular installation. If this equipment does cause harmful interference to radio or television reception, which can be determined by turning the equipment off and on, the user is encouraged to try to correct the interference by one or more of the following measures:





- Reorient or relocate the receiving antenna.
- Increase the separation between the equipment and receiver.
- Connect the equipment into an outlet on a circuit different from that to which the receiver is connected.
- Consult the dealer or an experienced radio/TV technician for help.

FCC Licensing Requirements

A license from Federal Communications Commission is required prior to use. Your dealer will program each radio with your authorized frequencies, signaling codes, etc., and will be there to meet your communications needs as your system expands. Contact your dealer for more information.

Contents

Checking Items in the Package	7
Product Overview	8
Product Controls	8
Programmable Keys	9
Before Use	11
Charging the Battery	11
Assembling the Accessories	12
Status Indication	14
LCD Icon	14
LED Indicator	15
Basic Operations	16
Turning the Radio On/Off	16
Adjusting the Volume	16
Selecting a Zone	16
Selecting a Channel	16
Switching the Channel Mode	16
Locking/Unlocking the Keypad	16
Call	18
Private Call 	18
Group Call 	18
All Call 	19
Calls on Analog Channels 	19
Menu Navigation	20
Contact 	20
Message 	21
Call Logs 	22
Scan	22
Zone	23
Settings	24
Accessories	26
Functions and Operations	27
Home Screen	27
Scan	27

Talk Around	28
Monitor 	28
Squelch Off 	28
Emergency.....	28
Battery Power Indicator	32
Man Down (optional).....	33
Scrambler  /Encrypt 	33
Busy Channel Lockout.....	34
Time-out Timer (TOT)	34
Pseudo Trunking 	34
MIC AGC	34
Signaling Introduction.....	35
HDC1200	35
Troubleshooting.....	36
Care and Cleaning	38
Optional Accessories.....	39
Appendix	40
Input Method.....	40

Checking Items in the Package

Please unpack carefully and check that all items listed below are received. If any item is missing or damaged, please contact your dealer.

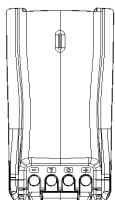

Battery

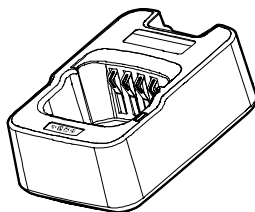

Charger

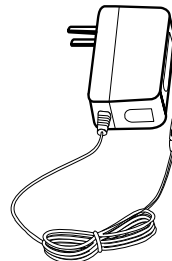

Power Adapter



Antenna

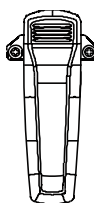

Belt Clip



Strap

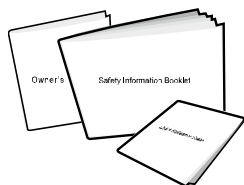

Owner's Manual/ Safety Information Booklet/ Quick Reference Guide



Radio Unit



Note: The antenna may vary with different frequency bands. And the frequency band is marked on the label of antenna; if not, please refer to the label on the radio unit for frequency band information.

Three pieces batteries contained in the package: Battery 1:Model:BL2503 DC7.4V 2500mAh/18.5Wh

Battery 2:Model:BL2411-Ex DC7.4V 2400mAh/17.7Wh

Battery 3:Model:BL2006 DC7.4V 2000mAh/14.8Wh



Product Overview

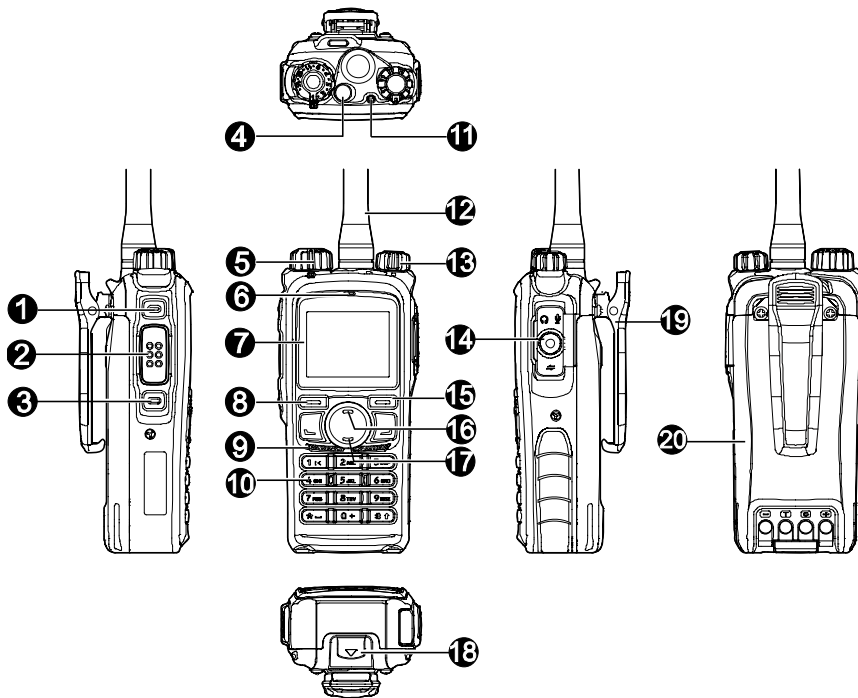







Product Controls





No.	Part Name	No.	Part Name
①	SK1 (Side Key 1)	⑪	LED Indicator
②	PTT Key	⑫	Antenna
③	SK2 (Side Key 2)	⑬	Radio On-Off/Volume Control Knob
④	TK (Top Key)	⑭	Accessory Jack
⑤	Channel Selector Knob	⑮	Back Key
⑥	Microphone	⑯	Up Key
⑦	LCD Display	⑰	Down Key
⑧	OK/Menu Key	⑱	Battery Latch
⑨	Speaker	⑲	Belt Clip
⑩	Numeric Keypad	⑳	Battery

Programmable Keys

For enhanced convenience, you may request your dealer to program the keys **SK1**, **SK2**, **TK**,  and  as shortcuts to the functions listed below:

No.	Shortcut Keys	Description
1	Zone Up	To select a desired zone quickly
2	Zone Down	
3	Keypad Lock	To lock or unlock the keypad quickly
4	Contact List 	To access the menu "Contact List" quickly
5	Message 	To access the menu "Message" quickly
6	Call Log 	To access the menu "Call Logs" quickly
7	Adjust Power Level	To adjust power level quickly
8	Talk Around	To directly communicate with other radios
9	Monitor 	To adjust the condition for incoming signal match
10	Monitor Momentary 	
11	Squelch Off 	To always unmute the speaker no matter whether carrier is present or not
12	Squelch Off Momentary 	
13	Home Screen	To quickly return to the previous menu or home screen
14	Scan	To receive signals on other channels
15	Nuisance Temporary Delete	To temporarily ignore unwanted channel activity
16	Emergency	To summon help in emergent situations
17	Adjust Squelch Level 	To temporarily adjust the squelch threshold required for the radio to unmute
18	Battery Power Indicator	To indicate the battery strength

19	Man Down	To activate Emergency in the case that the radio is positioned aslant for a preset time period due to an unexpected situation
20	Scrambler  /Encrypt 	Scrambler: To encrypt your voice so as to guarantee privacy of your communication Encrypt: To encrypt your voice and message so as to guarantee privacy of your communication



Note:

- (1) Long and short press of a key can be assigned with different functions by your dealer.
- (2) The **TK** is programmed as the **Emergency** key by default, and is programmable by your dealer.

Before Use

Charging the Battery

Use only the charger and battery specified by Hytera. Charger LED can indicate the charging process.

Charge Diagram

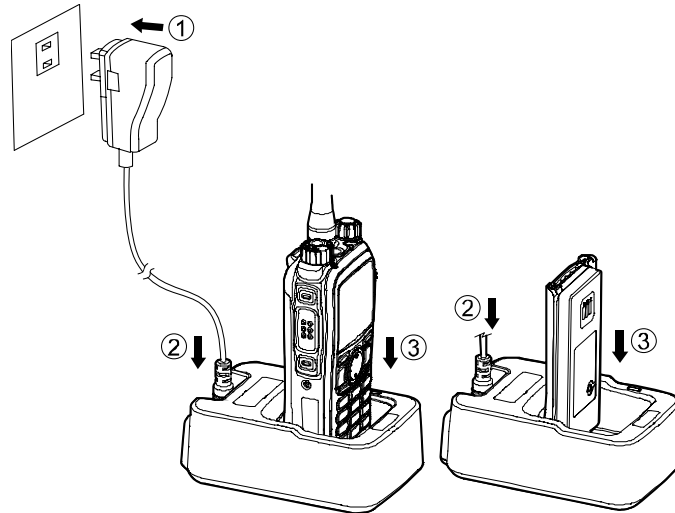

Procedures

1. Connect the power adapter to AC source. See arrow ①.
2. Plug the power adapter into the rear socket of the charger. See arrow ②.
3. Place the radio with the battery attached, or the battery alone, into the charger.
4. The charging process initiates when LED glows red, and is completed when LED glows green.



Note: To achieve optimal battery performance, please charge the battery for 5 hours before initial use.

Charge Indicator

LED Indicator	Charge Status
Red LED flashes slowly.	Standby (no load)
Red LED glows.	Charging
Orange LED glows.	90% charged
Green LED glows.	Fully charged
Red LED flashes rapidly.	Failure



Caution: Be sure to read the Safety Information Booklet, to get necessary safety information.

Assembling the Accessories

Attaching the Antenna

Turn the antenna clockwise to fasten it.

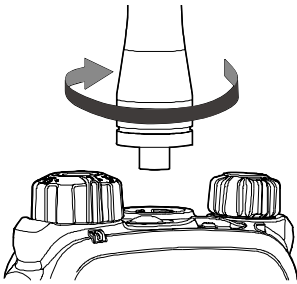

To remove the antenna, rotate it counter-clockwise.

Attaching the Battery

1. Insert the battery into top of the radio. See arrow ①.
2. Slightly press the bottom of the battery until a click is heard. See arrow ②.

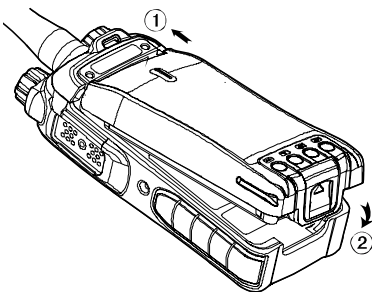

To remove the battery, turn off the radio first. Then slide the battery latch upwards to unlock the battery.

Attaching the Belt Clip

1. Remove the screws.
2. Align the screw holes on the belt clip with those on the radio's body, and then tighten the screws.

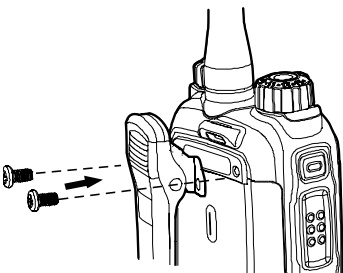

To remove the belt clip, loosen the screws.

Attaching the Audio Accessory/Programming Cable

1. Open the accessory jack cover as the arrow shown.
2. Align the plug with the accessory jack.
3. Tighten the screw on the plug.

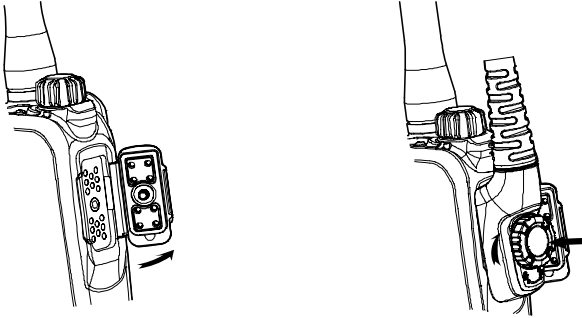

To remove accessories, loosen the screw.





















Caution: When you are using an external accessory, waterproof performance of the radio may get affected.

Status Indication

LCD Icon

✧ Status Icon



Icon Name	Icon	Radio Status
RSSI		No signal
		More bars indicate better signal strength
Message Icon		New message/unread message
		InBox is full
Scan Icon		Scanning is in progress
		Scanning pauses on a non-priority channel
		Scanning pauses on Priority Channel 1
		Scanning pauses on Priority Channel 2
TX Power Icon		Low TX power for the current channel
		High TX power for the current channel
Battery Strength Icon		More bars indicate more battery power
Monitor Icon		The Monitor feature is active
Speaker Icon		The speaker is unmuted
Emergency Icon		The Emergency mode (other than secret emergency) is active or an emergency message is received
Accessory Icon		An accessory is connected
GPS Icon		The GPS feature is active, and valid GPS data is received

		The GPS feature is active, but no valid GPS data is received
Scrambler/Encrypt Icon		The Scrambler/Encrypt feature is active



Note: The description related to the GPS feature in this manual is applicable to PD78XG only.

✧ Operation Mode Icon

Icon Name	Icon	Operation Mode
Operation Mode Icon		Direct Mode: Under this mode, radios communicate with each other directly
		Repeater Mode: Under this mode, radios communicate with each other via a repeater

LED Indicator

The top LED indicator will help you easily identify the current radio status.

LED Indicator	Radio Status
LED flashes green.	Powering on
LED glows red.	Transmitting
LED glows green.	Receiving
LED flashes orange slowly.	Scanning
LED flashes orange rapidly.	Emergency
LED glows orange.	Call ended (within the preset time period)

Basic Operations

Turning the Radio On/Off

Rotate the **Radio On-Off/Volume Control** knob clockwise/counter-clockwise until a click is heard to turn the radio on/off.

Adjusting the Volume

After turning the radio on, rotate the **Radio On-Off/Volume Control** knob clockwise to increase the call volume, or counter-clockwise to decrease it.

Selecting a Zone

A zone is a group of channels exhibiting the same property, and is programmed by your dealer. The radio supports up to 64 zones, each with a maximum of 16 channels. You may select a zone through any of the following methods:

1. Through menu selection

Go to the menu “Zone”, and use the **Up/Down** key to select your desired zone.

2. Through the function keys

You may quickly toggle to your desired zone by pressing the programmed **Zone Up** or **Zone Down** key.

Selecting a Channel

Rotate the **Channel Selector** knob to select a desired channel.

Switching the Channel Mode

Each channel can be programmed as either analog channel or digital channel. If the current zone includes both analog and digital channels, you may quickly switch between digital and analog channels through the **Channel Selector** knob.

Locking/Unlocking the Keypad

When the keypad is not in use, you can lock the keypad to prevent accidental keypad operation. The

following methods are available for you to lock or unlock the keypad:

1. Through key combination

Use “**OK+**  ” to lock or unlock the keypad.

2. Through the function key

Press the programmed **Keypad Lock** key to lock or unlock the keypad.

3. Through menu selection

Go to “Settings -> Radio Set -> Keypad Lock”, and then select “Enable” or “Disable”.

Enable: The keypad will be locked automatically if no operation is made within the preset time period.

Disable: The keypad will not be locked automatically. However, you can lock or unlock the keypad via the key combination or **Keypad Lock** key mentioned above.



Note: When the feature “Keypad Auto Lock” is enabled, the keypad will be locked automatically if no operation is made within the preset time period. You can use the “Disable” option in the menu “Keypad Lock” to deactivate the feature “Keypad Auto Lock”.

Call

To ensure an optimal volume of the receiving radio, hold the radio approximately 2.5 to 5 centimeters away from your mouth.

Private Call

Transmitting a Private Call

You may transmit a Private Call through any of the following methods. When transmitting a Private Call,

the icon  will appear.

- Transmitting a call to the preset contact

In the home screen, hold down the **PTT** key to transmit a Private Call to the Private Call contact preset for the current channel.



Note: Your dealer may preset a contact for each digital channel. The preset contact could be a Private Call contact, a Group Call contact or an All Call contact.

- Transmitting a call through Contact List or Call Logs

- 1) Go to “Contact -> Contact List”, or go to “Call Logs” and access the Outgoing/Incoming/Missed list.
- 2) Use the **Up/Down** key to select the Private Call contact you want to call.
- 3) Hold down the **PTT** key to transmit the Private Call.

- Transmitting a call through Manual Dial

- 1) Go to “Contact -> Manual Dial”.
- 2) Input a Private Call number you want to call.
- 3) Hold down the **PTT** key to transmit the Private Call.

Receiving and Responding to a Private Call

When a Private Call is received, your radio will display the icon .

You may hold down the **PTT** key within the preset time period to call back. If you do not respond to a

received Private Call, your radio will display the missed call icon .

Group Call

Transmitting a Group Call

You may transmit a Group Call through any of the following methods. When transmitting a Group Call, the

icon  will appear.

1. Transmitting a call to the preset contact

In the home screen, hold down the **PTT** key to transmit a Group Call to the Group Call contact preset for the current channel.

2. Transmitting a call through Contact List

- (1) Go to “Contact -> Contact List”.
- (2) Use the **Up/Down** key to select the Group Call contact you want to call.
- (3) Hold down the **PTT** key to transmit the Group Call.

Receiving and Responding to a Group Call

When a Group Call is received, your radio will display the icon .

You may hold down the **PTT** key within the preset time period to call back.

All Call

Transmitting an All Call

Methods are the same as those in *Transmitting a Group Call*. When transmitting an All Call, the icon

 will appear.



Note: You can transmit an All Call only when it is enabled by your dealer.

Receiving an All Call

When an All Call is received, your radio will display the icon .



Note: You cannot respond to an All Call.

Calls on Analog Channels

To transmit on an analog channel, hold down the **PTT** and speak into the microphone. To receive, release the **PTT** key.

Menu Navigation

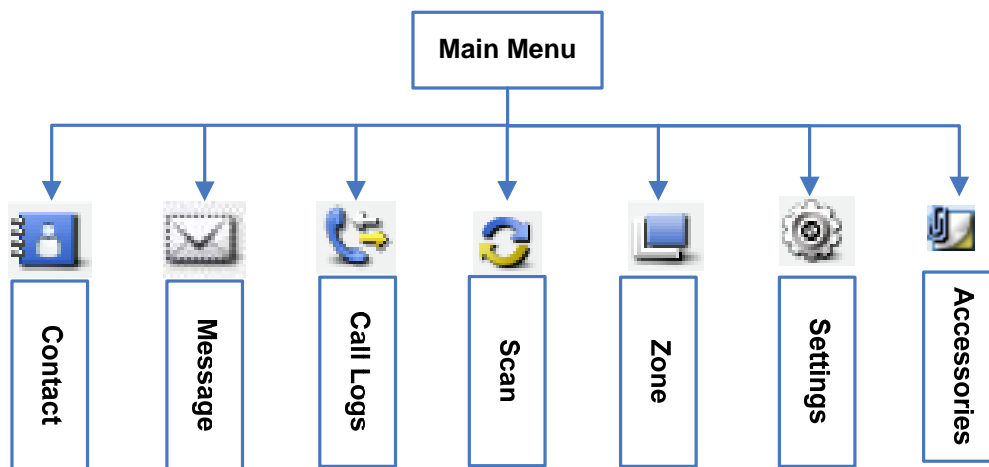

Contact

To access this item, press the **Menu** key in the home screen and then select “Contact”.

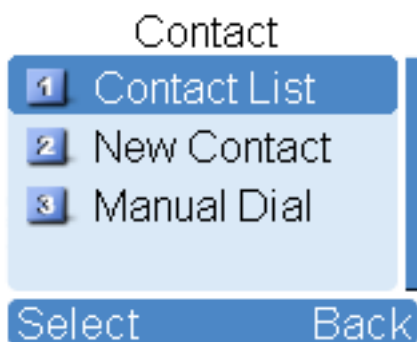

✧ **Contact List**

You can save up to 200 entries in the list. To access this item, select “Contact -> Contact List” or press the shortcut key for Contact List.

Editing a Contact

You can edit the number and alias of each Private Call contact.

Viewing a Contact

You can view details of each contact.

Deleting a Contact

You can delete a Private Call contact. However, please note that you can not delete the contact when there is only one entry left in the list. In addition, the Private Call contact preset on the currently used channel cannot be deleted.

✧ **New Contact**

You can add a Private Call contact to the contact list. The number and alias of each contact must be unique, and the available number range is 1-16776415.

✧ **Manual Dial**

You can manually input the Private Call number for calling.

Message

To access this item, press the **Menu** key in the home screen and then select “Message”, or press the shortcut key for Message directly.

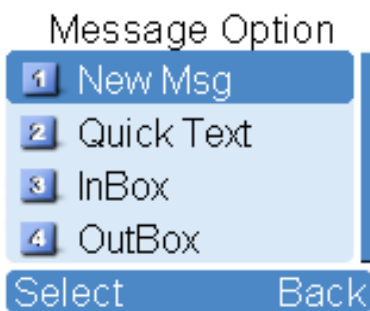

✧ **New Msg**

You can create new text message (256 characters at most) and send it to an individual user or to a talk group.

✧ **Quick Text**

Under this option there are some text messages (10 entries at most) preset by your dealer. You can choose to edit and send any entry.

✧ **InBox**

The InBox can save up to 20 received messages. When the InBox is full, the icon  will appear, and the earliest message will be overwritten by the latest one automatically.

For each message, you can choose to perform any of these operations: Reply, Forward, View Details and Delete.

To delete all messages in the InBox, select “Message -> InBox -> Delete All”.

✧ **OutBox**

The OutBox can save up to 20 sent messages. When the OutBox is full, the earliest message will be overwritten by the latest one automatically.

For each message, you can choose to perform any of these operations: Resend, Forward, View Details

and Delete.

To delete all messages in the OutBox, select “Message -> OutBox -> Delete All”.

✧ **Drafts**

The Drafts can save up to 20 draft messages. When the Drafts is full, the earliest message will be overwritten by the latest one automatically.

For each message, you can choose to perform any of these operations: Send, Save and Delete.

To delete all messages in the Drafts, select “Message -> Drafts -> Delete All”.

Call Logs

To access this item, press the **Menu** key in the home screen and then select “Call Logs”, or press the shortcut key for Call Logs directly.

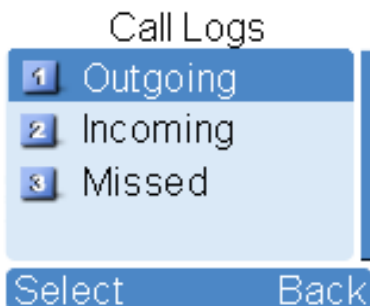

This radio can save up to 10 private call entries in the Outgoing/Incoming/Missed list respectively. When the Outgoing/Incoming/Missed list is full, the earliest entry will be overwritten by latest one automatically.

After accessing a list and selecting an entry, you can perform any of these operations: hold down the **PTT** key to initiate a call; add it to Contact List; or delete it.

To delete all entries in the Outgoing/Incoming/Missed list at a time, select “Call Logs -> Outgoing/Incoming/Missed -> Delete All”.

Scan

To access this item, press the **Menu** key in the home screen and then select “Scan”.

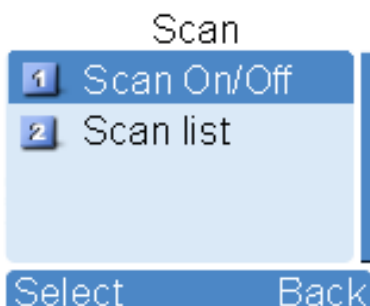

✧ **Scan On/Off**

The Scan feature allows you to listen to communication activities on other channels so that you can keep a close track of your team members. This option is used to enable or disable the function.

✧ **Scan List**

You can request your dealer to create a scan list for each channel. Each list may contain 32 channels at most (either digital channel or analog channel is OK). After accessing the list, you can perform any of the following operations:

Adding a Channel

To include a new channel into the active scan list.

Editing Priority Channel

To set the selected channel as a non-priority or as a priority channel. If you are interested in activities on a channel, you can set it as a priority channel, which will be scanned more frequently than a non-priority channel.

Each scan list may contain two priority channels at most. **P1** indicates priority channel 1, and **P2** indicates priority channel 2.

Deleting a Channel

To remove a channel from the active scan list. However, the first channel in the list can not be deleted.

Zone

To access this item, press the **Menu** key in the home screen and then select “Zone”.

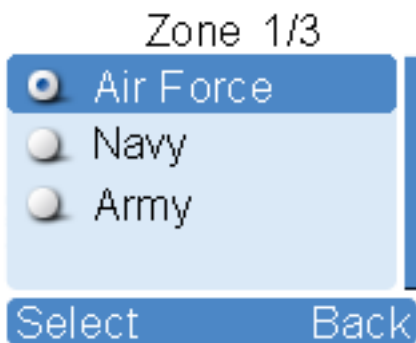

This radio supports up to 64 zones. You can use this menu to select your desired zone.

Settings

To access this item, press the **Menu** key in the home screen and then select “Settings”.

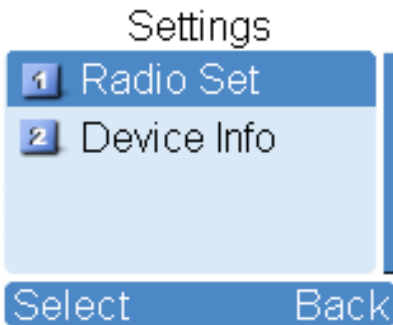

✧ **Radio Set**

You can optimize your radio performance by customizing related parameters according to actual needs and your preferences.

Power Level

This option allows you to set TX power level. Alternatively, you can change the power level by pressing the shortcut key for Adjust Power Level in the home screen.

There are two levels available: High (indicated by ) and Low (indicated by ). High power level enables you to communicate with farther team members.



Note: Power level should be set for each channel individually.

Squelch

This option allows you to select an appropriate squelch level. Alternatively, you can change the squelch level by pressing the shortcut key for Adjust Squelch Level in the home screen. There are three levels available: Tight, Normal and Open. The default squelch level is “Normal”, and is often used in low noise environment.

And generally, “Tight” is used in high noise environment. It requires stronger signal for the radio to unmute. However, if the squelch level is set to Open, the speaker will keep unmuted irrespective of the decoding conditions.

Scrambler **/Encrypt**

To set whether to enable the Scrambler/Encrypt feature.

Language

To set the language in which all interface information is displayed.

Backlight

To set the backlight parameters. There are three options available: On, Off and Timer. The timer is programmed by your dealer, with an available range of 5-60 seconds.

Brightness

To set the display brightness. You can raise or lower it using the **Up/Down** key.

Keypad Lock

To set whether to enable this function. When "Enable" is selected, you can use the **Up/Down** key to set the time range after which the keypad will be locked. Available range: 5-60 seconds.

LED

To set whether to enable LED indication.

Tone

To set alert tones for your radio. You can set the following tones:

Radio Silent: to set whether the radio will give tone indication. If Silent On is selected, all tone indication will be cancelled.

Talk Permit: to set whether the radio will give tone indication for transmission. The following options are available: Disable (no tone indication for transmission), Digital Only (tone indication for transmission on digital channels only), Analog Only (tone indication for transmission on analog channels only), and Enable (tone indication for transmission on both analog and digital channels).

Private Ring: to set whether the radio will give tone indication when the radio receives a private call.

TextMsg Ring: to set whether the radio will give tone indication when the radio receives a message.

Keypad: to set whether the radio will give tone indication when you are making keypad operations.

Vibration

To set whether to enable the Vibration feature. If enabled, your radio will vibrate upon reception of a message or a Private Call.

Man Down (optional)

To set whether to enable the Man Down feature.

✧ **Device Info**

With this option, you can view basic information of your radio, including serial number, radio model, frequency range and firmware version, etc.

Accessories

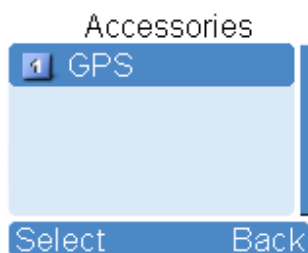

To access this item, press the **Menu** key in the home screen and then select “Accessories”.

✧ **GPS**

Position

With this option, you can view longitude, latitude, time, date, speed, altitude and SA (satellite) information of your radio.

GPS Text Msg

If the GPS feature is enabled via the programming software, you can send the GPS text message to your desired contact.

Operation:

1. Select “GPS Msg”, and press the **OK** key to access the menu “Contact List”.
2. Use the **Up/Down** key to select a desired contact.
3. Press the **OK** key to send the GPS message to the selected contact.



Note: Enabling the GPS feature will shorten the operating time of the battery.

Time Zone

You can choose your time zone to correct the received GPS time. We recommend you to set the time zone before your initial use of this feature.

Functions and Operations

Home Screen

The feature allows you to quickly return to the previous menu or the home screen.



Operation:

In the editing screen, press the programmed **Home Screen** key, and the radio exits the screen and returns to the previous menu immediately; in other screens, press the key, and the radio returns to the home screen immediately.

Scan

This feature allows you to listen to communication activities on other channels so that you can keep a close track of your team members.

Operation:

1. To enable the feature, you can select “On” from the menu “Scan”; or
Press the programmed **Scan** key in the home screen; or
Switch to a channel on which the feature “Auto Scan” is enabled via the programming software.
2. After the feature is enabled, your radio will scan according to the scan list set for the channel on which scanning starts. The scanning process is as follows:
 - During scanning, the LCD displays the icon  , and the LED flashes orange slowly.
 - When activities are detected on a channel, the radio will stay on the channel to receive current activities. If your radio stays on a non-priority channel, the LCD will display the icon  ; if on Priority Channel 1 or Priority Channel 2, the LCD will display the icon P_1 or P_2 respectively.
 - If you don't want to hear activities on the channel, press the programmed **Nuisance Temporary Delete** key to remove the channel from the scan list temporarily.
 - If you want to continue staying on the channel, press the programmed **Monitor** or **Squelch Off** key during scan stay. 
3. To exit the scanning process, you can select “Off” from the menu “Scan”, or press the programmed **Scan** key again.

Talk Around

You can continue to communicate in DM mode by pressing the programmed **Talk Around** key, when your repeater malfunctions, or when your radio is out of the repeater's range but within talking range of other radios.



Operation:

Press the programmed **Talk Around** key to switch between DM mode and RM mode.

Monitor

To adjust match conditions for signal receiving, you can enable the feature "Monitor".



Operation:

- ✧ Press the programmed **Monitor** key to enable the feature, and the radio displays the icon . To disable the feature, press this key again.
- ✧ Hold down the programmed **Monitor Momentary** key to enable the feature, and the radio displays the icon . To disable the feature, release this key.

Squelch Off

If the feature "Squelch Off" is enabled, the speaker will keep unmuted no matter whether carrier is present.

Operation:

- ✧ Press the programmed **Squelch Off** key to enable the feature. Then the radio displays the icon  and sounds background noise. To disable the feature, press this key again.
- ✧ Hold down the programmed **Squelch Off Momentary** key to enable the feature. Then the radio displays the icon  and sounds background noise. To disable the feature, release this key.

Emergency

In case of an emergency, you can use the feature to ask for help from your companion or control center.

The Emergency process has the highest priority. You can make emergency operation even when your radio is transmitting or receiving.

To enable the feature on a channel, an emergency system must be assigned to the channel via the programming software. In addition, the Emergency type, Emergency ID type and Emergency mode are settable via the programming software.

Emergency Type

For each Emergency mode, there are four Emergency types available. You can select one of them via your dealer:

Emergency Type	Description
Siren Only	In Emergency mode, the radio will sound shrill alarm tone and display the icon  .
Regular	In Emergency mode, the radio will give audible and visible indication.
Silent	In Emergency mode, the radio won't give any audible or visible indication.
Silent with Voice	In Emergency mode, the radio won't give any audible or visible indication, but will receive voice ACK from the companion or control center automatically.







Emergency ID Type

Your radio supports two Emergency ID types. You can select one of them via your dealer:

Emergency ID Type	Description
None	No signaling is used when the radio sends alarm information.
HDC1200	HDC1200 signaling is used when the radio sends alarm information.

Emergency Mode

Your radio supports three Emergency modes. You can select one of them via your dealer (Note: For the following operation methods, we take the “Regular” type as an example).

Emergency Mode	Description
Alarm 	In this mode, you can send alarm information to your companion or control center by pressing the programmed Emergency key, but you cannot talk with them.
Alarm with Call 	In this mode, you can send alarm information by pressing the programmed Emergency key. When the icon  appears, you can speak into the microphone, allowing your voice and background noise to be transmitted automatically (you do not need to hold down the PTT key).
Call Only	In this mode, press the programmed Emergency key to go to the Revert Channel. When the icon  () or  () appears, you can speak into the microphone, allowing your voice and background noise to be transmitted automatically (you do not need to hold down the PTT key).

Operation Methods for Analog Emergency

■ Alarm (None & HDC1200)







Operation: Press the programmed **Emergency** key to send alarm information. The radio displays the icon  and text information “Sending Alarm”, with red LED glowing. (None: If “Local Emergency Alarm” is enabled via the programming software, an alarm tone will sound.)

Two methods are available for you to exit the Emergency mode:

1. Once the Alarm Cycles expire, the radio will exit the Emergency mode automatically.
2. Long press the programmed **Emergency** key.

■ Alarm with Call (None & HDC1200)

Operation:







1. Press the programmed **Emergency** key to send alarm information. The radio displays the icon  and text information "Sending Alarm", with red LED glowing. (None: If "Local Emergency Alarm" is enabled via the programming software, an alarm tone will sound.)
2. When the icon  appears, you can speak into the microphone to make an emergency call.
3. When the icon  appears, you can receive. And when a call is received, the icon  appears.
4. If the preset Voice Cycles expire, you can hold down the **PTT** key to make the emergency call again (the radio displays the icon , with red LED glowing). After the emergency call is transmitted, release the **PTT** key to receive (the radio displays the icon , with LED flashing orange rapidly). And when a call is received, the icon  appears. (HDC1200 only)

Two methods are available for you to exit the Emergency mode:

1. After the preset Alarm Cycles and Voice Cycles expire, the radio will exit the Emergency mode automatically. (None)
2. Long press the programmed **Emergency** key.

■ Call Only (HDC1200)

Operation:

1. Press the programmed **Emergency** key to go to the Revert Channel, and the radio displays the icon .
2. If the feature "Alarm with Call to Follow" is enabled, you can speak into the microphone to make an emergency call when the radio displays the icon .
3. When the icon  appears, you can receive. And when a call is received, the icon  appears.
4. If the preset Voice Cycles expire, you can hold down the **PTT** key to make the emergency call again (the radio displays the icon , with red LED glowing). After the emergency call is transmitted, release the **PTT** key to receive (the radio displays the icon , with LED flashing orange rapidly).

And when a call is received, the icon  appears.

To exit the Emergency mode, long press the programmed **Emergency** key.









Note: Your dealer may set the number of alarm cycles and alarm duration (None), number of polite retries and impolite retries (HDC1200), number of voice cycles, duration of each transmission and TX interval.

Operation Method for Digital Emergency



■ Call Only

Operation:

1. Press the programmed **Emergency** key to go to the Revert Channel, and the radio displays the icon .
2. If the feature “Alarm with Call to Follow” is enabled, you can speak into the microphone to make an emergency call when the radio displays the icon .
3. When the icon  appears, you can receive. And when a call is received, the icon  appears.
4. If the preset Voice Cycles expire, you can hold down the **PTT** key to make the emergency call again (the radio displays the icon , with red LED glowing). After the emergency call is transmitted, release the **PTT** key to receive (the radio displays the icon , with LED flashing orange rapidly).

And when a call is received, the icon  appears.

To exit the Emergency mode, long press the programmed **Emergency** key.



Note: Your dealer may set the number of voice cycles, duration of each transmission and TX interval.





Battery Power Indicator

This feature allows you to know the current battery strength.

Operation:

Hold down the programmed **Battery Strength Indicator** key, and the radio will give a specific indication to represent the current battery strength. Release the key to exit.

Indication	Battery Strength Icon	Battery Strength
------------	-----------------------	------------------

Green LED glows.		High
Orange LED glows.		Medium
Red LED glows.		Low
Red LED glows and the low battery alert sounds.		Insufficient

Man Down (optional)

With this feature, your radio will alarm automatically to summon help from your companion if it is positioned aslant for a certain time period.

Operation:

1. To enable the feature,
 - Go to “Main Menu -> Settings -> Radio Set-> Man Down” and select “Enable”; or
 - Press the programmed **Man Down** key (a high-pitched tone sounds); or
 - Turn on the radio if the feature is enabled via the programming software.
2. Your radio will sound a pre-alert tone if it is positioned aslant for a preset time period, and will enter the Emergency mode if you do not place it vertically within such time period. To exit the Emergency mode, please place it upright.
3. To disable the feature,
 - Go to “Main Menu -> Settings -> Radio Set-> Man Down” and select “Disable”; or
 - Press the programmed **Man Down** key (a low-pitched tone sounds).

Scrambler /Encrypt

The Scrambler feature can encrypt your audio signals to prevent eavesdropping. Thus privacy of your communication is guaranteed.

This Encrypt feature can encrypt your audio signals and messages to prevent eavesdropping. Thus privacy of your communication is guaranteed.

Operation:

- On an analog channel, go to “Main Menu -> Settings -> Radio Set -> Scrambler” and select “Enable” or “Disable; on a digital channel, go to “Main Menu -> Settings -> Radio Set -> Encrypt” and select “Enable” or “Disable.
- Press the programmed **Scrambler/Encrypt** key to enable Scrambler or Encrypt on the current channel (a high-pitched tone sounds); press the key again to disable the feature (a low-pitched tone sounds).

-
- If the Scrambler/Encrypt feature is enabled for a channel via the programming software, switch to the channel to enable the feature, or exit the channel to disable the feature.

Busy Channel Lockout

If enabled via the programming software, this feature can prevent your radio interfering with other transmitting radios on the same channel. If you hold down the **PTT** key while the channel is in use, your radio will keep beeping and display text information “Channel Busy!”, alerting you to transmission prohibition. To stop beeping, please release the **PTT** key. When the channel is free, you can press and hold down the **PTT** key to transmit.

Time-out Timer (TOT)

The purpose of TOT is to prevent any user from occupying a channel for an extended period. If the preset time expires, the radio will automatically terminate transmission and keep beeping. To stop beeping, please release the **PTT** key. You must wait for a certain time period (preset by your dealer) to initiate another transmission.

If the pre-alert function is set by your dealer, your radio will alert you to the TOT expiration in advance.



Note: This feature is null in Emergency mode.

Pseudo Trunking



This feature can be enabled via the programming software. If your radio operates on a channel with this feature enabled and one time slot is already occupied, it can transmit and receive on the other free time slot, allowing you to communicate timely under emergent situations.

MIC AGC

If enabled via the programming software, your radio will process the audio signals during transmission, providing improved audio for the receiving radio.

Signaling Introduction

The radio supports the following signaling. You can ask your dealer to make appropriate settings on your radio. For detailed information, please contact your dealer.



HDC1200

The HDC1200 signaling is compatible with the MDC1200 signaling, and realizes functions such as PTT ID (Encoding & Decoding), Emergency (Encoding & Decoding) and Selective Call (Encoding & Decoding).

Encoding:

1. Hold down the **PTT** key during normal voice communication to send PTT ID.
2. Go to the menu “Contact List” and select a required contact. Then hold down the **PTT** key to send a selective call (Private Call/Group Call/All Call).

For encoding, the radio will provide the following indications:

- PTT ID/Selective Call: Your dealer can program whether the radio sounds side tone during encoding or sounds beeps after encoding.
- Selective Call: During encoding, the LED glows red, and the LCD displays the appropriate call icon (Private Call: ; Group Call: ; All Call: ). After encoding, the LED glows orange.



Decoding:

For decoding, the radio provides the following indications:

- PTT ID: After decoding, the LCD displays the icon  and ID or alias of the transmitting party.
- Selective Call: After decoding, the radio provides the following indications:

Alert: The radio will sound default alert.

LED: The LED glows green.

LCD: If your dealer enables the feature “Display Decode ID”, the radio will display the appropriate call icon (Private Call: ; Group Call: ; All Call: ) and alias of the transmitting party (ID of the transmitting party will be displayed if it is not in the contact list). If your dealer does not enable the feature “Display Decode ID”, the radio will display the appropriate call icon only.

Troubleshooting

Phenomena	Analysis	Solution
The radio can not be powered on.	The battery may be improperly installed.	Remove the battery and attach it again.
	The battery may run out.	Recharge or replace the battery.
	The battery may suffer from poor contact caused by dirtied or damaged battery contacts.	Clean the battery contacts. If the problem can not be solved, contact your dealer or authorized service center for inspection and repair.
During receiving signals, the voice is weak, discontinuous or totally inactive.	The battery strength may be too low.	Recharge or replace the battery.
	The volume may be set to a low level.	Increase the volume.
	The antenna may get loose or may be improperly installed.	Power off the radio, and re-install the antenna.
	The speaker may be blocked or damaged.	Clean surface of the speaker. If the problem can not be solved, contact your dealer or authorized service center for inspection and repair.
You can not communicate with other members.	The frequency or signaling may be inconsistent with that of other members.	Set your TX/RX frequency and signaling to the same as that of other members.
	The channel type (digital/analog) may be set inconsistently.	Make sure all members are on the same digital/analog channel.

	You may be too far away from the group members.	Move towards other members.
Irrelevant communication or noise is heard on the channel.	You may be interrupted by radios using the same frequency.	Change the frequency, or adjust the squelch level.
	The radio may be set with no signaling.	Set signaling for all member radios to avoid interference at the same frequency.
The noise is too loud.	You may be too far away from other members.	Move towards other members.
	You may be at an unfavorable position. For example, your communication may be blocked by high buildings or frustrated in the underground areas.	Move to an open and flat area, and restart the radio.
	You may suffer from external disturbance (such as electromagnetic interference).	Stay away from equipment that may cause interference.
The GPS cannot locate your position.	No GPS signal is received.	Move to an open and flat area, and try again.

If the above solutions can not fix your problems, or you may have some other queries, please contact us or your local dealer for more technical support.

Care and Cleaning

To guarantee optimal performance as well as a long service life of the product, please follow the tips below.

Product Care

- Do not pierce or scrape the product with any edged instruments or hard objects.
- Keep the product far away from substances that can corrode the circuit.
- Do not hold the product by its antenna or earpiece cable directly.
- Attach the accessory jack cover when the product is not in use.

Product Cleaning

- Clean up the dust and fine particles on the product surface and charging piece with a clean and dry lint-free cloth or a brush regularly.
- Use neutral cleanser and a non-woven fabric to clean the keys, control knobs and front case long-time use. Do not use chemical preparations such as stain removers, alcohol, sprays or oil preparations, so as to avoid surface case damage. Make sure the product is completely dry before use.



Caution: Power off and remove the battery before cleaning.

Optional Accessories

The following items are the main optional accessories for the product, and please consult your local dealer for more other accessories.

			
<p>Remote Speaker Microphone (IP57) SM18N2</p>	<p>Earpiece with on-MIC PTT & Transparent Acoustic Tube EAN16</p>	<p>D-earset with in-line Microphone EHN12</p>	<p>Earbud with on-MIC PTT ESN10</p>
			
<p>3-Wire Surveillance Earpiece with Transparent Acoustic Tube (beige) EAN17</p>	<p>Six-unit Switching Power PS7002</p>	<p>Carrying Case (for thick battery) (leather) (swivel) LCY003</p>	

 **Caution:** Use the accessories specified by Hytera only. If not, Hytera shall not be liable for any losses or damages arising out of use of unauthorized accessories.

Appendix

Input Method

You can enter aliases, numbers or messages using the keypad. The radio supports the following input methods: Chinese Pinyin (simplified), English and Number.

✧ Simplified Chinese Pinyin

Operation:

1. Press  to switch to Chinese Pinyin mode;
2. Enter the pinyin through alphanumeric keys; then a list of possible combinations and corresponding characters will appear;
3. Use the **Up/Down** key to choose the right pinyin;
4. Press the **OK** key to highlight the characters, and choose the right character using the **Up/Down** key;
5. Press the **OK** key to enter the selected character.

You can repeat the above steps to continue.

✧ English



Operation:

1. Press  to switch to uppercase English or lowercase English mode;
2. Enter the English letters through alphanumeric keys; then a list of possible letters will appear;
3. Use the **Up/Down** key to choose the right letter;
4. Press the **OK** key to enter the selected letter.

You can repeat the above steps to continue.

✧ Number

Operation:

1. Press  to switch to Number mode;
2. Enter the numbers through alphanumeric keys  to .

✧ Special Character

To enter common punctuations and special characters, press .

To input a space, press .



Note: You can use the **Up/Down** key to move the cursor leftward/rightward in the entered text.