

12.5 KHz Channel Separation

Modulation Level(dB)	Peak Freq. Deviation At 300 Hz(KHz)	Peak Freq. Deviation At 1004 H(KHz)	Peak Freq. Deviation At 1500 Hz(KHz)	Peak Freq. Deviation At 2500 Hz(KHz)
-20	0.06	0.16	0.21	0.36
-15	0.18	0.25	0.51	0.53
-10	0.18	0.44	1.25	1.02
-5	0.23	0.85	1.76	2.01
0	0.45	1.52	2.05	2.04
+5	0.48	1.55	2.28	2.05
+10	0.45	1.58	2.24	2.06
+15	0.57	2.25	2.21	2.08
+20	1.05	2.24	2.22	2.09

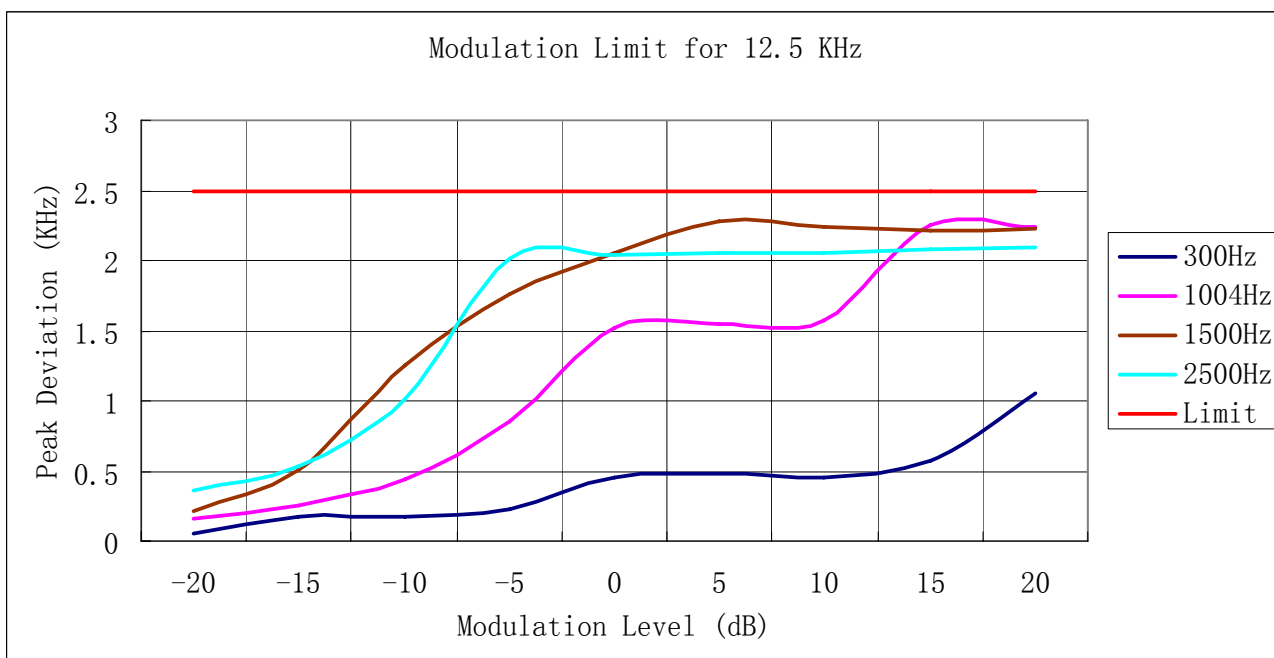

Modulation type: 4FSK

Channel bandwidth: 12.5 kHz

It is not applicable for devices which operate with the digitized voice/data modulation type.

b). Audio Frequency Response:**Rule Part No.: Part 2.1407(a) (b)****Method of Measurement:**

The audio frequency response was measured in accordance with TIA/EIA Specification 603 with no exception. A curve or equivalent data showing the frequency response of the audio modulating circuit over a range of 300-3000Hz shall be submitted and Audio Post Limiter Low Pass Filter Response from 3.0 KHz to 50KHz. However, the audio frequency response should test from 100Hz to 5.0 KHz according to FCC Part 90.

Modulation Type: FM

The audio frequency response curve is show below.and

Test Audio Level (1 KHz and 20% maximum deviation) for 25 KHz channel separation is 2.28mv and 2.28mv for 12.5 KHz channel separation.

Note:

- 1 Not applicable to new standard. However, tests are conducted under FCC's recommendation.
- 2 The Audio Frequency Response is identical for 12.5 KHz and 25 KHz channel separation

For 25 KHz

Frequency (KHz)	Frequency Deviation (KHz)	1KHz Reference Deviation (KHz)	Audio Frequency Response (dB)
0.1	0.06	1.07	-25.02
0.2	0.07	1.07	-23.69
0.3	0.30	1.07	-11.05
0.4	0.38	1.07	-8.99
0.5	0.50	1.07	-6.61
0.6	0.63	1.07	-4.60
0.7	0.75	1.07	-3.09
0.8	0.88	1.07	-1.70
0.9	0.97	1.07	-0.85
1.0	1.07	1.07	0.00
1.2	1.27	1.07	1.49
1.4	1.54	1.07	3.16
1.6	1.76	1.07	4.32
1.8	2.00	1.07	5.43
2.0	2.25	1.07	6.46
2.2	2.45	1.07	7.20
2.4	2.73	1.07	8.14
2.6	2.79	1.07	8.32
2.7	2.98	1.07	8.90
2.8	3.09	1.07	9.21
3.0	3.32	1.07	9.84
3.5	0.06	1.07	-25.02
4.0	0.06	1.07	-25.02
4.5	0.05	1.07	-26.61
5.0	0.05	1.07	-26.61

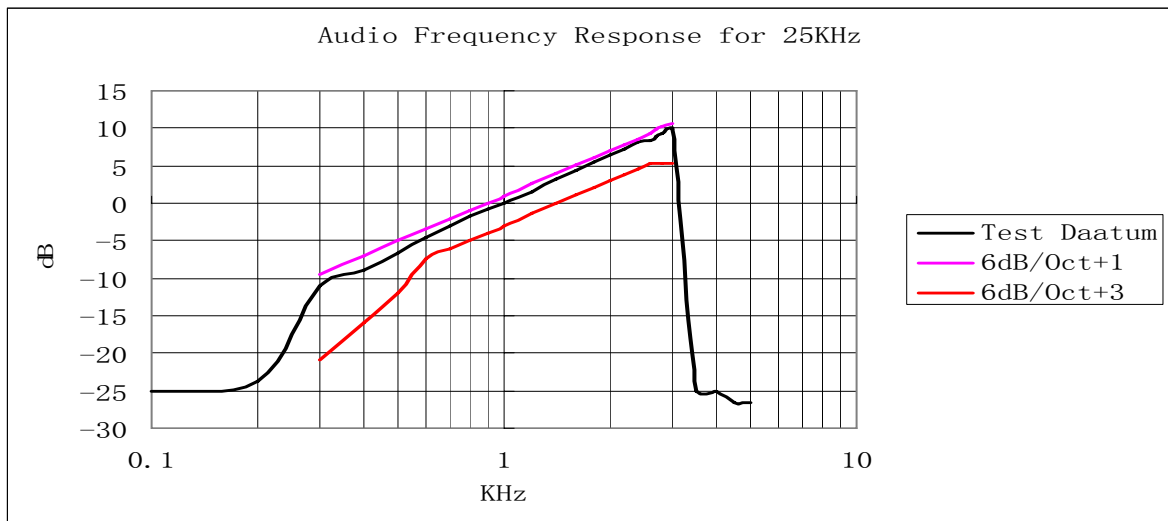

For 12.5 KHz

Frequency (KHz)	Frequency Deviation (KHz)	1KHz Refenerce Deviation (KHz)	Audio Frequency Response (dB)
0.1	0.04	0.58	-23.23
0.2	0.03	0.58	-25.73
0.3	0.14	0.58	-12.35
0.4	0.21	0.58	-8.82
0.5	0.27	0.58	-6.64
0.6	0.37	0.58	-3.90
0.7	0.38	0.58	-3.67
0.8	0.44	0.58	-2.40
0.9	0.49	0.58	-1.46
1.0	0.58	0.58	0.00
1.2	0.67	0.58	1.25
1.4	0.84	0.58	3.22
1.6	0.90	0.58	3.82
1.8	1.02	0.58	4.90
2.0	1.09	0.58	5.48
2.2	1.24	0.58	6.60
2.4	1.33	0.58	7.21
2.6	1.41	0.58	7.72
2.7	1.64	0.58	9.03
2.8	1.62	0.58	8.92
3.0	1.47	0.58	8.08
3.5	0.04	0.58	-23.23
4.0	0.04	0.58	-23.23
4.5	0.04	0.58	-23.23
5.0	0.04	0.58	-23.23

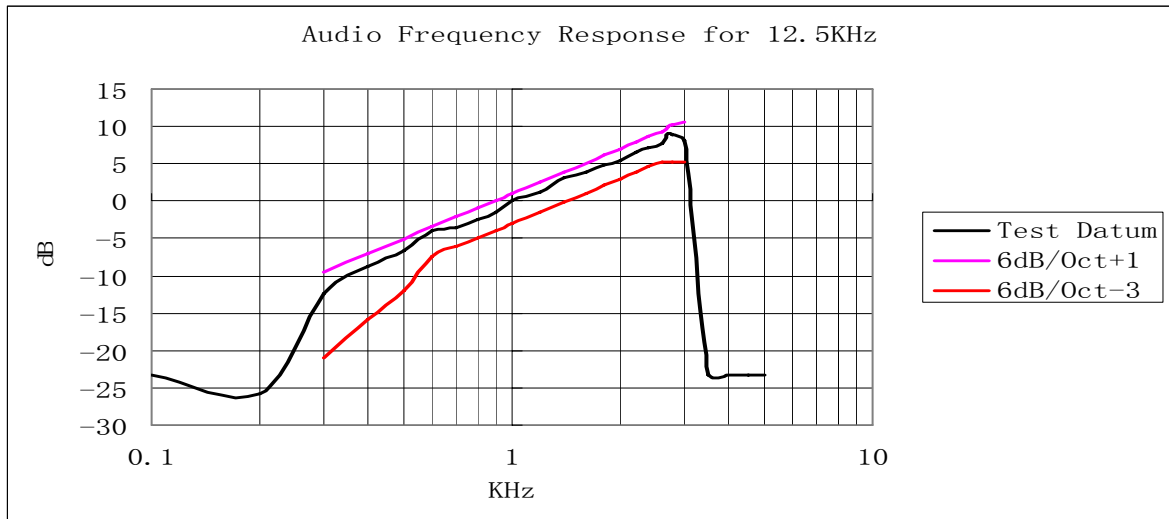

Modulation type: 4FSK

Channel bandwidth: 12.5 kHz

It is not applicable for devices which operate with the digitized voice/data modulation type.

4.6. Frequency Stability Test

TEST APPLICABLE

- 1 According to FCC Part 2 Section 2.1055 (a)(1), the frequency stability shall be measured with variation of ambient temperature from -30°C to $+60^{\circ}\text{C}$ centigrade.
- 2 According to FCC Part 2 Section 2.1055 (a) (2), for battery powered equipment, the frequency stability shall be measured with reducing primary supply voltage to the battery operating end point, which is specified by the manufacture.
- 3 Vary primary supply voltage from 85 to 115 percent of the nominal value for other than hand carried battery equipment.
- 4 According to §90.213, the frequency stability limit is 2.5 ppm for 806-809MHz/851-854MHz/896-901MHz/935-940MHz and 1.5ppm for 809-824MHz/854-869MHz.
- 5 According to Section 5.3 of RSS-119, the frequency stability limit is 1.5 ppm for 806-809MHz/851-854MHz/896-901MHz/935-940MHz and 809-824MHz/854-869MHz of 12.5KHz channel separation while 2.5ppm for 806-824MHz/851-869MHz of 25KHz channel separation.

TEST PROCEDURE

The EUT was set in the climate chamber and connected to an external DC power supply. The RF output was directly connected to Spectrum Analyzer ESI 26. The coupling loss of the additional cables was recorded and taken in account for all the measurements. After temperature stabilization (approx. 20 min for each stage), the frequency for the lower, the middle and the highest frequency range was recorded. For Frequency stability Vs. Voltage the EUT was connected to a DC power supply and the voltage was adjusted in the required ranges. The result was recorded.

TEST CONFIGURATION

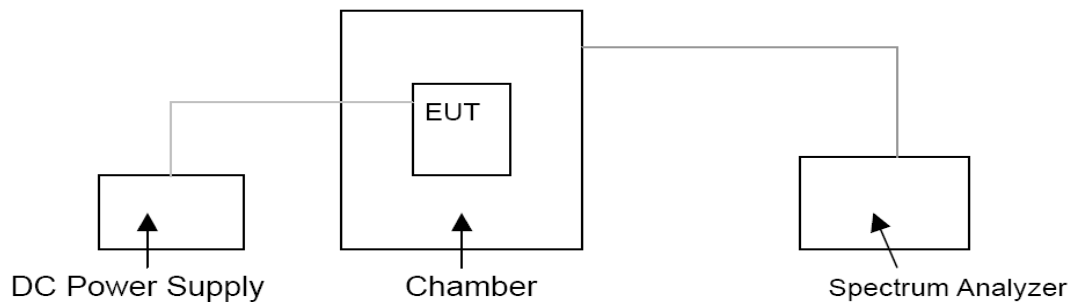

TEST LIMITS

According to 90.213, Transmitters used must have minimum frequency stability as specified in the following table.

Frequency range (MHz)	Fixed and base stations	Mobile stations	
		Over 2 watts output power	2 watts or less output power
Below 25	1,2,3 100	100	200
25-50	20	20	50
72-76	5	-----	50
150-174	5,11 5	5	4,6 50
216-220	1.0	-----	1.0
220-222 ¹²	0.1	1.5	1.5
421-512	7,11,14 2.5	5	5
806-809	¹⁴ 1.0	1.5	1.5
809-824	¹⁴ 1.5	2.5	2.5
851-854	1.0	1.5	1.5
854-869	1.5	2.5	2.5
896-901	¹⁴ 0.1	1.5	1.5
902-928	2.5	2.5	2.5
902-928 ¹³	2.5	2.5	2.5
929-930	1.5	-----	-----
935-940	0.1	1.5	1.5
1427-1435	300	300	300
Above 2450 ¹⁰	-----	-----	-----

According to section 5.3, Transmitters used must have minimum frequency stability as specified in the following table.

Frequency Band (MHz)	Channel Spacing (kHz)	Frequency Stability (ppm)		
		Base/Fixed	Mobile Station	
			>2 watts	≤ 2 watts
27.41-28 and 29.7-50	20	20	20	50
72-76	20	5	20	50
138-174	30	5	5	5
	15	2.5	5	5
	7.5	1	2	5
217-218 and 219-220	12.5	1	5	5
220-222 (Note 1)	5	0.1	1.5	1.5
406.1-430 and 450-470 (Note 6)	25 (Note 2)	0.5	1	1
	25	2.5	5	5
	12.5	1.5	2.5	2.5
	6.25	0.5	1	1
764-776 and 794-806 (Note 3)	6.25	0.1	0.4 (Note 4)	0.4 (Note 4)
	12.5			
	25			
	50	1	1.25 (Note 5)	1.25 (Note 5)
806-821/851-866 and 821-824/866-869 (Note 6)	25 (Note 2)	0.1	0.1	0.1
	25	1.5	2.5	2.5
	12.5	1	1.5	1.5
896-901/935-940 (Note 6)	12.5	0.1	1.5	1.5
929-930/931-932	25	1.5	N/A	N/A
928-929/952-953 and 932-932.5/941-941.5	25	1.5	N/A	N/A
	12.5	1	³ (for remote station)	N/A
932.5-935/941.5-944	25	2.5	N/A	N/A
	12.5	2.5	N/A	N/A

TEST RESULTS

Modulation Type	Channel Separation	Test conditions		Frequency error (ppm)		
		Voltage(V)	Temp(°C)	806.5MHz	817.0MHz	823.5MHz
Analog/FM	25KHz	7.40	-30	1.07	1.04	0.94
			-20	1.03	1.07	0.97
			-10	0.99	0.97	0.90
			0	0.88	0.74	0.79
			10	0.75	0.69	0.68
			20	0.64	0.64	0.70
			30	0.67	0.66	0.67
			40	0.77	0.76	0.63
			50	0.91	0.88	0.73
			6.29 (85% Rated)	20	0.66	0.77
		8.51 (115% Rated)	20	0.68	0.71	0.65
Limit for FCC				1.50	2.50	2.50
Limit for IC				2.50	2.50	2.50
Conclusion			Complies			

Modulation Type	Channel Separation	Test conditions		Frequency error (ppm)		
		Voltage(V)	Temp(°C)	851.5MHz	860.0MHz	868.5MHz
Analog/FM	25KHz	7.40	-30	0.98	1.00	0.94
			-20	0.93	0.86	0.86
			-10	0.91	0.88	0.94
			0	0.80	0.74	0.76
			10	0.65	0.56	0.64
			20	0.53	0.58	0.54
			30	0.58	0.57	0.58
			40	0.63	0.66	0.53
			50	0.80	0.66	0.65
			6.29 (85% Rated)	20	0.56	0.58
		8.51 (115% Rated)	20	0.68	0.58	0.58
Limit for FCC				1.50	2.50	2.50
Limit for IC				2.50	2.50	2.50
Conclusion			Complies			

Modulation Type	Channel Separation	Test conditions		Frequency error (ppm)		
		Voltage(V)	Temp(°C)	806.5MHz	817.0MHz	823.5MHz
Analog/FM	12.5KHz	7.40	-30	1.04	1.04	1.00
			-20	1.06	1.03	0.96
			-10	1.05	1.01	0.88
			0	0.87	0.88	0.75
			10	0.82	0.65	0.79
			20	0.69	0.64	0.56
			30	0.64	0.64	0.66
			40	0.76	0.73	0.66
			50	0.83	0.84	0.8
			6.29 (85% Rated)	20	0.67	0.68
		8.51 (115% Rated)	20	0.68	0.72	0.64
Limit for FCC				1.50	2.50	2.50
Limit for IC				1.50	1.50	1.50
Conclusion			Complies			

Modulation Type	Channel Separation	Test conditions		Frequency error (ppm)		
		Voltage(V)	Temp(°C)	851.5MHz	860.0MHz	868.5MHz
Analog/FM	12.5KHz	7.40	-30	0.97	0.94	0.98
			-20	0.99	0.96	0.93
			-10	1.01	0.92	0.94
			0	0.73	0.81	0.77
			10	0.66	0.68	0.64
			20	0.58	0.54	0.58
			30	0.57	0.53	0.61
			40	0.70	0.66	0.63
			50	0.77	0.68	0.63
			6.29 (85% Rated)	20	0.61	0.67
		8.51 (115% Rated)	20	0.58	0.55	0.69
Limit for FCC				1.50	2.50	2.50
Limit for IC				1.50	1.50	1.50
Conclusion			Complies			

Modulation Type	Channel Separation	Test conditions		Frequency error (ppm)	
		Voltage(V)	Temp(°C)	896.5MHz	900.5MHz
Analog/FM	12.5KHz	7.40	-30	0.88	0.87
			-20	0.83	0.89
			-10	0.70	0.81
			0	0.60	0.63
			10	0.48	0.55
			20	0.46	0.45
			30	0.47	0.47
			40	0.56	0.57
			50	0.67	0.71
			6.29 (85% Rated)	20	0.48
		8.51 (115% Rated)	20	0.52	0.48
Limit for FCC				1.50	1.50
Limit for IC				1.50	1.50
Conclusion			Complies		

Modulation Type	Channel Separation	Test conditions		Frequency error (ppm)	
		Voltage(V)	Temp(°C)	935.5MHz	939.5MHz
Analog/FM	12.5KHz	7.40	-30	0.82	0.78
			-20	0.73	0.80
			-10	0.69	0.71
			0	0.53	0.6
			10	0.45	0.48
			20	0.47	0.39
			30	0.48	0.34
			40	0.46	0.42
			50	0.68	0.64
			6.29 (85% Rated)	20	0.44
		8.51 (115% Rated)	20	0.59	0.35
Limit for FCC				1.50	1.50
Limit for IC				1.50	1.50
Conclusion			Complies		

Modulation Type	Channel Separation	Test conditions		Frequency error (ppm)		
		Voltage(V)	Temp(°C)	806.5MHz	817.0MHz	823.5MHz
Digital/4FSK	12.5KHz	7.40	-30	1.02	1.04	1.04
			-20	0.93	0.93	0.92
			-10	1.01	0.87	0.88
			0	0.88	0.83	0.73
			10	0.81	0.78	0.76
			20	0.62	0.67	0.64
			30	0.59	0.68	0.64
			40	0.57	0.80	0.62
			50	0.88	0.90	0.74
			6.29 (85% Rated)	20	0.70	0.63
		8.51 (115% Rated)	20	0.68	0.65	0.64
Limit for FCC				1.50	2.50	2.50
Limit for IC				1.50	1.50	1.50
Conclusion			Complies			

Modulation Type	Channel Separation	Test conditions		Frequency error (ppm)		
		Voltage(V)	Temp(°C)	851.5MHz	860.0MHz	868.5MHz
Digital/4FSK	12.5KHz	7.40	-30	0.98	1.00	0.97
			-20	0.96	0.96	0.89
			-10	0.94	0.91	0.91
			0	0.9	0.76	0.80
			10	0.82	0.68	0.68
			20	0.57	0.54	0.56
			30	0.56	0.58	0.53
			40	0.63	0.63	0.66
			50	0.73	0.77	0.78
			6.29 (85% Rated)	20	0.68	0.61
		8.51 (115% Rated)	20	0.72	0.72	0.71
Limit for FCC				1.50	2.50	2.50
Limit for IC				1.50	1.50	1.50
Conclusion			Complies			

Modulation Type	Channel Separation	Test conditions		Frequency error (ppm)	
		Voltage(V)	Temp(°C)	896.5MHz	900.5MHz
Digital/4FSK	12.5KHz	7.40	-30	0.86	0.86
			-20	0.82	0.85
			-10	0.78	0.84
			0	0.67	0.66
			10	0.55	0.57
			20	0.48	0.47
			30	0.44	0.47
			40	0.56	0.59
			50	0.67	0.70
			6.29 (85% Rated)	20	0.43
		8.51 (115% Rated)	20	0.44	0.48
Limit for FCC				1.50	1.50
Limit for IC				1.50	1.50
Conclusion			Complies		

Modulation Type	Channel Separation	Test conditions		Frequency error (ppm)	
		Voltage(V)	Temp(°C)	935.5MHz	939.5MHz
Digital/4FSK	12.5KHz	7.40	-30	0.87	0.87
			-20	0.73	0.76
			-10	0.71	0.74
			0	0.58	0.60
			10	0.62	0.51
			20	0.47	0.41
			30	0.50	0.4
			40	0.46	0.46
			50	0.64	0.83
			6.29 (85% Rated)	20	0.47
		8.51 (115% Rated)	20	0.51	0.41
		Limit for FCC			
Limit for IC				1.50	1.50
Conclusion			Complies		

4.7. Maximum Transmitter Power

TEST APPLICABLE

Per FCC «2.1046 and «90.205: Maximum ERP is dependent upon the station’s antenna HAAT and required service area.

Per RSS-119 Section 5.4 and 5.4.1: The output power shall be within ±1.0 dB of the manufacturer’s rated power. Typical transmitter output powers are 110 watts for base and/or fixed stations (paging transmitters excepted), and 30 watts for mobile stations. Higher powers may be certified, but it should be noted that mobile stations are normally only licensed up to 30 watts. See the SRSP relevant to the operating frequency for equipment power limits.

TEST PROCEDURE

Measurements shall be made to establish the radio frequency power delivered by the transmitter the standard output termination. The power output shall be monitored and recorded and no adjustment shall be made to the transmitter after the test has begun, except as noted below:

If the power output is adjustable, measurements shall be made for the highest and lowest power levels.

The EUT connect to the Receiver through 20 dB attenuator.

Measurement with Spectrum Analyzer FSP40 or Aglient E4407B conducted, external power supply with 13.60 V stabilized supply voltage.

TEST CONFIGURATION

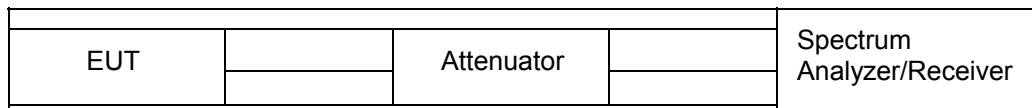

The EUT was directly connected to a RF Communication Test set by a 20 dB attenuator

TEST RESULTS

Frequency Range (MHz)	Modulation Type	Channel Separation (KHz)	Test Channel	Maximum Output Power Test Results (dBm)	
				Rated High Power	Rated Low Power
806-825	Analog/FM	25	Low	35.17	30.80
			Middle	34.94	30.81
			High	34.80	30.38
		12.5	Low	35.21	30.41
			Middle	34.98	30.81
			High	34.87	30.52
	Digital/4FSK	12.5	Low	35.23	30.68
			Middle	34.98	30.81
			High	34.90	30.49
851-870	Analog/FM	25	Low	35.02	30.92
			Middle	35.02	30.95
			High	35.07	30.37
		12.5	Low	35.09	30.92
			Middle	35.09	30.99
			High	35.05	30.39
	Digital/4FSK	12.5	Low	35.04	30.21
			Middle	35.11	30.26
			High	35.11	30.39
896-902	Analog/FM	12.5	Low	34.31	30.54
			High	34.38	30.62
	Digital/4FSK		Low	34.51	30.78
			High	34.44	30.76
935-941	Analog/FM	12.5	Low	34.36	30.61
			High	34.16	30.56
	Digital/4FSK		Low	34.37	30.33
			High	34.32	30.30
Limit	FCC:The limit is dependent upon the station’s antenna HAAT and required service area. IC:The output power shall be within ±1.0 dB of the manufacturer’s rated power.				
Test Results	Compliance				

Plots of Maximum Transmitter Power Measurement

Modulation Type	Channel Separation	Freq.(MHz)	Rated Power (Watt)	Measurement (dBm)	FCC Limit	IC Limit (dB)	Results
FM	25 KHz	806.5000	3	35.17	Varies	34.77 ± 1	Complicance

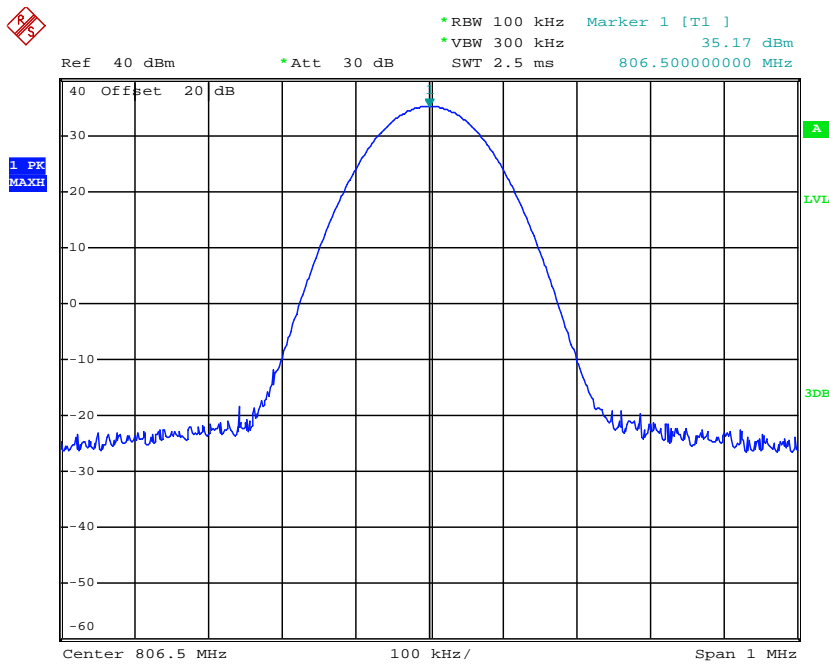

Date: 1.APR.2013 14:21:38

Modulation Type	Channel Separation	Freq.(MHz)	Rated Power (Watt)	Measurement (dBm)	FCC Limit	IC Limit (dB)	Results
FM	25 KHz	817.0000	3	34.94	Varies	34.77 ± 1	Complicance

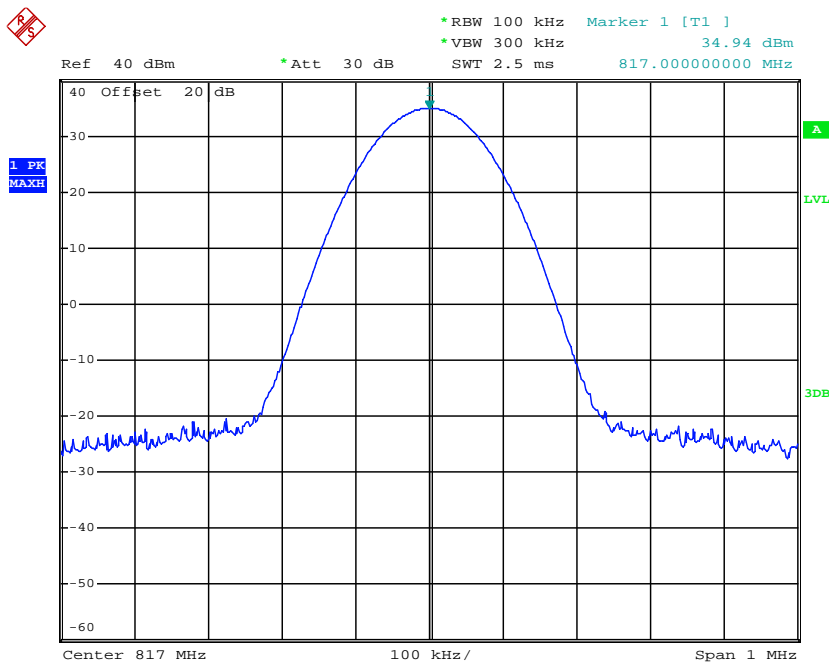

Date: 1.APR.2013 14:24:23

Modulation Type	Channel Separation	Freq.(MHz)	Rated Power (Watt)	Measurement (dBm)	FCC Limit	IC Limit (dB)	Results
FM	25 KHz	823.5000	3	34.80	Varies	34.77 ± 1	Compliance

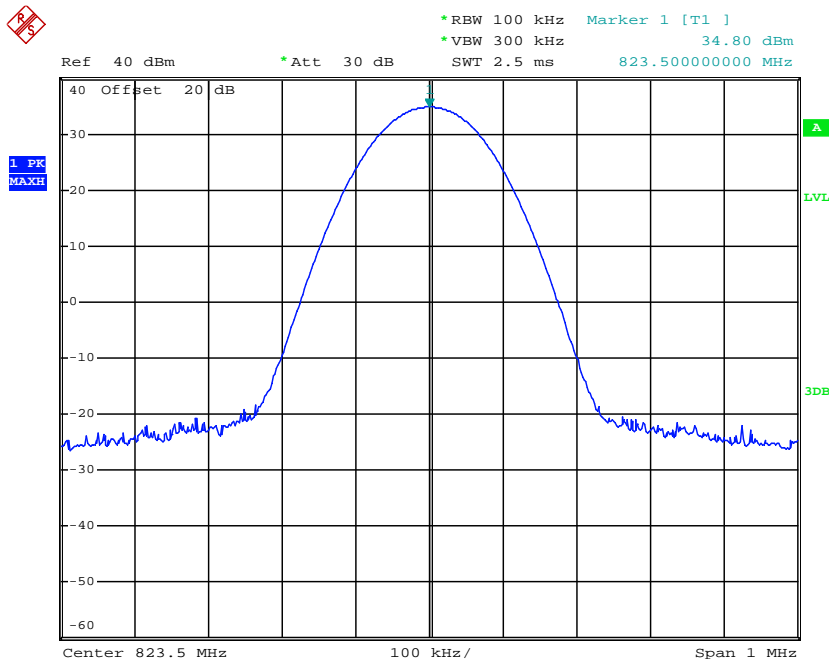

Date: 1.APR.2013 14:24:58

Modulation Type	Channel Separation	Freq.(MHz)	Rated Power (Watt)	Measurement (dBm)	FCC Limit	IC Limit (dB)	Results
FM	25 KHz	851.5000	3	35.02	Varies	34.77 ± 1	Compliance

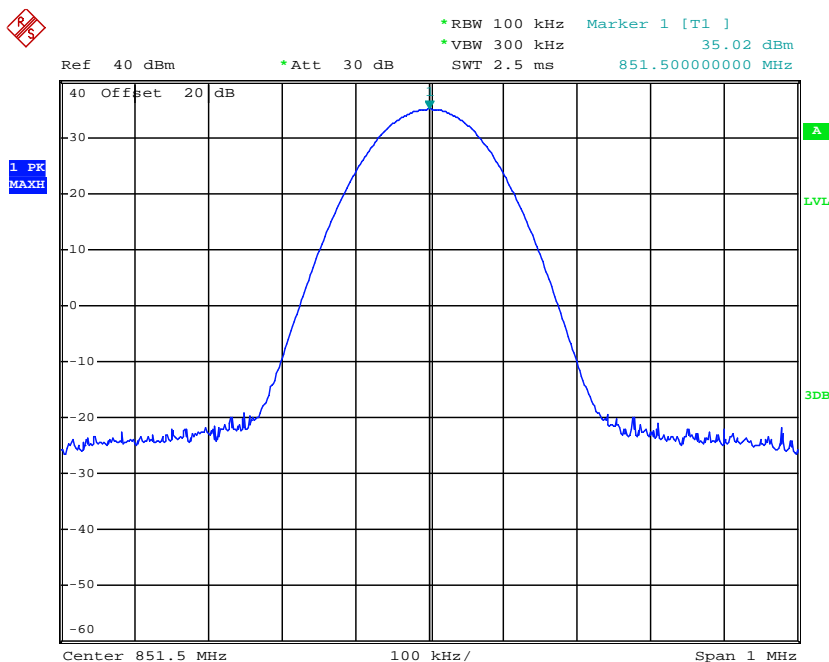

Date: 1.APR.2013 15:05:33

Modulation Type	Channel Separation	Freq.(MHz)	Rated Power (Watt)	Measurement (dBm)	FCC Limit	IC Limit (dB)	Results
FM	25 KHz	860.0000	3	35.02	Varies	34.77±1	Complicance

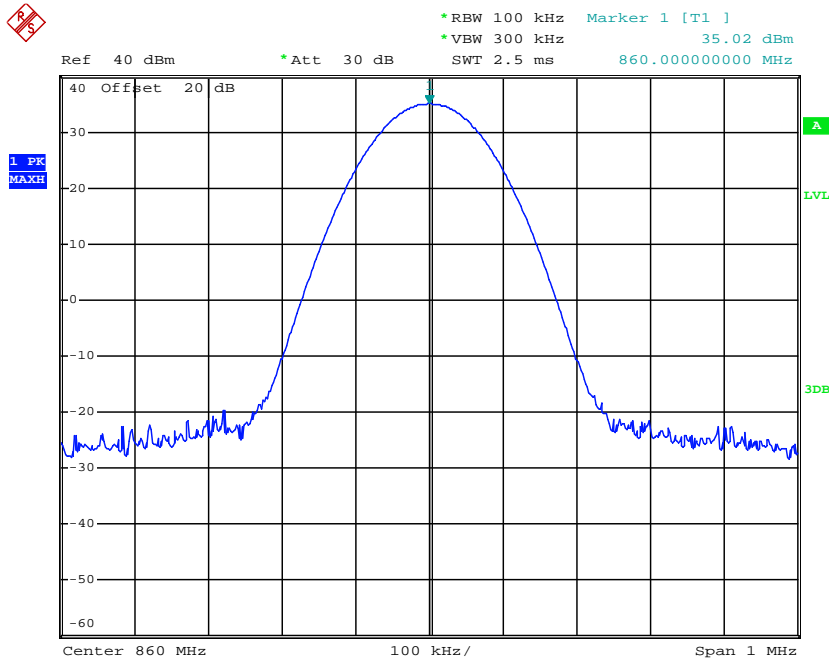

Date: 1.APR.2013 15:06:56

Modulation Type	Channel Separation	Freq.(MHz)	Rated Power (Watt)	Measurement (dBm)	FCC Limit	IC Limit (dB)	Results
FM	25 KHz	868.5000	3	35.07	Varies	34.77±1	Complicance

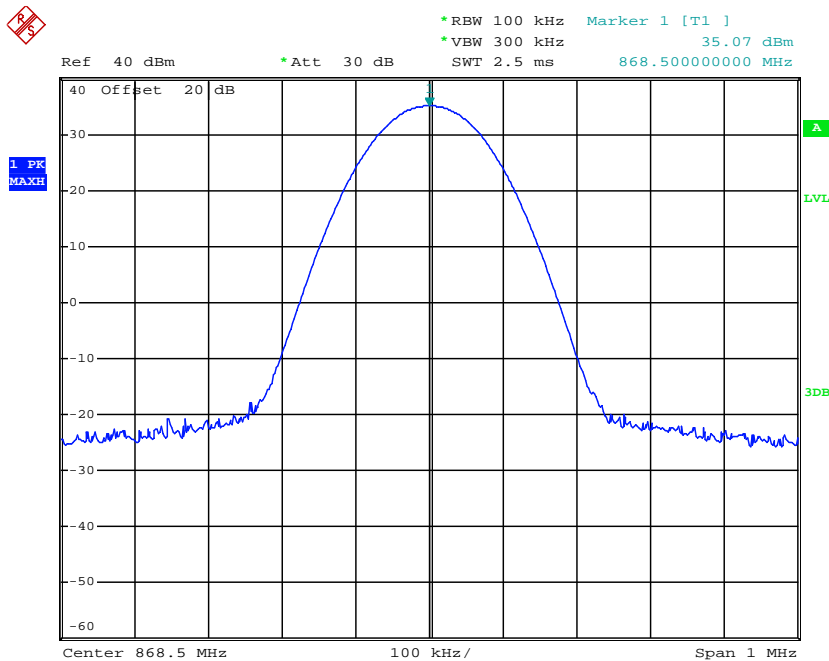

Date: 1.APR.2013 15:09:02

Modulation Type	Channel Separation	Freq.(MHz)	Rated Power (Watt)	Measurement (dBm)	FCC Limit	IC Limit (dB)	Results
FM	12.5 KHz	806.5000	3	35.21	Varies	34.77±1	Complicance

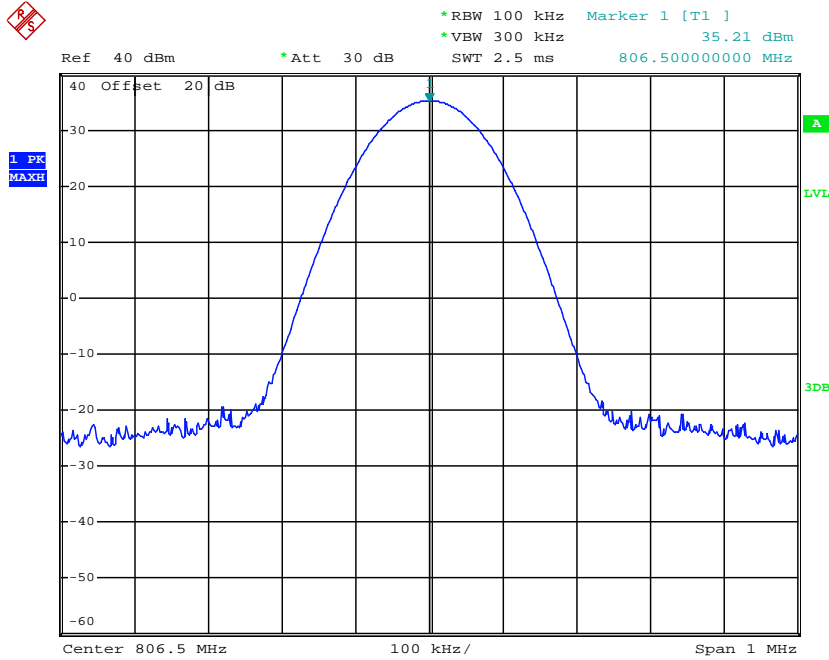

Date: 1.APR.2013 14:19:16

Modulation Type	Channel Separation	Freq.(MHz)	Rated Power (Watt)	Measurement (dBm)	FCC Limit	IC Limit (dB)	Results
FM	12.5 KHz	817.0000	3	34.98	Varies	34.77±1	Complicance

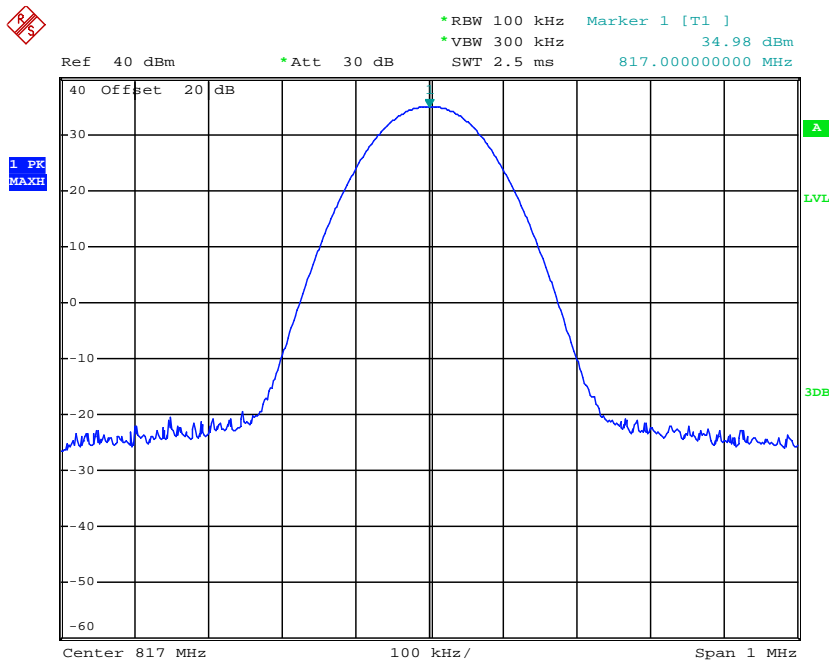

Date: 1.APR.2013 14:20:00

Modulation Type	Channel Separation	Freq.(MHz)	Rated Power (Watt)	Measurement (dBm)	FCC Limit	IC Limit (dB)	Results
FM	12.5 KHz	823.5000	3	34.87	Varies	34.77 ± 1	Complicance

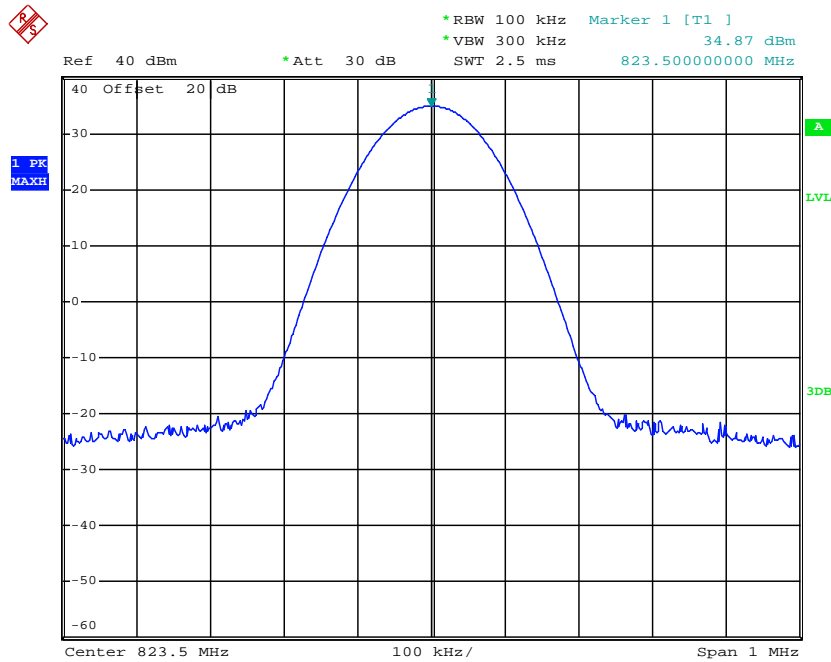

Date: 1.APR.2013 14:20:56

Modulation Type	Channel Separation	Freq.(MHz)	Rated Power (Watt)	Measurement (dBm)	FCC Limit	IC Limit (dB)	Results
FM	12.5 KHz	851.5000	3	35.09	Varies	34.77 ± 1	Complicance

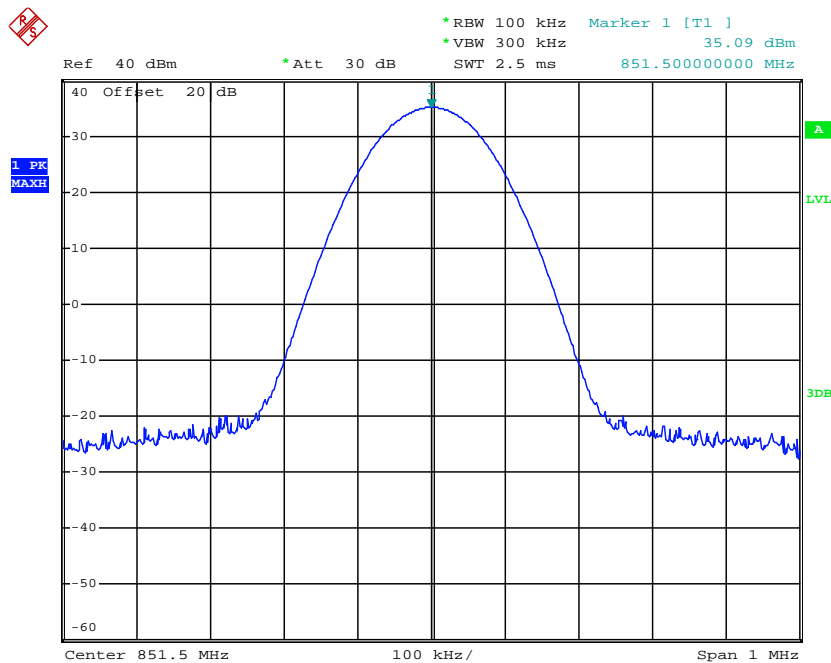

Date: 1.APR.2013 15:02:34

Modulation Type	Channel Separation	Freq.(MHz)	Rated Power (Watt)	Measurement (dBm)	FCC Limit	IC Limit (dB)	Results
FM	12.5 KHz	860.0000	3	35.09	Varies	34.77±1	Compliance

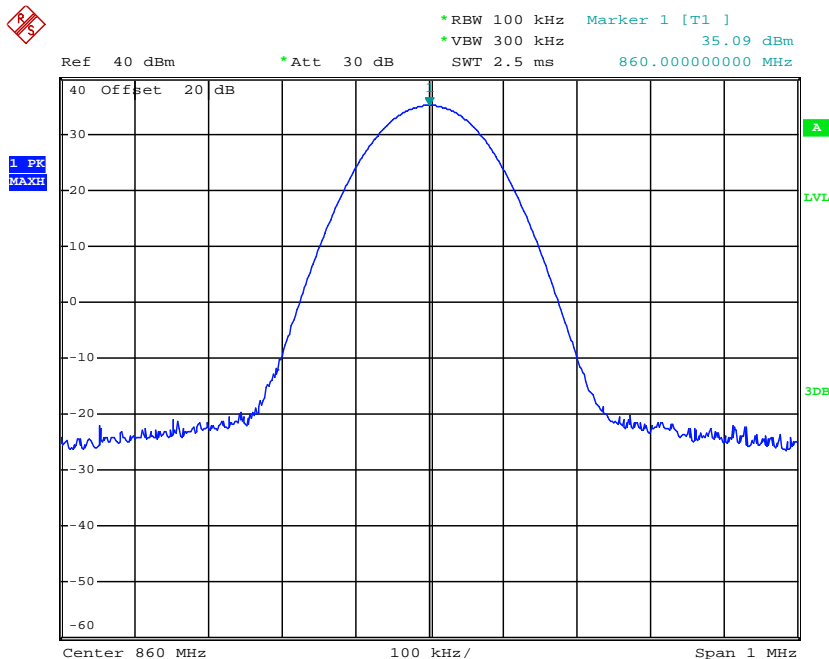

Date: 1.APR.2013 15:03:21

Modulation Type	Channel Separation	Freq.(MHz)	Rated Power (Watt)	Measurement (dBm)	FCC Limit	IC Limit (dB)	Results
FM	12.5 KHz	868.5000	3	35.05	Varies	34.77±1	Compliance

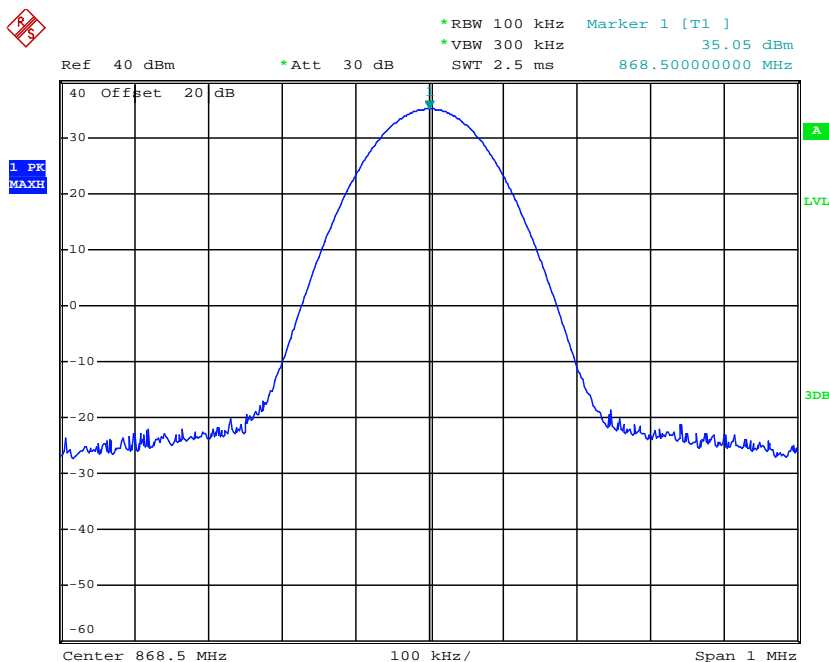

Date: 1.APR.2013 15:04:42

Modulation Type	Channel Separation	Freq.(MHz)	Rated Power (Watt)	Measurement (dBm)	FCC Limit	IC Limit (dB)	Results
FM	12.5 KHz	896.5000	2.5	34.31	Varies	33.98±1	Complicance

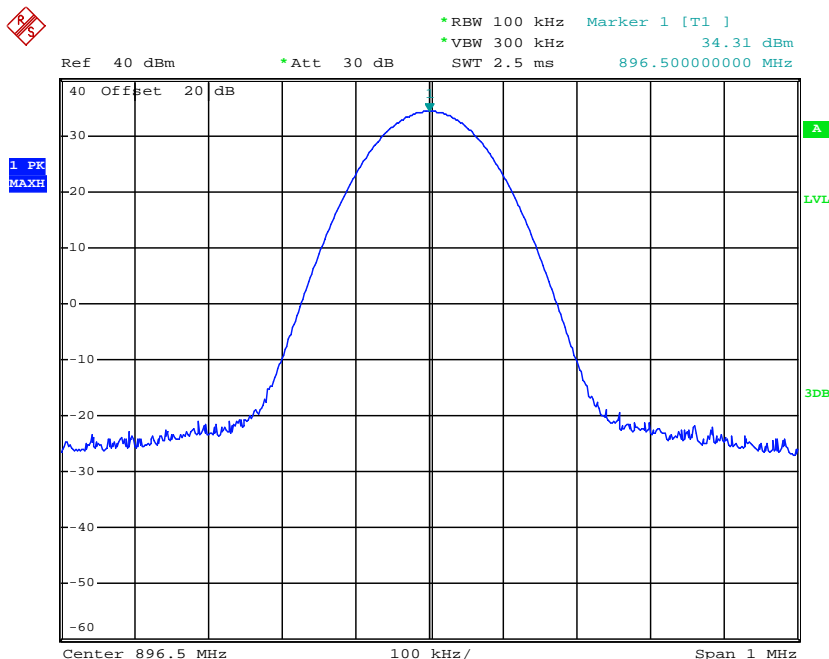

Date: 1.APR.2013 14:30:34

Modulation Type	Channel Separation	Freq.(MHz)	Rated Power (Watt)	Measurement (dBm)	FCC Limit	IC Limit (dB)	Results
FM	12.5 KHz	900.5000	2.5	34.38	Varies	33.98±1	Complicance

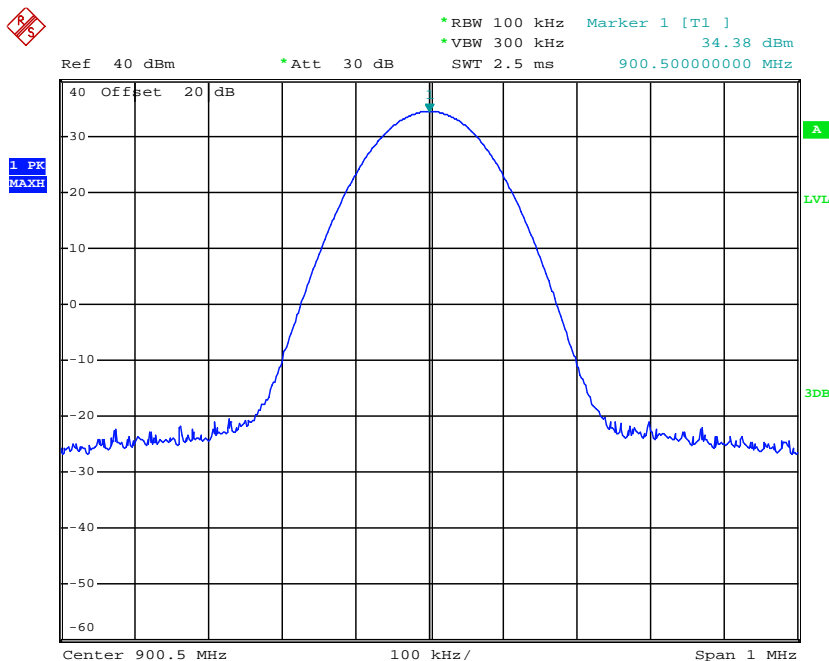

Date: 1.APR.2013 14:31:45

Modulation Type	Channel Separation	Freq.(MHz)	Rated Power (Watt)	Measurement (dBm)	FCC Limit	IC Limit (dB)	Results
FM	12.5 KHz	935.5000	2.5	34.36	Varies	33.98±1	Complicance

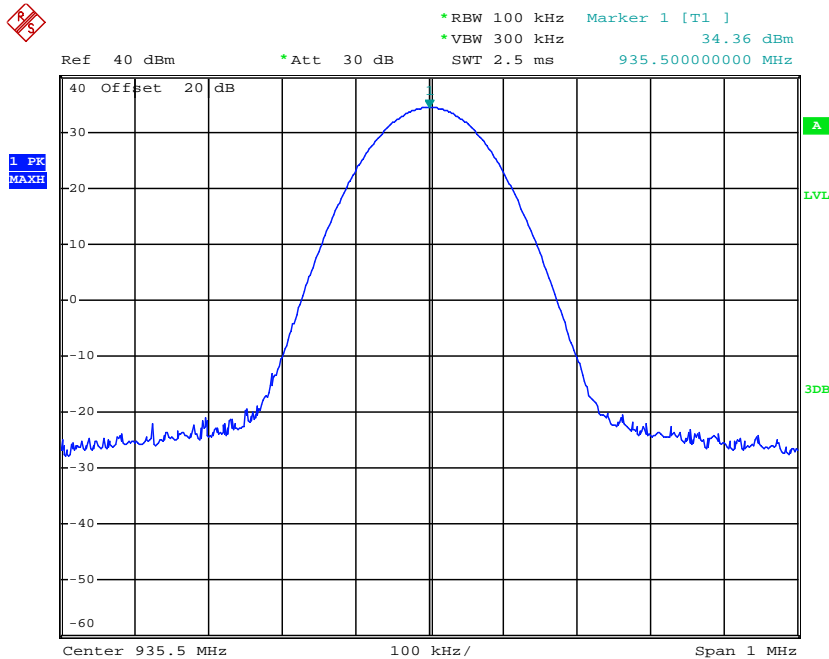

Date: 1.APR.2013 15:13:00

Modulation Type	Channel Separation	Freq.(MHz)	Rated Power (Watt)	Measurement (dBm)	FCC Limit	IC Limit (dB)	Results
FM	12.5 KHz	939.5000	2.5	34.16	Varies	33.98±1	Complicance

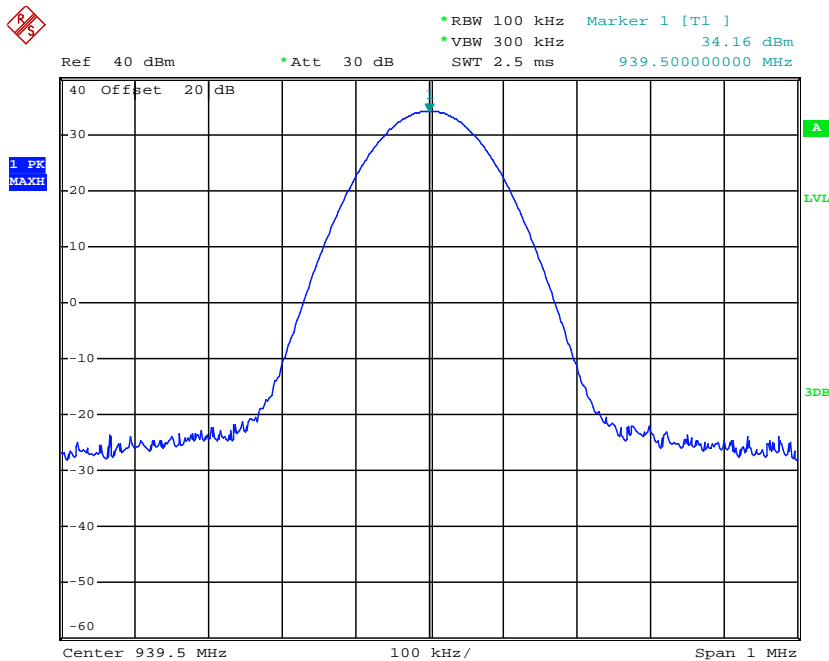

Date: 1.APR.2013 15:13:48

Modulation Type	Channel Separation	Freq.(MHz)	Rated Power (Watt)	Measurement (dBm)	FCC Limit	IC Limit (dB)	Results
4FSK	12.5 KHz	806.5000	3	35.23	Varies	34.77 ± 1	Compliance

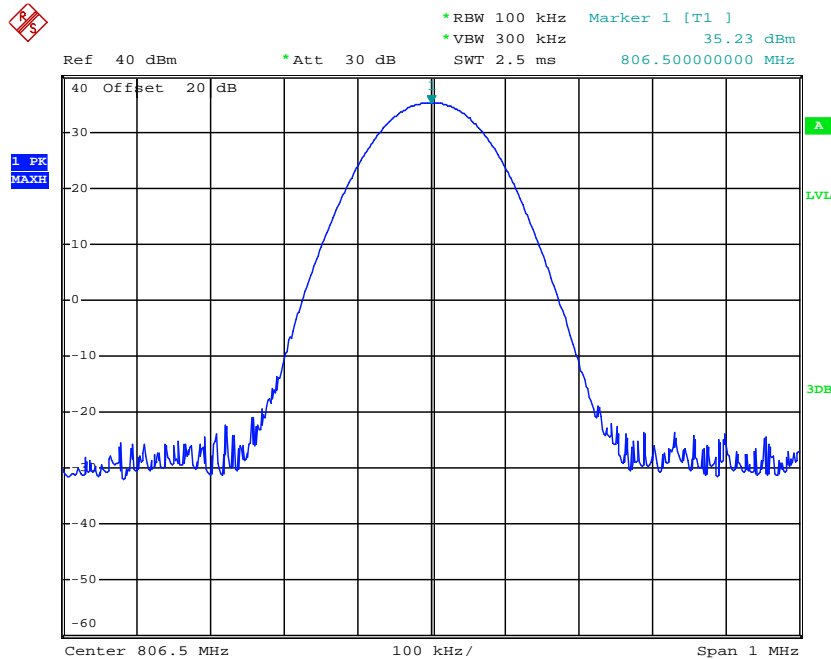

Date: 1.APR.2013 14:26:25

Modulation Type	Channel Separation	Freq.(MHz)	Rated Power (Watt)	Measurement (dBm)	FCC Limit	IC Limit (dB)	Results
4FSK	12.5 KHz	817.0000	3	34.98	Varies	34.77 ± 1	Compliance

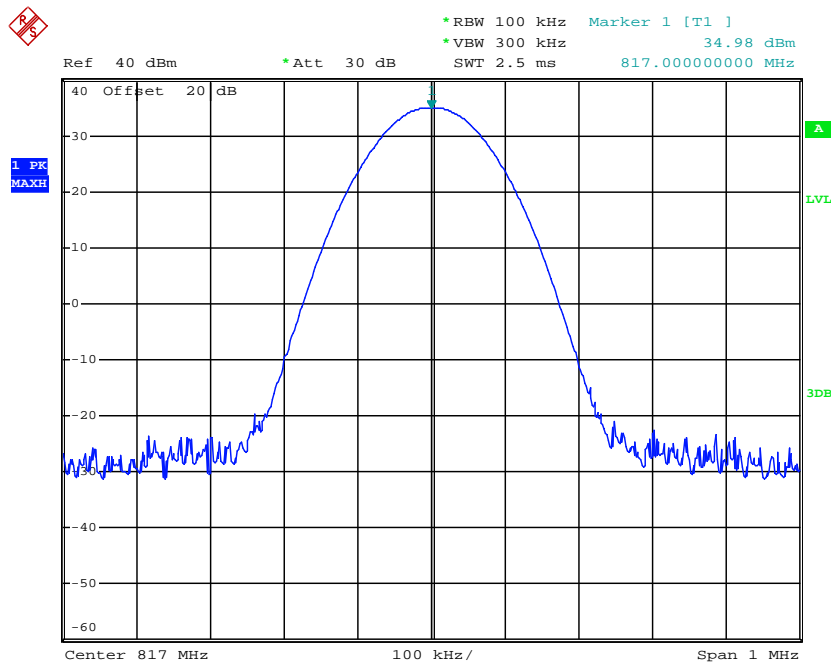

Date: 1.APR.2013 14:27:36

Modulation Type	Channel Separation	Freq.(MHz)	Rated Power (Watt)	Measurement (dBm)	FCC Limit	IC Limit (dB)	Results
4FSK	12.5 KHz	823.5000	3	34.90	Varies	34.77±1	Compliance

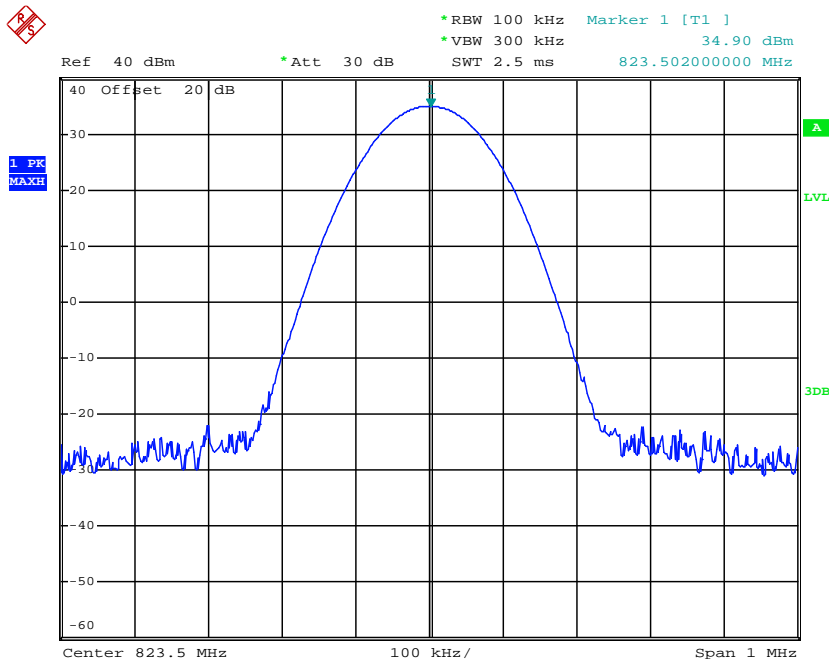

Date: 1.APR.2013 14:28:19

Modulation Type	Channel Separation	Freq.(MHz)	Rated Power (Watt)	Measurement (dBm)	FCC Limit	IC Limit (dB)	Results
4FSK	12.5 KHz	851.5000	3	35.04	Varies	34.77±1	Compliance

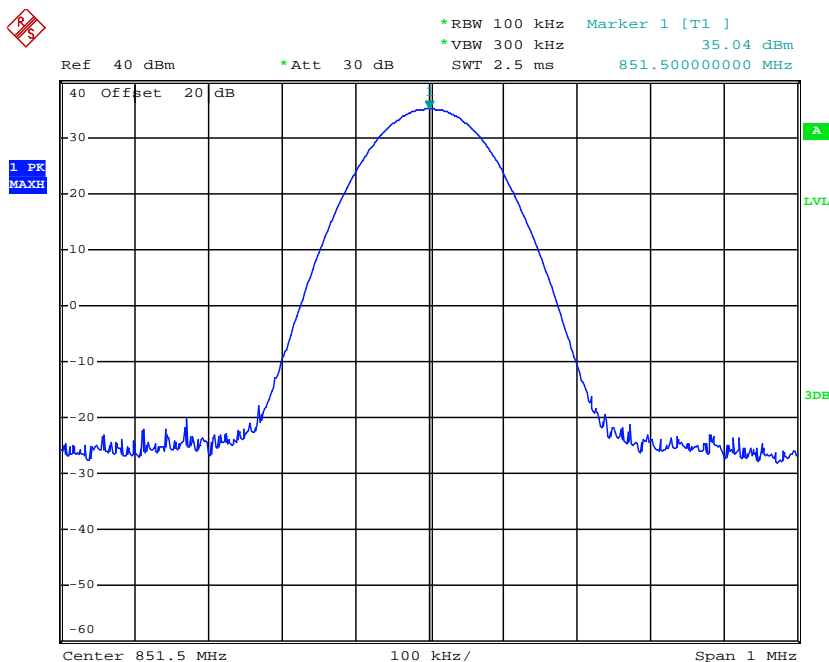

Date: 1.APR.2013 15:10:29

Modulation Type	Channel Separation	Freq.(MHz)	Rated Power (Watt)	Measurement (dBm)	FCC Limit	IC Limit (dB)	Results
4FSK	12.5 KHz	860.0000	3	35.11	Varies	34.77±1	Complicance

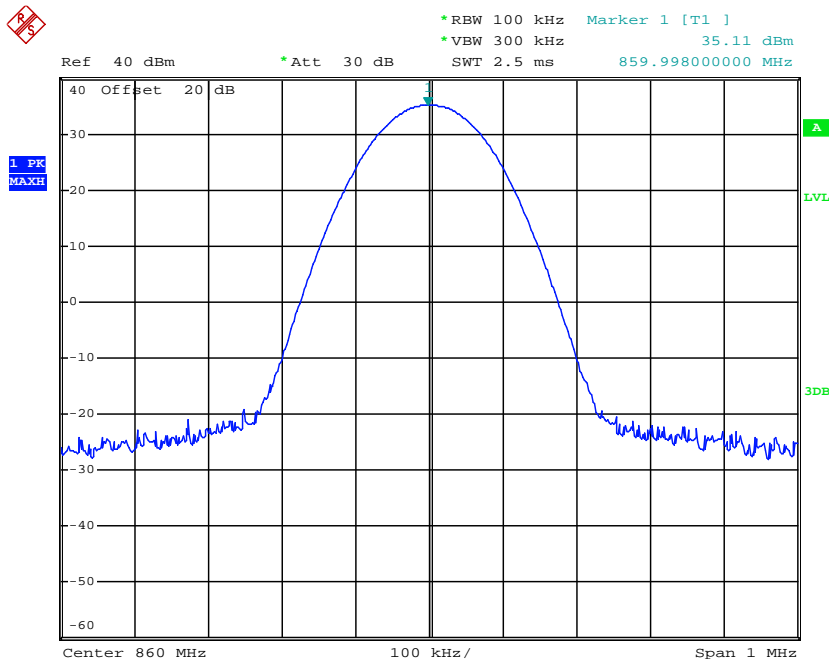

Date: 1.APR.2013 15:11:34

Modulation Type	Channel Separation	Freq.(MHz)	Rated Power (Watt)	Measurement (dBm)	FCC Limit	IC Limit (dB)	Results
4FSK	12.5 KHz	868.5000	3	35.11	Varies	34.77±1	Complicance

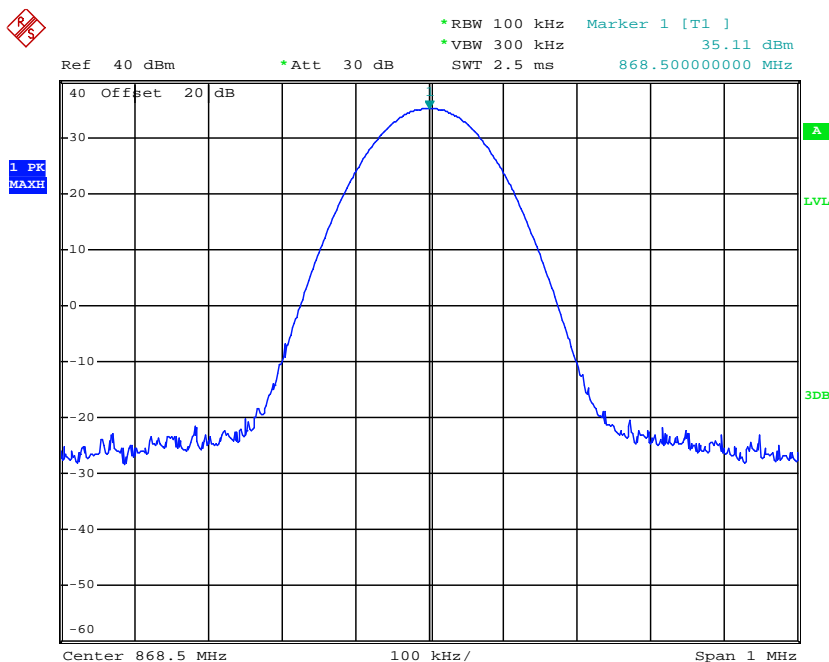

Date: 1.APR.2013 15:12:24

Modulation Type	Channel Separation	Freq.(MHz)	Rated Power (Watt)	Measurement (dBm)	FCC Limit	IC Limit (dB)	Results
4FSK	12.5 KHz	896.5000	2.5	34.51	Varies	33.98±1	Complicance

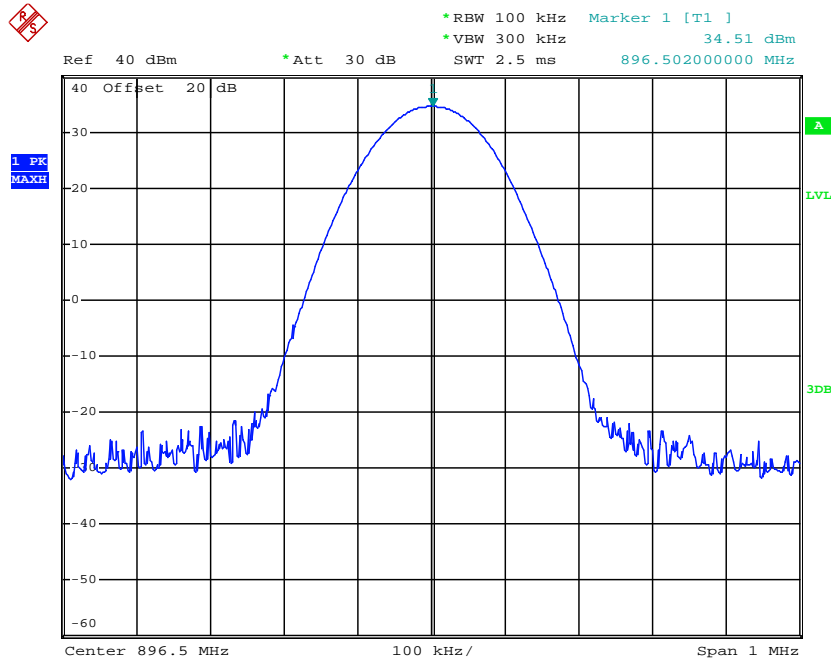

Date: 1.APR.2013 14:39:19

Modulation Type	Channel Separation	Freq.(MHz)	Rated Power (Watt)	Measurement (dBm)	FCC Limit	IC Limit (dB)	Results
4FSK	12.5 KHz	900.5000	2.5	34.44	Varies	33.98±1	Complicance

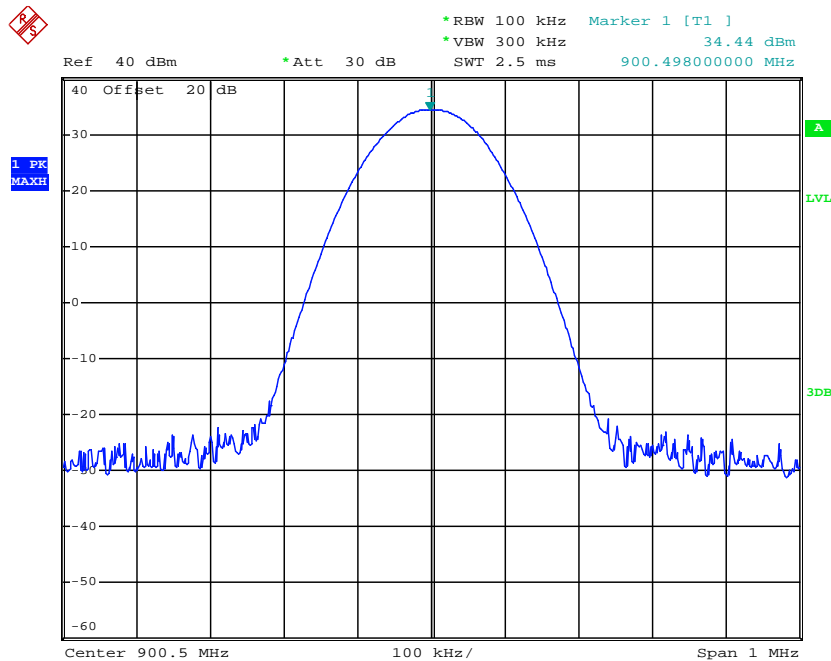

Date: 1.APR.2013 14:33:55

Modulation Type	Channel Separation	Freq.(MHz)	Rated Power (Watt)	Measurement (dBm)	FCC Limit	IC Limit (dB)	Results
4FSK	12.5 KHz	935.5000	2.5	34.37	Varies	33.98±1	Compliance

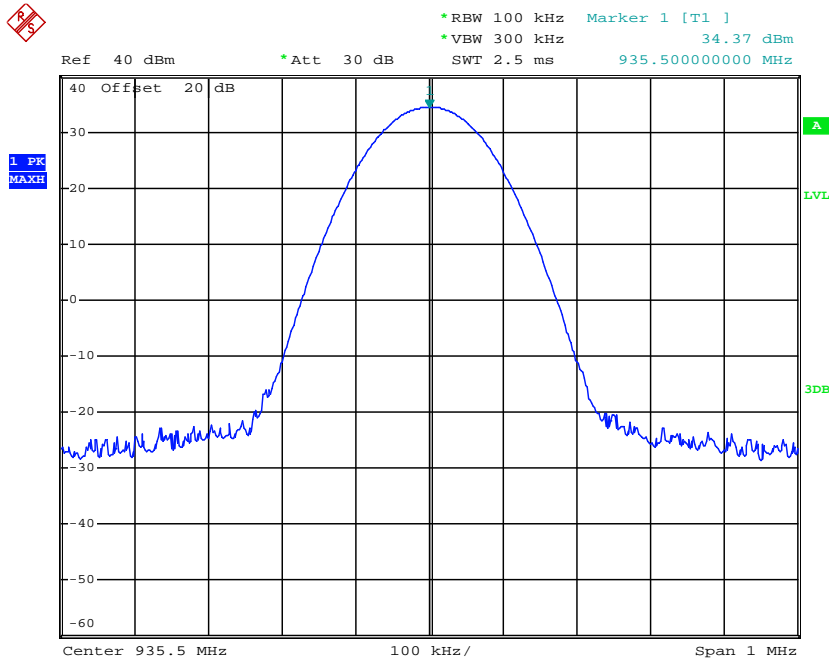

Date: 1.APR.2013 15:15:23

Modulation Type	Channel Separation	Freq.(MHz)	Rated Power (Watt)	Measurement (dBm)	FCC Limit	IC Limit (dB)	Results
4FSK	12.5 KHz	939.5000	2.5	34.32	Varies	33.98±1	Compliance

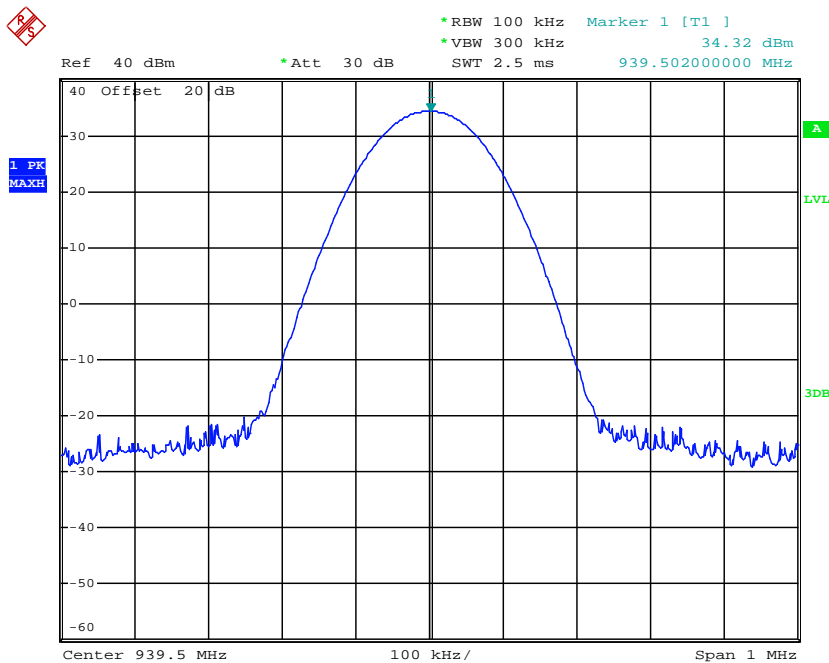

Date: 1.APR.2013 15:15:48

Modulation Type	Channel Separation	Freq.(MHz)	Rated Power (Watt)	Measurement (dBm)	FCC Limit	IC Limit (dB)	Results
FM	25 KHz	806.5000	1	30.80	Varies	30.00±1	Compliance

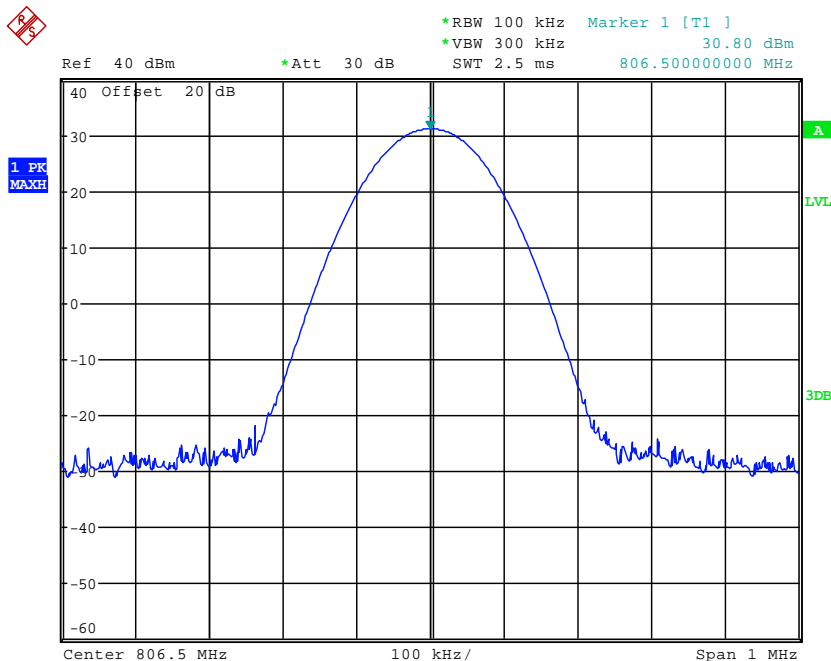

Date: 1.APR.2013 14:22:21

Modulation Type	Channel Separation	Freq.(MHz)	Rated Power (Watt)	Measurement (dBm)	FCC Limit	IC Limit (dB)	Results
FM	25 KHz	817.0000	1	30.81	Varies	30.00±1	Compliance

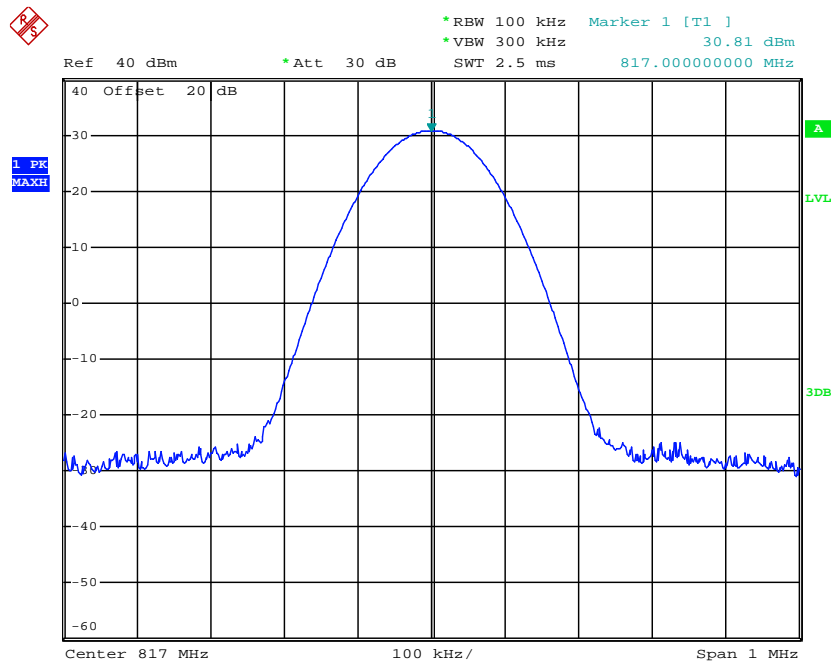

Date: 1.APR.2013 14:45:51

Modulation Type	Channel Separation	Freq.(MHz)	Rated Power (Watt)	Measurement (dBm)	FCC Limit	IC Limit (dB)	Results
FM	25 KHz	823.5000	1	30.38	Varies	30.00±1	Complicance

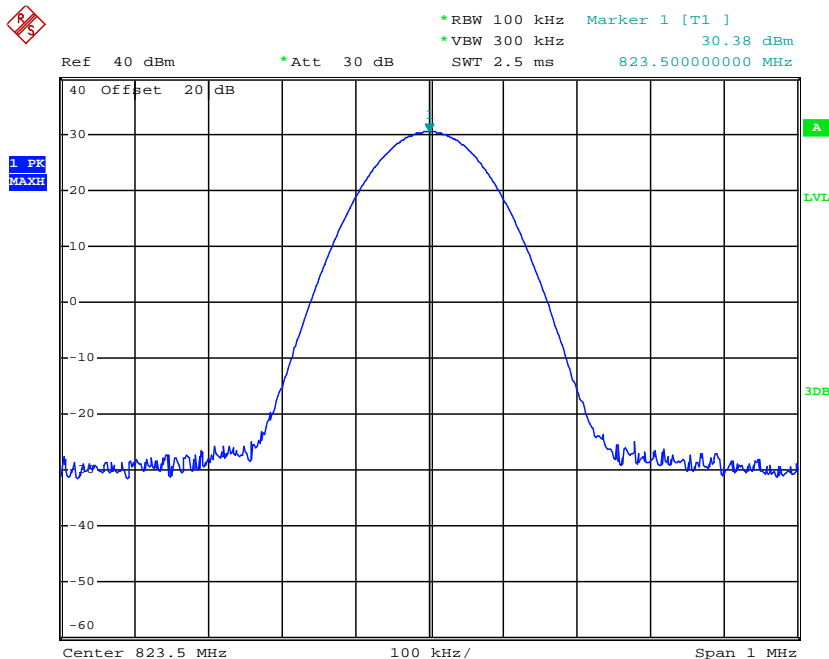

Date: 1.APR.2013 14:25:18

Modulation Type	Channel Separation	Freq.(MHz)	Rated Power (Watt)	Measurement (dBm)	FCC Limit	IC Limit (dB)	Results
FM	25 KHz	851.5000	1	30.92	Varies	30.00±1	Complicance

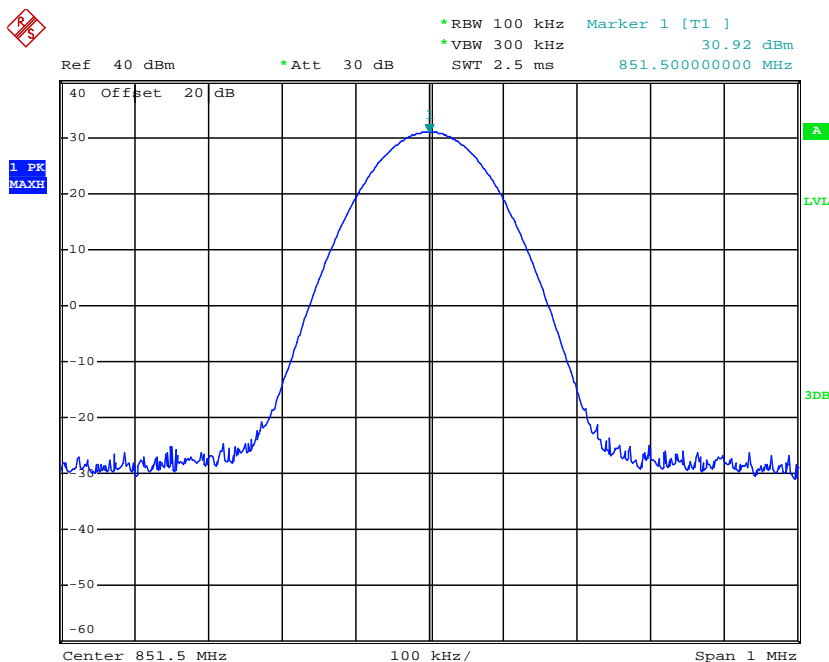

Date: 1.APR.2013 15:05:50

Modulation Type	Channel Separation	Freq.(MHz)	Rated Power (Watt)	Measurement (dBm)	FCC Limit	IC Limit (dB)	Results
FM	25 KHz	860.0000	1	30.95	Varies	30.00±1	Compliance

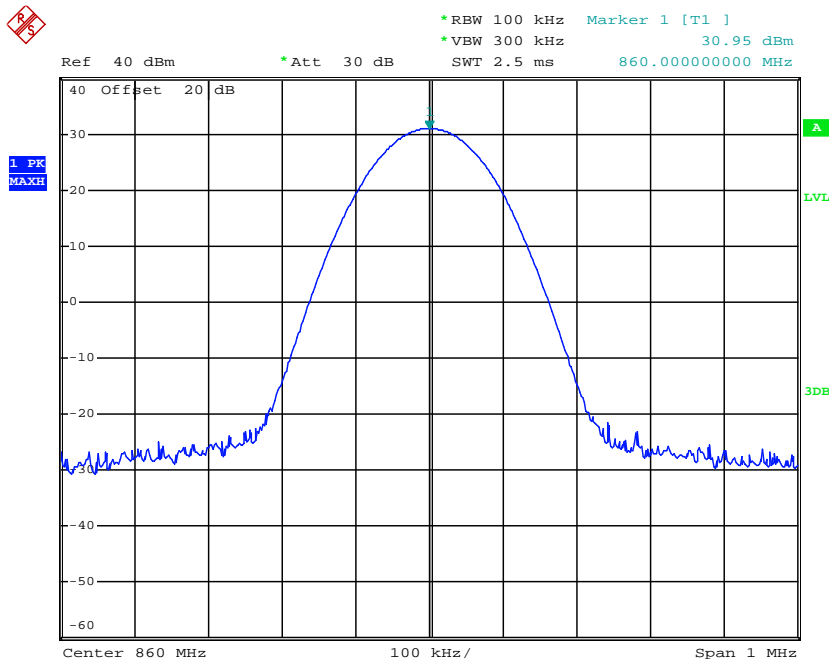

Date: 1.APR.2013 15:06:39

Modulation Type	Channel Separation	Freq.(MHz)	Rated Power (Watt)	Measurement (dBm)	FCC Limit	IC Limit (dB)	Results
FM	25 KHz	868.5000	1	30.37	Varies	30.00±1	Compliance

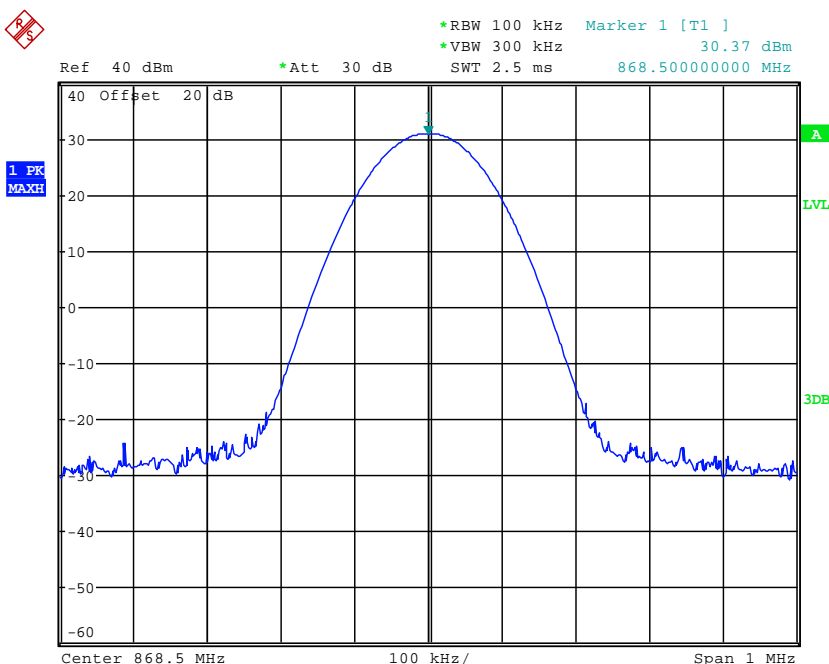

Date: 1.APR.2013 15:07:38

Modulation Type	Channel Separation	Freq.(MHz)	Rated Power (Watt)	Measurement (dBm)	FCC Limit	IC Limit (dB)	Results
FM	12.5 KHz	806.5000	1	30.41	Varies	30.00±1	Compliance

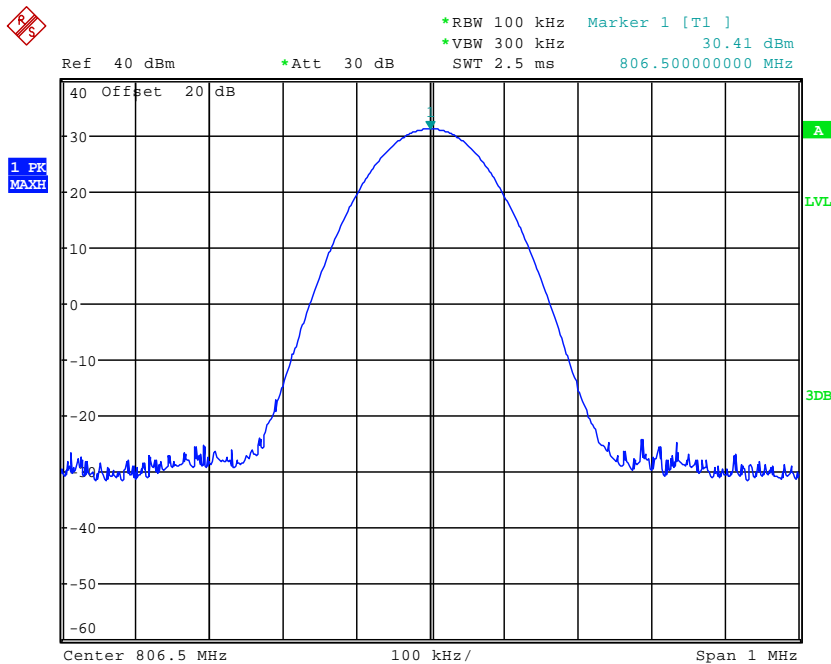

Date: 1.APR.2013 14:23:05

Modulation Type	Channel Separation	Freq.(MHz)	Rated Power (Watt)	Measurement (dBm)	FCC Limit	IC Limit (dB)	Results
FM	12.5 KHz	817.0000	1	30.81	Varies	30.00±1	Compliance

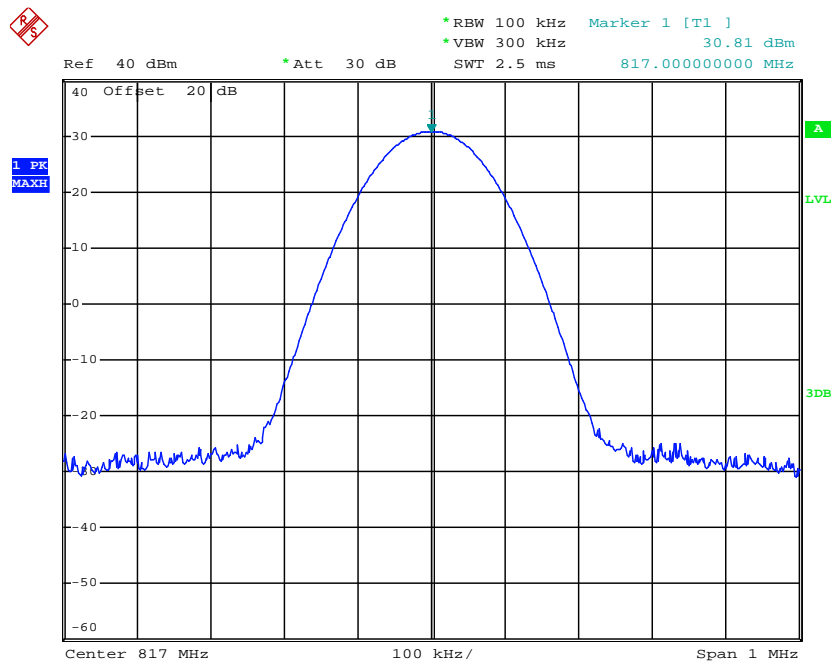

Date: 1.APR.2013 14:45:51

Modulation Type	Channel Separation	Freq.(MHz)	Rated Power (Watt)	Measurement (dBm)	FCC Limit	IC Limit (dB)	Results
FM	12.5 KHz	823.5000	1	30.52	Varies	30.00±1	Compliance

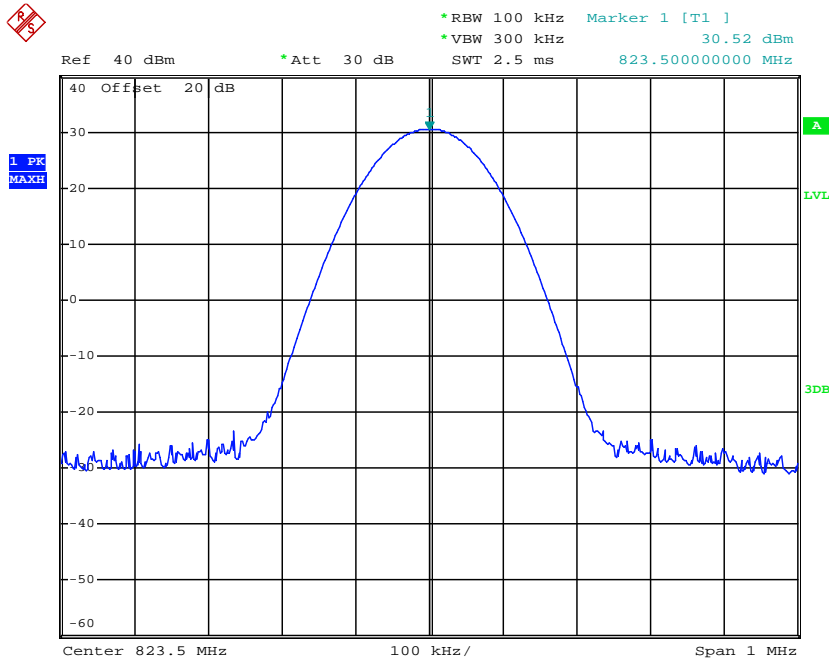

Date: 1.APR.2013 14:40:14

Modulation Type	Channel Separation	Freq.(MHz)	Rated Power (Watt)	Measurement (dBm)	FCC Limit	IC Limit (dB)	Results
FM	12.5 KHz	851.5000	1	30.92	Varies	30.00±1	Compliance

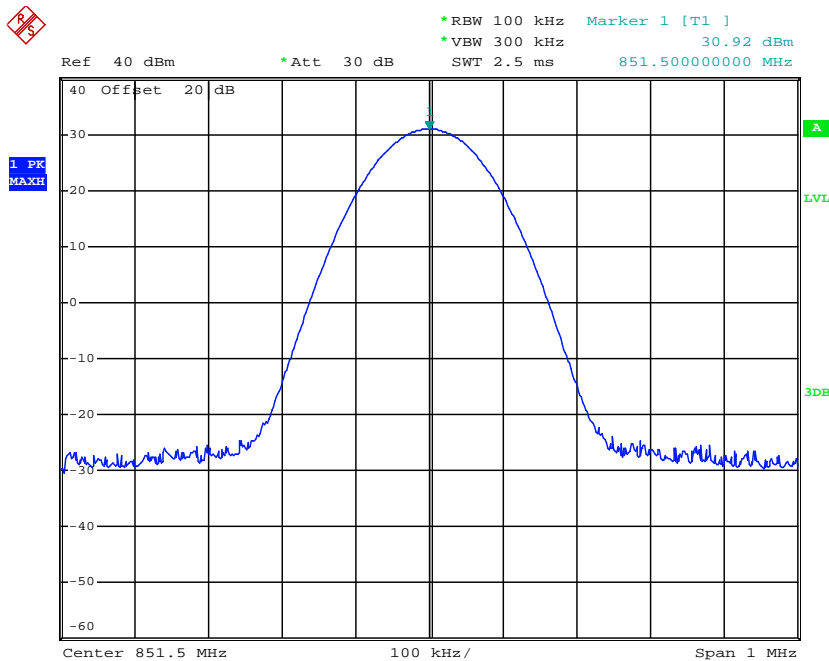

Date: 1.APR.2013 15:01:55

Modulation Type	Channel Separation	Freq.(MHz)	Rated Power (Watt)	Measurement (dBm)	FCC Limit	IC Limit (dB)	Results
FM	12.5 KHz	860.0000	1	30.99	Varies	30.00±1	Complicance

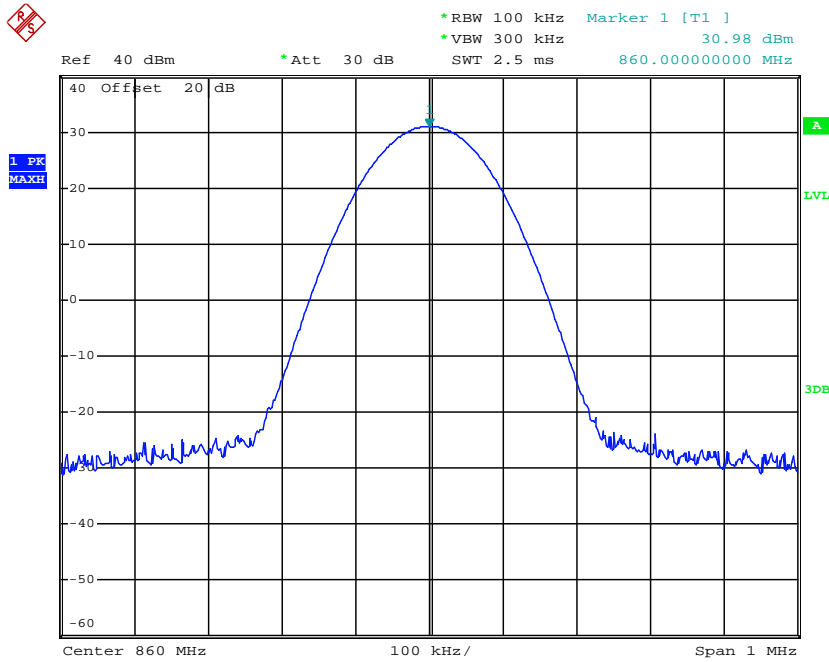

Date: 1.APR.2013 15:03:41

Modulation Type	Channel Separation	Freq.(MHz)	Rated Power (Watt)	Measurement (dBm)	FCC Limit	IC Limit (dB)	Results
FM	12.5 KHz	868.5000	1	30.39	Varies	30.00±1	Complicance

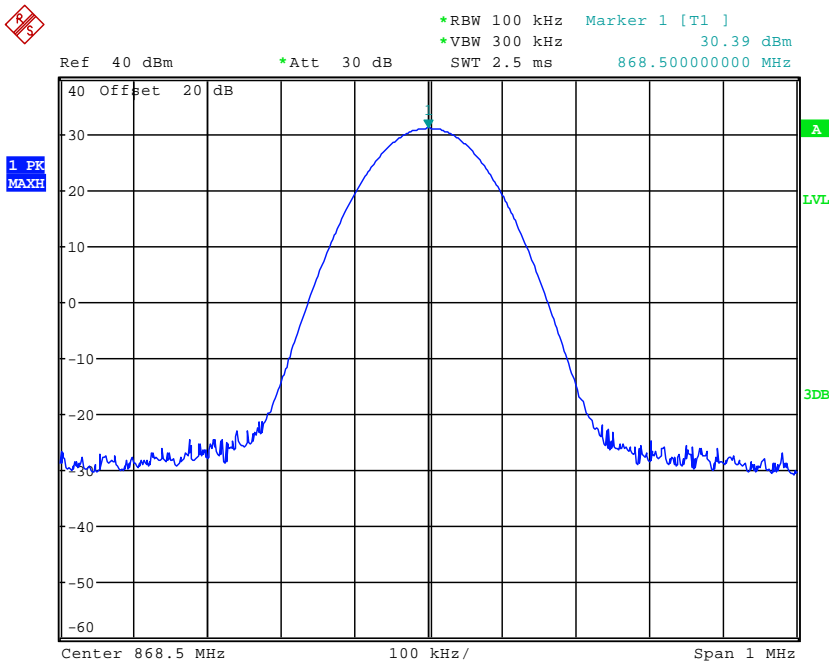

Date: 1.APR.2013 15:04:24

Modulation Type	Channel Separation	Freq.(MHz)	Rated Power (Watt)	Measurement (dBm)	FCC Limit	IC Limit (dB)	Results
FM	12.5 KHz	896.5000	1	30.54	Varies	30.00±1	Complicance

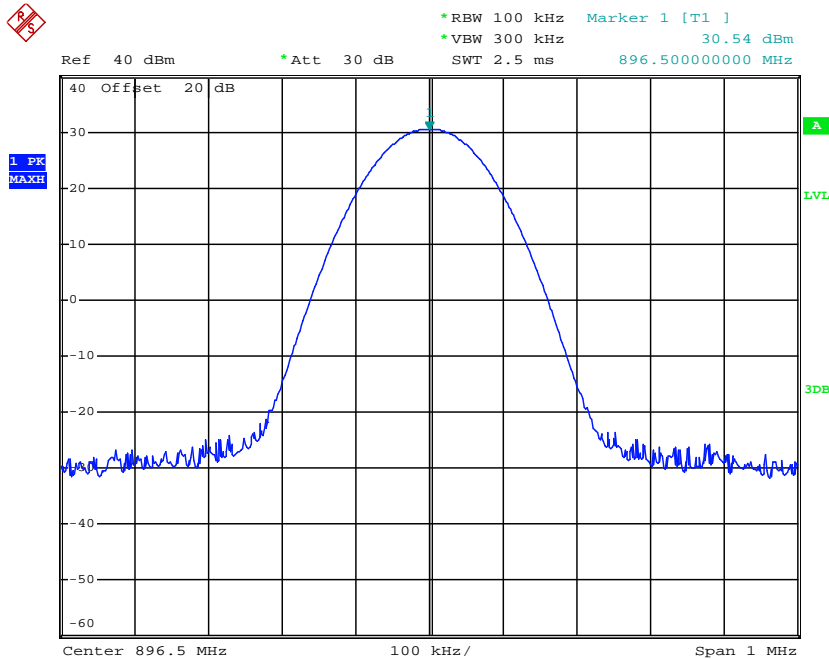

Date: 1.APR.2013 14:30:48

Modulation Type	Channel Separation	Freq.(MHz)	Rated Power (Watt)	Measurement (dBm)	FCC Limit	IC Limit (dB)	Results
FM	12.5 KHz	900.5000	1	30.62	Varies	30.00±1	Complicance

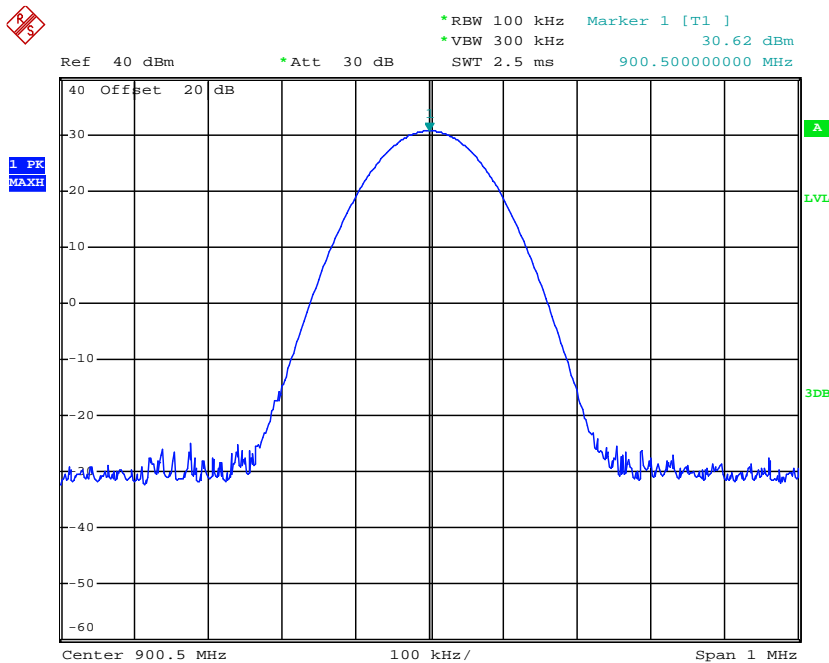

Date: 1.APR.2013 14:33:05

Modulation Type	Channel Separation	Freq.(MHz)	Rated Power (Watt)	Measurement (dBm)	FCC Limit	IC Limit (dB)	Results
FM	12.5 KHz	935.5000	1	30.61	Varies	30.00±1	Compliance

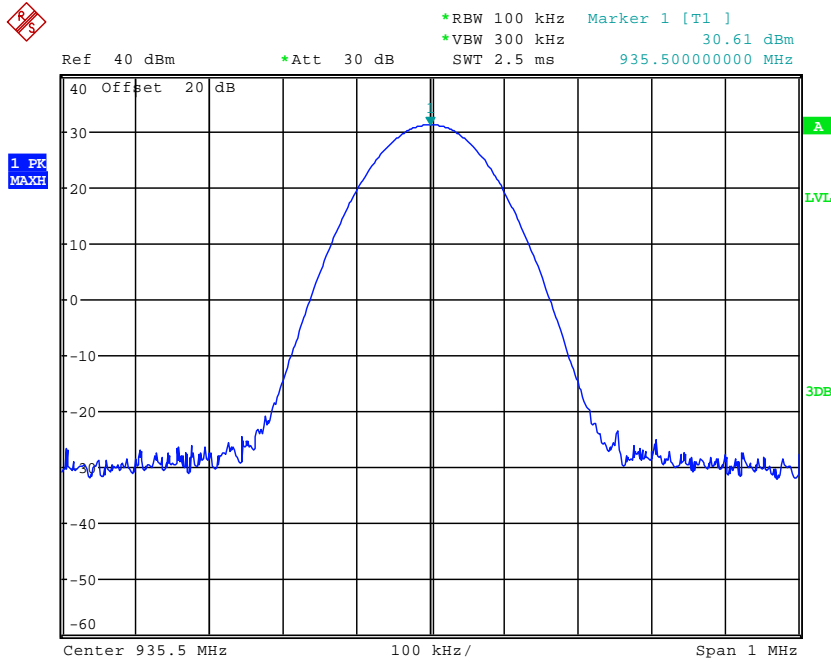

Date: 1.APR.2013 15:13:13

Modulation Type	Channel Separation	Freq.(MHz)	Rated Power (Watt)	Measurement (dBm)	FCC Limit	IC Limit (dB)	Results
FM	12.5 KHz	939.5000	1	30.56	Varies	30.00±1	Compliance

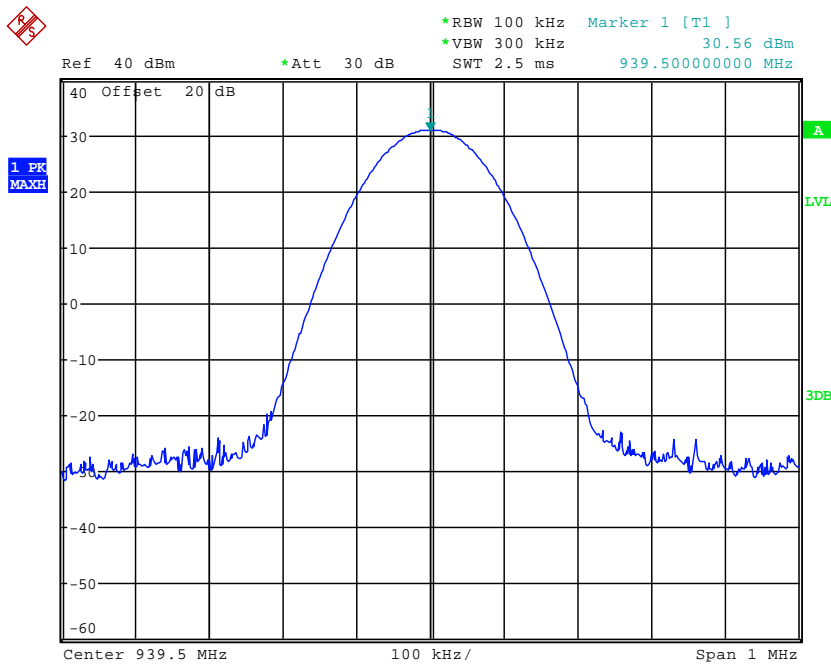

Date: 1.APR.2013 15:14:40

Modulation Type	Channel Separation	Freq.(MHz)	Rated Power (Watt)	Measurement (dBm)	FCC Limit	IC Limit (dB)	Results
4FSK	12.5 KHz	806.5000	1	30.68	Varies	30.00±1	Compliance

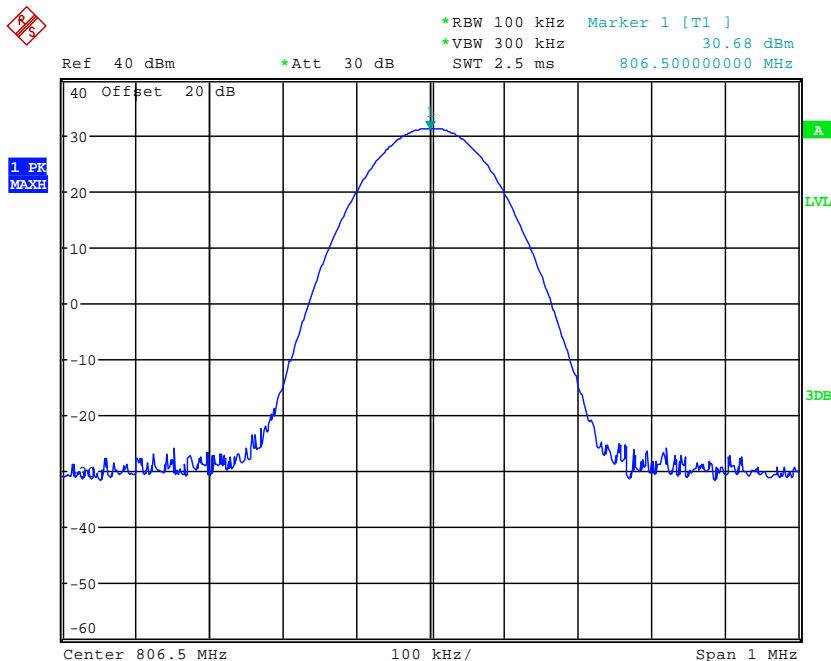

Date: 1.APR.2013 14:26:02

Modulation Type	Channel Separation	Freq.(MHz)	Rated Power (Watt)	Measurement (dBm)	FCC Limit	IC Limit (dB)	Results
4FSK	12.5 KHz	817.0000	1	30.81	Varies	30.00±1	Compliance

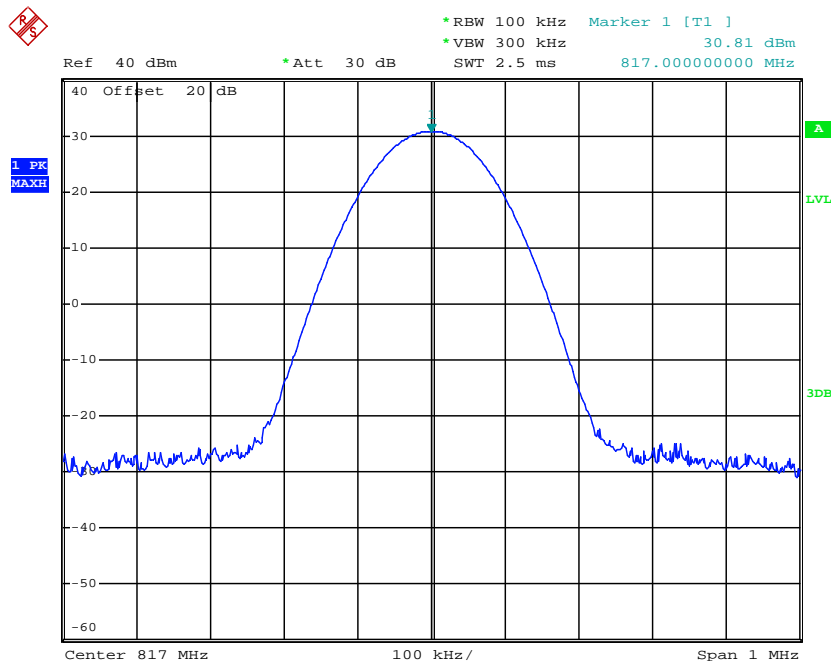

Date: 1.APR.2013 14:45:51

Modulation Type	Channel Separation	Freq.(MHz)	Rated Power (Watt)	Measurement (dBm)	FCC Limit	IC Limit (dB)	Results
4FSK	12.5 KHz	823.5000	1	30.49	Varies	30.00±1	Compliance

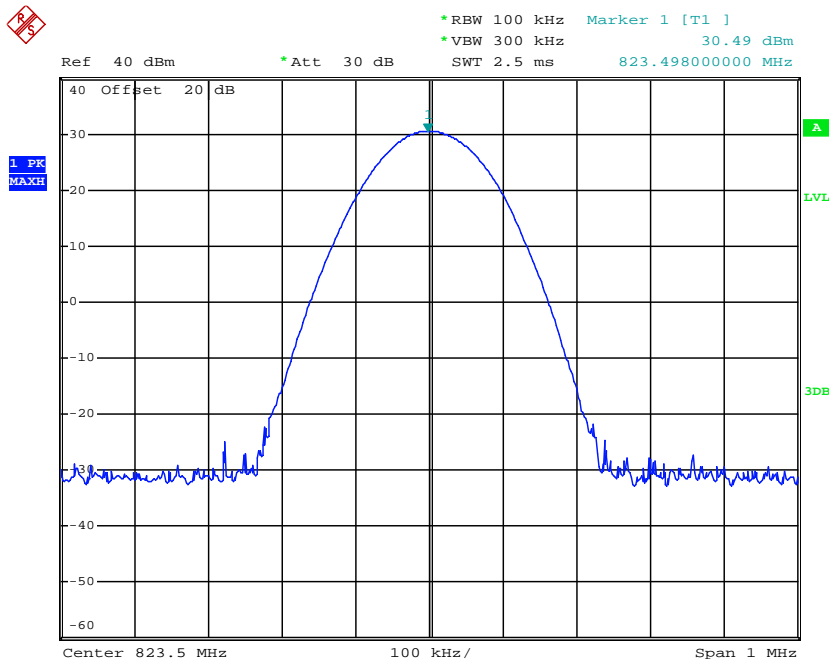

Date: 1.APR.2013 14:29:44

Modulation Type	Channel Separation	Freq.(MHz)	Rated Power (Watt)	Measurement (dBm)	FCC Limit	IC Limit (dB)	Results
4FSK	12.5 KHz	851.5000	1	30.21	Varies	30.00±1	Compliance

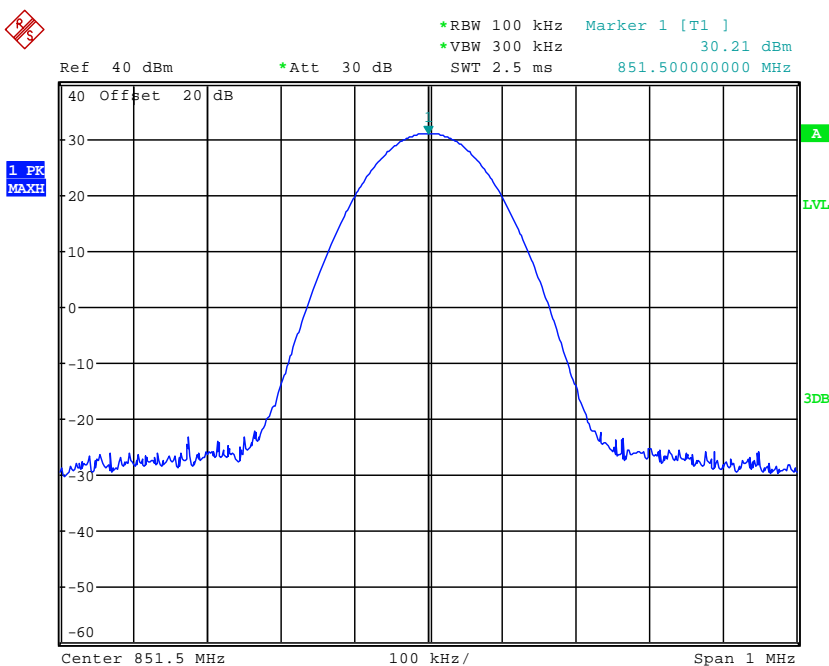

Date: 1.APR.2013 15:10:15

Modulation Type	Channel Separation	Freq.(MHz)	Rated Power (Watt)	Measurement (dBm)	FCC Limit	IC Limit (dB)	Results
4FSK	12.5 KHz	860.0000	1	30.26	Varies	30.00±1	Compliance

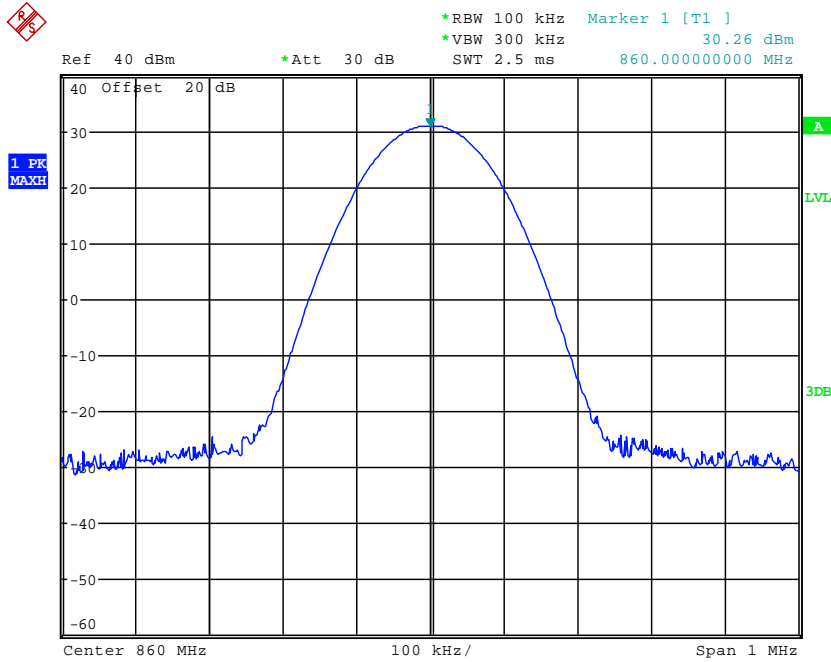

Date: 1.APR.2013 15:10:51

Modulation Type	Channel Separation	Freq.(MHz)	Rated Power (Watt)	Measurement (dBm)	FCC Limit	IC Limit (dB)	Results
4FSK	12.5 KHz	868.5000	1	30.39	Varies	30.00±1	Compliance

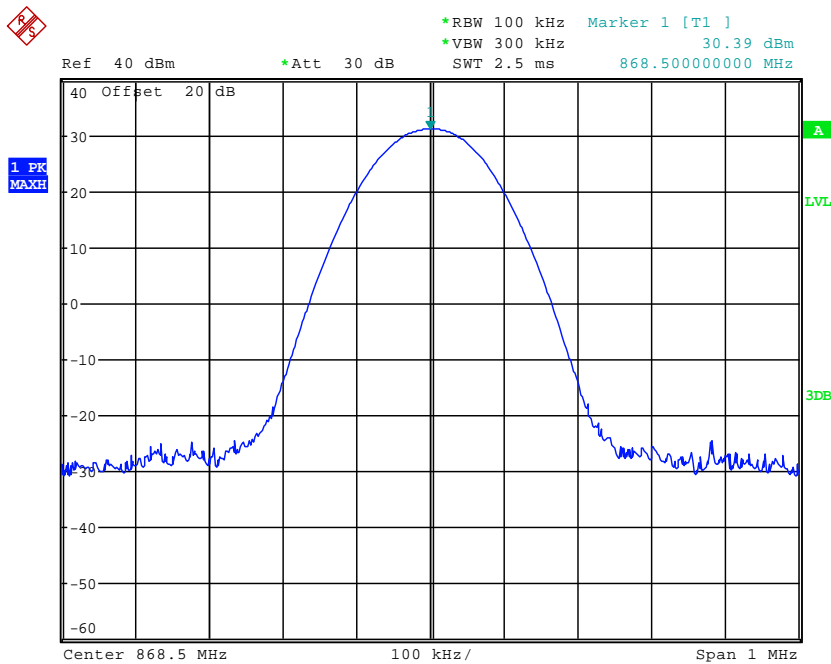

Date: 1.APR.2013 15:12:13

Modulation Type	Channel Separation	Freq.(MHz)	Rated Power (Watt)	Measurement (dBm)	FCC Limit	IC Limit (dB)	Results
4FSK	12.5 KHz	896.5000	1	30.78	Varies	30.00±1	Compliance

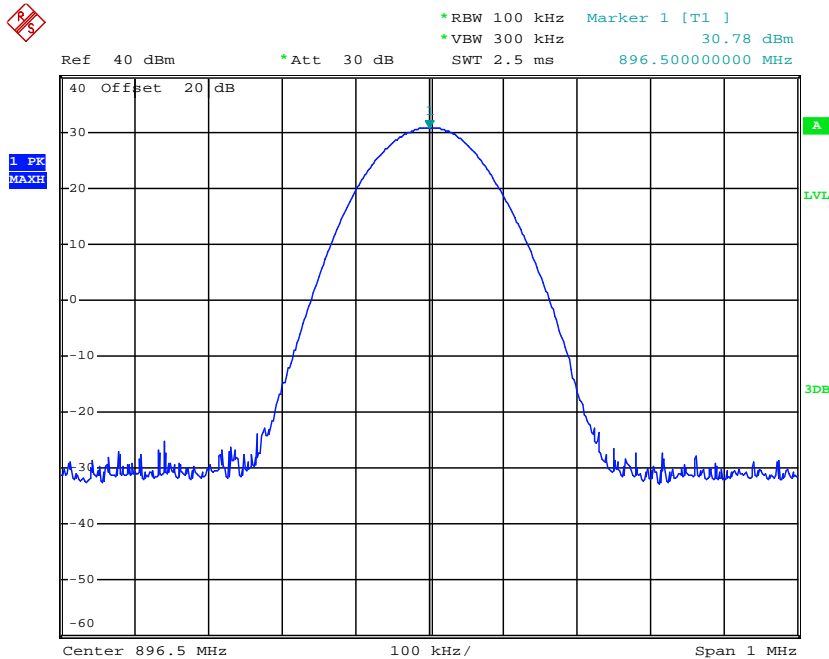

Date: 1.APR.2013 14:39:35

Modulation Type	Channel Separation	Freq.(MHz)	Rated Power (Watt)	Measurement (dBm)	FCC Limit	IC Limit (dB)	Results
4FSK	12.5 KHz	900.5000	1	30.76	Varies	30.00±1	Compliance

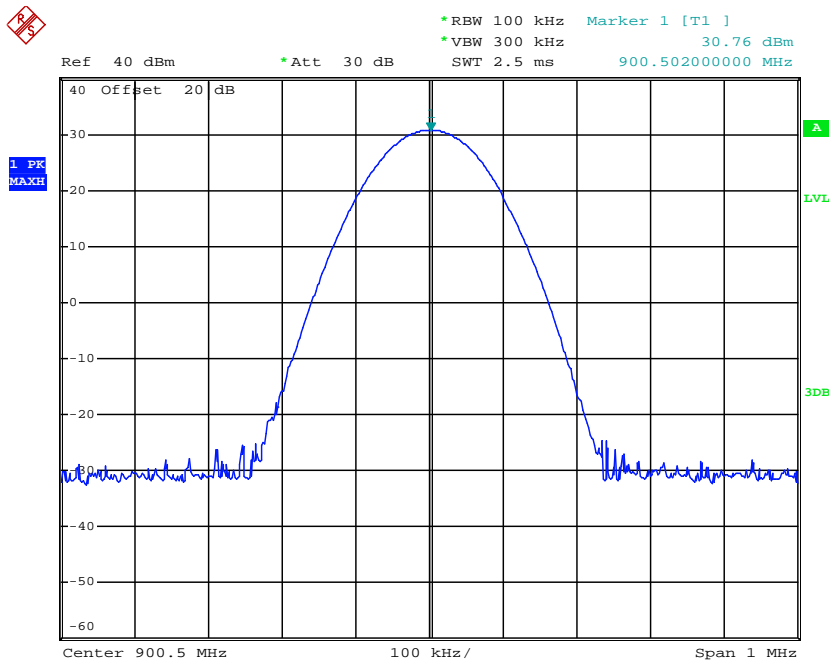

Date: 1.APR.2013 14:33:27

Modulation Type	Channel Separation	Freq.(MHz)	Rated Power (Watt)	Measurement (dBm)	FCC Limit	IC Limit (dB)	Results
4FSK	12.5 KHz	935.5000	1	30.33	Varies	30.00±1	Compliance

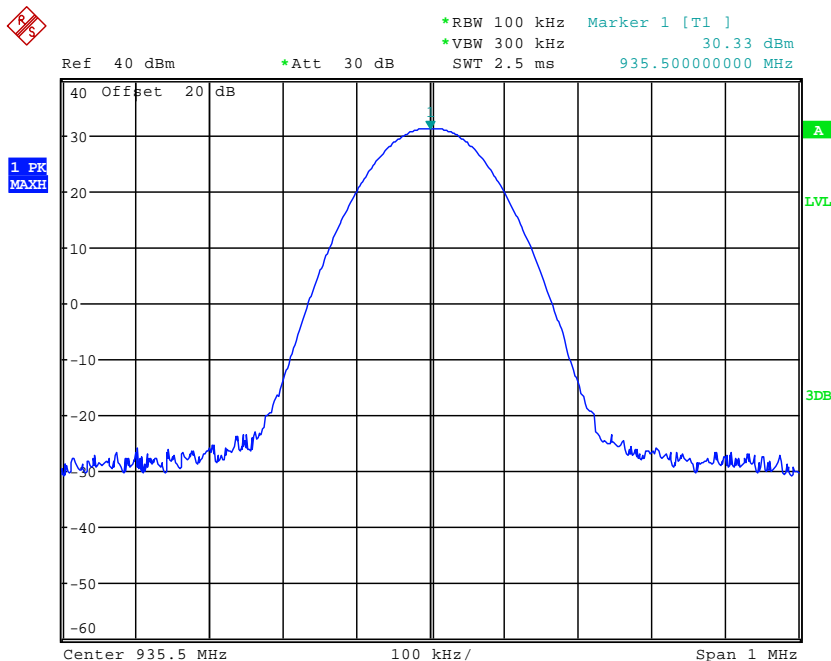

Date: 1.APR.2013 15:15:04

Modulation Type	Channel Separation	Freq.(MHz)	Rated Power (Watt)	Measurement (dBm)	FCC Limit	IC Limit (dB)	Results
4FSK	12.5 KHz	939.5000	1	30.30	Varies	30.00±1	Compliance

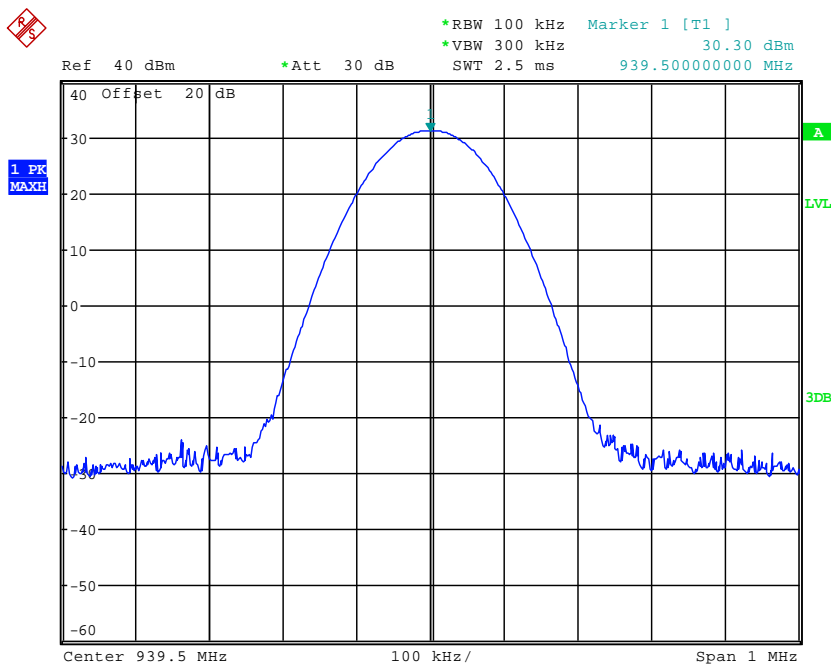

Date: 1.APR.2013 15:16:03

4.8. Receiver Radiated Spurious Emission

TEST APPLICABLE

The field strength is calculated by adding the Antenna Factor and Cable Factor and subtracting the Amplifier Gain and Duty Cycle Correction Factor (if any) from the measured reading. The basic equation with a sample calculation is as follows:

$$FS = RA + AF + CL - AG$$

Where FS = Field Strength	CL = Cable Attenuation Factor (Cable Loss)
RA = Reading Amplitude	AG = Amplifier Gain
AF = Antenna Factor	

TEST CONFIGURATION

(A) Radiated Emission Test Set-Up, Frequency below 1000MHz

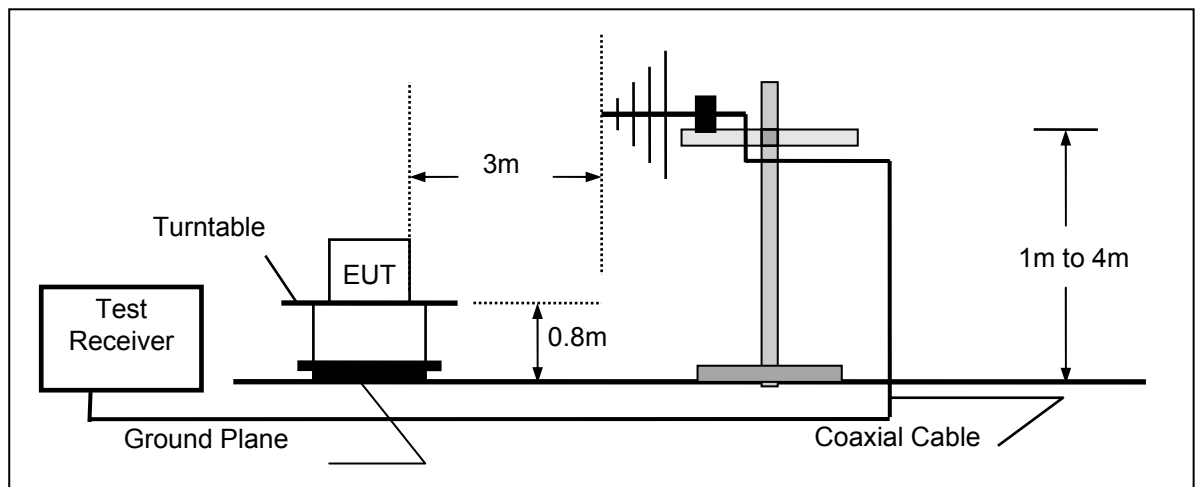

(B) Radiated Emission Test Set-Up, Frequency above 1000MHz

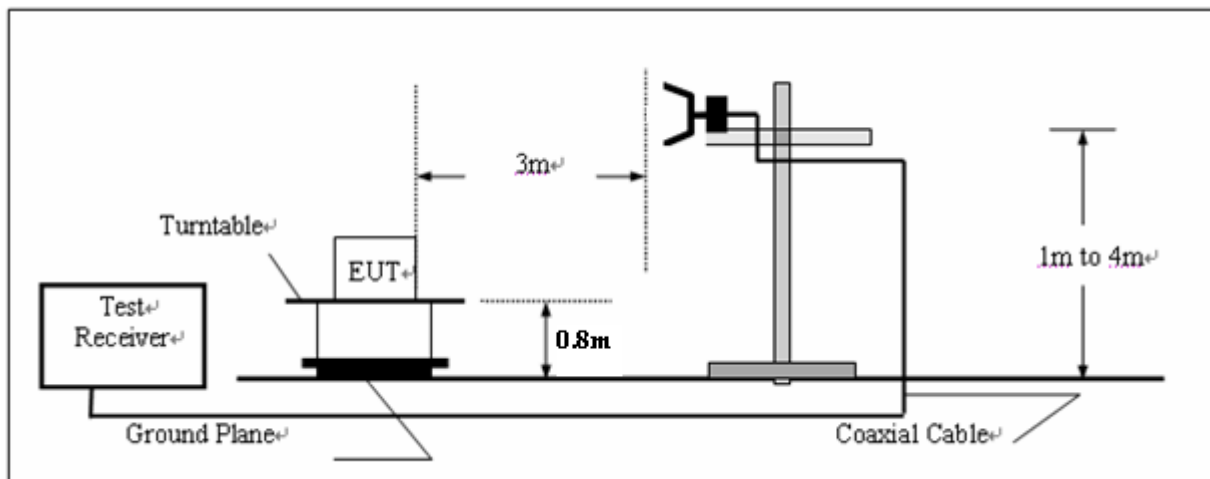

TEST PROCEDURE

- 1 The EUT was placed on a turn table which is 0.8m above ground plane.
- 2 Maximum procedure was performed by raising the receiving antenna from 1m to 4m and rotating the turn table from 0° to 360° to acquire the highest emissions from EUT
- 3 And also, each emission was to be maximized by changing the polarization of receiving antenna both horizontal and vertical.
- 4 Repeat above procedures until all frequency measurements have been completed.

RECEIVER RADIATED SPOUIOUS LIMIT

For unintentional device, according to § 15.109(a) and RSS-Gen, except for Class A digital devices, the field strength of radiated emissions from unintentional radiators at a distance of 3 meters shall not exceed the following values:

Frequency (MHz)	Distance (Meters)	Radiated (dB μ V/m)	Radiated (μ V/m)
30-88	3	40.0	100
88-216	3	43.5	150
216-960	3	46.0	200
Above 960	3	54.0	500

For intentional device, according to § 15.209(a), the general requirement of field strength of radiated emissions from intentional radiators at a distance of 3 meters shall not exceed the above table.

TEST RESULTS

The Radiated Measurement are performed to the five channels (the top channel, the middle channel and the bottom channel), the datum recorded below is the worst case for each channel separation;and the EUT shall be scanned from 30 MHz to the 5th harmonic of the highest oscillator frequency in the digital devices or 1 GHz whichever is higher.

Both For FCC and IC Review

Modulation Type	Channel Separation	Test Frequency (MHz)	Polar.	Maximum Radiated Emissions		FCC Limit (dBuV/m)
				Frequency (MHz)	Datum (dBuV/m)	
FM	25 KHz	806.5000	H	926.28	29.70	46.00
			V	881.66	30.70	46.00
Test Results			Compliance			

SWEEP TABLE: "test (30M-1G)"

Short Description: Field Strength
 Start Stop Detector Meas. IF Transducer
 Frequency Frequency Time Bandw.
 30.0 MHz 1.0 GHz MaxPeak Coupled 120 kHz HL562 201106

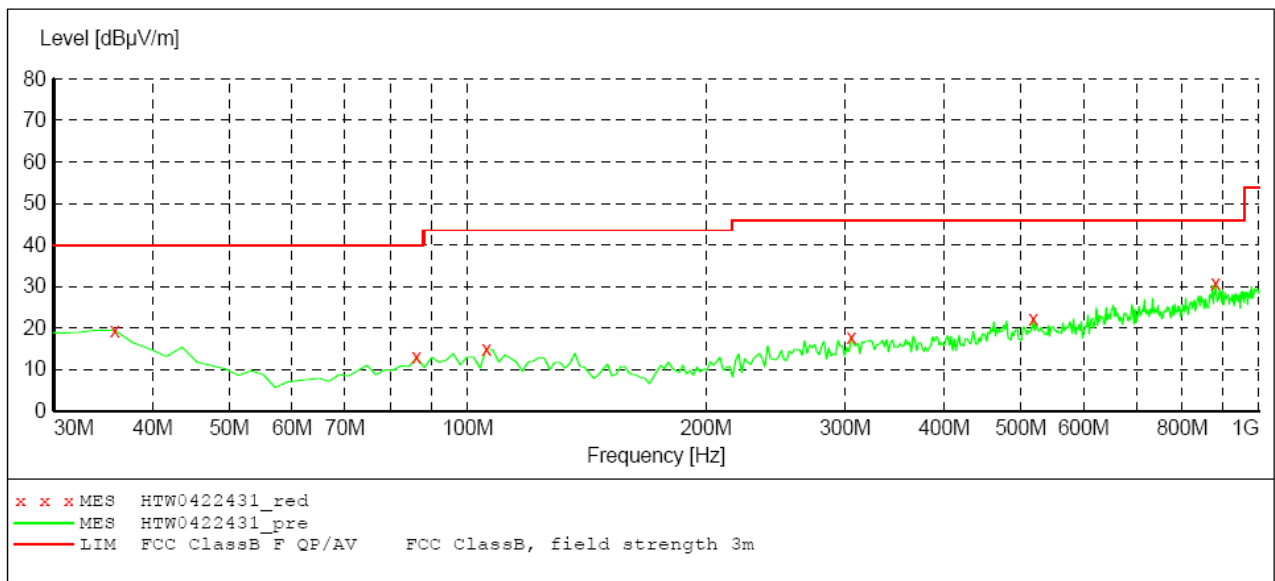

MEASUREMENT RESULT: "HTW0422431_red"

4/22/2013 6:07PM

Frequency MHz	Level dBuV/m	Transd dB	Limit dBuV/m	Margin dB	Det.	Height cm	Azimuth deg	Polarization
35.820000	19.40	-12.9	40.0	20.6	PK	100.0	0.00	VERTICAL
86.260000	12.80	-19.4	40.0	27.2	PK	100.0	0.00	VERTICAL
105.660000	14.90	-18.2	43.5	28.6	PK	100.0	0.00	VERTICAL
305.480000	17.80	-15.0	46.0	28.2	PK	100.0	0.00	VERTICAL
518.880000	22.20	-10.9	46.0	23.8	PK	100.0	0.00	VERTICAL
881.660000	30.70	-4.4	46.0	15.3	PK	100.0	0.00	VERTICAL

SWEEP TABLE: "test (30M-1G)"

Short Description:		Field Strength			
Start	Stop	Detector	Meas.	IF	Transducer
Frequency	Frequency		Time	Bandw.	
30.0 MHz	1.0 GHz	MaxPeak	Coupled	120 kHz	HL562 201106

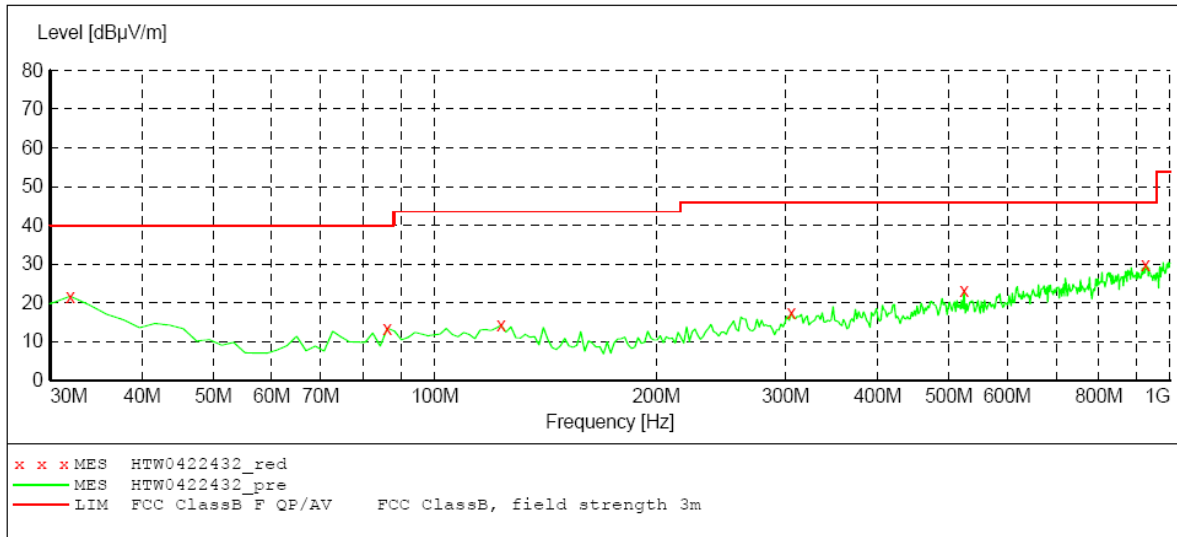

MEASUREMENT RESULT: "HTW0422432_red"

4/22/2013 6:08PM

Frequency MHz	Level dBµV/m	Transd dB	Limit dBµV/m	Margin dB	Det.	Height cm	Azimuth deg	Polarization
31.940000	21.60	-11.1	40.0	18.4	PK	100.0	0.00	HORIZONTAL
86.260000	13.40	-19.4	40.0	26.6	PK	100.0	0.00	HORIZONTAL
123.120000	14.10	-18.0	43.5	29.4	PK	100.0	0.00	HORIZONTAL
305.480000	17.40	-15.0	46.0	28.6	PK	100.0	0.00	HORIZONTAL
524.700000	23.10	-11.0	46.0	22.9	PK	100.0	0.00	HORIZONTAL
926.280000	29.70	-4.5	46.0	16.3	PK	100.0	0.00	HORIZONTAL

Modulation Type	Channel Separation	Test Frequency (MHz)	Polar.	Maximum Radiated Emissions		FCC Limit (dBuV/m)
				Frequency (MHz)	Datum (dBuV/m)	
FM	25 KHz	806.5000	H	18000.00	45.80	54.00
			V	18000.00	45.80	54.00
Test Results			Compliance			

SWEEP TABLE: "test (1G-18G) P"

Short Description: EN 55022 Field Strength
 Start Stop Detector Meas. IF Transducer
 Frequency Frequency Time Bandw.
 1.0 GHz 18.0 GHz MaxPeak Coupled 1 MHz HF906 2011
 Average

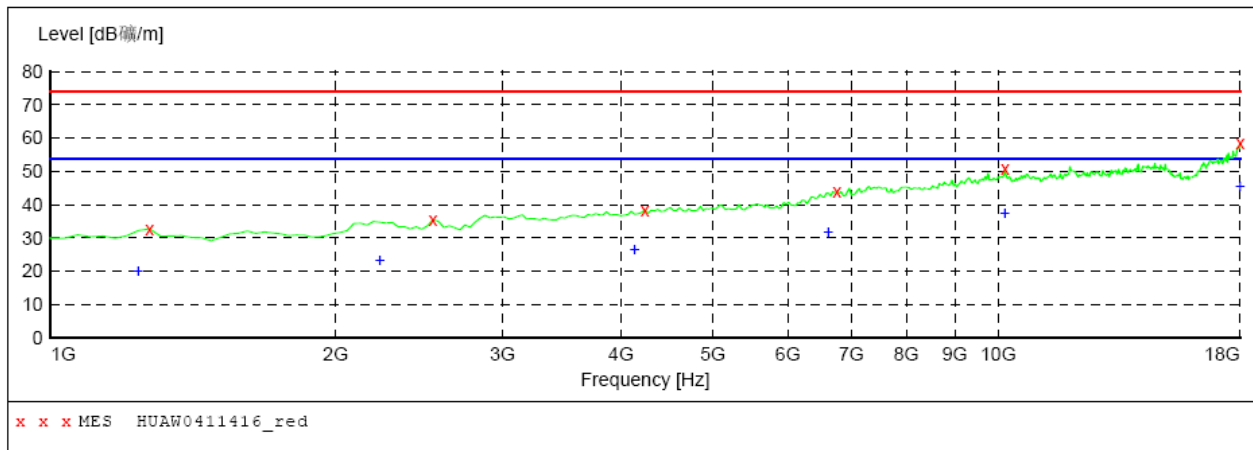

MEASUREMENT RESULT: "HUAW0411416_red"

4/11/2013 4:35PM

Frequency MHz	Level dBμV/m	Transd dB	Limit dBμV/m	Margin dB	Det.	Height cm	Azimuth deg	Polarization
1272.545090	32.70	-8.2	73.9	41.2	PK	100.0	284.00	VERTICAL
2533.066132	35.50	-5.1	73.9	38.4	PK	100.0	0.00	VERTICAL
4236.472946	38.40	0.3	73.9	35.5	PK	100.0	78.00	VERTICAL
6757.515030	43.90	8.3	73.9	30.0	PK	100.0	284.00	VERTICAL
10164.328657	50.70	13.1	73.9	23.2	PK	100.0	169.00	VERTICAL
18000.000000	58.60	26.3	73.9	15.3	PK	100.0	343.00	VERTICAL

MEASUREMENT RESULT: "HUAW0411416_red2"

4/11/2013 4:35PM

Frequency MHz	Level dBμV/m	Transd dB	Limit dBμV/m	Margin dB	Det.	Height cm	Azimuth deg	Polarization
1238.476954	20.10	-8.5	53.9	33.8	AV	100.0	97.00	VERTICAL
2226.452906	23.30	-4.9	53.9	30.6	AV	100.0	213.00	VERTICAL
4134.268537	26.60	0.1	53.9	27.3	AV	100.0	329.00	VERTICAL
6621.242485	31.70	8.0	53.9	22.2	AV	100.0	360.00	VERTICAL
10164.328657	37.50	13.1	53.9	16.4	AV	100.0	155.00	VERTICAL
18000.000000	45.80	26.3	53.9	8.1	AV	100.0	360.00	VERTICAL

SWEEP TABLE: "test (1G-18G) P"

Short Description: EN 55022 Field Strength
 Start Stop Detector Meas. IF Transducer
 Frequency Frequency Time Bandw.
 1.0 GHz 18.0 GHz MaxPeak Coupled 1 MHz HF906 2011
 Average

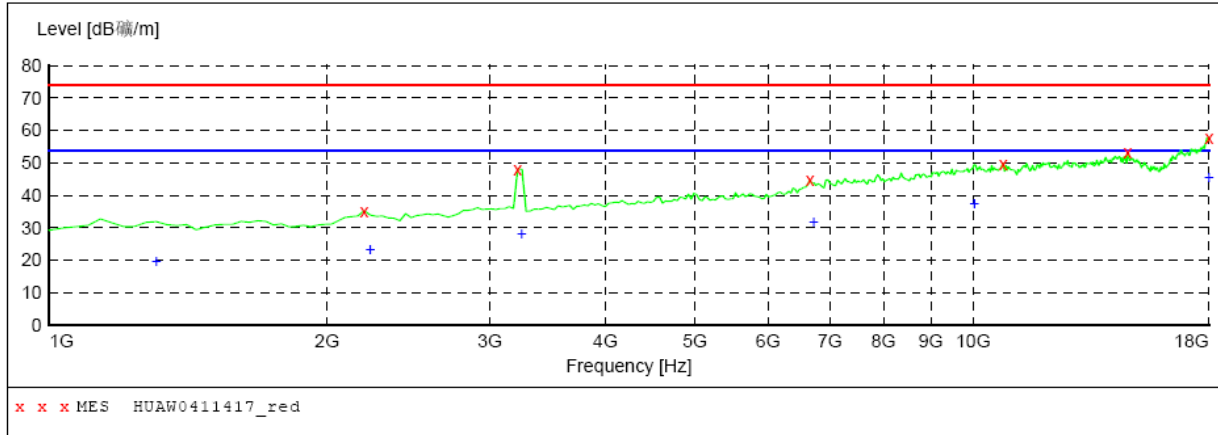

MEASUREMENT RESULT: "HUAW0411417_red"

4/11/2013 4:37PM

Frequency MHz	Level dBμV/m	Transd dB	Limit dBμV/m	Margin dB	Det.	Height cm	Azimuth deg	Polarization
2192.384770	35.20	-5.0	73.9	38.7	PK	100.0	53.00	HORIZONTAL
3214.428858	48.20	-2.8	73.9	25.7	PK	100.0	319.00	HORIZONTAL
6655.310621	44.70	8.0	73.9	29.2	PK	100.0	274.00	HORIZONTAL
10777.555110	49.70	14.1	73.9	24.2	PK	100.0	158.00	HORIZONTAL
14695.390782	53.30	18.9	73.9	20.6	PK	100.0	158.00	HORIZONTAL
18000.000000	57.80	26.3	73.9	16.1	PK	100.0	11.00	HORIZONTAL

MEASUREMENT RESULT: "HUAW0411417_red2"

4/11/2013 4:37PM

Frequency MHz	Level dBμV/m	Transd dB	Limit dBμV/m	Margin dB	Det.	Height cm	Azimuth deg	Polarization
1306.613226	19.90	-8.0	53.9	34.0	AV	100.0	3.00	HORIZONTAL
2226.452906	23.30	-4.9	53.9	30.6	AV	100.0	171.00	HORIZONTAL
3248.496994	28.40	-2.9	53.9	25.5	AV	100.0	319.00	HORIZONTAL
6723.446894	31.90	8.2	53.9	22.0	AV	100.0	53.00	HORIZONTAL
10028.056112	37.50	13.2	53.9	16.4	AV	100.0	333.00	HORIZONTAL
18000.000000	45.80	26.3	53.9	8.1	AV	100.0	359.00	HORIZONTAL

Modulation Type	Channel Separation	Test Frequency (MHz)	Polar.	Maximum Radiated Emissions		FCC Limit (dBuV/m)
				Frequency (MHz)	Datum (dBuV/m)	
FM	12.5 KHz	806.5000	H	932.10	29.70	46.00
			V	893.30	30.40	46.00
Test Results			Compliance			

SWEEP TABLE: "test (30M-1G)"

Short Description: Field Strength
 Start Stop Detector Meas. IF Transducer
 Frequency Frequency Time Bandw.
 30.0 MHz 1.0 GHz MaxPeak Coupled 120 kHz HL562 201106

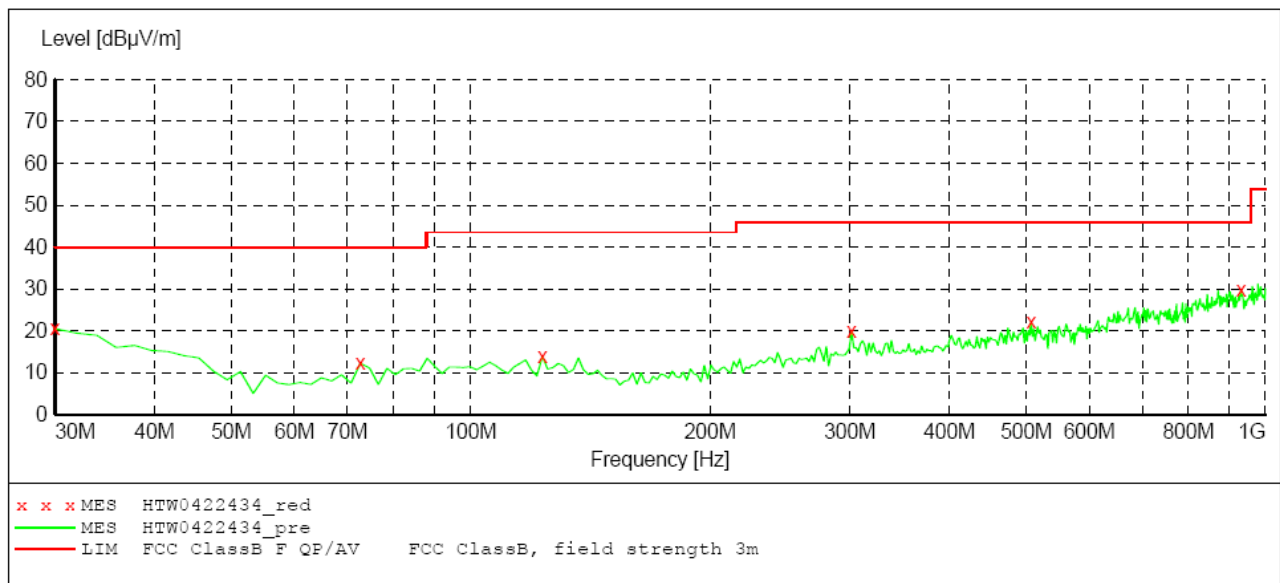

MEASUREMENT RESULT: "HTW0422434_red"

4/22/2013 6:09PM

Frequency MHz	Level dBuV/m	Transd dB	Limit dBuV/m	Margin dB	Det.	Height cm	Azimuth deg	Polarization
30.000000	20.50	-10.0	40.0	19.5	PK	100.0	0.00	HORIZONTAL
72.680000	12.20	-21.3	40.0	27.8	PK	100.0	0.00	HORIZONTAL
123.120000	13.80	-18.0	43.5	29.7	PK	100.0	0.00	HORIZONTAL
301.600000	19.80	-15.3	46.0	26.2	PK	100.0	0.00	HORIZONTAL
507.240000	22.20	-11.3	46.0	23.8	PK	100.0	0.00	HORIZONTAL
932.100000	29.70	-4.5	46.0	16.3	PK	100.0	0.00	HORIZONTAL

SWEEP TABLE: "test (30M-1G)"

Short Description:		Field Strength			
Start	Stop	Detector	Meas. Time	IF Bandw.	Transducer
Frequency	Frequency				
30.0 MHz	1.0 GHz	MaxPeak	Coupled	120 kHz	HL562 201106

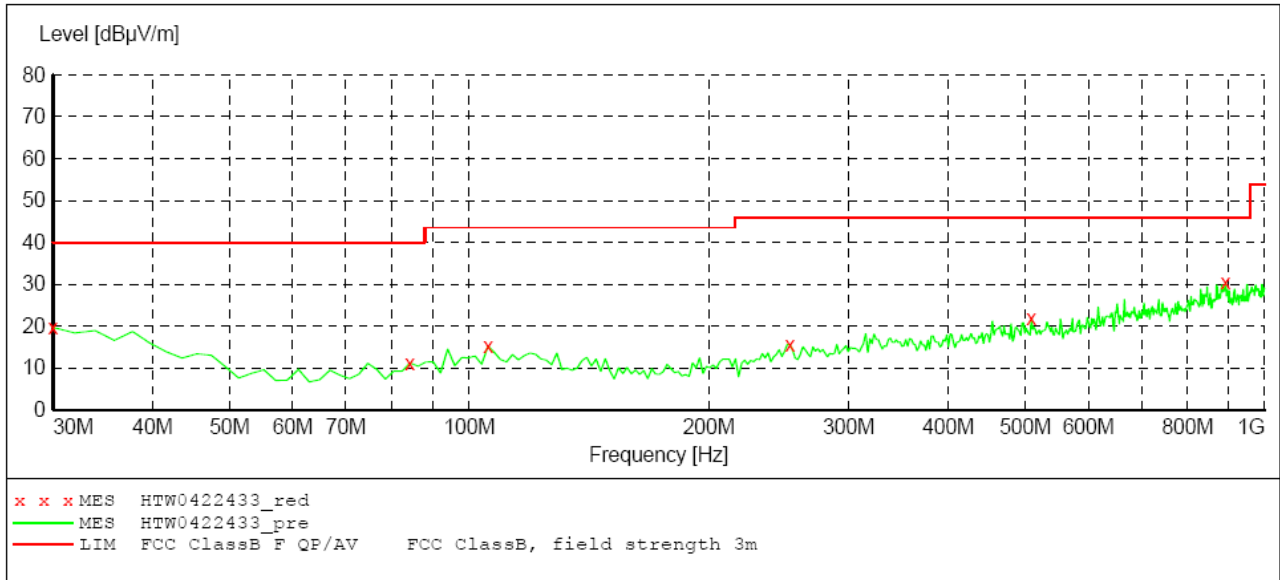

MEASUREMENT RESULT: "HTW0422433_red"

4/22/2013 6:09PM

Frequency	Level	Transd	Limit	Margin	Det.	Height	Azimuth	Polarization
MHz	dBµV/m	dB	dBµV/m	dB		cm	deg	
30.000000	19.60	-10.0	40.0	20.4	PK	100.0	0.00	VERTICAL
84.320000	11.20	-19.8	40.0	28.8	PK	100.0	0.00	VERTICAL
105.660000	15.20	-18.2	43.5	28.3	PK	100.0	0.00	VERTICAL
253.100000	15.60	-16.7	46.0	30.4	PK	100.0	0.00	VERTICAL
509.180000	21.90	-11.3	46.0	24.1	PK	100.0	0.00	VERTICAL
893.300000	30.40	-4.3	46.0	15.6	PK	100.0	0.00	VERTICAL

Modulation Type	Channel Separation	Test Frequency (MHz)	Polar.	Maximum Radiated Emissions		FCC Limit (dBuV/m)
				Frequency (MHz)	Datum (dBuV/m)	
FM	12.5 KHz	806.5000	H	18000.00	45.80	54.00
			V	18000.00	45.80	54.00
Test Results			Compliance			

SWEEP TABLE: "test (1G-18G) P"

Short Description: EN 55022 Field Strength
 Start Stop Detector Meas. IF Transducer
 Frequency Frequency Time Bandw.
 1.0 GHz 18.0 GHz MaxPeak Coupled 1 MHz HF906 2011
 Average

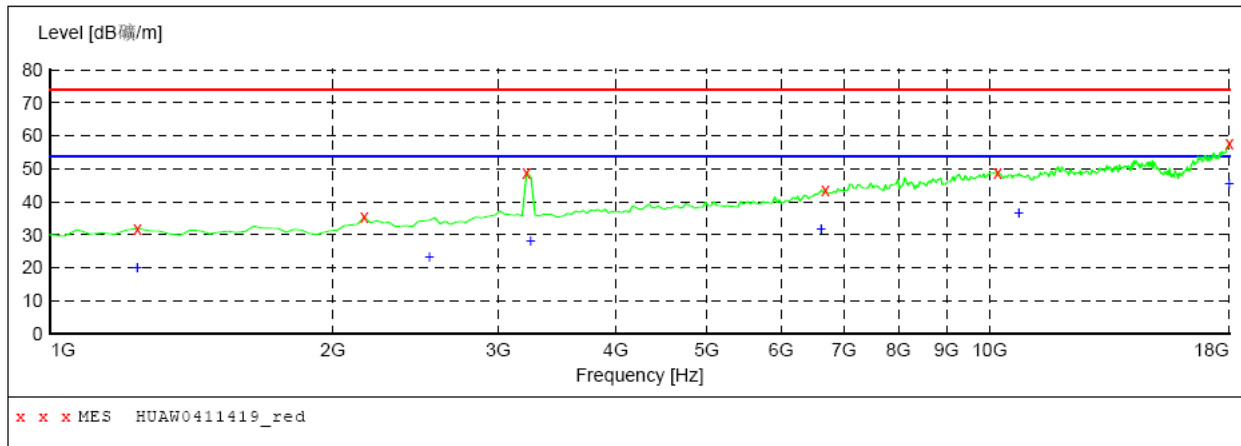

MEASUREMENT RESULT: "HUAW0411419_red"

4/11/2013 4:41PM

Frequency MHz	Level dBμV/m	Transd dB	Limit dBμV/m	Margin dB	Det.	Height cm	Azimuth deg	Polarization
1238.476954	31.90	-8.5	73.9	42.0	PK	100.0	296.00	VERTICAL
2158.316633	35.40	-5.3	73.9	38.5	PK	100.0	353.00	VERTICAL
3214.428858	48.90	-2.8	73.9	25.0	PK	100.0	282.00	VERTICAL
6689.378758	43.50	8.1	73.9	30.4	PK	100.0	327.00	VERTICAL
10198.396794	49.00	13.1	73.9	24.9	PK	100.0	152.00	VERTICAL
18000.000000	57.80	26.3	73.9	16.1	PK	100.0	353.00	VERTICAL

MEASUREMENT RESULT: "HUAW0411419_red2"

4/11/2013 4:41PM

Frequency MHz	Level dBμV/m	Transd dB	Limit dBμV/m	Margin dB	Det.	Height cm	Azimuth deg	Polarization
1238.476954	20.10	-8.5	53.9	33.8	AV	100.0	35.00	VERTICAL
2533.066132	23.20	-5.1	53.9	30.7	AV	100.0	152.00	VERTICAL
3248.496994	28.40	-2.9	53.9	25.5	AV	100.0	282.00	VERTICAL
6621.242485	31.70	8.0	53.9	22.2	AV	100.0	341.00	VERTICAL
10743.486974	36.90	13.9	53.9	17.0	AV	100.0	353.00	VERTICAL
18000.000000	45.80	26.3	53.9	8.1	AV	100.0	360.00	VERTICAL

SWEEP TABLE: "test (1G-18G) P"

Short Description: EN 55022 Field Strength
 Start Stop Detector Meas. IF Transducer
 Frequency Frequency Time Bandw.
 1.0 GHz 18.0 GHz MaxPeak Coupled 1 MHz HF906 2011
 Average

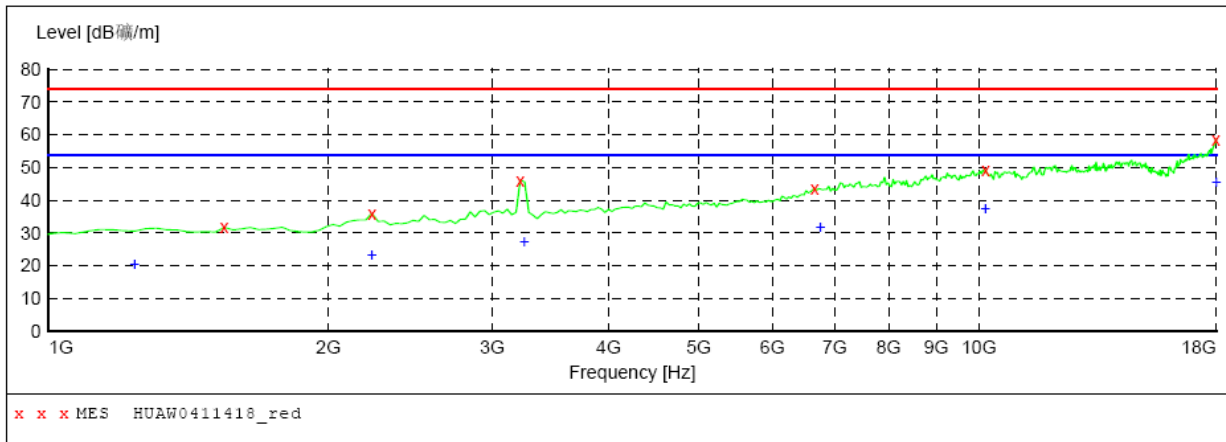

MEASUREMENT RESULT: "HUAW0411418_red"

4/11/2013 4:39PM

Frequency MHz	Level dBμV/m	Transd dB	Limit dBμV/m	Margin dB	Det.	Height cm	Azimuth deg	Polarization
1545.090180	31.70	-8.4	73.9	42.2	PK	100.0	271.00	HORIZONTAL
2226.452906	36.00	-4.9	73.9	37.9	PK	100.0	271.00	HORIZONTAL
3214.428858	46.10	-2.8	73.9	27.8	PK	100.0	3.00	HORIZONTAL
6655.310621	43.60	8.0	73.9	30.3	PK	100.0	169.00	HORIZONTAL
10164.328657	49.40	13.1	73.9	24.5	PK	100.0	260.00	HORIZONTAL
17965.931864	58.70	25.9	73.9	15.2	PK	100.0	260.00	HORIZONTAL

MEASUREMENT RESULT: "HUAW0411418_red2"

4/11/2013 4:39PM

Frequency MHz	Level dBμV/m	Transd dB	Limit dBμV/m	Margin dB	Det.	Height cm	Azimuth deg	Polarization
1238.476954	20.50	-8.5	53.9	33.4	AV	100.0	353.00	HORIZONTAL
2226.452906	23.30	-4.9	53.9	30.6	AV	100.0	317.00	HORIZONTAL
3248.496994	27.50	-2.9	53.9	26.4	AV	100.0	3.00	HORIZONTAL
6757.515030	32.00	8.3	53.9	21.9	AV	100.0	126.00	HORIZONTAL
10164.328657	37.50	13.1	53.9	16.4	AV	100.0	53.00	HORIZONTAL
18000.000000	45.80	26.3	53.9	8.1	AV	100.0	360.00	HORIZONTAL

Modulation Type	Channel Separation	Test Frequency (MHz)	Polar.	Maximum Radiated Emissions		FCC Limit (dBuV/m)
				Frequency (MHz)	Datum (dBuV/m)	
4FSK	12.5 KHz	806.5000	H	879.72	30.00	46.00
			V	897.18	30.70	46.00
Test Results			Compliance			

SWEEP TABLE: "test (30M-1G)"

Short Description:		Field Strength			
Start	Stop	Detector	Meas.	IF	Transducer
Frequency	Frequency		Time	Bandw.	
30.0 MHz	1.0 GHz	MaxPeak	Coupled	120 kHz	HL562 201106

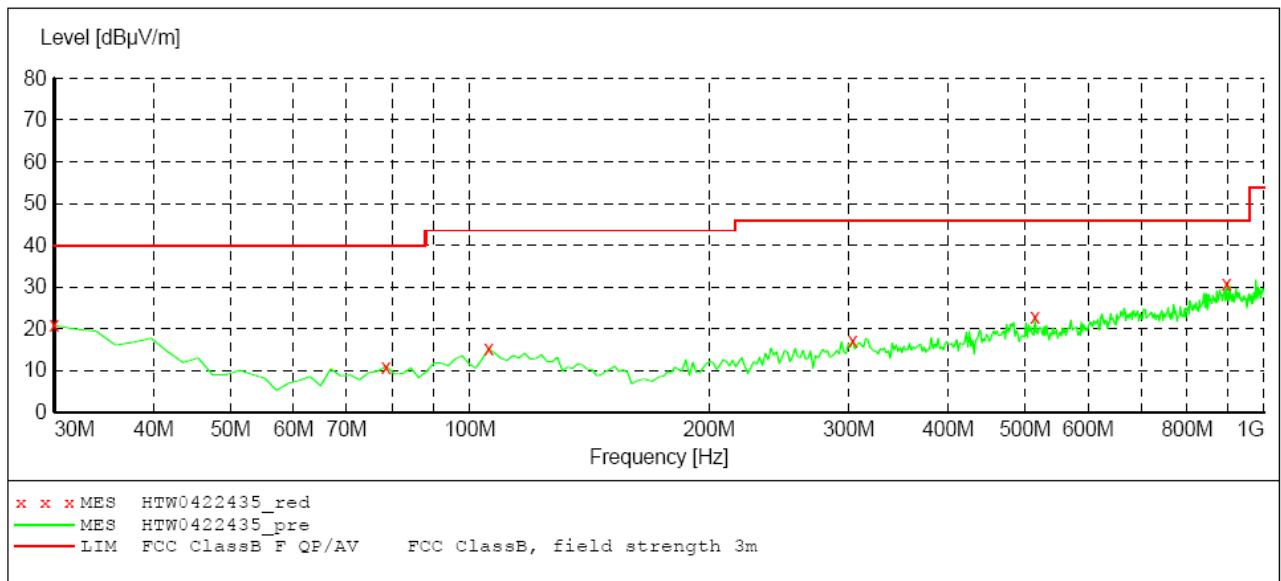

MEASUREMENT RESULT: "HTW0422435_red"

4/22/2013 6:10PM

Frequency MHz	Level dBuV/m	Transd dB	Limit dBuV/m	Margin dB	Det.	Height cm	Azimuth deg	Polarization
30.000000	20.80	-10.0	40.0	19.2	PK	100.0	0.00	VERTICAL
78.500000	10.90	-20.8	40.0	29.1	PK	100.0	0.00	VERTICAL
105.660000	15.20	-18.2	43.5	28.3	PK	100.0	0.00	VERTICAL
303.540000	17.00	-15.1	46.0	29.0	PK	100.0	0.00	VERTICAL
515.000000	22.80	-11.1	46.0	23.2	PK	100.0	0.00	VERTICAL
897.180000	30.70	-4.6	46.0	15.3	PK	100.0	0.00	VERTICAL

SWEEP TABLE: "test (30M-1G)"

Short Description:		Field Strength			
Start	Stop	Detector	Meas.	IF	Transducer
Frequency	Frequency		Time	Bandw.	
30.0 MHz	1.0 GHz	MaxPeak	Coupled	120 kHz	HL562 201106

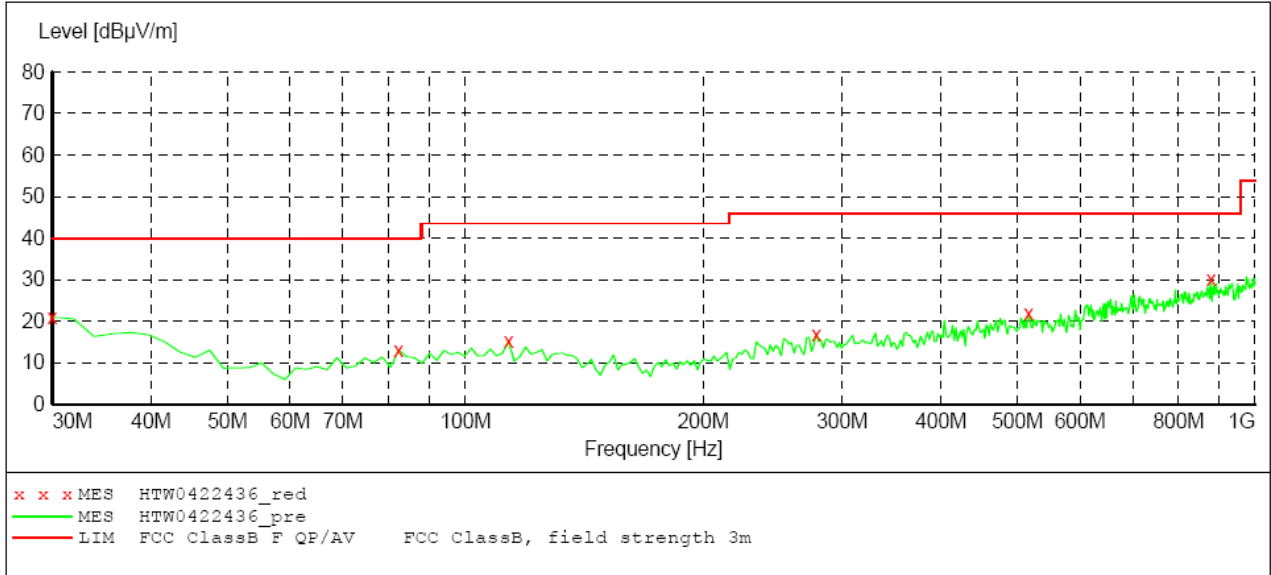

MEASUREMENT RESULT: "HTW0422436_red"

4/22/2013 6:11PM

Frequency MHz	Level dBuV/m	Transd dB	Limit dBuV/m	Margin dB	Det.	Height cm	Azimuth deg	Polarization
30.000000	20.90	-10.0	40.0	19.1	PK	100.0	0.00	HORIZONTAL
82.380000	13.00	-20.2	40.0	27.0	PK	100.0	0.00	HORIZONTAL
113.420000	15.10	-18.1	43.5	28.4	PK	100.0	0.00	HORIZONTAL
278.320000	16.80	-16.3	46.0	29.2	PK	100.0	0.00	HORIZONTAL
516.940000	21.90	-11.0	46.0	24.1	PK	100.0	0.00	HORIZONTAL
879.720000	30.00	-4.4	46.0	16.0	PK	100.0	0.00	HORIZONTAL

Modulation Type	Channel Separation	Test Frequency (MHz)	Polar.	Maximum Radiated Emissions		FCC Limit (dBuV/m)
				Frequency (MHz)	Datum (dBuV/m)	
4FSK	12.5 KHz	806.5000	H	18000.00	45.80	54.00
			V	18000.00	45.80	54.00
Test Results			Compliance			

SWEEP TABLE: "test (1G-18G) P"

Short Description: EN 55022 Field Strength
 Start Stop Detector Meas. IF Transducer
 Frequency Frequency Time Bandw.
 1.0 GHz 18.0 GHz MaxPeak Coupled 1 MHz HF906 2011
 Average

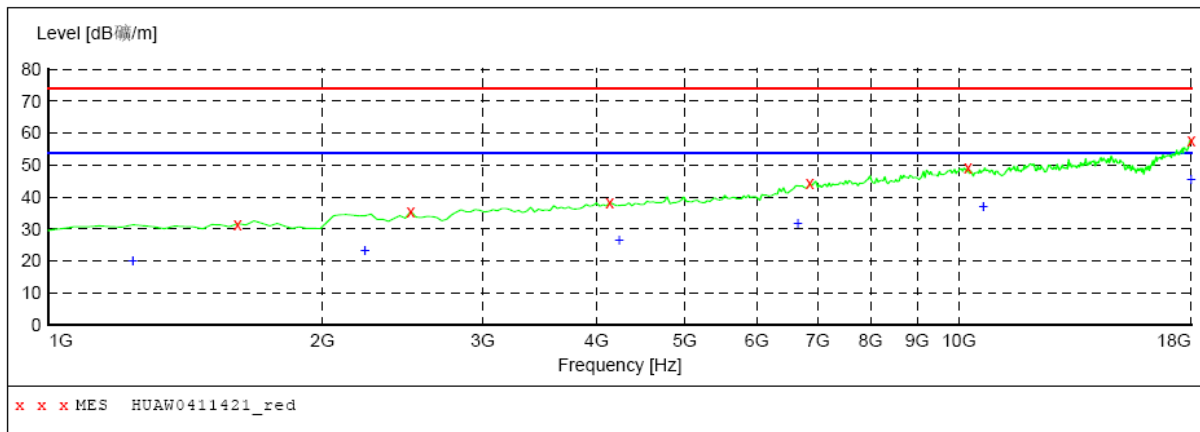

MEASUREMENT RESULT: "HUAW0411421_red"

4/11/2013 4:45PM

Frequency MHz	Level dBμV/m	Transd dB	Limit dBμV/m	Margin dB	Det.	Height cm	Azimuth deg	Polarization
1613.226453	31.60	-8.4	73.9	42.3	PK	100.0	112.00	VERTICAL
2498.997996	35.40	-5.2	73.9	38.5	PK	100.0	300.00	VERTICAL
4134.268537	38.30	0.1	73.9	35.6	PK	100.0	39.00	VERTICAL
6859.719439	44.20	8.8	73.9	29.7	PK	100.0	170.00	VERTICAL
10232.464930	49.10	13.2	73.9	24.8	PK	100.0	39.00	VERTICAL
18000.000000	57.80	26.3	73.9	16.1	PK	100.0	170.00	VERTICAL

MEASUREMENT RESULT: "HUAW0411421_red2"

4/11/2013 4:45PM

Frequency MHz	Level dBμV/m	Transd dB	Limit dBμV/m	Margin dB	Det.	Height cm	Azimuth deg	Polarization
1238.476954	20.10	-8.5	53.9	33.8	AV	100.0	241.00	VERTICAL
2226.452906	23.30	-4.9	53.9	30.6	AV	100.0	260.00	VERTICAL
4236.472946	26.80	0.3	53.9	27.1	AV	100.0	1.00	VERTICAL
6655.310621	31.80	8.0	53.9	22.1	AV	100.0	331.00	VERTICAL
10641.282565	37.00	13.3	53.9	16.9	AV	100.0	354.00	VERTICAL
18000.000000	45.80	26.3	53.9	8.1	AV	100.0	354.00	VERTICAL

SWEEP TABLE: "test (1G-18G) P"

Short Description: EN 55022 Field Strength
 Start Stop Detector Meas. IF Transducer
 Frequency Frequency Time Bandw.
 1.0 GHz 18.0 GHz MaxPeak Coupled 1 MHz HF906 2011
 Average

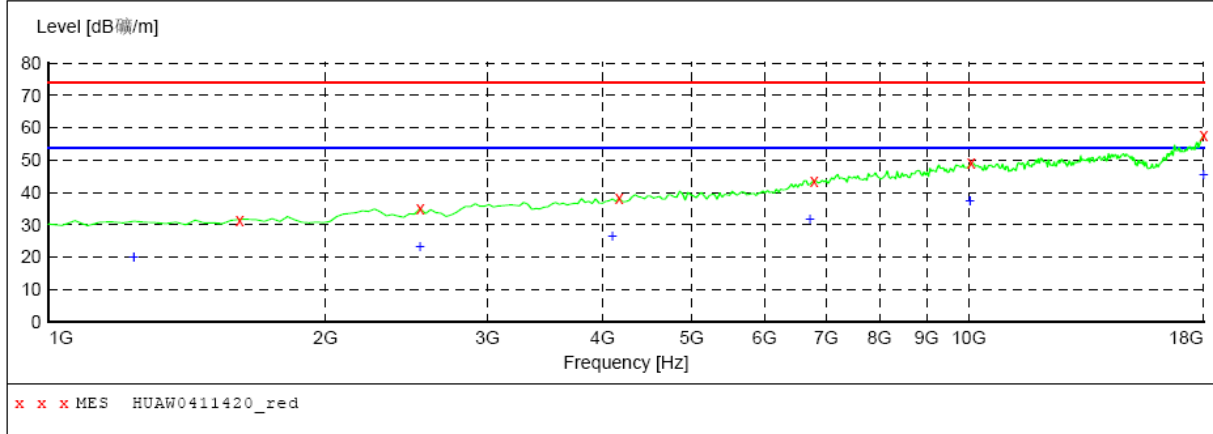

MEASUREMENT RESULT: "HUAW0411420_red"

4/11/2013 4:43PM

Frequency MHz	Level dBμV/m	Transd dB	Limit dBμV/m	Margin dB	Det.	Height cm	Azimuth deg	Polarization
1613.226453	31.60	-8.4	73.9	42.3	PK	100.0	39.00	HORIZONTAL
2533.066132	35.00	-5.1	73.9	38.9	PK	100.0	289.00	HORIZONTAL
4168.336673	38.20	0.1	73.9	35.7	PK	100.0	231.00	HORIZONTAL
6791.583166	43.70	8.4	73.9	30.2	PK	100.0	111.00	HORIZONTAL
10062.124248	49.10	13.1	73.9	24.8	PK	100.0	309.00	HORIZONTAL
18000.000000	57.80	26.3	73.9	16.1	PK	100.0	0.00	HORIZONTAL

MEASUREMENT RESULT: "HUAW0411420_red2"

4/11/2013 4:43PM

Frequency MHz	Level dBμV/m	Transd dB	Limit dBμV/m	Margin dB	Det.	Height cm	Azimuth deg	Polarization
1238.476954	20.10	-8.5	53.9	33.8	AV	100.0	359.00	HORIZONTAL
2533.066132	23.50	-5.1	53.9	30.4	AV	100.0	289.00	HORIZONTAL
4100.200401	26.60	0.0	53.9	27.3	AV	100.0	262.00	HORIZONTAL
6723.446894	31.90	8.2	53.9	22.0	AV	100.0	321.00	HORIZONTAL
10028.056112	37.50	13.2	53.9	16.4	AV	100.0	348.00	HORIZONTAL
18000.000000	45.80	26.3	53.9	8.1	AV	100.0	335.00	HORIZONTAL

Only For IC Review Not For FCC Review

Modulation Type	Channel Separation	Test Frequency (MHz)	Polar.	Maximum Radiated Emissions		IC Limit (dBuV/m)
				Frequency (MHz)	Datum (dBuV/m)	
GPS	12.5 KHz	806.5000	H	871.96	29.60	46.00
			V	860.32	30.90	46.00
Test Results			Compliance			

SWEEP TABLE: "test (30M-1G)"

Short Description: Field Strength
 Start Stop Detector Meas. IF Transducer
 Frequency Frequency Time Bandw.
 30.0 MHz 1.0 GHz MaxPeak Coupled 120 kHz HL562 201106

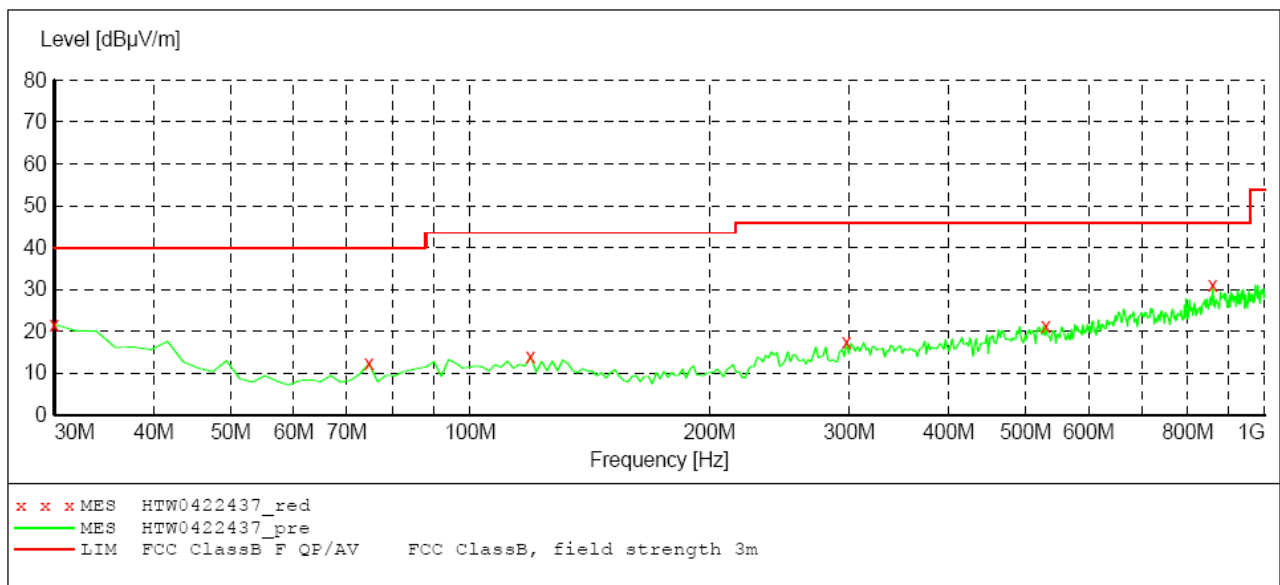

MEASUREMENT RESULT: "HTW0422437_red"

4/22/2013 6:12PM

Frequency MHz	Level dBuV/m	Transd dB	Limit dBuV/m	Margin dB	Det.	Height cm	Azimuth deg	Polarization
30.000000	21.60	-10.0	40.0	18.4	PK	100.0	0.00	VERTICAL
74.620000	12.20	-20.9	40.0	27.8	PK	100.0	0.00	VERTICAL
119.240000	14.00	-17.9	43.5	29.5	PK	100.0	0.00	VERTICAL
297.720000	17.50	-15.5	46.0	28.5	PK	100.0	0.00	VERTICAL
530.520000	21.20	-11.1	46.0	24.8	PK	100.0	0.00	VERTICAL
860.320000	30.90	-5.1	46.0	15.1	PK	100.0	0.00	VERTICAL

SWEEP TABLE: "test (30M-1G)"

Short Description:		Field Strength			
Start	Stop	Detector	Meas.	IF	Transducer
Frequency	Frequency		Time	Bandw.	
30.0 MHz	1.0 GHz	MaxPeak	Coupled	120 kHz	HL562 201106

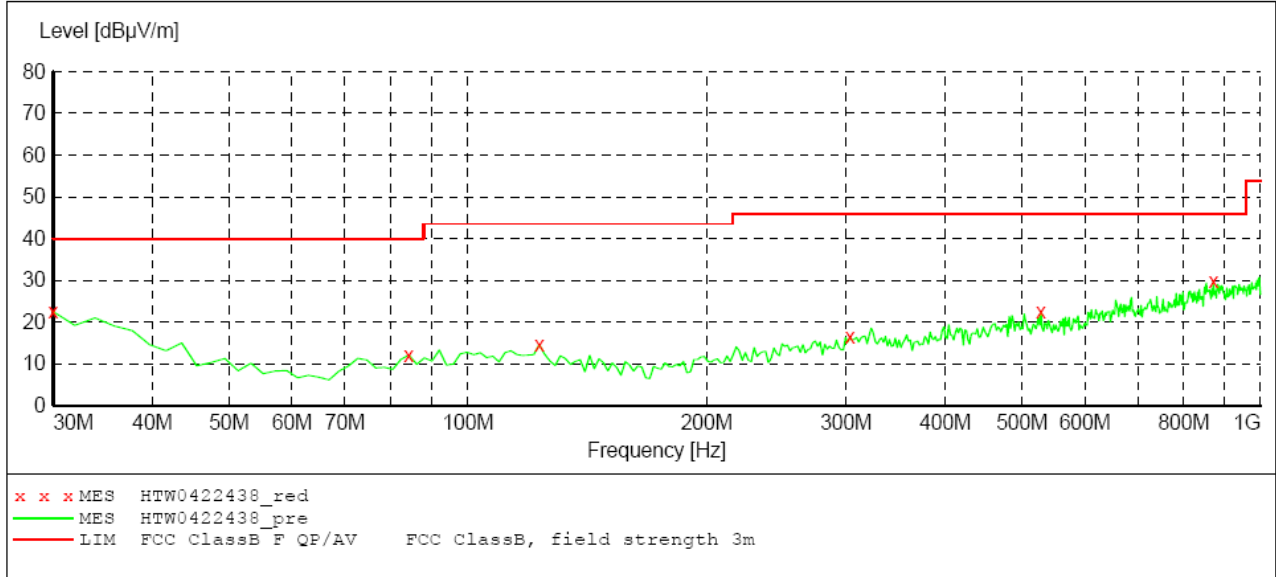

MEASUREMENT RESULT: "HTW0422438_red"

4/22/2013 6:13PM

Frequency	Level	Transd	Limit	Margin	Det.	Height	Azimuth	Polarization
MHz	dBuV/m	dB	dBuV/m	dB		cm	deg	
30.000000	22.40	-10.0	40.0	17.6	PK	100.0	0.00	HORIZONTAL
84.320000	12.10	-19.8	40.0	27.9	PK	100.0	0.00	HORIZONTAL
123.120000	14.50	-18.0	43.5	29.0	PK	100.0	0.00	HORIZONTAL
303.540000	16.40	-15.1	46.0	29.6	PK	100.0	0.00	HORIZONTAL
528.580000	22.50	-11.0	46.0	23.5	PK	100.0	0.00	HORIZONTAL
871.960000	29.60	-4.4	46.0	16.4	PK	100.0	0.00	HORIZONTAL

Modulation Type	Channel Separation	Test Frequency (MHz)	Polar.	Maximum Radiated Emissions		IC Limit (dBuV/m)
				Frequency (MHz)	Datum (dBuV/m)	
GPS	12.5 KHz	806.5000	H	18000.00	45.80	54.00
			V	18000.00	45.80	54.00
Test Results			Compliance			

SWEEP TABLE: "test (1G-18G) P"

Short Description: EN 55022 Field Strength
 Start Stop Detector Meas. IF Transducer
 Frequency Frequency Time Bandw.
 1.0 GHz 18.0 GHz MaxPeak Coupled 1 MHz HF906 2011
 Average

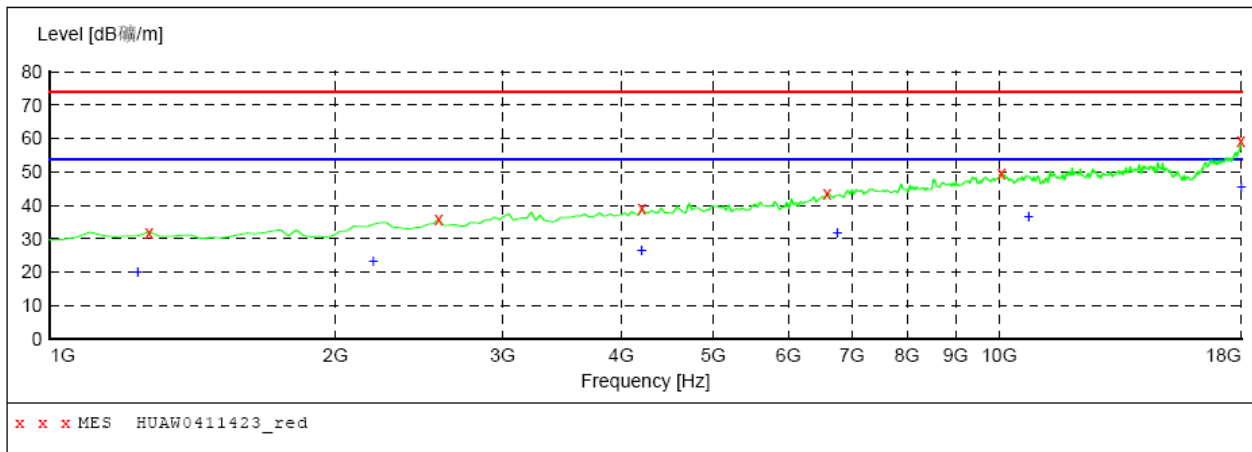

MEASUREMENT RESULT: "HUAW0411423_red"

4/11/2013 4:49PM

Frequency MHz	Level dB/m	Transd dB	Limit dB/m	Margin dB	Det.	Height cm	Azimuth deg	Polarization
1272.545090	32.00	-8.2	73.9	41.9	PK	100.0	65.00	VERTICAL
2567.134269	35.80	-5.0	73.9	38.1	PK	100.0	232.00	VERTICAL
4202.404810	39.00	0.2	73.9	34.9	PK	100.0	360.00	VERTICAL
6587.174349	43.60	7.8	73.9	30.3	PK	100.0	251.00	VERTICAL
10062.124248	49.80	13.1	73.9	24.1	PK	100.0	39.00	VERTICAL
17965.931864	59.40	25.9	73.9	14.5	PK	100.0	206.00	VERTICAL

MEASUREMENT RESULT: "HUAW0411423_red2"

4/11/2013 4:49PM

Frequency MHz	Level dB/m	Transd dB	Limit dB/m	Margin dB	Det.	Height cm	Azimuth deg	Polarization
1238.476954	20.10	-8.5	53.9	33.8	AV	100.0	232.00	VERTICAL
2192.384770	23.30	-5.0	53.9	30.6	AV	100.0	308.00	VERTICAL
4202.404810	26.70	0.2	53.9	27.2	AV	100.0	308.00	VERTICAL
6757.515030	32.00	8.3	53.9	21.9	AV	100.0	93.00	VERTICAL
10743.486974	36.90	13.9	53.9	17.0	AV	100.0	251.00	VERTICAL
18000.000000	45.80	26.3	53.9	8.1	AV	100.0	360.00	VERTICAL

SWEEP TABLE: "test (1G-18G) P"

Short Description: EN 55022 Field Strength
 Start Stop Detector Meas. IF Transducer
 Frequency Frequency Time Bandw.
 1.0 GHz 18.0 GHz MaxPeak Coupled 1 MHz HF906 2011
 Average

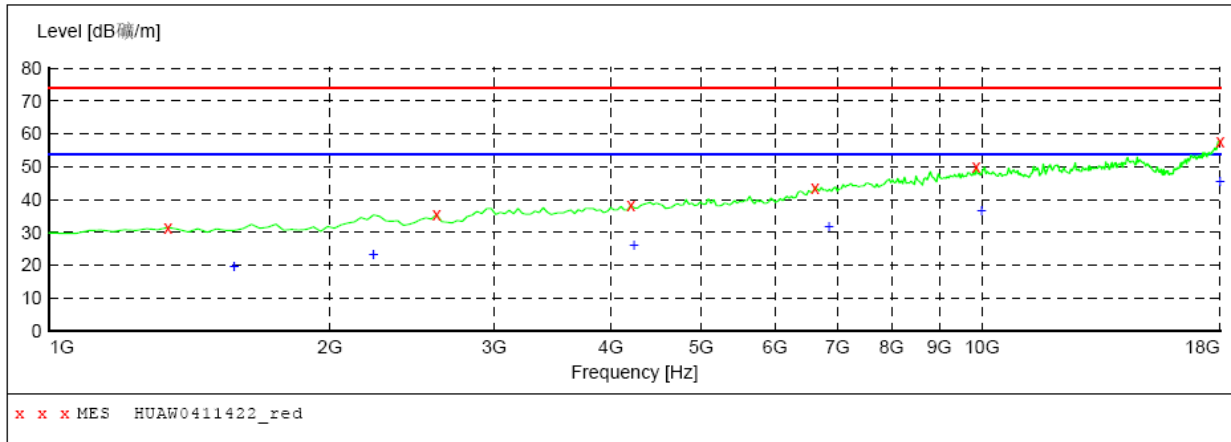

MEASUREMENT RESULT: "HUAW0411422_red"

4/11/2013 4:47PM

Frequency MHz	Level dBμV/m	Transd dB	Limit dBμV/m	Margin dB	Det.	Height cm	Azimuth deg	Polarization
1340.681363	31.50	-8.0	73.9	42.4	PK	100.0	169.00	HORIZONTAL
2601.202405	35.40	-5.0	73.9	38.5	PK	100.0	125.00	HORIZONTAL
4202.404810	38.20	0.2	73.9	35.7	PK	100.0	360.00	HORIZONTAL
6621.242485	43.70	8.0	73.9	30.2	PK	100.0	125.00	HORIZONTAL
9857.715431	50.10	13.0	73.9	23.8	PK	100.0	53.00	HORIZONTAL
18000.000000	57.80	26.3	73.9	16.1	PK	100.0	213.00	HORIZONTAL

MEASUREMENT RESULT: "HUAW0411422_red2"

4/11/2013 4:47PM

Frequency MHz	Level dBμV/m	Transd dB	Limit dBμV/m	Margin dB	Det.	Height cm	Azimuth deg	Polarization
1579.158317	19.90	-8.4	53.9	34.0	AV	100.0	24.00	HORIZONTAL
2226.452906	23.30	-4.9	53.9	30.6	AV	100.0	343.00	HORIZONTAL
4236.472946	26.30	0.3	53.9	27.6	AV	100.0	330.00	HORIZONTAL
6859.719439	31.80	8.8	53.9	22.1	AV	100.0	284.00	HORIZONTAL
9993.987976	36.90	13.2	53.9	17.0	AV	100.0	284.00	HORIZONTAL
18000.000000	45.80	26.3	53.9	8.1	AV	100.0	360.00	HORIZONTAL

4.9. Receiver Conducted Spurious Emission

TEST APPLICABLE

The same as Section 4.3

TEST PROCEDURE

The spectrum analyzer was connected to the RF output power of the EUT, the EUT was setup in receiving mode; The RBW of the spectrum analyzer was set to 100 kHz and the VBW set to 300 KHz below the test frequency 1GHz. While the RBW of the spectrum analyzer was set to the 1MHz and VBW set to the 3MHz from 1GHz to the 10th harmonic.

TEST CONFIGURATION

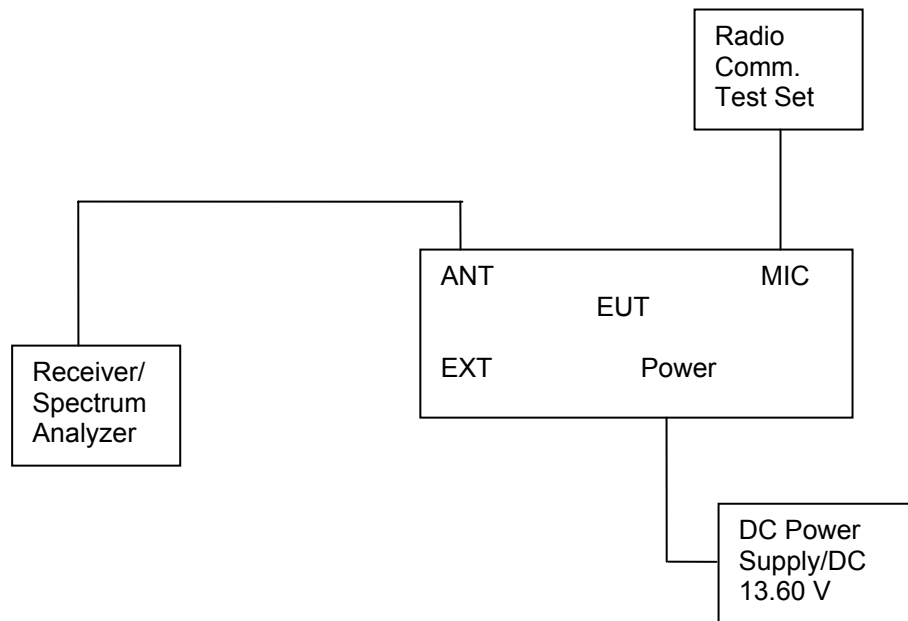

LIMIT

The power at the antenna terminal shall not exceed 2.0 nanowatts (-57dBm).

TEST RESULTS

The Receiver Conducted Spurious Emissions Measurement is performed to the three channels (the top channel, the middle channel and the bottom channel), the datums recorded below were for the three channels; and the EUT shall be scanned from 30 MHz to the 10 GHz.

Modulation Type	Channel Sparation	Test Channel	Test Frequency (MHz)	Maximum Conducted Spurious Emissions Below 1GHz		Maximum Conducted Spurious Emissions Above 1GHz		FCC Limit
				Frequency (MHz)	Datum (dBm)	Frequency (MHz)	Datum (dBm)	
FM	25KHz	Low	851.5000	515.00	-88.76	3142.00	-75.95	-57dBm
Test Results				Compliance				

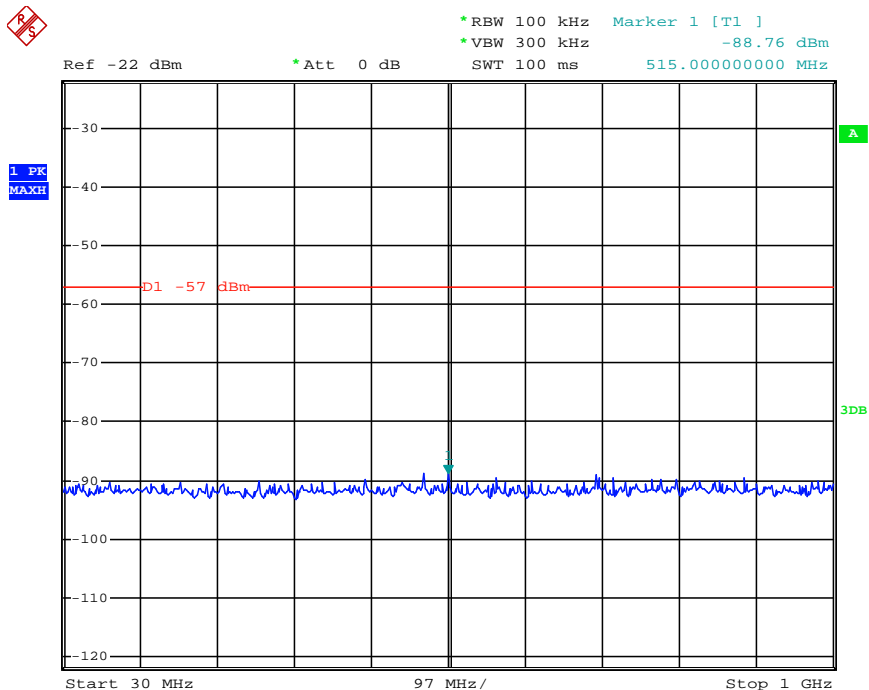

Date: 3.APR.2013 18:13:20

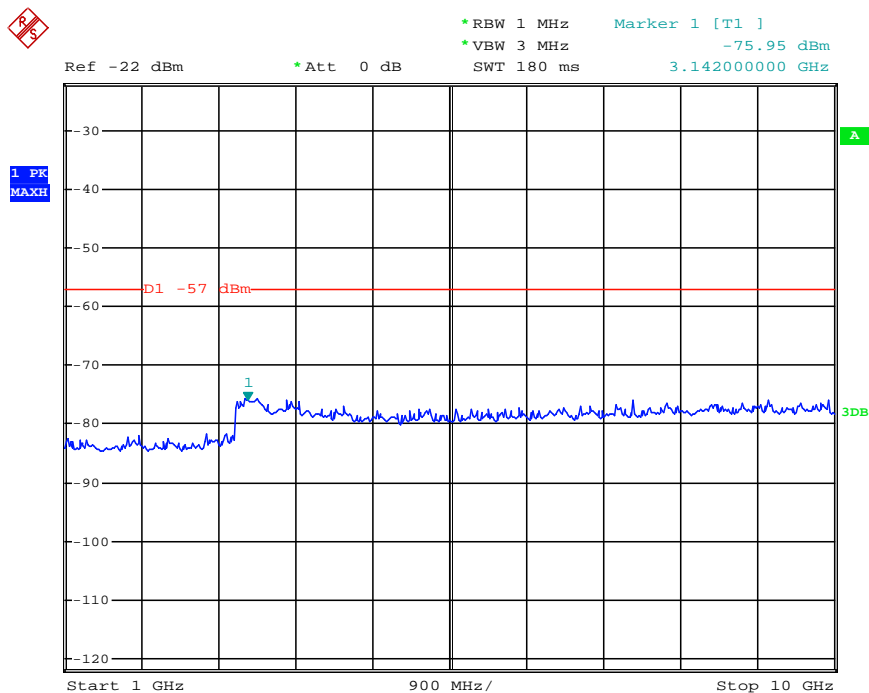

Date: 3.APR.2013 18:15:10

Modulation Type	Channel Sparation	Test Channel	Test Frequency (MHz)	Maximum Conducted Spurious Emissions Below 1GHz		Maximum Conducted Spurious Emissions Above 1GHz		FCC Limit
				Frequency (MHz)	Datum (dBm)	Frequency (MHz)	Datum (dBm)	
FM	25KHz	Middle	860.0000	321.00	-89.48	3646.00	-76.49	-57dBm
Test Results				Compliance				

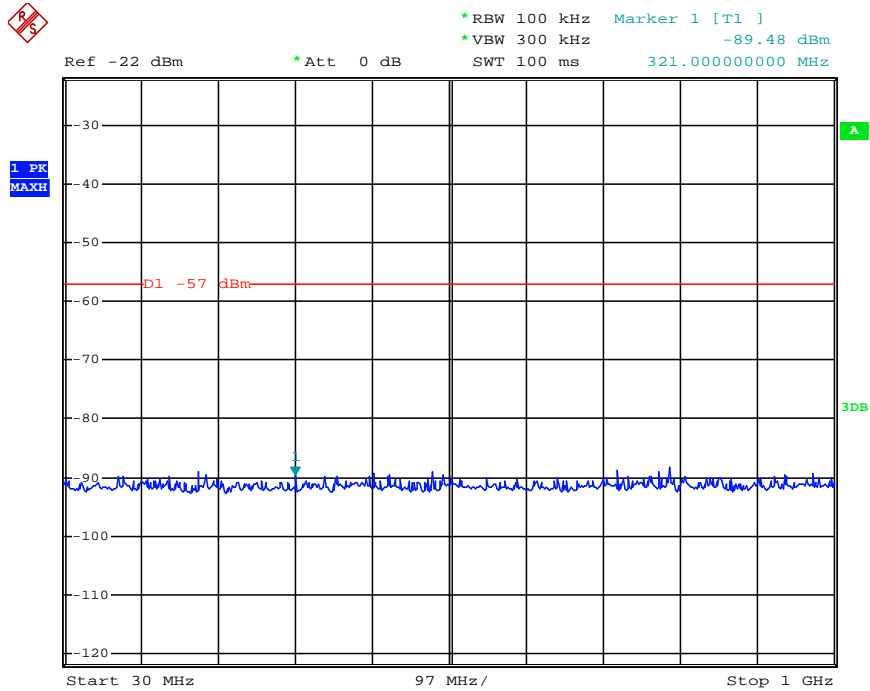

Date: 3.APR.2013 18:13:09

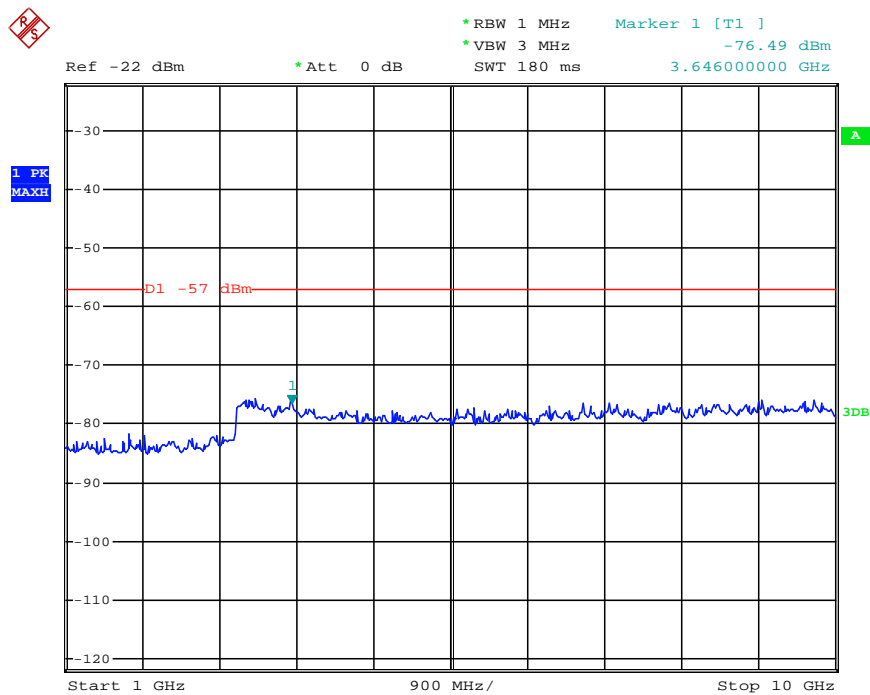

Date: 3.APR.2013 18:15:20

Modulation Type	Channel Sparation	Test Channel	Test Frequency (MHz)	Maximum Conducted Spurious Emissions Below 1GHz		Maximum Conducted Spurious Emissions Above 1GHz		FCC Limit
				Frequency (MHz)	Datum (dBm)	Frequency (MHz)	Datum (dBm)	
FM	25KHz	High	868.5000	965.08	-89.57	9136.00	-77.84	-57dBm
Test Results				Compliance				

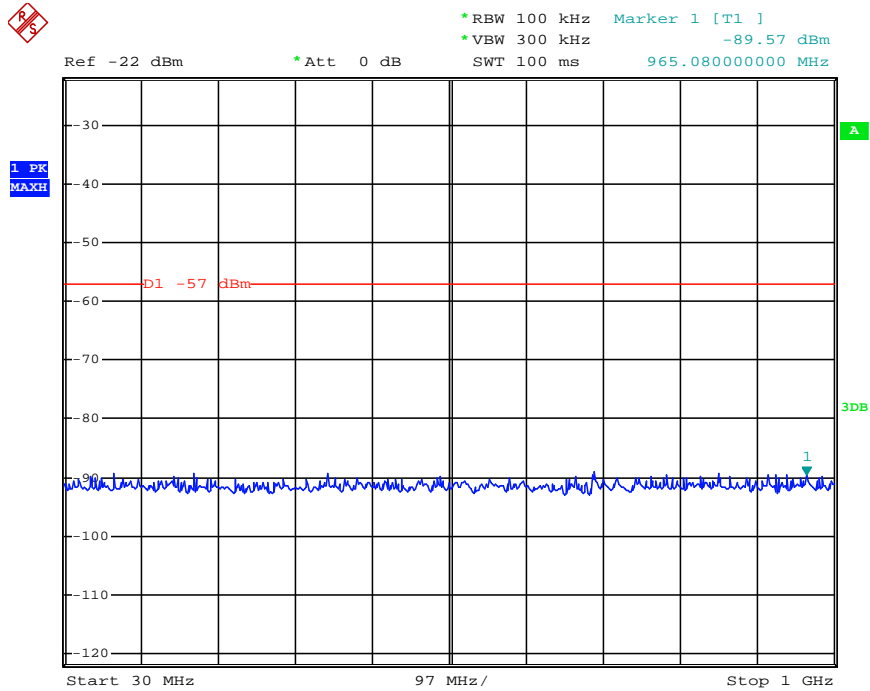

Date: 3.APR.2013 18:12:55

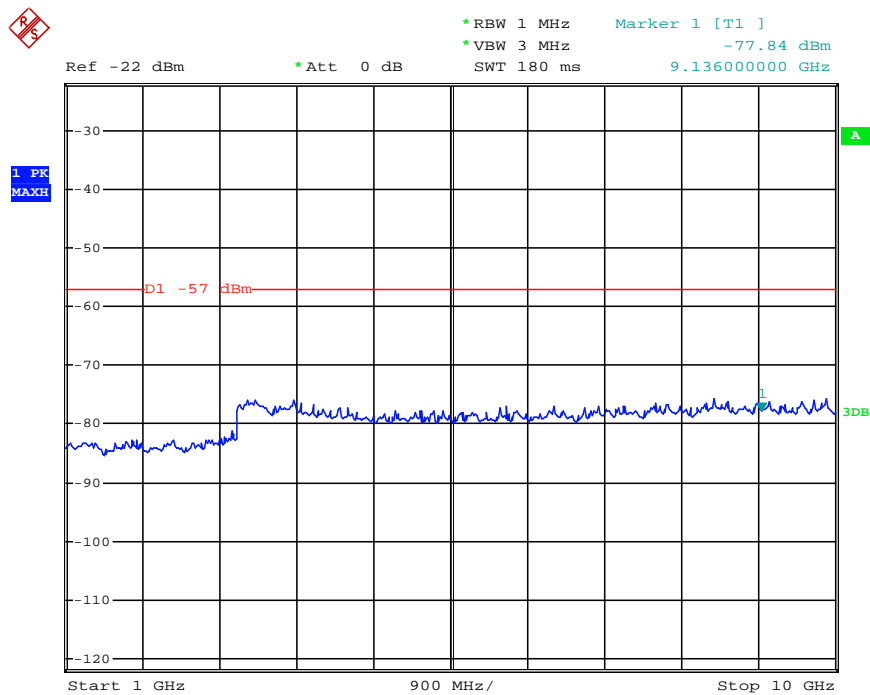

Date: 3.APR.2013 18:15:32

Modulation Type	Channel Sparation	Test Channel	Test Frequency (MHz)	Maximum Conducted Spurious Emissions Below 1GHz		Maximum Conducted Spurious Emissions Above 1GHz		FCC Limit
				Frequency (MHz)	Datum (dBm)	Frequency (MHz)	Datum (dBm)	
FM	12.5KHz	Low	851.5000	749.74	-89.87	9856.00	-76.50	-57dBm
Test Results				Compliance				

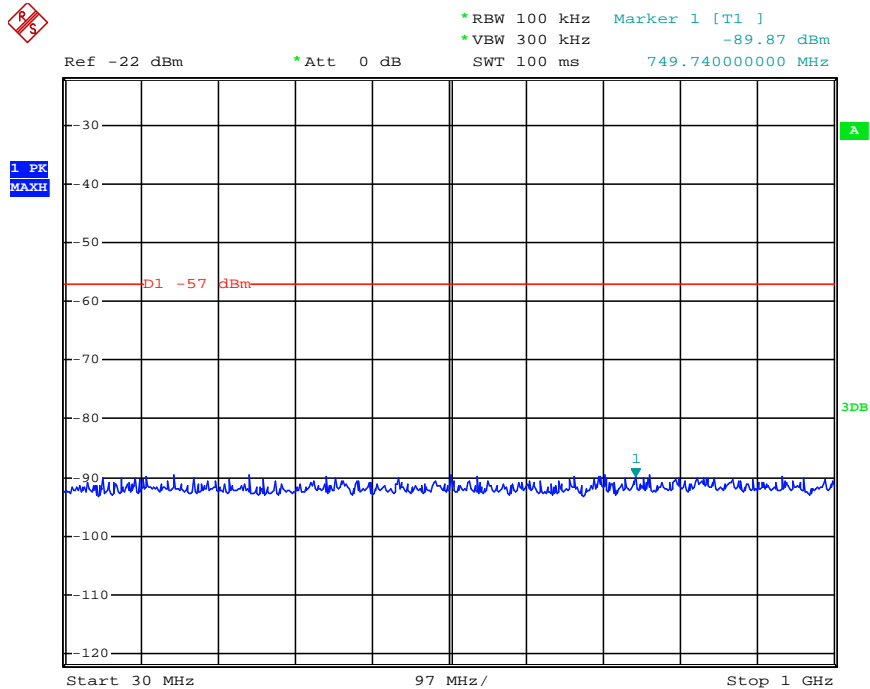

Date: 3.APR.2013 18:13:49

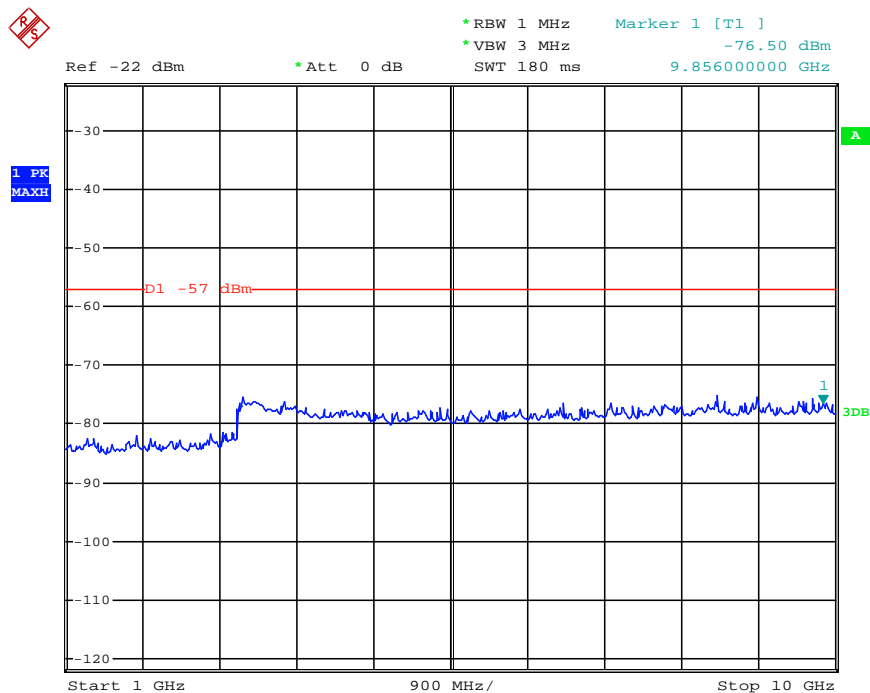

Date: 3.APR.2013 18:14:57

Modulation Type	Channel Sparation	Test Channel	Test Frequency (MHz)	Maximum Conducted Spurious Emissions Below 1GHz		Maximum Conducted Spurious Emissions Above 1GHz		FCC Limit
				Frequency (MHz)	Datum (dBm)	Frequency (MHz)	Datum (dBm)	
FM	12.5KHz	Middle	860.0000	130.88	-89.40	3646.00	-75.54	-57dBm
Test Results				Compliance				

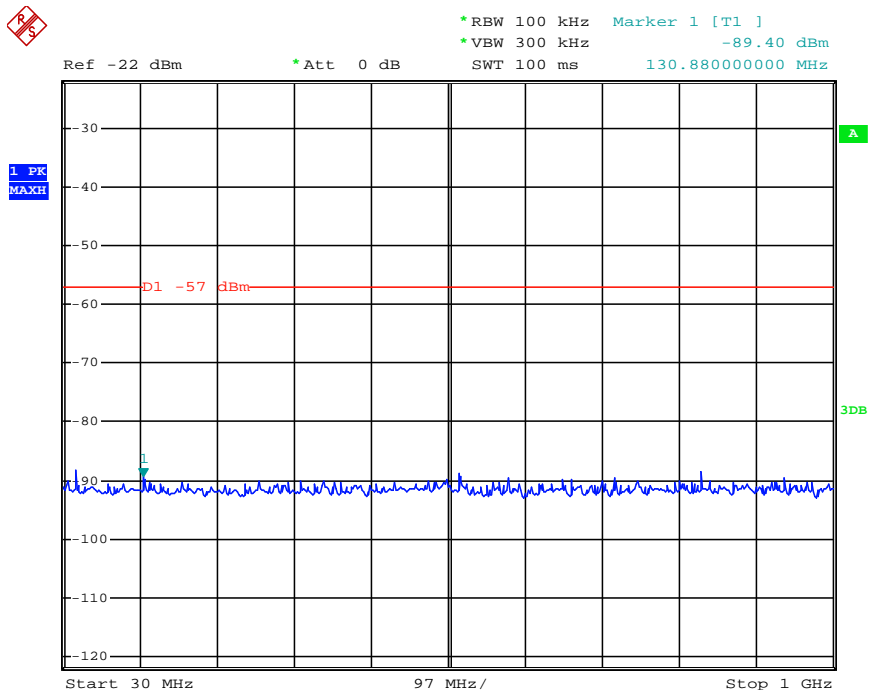

Date: 3.APR.2013 18:14:00

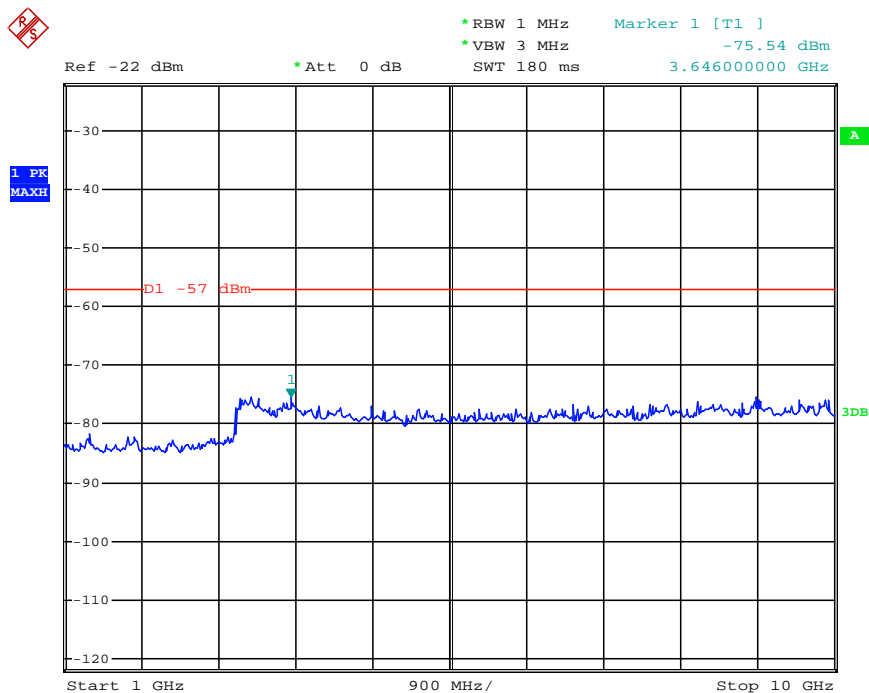

Date: 3.APR.2013 18:14:46

Modulation Type	Channel Sparation	Test Channel	Test Frequency (MHz)	Maximum Conducted Spurious Emissions Below 1GHz		Maximum Conducted Spurious Emissions Above 1GHz		FCC Limit
				Frequency (MHz)	Datum (dBm)	Frequency (MHz)	Datum (dBm)	
FM	12.5KHz	High	868.5000	487.84	-90.27	3124.00	-75.53	-57dBm
Test Results				Compliance				

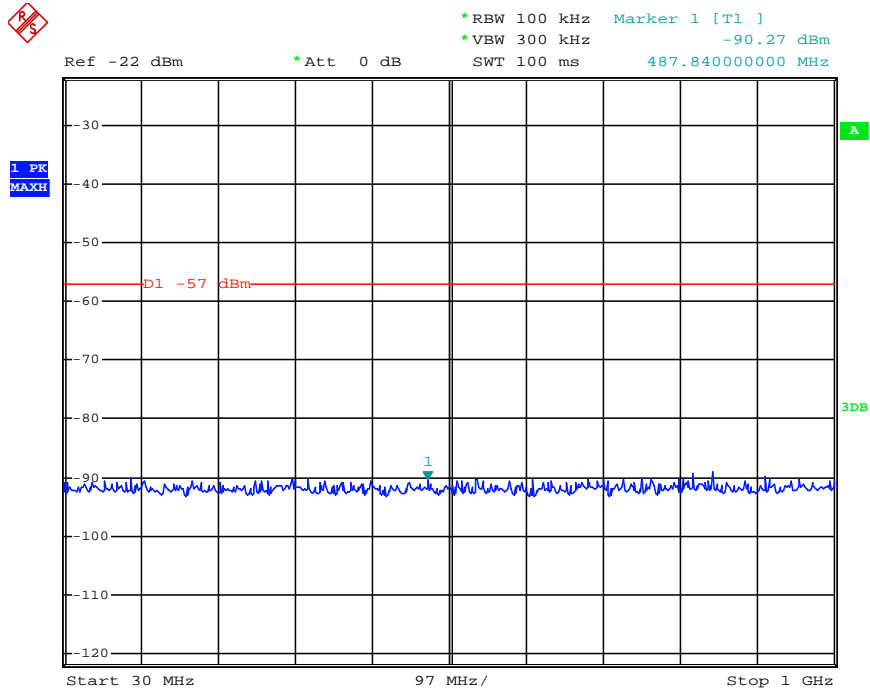

Date: 3.APR.2013 18:14:07

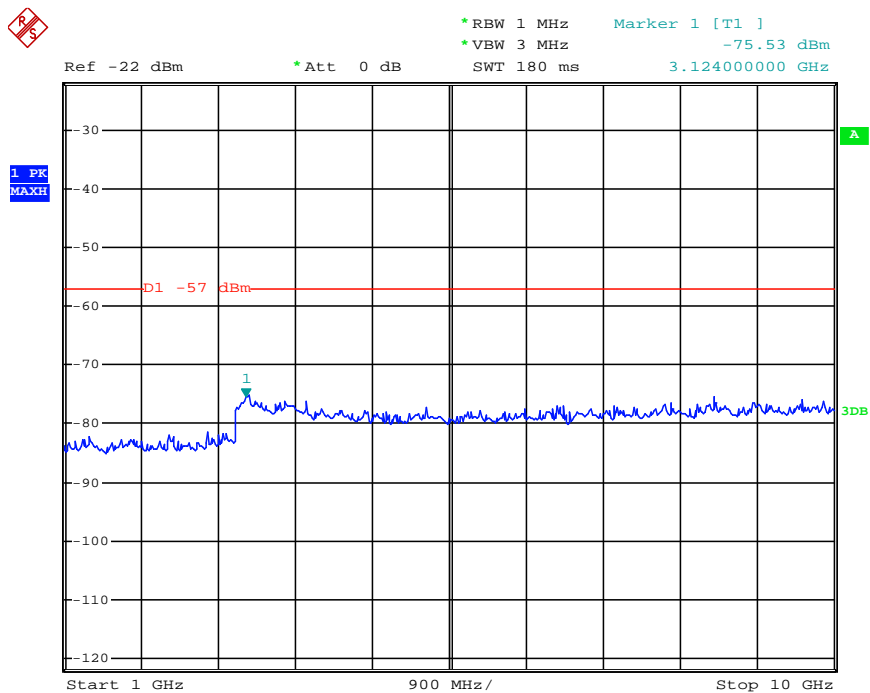

Date: 3.APR.2013 18:14:35

Modulation Type	Channel Sparation	Test Channel	Test Frequency (MHz)	Maximum Conducted Spurious Emissions Below 1GHz		Maximum Conducted Spurious Emissions Above 1GHz		FCC Limit
				Frequency (MHz)	Datum (dBm)	Frequency (MHz)	Datum (dBm)	
FM	12.5KHz	Low	935.5000	474.26	-89.59	8740.00	-75.97	-57dBm
Test Results				Compliance				

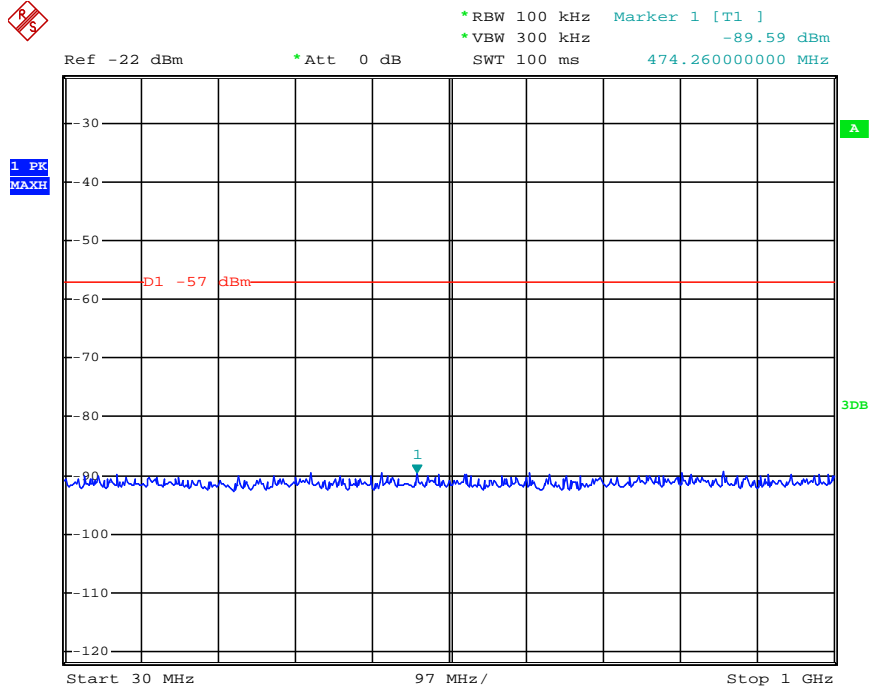

Date: 3.APR.2013 18:12:42

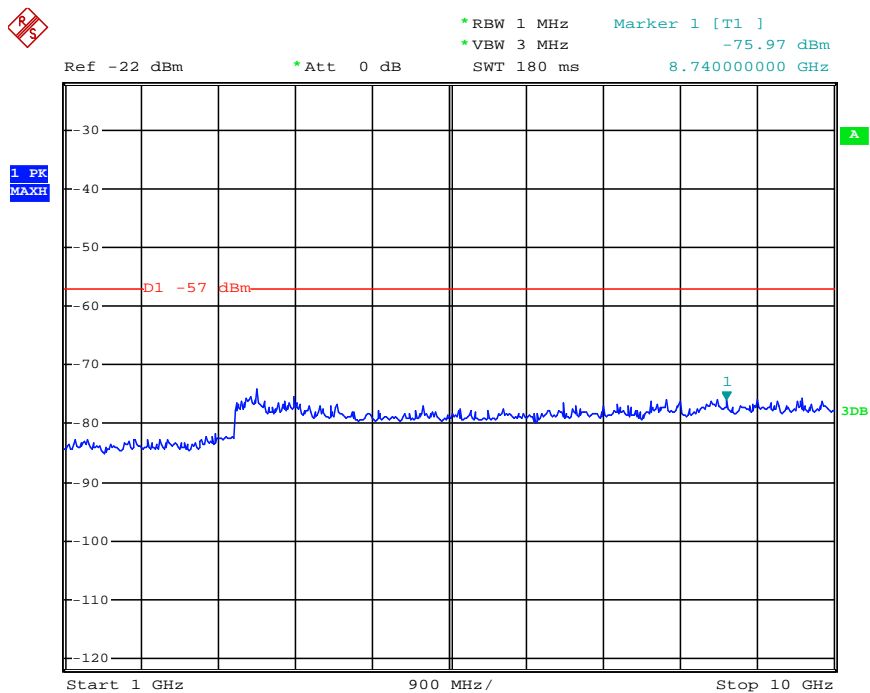

Date: 3.APR.2013 18:15:46

Modulation Type	Channel Sparation	Test Channel	Test Frequency (MHz)	Maximum Conducted Spurious Emissions Below 1GHz		Maximum Conducted Spurious Emissions Above 1GHz		FCC Limit
				Frequency (MHz)	Datum (dBm)	Frequency (MHz)	Datum (dBm)	
FM	12.5KHz	High	939.5000	644.98	-89.93	3340.00	-75.37	-57dBm
Test Results				Compliance				

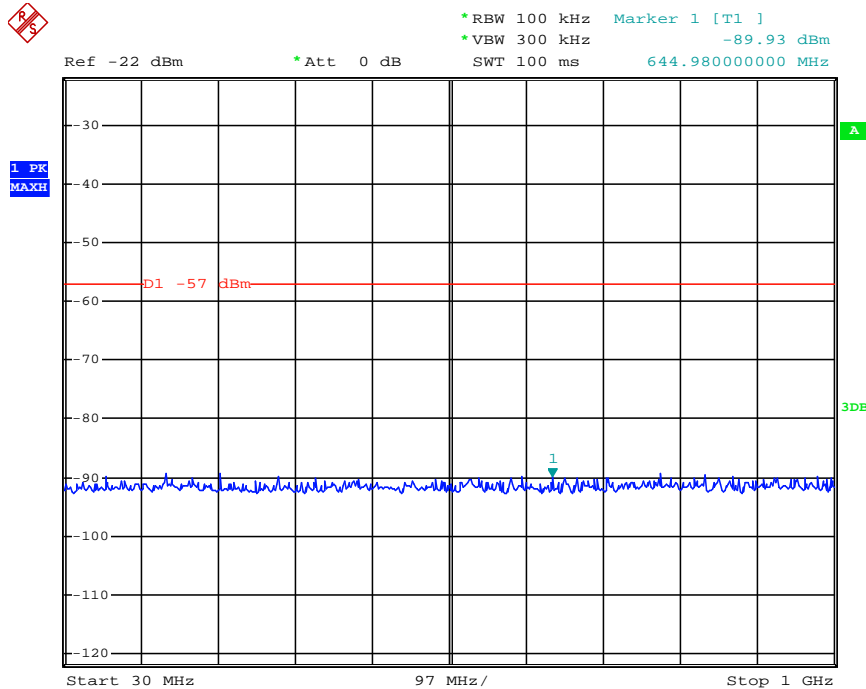

Date: 3.APR.2013 18:12:15

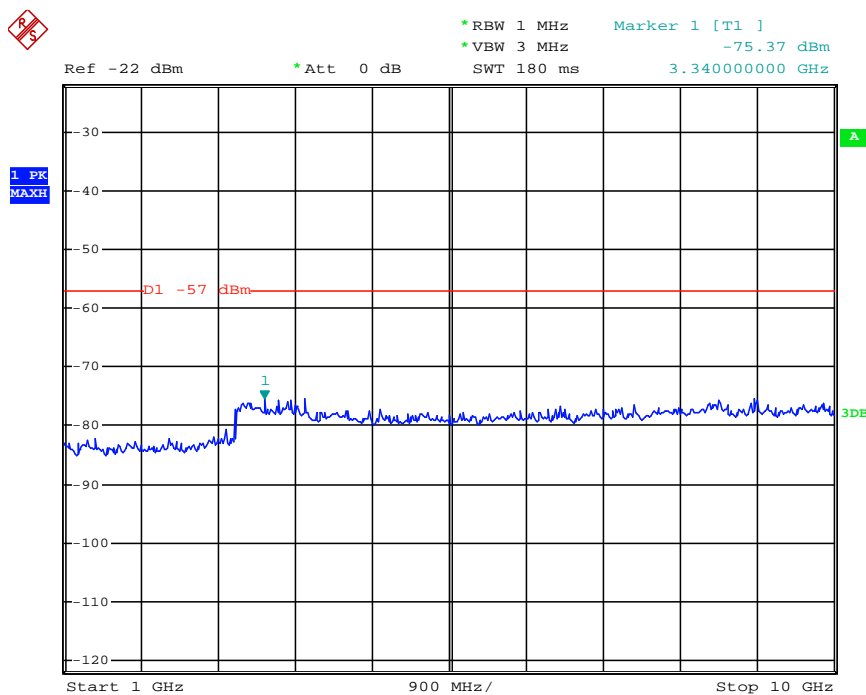

Date: 3.APR.2013 18:15:59

Modulation Type	Channel Sparation	Test Channel	Test Frequency (MHz)	Maximum Conducted Spurious Emissions Below 1GHz		Maximum Conducted Spurious Emissions Above 1GHz		FCC Limit
				Frequency (MHz)	Datum (dBm)	Frequency (MHz)	Datum (dBm)	
FSK	12.5KHz	Low	851.5000	916.58	-89.51	916.58	-89.51	-57dBm
Test Results				Compliance				

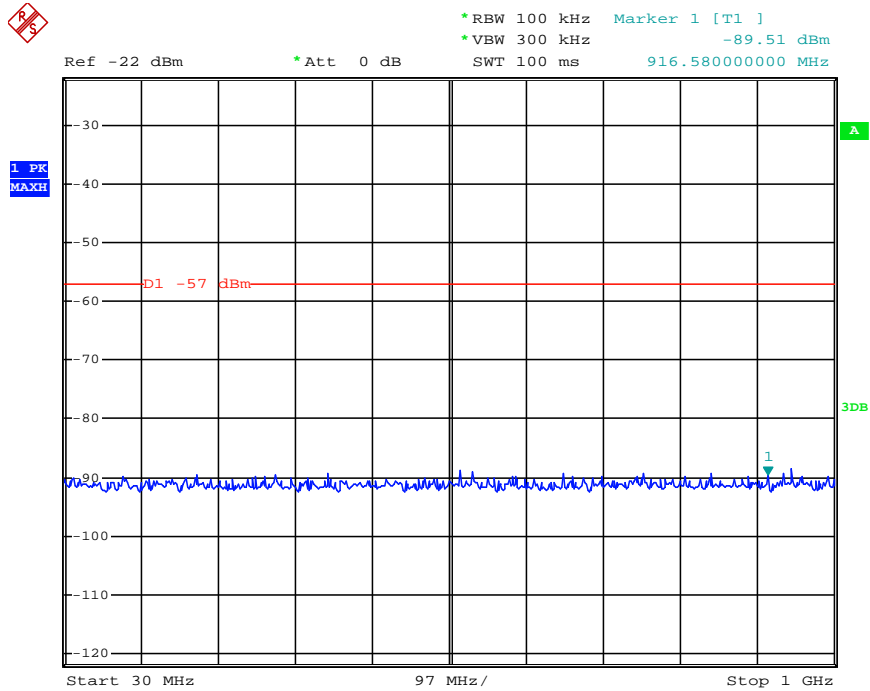

Date: 3.APR.2013 18:09:20

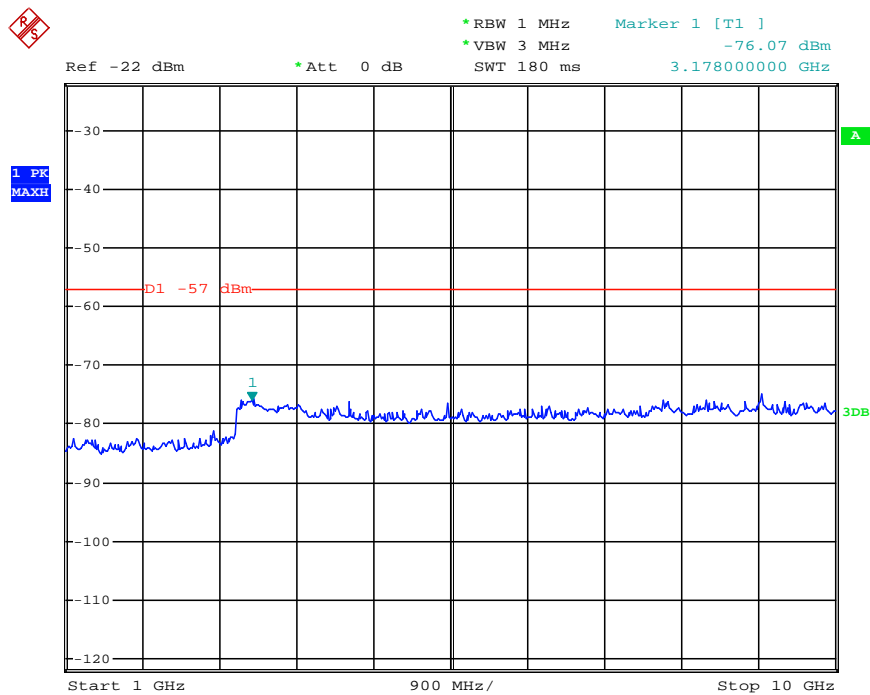

Date: 3.APR.2013 18:16:59

Modulation Type	Channel Sparation	Test Channel	Test Frequency (MHz)	Maximum Conducted Spurious Emissions Below 1GHz		Maximum Conducted Spurious Emissions Above 1GHz		FCC Limit
				Frequency (MHz)	Datum (dBm)	Frequency (MHz)	Datum (dBm)	
FSK	12.5KHz	Middle	860.0000	639.16	-89.08	3142.00	-75.68	-57dBm
Test Results				Compliance				

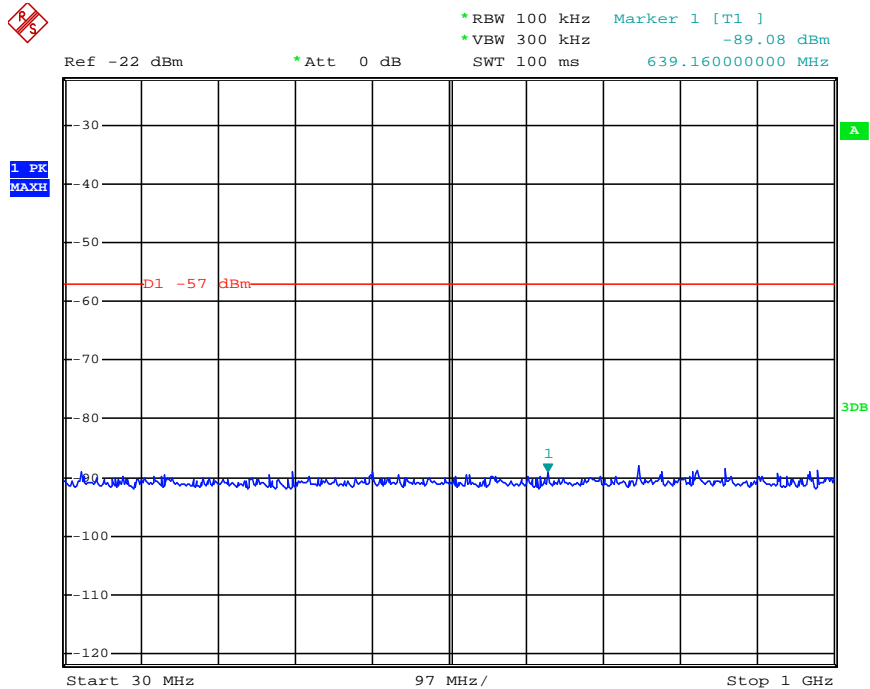

Date: 3.APR.2013 18:09:56

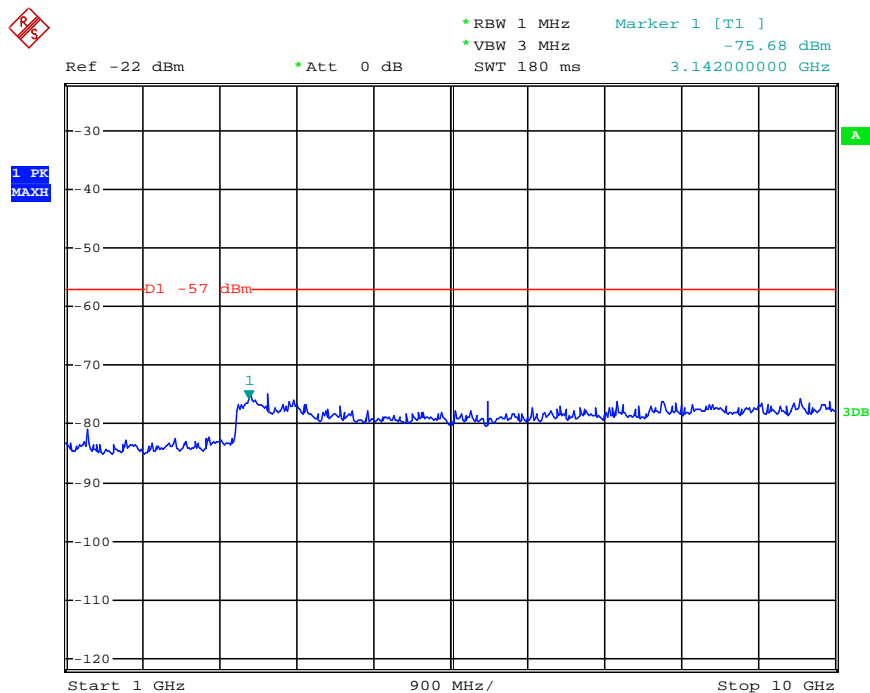

Date: 3.APR.2013 18:16:45

Modulation Type	Channel Sparation	Test Channel	Test Frequency (MHz)	Maximum Conducted Spurious Emissions Below 1GHz		Maximum Conducted Spurious Emissions Above 1GHz		FCC Limit
				Frequency (MHz)	Datum (dBm)	Frequency (MHz)	Datum (dBm)	
FSK	12.5KHz	High	868.5000	293.84	-89.44	3142.00	-75.30	-57dBm
Test Results				Compliance				

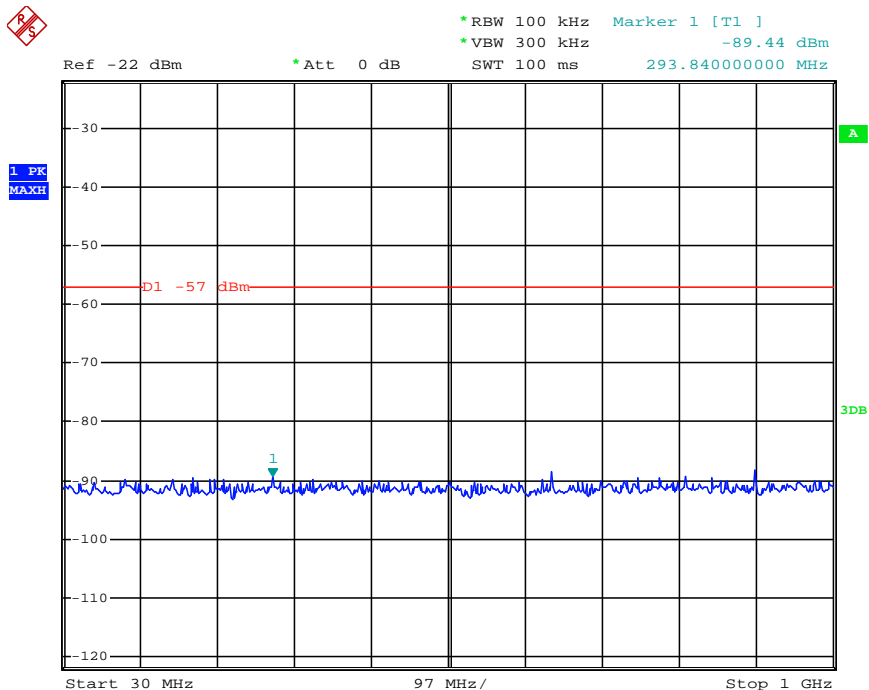

Date: 3.APR.2013 18:10:17

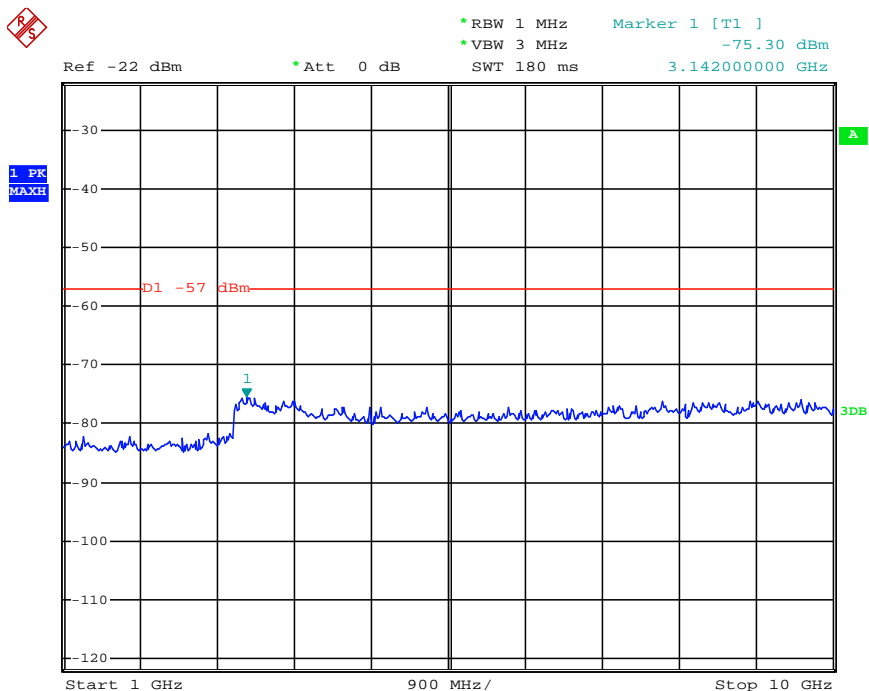

Date: 3.APR.2013 18:16:35

Modulation Type	Channel Sparation	Test Channel	Test Frequency (MHz)	Maximum Conducted Spurious Emissions Below 1GHz		Maximum Conducted Spurious Emissions Above 1GHz		FCC Limit
				Frequency (MHz)	Datum (dBm)	Frequency (MHz)	Datum (dBm)	
FSK	12.5KHz	Low	935.5000	864.20	-89.58	3160.00	-75.27	-57dBm
Test Results				Compliance				

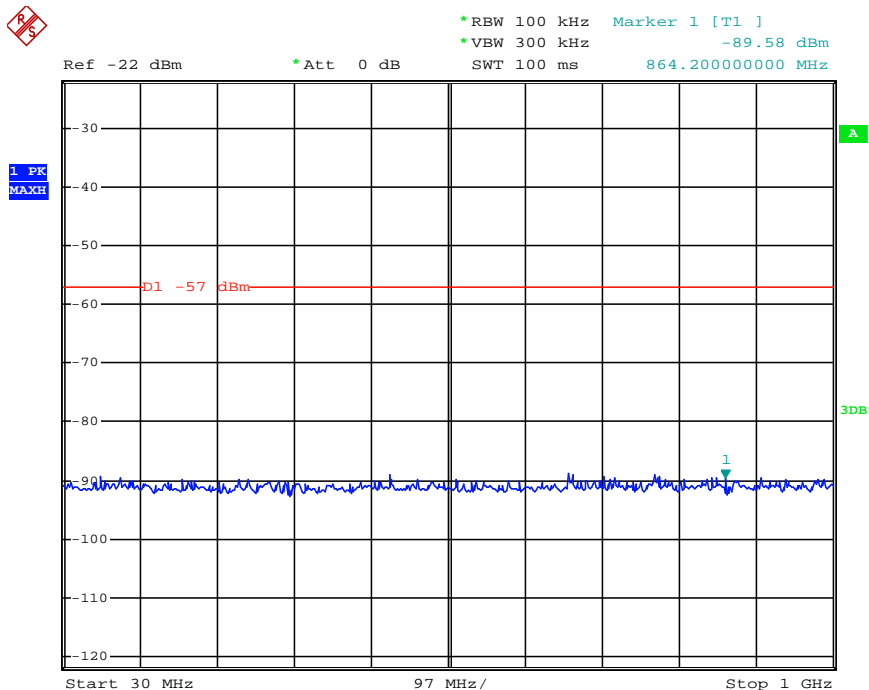

Date: 3.APR.2013 18:10:44

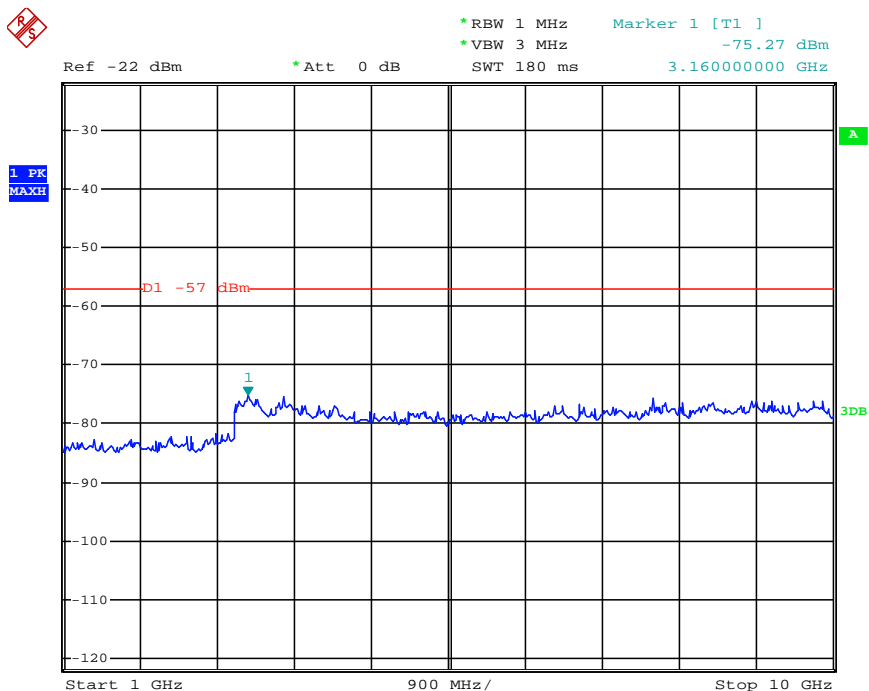

Date: 3.APR.2013 18:16:22

Modulation Type	Channel Sparation	Test Channel	Test Frequency (MHz)	Maximum Conducted Spurious Emissions Below 1GHz		Maximum Conducted Spurious Emissions Above 1GHz		FCC Limit
				Frequency (MHz)	Datum (dBm)	Frequency (MHz)	Datum (dBm)	
FSK	12.5KHz	High	939.5000	495.60	-89.40	3250.00	-75.99	-57dBm
Test Results				Compliance				

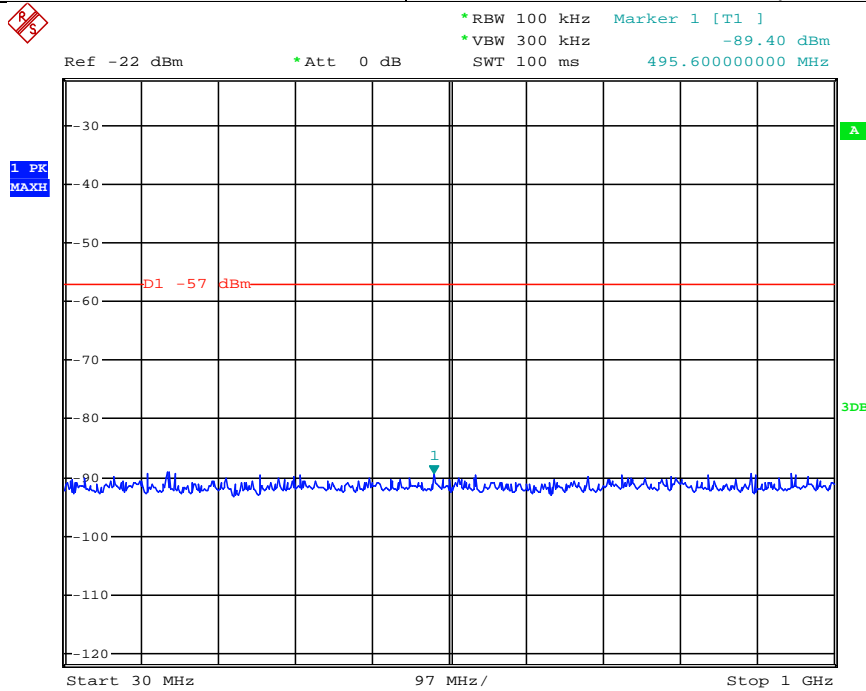

Date: 3.APR.2013 18:11:31

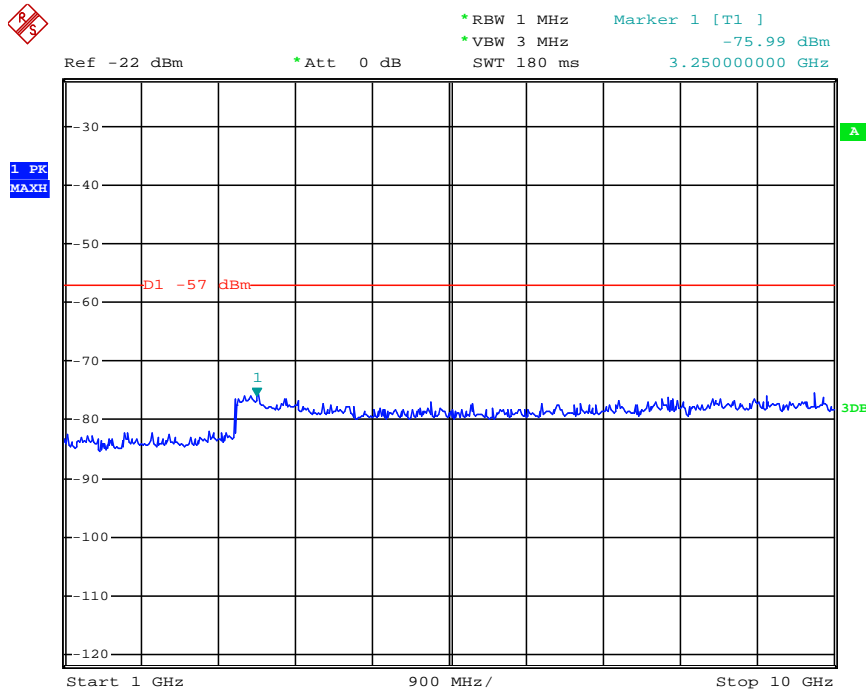

Date: 3.APR.2013 18:16:12

5. Test Setup Photos of the EUT

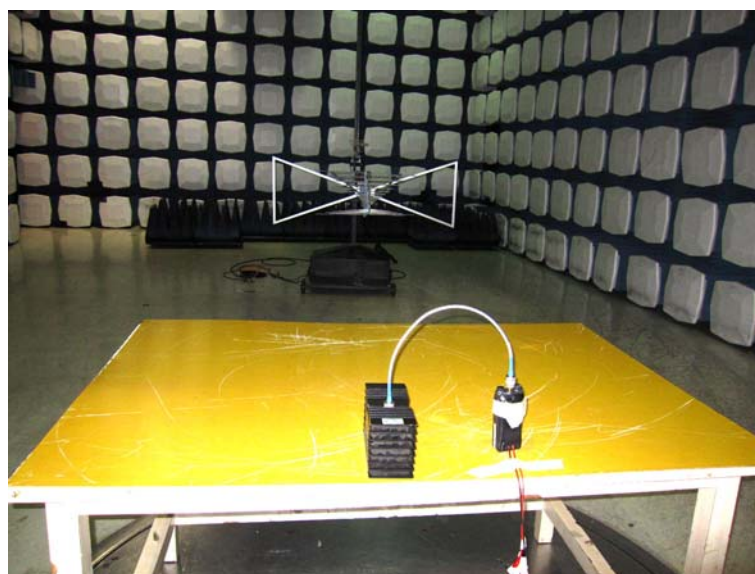
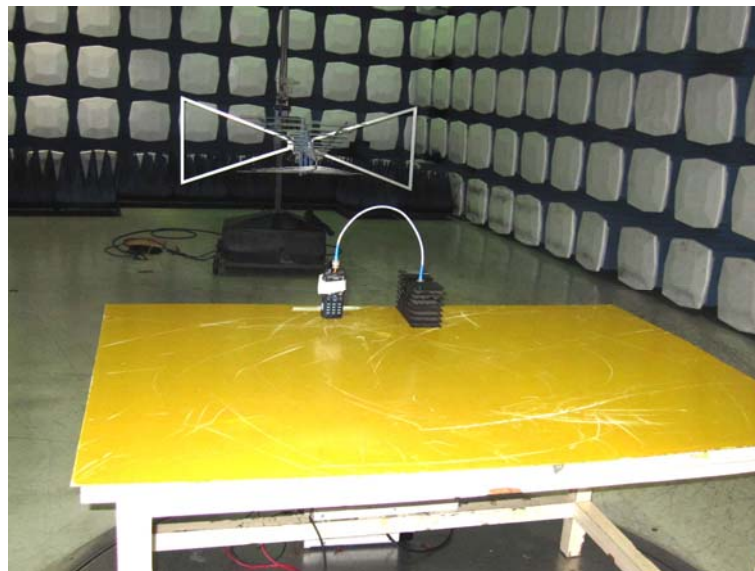

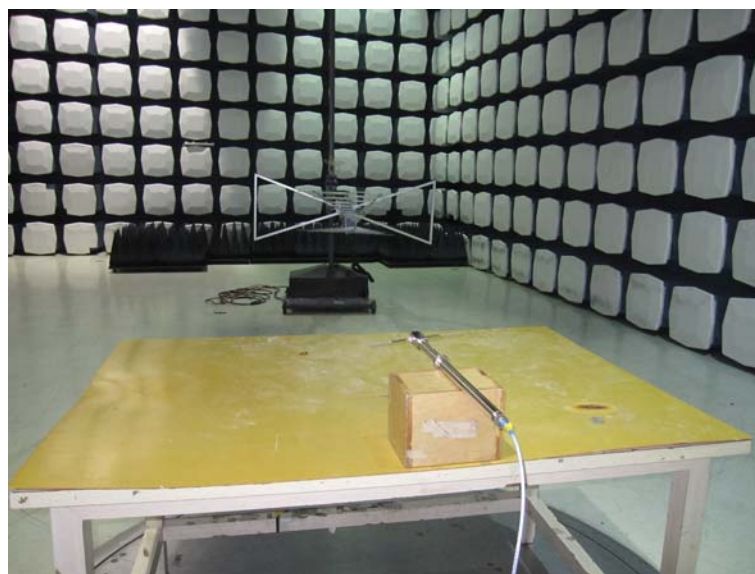

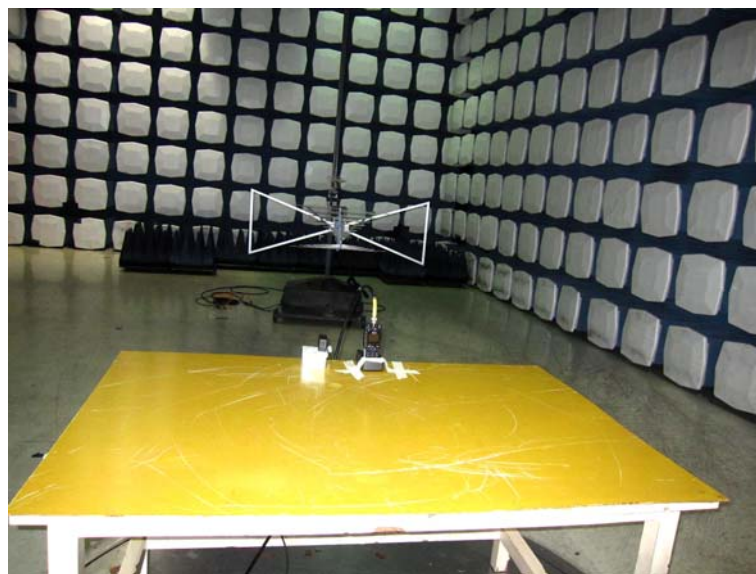
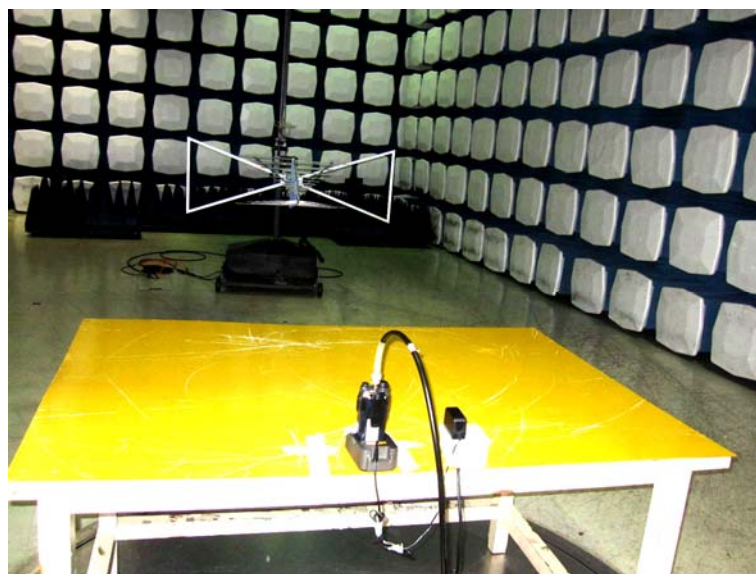
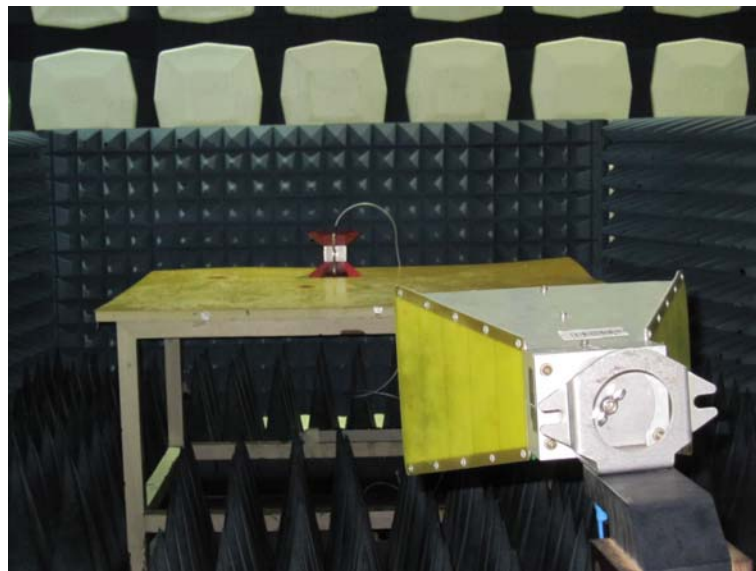

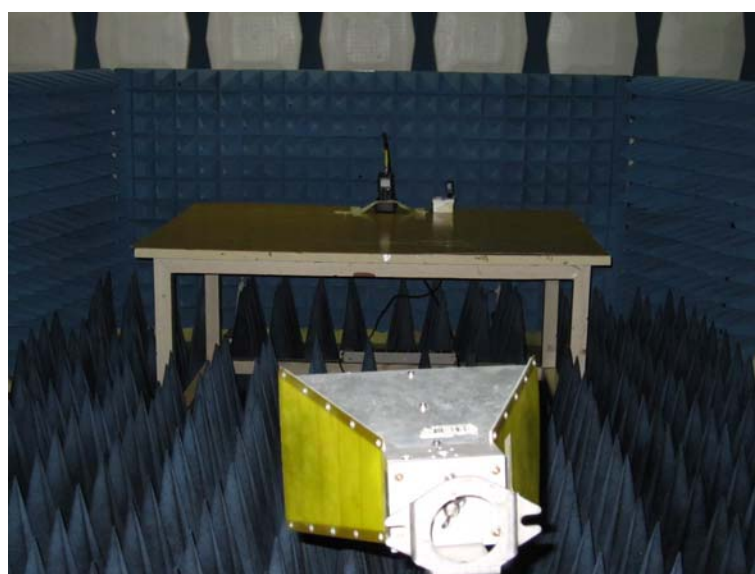

6. External and Internal Photos of the EUT

External photos of the EUT













Internal photos of the EUT



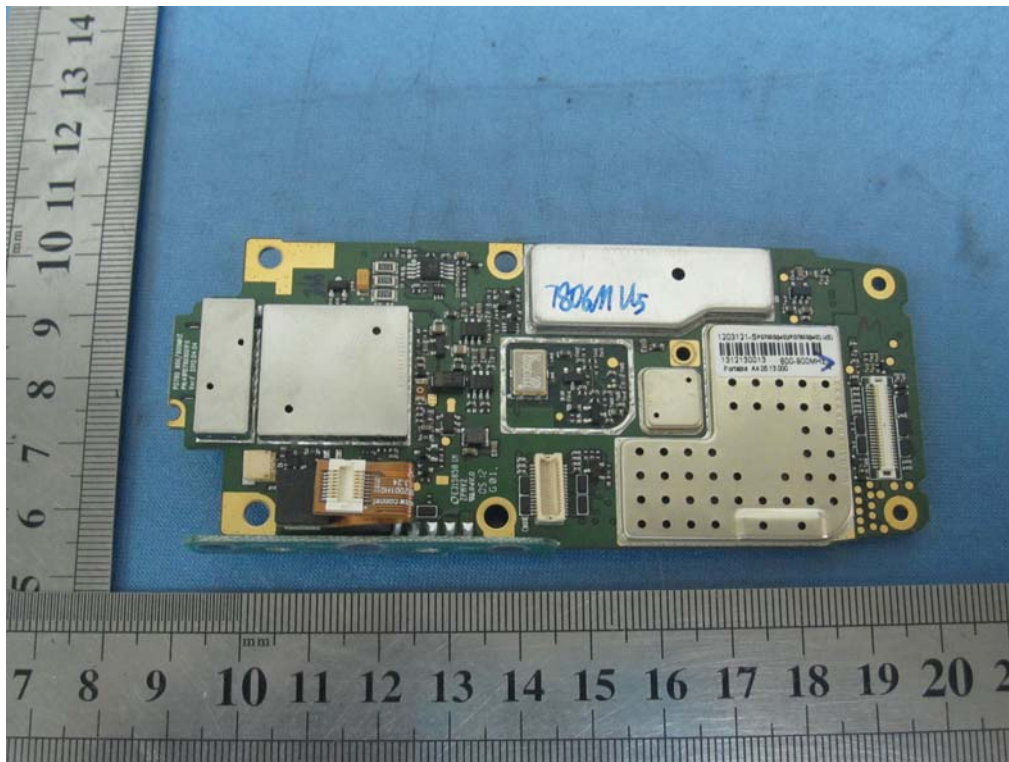
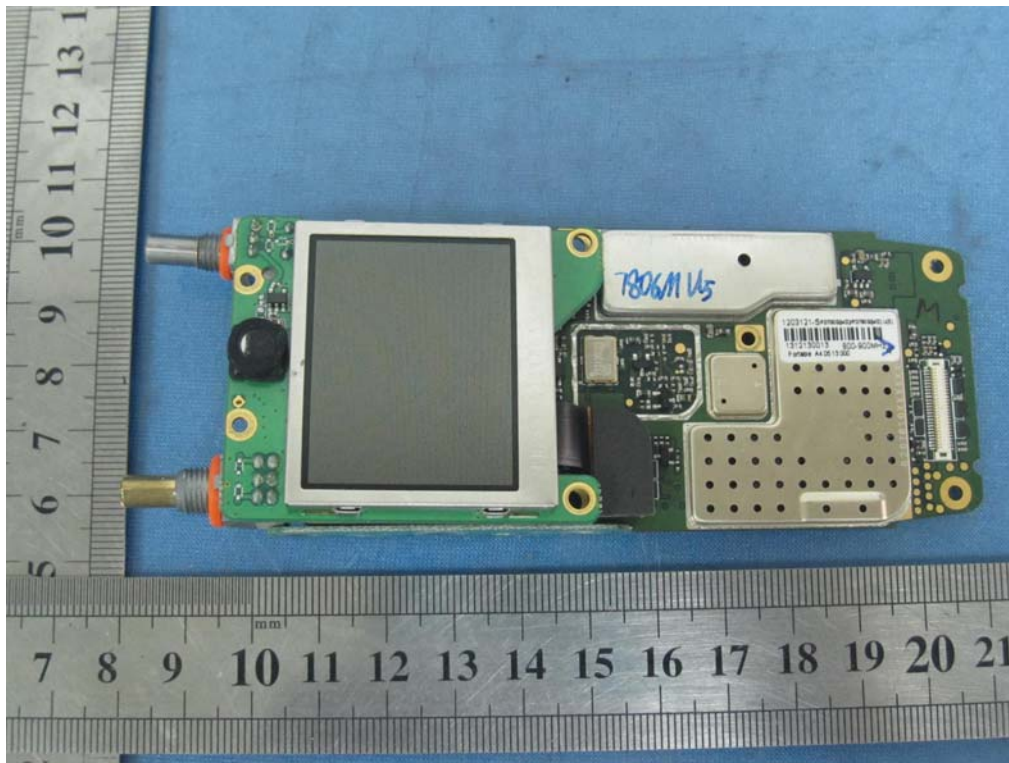

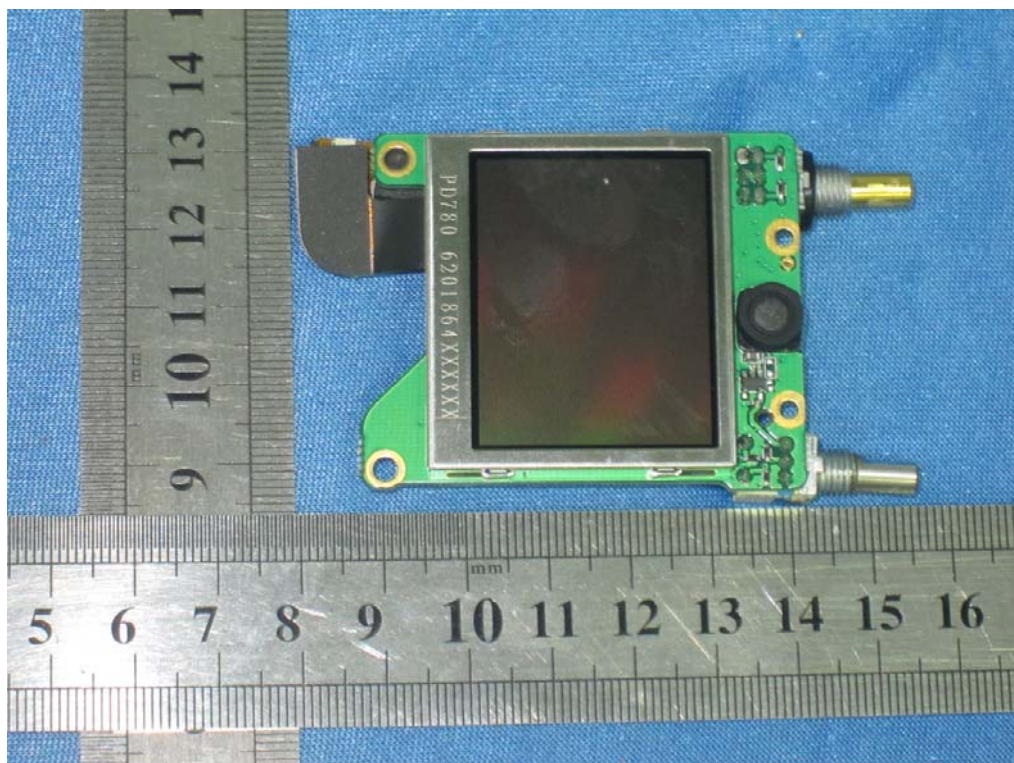
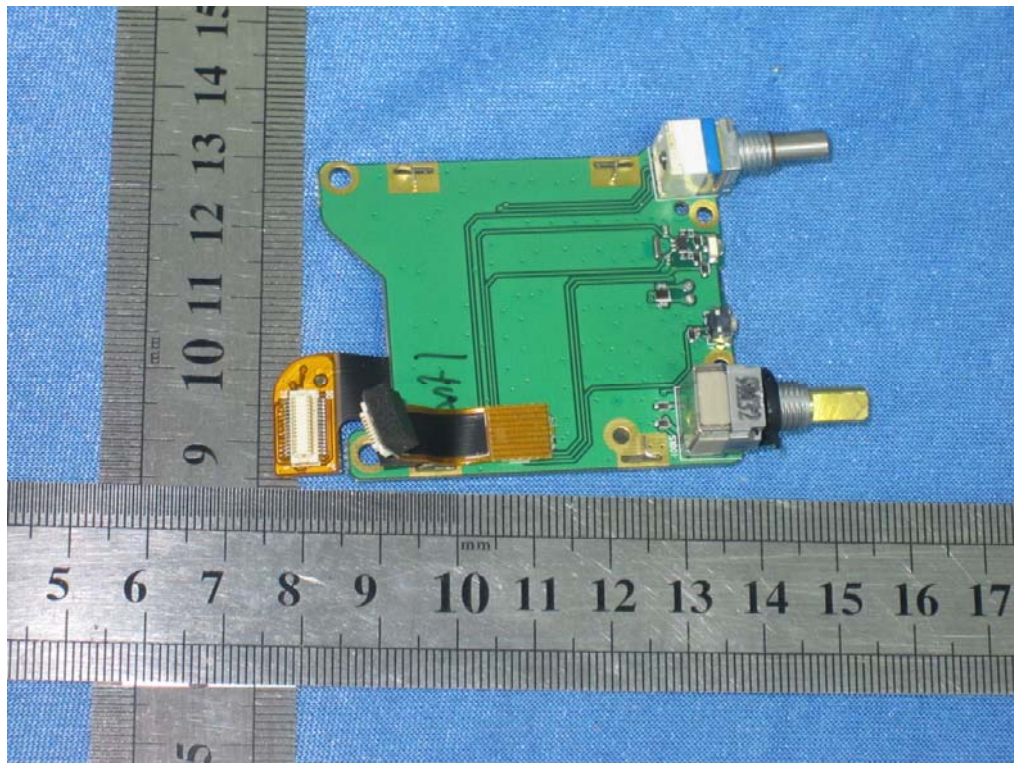

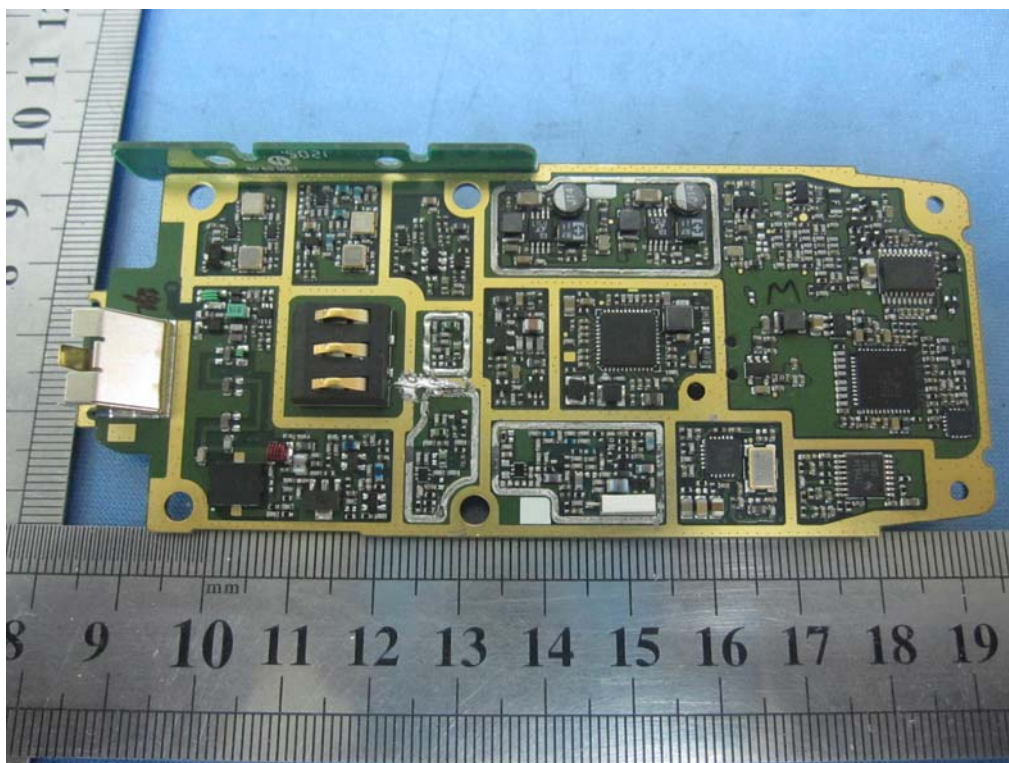
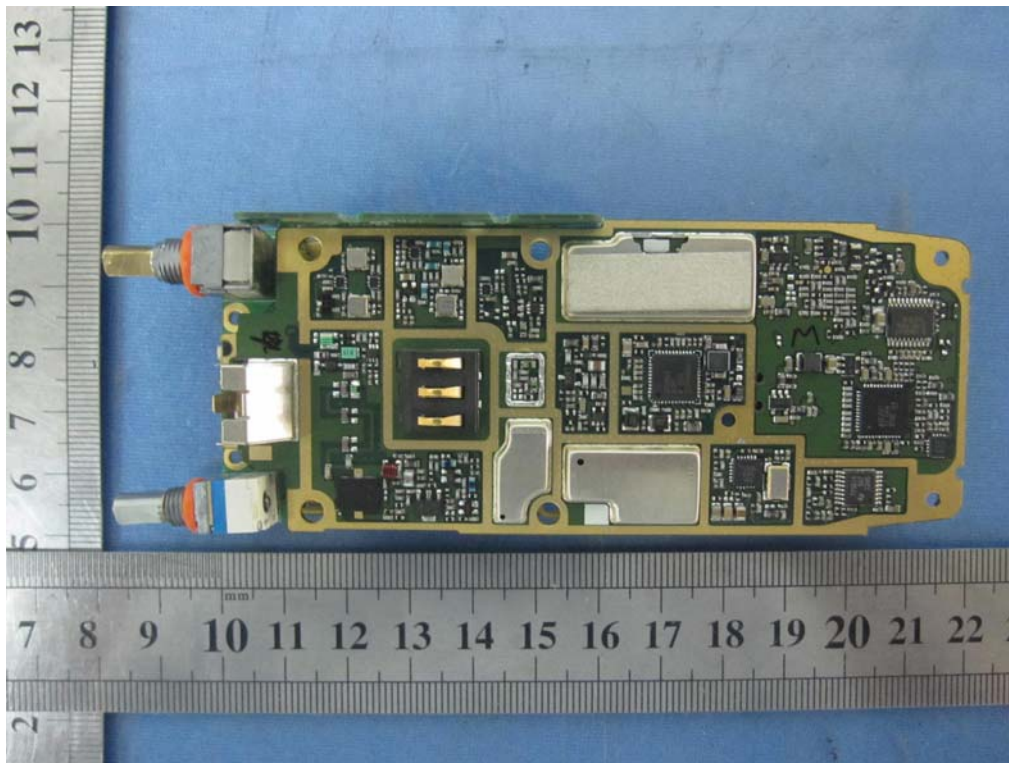

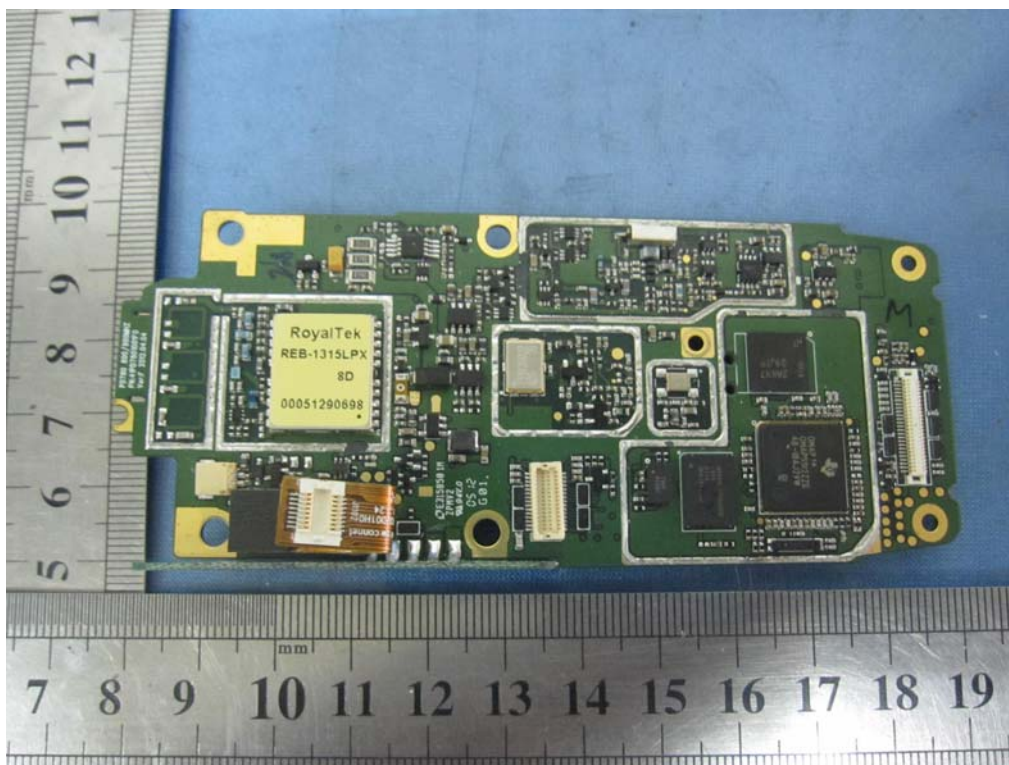
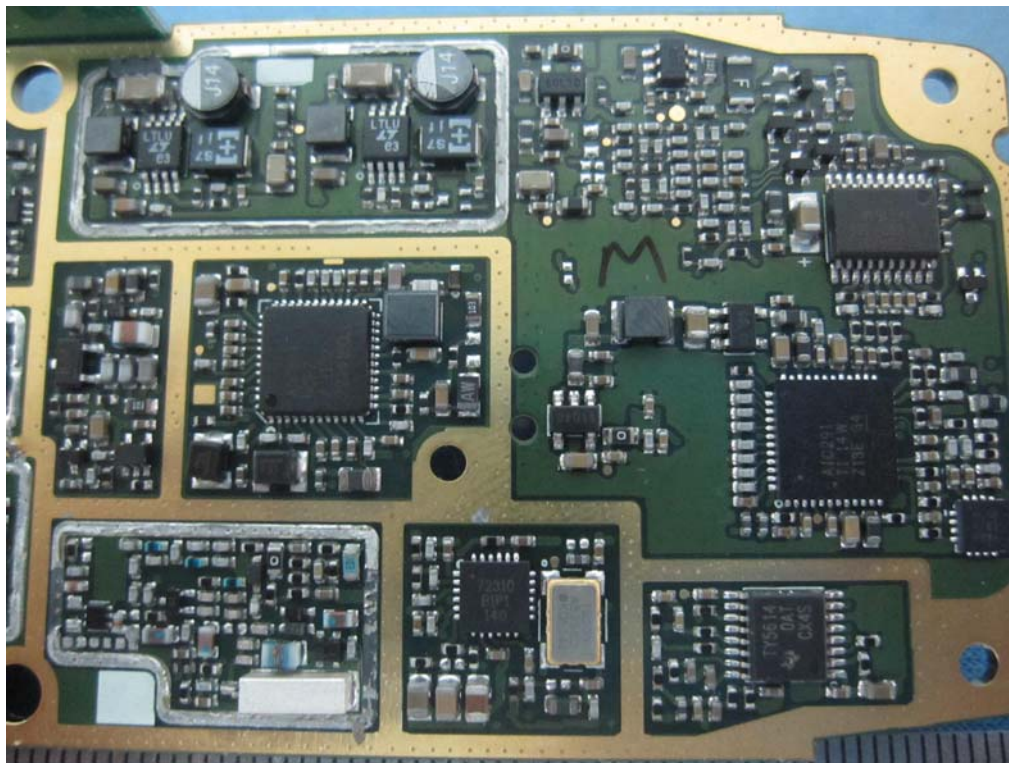

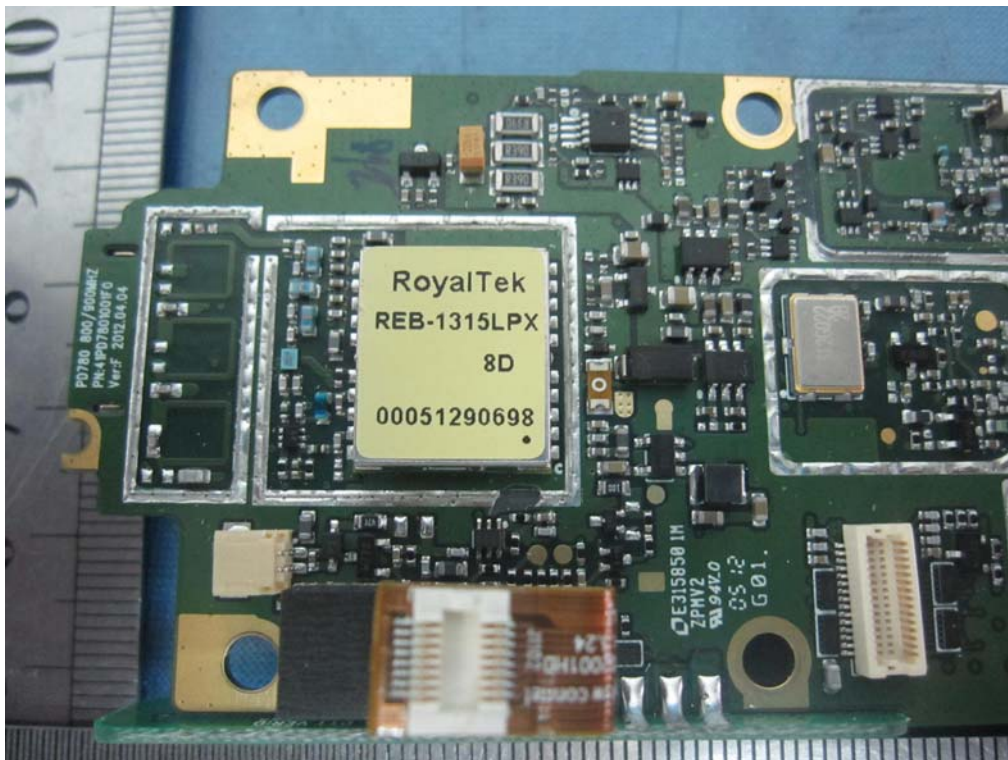
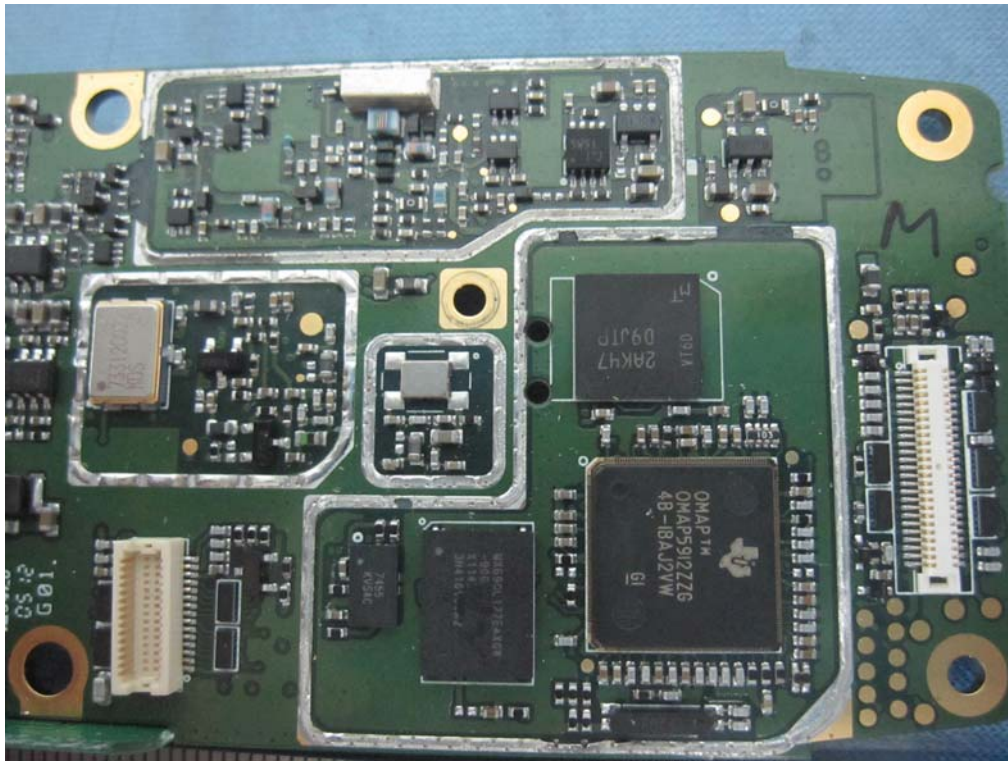

.....End of Report.....