

Preface

Thanks for your favor in our product. To derive optimum performance from the product, please read this manual and the supplied Safety Information Booklet carefully before use.

This manual is applicable to the following model:

PD602 VHF Digital Portable Radio

Copyright Information

Hytera is the trademark or registered trademark of Hytera Communications Co., Ltd. (the Company) in PRC and/or other countries or areas. The Company retains the ownership of its trademarks and product names. All other trademarks and/or product names that may be used in this manual are properties of their respective owners.

The product described in this manual may include the Company's computer programs stored in memory or other media. Laws in PRC and/or other countries or areas protect the exclusive rights of the Company with respect to its computer programs. The purchase of this product shall not be deemed to grant, either directly or by implication, any rights to the purchaser regarding the Company's computer programs. Any of the Company's computer programs may not be copied, modified, distributed, decompiled, or reverse-engineered in any manner without the prior written consent of the Company.

The AMBE+2™ voice coding technology embodied in this product is protected by intellectual property rights including patent rights, copyrights and trade secrets of Digital Voice Systems, Inc. This voice coding technology is licensed solely for use within this product. The user of this technology is explicitly prohibited from attempting to decompile, reverse engineer, or disassemble the Object Code or in any other way convert the Object Code into a human readable form.

U.S. Patent No: #6,912,495 B2, #6,199,037 B1, #5,870,405, #5,826,222, #5,754,974, #5,701,390, #5,715,365, #5,649,050, #5,630,011, #5,581,656, #5,517,511, #5,491,772, #5,247,579, #5,226,084 and #5,195,166.

Disclaimer

The Company endeavors to achieve the accuracy and completeness of this manual, but no warranty of accuracy or reliability is given. All the specifications and designs are subject to change without notice due to continuous technology development. No part of this manual may be copied, modified, translated, or distributed in any manner without the express written permission of us.

We do not guarantee, for any particular purpose, the accuracy, validity, timeliness, legitimacy or completeness of the Third Party products and contents involved in this manual.

If you have any suggestions or would like to learn more details, please visit our website at:

<http://www.hytera.com>.

RF Radiation Information

This product must be restricted to operations in an Occupational/Controlled RF exposure Environments. The product must be only used by users who are fully aware of the hazards of the exposure and who are able to exercise control over their RF exposure to qualify for the higher exposure limits.

RF Radiation Profile

Radio Frequency (RF) is a frequency of electromagnetic radiation in the range at which radio signals are transmitted. RF technology is widely used in communication, medicine, food processing and other fields. It may generate radiation during use.

RF Radiation Safety

In order to ensure user health, experts from relevant industries including science, engineering, medicine and health work with international organizations to develop standards for safe exposure to RF radiation. These standards consist of:

- United States Federal Communications Commission, Code of Federal Regulations; 47CFR part 2 sub-part J;
- American National Standards Institute (ANSI)/Institute of Electrical and Electronic Engineers (IEEE) C95. 1-1992;
- Institute of Electrical and Electronic Engineers (IEEE) C95.1-1999;
- International Commission on Non-Ionizing Radiation Protection (ICNIRP) 1998;

FCC Regulations

Federal Communication Commission (FCC) requires that all radio communication products should meet the requirements set forth in the above standards before they can be marketed in the U.S, and the manufacturer shall post a RF label on the product to inform users of operational instructions, so as to enhance their occupational health against exposure to RF energy.

Operational Instructions and Training Guidelines

To ensure optimal performance and compliance with the occupational/controlled environment RF energy exposure limits in the above standards and guidelines, users should transmit no more than 50% of the time and always adhere to the following procedures:

Your radio radiates measurable RF energy only while it is transmitting (during talking), not when it is receiving (listening) or in standby mode.

FCC Statement

This equipment has been tested and found to comply with the limits for a Class B digital device, pursuant to part 15 of FCC Rules. These limits are designed to provide reasonable protection against harmful interference in a residential installation. This equipment generates and can radiate radio frequency energy and, if not installed and used in accordance with the instructions, may cause harmful interference to radio communications. However, there is no guarantee that interference will not occur in a particular installation. If this equipment does cause harmful interference to radio or television reception, which can be determined by turning the equipment off and on, the user is encouraged to try to correct.

The interference by one or more of the following measures:

- Reorient or relocate the receiving antenna. Increase the separation between the equipment and receiver.
- Connect the equipment into an outlet on a circuit different from that to which the receiver is connected.
- Consult the dealer or an experienced radio/TV technician for help

Operation is subject to the following two conditions: 1. This device may not cause harmful interference, and 2. This device must accept any interference received, including interference that may cause undesired operation.

Note:” Changes or modifications to this unit not expressly approved by the party responsible for compliance could void the user’s authority to operate the equipment.”

Compliance with RF Exposure Standards

Hytera’s 2-way radio complies with the following RF energy exposure standards and guidelines:

- United States Federal Communications Commission, Code of Federal Regulations; 47 CFR §§ 1.1307, 1.1310 and 2.1093
- American National Standards Institute (ANSI) / Institute of Electrical and Electronic Engineers (IEEE) C95. 1-1992
- Institute of Electrical and Electronic Engineers (IEEE) C95.1-1999 Edition

RF Exposure Compliance and Control Guidelines and Operating Instructions

To control your exposure and ensure compliance with the occupational/controlled environment exposure limits always adhere to the following procedures.

Guidelines:

- Do not remove the RF Exposure Label from the device.
- User awareness instructions should accompany device when transferred to other users.

- Do not use this device if the operational requirements described herein are not met.

Operating Instructions:

- Transmit no more than the rated duty factor of 50% of the time. To transmit (talk), push the Push-To-Talk (PTT) button. To receive calls, release the PTT button. Transmitting 50 % of the time, or less, is important because this radio generates measurable RF energy exposure only when transmitting (in terms of measuring for standards compliance).
- Hold the radio in a vertical position in front of face with the microphone (and the other parts of the radio, including the antenna) at least one inch (2.5 cm) away from the nose. Keeping the radio at the proper distance is important because RF exposures decrease with distance from the antenna. Antenna should be kept away from eyes.
- When worn on the body, always place the radio in a Hytera's approved clip, holder, holster, case, or body harness for this product. Using approved body-worn accessories is important because the use of Hytera's or other manufacturer's non-approved accessories may result in exposure levels, which exceed the FCC's occupational/controlled environment RF exposure limits.
- If you are not using a body-worn accessory and are not using the radio in the intended use position in front of the face, then ensure the antenna and the radio are kept at least 2.5 cm (one inch) from the body when transmitting. Keeping the radio at the proper distance is important because RF exposures decrease with increasing distance from the antenna.
- Use only manufacturer's name approved supplied or replacement antennas, batteries, and accessories. Use of non-manufacturer-name approved antennas, batteries, and accessories may exceed the FCC RF exposure guidelines.
- For a list of Hytera's approved accessories (see the user manual), or (visit the following website which lists approved accessories: [http: add website address](http://add website address)), or (The manufacturer should include the appropriate bracketed item{s} in the manual.)
- For a list of Hytera's approved accessories (see the user manual), or (visit the following website which lists approved accessories: www.hytera.cn)

IC statement

This device complies with Industry Canada licence-exempt RSS standard(s). Operation is subject to the following two conditions:

- (1) This device may not cause interference, and
- (2) This device must accept any interference, including interference that may cause undesired operation of the Device.

The device has been tested and compliance with SAR limits, users can obtain Canadian information on RF exposure and compliance

Le présent appareil est conforme aux CNR d'Industrie Canada applicables aux appareils radio exempts de licence. L'exploitation est autorisée aux deux conditions suivantes :

- (1) l'appareil n' doit pas produire de brouillage, et
- (2) l'utilisateur de l'appareil doit accepter tout brouillage radioélectrique subi, même si le brouillage est susceptible d'en compromettre le fonctionnement.





Après examen de ce matériel aux conformités aux limites DAS et/ou aux limites d'intensité de champ RF, les utilisateurs peuvent sur l'exposition aux radiofréquences et la conformité and compliance d'acquérir les informations correspondantes













EU Regulatory Conformance

As certified by the qualified laboratory, the product is in compliance with the essential requirements and other relevant provisions of the Directive 1999/5/EC. Please note that the above information is applicable to EU countries only.



Contents





1. Documentation Conventions	8
1.1 Instructional Icons.....	8
1.2 Notational Conventions.....	8
1.3 Key Operation.....	8
2. Items in the Package	10
3. Product Overview	11
3.1 Product Controls.....	11
3.2 Programmable Keys.....	12
4. Status Indication	14
4.1 LED Indicator.....	14
5. Before Use	15
5.1 Charge the Battery.....	15
5.2 Assembling Accessories.....	16
5.2.1 Assembling the Antenna.....	16
5.2.2 Assembling the Battery.....	16
5.2.3 Assembling the Belt Clip.....	17
5.2.4 Attaching Audio/Programming Cable.....	17
6. Basic Operations	18
6.1 Powering On/Off.....	18
6.2 Adjusting the Volume.....	18
6.3 Adjust Power Level.....	18
6.4 Selecting a Zone.....	18
6.5 Selecting a Channel.....	18
6.6 Switching the Channel Mode.....	18
7. Call	20
7.1 Private Call 	20
7.2 Group Call 	20
7.3 All Call 	20
7.4 Calls on Analog Channels 	20
7.5 One Touch Call.....	21
7.6 Time-out Timer (TOT).....	21
7.7 Busy Channel Lockout.....	21
7.8 Pseudo Trunking 	21
8. Functions and Operations	22
8.1 Rent.....	22

8.2 Scan.....	22
8.3 Roam  ▼	22
8.4 Talk Around	23
8.5 Monitor 	23
8.6 Squelch Off 	23
8.7 Adjust Squelch Level 	23
8.8 VOX	24
8.9 LQO	24
8.10 Covert Mode	24
8.11 GPS Report  ▼	24
8.12 Battery Power Indicator.....	24
8.13 Audio Feedback Suppression	25
8.14 MIC AGC	25
8.15 Radio Registration Service 	25
8.16 Telemetry  ▼	25
8.17 Man Down ▼	26
8.18 Lone Worker	26
8.19 Priority Interrupt	26
8.19.1 Manual Priority Interrupt	26
8.19.2 Auto Priority Interrupt.....	27
8.20 Scrambler  /Encrypt 	27
8.21 Emergency Alarm	28
8.21.1 Emergency Type.....	28
8.21.2 Emergency ID Type 	28
8.21.3 Emergency Mode.....	29
8.21.4 Operation Methods for Analog Emergency 	29
8.21.5 Operation Method for Digital Emergency 	31
9. Troubleshooting	33
10. Care and Cleaning.....	35
11. Optional Accessories.....	36
12. Appendix	38
12.1 Signaling Introduction	38
12.1.1 HDC1200.....	38
12.1.2 5-Tone.....	38

1. Documentation Conventions

For your better understanding of this manual, please read the following conventions first.

1.1 Instructional Icons

Icon	Description
 Note	Indicates references that can further describe the related topics.
 Caution	Indicates situations that could cause data loss or equipment damage.
	Indicates that the function is unavailable on PD600X FL <u>LI</u> digital portable radio.
	Indicates functions that are available on digital channel only.
	Indicates functions that are available on analog channel only.
	Functions marked with no function icons are available on both analog and digital channels.

1.2 Notational Conventions

Convention	Description
“ ”	The quotation marks enclose the name of a software interface element. For example, click “OK”.
Bold	The text in boldface denotes the name of a hardware button. For example, press the PTT key.
->	The symbol directs you to access a multi-level menu. For example, to select “New” from the “File” menu, we will describe it as follows: File -> New.







1.3 Key Operation

Operation	Definition
Short press	To press a key and release it quickly.

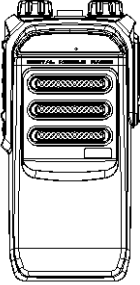
Operation	Definition
Long press	To press a key for the preset time (2s by default) and release it.
Hold	To press a key and do not release it.

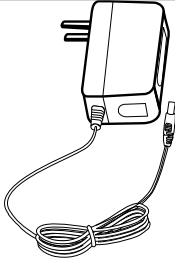
2. Items in the Package

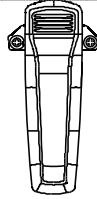
Please unpack carefully and check that all items listed below are received. If any item is missing or damaged, please contact your dealer.

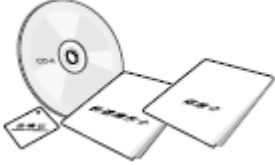
		
Radio	Battery	Charger
		
Power Adapter	Antenna	Belt clip
		
Strap	Documentation Kit	

 **Note:** The frequency band of the antenna is marked on the label of the antenna; if not, refer to the label on the radio for frequency band information.

3. Product Overview

This section introduces the mechanical structure and the programmable key features of this radio.



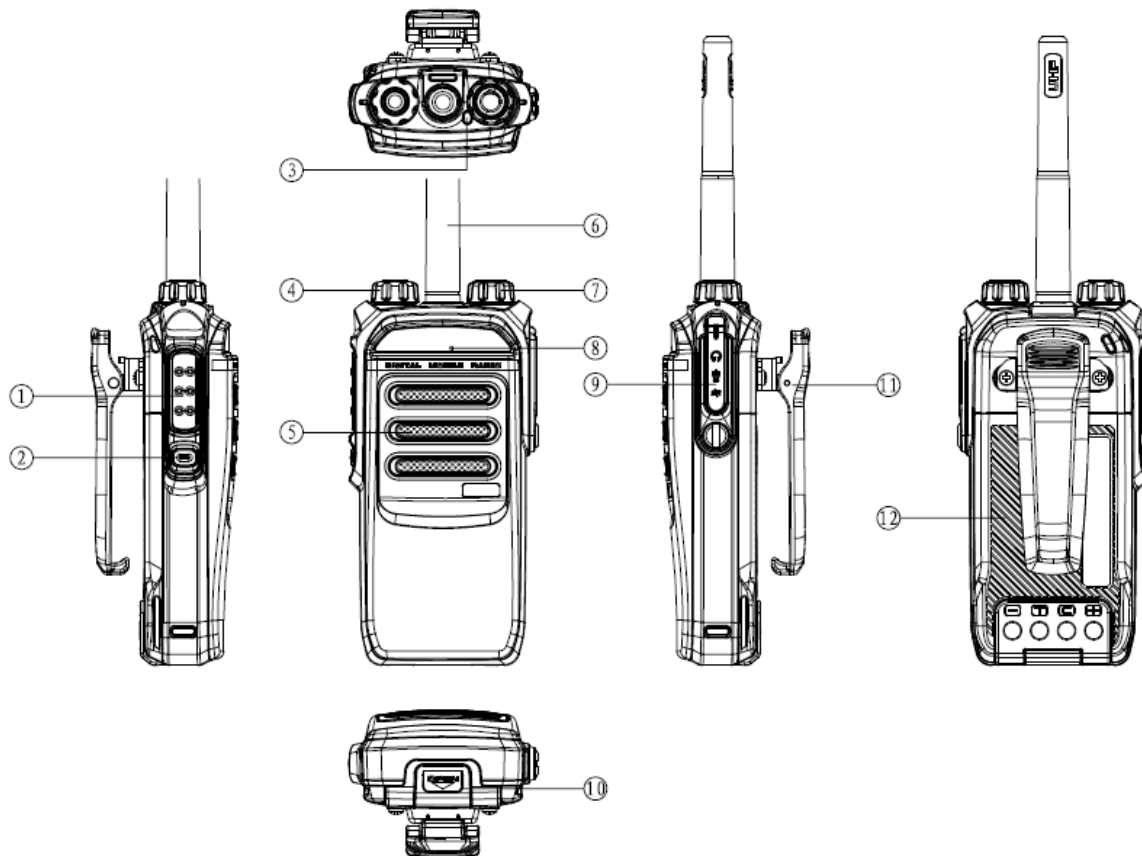



3.1 Product Controls





No.	Part Name	No.	Part Name
①	SK1 (Side Key 1)	⑧	Power On-Off/Volume Control Knob
②	PTT (Push-to-Talk) Key	⑨	Microphone
③	SK2 (Side Key 2)	⑩	Accessory Jack
④	TK (Top Key)	⑪	Battery latch
⑤	Channel Selector Knob	⑫	Antenna
⑥	Speaker	⑬	Belt clip
⑦	LED Indicator	⑭	Battery

3.2 Programmable Keys

For enhanced convenience, you may request your dealer to program the keys **SK1**, **SK2** and **TK** as shortcuts to the functions listed below.

No.	Shortcut Key	Description
1	Zone Up	To select a zone quickly
2	Zone Down	
3	Adjust Power Level	To adjust the power level quickly. The power level: High and Low.
4	Talk Around	To switch the operation mode between the Direct mode and the Repeat mode quickly.
5	Monitor 	Press this key to switch to the Monitor Squelch Mode, and press it again to switch to the Rx Squelch Mode.
6	Monitor Momentary 	Press this key to start monitoring, and release it to exit monitoring. This feature is linked with both the long press and short press of the key.
7	Squelch Off 	To activate the Squelch Off feature quickly, so the speaker will be unmuted. The feature will remain active upon radio restart.
8	Squelch Off Momentary 	Press this key to activate the Squelch Off feature momentarily. Release it to return to the previous mode. The Squelch Off Momentary feature must be assigned to short press and long press of a key together.
9	Scan	To enable or disable the Scan feature quickly.
10	Nuisance Temporary Delete	To temporarily ignore rarely used channel activity.
11	Adjust Squelch Level 	To change the squelch level among Open, Normal and Tight.
12	Battery Power Indicator	Press this key and check the current battery power status via the LED indicator.
13	Man Down ▼	To enable or disable the Man Down function quickly.
14	Scramble 	To enable or disable the Scrambler feature quickly. Scrambler is used to encrypt your voice so as to guarantee privacy of your

No.	Shortcut Key	Description
		communication.
15	Encrypt  ▼	To enable or disable the Encrypt feature quickly. Encrypt is used to encrypt your voice and message so as to guarantee privacy of your communication.
16	Lone Worker	To enable or disable the Lone Worker feature quickly.
17	One Touch Call	To call the preset contact quickly. At most five keys can be assigned with this feature.
18	Telemetry  ▼	To monitor remote equipment.
19	Roam  ▼	To enable or disable the Roam feature quickly.
20	Priority Interrupt	To terminate the ongoing activity on the current channel, so as to initiate a new call or data service.
21	VOX	To enable or disable the VOX feature quickly.
22	GPS Report ▼	To upload the GPS data to the system immediately.
23	Option Board ▼	To enable or disable the option board on the current channel.
24	Emergency On	To make an emergency call for help in emergent situations.
25	Emergency Off	To exit the emergency call.
26	Preset Channel	To switch the channel quickly. The target channel, preset by the dealer, is a channel from any zone. At most 4 programmable keys can be assigned with this feature at one time.
27	LQO	To enable or disable LQO feature.
28	Covert Mode	To enter or exit the Covert mode.



Note:

- Long and short press of a key can be assigned with different functions by your dealer.
- Short press of the **TK** key is assigned with the Emergency On feature, long press assigned with the Emergency Off feature. You can also assign it with other features via your dealer.

4. Status Indication

4.1 LED Indicator

The LED on the top of the radio will help you easily identify the current radio status.

LED Indication	Radio Status
The LED flashes green.	Powering on
The LED glows red.	Transmitting
The LED glows green.	Receiving
The LED flashes orange slowly.	Scanning
The LED flashes orange rapidly.	Emergency
The LED glows orange.	No voice is being transmitted or received on the channel after a call is established. Within such period, you can hold the PTT key to talk.

5. Before Use

5.1 Charge the Battery

⚠ Caution: Make sure the radio is powered off during charging.

Use only the charger and battery specified by Hytera. Charger LED can indicate the charging process. See the table below. The following figure shows the steps for charging.

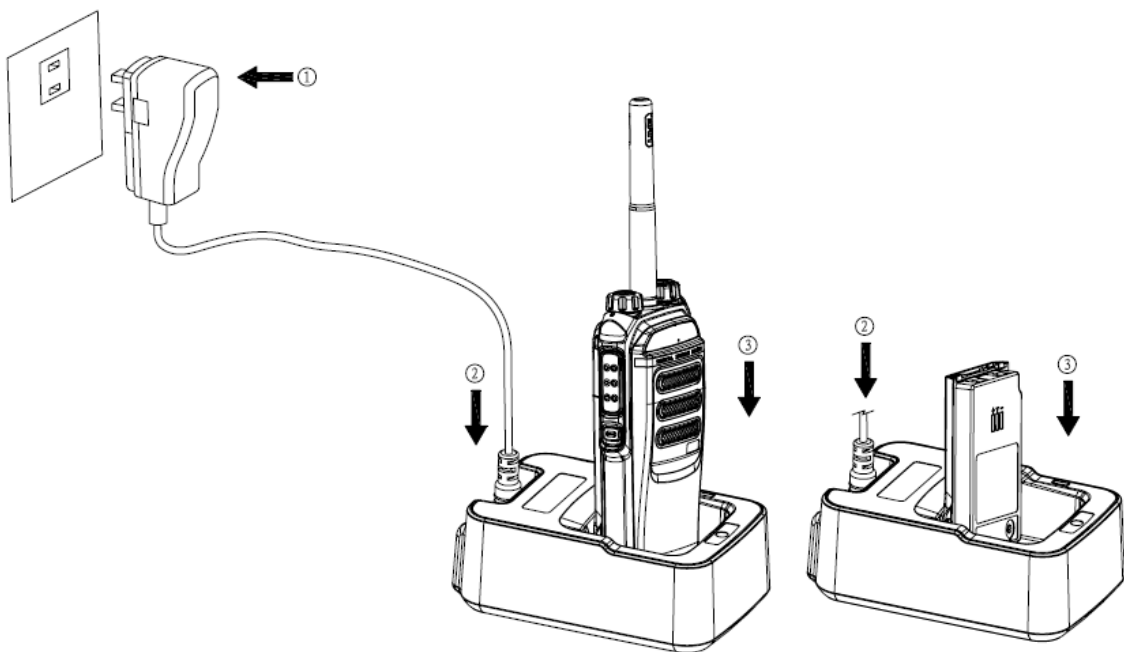

Step 1 Connect the power adapter to AC socket. See arrow ①.

Step 2 Plug the other end of the power adapter into the rear jack of the charger. See arrow ②.

Step 3 Place the radio with the battery attached, or the battery alone, into the charger. See arrow ③.

During charging, the LED on the charger will indicate the charging status. The charging status begins when the charger LED glows red. When charging is complete, the charger LED glows green.

See the following table for details.

Note

- To achieve optimal battery performance, please charge the battery for 5 hours before initial use.
- Be sure to read the Safety Information Booklet to get necessary battery safety information.

LED Indication	Charging Status
----------------	-----------------

LED Indication	Charging Status
The LED flashes red slowly.	Standby (no load)
The LED glows red.	Charging
The LED glows orange.	90% charged
The LED glows green.	Fully charged
The LED flashes red rapidly.	Charging failure

5.2 Assembling Accessories

5.2.1 Assembling the Antenna

Turn the antenna clockwise to fasten it. To remove the antenna, rotate it counter-clockwise.

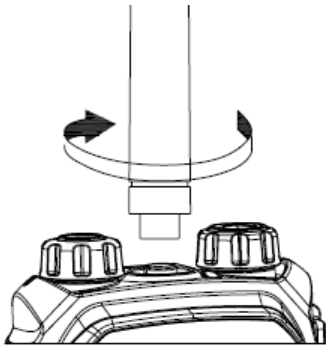

5.2.2 Assembling the Battery

Step 1 Attach the battery as ① shows in the following figure.

Step 2 Slightly press the bottom of the battery until a click is heard. See ② in the following figure.

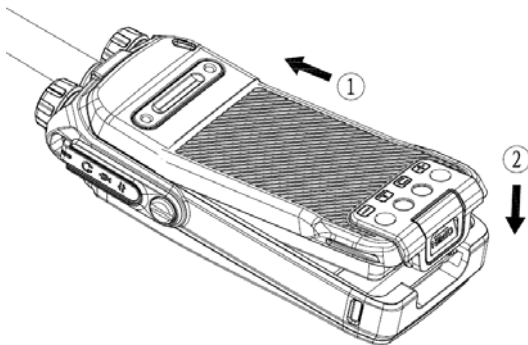

To remove the battery, turn off the radio first. Then slide the battery latch upwards (as ② shows) to

unlock the battery.

5.2.3 Assembling the Belt Clip

Step 1 Remove the screws on the back of the radio, as shown in the following figure.

Step 2 Align the screw holes in the belt clip and on the radio's back, and then tighten the screws.

To remove the belt clip, loosen the screws.

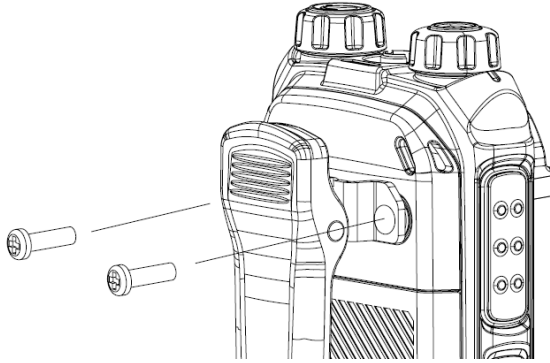

5.2.4 Attaching Audio/Programming Cable

Step 1 Open the accessory jack cover as the arrow below shows.

Step 2 Align the accessory connector with the accessory jack.

Caution

- When aligning, make sure not to scrape the silica gel surrounding the accessory jack screw hole, in order to ensure the waterproof performance of the radio.
- Be sure to align the screw on the accessory connector to the screw hole in the jack before fastening the screw.

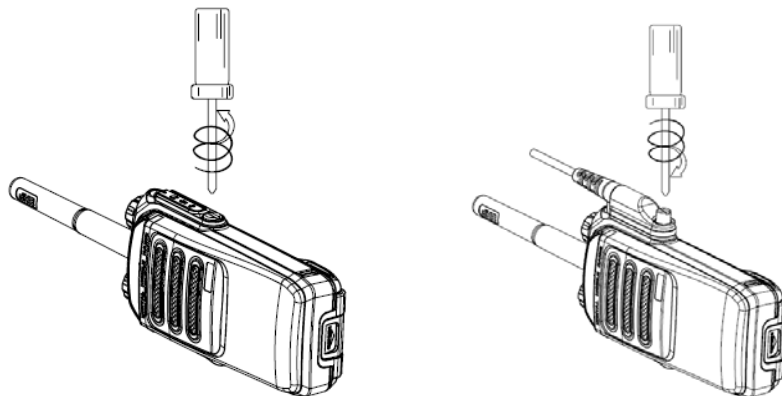

Step 3 Tighten the screw on the connector.

To remove the accessory connector, loosen the screw.

6. Basic Operations

6.1 Powering On/Off

Rotate the **Power On-Off/Volume Control** knob clockwise/counter-clockwise until a click is heard to turn the radio on/off.

6.2 Adjusting the Volume

After turning the radio on, rotate the **Power On-Off/Volume Control** knob clockwise to increase the output sound volume, or counter-clockwise to decrease it.

6.3 Adjust Power Level

With this feature, you may switch power levels quickly. Generally, we recommend you to adopt low power for battery saving. However, if you cannot communicate with radios located at a distant place with low power, please select high power.

Operation: Press the programmed **Adjust Power Level** key to switch the Tx power of the current channel between High and Low.

6.4 Selecting a Zone

A zone is a group of channels exhibiting the same property. You can list such channels into a zone for convenient management to them. This radio supports 3 zones: Zone 1, Zone 2 and Zone 3, each of which can contain 16 channels at most.

You may quickly toggle to your wanted zone by pressing the programmed **Zone Up** or **Zone Down** key. When toggling to a zone, you will hear the alert tone for the zone (one alert tone for Zone 1, two alert tones for Zone 2 and three alert tones for Zone 3).

6.5 Selecting a Channel

After turning the radio on, rotate the **Channel Selector** knob to select a needed channel. You can also switch to the designated channel by pressing the programmed **Preset Channel** key.

If the Channel Notify function is active, you will hear the corresponding channel number when switching to any channel.

6.6 Switching the Channel Mode

Each channel can be programmed as either analog channel or digital channel via your dealer. If the

current zone includes both analog and digital channels, you may quickly switch between digital and analog channels through the **Channel Selector** knob.

7. Call

To ensure optimal volume of the transmitted voice, keep the microphone approximately 2.5 to 5 centimeters away from your mouth.

7.1 Private Call

Initiating a Call

In the home screen, hold the **PTT** key to transmit a private call to the private call contact preset for the current channel.

 **Note:** Your dealer may preset a contact for each digital channel. The preset contact could be a private call contact, a group call contact or an all call contact.

Receiving a Call or Calling Back

When a private call is received, you can listen to it without any operation. You may hold the **PTT** key within the preset time period to call back.

7.2 Group Call

Initiating a Call

In the home screen, hold the **PTT** key to transmit a group call to the group call contact preset for the current channel.

Receiving a Call or Calling Back

When a group call is received, you can listen to it without any operation, and you may hold the **PTT** key within the preset time period to call back.

7.3 All Call

In the home screen, hold the **PTT** key to transmit an all call to the all call contact preset for the current channel. When an all call is received, you can listen to it without any operation.

 **Note:** You can transmit an all call only when the feature is enabled by your dealer. However, you cannot call back an all call.

7.4 Calls on Analog Channels

To transmit a call on the analog channel, hold the **PTT** key and speak into the microphone. To receive, release the **PTT** key.

7.5 One Touch Call

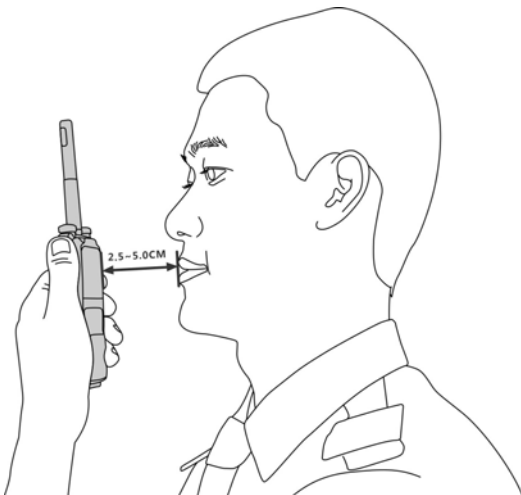

You may request your dealer to set the **One Touch Call** key for you. The One Touch Call feature is used to make a call quickly. The call contact and call type are preset by the dealer.

Operation: Press the programmed **One Touch Call** key to initiate a call.

7.6 Time-out Timer (TOT)

TOT aims to prevent any user from occupying a channel for an extended period. If the preset time expires, the radio will automatically terminate the transmission and keep beeping. To stop beeping, please release the **PTT** key. You must wait for a certain time period (preset by your dealer) to initiate another transmission.

 **Note:** This feature is null in Emergency mode.

7.7 Busy Channel Lockout

If enabled (via the programming software), this feature can prevent your radio interfering with other transmitting radios on the same channel. If you hold the **PTT** key while the channel is in use, your radio will keep beeping, alerting you to transmission prohibition. When the channel is free, you can hold the **PTT** key to transmit.

7.8 Pseudo Trunking

This feature can be enabled via the programming software. If the radio operates on a channel with this feature enabled and a time slot is already occupied, the radio can transmit and receive in another free slot.

8. Functions and Operations

8.1 Rent

You can rent the radio from your dealer. When the rental period expires, you are not allowed to use this radio.

If you rent this radio, please obtain the rental time information from your dealer. If the Rent Pre-Alert feature is enabled, the radio will give a tone periodically to remind you the remaining time of your rental.

8.2 Scan

With the Scan feature, you can listen to communication activities on other channels so that you can keep a close track of your team members.

Operation:

Step 1 To enable the feature, press the programmed **Scan** key in standby mode (a high-pitched tone sounds); or switch to a channel for which the Auto Scan feature is enabled. When you switch to the channel, the radio will start scan automatically.

Step 2 After the feature is enabled, the radio will scan according to the scan list set for the channel.

The scanning process is as follows:

- During scanning, the LED flashes orange.
- When activities are detected on a channel, the radio will stay on the channel to receive current activities, and the LED will glow green.
 - If you don't want to hear the activities on the channel, press the programmed **Nuisance Temporary Delete** key to remove the channel from the scan list temporarily.
 - If you want to continue listening to the activities on the channel, press the programmed **Monitor** key or **Squelch Off** key during scan stay. 
 - To exit the scanning process, press the programmed **Scan** key again (a low-pitched tone sounds).

8.3 Roam ▼

This feature allows the radio to communicate between sites in the same IP Multi-site Connect system. After the feature enabled, the radio can communicate via any site in the IP Multi-site Connect system, thus ensuring seamless communication in the system.

Operation: You can enable or disable the Roam feature by pressing the programmed **Roam** key.

8.4 Talk Around

You can continue to communicate in DM mode by pressing the programmed **Talk Around** key when your repeater malfunctions, or when your radio and the communicating radio are out of the repeater's range but within talking range of each other.

Operation: Press the programmed **Talk Around** key to enable the feature (a high-pitched tone sounds). To disable the feature, press this key again (a low-pitched tone sounds).

8.5 Monitor

To adjust match conditions for signal receiving, you can enable the Monitor feature.

Operation:

- Press the programmed **Monitor** key to enable the feature (a high-pitched tone sounds). To disable the feature, press this key again (a low-pitched tone sounds).
- Hold down the programmed **Monitor Momentary** key to enable the feature (a high-pitched tone sounds). To disable the feature, release this key (a low-pitched tone sounds).

8.6 Squelch Off

If the Squelch Off feature is activated, the speaker will keep unmuted no matter whether the signals are present.

Operation:

- Press the programmed **Squelch Off** key to enable the feature (a high-pitched tone sounds). Then the radio sounds background noise. Press the key again to disable the feature (a low-pitched tone sounds).
- Press the programmed **Squelch Off Momentary** key to enable the feature (a high-pitched tone sounds). Then the radio sounds background noise. Press the key again to disable the feature (a low-pitched tone sounds).

8.7 Adjust Squelch Level

This feature allows you to adjust the squelch threshold required for the radio to be unmuted.

Generally, the higher squelch level requires stronger signal for the radio to be unmuted. If the squelch level is set to "Open", the speaker will keep unmuted irrespective of the satisfaction of decoding conditions.

Operation: Press the programmed **Adjust Squelch Level** key to switch among Tight, Open and Normal (when you switch from Tight to Open, a low-pitched tone and the background noise will sound).

- When you switch from Open to Normal, a high-pitched tone will sound and the background noise will disappear.
- When you switch from Normal to Tight, a high-pitched tone will sound.

8.8 VOX

VOX indicates that you can trigger the voice transmission by speaking directly without holding the **PTT** key. When the voice detected by the microphone reaches the volume to trigger the transmission, it will be transmitted automatically.

Operation: You can enable or disable this feature by pressing the programmed **VOX** key.

8.9 LQO

This feature enables the radio to adjust the received voice volume automatically to fit different using environments, as well as making the heard voice clear.

Operation: You can enable or disable the LQO feature by pressing the programmed **LQO** key.

8.10 Covert Mode

When this feature is enabled, the radio will disable any visible indications on it, such as the LED, vibration, etc, set by your dealer. This feature is mainly used in special missions.

Operation: Press the programmed **Covert Mode** key to enable or disable the Covert mode.

8.11 GPS Report ▼

With the GPS feature enabled, the radio will upload its positioning information to the system when the system requires GPS information. The uploading method is set by the dealer.

Operation: Press the programmed **GPS Report** key to upload the GPS information quickly.

8.12 Battery Power Indicator

This feature allows you to know the current battery power.

Operation: Hold the programmed **Battery Power Indicator** key, and the radio will give an appropriate LED indication to represent the current battery power. Release this key to stop the indication.

LED Indicator	Battery Power
The LED glows green.	High

LED Indicator	Battery Power
The LED glows orange.	Medium
The LED glows red.	Low
The LED glows red and the low battery tone sounds.	The power is under the low battery threshold. Now you need to charge it or replace it to ensure the proper operation of the radio.

8.13 Audio Feedback Suppression

This feature is enabled by your dealer via the programming software. The enabled feature will weaken the noise made by short-distance communication, so as to improve the voice quality.

8.14 MIC AGC

This feature is enabled by your dealer via the programming software. When it is enabled, the radio will control the audio gain to a proper range during transmission, providing improved voice with proper volume for the receiving radio.

8.15 Radio Registration Service

This feature is enabled by your dealer via the programming software. The radio will automatically register in the system within a certain period after power-on. Then it can acquire online information of other radios via accessing specific servers within the valid registration period.

8.16 Telemetry ▼

This feature allows you to remotely supervise the device connected with the radio. With this feature, you can control the device and view its status at any time in case that you are away from the device.

The method for supervising the device is programmable by your dealer. The available methods are:

- To supervise the device via the radio

If a device is connected with the radio, you can use another radio to supervise the device. All the radios involved should be configured with the Telemetry feature. For example, the dealer enables the Telemetry feature for both Radio A and Radio B, and assigns the Telemetry feature to the **SK** key on Radio A. To supervise the Device C, connect it with Radio B, and press the **SK** key on Radio A.

- To supervise the device via the third-party software

If the Telemetry feature is enabled for the radio by your dealer, you can supervise the device connected with the radio via the third-party software.

8.17 Man Down ▼

This feature is enabled by your dealer via the programming software. With the feature enabled, the radio will give an alert tone if it tilts to a certain gradient (defined by the dealer) or stay motionless until the preset period (10s by default) expires. If you fail to place the radio upright or move it during the tone lasting time, it will enter the Emergency mode automatically. To exit the Emergency mode, move the radio or place it upright.

Operation: You can enable/disable this feature by pressing the programmed **Man Down** key. The radio gives a high-pitched tone when the Man Down feature is enabled and a low-pitched tone when the feature is disabled.

8.18 Lone Worker

This feature is ideal for persons who work alone. If you encounter an incident and cannot operate your radio within the preset time period, your radio will alarm automatically to summon help from your companion.

Operation: Press the programmed **Lone Worker** key (a high-pitched tone sounds) to enable the feature quickly or just turn on the radio if the feature is enabled via the programming software. Press the programmed **Lone Worker** key again to disable the feature (a low-pitched tone sounds).

If you do not operate the radio within a preset response period, it will give alerts before this period expires (dependent on the settings by your dealer). Now you can terminate the alerts by rotating a knob or pressing a key. When the response period expires, the radio will trigger the emergency on the current channel automatically.

 **Note:** If the Lone Worker feature is not disabled before your radio is powered off, it will remain enabled when the radio is powered on again.

8.19 Priority Interrupt

8.19.1 Manual Priority Interrupt

You can have the priority interruption by pressing the programmed **Priority Interrupt** key. By pressing this key, you can terminate the ongoing activity (a call, Call Hold Time or remote monitoring) on the current channel, so as to initiate a new call or data service.

Call Hold Time: the duration the radio stays at in-call status after the end of the call. The Call Hold Time includes two types: Group Call Hold Time and Private Call Hold Time. Within the time, you can hold the **PTT** key to directly call back.

8.19.2 Auto Priority Interrupt

The Auto Priority Interrupt is enabled by the dealer and it includes four categories as introduced below. This feature is designed to ensure the priority given to the specified services. Such services will trigger the interruption automatically.

Emergency Priority Interrupt

This function is designed for users to initiate an emergency alarm in time. Carrying this function would interrupt the active call on the current channel through an emergency alarm. To carry out the function, any of the following ways is available:

- Press the programmed **Emergency On** key.
- Hold the **PTT** key in Emergency mode.
- Auto Emergency Call

Call Back Priority Interrupt

With the feature enabled, you can hold the **PTT** key to interrupt a receiving call and call back. For example, User A is receiving a call from User B. This function allows User A to interrupt the call and talk back to User B by holding the **PTT** key.

Radio Disable Priority Interrupt

During a call on the channel, this function allows you to interrupt the ongoing call and have the priority to sending a Radio Disable command. The disabled radio can be monitored remotely, but its other features will be invalid. It can only be revived by reprogramming through the programming software or through the Revive command.

All Call Priority Interrupt

During a call on the channel, this function allows you to interrupt the ongoing call and transmit an all call.

8.20 Scrambler /Encrypt

This Encrypt feature can encrypt your audio signals to prevent eavesdropping. Thus privacy of your communication is guaranteed.

Operation:

- Press the programmed **Scramble/Encrypt** key to enable the Scrambler or Encrypt feature on the current channel (a high-pitched tone sounds); press the key again to disable the feature (a low-pitched tone sounds).
- If the Scrambler or Encrypt feature is enabled for a channel via the programming software, switch to the channel and the feature will be enabled automatically. When you exit the channel, the feature will be disabled.

8.21 Emergency Alarm

This feature is enabled by your dealer via the programming software. In case of an emergency, you can use the feature to ask for help from your companion or control center. The emergency alarm has the highest priority. You can make emergency operation even when the radio is transmitting or receiving.

 **Caution:** Any of the two situations below will occur when the emergency alarm initiator exits the Emergency mode:

- The initiator will exit the Emergency mode by pressing the programmed **Emergency Off** key or **Power Off** key.
- When exiting this mode in other ways (as introduced below), the radio can only exit the emergency alarm on the current channel temporarily, and will continue to give the alarm when it returns to this channel; moreover, when the radio switches to another channel which is also designed with the Emergency feature, it will give an alarm on that channel, too.

Before use, you may need to know the following concepts.

8.21.1 Emergency Type

Different Emergency types will have different indications, as shown below:

Emergency Type	Description
Siren Only	In Emergency mode, the radio will sound shrill alarm tone.
Regular	In Emergency mode, the radio will give audible and visible indication.
Silent	In Emergency mode, the radio won't give any audible or visible indication.
Silent with Voice	In Emergency mode, the radio will give only audible indication upon receipt of voice ACK from the companion or control center.



8.21.2 Emergency ID Type

This radio supports three Emergency ID types. You can select one of them via your dealer:

Emergency ID Type	Description
None	No signaling is used when the radio sends alarm information.
HDC1200	HDC1200 signaling is used when the radio sends alarm information.
5-Tone	5-Tone signaling is used when the radio sends alarm information.

8.21.3 Emergency Mode

Except “Siren Only”, other emergency types support the following three Emergency modes. You can select one of them via your dealer (For the following operation methods, we take the “Regular” type as an example).

Emergency Mode	Description
Alarm	In this mode, you can send alarm information to your companion or control center by pressing the programmed Emergency On key, but you cannot talk with them.
Alarm with Call	In this mode, you can send alarm information by pressing the programmed Emergency On key. You can hold the PTT key to speak into the microphone. Your voice and background noise to be transmitted.  Note: If the Alarm with Call To Follow feature is enabled by your dealer, you can speak into the microphone without holding the PTT key.
Emergency Call	In this mode, press the programmed Emergency On key to go to the Revert Channel, and you can hold the PTT key to speak into the microphone. Your voice and background noise will be transmitted.  Note: If the Alarm with Call To Follow feature is enabled by your dealer, you can speak into the microphone without holding the PTT key. This mode will be unavailable when the None or 5-Tone Emergency ID is sent.

8.21.4 Operation Methods for Analog Emergency

Alarm (None, 5-Tone & HDC1200)

Initiating an emergency alarm:

Press the programmed **Emergency On** key send the emergency information, and the LED glows red.

 **Note:** As for None and 5-Tone emergency alarms, if “Local Emergency Alarm” is enabled via the programming software, the radio will give an alarm tone.

Exiting the emergency alarm:

The emergency alarm initiator exits the Emergency mode in any of the following ways:

- Press the programmed **Emergency Off** key.
- Turn off the radio.
- Once the emergency cycles expire, the radio will exit the Emergency mode automatically.

- Hold the **PTT** key to exit the Emergency mode. The radio will transmit the voice on the channel where the radio operates before entering the Emergency mode (for HDC1200 only).

The emergency alarm receiving party exits the emergency alarm in any of the following ways:

- None: When the alarm is received, the receiving party can press any key to exit the emergency alert. When the alarm initiator exits the Emergency mode or when the Alarm Cycles expire, the receiving radio will exit the emergency alert automatically.
- 5-Tone: When an alarm is received, the receiving party can press any key to exit the emergency alert.
- HDC1200: When an alarm is received, the receiving party can exit the emergency alert by pressing the **TK** key within 2s after pressing the **Back** key, or switching the channel or powering off the radio.

Alarm with Call (None, 5-Tone & HDC1200)

Initiating an emergency alarm:

Step 1 Press the programmed **Emergency On** key to send the emergency information, and the LED glows red.

 **Note:** As for None and 5-Tone emergency alarms, if “Local Emergency Alarm” is enabled via the programming software, the radio will give an alarm tone.

Step 2 If the “Alarm with Call To Follow” feature is enabled, when the alarm tone disappears (None or 5-Tone) or after the Emergency ID is sent (HDC1200), you can speak into the microphone to make an emergency call.

Step 3 If the preset Voice Cycles expire, you can hold the **PTT** key to make the emergency call again (the LED glows red). After the emergency call is transmitted, release the **PTT** key to receive (the LED will flash orange rapidly) (for HDC1200 only).

Exiting the emergency alarm:

The emergency alarm initiator exits the Emergency mode in any of the following ways:

- Press the programmed **Emergency Off** key.
- Turn off the radio.
- After the preset Alarm Cycles and Voice Cycles expire, the radio will exit the Emergency mode automatically (for None and 5-Tone only).

The emergency alarm receiving party exits the emergency alarm in any of the following ways:

- None: When the alarm is received, the receiving party can press any key to exit the emergency alert. When the alarm initiator exits the Emergency mode or when the Alarm Cycles expire, the receiving radio will exit the emergency alert automatically.
- 5-Tone: When an alarm is received, the receiving party can press any key to exit the emergency alert.

- HDC1200: When an alarm is received, the receiving party can exit the emergency alert by pressing the **TK** key within 2s after pressing the **Back** key, or switching the channel or powering off the radio.

Call Only (HDC1200)

Initiating an emergency alarm:

Step 1 Press the programmed **Emergency** key to go to the Revert Channel, and the LED glows red.

Step 2 If the feature “Alarm with Call to Follow” is enabled, you can speak into the microphone to make an emergency call when the LED glows red.

Step 3 When the LED flashes orange, your radio can receive voice.

Exiting the emergency alarm:

To exit the Emergency mode, press the programmed **Emergency Off** key or power off the radio.

The emergency receiving party cannot exit the emergency alarm manually. When the initiator exits the alarm, the receiving radio will exit automatically.



Note: Your dealer may set the number of alarm cycles and alarm duration (None, 5-Tone), number of polite retries and impolite retries (HDC1200), number of voice cycles, duration of each transmission and TX interval.

8.21.5 Operation Method for Digital Emergency

Alarm

Initiating an emergency alarm:

Press the programmed **Emergency On** key send the emergency information, and the LED glows red.

Exiting the emergency alarm:

The emergency alarm initiator exits the Emergency mode in any of the following ways:

- Press the programmed **Emergency Off** key.
- Turn off the radio.
- Once the emergency cycles expire, the radio will exit the Emergency mode automatically.

When an alarm is received, the receiving party can exit the emergency alert by pressing the **TK** key within 2s after pressing the **Back** key, or switching the channel or powering off the radio.

Alarm with Call

Initiating an emergency alarm:

Step 1 Press the programmed **Emergency On** key to send the emergency information, and the LED glows red.

Step 2 When the LED glows red, you can hold the **PTT** key and speak into the microphone to make an emergency call.

 **Note:** If the Alarm with Call To Follow feature is enabled by your dealer, you can speak into the microphone without holding the **PTT** key. If the preset Voice Cycles expire, you can hold the **PTT** key to make the emergency call again.

Step 3 When the LED flashes orange quickly, you can receive. And when a call is received, the LED glows green.

Step 4 If the preset Voice Cycles expire, you can press the **PTT** key to make the emergency call again (the LED glows red). Release the **PTT** key to receive (the LED flashes orange quickly); when a call is received, the LED glows green solidly.

Exiting the emergency alarm:

To exit the Emergency mode, press the programmed **Emergency Off** key or power off the radio.

When an alarm is received, the receiving party can exit the emergency alert by pressing the **TK** key within 2s after pressing the **Back** key, or switching the channel or powering off the radio.

Emergency Call

Initiating an emergency alarm:

Step 1 Press the programmed **Emergency** key to go to the Revert Channel.

Step 2 If the feature “Alarm with Call to Follow” is enabled, you can speak into the microphone to make an emergency call when the LED glows red.

Step 3 When the LED flashes orange, your radio can receive call.

Step 4 If the preset Voice Cycles expire, you can hold the **PTT** key to make the emergency call again (the LED glows red). After the emergency call is transmitted, please release the **PTT** key to receive.

Exiting the emergency alarm:

To exit the Emergency mode, press the programmed **Emergency Off** key or power off the radio.

The emergency receiving party cannot exit the emergency alarm manually. When the initiator exits the alarm, the receiving radio will exit automatically.

 **Note:** Your dealer may set the number of polite retries and impolite retries, number of voice cycles, duration of each transmission and TX interval.

9. Troubleshooting

Phenomena	Analysis	Solution
Power-on failure	The battery may be improperly installed.	Remove the battery and attach it again.
	The battery may run out.	Recharge or replace the battery.
	The battery may suffer from poor contact caused by dirtied or damaged battery contacts.	Clean the battery contacts. If the problem can not be solved, contact your dealer or authorized service center for inspection and repair.
During receiving, the voice is weak, discontinuous or totally inactive.	The battery power may be too low.	Recharge or replace the battery.
	The volume may be set to a low level.	Increase the volume.
	The antenna may get loose or improperly installed.	Power off the radio, and re-install the antenna.
	The speaker may be blocked or damaged.	Clean surface of the speaker. If the problem can not be solved, contact your dealer or authorized service center for inspection and repair.
You can not communicate with other members.	The frequency or signaling may be inconsistent with that of other members.	Set your TX/RX frequency and signaling to the same as that of other members.
	The channel type (digital/analog) may be set inconsistently.	Make sure all members are on the same digital/analog channel.
	You may be too far away from the group members.	Move towards other members.
Irrelevant communication or noise is heard on	You may be interrupted by radios using the same frequency.	Change the frequency, or adjust the squelch level.

Phenomena	Analysis	Solution
the channel.	The radio may be set with no signaling.	Set signaling for all member radios to avoid interference at the same frequency.
The noise is too loud.	You may be too far away from other members.	Move towards other members.
	You may be at an unfavorable position. For example, your communication may be blocked by high buildings or frustrated in the underground areas.	Move to an open and flat area, and restart the radio to try again.
	You may suffer from external disturbance (such as electromagnetic interference).	Stay away from equipment that may cause interference.
The GPS cannot locate your position. ▼	No GPS signal is received.	Move to an open and flat area, and restart the radio.

If the above solutions can not fix the problems for you, or you may have some other queries, please contact us or your local dealer for more technical support.

10. Care and Cleaning

To guarantee optimal performance as well as a long service life of the product, please follow the tips below.

Product Care

- Do not pierce or scrape the product.
- Keep the product far away from substances that can corrode the circuit.
- Do not hold the product by its antenna or earpiece cable directly.
- Attach the accessory jack cover when the accessory is not in use.

Product Cleaning



Caution: Power off the product and remove the battery before cleaning.

- Clean up the dust and fine particles on the product surface and charging piece with a clean and dry lint-free cloth or a brush regularly.
- Use neutral cleanser and a non-woven fabric to clean the keys, control knobs and front case. Do not use chemical preparations such as stain removers, alcohol, sprays or oil preparations, so as to avoid surface case damage.
- Make sure the product is completely dry before use.

11. Optional Accessories

The following items are the main optional accessories for the radio. For more information of other accessories, please consult your local dealer.

			
Earbud with On-MIC PTT ESN10	D-earset with In-Line Microphone EHN12	Earpiece with On-MIC PTT & Transparent Acoustic Tube EAN16	3-Wire Surveillance Earpiece with Transparent Acoustic Tube (black/beige) EAN17/ EAN18
			
Receive-Only Earbud ESS07	Receive-Only Earpiece with Transparent Acoustic Tube ESS08	Remote Speaker Microphone (IP57) SM18N2	Vehicle Adapter for Charger CHV09
			
MCU Multi-unit	Battery Optimizing	Programming Cable	Leather Carrying

Rapid-rate Charger (for Li-Ion/Ni-MH batteries) MCA06	System MCA05	(USB Port) PC38	Case (swivel) LCY003
---	-----------------	-----------------	----------------------

 **Caution:** Use the accessories specified by the Company only. If not, Hytera shall not be liable for any losses or damages arising out of use of unauthorized accessories.

12. Appendix

12.1 Signaling Introduction

The radio supports the following signaling. You can ask your dealer to make appropriate settings on the radio. For detailed information, please consult your dealer.

12.1.1 HDC1200

The HDC1200 signaling is compatible with the MDC1200 signaling, and realizes functions such as PTT ID (Encoding & Decoding), Emergency (Encoding & Decoding) and Selective Call (Encoding & Decoding).

Encoding

When initiating a normal call, hold the **PTT** key during normal voice communication to send PTT ID. For encoding, the radio will provide the following indications:

- PTT ID/Selective Call: Your dealer can program whether the radio sounds side tone during encoding or beeps after encoding.
- Selective Call: During encoding, the LED glows red. After encoding, the LED glows orange.

Decoding

For decoding, the radio provides the following indications:

- Selective Call: After decoding, the radio provides the following indications:
 - Tone: The radio will give the tone by default.
 - LED: The LED glows green.

12.1.2 5-Tone

The radio can realize various types of calls through 5-Tone signaling.

Encoding

Step 1 Request your dealer to configure the correct format and type for the encoding contents.

Step 2 When the format consists of fixed codes only, you do not have to edit such fields or save such data.

Step 3 Hold the **PTT** key or press the programmed **One Touch Call** key to send the 2-Tone signaling.

During encoding, the LED glows red and the Side tone will be given. If Auto Reset is enabled (by your dealer), the radio will enter the Auto Reset mode after successful encoding, with the LED glowing orange, until the Auto Reset Time expires.

Decoding

The radio can automatically decode the 5-Tone signaling when receiving any matched one.

During decoding, the LED glows green. If Auto Reset is enabled (by your dealer), the radio will enter the Auto Reset mode, with the LED glowing orange, until the Auto Reset Time expires.

12.1.3 2-Tone

With the 2-Tone signaling, the radio can transmit and receive 2-Tone calls.

Encoding

Step 1 Request your dealer to configure the correct format and type for the encoding contents.

Step 2 Hold the **PTT** key or press the programmed **One Touch Call** key to send the 2-Tone signaling.

During encoding, the LED glows red and the Side tone will be given. If Auto Reset is enabled (by your dealer), the radio will enter the Auto Reset mode after successful encoding, with the LED glowing orange, until the Auto Reset Time expires.

Decoding

The radio can automatically decode the 2-Tone signaling when receiving any matched one.

During decoding, the LED glows green. If Auto Reset is enabled (by your dealer), the radio will enter the Auto Reset mode, with the LED glowing orange, until the Auto Reset Time expires. The radio cannot enter the Auto Reset mode if the call is an alert call.