

Test Plot 1#: Antenna 1_PTT_FM 12.5kHz_Face Up_140 MHz**DUT: Digital Portable Radio; Type: PD602i VHF; Serial: 18052401120**

Communication System: FM; Frequency: 140 MHz; Duty Cycle: 1:1

Medium parameters used: $f = 140$ MHz; $\sigma = 0.738$ S/m; $\epsilon_r = 54.409$; $\rho = 1000$ kg/m³

Phantom section: Flat Section

DASY5 Configuration:

- Probe: EX3DV4 - SN7329; ConvF(12.88, 12.88, 12.88); Calibrated: 2018/1/22;
- Sensor-Surface: 1.4mm (Mechanical Surface Detection)
- Electronics: DAE4 Sn1459; Calibrated: 2017/9/15
- Phantom: ELI v8.0; Type: QDOVA004AA; Serial: 2051
- Measurement SW: DASY52, Version 52.8 (8);

Area Scan (71x101x1): Interpolated grid: dx=1.500 mm, dy=1.500 mm

Maximum value of SAR (interpolated) = 1.65 W/kg

Zoom Scan (6x6x7)/Cube 0: Measurement grid: dx=8mm, dy=8mm, dz=5mm

Reference Value = 30.98 V/m; Power Drift = -0.14 dB

Peak SAR (extrapolated) = 2.25 W/kg

SAR(1 g) = 0.965 W/kg; SAR(10 g) = 0.663 W/kg

Maximum value of SAR (measured) = 1.52 W/kg

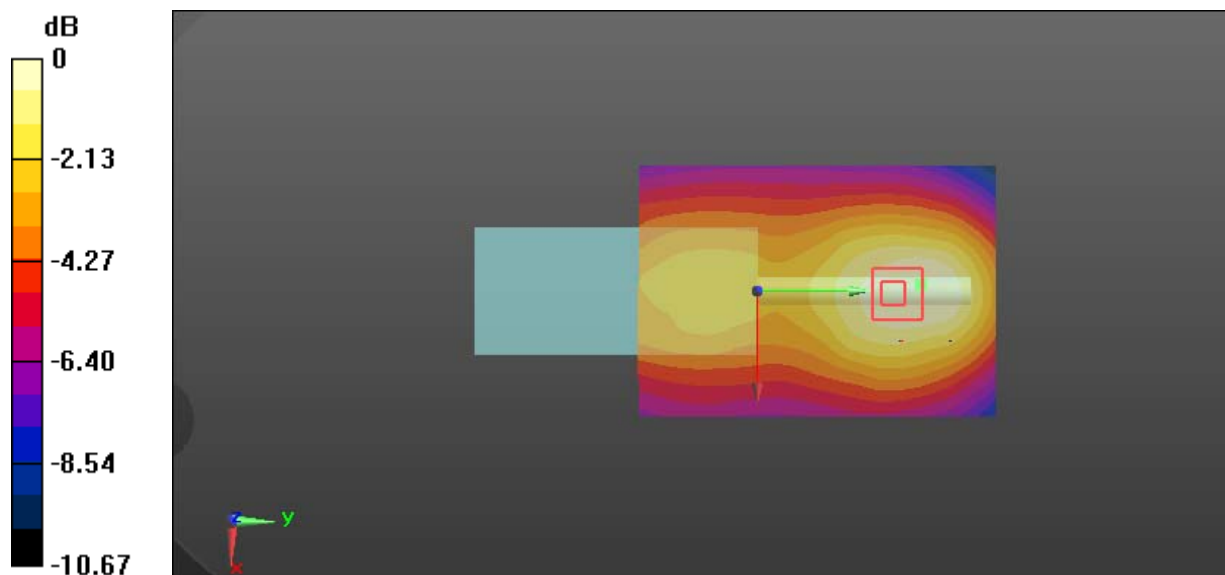

0 dB = 1.52 W/kg = 1.82 dBW/kg

Test Plot 2#: Antenna 1_PTT_FM 25kHz_Face Up_140 MHz**DUT: Digital Portable Radio; Type: PD602i VHF; Serial: 18052401120**

Communication System: FM; Frequency: 140 MHz; Duty Cycle: 1:1

Medium parameters used: $f = 140$ MHz; $\sigma = 0.738$ S/m; $\epsilon_r = 54.409$; $\rho = 1000$ kg/m³

Phantom section: Flat Section

DASY5 Configuration:

- Probe: EX3DV4 - SN7329; ConvF(12.88, 12.88, 12.88); Calibrated: 2018/1/22;
- Sensor-Surface: 1.4mm (Mechanical Surface Detection)
- Electronics: DAE4 Sn1459; Calibrated: 2017/9/15
- Phantom: ELI v8.0; Type: QDOVA004AA; Serial: 2051
- Measurement SW: DASY52, Version 52.8 (8);

Area Scan (71x101x1): Interpolated grid: dx=1.500 mm, dy=1.500 mm

Maximum value of SAR (interpolated) = 1.82 W/kg

Zoom Scan (6x6x7)/Cube 0: Measurement grid: dx=8mm, dy=8mm, dz=5mm

Reference Value = 29.65 V/m; Power Drift = 0.01 dB

Peak SAR (extrapolated) = 2.62 W/kg

SAR(1 g) = 1.16 W/kg; SAR(10 g) = 0.798 W/kg

Maximum value of SAR (measured) = 1.85 W/kg

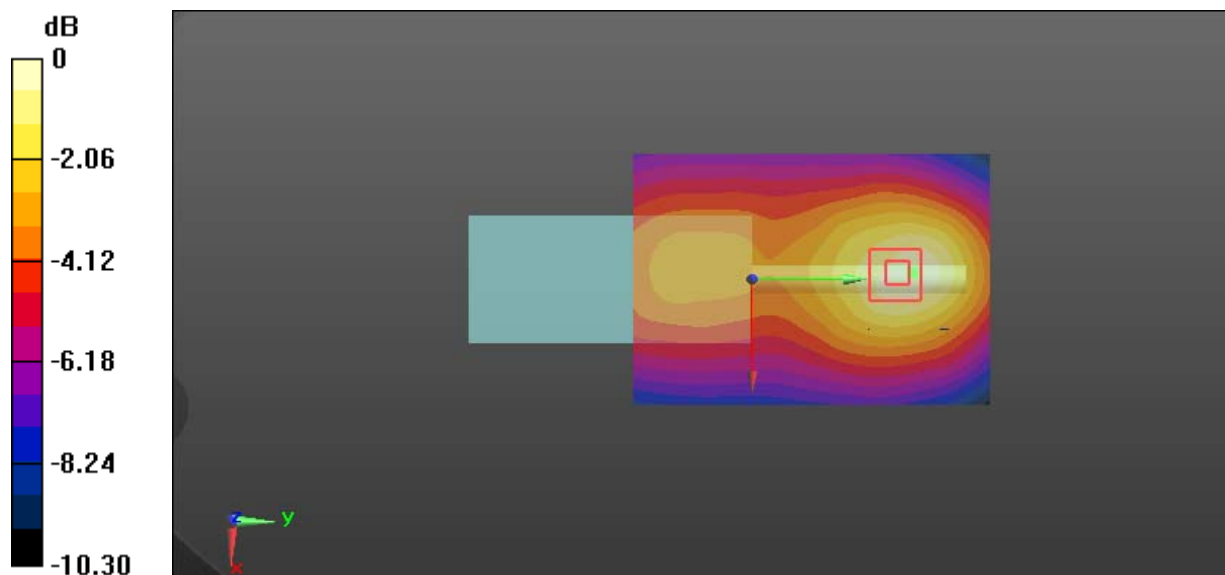

0 dB = 1.85 W/kg = 2.67 dBW/kg

Test Plot 3#: Antenna 1_PTT_4FSK 12.5kHz_Face Up_140 MHz

DUT: Digital Poratable Radio; Type: PD602i VHF; Serial: 18052401120

Communication System: 4FSK; Frequency: 140 MHz;Duty Cycle: 1:2
 Medium parameters used: $f = 140 \text{ MHz}$; $\sigma = 0.738 \text{ S/m}$; $\epsilon_r = 54.409$; $\rho = 1000 \text{ kg/m}^3$
 Phantom section: Flat Section

DASY5 Configuration:

- Probe: EX3DV4 - SN7329; ConvF(12.88, 12.88, 12.88); Calibrated: 2018/1/22;
- Sensor-Surface: 1.4mm (Mechanical Surface Detection)
- Electronics: DAE4 Sn1459; Calibrated: 2017/9/15
- Phantom: ELI v8.0; Type: QDOVA004AA; Serial: 2051
- Measurement SW: DASY52, Version 52.8 (8);

Area Scan (71x101x1): Interpolated grid: $dx=1.500 \text{ mm}$, $dy=1.500 \text{ mm}$
 Maximum value of SAR (interpolated) = 0.999 W/kg

Zoom Scan (5x5x7)/Cube 0: Measurement grid: $dx=8\text{mm}$, $dy=8\text{mm}$, $dz=5\text{mm}$
 Reference Value = 24.06 V/m ; Power Drift = -0.09 dB
 Peak SAR (extrapolated) = 1.49 W/kg

SAR(1 g) = 0.619 W/kg; SAR(10 g) = 0.440 W/kg
 Maximum value of SAR (measured) = 0.978 W/kg

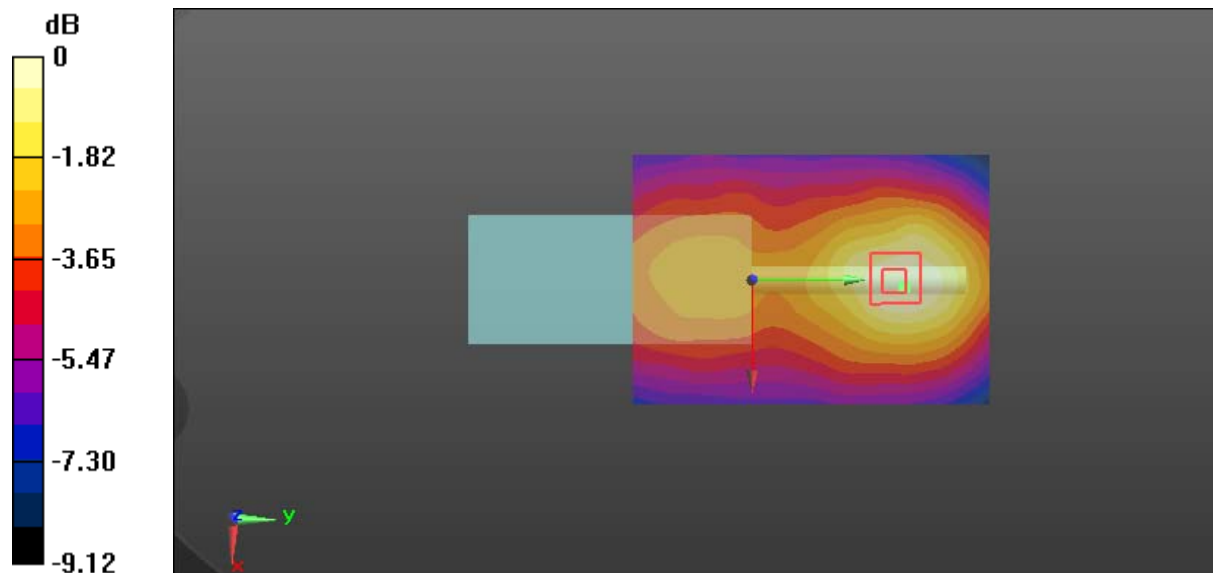

0 dB = $0.978 \text{ W/kg} = -0.10 \text{ dBW/kg}$

Test Plot 4#: Antenna 1_PTT_FM 12.5kHz_Body Back_136.0125 MHz**DUT: Digital Portable Radio; Type: PD602i VHF; Serial: 18052401120**

Communication System: FM; Frequency: 136.012 MHz; Duty Cycle: 1:1

Medium parameters used: $f = 136.012$ MHz; $\sigma = 0.779$ S/m; $\epsilon_r = 64.379$; $\rho = 1000$ kg/m³

Phantom section: Flat Section

DASY5 Configuration:

- Probe: EX3DV4 - SN7329; ConvF(12.56, 12.56, 12.56); Calibrated: 2018/1/22;
- Sensor-Surface: 1.4mm (Mechanical Surface Detection)
- Electronics: DAE4 Sn1459; Calibrated: 2017/9/15
- Phantom: ELI v8.0; Type: QDOVA004AA; Serial: 2051
- Measurement SW: DASY52, Version 52.8 (8);

Area Scan (71x101x1): Interpolated grid: dx=1.500 mm, dy=1.500 mm

Maximum value of SAR (interpolated) = 10.7 W/kg

Zoom Scan (5x5x7)/Cube 0: Measurement grid: dx=8mm, dy=8mm, dz=5mm

Reference Value = 59.73 V/m; Power Drift = -0.12 dB

Peak SAR (extrapolated) = 20.5 W/kg

SAR(1 g) = 5.35 W/kg; SAR(10 g) = 2.53 W/kg

Maximum value of SAR (measured) = 11.7 W/kg

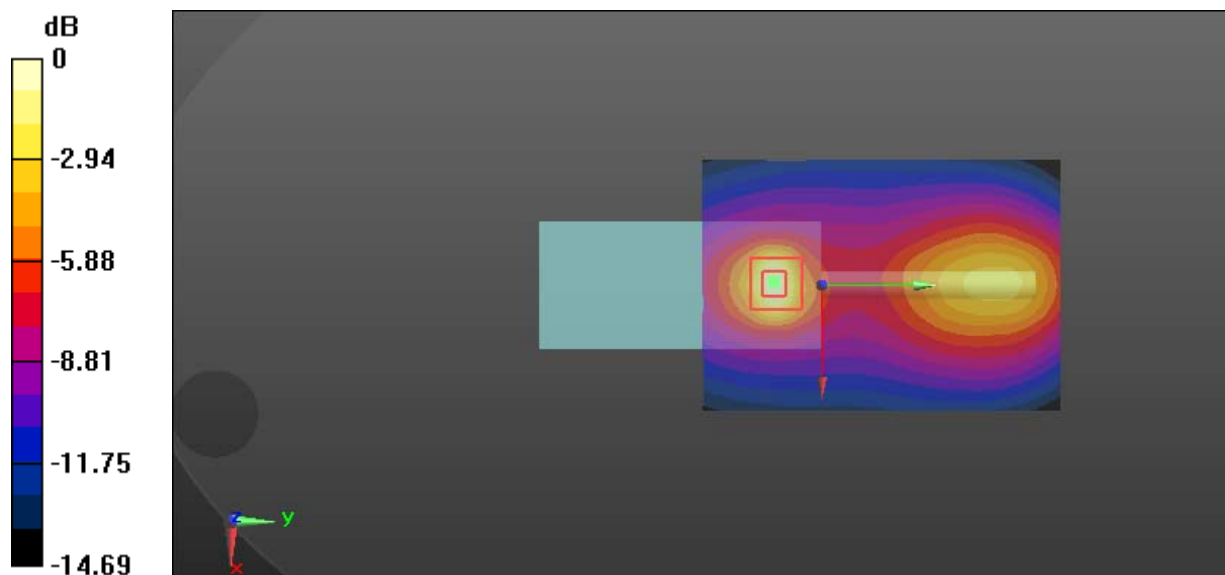

0 dB = 11.7 W/kg = 10.68 dBW/kg

Test Plot 5#: Antenna 1_PTT_FM 12.5kHz_Body Back_140 MHz**DUT: Digital Poratable Radio; Type: PD602i VHF; Serial: 18052401120**

Communication System: FM; Frequency: 140 MHz; Duty Cycle: 1:1

Medium parameters used: $f = 140$ MHz; $\sigma = 0.769$ S/m; $\epsilon_r = 64.444$; $\rho = 1000$ kg/m³

Phantom section: Flat Section

DASY5 Configuration:

- Probe: EX3DV4 - SN7329; ConvF(12.56, 12.56, 12.56); Calibrated: 2018/1/22;
- Sensor-Surface: 1.4mm (Mechanical Surface Detection)
- Electronics: DAE4 Sn1459; Calibrated: 2017/9/15
- Phantom: ELI v8.0; Type: QDOVA004AA; Serial: 2051
- Measurement SW: DASY52, Version 52.8 (8);

Area Scan (71x101x1): Interpolated grid: dx=1.500 mm, dy=1.500 mm

Maximum value of SAR (interpolated) = 12.1 W/kg

Zoom Scan (5x5x7)/Cube 0: Measurement grid: dx=8mm, dy=8mm, dz=5mm

Reference Value = 68.83 V/m; Power Drift = -0.06 dB

Peak SAR (extrapolated) = 24.8 W/kg

SAR(1 g) = 6.99 W/kg; SAR(10 g) = 3.4 W/kg

Maximum value of SAR (measured) = 14.8 W/kg

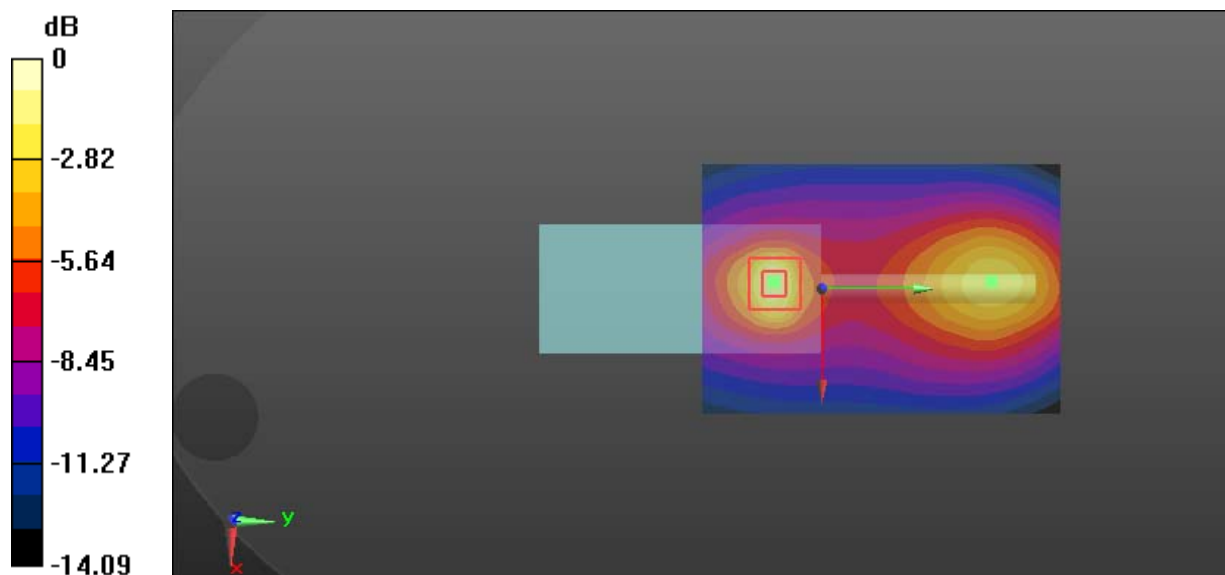

0 dB = 14.8 W/kg = 11.70 dBW/kg

Test Plot 6#: Antenna 1_PTT_FM 12.5kHz_Body Back_144.9875 MHz**DUT: Digital Poratable Radio; Type: PD602i VHF; Serial: 18052401120**

Communication System: FM; Frequency: 144.988 MHz; Duty Cycle: 1:1

Medium parameters used: $f = 144.988$ MHz; $\sigma = 0.776$ S/m; $\epsilon_r = 64.319$; $\rho = 1000$ kg/m³

Phantom section: Flat Section

DASY5 Configuration:

- Probe: EX3DV4 - SN7329; ConvF(12.56, 12.56, 12.56); Calibrated: 2018/1/22;
- Sensor-Surface: 1.4mm (Mechanical Surface Detection)
- Electronics: DAE4 Sn1459; Calibrated: 2017/9/15
- Phantom: ELI v8.0; Type: QDOVA004AA; Serial: 2051
- Measurement SW: DASY52, Version 52.8 (8);

Area Scan (71x101x1): Interpolated grid: dx=1.500 mm, dy=1.500 mm

Maximum value of SAR (interpolated) = 4.52 W/kg

Zoom Scan (5x5x7)/Cube 0: Measurement grid: dx=8mm, dy=8mm, dz=5mm

Reference Value = 41.21 V/m; Power Drift = -0.12 dB

Peak SAR (extrapolated) = 8.29 W/kg

SAR(1 g) = 2.32 W/kg; SAR(10 g) = 1.14 W/kg

Maximum value of SAR (measured) = 4.83 W/kg

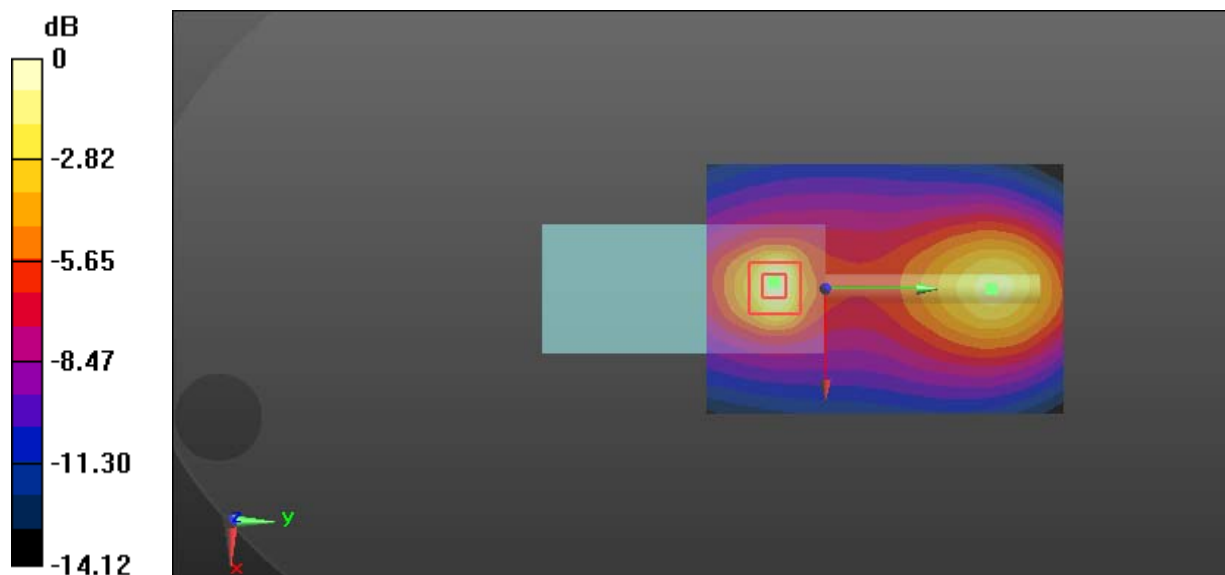

0 dB = 4.83 W/kg = 6.84 dBW/kg

Test Plot 7#: Antenna 1_PTT_FM 25kHz_Body Back_136.0125 MHz**DUT: Digital Portable Radio; Type: PD602i VHF; Serial: 18052401120**

Communication System: FM; Frequency: 136.012 MHz; Duty Cycle: 1:1

Medium parameters used: $f = 136.012$ MHz; $\sigma = 0.779$ S/m; $\epsilon_r = 64.379$; $\rho = 1000$ kg/m³

Phantom section: Flat Section

DASY5 Configuration:

- Probe: EX3DV4 - SN7329; ConvF(12.56, 12.56, 12.56); Calibrated: 2018/1/22;
- Sensor-Surface: 1.4mm (Mechanical Surface Detection)
- Electronics: DAE4 Sn1459; Calibrated: 2017/9/15
- Phantom: ELI v8.0; Type: QDOVA004AA; Serial: 2051
- Measurement SW: DASY52, Version 52.8 (8);

Area Scan (71x101x1): Interpolated grid: dx=1.500 mm, dy=1.500 mm

Maximum value of SAR (interpolated) = 10.4 W/kg

Zoom Scan (5x5x7)/Cube 0: Measurement grid: dx=8mm, dy=8mm, dz=5mm

Reference Value = 51.90 V/m; Power Drift = -0.15 dB

Peak SAR (extrapolated) = 20.5 W/kg

SAR(1 g) = 5.28 W/kg; SAR(10 g) = 2.5 W/kg

Maximum value of SAR (measured) = 11.4 W/kg

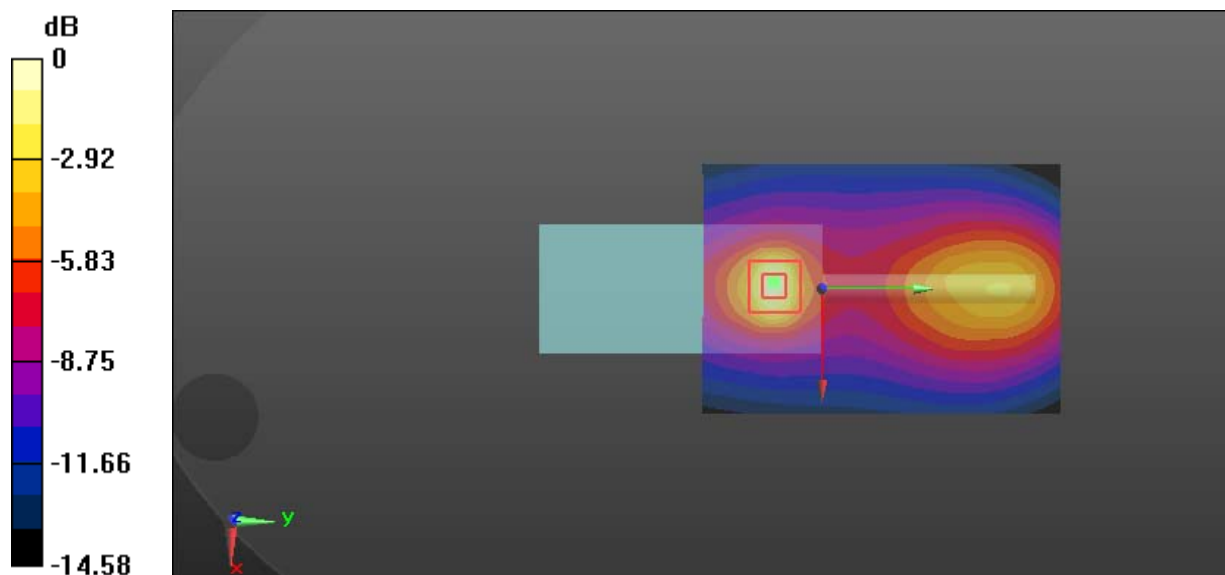

0 dB = 11.4 W/kg = 10.57 dBW/kg

Test Plot 8#: Antenna 1_PTT_FM 25kHz_Body Back_140 MHz**DUT: Digital Portable Radio; Type: PD602i VHF; Serial: 18052401120**

Communication System: FM; Frequency: 140 MHz; Duty Cycle: 1:1

Medium parameters used: $f = 140$ MHz; $\sigma = 0.769$ S/m; $\epsilon_r = 64.444$; $\rho = 1000$ kg/m³

Phantom section: Flat Section

DASY5 Configuration:

- Probe: EX3DV4 - SN7329; ConvF(12.56, 12.56, 12.56); Calibrated: 2018/1/22;
- Sensor-Surface: 1.4mm (Mechanical Surface Detection)
- Electronics: DAE4 Sn1459; Calibrated: 2017/9/15
- Phantom: ELI v8.0; Type: QDOVA004AA; Serial: 2051
- Measurement SW: DASY52, Version 52.8 (8);

Area Scan (71x101x1): Interpolated grid: dx=1.500 mm, dy=1.500 mm

Maximum value of SAR (interpolated) = 14.2 W/kg

Zoom Scan (5x5x7)/Cube 0: Measurement grid: dx=8mm, dy=8mm, dz=5mm

Reference Value = 64.61 V/m; Power Drift = -0.10 dB

Peak SAR (extrapolated) = 27.1 W/kg

SAR(1 g) = 7.2 W/kg; SAR(10 g) = 3.47 W/kg

Maximum value of SAR (measured) = 15.6 W/kg

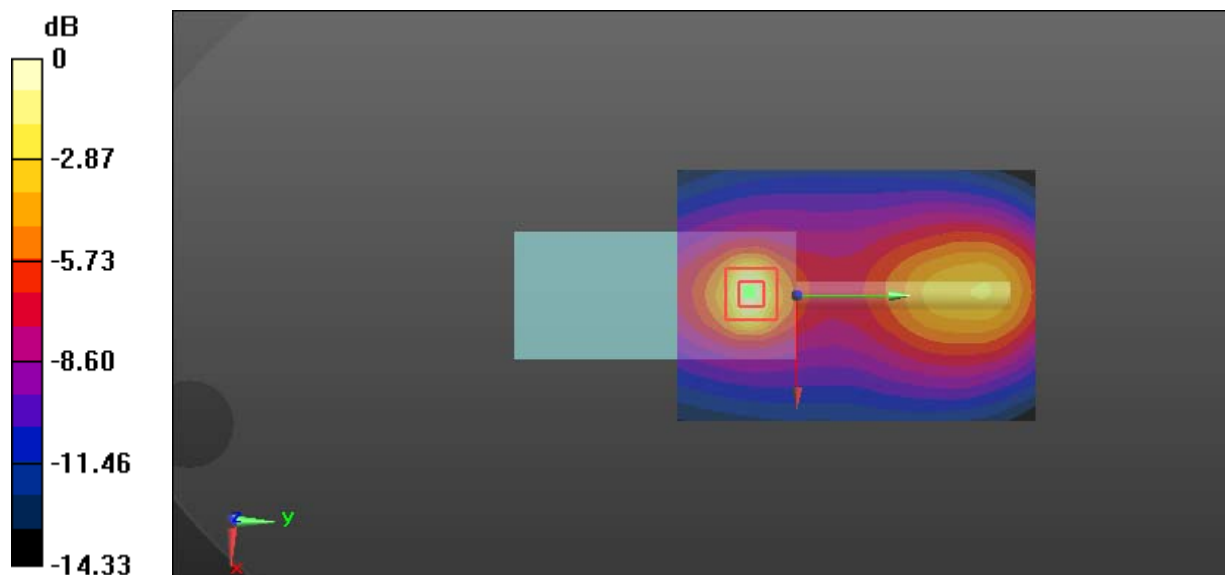

0 dB = 15.6 W/kg = 11.93 dBW/kg

Test Plot 9#: Antenna 1_PTT_FM 25kHz_Body Back_144.9875 MHz**DUT: Digital Portable Radio; Type: PD602i VHF; Serial: 18052401120**

Communication System: FM; Frequency: 144.988 MHz; Duty Cycle: 1:1

Medium parameters used: $f = 144.988$ MHz; $\sigma = 0.776$ S/m; $\epsilon_r = 64.319$; $\rho = 1000$ kg/m³

Phantom section: Flat Section

DASY5 Configuration:

- Probe: EX3DV4 - SN7329; ConvF(12.56, 12.56, 12.56); Calibrated: 2018/1/22;
- Sensor-Surface: 1.4mm (Mechanical Surface Detection)
- Electronics: DAE4 Sn1459; Calibrated: 2017/9/15
- Phantom: ELI v8.0; Type: QDOVA004AA; Serial: 2051
- Measurement SW: DASY52, Version 52.8 (8);

Area Scan (71x101x1): Interpolated grid: dx=1.500 mm, dy=1.500 mm

Maximum value of SAR (interpolated) = 4.92 W/kg

Zoom Scan (5x5x7)/Cube 0: Measurement grid: dx=8mm, dy=8mm, dz=5mm

Reference Value = 36.79 V/m; Power Drift = -0.13 dB

Peak SAR (extrapolated) = 11.2 W/kg

SAR(1 g) = 2.83 W/kg; SAR(10 g) = 1.36 W/kg

Maximum value of SAR (measured) = 6.29 W/kg

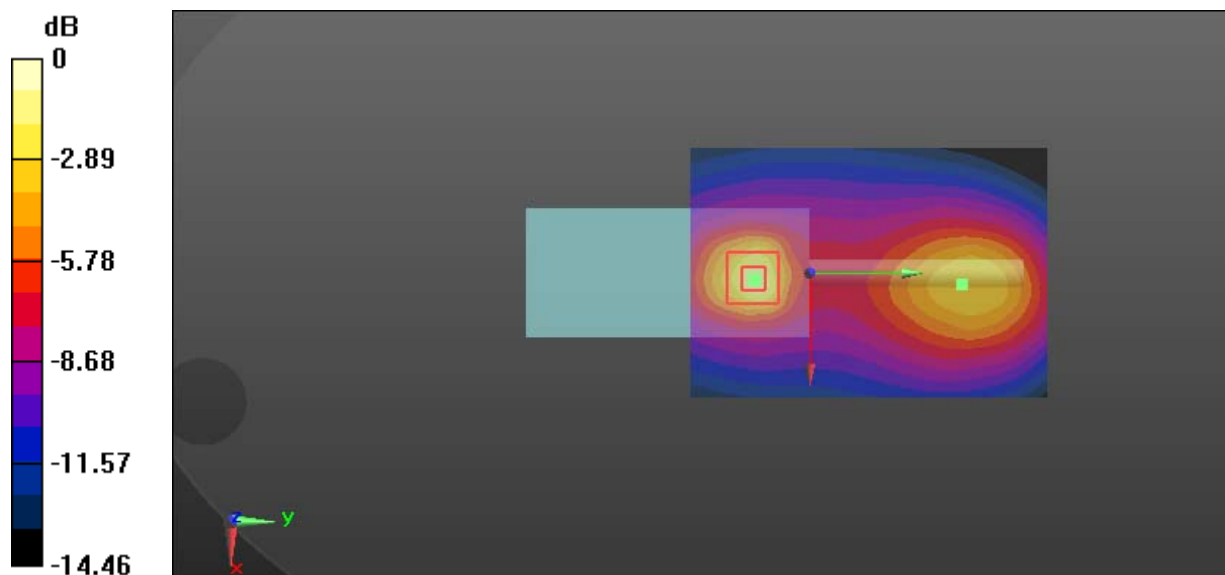

0 dB = 6.29 W/kg = 7.99 dBW/kg

Test Plot 10#: Antenna 1_PTT_4FSK 12.5kHz_Body Back_140 MHz**DUT: Digital Portable Radio; Type: PD602i VHF; Serial: 18052401120**

Communication System: 4FSK; Frequency: 140 MHz; Duty Cycle: 1:2

Medium parameters used: $f = 140$ MHz; $\sigma = 0.769$ S/m; $\epsilon_r = 64.444$; $\rho = 1000$ kg/m³

Phantom section: Flat Section

DASY5 Configuration:

- Probe: EX3DV4 - SN7329; ConvF(12.56, 12.56, 12.56); Calibrated: 2018/1/22;
- Sensor-Surface: 1.4mm (Mechanical Surface Detection)
- Electronics: DAE4 Sn1459; Calibrated: 2017/9/15
- Phantom: ELI v8.0; Type: QDOVA004AA; Serial: 2051
- Measurement SW: DASY52, Version 52.8 (8);

Area Scan (71x101x1): Interpolated grid: dx=1.500 mm, dy=1.500 mm

Maximum value of SAR (interpolated) = 9.47 W/kg

Zoom Scan (5x5x7)/Cube 0: Measurement grid: dx=8mm, dy=8mm, dz=5mm

Reference Value = 44.88 V/m; Power Drift = -0.18 dB

Peak SAR (extrapolated) = 16.3 W/kg

SAR(1 g) = 4.13 W/kg; SAR(10 g) = 1.95 W/kg

Maximum value of SAR (measured) = 8.82 W/kg

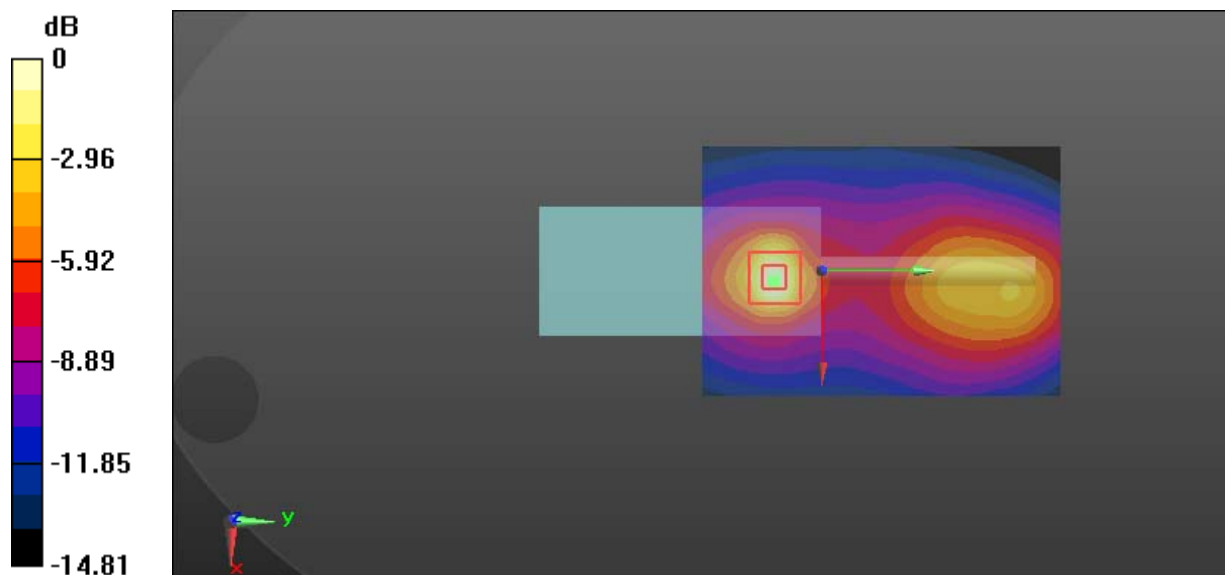

Test Plot 11#: Antenna 2_PTT_FM 12.5kHz_Face Up_144.0125 MHz**DUT: Digital Portable Radio; Type: PD602i VHF; Serial: 18052401120**

Communication System: FM; Frequency: 144.012 MHz; Duty Cycle: 1:1

Medium parameters used: $f = 144.012$ MHz; $\sigma = 0.739$ S/m; $\epsilon_r = 54.347$; $\rho = 1000$ kg/m³

Phantom section: Flat Section

DASY5 Configuration:

- Probe: EX3DV4 - SN7329; ConvF(12.88, 12.88, 12.88); Calibrated: 2018/1/22;
- Sensor-Surface: 1.4mm (Mechanical Surface Detection)
- Electronics: DAE4 Sn1459; Calibrated: 2017/9/15
- Phantom: ELI v8.0; Type: QDOVA004AA; Serial: 2051
- Measurement SW: DASY52, Version 52.8 (8);

Area Scan (71x101x1): Interpolated grid: dx=1.500 mm, dy=1.500 mm

Maximum value of SAR (interpolated) = 2.79 W/kg

Zoom Scan (5x5x7)/Cube 0: Measurement grid: dx=8mm, dy=8mm, dz=5mm

Reference Value = 38.56 V/m; Power Drift = -0.12 dB

Peak SAR (extrapolated) = 4.39 W/kg

SAR(1 g) = 1.78 W/kg; SAR(10 g) = 1.20 W/kg

Maximum value of SAR (measured) = 2.91 W/kg

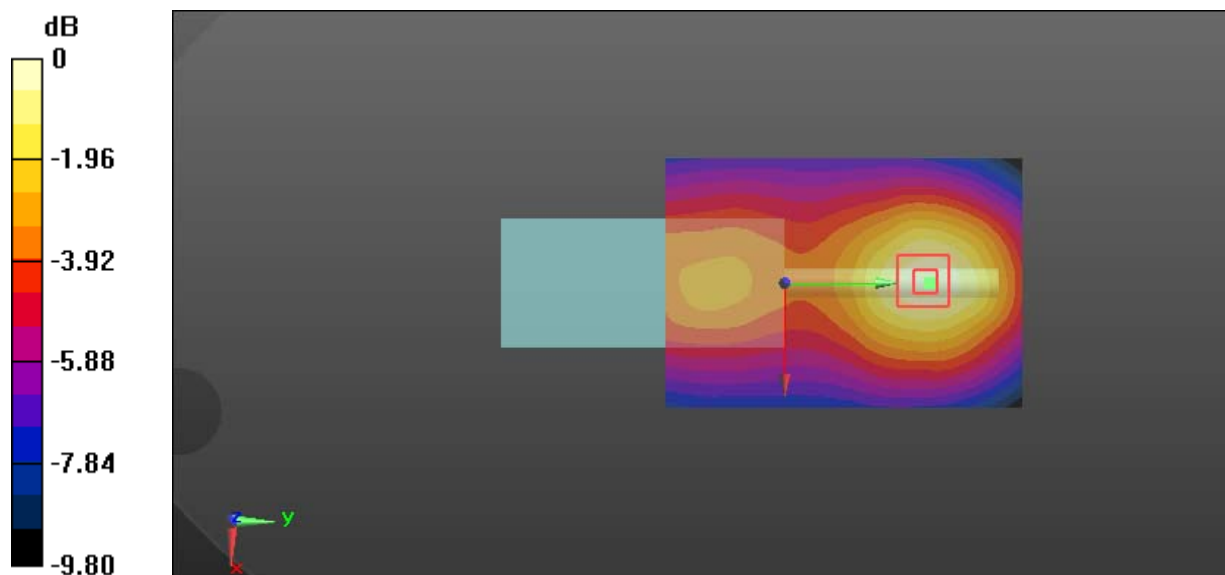

0 dB = 2.91 W/kg = 4.64 dBW/kg

Test Plot 12#: Antenna 2_PTT_FM 25kHz_Face Up_144.0125 MHz**DUT: Digital Portable Radio; Type: PD602i VHF; Serial: 18052401120**

Communication System: FM; Frequency: 144.012 MHz; Duty Cycle: 1:1

Medium parameters used: $f = 144.012$ MHz; $\sigma = 0.739$ S/m; $\epsilon_r = 54.347$; $\rho = 1000$ kg/m³

Phantom section: Flat Section

DASY5 Configuration:

- Probe: EX3DV4 - SN7329; ConvF(12.88, 12.88, 12.88); Calibrated: 2018/1/22;
- Sensor-Surface: 1.4mm (Mechanical Surface Detection)
- Electronics: DAE4 Sn1459; Calibrated: 2017/9/15
- Phantom: ELI v8.0; Type: QDOVA004AA; Serial: 2051
- Measurement SW: DASY52, Version 52.8 (8);

Area Scan (71x101x1): Interpolated grid: dx=1.500 mm, dy=1.500 mm

Maximum value of SAR (interpolated) = 3.20 W/kg

Zoom Scan (5x5x7)/Cube 0: Measurement grid: dx=8mm, dy=8mm, dz=5mm

Reference Value = 41.00 V/m; Power Drift = -0.13 dB

Peak SAR (extrapolated) = 4.77 W/kg

SAR(1 g) = 1.94 W/kg; SAR(10 g) = 1.31 W/kg

Maximum value of SAR (measured) = 3.14 W/kg

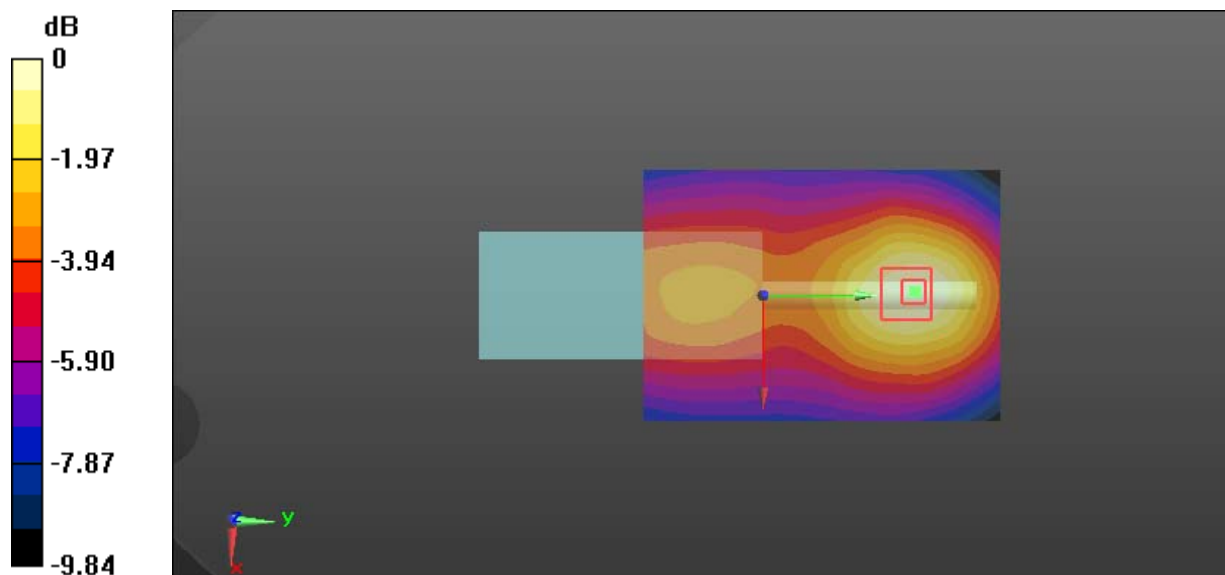

0 dB = 3.14 W/kg = 4.97 dBW/kg

Test Plot 13#: Antenna 2_PTT_4FSK 12.5kHz_Face Up_144.0125 MHz**DUT: Digital Portable Radio; Type: PD602i VHF; Serial: 18052401120**

Communication System: 4FSK; Frequency: 144.012 MHz; Duty Cycle: 1:2

Medium parameters used: $f = 144.012$ MHz; $\sigma = 0.739$ S/m; $\epsilon_r = 54.347$; $\rho = 1000$ kg/m³

Phantom section: Flat Section

DASY5 Configuration:

- Probe: EX3DV4 - SN7329; ConvF(12.88, 12.88, 12.88); Calibrated: 2018/1/22;
- Sensor-Surface: 1.4mm (Mechanical Surface Detection)
- Electronics: DAE4 Sn1459; Calibrated: 2017/9/15
- Phantom: ELI v8.0; Type: QDOVA004AA; Serial: 2051
- Measurement SW: DASY52, Version 52.8 (8);

Area Scan (71x101x1): Interpolated grid: dx=1.500 mm, dy=1.500 mm

Maximum value of SAR (interpolated) = 1.71 W/kg

Zoom Scan (5x5x7)/Cube 0: Measurement grid: dx=8mm, dy=8mm, dz=5mm

Reference Value = 29.42 V/m; Power Drift = -0.17 dB

Peak SAR (extrapolated) = 2.60 W/kg

SAR(1 g) = 1.03 W/kg; SAR(10 g) = 0.702 W/kg

Maximum value of SAR (measured) = 1.68 W/kg

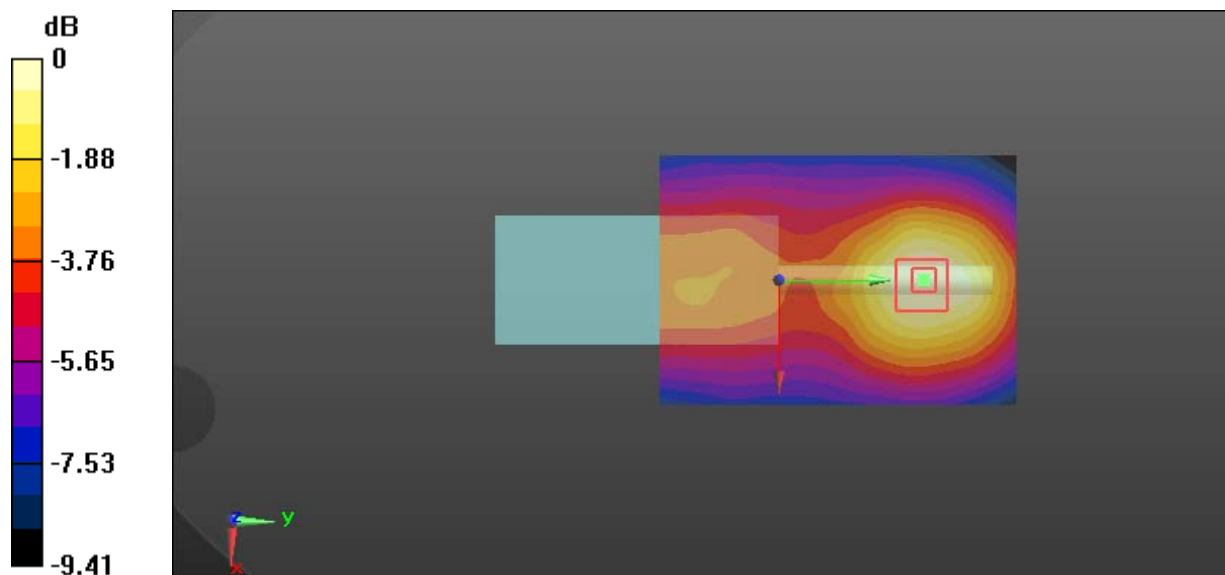

0 dB = 1.68 W/kg = 2.25 dBW/kg

Test Plot 14#: Antenna 2_PTT_FM 12.5kHz_Body Back_144.0125 MHz**DUT: Digital Portable Radio; Type: PD602i VHF; Serial: 18052401120**

Communication System: FM; Frequency: 144.012 MHz; Duty Cycle: 1:1

Medium parameters used: $f = 144.012$ MHz; $\sigma = 0.773$ S/m; $\epsilon_r = 64.304$; $\rho = 1000$ kg/m³

Phantom section: Flat Section

DASY5 Configuration:

- Probe: EX3DV4 - SN7329; ConvF(12.56, 12.56, 12.56); Calibrated: 2018/1/22;
- Sensor-Surface: 1.4mm (Mechanical Surface Detection)
- Electronics: DAE4 Sn1459; Calibrated: 2017/9/15
- Phantom: ELI v8.0; Type: QDOVA004AA; Serial: 2051
- Measurement SW: DASY52, Version 52.8 (8);

Area Scan (71x101x1): Interpolated grid: dx=1.500 mm, dy=1.500 mm

Maximum value of SAR (interpolated) = 17.2 W/kg

Zoom Scan (5x5x7)/Cube 0: Measurement grid: dx=8mm, dy=8mm, dz=5mm

Reference Value = 66.80 V/m; Power Drift = -0.18 dB

Peak SAR (extrapolated) = 41.7 W/kg

SAR(1 g) = 9.35 W/kg; SAR(10 g) = 4.41 W/kg

Maximum value of SAR (measured) = 21.1 W/kg

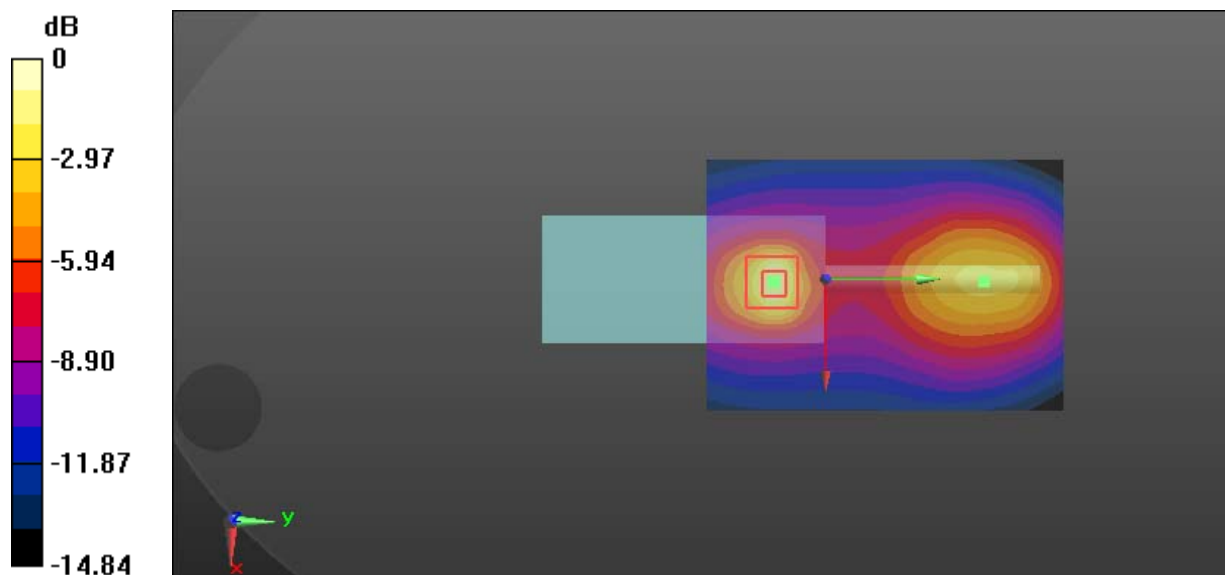

0 dB = 21.1 W/kg = 13.24 dBW/kg

Test Plot 15#: Antenna 2_PTT_FM 12.5kHz_Body Back_149 MHz**DUT: Digital Portable Radio; Type: PD602i VHF; Serial: 18052401120**

Communication System: FM; Frequency: 149 MHz; Duty Cycle: 1:1

Medium parameters used: $f = 149$ MHz; $\sigma = 0.794$ S/m; $\epsilon_r = 63.516$; $\rho = 1000$ kg/m³

Phantom section: Flat Section

DASY5 Configuration:

- Probe: EX3DV4 - SN7329; ConvF(12.56, 12.56, 12.56); Calibrated: 2018/1/22;
- Sensor-Surface: 1.4mm (Mechanical Surface Detection)
- Electronics: DAE4 Sn1459; Calibrated: 2017/9/15
- Phantom: ELI v8.0; Type: QDOVA004AA; Serial: 2051
- Measurement SW: DASY52, Version 52.8 (8);

Area Scan (71x151x1): Interpolated grid: dx=1.500 mm, dy=1.500 mm

Maximum value of SAR (interpolated) = 10.5 W/kg

Zoom Scan (5x5x7)/Cube 0: Measurement grid: dx=8mm, dy=8mm, dz=5mm

Reference Value = 55.05 V/m; Power Drift = -0.13 dB

Peak SAR (extrapolated) = 30.3 W/kg

SAR(1 g) = 6.79 W/kg; SAR(10 g) = 3.15 W/kg

Maximum value of SAR (measured) = 15.2 W/kg

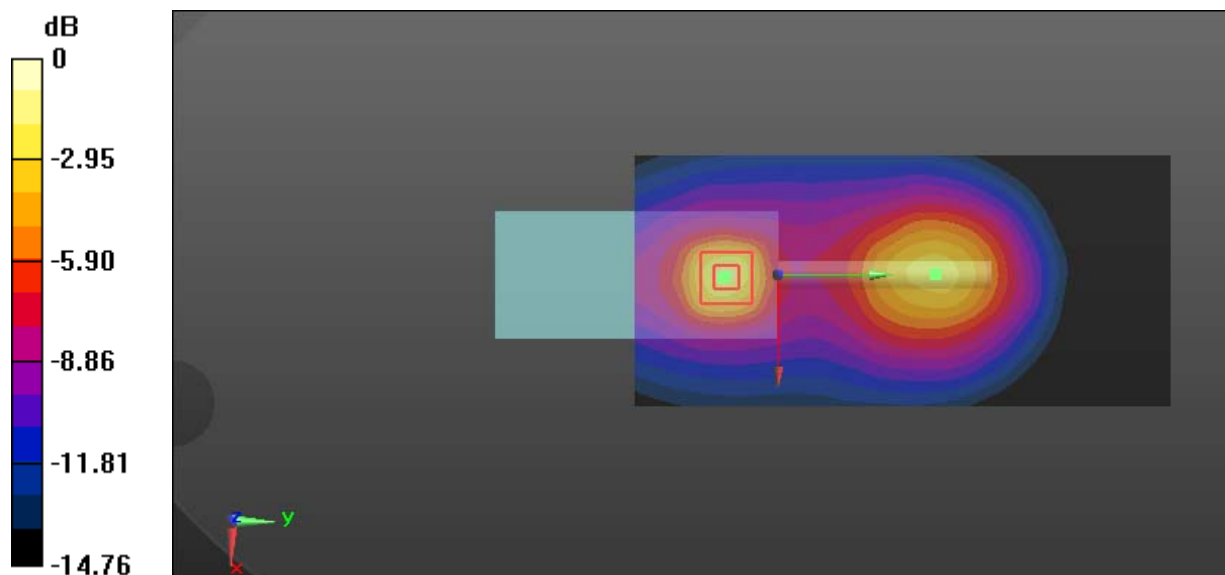

0 dB = 15.2 W/kg = 11.82 dBW/kg

Test Plot 16#: Antenna 2_PTT_FM 12.5kHz_Body Back_153.9875 MHz**DUT: Digital Portable Radio; Type: PD602i VHF; Serial: 18052401120**

Communication System: FM; Frequency: 153.988 MHz; Duty Cycle: 1:1

Medium parameters used: $f = 153.988$ MHz; $\sigma = 0.81$ S/m; $\epsilon_r = 63.454$; $\rho = 1000$ kg/m³

Phantom section: Flat Section

DASY5 Configuration:

- Probe: EX3DV4 - SN7329; ConvF(12.56, 12.56, 12.56); Calibrated: 2018/1/22;
- Sensor-Surface: 1.4mm (Mechanical Surface Detection)
- Electronics: DAE4 Sn1459; Calibrated: 2017/9/15
- Phantom: ELI v8.0; Type: QDOVA004AA; Serial: 2051
- Measurement SW: DASY52, Version 52.8 (8);

Area Scan (71x101x1): Interpolated grid: dx=1.500 mm, dy=1.500 mm

Maximum value of SAR (interpolated) = 8.51 W/kg

Zoom Scan (5x5x7)/Cube 0: Measurement grid: dx=8mm, dy=8mm, dz=5mm

Reference Value = 52.04 V/m; Power Drift = -0.07 dB

Peak SAR (extrapolated) = 20.1 W/kg

SAR(1 g) = 4.48 W/kg; SAR(10 g) = 2.12 W/kg

Maximum value of SAR (measured) = 9.90 W/kg

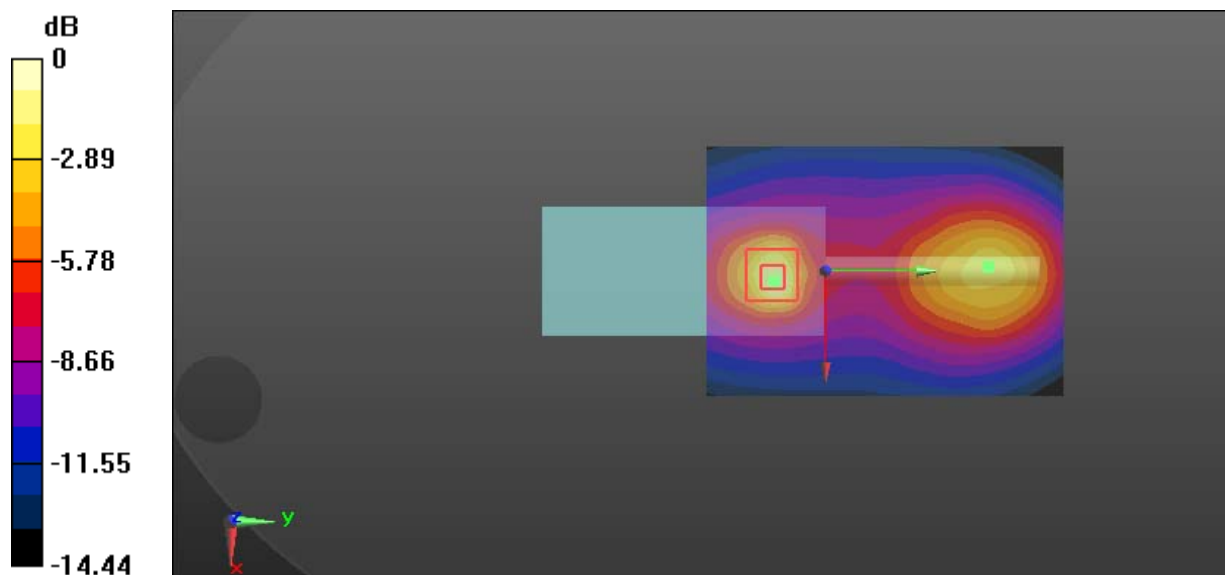

0 dB = 9.90 W/kg = 9.96 dBW/kg

Test Plot 17#: Antenna 2_PTT_FM 25kHz_Body Back_144.0125 MHz**DUT: Digital Portable Radio; Type: PD602i VHF; Serial: 18052401120**

Communication System: FM; Frequency: 144.012 MHz; Duty Cycle: 1:1

Medium parameters used: $f = 144.012$ MHz; $\sigma = 0.773$ S/m; $\epsilon_r = 64.304$; $\rho = 1000$ kg/m³

Phantom section: Flat Section

DASY5 Configuration:

- Probe: EX3DV4 - SN7329; ConvF(12.56, 12.56, 12.56); Calibrated: 2018/1/22;
- Sensor-Surface: 1.4mm (Mechanical Surface Detection)
- Electronics: DAE4 Sn1459; Calibrated: 2017/9/15
- Phantom: ELI v8.0; Type: QDOVA004AA; Serial: 2051
- Measurement SW: DASY52, Version 52.8 (8);

Area Scan (71x101x1): Interpolated grid: dx=1.500 mm, dy=1.500 mm

Maximum value of SAR (interpolated) = 18.2 W/kg

Zoom Scan (5x5x7)/Cube 0: Measurement grid: dx=8mm, dy=8mm, dz=5mm

Reference Value = 69.81 V/m; Power Drift = -0.07 dB

Peak SAR (extrapolated) = 36.5 W/kg

SAR(1 g) = 8.87 W/kg; SAR(10 g) = 4.25 W/kg

Maximum value of SAR (measured) = 18.4 W/kg

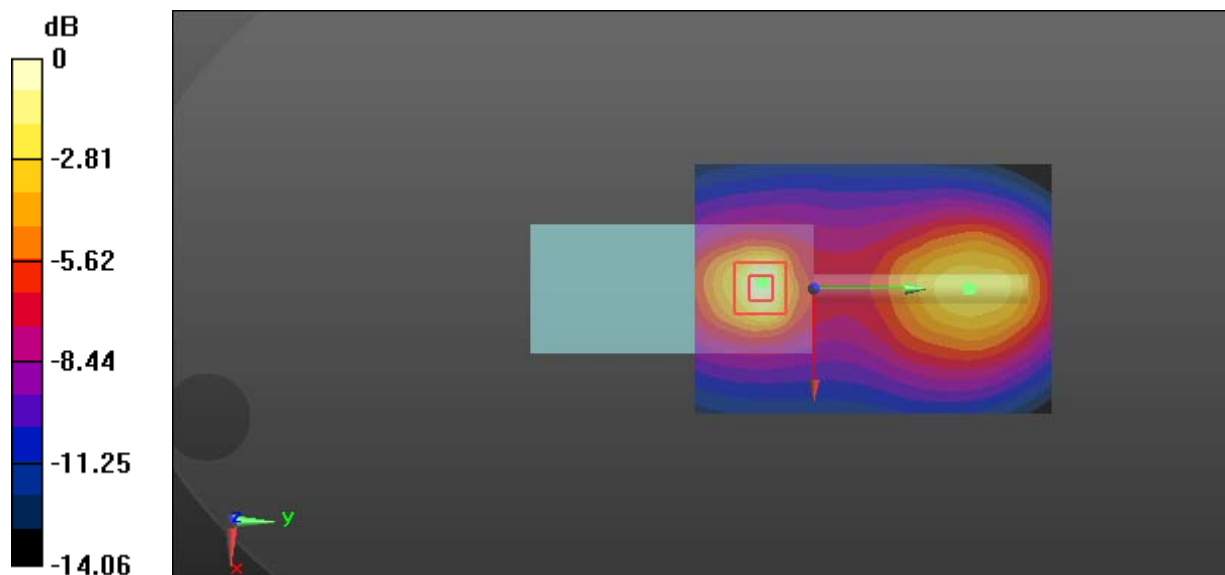

0 dB = 18.4 W/kg = 12.65 dBW/kg

Test Plot 18#: Antenna 2_PTT_FM 25kHz_Body Back_149 MHz**DUT: Digital Poratable Radio; Type: PD602i VHF; Serial: 18052401120**

Communication System: FM; Frequency: 149 MHz; Duty Cycle: 1:1

Medium parameters used: $f = 149$ MHz; $\sigma = 0.794$ S/m; $\epsilon_r = 63.516$; $\rho = 1000$ kg/m³

Phantom section: Flat Section

DASY5 Configuration:

- Probe: EX3DV4 - SN7329; ConvF(12.56, 12.56, 12.56); Calibrated: 2018/1/22;
- Sensor-Surface: 1.4mm (Mechanical Surface Detection)
- Electronics: DAE4 Sn1459; Calibrated: 2017/9/15
- Phantom: ELI v8.0; Type: QDOVA004AA; Serial: 2051
- Measurement SW: DASY52, Version 52.8 (8);

Area Scan (71x151x1): Interpolated grid: dx=1.500 mm, dy=1.500 mm

Maximum value of SAR (interpolated) = 10.4 W/kg

Zoom Scan (5x5x7)/Cube 0: Measurement grid: dx=8mm, dy=8mm, dz=5mm

Reference Value = 54.73 V/m; Power Drift = -0.02 dB

Peak SAR (extrapolated) = 29.4 W/kg

SAR(1 g) = 6.71 W/kg; SAR(10 g) = 3.11 W/kg

Maximum value of SAR (measured) = 15.0 W/kg

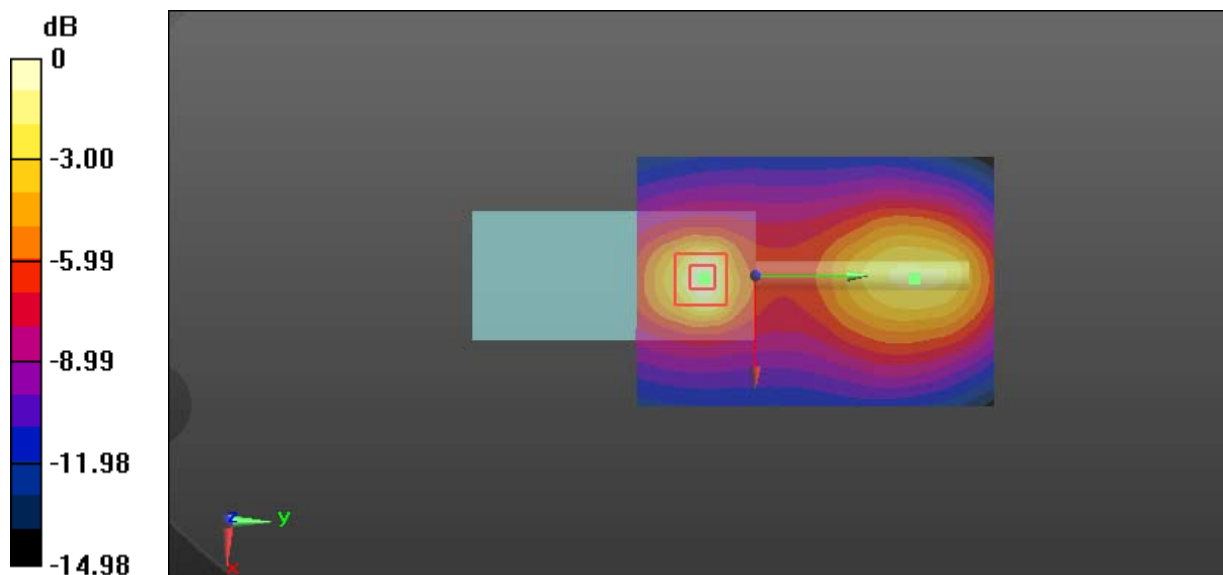

0 dB = 15.0 W/kg = 11.76 dBW/kg

Test Plot 19#: Antenna 2_PTT_FM 25kHz_Body Back_153.9875 MHz**DUT: Digital Portable Radio; Type: PD602i VHF; Serial: 18052401120**

Communication System: FM; Frequency: 153.988 MHz; Duty Cycle: 1:1

Medium parameters used: $f = 153.988$ MHz; $\sigma = 0.81$ S/m; $\epsilon_r = 63.454$; $\rho = 1000$ kg/m³

Phantom section: Flat Section

DASY5 Configuration:

- Probe: EX3DV4 - SN7329; ConvF(12.56, 12.56, 12.56); Calibrated: 2018/1/22;
- Sensor-Surface: 1.4mm (Mechanical Surface Detection)
- Electronics: DAE4 Sn1459; Calibrated: 2017/9/15
- Phantom: ELI v8.0; Type: QDOVA004AA; Serial: 2051
- Measurement SW: DASY52, Version 52.8 (8);

Area Scan (71x101x1): Interpolated grid: dx=1.500 mm, dy=1.500 mm

Maximum value of SAR (interpolated) = 8.69 W/kg

Zoom Scan (5x5x7)/Cube 0: Measurement grid: dx=8mm, dy=8mm, dz=5mm

Reference Value = 52.61 V/m; Power Drift = -0.12 dB

Peak SAR (extrapolated) = 20.5 W/kg

SAR(1 g) = 4.56 W/kg; SAR(10 g) = 2.15 W/kg

Maximum value of SAR (measured) = 10.1 W/kg

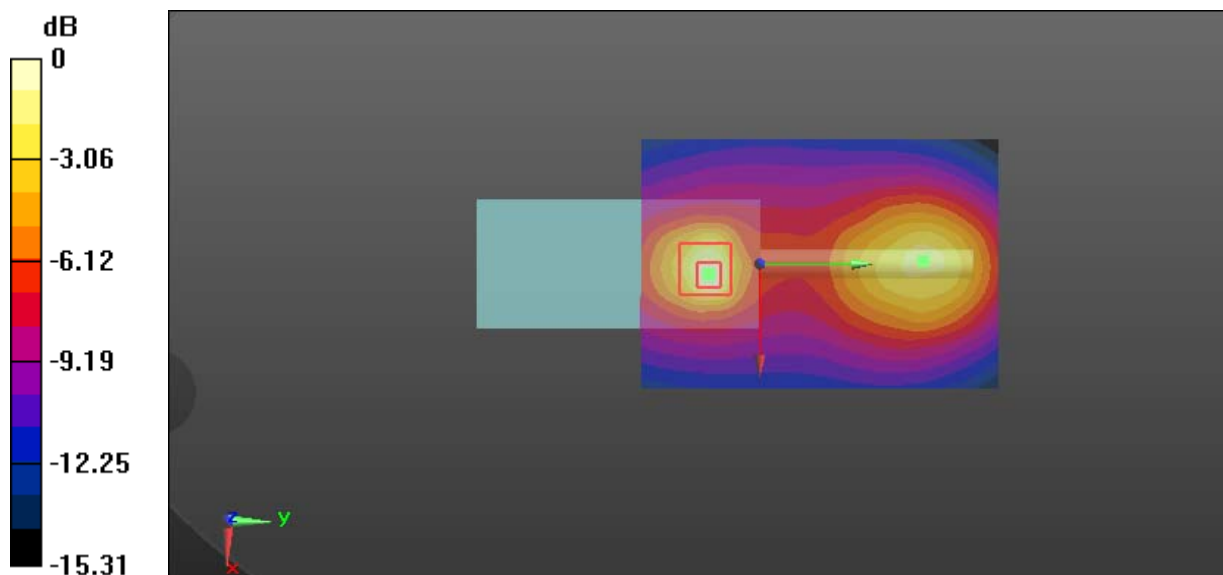

0 dB = 10.1 W/kg = 10.04 dBW/kg

Test Plot 20#: Antenna 2_PTT_4FSK 12.5kHz_Body Back_144.0125 MHz**DUT: Digital Poratable Radio; Type: PD602i VHF; Serial: 18052401120**

Communication System: 4FSK; Frequency: 144.012 MHz; Duty Cycle: 1:2

Medium parameters used: $f = 144.012$ MHz; $\sigma = 0.773$ S/m; $\epsilon_r = 64.304$; $\rho = 1000$ kg/m³

Phantom section: Flat Section

DASY5 Configuration:

- Probe: EX3DV4 - SN7329; ConvF(12.56, 12.56, 12.56); Calibrated: 2018/1/22;
- Sensor-Surface: 1.4mm (Mechanical Surface Detection)
- Electronics: DAE4 Sn1459; Calibrated: 2017/9/15
- Phantom: ELI v8.0; Type: QDOVA004AA; Serial: 2051
- Measurement SW: DASY52, Version 52.8 (8);

Area Scan (71x101x1): Interpolated grid: dx=1.500 mm, dy=1.500 mm

Maximum value of SAR (interpolated) = 8.78 W/kg

Zoom Scan (5x5x7)/Cube 0: Measurement grid: dx=8mm, dy=8mm, dz=5mm

Reference Value = 45.04 V/m; Power Drift = -0.17 dB

Peak SAR (extrapolated) = 19.4 W/kg

SAR(1 g) = 4.61 W/kg; SAR(10 g) = 2.18 W/kg

Maximum value of SAR (measured) = 10.5 W/kg

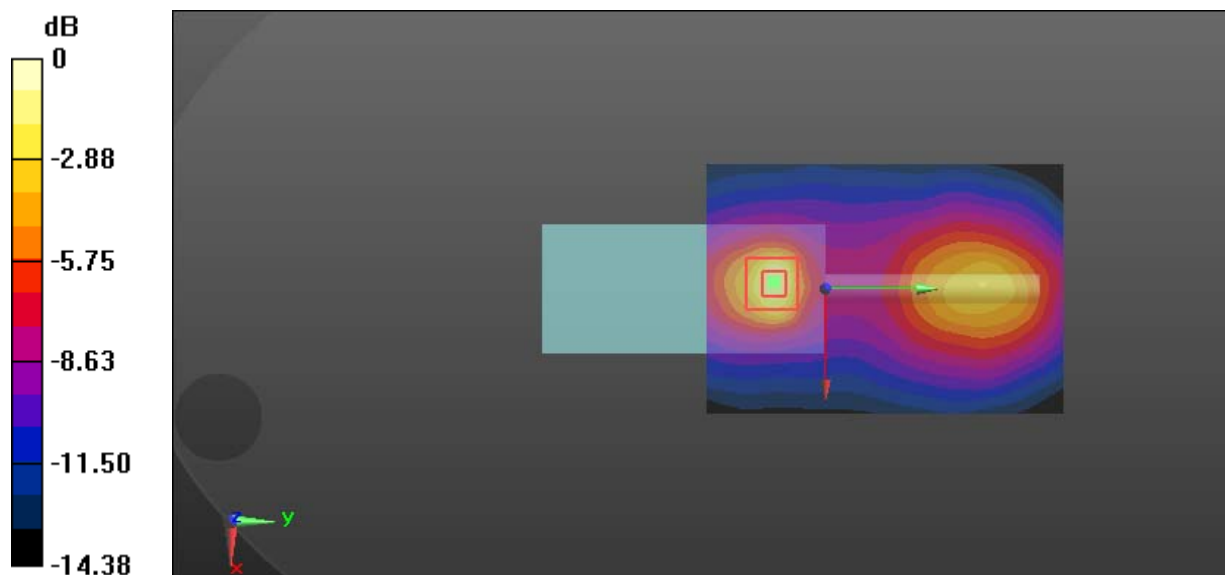

0 dB = 10.5 W/kg = 10.21 dBW/kg

Test Plot 21#: Antenna 3_PTT_FM 12.5kHz_Face Up_153.0125 MHz**DUT: Digital Portable Radio; Type: PD602i VHF; Serial: 18052401120**

Communication System: FM; Frequency: 153.012 MHz; Duty Cycle: 1:1

Medium parameters used: $f = 153.012$ MHz; $\sigma = 0.761$ S/m; $\epsilon_r = 53.492$; $\rho = 1000$ kg/m³

Phantom section: Flat Section

DASY5 Configuration:

- Probe: EX3DV4 - SN7329; ConvF(12.88, 12.88, 12.88); Calibrated: 2018/1/22;
- Sensor-Surface: 1.4mm (Mechanical Surface Detection)
- Electronics: DAE4 Sn1459; Calibrated: 2017/9/15
- Phantom: ELI v8.0; Type: QDOVA004AA; Serial: 2051
- Measurement SW: DASY52, Version 52.8 (8);

Area Scan (71x101x1): Interpolated grid: dx=1.500 mm, dy=1.500 mm

Maximum value of SAR (interpolated) = 1.26 W/kg

Zoom Scan (5x5x7)/Cube 0: Measurement grid: dx=8mm, dy=8mm, dz=5mm

Reference Value = 28.47 V/m; Power Drift = -0.12 dB

Peak SAR (extrapolated) = 1.80 W/kg

SAR(1 g) = 0.793 W/kg; SAR(10 g) = 0.556 W/kg

Maximum value of SAR (measured) = 1.23 W/kg

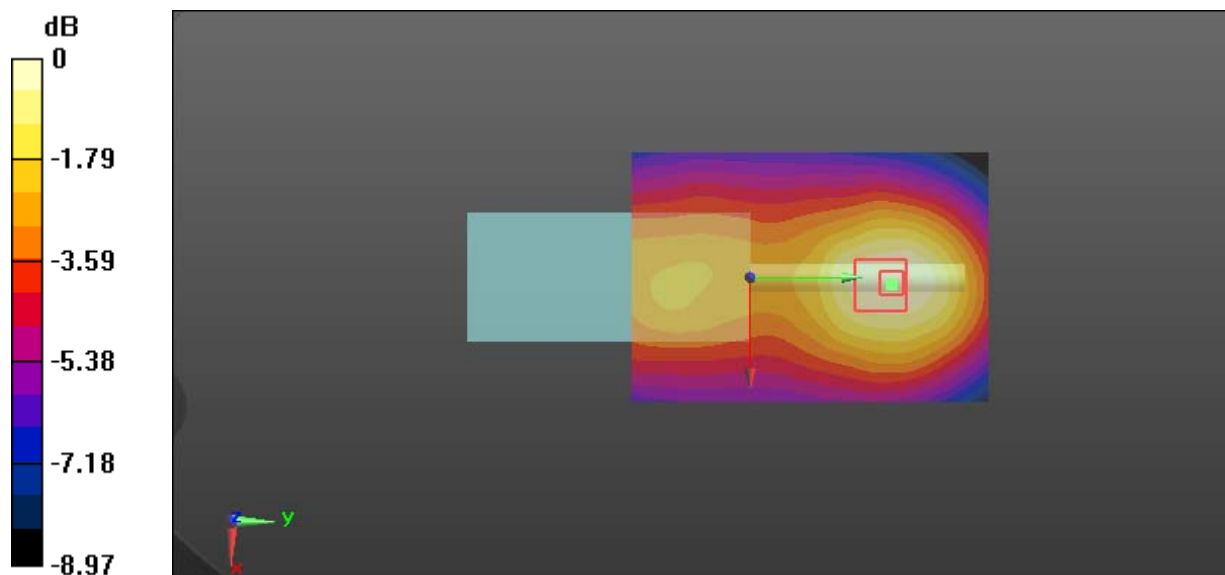

0 dB = 1.23 W/kg = 0.90 dBW/kg

Test Plot 22#: Antenna 3_PTT_FM 25kHz_Face Up_153.0125 MHz**DUT: Digital Portable Radio; Type: PD602i VHF; Serial: 18052401120**

Communication System: FM; Frequency: 153.012 MHz; Duty Cycle: 1:1

Medium parameters used: $f = 153.012$ MHz; $\sigma = 0.761$ S/m; $\epsilon_r = 53.492$; $\rho = 1000$ kg/m³

Phantom section: Flat Section

DASY5 Configuration:

- Probe: EX3DV4 - SN7329; ConvF(12.88, 12.88, 12.88); Calibrated: 2018/1/22;
- Sensor-Surface: 1.4mm (Mechanical Surface Detection)
- Electronics: DAE4 Sn1459; Calibrated: 2017/9/15
- Phantom: ELI v8.0; Type: QDOVA004AA; Serial: 2051
- Measurement SW: DASY52, Version 52.8 (8);

Area Scan (71x101x1): Interpolated grid: dx=1.500 mm, dy=1.500 mm

Maximum value of SAR (interpolated) = 1.43 W/kg

Zoom Scan (5x5x7)/Cube 0: Measurement grid: dx=8mm, dy=8mm, dz=5mm

Reference Value = 28.88 V/m; Power Drift = -0.03 dB

Peak SAR (extrapolated) = 2.12 W/kg

SAR(1 g) = 0.941 W/kg; SAR(10 g) = 0.655 W/kg

Maximum value of SAR (measured) = 1.46 W/kg

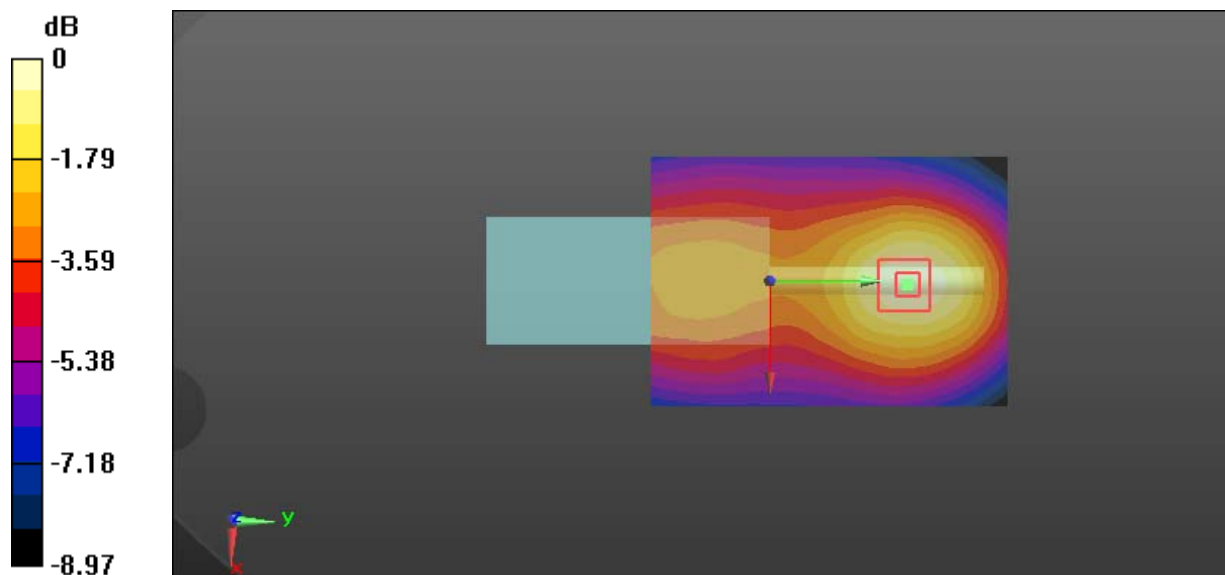

0 dB = 1.46 W/kg = 1.64 dBW/kg

Test Plot 23#: Antenna 3_PTT_4FSK 12.5kHz_Face Up_153.0125 MHz**DUT: Digital Portable Radio; Type: PD602i VHF; Serial: 18052401120**

Communication System: 4FSK; Frequency: 153.012 MHz; Duty Cycle: 1:2

Medium parameters used: $f = 153.012$ MHz; $\sigma = 0.761$ S/m; $\epsilon_r = 53.492$; $\rho = 1000$ kg/m³

Phantom section: Flat Section

DASY5 Configuration:

- Probe: EX3DV4 - SN7329; ConvF(12.88, 12.88, 12.88); Calibrated: 2018/1/22;
- Sensor-Surface: 1.4mm (Mechanical Surface Detection)
- Electronics: DAE4 Sn1459; Calibrated: 2017/9/15
- Phantom: ELI v8.0; Type: QDOVA004AA; Serial: 2051
- Measurement SW: DASY52, Version 52.8 (8);

Area Scan (71x101x1): Interpolated grid: dx=1.500 mm, dy=1.500 mm

Maximum value of SAR (interpolated) = 0.550 W/kg

Zoom Scan (5x5x7)/Cube 0: Measurement grid: dx=8mm, dy=8mm, dz=5mm

Reference Value = 18.46 V/m; Power Drift = -0.17 dB

Peak SAR (extrapolated) = 0.751 W/kg

SAR(1 g) = 0.334 W/kg; SAR(10 g) = 0.235 W/kg

Maximum value of SAR (measured) = 0.510 W/kg

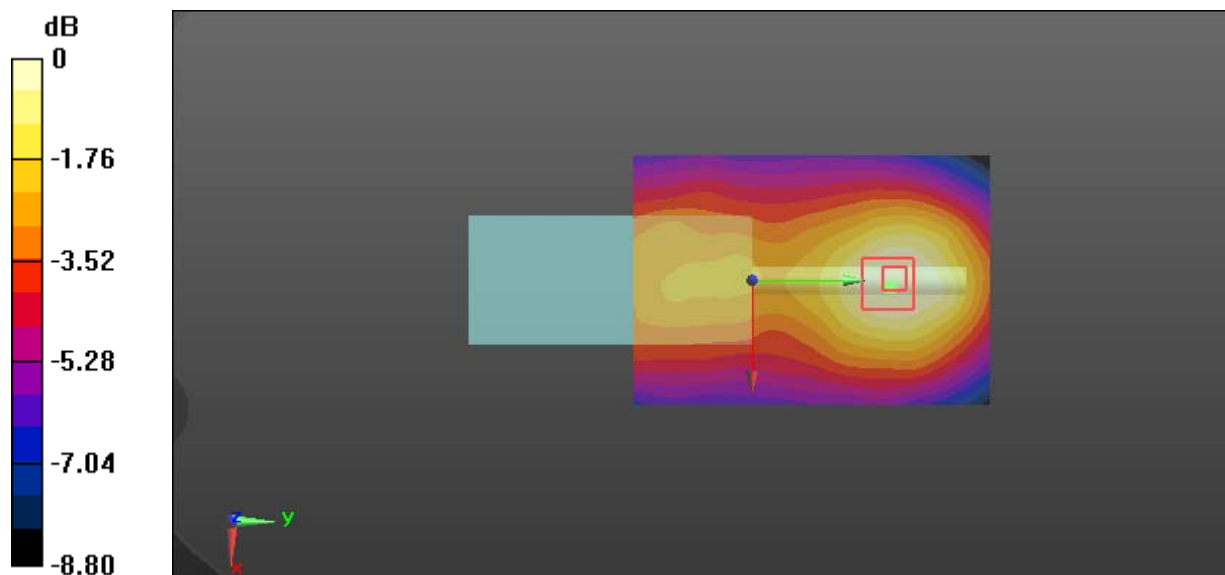

0 dB = 0.510 W/kg = -2.92 dBW/kg

Test Plot 24#: Antenna 3_PTT_FM 12.5kHz_ Body Back_153.0125 MHz**DUT: Digital Poratable Radio; Type: PD602i VHF; Serial: 18052401120**

Communication System: FM; Frequency: 153.012 MHz; Duty Cycle: 1:1

Medium parameters used: $f = 153.012$ MHz; $\sigma = 0.823$ S/m; $\epsilon_r = 62.528$; $\rho = 1000$ kg/m³

Phantom section: Flat Section

DASY5 Configuration:

- Probe: EX3DV4 - SN7329; ConvF(12.56, 12.56, 12.56); Calibrated: 2018/1/22;
- Sensor-Surface: 1.4mm (Mechanical Surface Detection)
- Electronics: DAE4 Sn1459; Calibrated: 2017/9/15
- Phantom: ELI v8.0; Type: QDOVA004AA; Serial: 2051
- Measurement SW: DASY52, Version 52.8 (8);

Area Scan (71x101x1): Interpolated grid: dx=1.500 mm, dy=1.500 mm

Maximum value of SAR (interpolated) = 21.4 W/kg

Zoom Scan (5x5x7)/Cube 0: Measurement grid: dx=8mm, dy=8mm, dz=5mm

Reference Value = 73.65 V/m; Power Drift = -0.04 dB

Peak SAR (extrapolated) = 33.3 W/kg

SAR(1 g) = 11 W/kg; SAR(10 g) = 6.48 W/kg

Maximum value of SAR (measured) = 19.5 W/kg

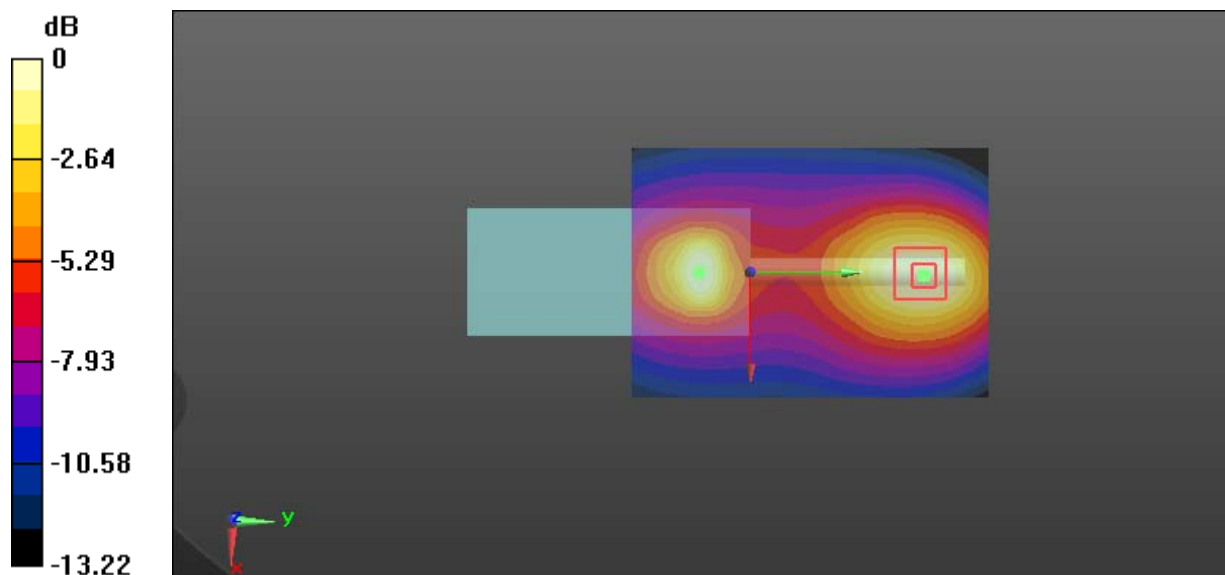

0 dB = 19.5 W/kg = 12.90 dBW/kg

Test Plot 25#: Antenna 3_PTT_FM 12.5kHz_ Body Back_158 MHz**DUT: Digital Portable Radio; Type: PD602i VHF; Serial: 18052401120**

Communication System: FM; Frequency: 158 MHz; Duty Cycle: 1:1

Medium parameters used: $f = 158$ MHz; $\sigma = 0.835$ S/m; $\epsilon_r = 52.253$; $\rho = 1000$ kg/m³

Phantom section: Flat Section

DASY5 Configuration:

- Probe: EX3DV4 - SN7329; ConvF(12.56, 12.56, 12.56); Calibrated: 2018/1/22;
- Sensor-Surface: 1.4mm (Mechanical Surface Detection)
- Electronics: DAE4 Sn1459; Calibrated: 2017/9/15
- Phantom: ELI v8.0; Type: QDOVA004AA; Serial: 2051
- Measurement SW: DASY52, Version 52.8 (8);

Area Scan (71x101x1): Interpolated grid: dx=1.500 mm, dy=1.500 mm

Maximum value of SAR (interpolated) = 16.4 W/kg

Zoom Scan (5x5x7)/Cube 0: Measurement grid: dx=8mm, dy=8mm, dz=5mm

Reference Value = 62.27 V/m; Power Drift = -0.16 dB

Peak SAR (extrapolated) = 27.1 W/kg

SAR(1 g) = 8.67 W/kg; SAR(10 g) = 5.03 W/kg

Maximum value of SAR (measured) = 15.2 W/kg

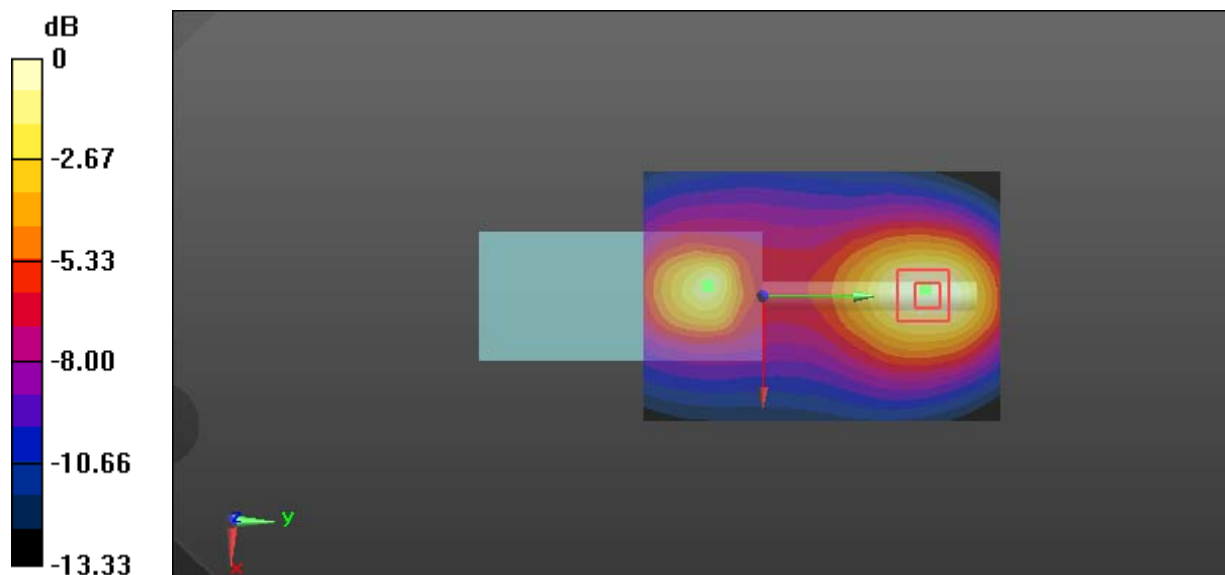

0 dB = 15.2 W/kg = 11.82 dBW/kg

Test Plot 26#: Antenna 3_PTT_FM 12.5kHz_ Body Back_163.9875 MHz**DUT: Digital Poratable Radio; Type: PD602i VHF; Serial: 18052401120**

Communication System: FM; Frequency: 163.988 MHz;Duty Cycle: 1:1

Medium parameters used: $f = 163.988$ MHz; $\sigma = 0.838$ S/m; $\epsilon_r = 62.215$; $\rho = 1000$ kg/m³

Phantom section: Flat Section

DASY5 Configuration:

- Probe: EX3DV4 - SN7329; ConvF(12.56, 12.56, 12.56); Calibrated: 2018/1/22;
- Sensor-Surface: 1.4mm (Mechanical Surface Detection)
- Electronics: DAE4 Sn1459; Calibrated: 2017/9/15
- Phantom: ELI v8.0; Type: QDOVA004AA; Serial: 2051
- Measurement SW: DASY52, Version 52.8 (8);

Area Scan (71x101x1): Interpolated grid: dx=1.500 mm, dy=1.500 mm

Maximum value of SAR (interpolated) = 9.50 W/kg

Zoom Scan (5x5x7)/Cube 0: Measurement grid: dx=8mm, dy=8mm, dz=5mm

Reference Value = 48.96 V/m; Power Drift = -0.10 dB

Peak SAR (extrapolated) = 15.6 W/kg

SAR(1 g) = 5.21 W/kg; SAR(10 g) = 3.11 W/kg

Maximum value of SAR (measured) = 9.03 W/kg

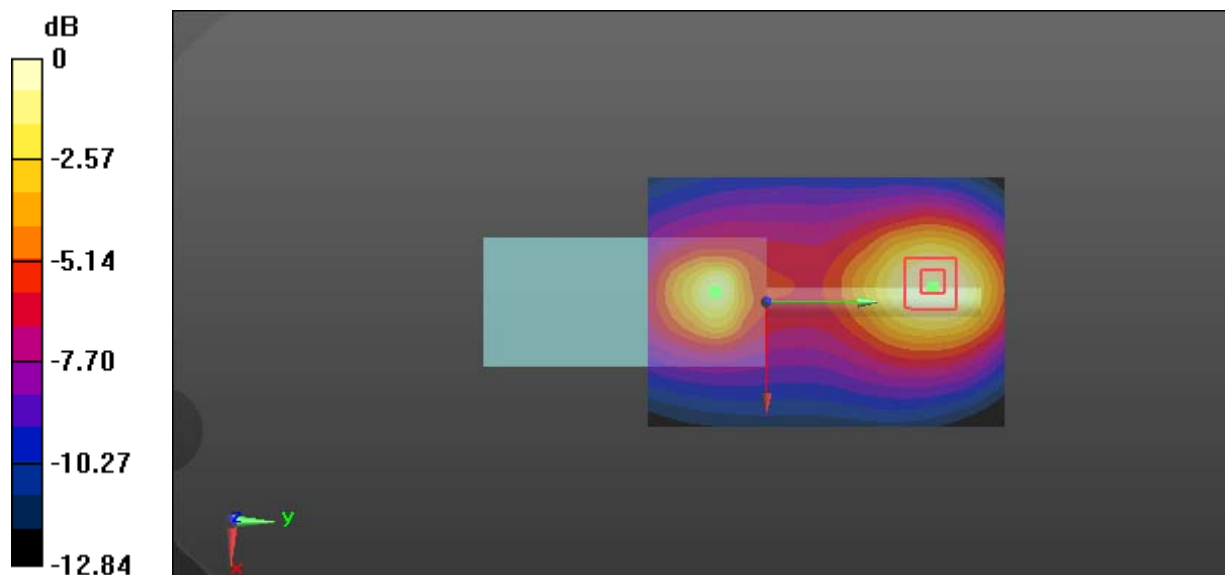

0 dB = 9.03 W/kg = 9.56 dBW/kg

Test Plot 27#: Antenna 3_PTT_FM 25kHz_ Body Back_153.0125 MHz**DUT: Digital Portable Radio; Type: PD602i VHF; Serial: 18052401120**

Communication System: FM; Frequency: 153.012 MHz; Duty Cycle: 1:1

Medium parameters used: $f = 153.012$ MHz; $\sigma = 0.823$ S/m; $\epsilon_r = 62.528$; $\rho = 1000$ kg/m³

Phantom section: Flat Section

DASY5 Configuration:

- Probe: EX3DV4 - SN7329; ConvF(12.56, 12.56, 12.56); Calibrated: 2018/1/22;
- Sensor-Surface: 1.4mm (Mechanical Surface Detection)
- Electronics: DAE4 Sn1459; Calibrated: 2017/9/15
- Phantom: ELI v8.0; Type: QDOVA004AA; Serial: 2051
- Measurement SW: DASY52, Version 52.8 (8);

Area Scan (71x101x1): Interpolated grid: dx=1.500 mm, dy=1.500 mm

Maximum value of SAR (interpolated) = 21.8 W/kg

Zoom Scan (5x5x7)/Cube 0: Measurement grid: dx=8mm, dy=8mm, dz=5mm

Reference Value = 69.91 V/m; Power Drift = -0.10 dB

Peak SAR (extrapolated) = 37.0 W/kg

SAR(1 g) = 11.5 W/kg; SAR(10 g) = 6.69 W/kg

Maximum value of SAR (measured) = 22.0 W/kg

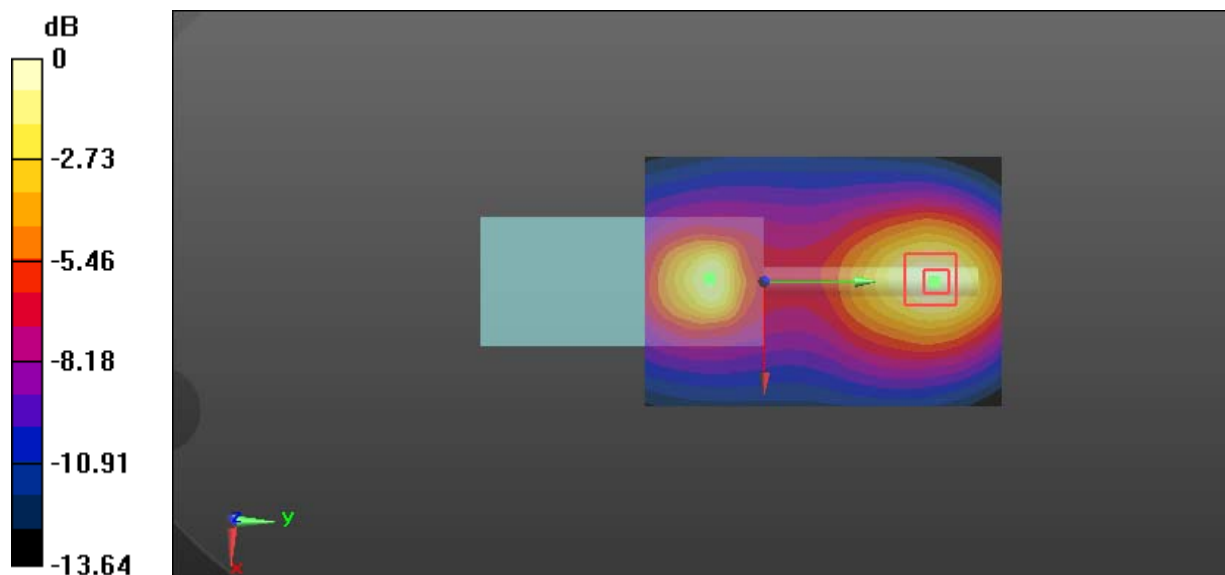

0 dB = 22.0 W/kg = 13.42 dBW/kg

Test Plot 28#: Antenna 3_PTT_FM 25kHz_ Body Back_158 MHz**DUT: Digital Portable Radio; Type: PD602i VHF; Serial: 18052401120**

Communication System: FM; Frequency: 158 MHz; Duty Cycle: 1:1

Medium parameters used: $f = 158 \text{ MHz}$; $\sigma = 0.835 \text{ S/m}$; $\epsilon_r = 52.253$; $\rho = 1000 \text{ kg/m}^3$

Phantom section: Flat Section

DASY5 Configuration:

- Probe: EX3DV4 - SN7329; ConvF(12.56, 12.56, 12.56); Calibrated: 2018/1/22;
- Sensor-Surface: 1.4mm (Mechanical Surface Detection)
- Electronics: DAE4 Sn1459; Calibrated: 2017/9/15
- Phantom: ELI v8.0; Type: QDOVA004AA; Serial: 2051
- Measurement SW: DASY52, Version 52.8 (8);

Area Scan (71x101x1): Interpolated grid: $dx=1.500 \text{ mm}$, $dy=1.500 \text{ mm}$

Maximum value of SAR (interpolated) = 16.0 W/kg

Zoom Scan (5x5x7)/Cube 0: Measurement grid: $dx=8\text{mm}$, $dy=8\text{mm}$, $dz=5\text{mm}$

Reference Value = 63.57 V/m; Power Drift = -0.14 dB

Peak SAR (extrapolated) = 28.1 W/kg

SAR(1 g) = 8.75 W/kg; SAR(10 g) = 5.10 W/kg

Maximum value of SAR (measured) = 16.6 W/kg

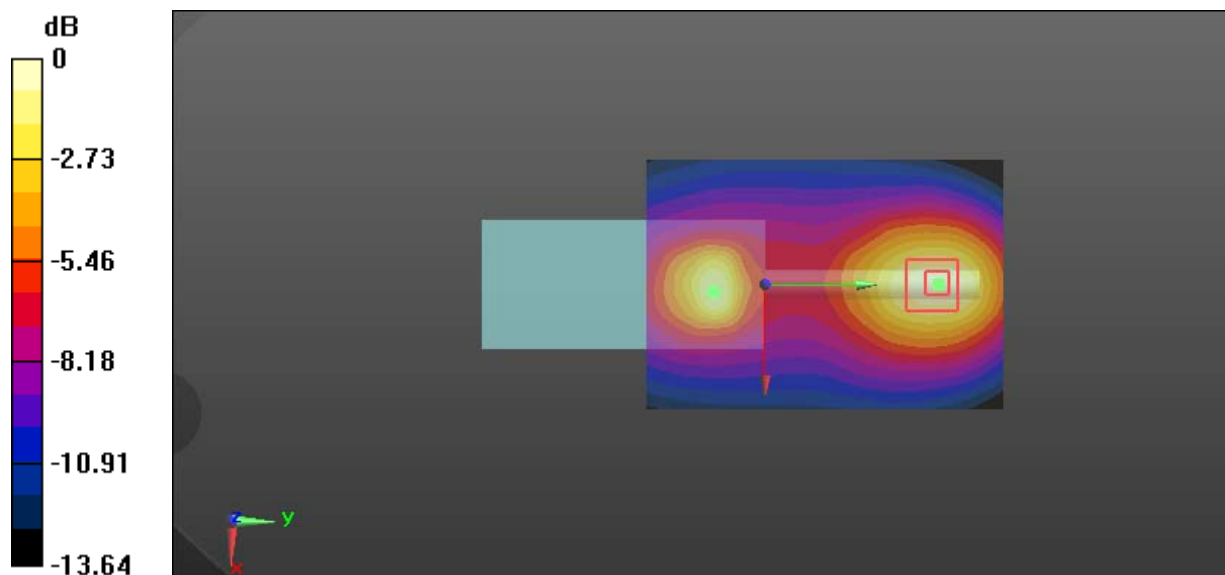

0 dB = 16.6 W/kg = 12.20 dBW/kg

Test Plot 29#: Antenna 3_PTT_FM 25kHz_ Body Back_163.9875 MHz**DUT: Digital Portable Radio; Type: PD602i VHF; Serial: 18052401120**

Communication System: FM; Frequency: 163.988 MHz; Duty Cycle: 1:1

Medium parameters used: $f = 163.988$ MHz; $\sigma = 0.838$ S/m; $\epsilon_r = 62.215$; $\rho = 1000$ kg/m³

Phantom section: Flat Section

DASY5 Configuration:

- Probe: EX3DV4 - SN7329; ConvF(12.56, 12.56, 12.56); Calibrated: 2018/1/22;
- Sensor-Surface: 1.4mm (Mechanical Surface Detection)
- Electronics: DAE4 Sn1459; Calibrated: 2017/9/15
- Phantom: ELI v8.0; Type: QDOVA004AA; Serial: 2051
- Measurement SW: DASY52, Version 52.8 (8);

Area Scan (71x101x1): Interpolated grid: dx=1.500 mm, dy=1.500 mm

Maximum value of SAR (interpolated) = 9.52 W/kg

Zoom Scan (5x5x7)/Cube 0: Measurement grid: dx=8mm, dy=8mm, dz=5mm

Reference Value = 51.68 V/m; Power Drift = -0.18 dB

Peak SAR (extrapolated) = 21.4 W/kg

SAR(1 g) = 5.29 W/kg; SAR(10 g) = 2.63 W/kg

Maximum value of SAR (measured) = 11.2 W/kg

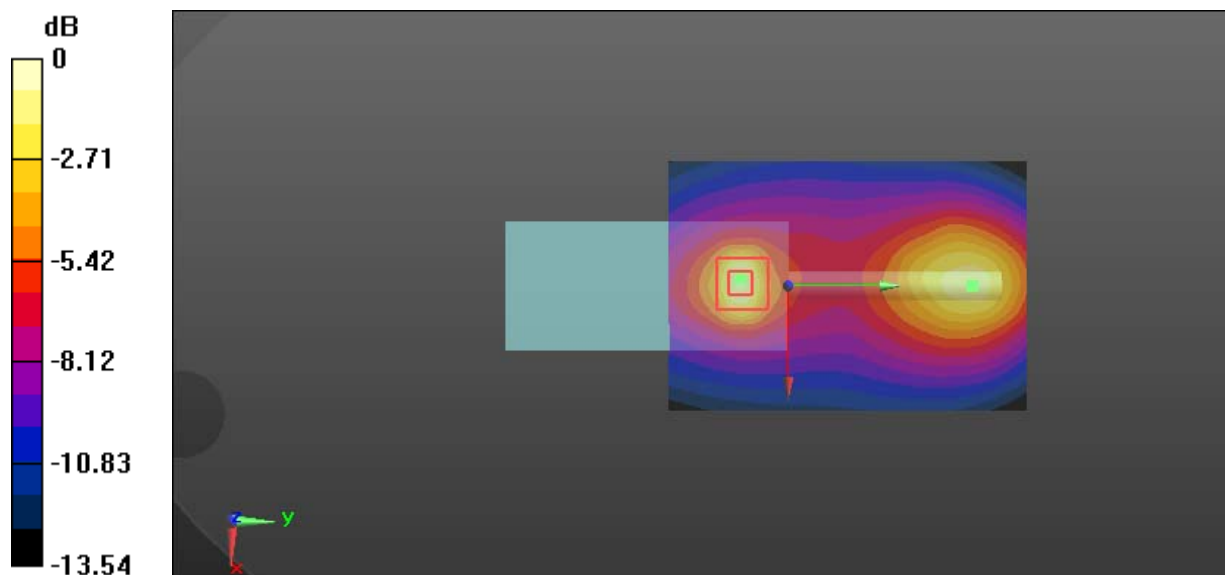

0 dB = 11.2 W/kg = 10.49 dBW/kg

Test Plot 30#: Antenna 3_PTT_4FSK 12.5kHz_ Body Back_153.0125 MHz**DUT: Digital Poratable Radio; Type: PD602i VHF; Serial: 18052401120**

Communication System: 4FSK; Frequency: 153.012 MHz; Duty Cycle: 1:2

Medium parameters used: $f = 153.012$ MHz; $\sigma = 0.823$ S/m; $\epsilon_r = 62.528$; $\rho = 1000$ kg/m³

Phantom section: Flat Section

DASY5 Configuration:

- Probe: EX3DV4 - SN7329; ConvF(12.56, 12.56, 12.56); Calibrated: 2018/1/22;
- Sensor-Surface: 1.4mm (Mechanical Surface Detection)
- Electronics: DAE4 Sn1459; Calibrated: 2017/9/15
- Phantom: ELI v8.0; Type: QDOVA004AA; Serial: 2051
- Measurement SW: DASY52, Version 52.8 (8);

Area Scan (71x101x1): Interpolated grid: dx=1.500 mm, dy=1.500 mm

Maximum value of SAR (interpolated) = 7.17 W/kg

Zoom Scan (5x5x7)/Cube 0: Measurement grid: dx=8mm, dy=8mm, dz=5mm

Reference Value = 41.91 V/m; Power Drift = 0.08 dB

Peak SAR (extrapolated) = 18.5 W/kg

SAR(1 g) = 4.56 W/kg; SAR(10 g) = 2.19 W/kg

Maximum value of SAR (measured) = 9.38 W/kg

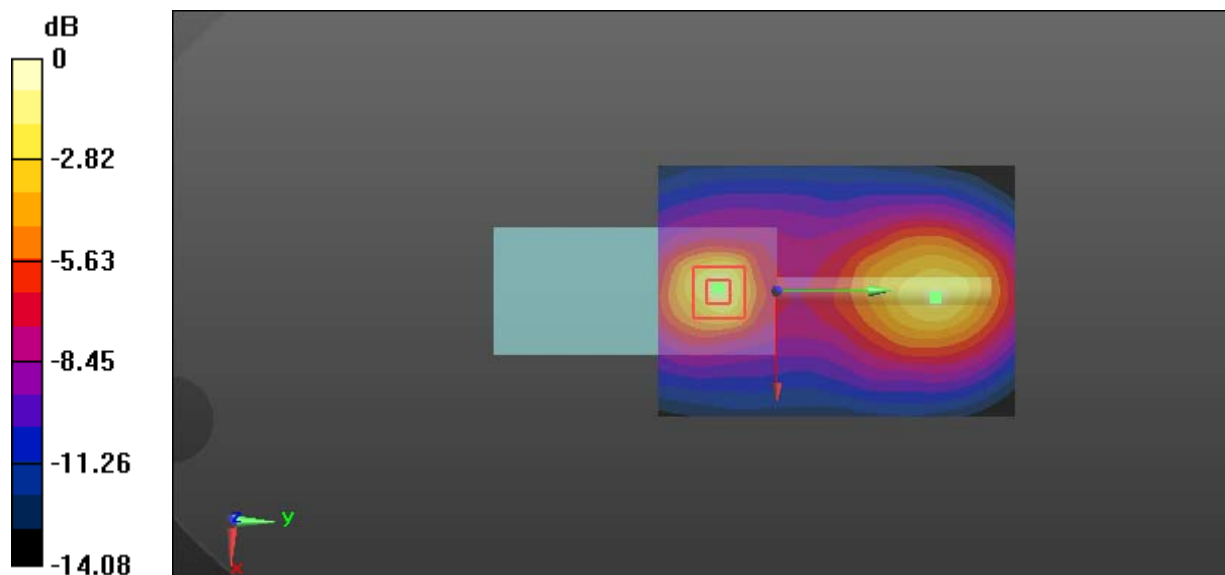

0 dB = 9.38 W/kg = 9.72 dBW/kg

Test Plot 31#: Antenna 4_PTT_FM 12.5kHz_Face Up_168 MHz**DUT: Digital Portable Radio; Type: PD602i VHF; Serial: 18052401120**

Communication System: FM; Frequency: 168 MHz; Duty Cycle: 1:1

Medium parameters used: $f = 168$ MHz; $\sigma = 0.785$ S/m; $\epsilon_r = 51.619$; $\rho = 1000$ kg/m³

Phantom section: Flat Section

DASY5 Configuration:

- Probe: EX3DV4 - SN7329; ConvF(12.88, 12.88, 12.88); Calibrated: 2018/1/22;
- Sensor-Surface: 1.4mm (Mechanical Surface Detection)
- Electronics: DAE4 Sn1459; Calibrated: 2017/9/15
- Phantom: ELI v8.0; Type: QDOVA004AA; Serial: 2051
- Measurement SW: DASY52, Version 52.8 (8);

Area Scan (71x101x1): Interpolated grid: dx=1.500 mm, dy=1.500 mm

Maximum value of SAR (interpolated) = 1.27 W/kg

Zoom Scan (5x5x7)/Cube 0: Measurement grid: dx=8mm, dy=8mm, dz=5mm

Reference Value = 29.65 V/m; Power Drift = 0.04 dB

Peak SAR (extrapolated) = 1.88 W/kg

SAR(1 g) = 0.872 W/kg; SAR(10 g) = 0.636 W/kg

Maximum value of SAR (measured) = 1.32 W/kg

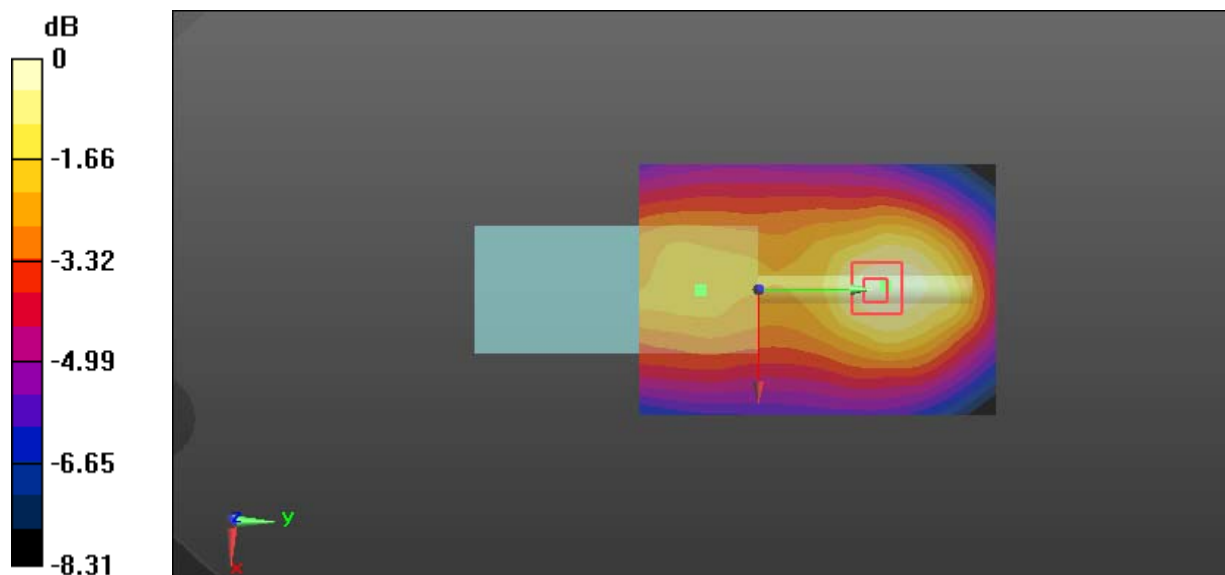

0 dB = 1.32 W/kg = 1.21 dBW/kg

Test Plot 32#: Antenna 4_PTT_FM 25kHz_ Face Up_168 MHz**DUT: Digital Poratable Radio; Type: PD602i VHF; Serial: 18052401120**

Communication System: FM; Frequency: 168 MHz; Duty Cycle: 1:1

Medium parameters used: $f = 168$ MHz; $\sigma = 0.785$ S/m; $\epsilon_r = 51.619$; $\rho = 1000$ kg/m³

Phantom section: Flat Section

DASY5 Configuration:

- Probe: EX3DV4 - SN7329; ConvF(12.88, 12.88, 12.88); Calibrated: 2018/1/22;
- Sensor-Surface: 1.4mm (Mechanical Surface Detection)
- Electronics: DAE4 Sn1459; Calibrated: 2017/9/15
- Phantom: ELI v8.0; Type: QDOVA004AA; Serial: 2051
- Measurement SW: DASY52, Version 52.8 (8);

Area Scan (71x101x1): Interpolated grid: dx=1.500 mm, dy=1.500 mm

Maximum value of SAR (interpolated) = 1.31 W/kg

Zoom Scan (5x5x7)/Cube 0: Measurement grid: dx=8mm, dy=8mm, dz=5mm

Reference Value = 30.07 V/m; Power Drift = 0.20 dB

Peak SAR (extrapolated) = 1.95 W/kg

SAR(1 g) = 0.924 W/kg; SAR(10 g) = 0.671 W/kg

Maximum value of SAR (measured) = 1.38 W/kg

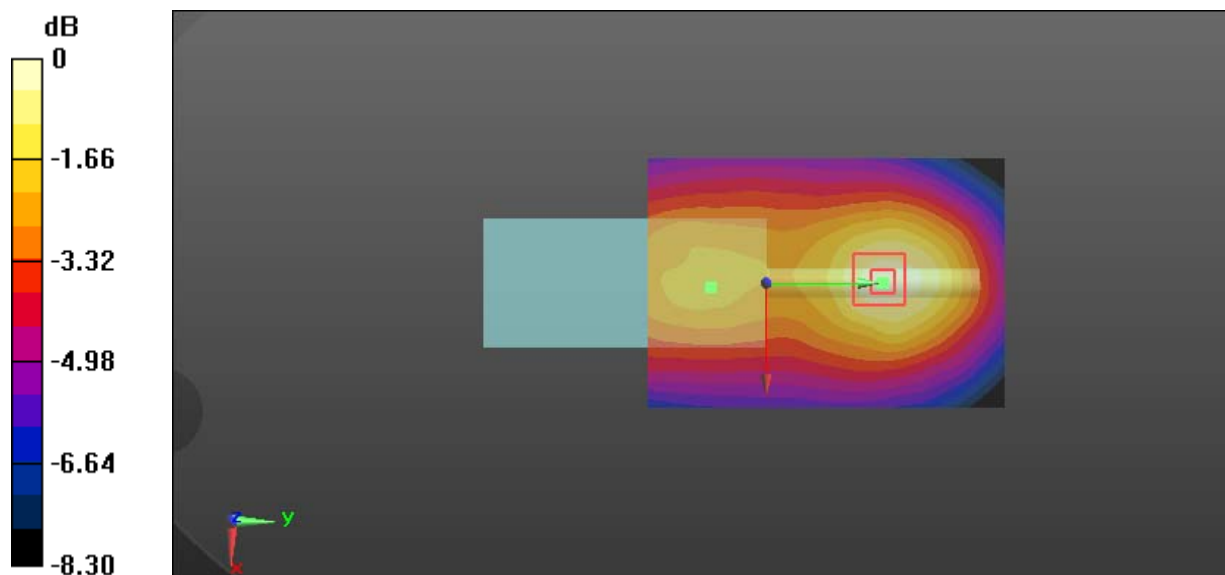

0 dB = 1.38 W/kg = 1.40 dBW/kg

Test Plot 33#: Antenna 4_PTT_4FSK 12.5kHz_ Face Up_168 MHz**DUT: Digital Portable Radio; Type: PD602i VHF; Serial: 18052401120**

Communication System: 4FSK; Frequency: 168 MHz; Duty Cycle: 1:2

Medium parameters used: $f = 168$ MHz; $\sigma = 0.785$ S/m; $\epsilon_r = 51.619$; $\rho = 1000$ kg/m³

Phantom section: Flat Section

DASY5 Configuration:

- Probe: EX3DV4 - SN7329; ConvF(12.88, 12.88, 12.88); Calibrated: 2018/1/22;
- Sensor-Surface: 1.4mm (Mechanical Surface Detection)
- Electronics: DAE4 Sn1459; Calibrated: 2017/9/15
- Phantom: ELI v8.0; Type: QDOVA004AA; Serial: 2051
- Measurement SW: DASY52, Version 52.8 (8);

Area Scan (71x101x1): Interpolated grid: dx=1.500 mm, dy=1.500 mm

Maximum value of SAR (interpolated) = 0.618 W/kg

Zoom Scan (5x5x7)/Cube 0: Measurement grid: dx=8mm, dy=8mm, dz=5mm

Reference Value = 21.12 V/m; Power Drift = -0.10 dB

Peak SAR (extrapolated) = 0.883 W/kg

SAR(1 g) = 0.417 W/kg; SAR(10 g) = 0.303 W/kg

Maximum value of SAR (measured) = 0.634 W/kg

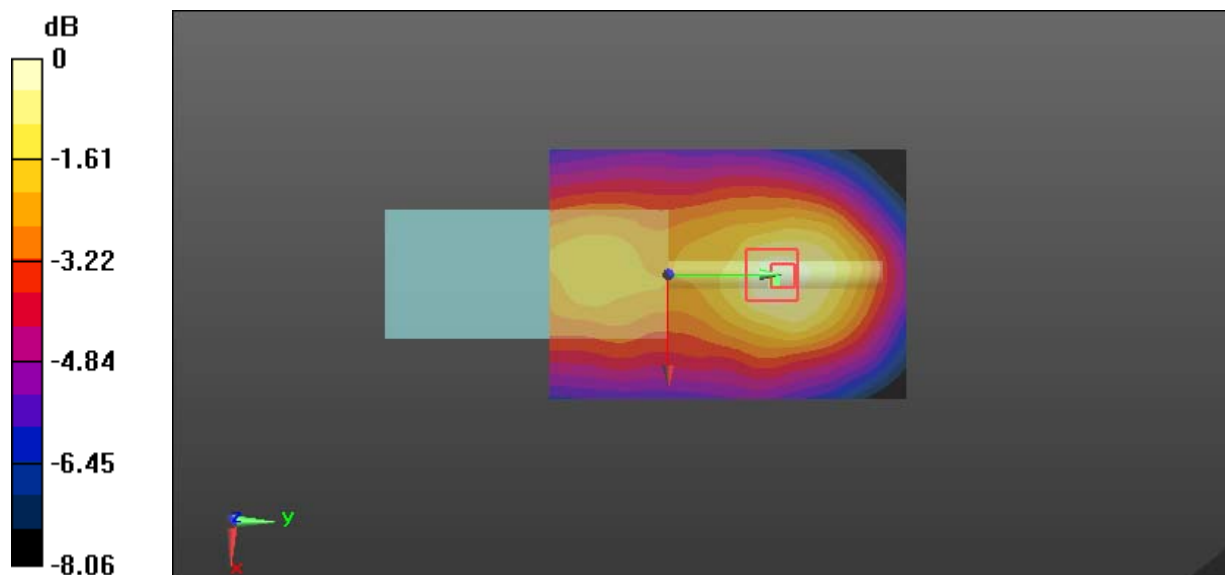

0 dB = 0.634 W/kg = -1.98 dBW/kg

Test Plot 34#: Antenna 4_PTT_FM 12.5kHz_Body Back_163.0125 MHz**DUT: Digital Poratable Radio; Type: PD602i VHF; Serial: 18052401120**

Communication System: FM; Frequency: 163.012 MHz; Duty Cycle: 1:1

Medium parameters used: $f = 163.012$ MHz; $\sigma = 0.83$ S/m; $\epsilon_r = 61.048$; $\rho = 1000$ kg/m³

Phantom section: Flat Section

DASY5 Configuration:

- Probe: EX3DV4 - SN7329; ConvF(12.56, 12.56, 12.56); Calibrated: 2018/1/22;
- Sensor-Surface: 1.4mm (Mechanical Surface Detection)
- Electronics: DAE4 Sn1459; Calibrated: 2017/9/15
- Phantom: ELI v8.0; Type: QDOVA004AA; Serial: 2051
- Measurement SW: DASY52, Version 52.8 (8);

Area Scan (71x101x1): Interpolated grid: dx=1.500 mm, dy=1.500 mm

Maximum value of SAR (interpolated) = 11.5 W/kg

Zoom Scan (5x5x7)/Cube 0: Measurement grid: dx=8mm, dy=8mm, dz=5mm

Reference Value = 59.67 V/m; Power Drift = -0.18 dB

Peak SAR (extrapolated) = 30.6 W/kg

SAR(1 g) = 7.42 W/kg; SAR(10 g) = 3.61 W/kg

Maximum value of SAR (measured) = 17.1 W/kg

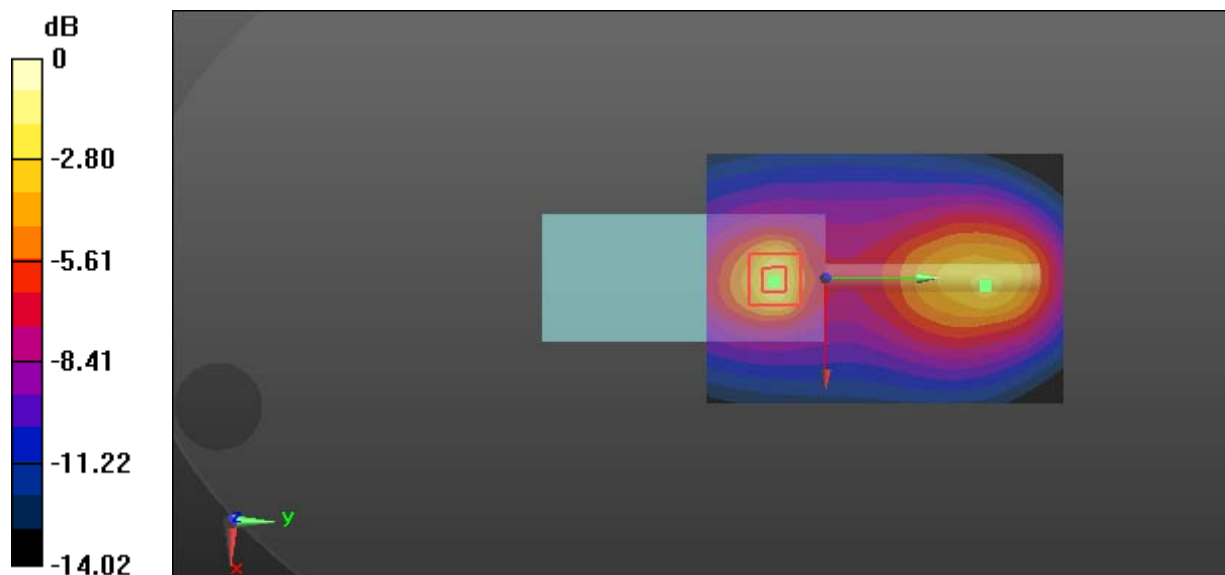

0 dB = 17.1 W/kg = 12.33 dBW/kg

Test Plot 35#: Antenna 4_PTT_FM 12.5kHz_Body Back_168 MHz**DUT: Digital Portable Radio; Type: PD602i VHF; Serial: 18052401120**

Communication System: FM; Frequency: 168 MHz; Duty Cycle: 1:1

Medium parameters used: $f = 168$ MHz; $\sigma = 0.839$ S/m; $\epsilon_r = 61.151$; $\rho = 1000$ kg/m³

Phantom section: Flat Section

DASY5 Configuration:

- Probe: EX3DV4 - SN7329; ConvF(12.56, 12.56, 12.56); Calibrated: 2018/1/22;
- Sensor-Surface: 1.4mm (Mechanical Surface Detection)
- Electronics: DAE4 Sn1459; Calibrated: 2017/9/15
- Phantom: ELI v8.0; Type: QDOVA004AA; Serial: 2051
- Measurement SW: DASY52, Version 52.8 (8);

Area Scan (71x101x1): Interpolated grid: dx=1.500 mm, dy=1.500 mm

Maximum value of SAR (interpolated) = 23.4 W/kg

Zoom Scan (5x5x7)/Cube 0: Measurement grid: dx=8mm, dy=8mm, dz=5mm

Reference Value = 80.96 V/m; Power Drift = -0.09 dB

Peak SAR (extrapolated) = 36.9 W/kg

SAR(1 g) = 10.9 W/kg; SAR(10 g) = 5.64 W/kg

Maximum value of SAR (measured) = 19.6 W/kg

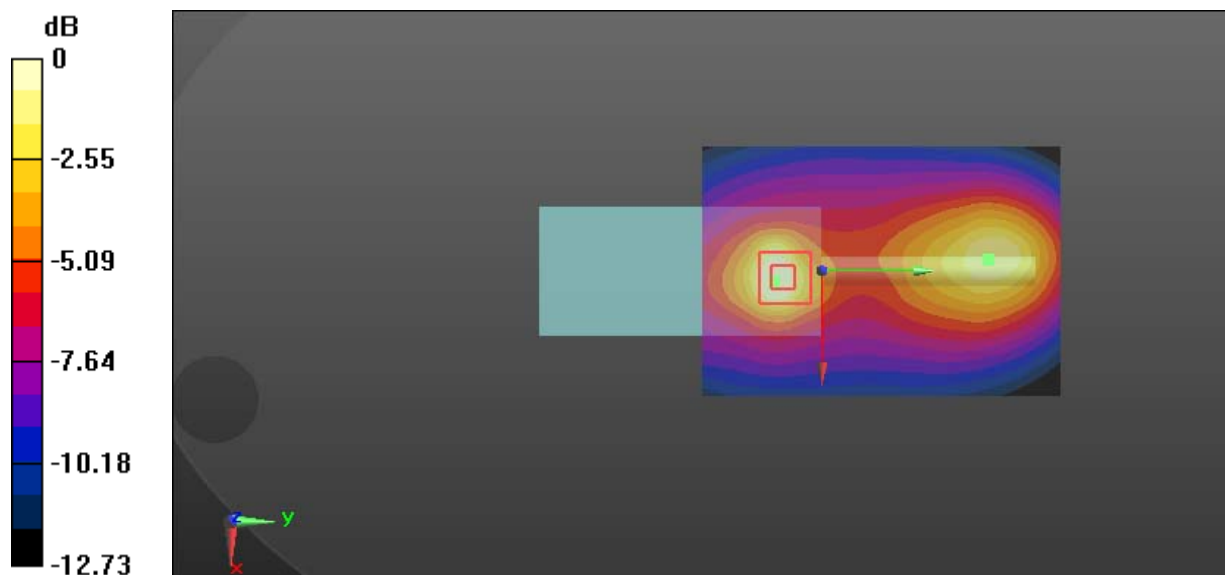

0 dB = 19.6 W/kg = 12.92 dBW/kg

Test Plot 36#: Antenna 4_PTT_FM 12.5kHz_Body Back_173.9875 MHz**DUT: Digital Portable Radio; Type: PD602i VHF; Serial: 18052401120**

Communication System: FM; Frequency: 173.988 MHz; Duty Cycle: 1:1

Medium parameters used: $f = 173.988$ MHz; $\sigma = 0.846$ S/m; $\epsilon_r = 61.29$; $\rho = 1000$ kg/m³

Phantom section: Flat Section

DASY5 Configuration:

- Probe: EX3DV4 - SN7329; ConvF(12.56, 12.56, 12.56); Calibrated: 2018/1/22;
- Sensor-Surface: 1.4mm (Mechanical Surface Detection)
- Electronics: DAE4 Sn1459; Calibrated: 2017/9/15
- Phantom: ELI v8.0; Type: QDOVA004AA; Serial: 2051
- Measurement SW: DASY52, Version 52.8 (8);

Area Scan (71x101x1): Interpolated grid: dx=1.500 mm, dy=1.500 mm

Maximum value of SAR (interpolated) = 11.9 W/kg

Zoom Scan (5x5x7)/Cube 0: Measurement grid: dx=8mm, dy=8mm, dz=5mm

Reference Value = 67.40 V/m; Power Drift = 0.20 dB

Peak SAR (extrapolated) = 30.2 W/kg

SAR(1 g) = 8.75 W/kg; SAR(10 g) = 4.57 W/kg

Maximum value of SAR (measured) = 18.6 W/kg

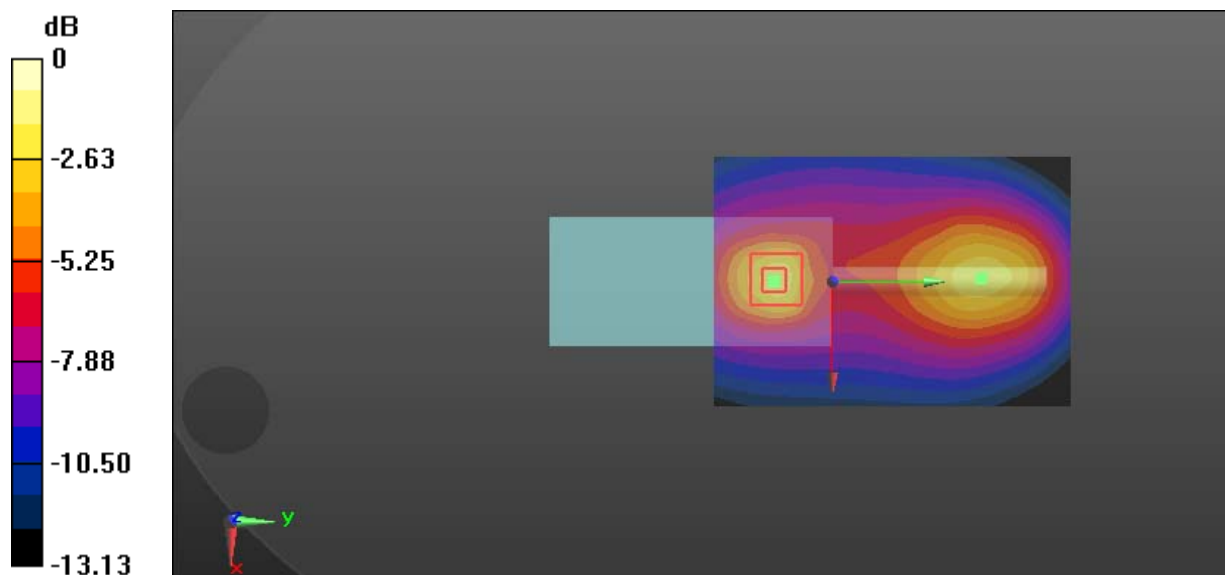

0 dB = 18.6 W/kg = 12.70 dBW/kg

Test Plot 37#: Antenna 4_PTT_FM 25kHz_ Body Back_163.0125 MHz**DUT: Digital Poratable Radio; Type: PD602i VHF; Serial: 18052401120**

Communication System: FM; Frequency: 163.012 MHz; Duty Cycle: 1:1

Medium parameters used: $f = 163.012$ MHz; $\sigma = 0.83$ S/m; $\epsilon_r = 61.048$; $\rho = 1000$ kg/m³

Phantom section: Flat Section

DASY5 Configuration:

- Probe: EX3DV4 - SN7329; ConvF(12.56, 12.56, 12.56); Calibrated: 2018/1/22;
- Sensor-Surface: 1.4mm (Mechanical Surface Detection)
- Electronics: DAE4 Sn1459; Calibrated: 2017/9/15
- Phantom: ELI v8.0; Type: QDOVA004AA; Serial: 2051
- Measurement SW: DASY52, Version 52.8 (8);

Area Scan (71x101x1): Interpolated grid: dx=1.500 mm, dy=1.500 mm

Maximum value of SAR (interpolated) = 13.4 W/kg

Zoom Scan (5x5x7)/Cube 0: Measurement grid: dx=8mm, dy=8mm, dz=5mm

Reference Value = 55.92 V/m; Power Drift = 0.14 dB

Peak SAR (extrapolated) = 27.6 W/kg

SAR(1 g) = 6.8 W/kg; SAR(10 g) = 3.41 W/kg

Maximum value of SAR (measured) = 13.8 W/kg

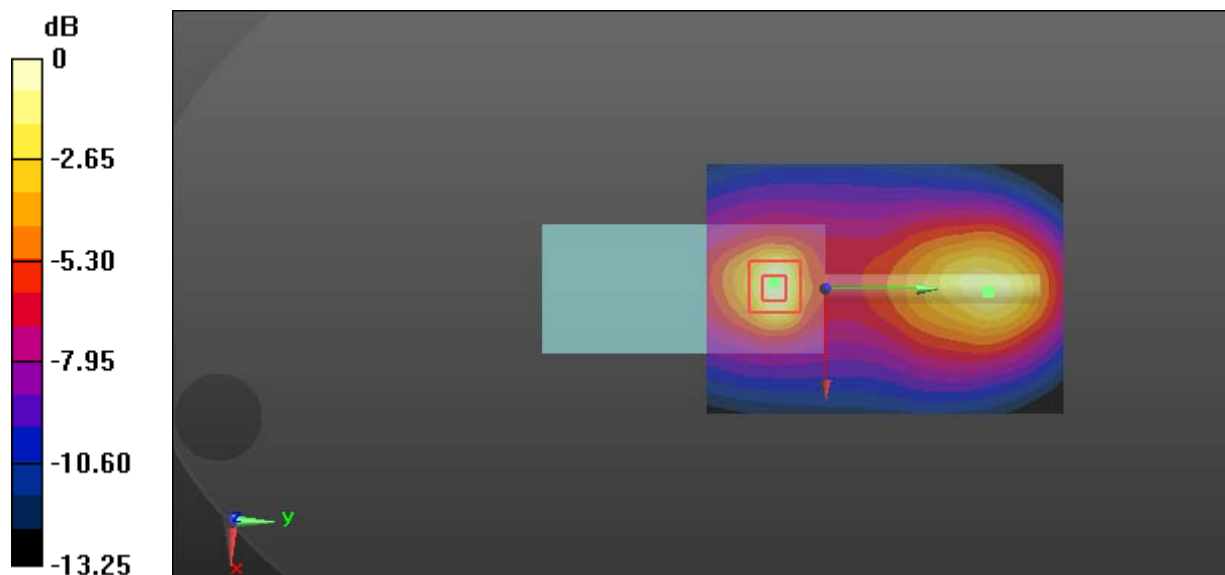

0 dB = 13.8 W/kg = 11.40 dBW/kg

Test Plot 38#: Antenna 4_PTT_FM 25kHz_ Body Back_168 MHz**DUT: Digital Portable Radio; Type: PD602i VHF; Serial: 18052401120**

Communication System: FM; Frequency: 168 MHz; Duty Cycle: 1:1

Medium parameters used: $f = 168$ MHz; $\sigma = 0.839$ S/m; $\epsilon_r = 61.151$; $\rho = 1000$ kg/m³

Phantom section: Flat Section

DASY5 Configuration:

- Probe: EX3DV4 - SN7329; ConvF(12.56, 12.56, 12.56); Calibrated: 2018/1/22;
- Sensor-Surface: 1.4mm (Mechanical Surface Detection)
- Electronics: DAE4 Sn1459; Calibrated: 2017/9/15
- Phantom: ELI v8.0; Type: QDOVA004AA; Serial: 2051
- Measurement SW: DASY52, Version 52.8 (8);

Area Scan (71x101x1): Interpolated grid: dx=1.500 mm, dy=1.500 mm

Maximum value of SAR (interpolated) = 16.7 W/kg

Zoom Scan (5x5x7)/Cube 0: Measurement grid: dx=8mm, dy=8mm, dz=5mm

Reference Value = 79.81 V/m; Power Drift = -0.14 dB

Peak SAR (extrapolated) = 34.7 W/kg

SAR(1 g) = 10.3 W/kg; SAR(10 g) = 5.6 W/kg

Maximum value of SAR (measured) = 20.0 W/kg

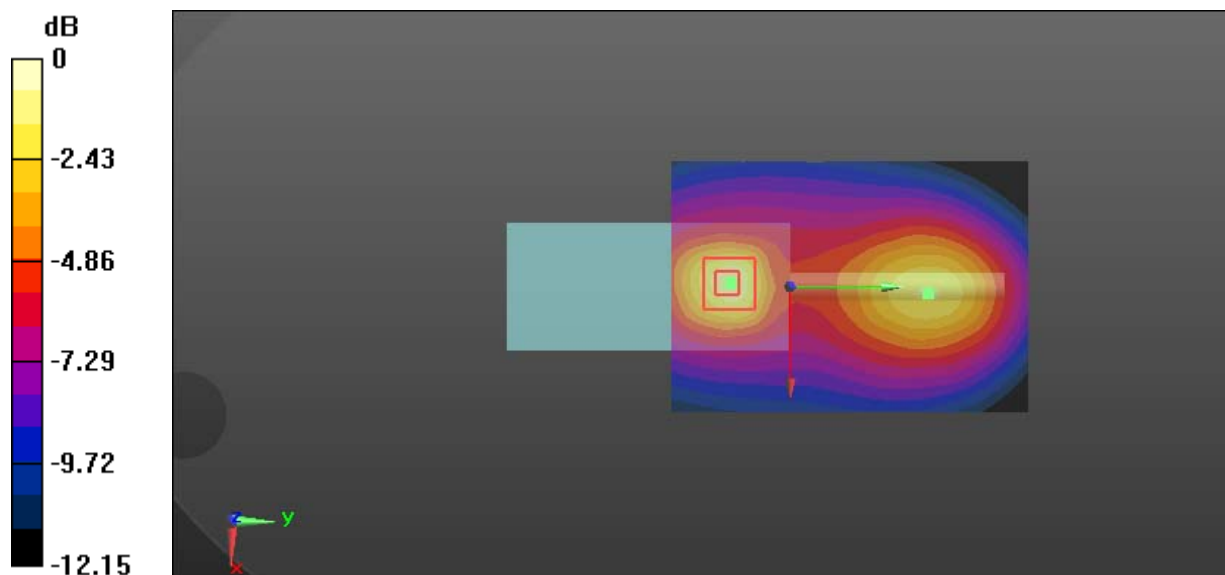

0 dB = 20.0 W/kg = 13.01 dBW/kg

Test Plot 39#: Antenna 4_PTT_FM 25kHz_ Body Back_173.9875 MHz**DUT: Digital Portable Radio; Type: PD602i VHF; Serial: 18052401120**

Communication System: FM; Frequency: 173.988 MHz; Duty Cycle: 1:1

Medium parameters used: $f = 173.988$ MHz; $\sigma = 0.846$ S/m; $\epsilon_r = 61.29$; $\rho = 1000$ kg/m³

Phantom section: Flat Section

DASY5 Configuration:

- Probe: EX3DV4 - SN7329; ConvF(12.56, 12.56, 12.56); Calibrated: 2018/1/22;
- Sensor-Surface: 1.4mm (Mechanical Surface Detection)
- Electronics: DAE4 Sn1459; Calibrated: 2017/9/15
- Phantom: ELI v8.0; Type: QDOVA004AA; Serial: 2051
- Measurement SW: DASY52, Version 52.8 (8);

Area Scan (71x101x1): Interpolated grid: dx=1.500 mm, dy=1.500 mm

Maximum value of SAR (interpolated) = 10.2 W/kg

Zoom Scan (5x5x7)/Cube 0: Measurement grid: dx=8mm, dy=8mm, dz=5mm

Reference Value = 62.91 V/m; Power Drift = 0.04 dB

Peak SAR (extrapolated) = 23.4 W/kg

SAR(1 g) = 7.52 W/kg; SAR(10 g) = 4.18 W/kg

Maximum value of SAR (measured) = 14.7 W/kg

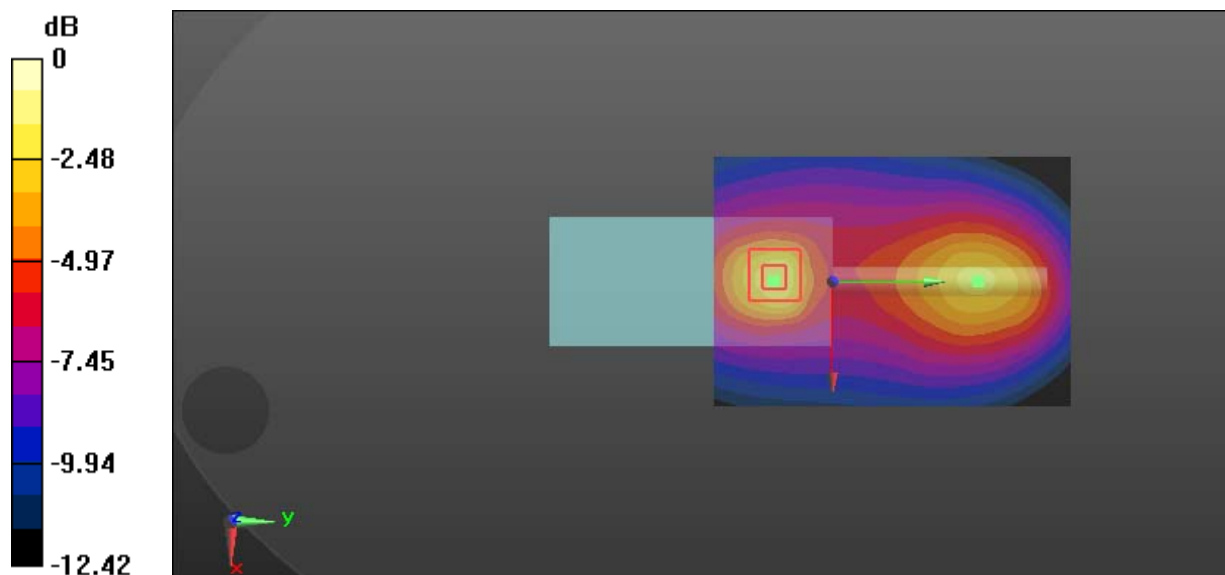

0 dB = 14.7 W/kg = 11.67 dBW/kg

Test Plot 40#: Antenna 4_PTT_ 4FSK 12.5kHz_ Body Back_168 MHz**DUT: Digital Poratable Radio; Type: PD602i VHF; Serial: 18052401120**

Communication System: 4FSK; Frequency: 168 MHz; Duty Cycle: 1:2

Medium parameters used: $f = 168$ MHz; $\sigma = 0.839$ S/m; $\epsilon_r = 61.151$; $\rho = 1000$ kg/m³

Phantom section: Flat Section

DASY5 Configuration:

- Probe: EX3DV4 - SN7329; ConvF(12.56, 12.56, 12.56); Calibrated: 2018/1/22;
- Sensor-Surface: 1.4mm (Mechanical Surface Detection)
- Electronics: DAE4 Sn1459; Calibrated: 2017/9/15
- Phantom: ELI v8.0; Type: QDOVA004AA; Serial: 2051
- Measurement SW: DASY52, Version 52.8 (8);

Area Scan (71x101x1): Interpolated grid: dx=1.500 mm, dy=1.500 mm

Maximum value of SAR (interpolated) = 10.6 W/kg

Zoom Scan (5x5x7)/Cube 0: Measurement grid: dx=8mm, dy=8mm, dz=5mm

Reference Value = 54.67 V/m; Power Drift = -0.12 dB

Peak SAR (extrapolated) = 28.0 W/kg

SAR(1 g) = 6.22 W/kg; SAR(10 g) = 2.98 W/kg

Maximum value of SAR (measured) = 13.6 W/kg

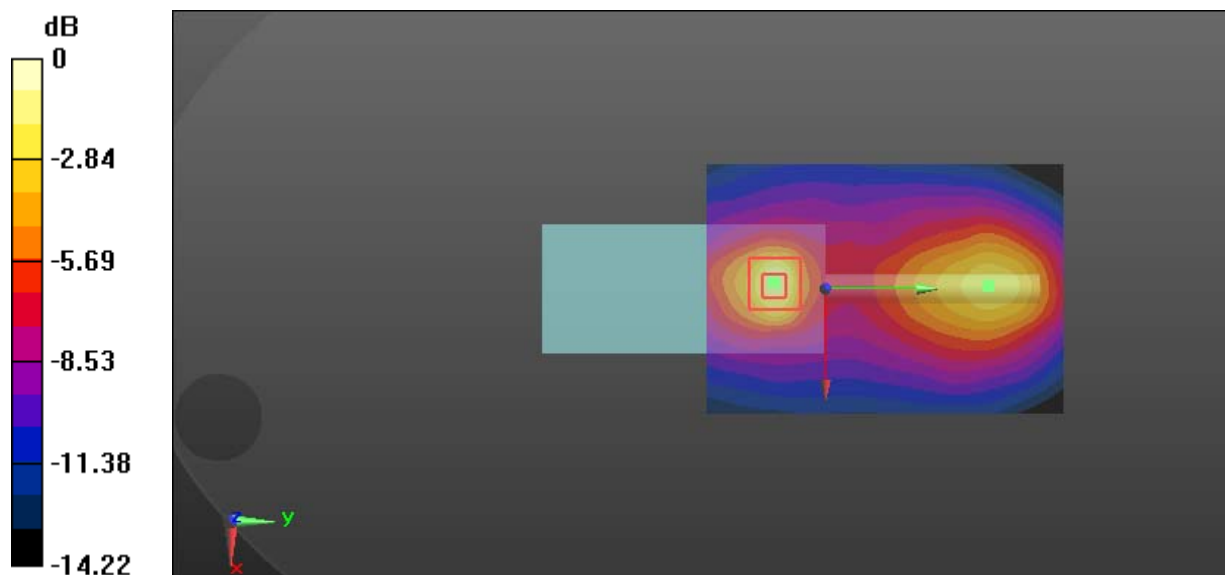

0 dB = 13.6 W/kg = 11.34 dBW/kg

Test Plot 41#: Antenna 5_PTT_FM 12.5kHz_Fack Up_163.9875 MHz**DUT: Digital Poratable Radio; Type: PD602i VHF; Serial: 18052401120**

Communication System: FM; Frequency: 163.988 MHz; Duty Cycle: 1:1

Medium parameters used: $f = 163.988$ MHz; $\sigma = 0.774$ S/m; $\epsilon_r = 51.889$; $\rho = 1000$ kg/m³

Phantom section: Flat Section

DASY5 Configuration:

- Probe: EX3DV4 - SN7329; ConvF(12.88, 12.88, 12.88); Calibrated: 2018/1/22;
- Sensor-Surface: 1.4mm (Mechanical Surface Detection)
- Electronics: DAE4 Sn1459; Calibrated: 2017/9/15
- Phantom: ELI v8.0; Type: QDOVA004AA; Serial: 2051
- Measurement SW: DASY52, Version 52.8 (8);

Area Scan (71x171x1): Interpolated grid: dx=1.500 mm, dy=1.500 mm

Maximum value of SAR (interpolated) = 1.47 W/kg

Zoom Scan (5x5x7)/Cube 0: Measurement grid: dx=8mm, dy=8mm, dz=5mm

Reference Value = 36.99 V/m; Power Drift = 0.02 dB

Peak SAR (extrapolated) = 1.69 W/kg

SAR(1 g) = 1.22 W/kg; SAR(10 g) = 0.967 W/kg

Maximum value of SAR (measured) = 1.50 W/kg

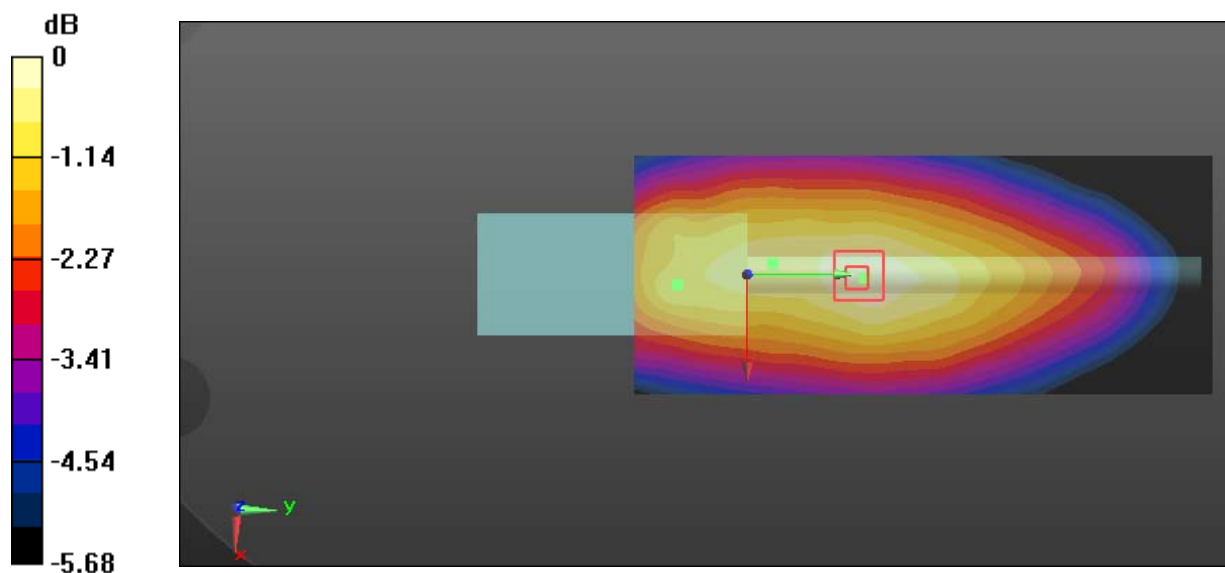

0 dB = 1.50 W/kg = 1.76 dBW/kg

Test Plot 42#: Antenna 5_PTT_FM 25kHz_ Fack Up_163.9875 MHz**DUT: Digital Poratable Radio; Type: PD602i VHF; Serial: 18052401120**

Communication System: FM; Frequency: 163.988 MHz; Duty Cycle: 1:1

Medium parameters used: $f = 163.988$ MHz; $\sigma = 0.774$ S/m; $\epsilon_r = 51.889$; $\rho = 1000$ kg/m³

Phantom section: Flat Section

DASY5 Configuration:

- Probe: EX3DV4 - SN7329; ConvF(12.88, 12.88, 12.88); Calibrated: 2018/1/22;
- Sensor-Surface: 1.4mm (Mechanical Surface Detection)
- Electronics: DAE4 Sn1459; Calibrated: 2017/9/15
- Phantom: ELI v8.0; Type: QDOVA004AA; Serial: 2051
- Measurement SW: DASY52, Version 52.8 (8);

Area Scan (71x171x1): Interpolated grid: dx=1.500 mm, dy=1.500 mm

Maximum value of SAR (interpolated) = 1.12 W/kg

Zoom Scan (5x5x7)/Cube 0: Measurement grid: dx=8mm, dy=8mm, dz=5mm

Reference Value = 35.46 V/m; Power Drift = -0.04 dB

Peak SAR (extrapolated) = 1.52 W/kg

SAR(1 g) = 0.898 W/kg; SAR(10 g) = 0.712 W/kg

Maximum value of SAR (measured) = 1.19 W/kg

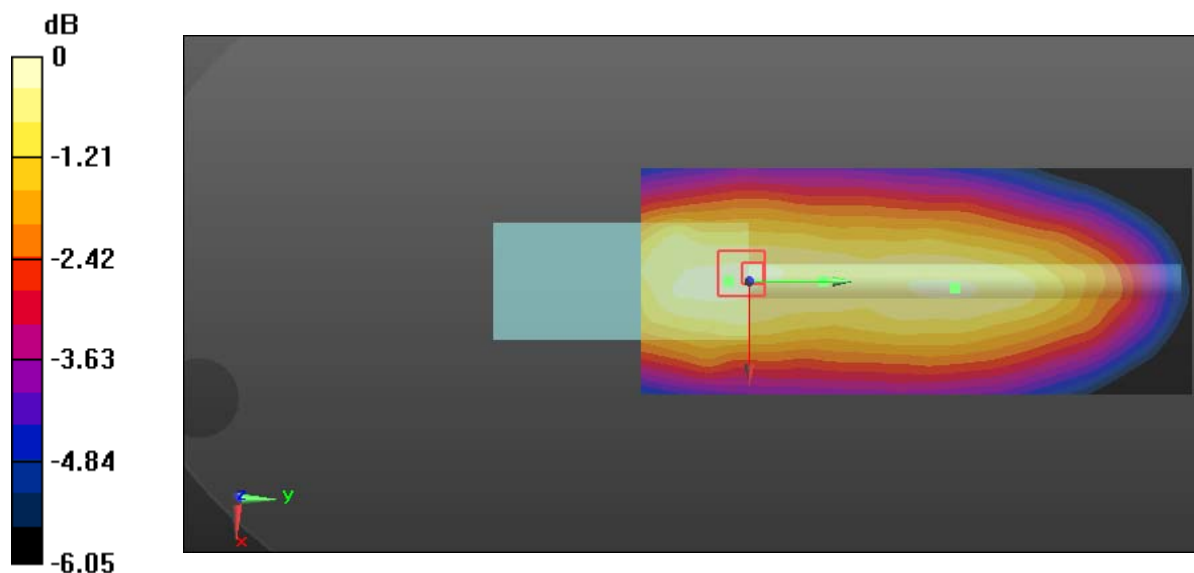

0 dB = 1.19 W/kg = 0.76 dBW/kg

Test Plot 43#: Antenna 5_PTT_4FSK 12.5kHz_Fack Up_163.9875 MHz**DUT: Digital Poratable Radio; Type: PD602i VHF; Serial: 18052401120**

Communication System: 4FSK; Frequency: 163.988 MHz; Duty Cycle: 1:2

Medium parameters used: $f = 163.988$ MHz; $\sigma = 0.774$ S/m; $\epsilon_r = 51.889$; $\rho = 1000$ kg/m³

Phantom section: Flat Section

DASY5 Configuration:

- Probe: EX3DV4 - SN7329; ConvF(12.88, 12.88, 12.88); Calibrated: 2018/1/22;
- Sensor-Surface: 1.4mm (Mechanical Surface Detection)
- Electronics: DAE4 Sn1459; Calibrated: 2017/9/15
- Phantom: ELI v8.0; Type: QDOVA004AA; Serial: 2051
- Measurement SW: DASY52, Version 52.8 (8);

Area Scan (71x171x1): Interpolated grid: dx=1.500 mm, dy=1.500 mm

Maximum value of SAR (interpolated) = 0.680 W/kg

Zoom Scan (5x5x7)/Cube 0: Measurement grid: dx=8mm, dy=8mm, dz=5mm

Reference Value = 25.28 V/m; Power Drift = -0.18 dB

Peak SAR (extrapolated) = 0.903 W/kg

SAR(1 g) = 0.593 W/kg; SAR(10 g) = 0.470 W/kg

Maximum value of SAR (measured) = 0.759 W/kg

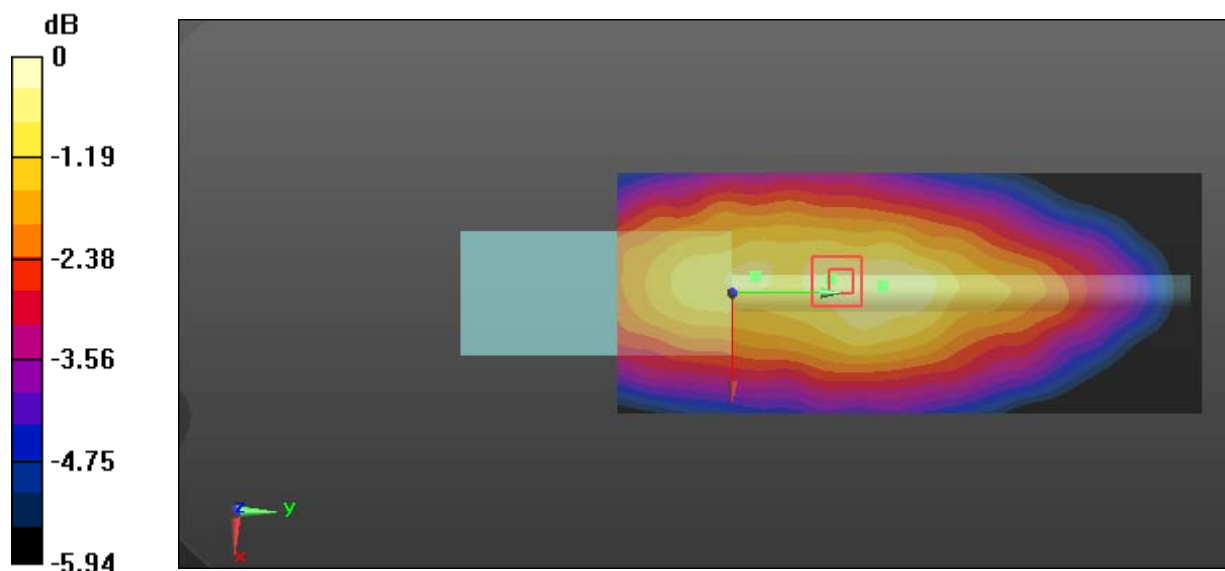

0 dB = 0.759 W/kg = -1.20 dBW/kg

Test Plot 44#: Antenna 5_PTT_FM 12.5kHz_Body Back_163.9875 MHz**DUT: Digital Portable Radio; Type: PD602i VHF; Serial: 18052401120**

Communication System: FM; Frequency: 163.988 MHz; Duty Cycle: 1:1

Medium parameters used: $f = 163.988$ MHz; $\sigma = 0.838$ S/m; $\epsilon_r = 62.215$; $\rho = 1000$ kg/m³

Phantom section: Flat Section

DASY5 Configuration:

- Probe: EX3DV4 - SN7329; ConvF(12.56, 12.56, 12.56); Calibrated: 2018/1/22;
- Sensor-Surface: 1.4mm (Mechanical Surface Detection)
- Electronics: DAE4 Sn1459; Calibrated: 2017/9/15
- Phantom: ELI v8.0; Type: QDOVA004AA; Serial: 2051
- Measurement SW: DASY52, Version 52.8 (8);

Area Scan (71x171x1): Interpolated grid: dx=1.500 mm, dy=1.500 mm

Maximum value of SAR (interpolated) = 6.49 W/kg

Zoom Scan (5x5x7)/Cube 0: Measurement grid: dx=8mm, dy=8mm, dz=5mm

Reference Value = 51.28 V/m; Power Drift = -0.13 dB

Peak SAR (extrapolated) = 16.6 W/kg

SAR(1 g) = 4.49 W/kg; SAR(10 g) = 2.3 W/kg

Maximum value of SAR (measured) = 9.56 W/kg

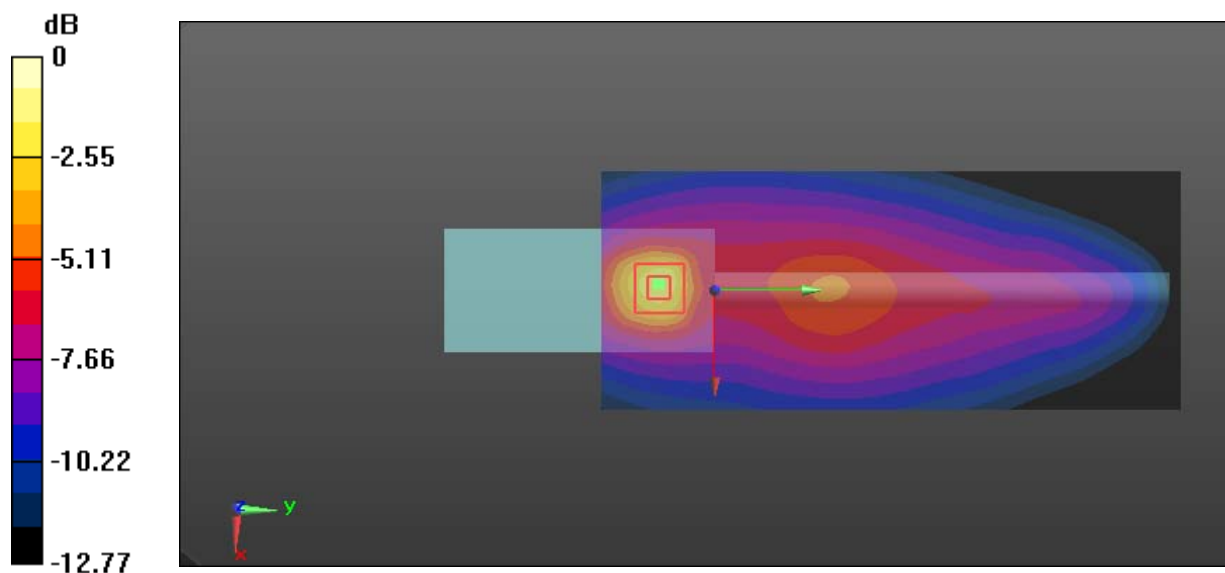

0 dB = 9.56 W/kg = 9.80 dBW/kg

Test Plot 45#: Antenna 5_PTT_FM 25kHz_ Body Back_163.9875 MHz**DUT: Digital Poratable Radio; Type: PD602i VHF; Serial: 18052401120**

Communication System: FM; Frequency: 163.988 MHz; Duty Cycle: 1:1

Medium parameters used: $f = 163.988$ MHz; $\sigma = 0.838$ S/m; $\epsilon_r = 62.215$; $\rho = 1000$ kg/m³

Phantom section: Flat Section

DASY5 Configuration:

- Probe: EX3DV4 - SN7329; ConvF(12.56, 12.56, 12.56); Calibrated: 2018/1/22;
- Sensor-Surface: 1.4mm (Mechanical Surface Detection)
- Electronics: DAE4 Sn1459; Calibrated: 2017/9/15
- Phantom: ELI v8.0; Type: QDOVA004AA; Serial: 2051
- Measurement SW: DASY52, Version 52.8 (8);

Area Scan (71x171x1): Interpolated grid: dx=1.500 mm, dy=1.500 mm

Maximum value of SAR (interpolated) = 9.41 W/kg

Zoom Scan (5x5x7)/Cube 0: Measurement grid: dx=8mm, dy=8mm, dz=5mm

Reference Value = 44.89 V/m; Power Drift = -0.12 dB

Peak SAR (extrapolated) = 24.5 W/kg

SAR(1 g) = 5 W/kg; SAR(10 g) = 2.33 W/kg

Maximum value of SAR (measured) = 11.6 W/kg

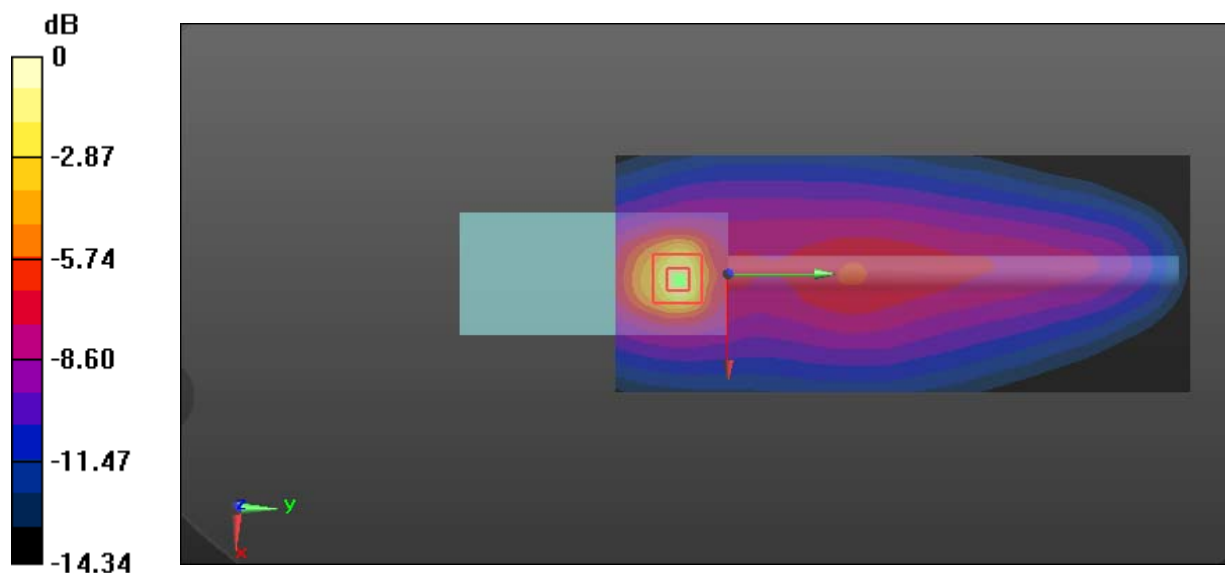

0 dB = 11.6 W/kg = 10.64 dBW/kg

Test Plot 46#: Antenna 5_PTT_4FSK 12.5kHz_ Body Back_163.9875 MHz**DUT: Digital Portable Radio; Type: PD602i VHF; Serial: 18052401120**

Communication System: 4FSK; Frequency: 163.988 MHz; Duty Cycle: 1:2

Medium parameters used: $f = 163.988$ MHz; $\sigma = 0.838$ S/m; $\epsilon_r = 62.215$; $\rho = 1000$ kg/m³

Phantom section: Flat Section

DASY5 Configuration:

- Probe: EX3DV4 - SN7329; ConvF(12.56, 12.56, 12.56); Calibrated: 2018/1/22;
- Sensor-Surface: 1.4mm (Mechanical Surface Detection)
- Electronics: DAE4 Sn1459; Calibrated: 2017/9/15
- Phantom: ELI v8.0; Type: QDOVA004AA; Serial: 2051
- Measurement SW: DASY52, Version 52.8 (8);

Area Scan (71x171x1): Interpolated grid: dx=1.500 mm, dy=1.500 mm

Maximum value of SAR (interpolated) = 4.66 W/kg

Zoom Scan (5x5x7)/Cube 0: Measurement grid: dx=8mm, dy=8mm, dz=5mm

Reference Value = 34.01 V/m; Power Drift = -0.09 dB

Peak SAR (extrapolated) = 12.1 W/kg

SAR(1 g) = 2.69 W/kg; SAR(10 g) = 1.32 W/kg

Maximum value of SAR (measured) = 5.88 W/kg

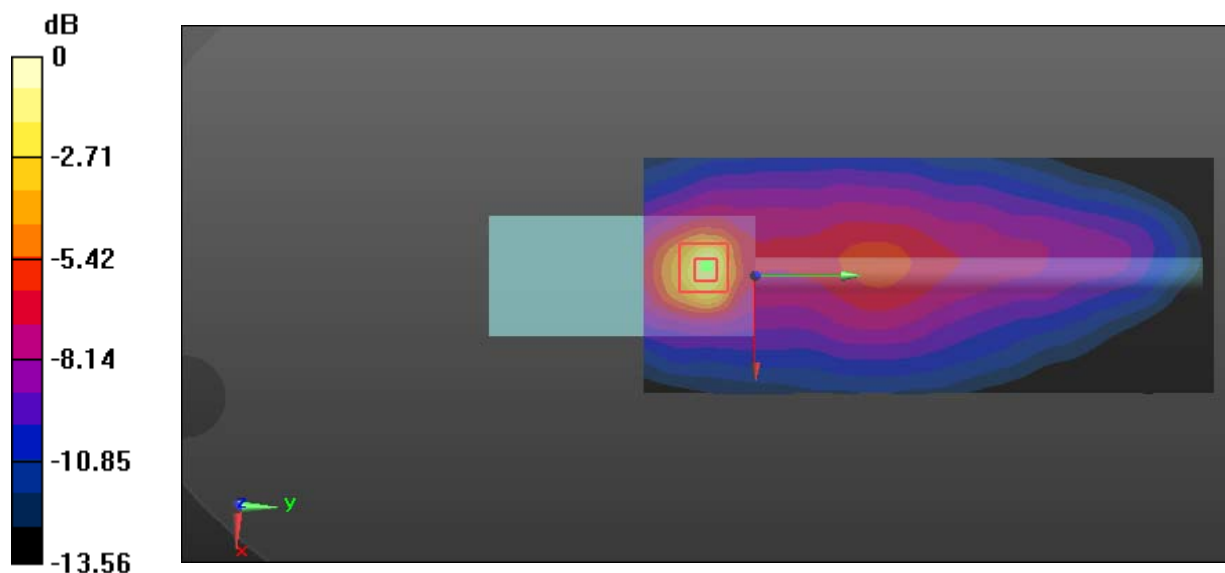

0 dB = 5.88 W/kg = 7.69 dBW/kg