



SAR EVALUATION REPORT

For

Hytera Communications Corporation Limited

Hytera Tower, Hi-Tech Industrial Park North, 9108# Beihuan Road, Nanshan District, Shenzhen,
518057 China

FCC ID: YAMPD60XIUHF

Report Type: Original Report	Product Type: Digital Portable Radio
Report Number: RDG171207009-20	
Report Date: 2018-01-10	
Reviewed By: Rocky Xiao RF Engineer	<i>Rocky Xiao</i>
Prepared By: Bay Area Compliance Laboratories Corp. (Dongguan) No.69 Pulongcun, Puxinhu Industry Area, Tangxia, Dongguan, Guangdong, China Tel: +86-769-86858888 Fax: +86-769-86858891 www.baclcorp.com.cn	

Note: This test report is prepared for the customer shown above and for the device described herein. It may not be duplicated or used in part without prior written consent from Bay Area Compliance Laboratories Corp. (Dongguan).

Attestation of Test Results			
EUT Information	EUT Description	Digital Portable Radio	
	Tested Model	PD602i Um	
	Series Model	PD605i Um, PD606i Um, PD608i Um	
	Serial Number	17120700920	
	Test Date	2017-12-25 ~ 2017-12-26	
MODE		Max. SAR Level(s) Reported(W/kg)	Limit
PTT(400-512 MHz)		1g Head SAR(Face Up)	3.73
		1g Body SAR(Body Back)	5.83
Applicable Standards	FCC 47 CFR part 2.1093 Radiofrequency radiation exposure evaluation: portable devices		
	IEEE1528:2013 IEEE Recommended Practice for Determining the Peak Spatial-Average Specific Absorption Rate (SAR) in the Human Head from Wireless Communications Devices: Measurement Techniques		
	IEC 62209-2:2010 Human exposure to radio frequency fields from hand-held and body-mounted wireless communication devices-Human models, instrumentation, and procedures-Part 2: Procedure to determine the specific absorption rate (SAR) for wireless communication devices used in close proximity to the human body (frequency range of 30 MHz to 6 GHz)		
	KDB procedures KDB 447498 D01 General RF Exposure Guidance v06 KDB 865664 D01 SAR Measurement 100 MHz to 6 GHz v01r04 KDB 865664 D02 RF Exposure Reporting v01r02 KDB 643646 D01 SAR Test for PTT Radios v01r03		
Note: This wireless device has been shown to be capable of compliance for localized specific absorption rate (SAR) for Occupational/Controlled Exposure limits specified in FCC 47 CFR part 2.1093 and has been tested in accordance with the measurement procedures specified in IEEE 1528-2013 and RF exposure KDB procedures. The results and statements contained in this report pertain only to the device(s) evaluated.			

TABLE OF CONTENTS

DOCUMENT REVISION HISTORY	4
EUT DESCRIPTION	5
TECHNICAL SPECIFICATION	5
REFERENCE, STANDARDS, AND GUIDELINES.....	6
SAR LIMITS	6
FACILITIES.....	7
DESCRIPTION OF TEST SYSTEM	8
EQUIPMENT LIST AND CALIBRATION	13
EQUIPMENTS LIST & CALIBRATION INFORMATION	13
SAR MEASUREMENT SYSTEM VERIFICATION	14
LIQUID VERIFICATION	14
SYSTEM ACCURACY VERIFICATION	16
SAR SYSTEM VALIDATION DATA	17
EUT TEST STRATEGY AND METHODOLOGY	19
TEST POSITIONS FOR DEVICE OPERATING NEXT TO A PERSON’S EAR.....	19
CHEEK/TOUCH POSITION	20
EAR/TILT POSITION	20
TEST POSITIONS FOR BODY-WORN AND OTHER CONFIGURATIONS	21
TEST DISTANCE FOR SAR EVALUATION	21
SAR EVALUATION PROCEDURE.....	22
CONDUCTED OUTPUT POWER MEASUREMENT	23
PROVISION APPLICABLE	23
TEST PROCEDURE	23
MAXIMUM TARGET OUTPUT POWER	23
TEST RESULTS:	23
SAR MEASUREMENT RESULTS.....	25
SAR TEST DATA.....	25
TEST RESULT:	26
SAR MEASUREMENT VARIABILITY	28
SAR PLOTS.....	29
APPENDIX A MEASUREMENT UNCERTAINTY	30
APPENDIX B EUT TEST POSITION PHOTOS	32
APPENDIX C CALIBRATION CERTIFICATES	33

DOCUMENT REVISION HISTORY

Revision Number	Report Number	Description of Revision	Date of Revision
1.0	RDG171207009-20	Original Report	2018-01-10

EUT DESCRIPTION

The **Hytera Communications Corporation Limited's** product, model number: **PD602i Um(FCC ID: YAMPD60XIUHF)** in this report was a **Digital Portable Radio**.

Notes: This series products model: PD605i Um, PD606i Um and PD608i Um are electrically identical, and only are different for model number. Model PD602i Um was selected for fully testing, the detailed information can be referred to the declaration which was stated and guaranteed by the applicant.

**All measurement and test data in this report was gathered from production sample serial number: 17120700920 (Assigned by BACL, Dongguan).The EUT supplied by the applicant was received on 2017-12-12.*

Technical Specification

Device Type:	Portable
Exposure Category:	Occupational/Controlled Exposure
Antenna Type(s):	External Antenna
Body-Worn Accessories:	Belt Clip
Face-Head Accessories:	None
Operation Mode :	PTT_FM, PTT_4FSK
Frequency Band:	400 -512 MHz
Conducted RF Power:	3.99 W
Power Source:	DC 7.4 V Li-ion Battery
Normal Operation:	Face Up and Body-worn

REFERENCE, STANDARDS, AND GUIDELINES

The Report and Order requires routine SAR evaluation prior to equipment authorization of portable transmitter devices, including portable telephones. For consumer products, ANSI/IEEE standard C95.1-1992 [6], limit the whole-body-averaged SAR to 0.4 and 0.08 W/kg for the controlled and uncontrolled environments. According to the Supplement C of OET Bulletin 65 "Evaluating Compliance with FCC Guide-lines for Human Exposure to Radio frequency Electromagnetic Fields", released on Jun 29, 2001 by the FCC, the device should be evaluated at maximum output power (radiated from the antenna) under "worst-case" conditions for normal or intended use, incorporating normal antenna operating positions, device peak performance frequencies and positions for maximum RF energy coupling.

This report describes the methodology and results of experiments performed on wireless data terminal. The objective was to determine if there is RF radiation and if radiation is found, what is the extent of radiation with respect to safety limits. SAR (Specific Absorption Rate) is the measure of RF exposure determined by the amount of RF energy absorbed by human body (or its parts) – to determine how the RF energy couples to the body or head which is a primary health concern for body worn devices. The limit below which the exposure to RF is considered safe by regulatory bodies in North America.

SAR Limits

FCC Limit

EXPOSURE LIMITS	SAR (W/kg)	
	(General Population / Uncontrolled Exposure Environment)	(Occupational / Controlled Exposure Environment)
Spatial Average (averaged over the whole body)	0.08	0.4
Spatial Peak (averaged over any 1 g of tissue)	1.60	8.0
Spatial Peak (hands/wrists/feet/ankles averaged over 10 g)	4.0	20.0

Population/Uncontrolled Environments are defined as locations where there is the exposure of individual who have no knowledge or control of their exposure.

Occupational/Controlled Environments are defined as locations where there is exposure that may be incurred by people who are aware of the potential for exposure (i.e. as a result of employment or occupation).

FACILITIES

The Test site used by Bay Area Compliance Laboratories Corp. (Dongguan) to collect test data is located on the No.69 Pulongcun, Puxinhu Industry Area, Tangxia, Dongguan, Guangdong, China.

The test site has been approved by the FCC under the KDB 974614 D01 and is listed in the FCC Public Access Link (PAL) database, FCC Registration No. : 897218, the FCC Designation No. : CN1220.

The test site has been registered with ISED Canada under ISED Canada Registration Number 3062D.

The test sites and measurement facilities used to collect data are located at:

<input checked="" type="checkbox"/> SAR Lab 1	<input type="checkbox"/> SAR Lab 2
---	------------------------------------

DESCRIPTION OF TEST SYSTEM

These measurements were performed with the automated near-field scanning system DASY5 from Schmid & Partner Engineering AG (SPEAG) which is the Fifth generation of the system shown in the figure hereinafter:



DASY5 System Description

The DASY5 system for performing compliance tests consists of the following items:

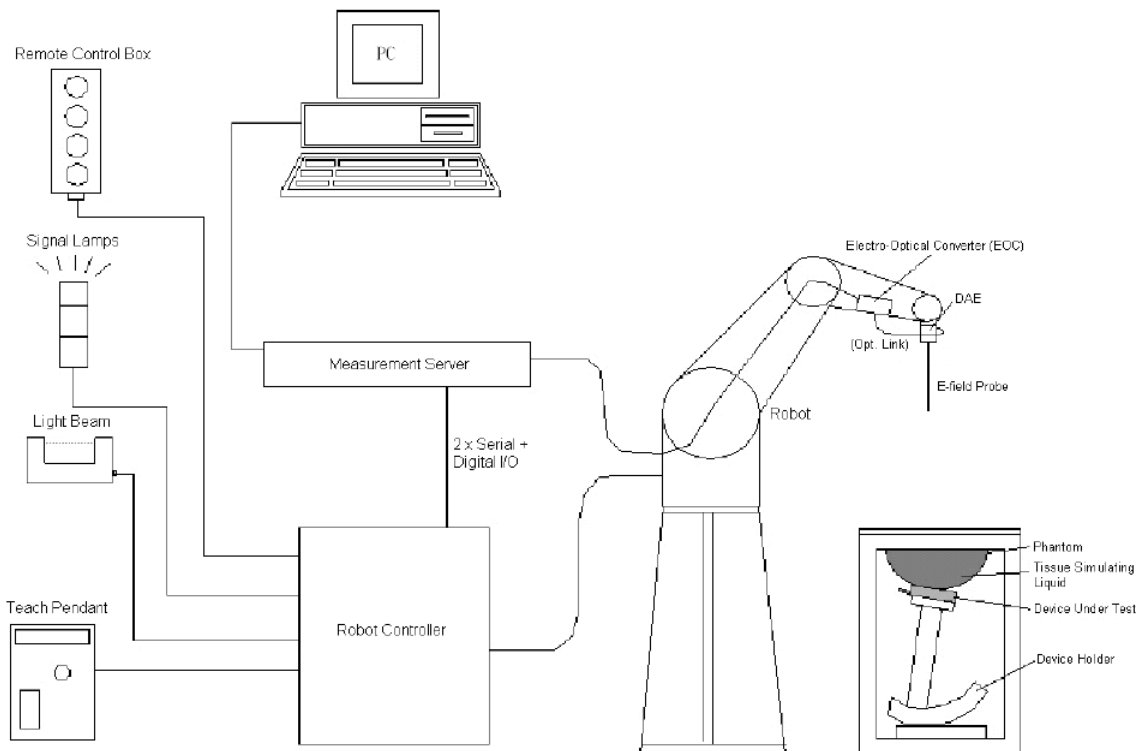

- A standard high precision 6-axis robot with controller, teach pendant and software. An arm extension for accommodating the data acquisition electronics (DAE).
- An isotropic field probe optimized and calibrated for the targeted measurement.
- A data acquisition electronics (DAE) which performs the signal application, signal multiplexing, AD-conversion, offset measurements, mechanical surface detection, collision detection, etc. The unit is battery powered with standard or rechargeable batteries. The signal is optically transmitted to the EOC.
- The Electro-optical converter (EOC) performs the conversion from optical to electrical signals for the digital communication to the DAE. To use optical surface detection, a special version of the EOC is required. The EOC signal is transmitted to the measurement server.
- The function of the measurement server is to perform the time critical tasks such as signal filtering, control of the robot operation and fast movement interrupts.
- The Light Beam used is for probe alignment. This improves the (absolute) accuracy of the probe positioning.
- A computer running Win7 professional operating system and the DASY52 software.
- Remote control and teach pendant as well as additional circuitry for robot safety such as warning lamps, etc.
- The phantom, the device holder and other accessories according to the targeted measurement.

DASY5 Measurement Server

The DASY5 measurement server is based on a PC/104 CPU board with a 400MHz Intel ULV Celeron, 128MB chip-disk and 128MB RAM. The necessary circuits for communication with the DAE4 (or DAE3) electronics box, as well as the 16 bit AD-converter system for optical detection and digital I/O interface are contained on the DASY5 I/O board, which is directly connected to the PC/104 bus of the CPU board.



The measurement server performs all real-time data evaluation of field measurements and surface detection, controls robot movements and handles safety operation. The PC operating system cannot interfere with these time critical processes. All connections are supervised by a watchdog, and disconnection of any of the cables to the measurement server will automatically disarm the robot and disable all program-controlled robot movements. Furthermore, the measurement server is equipped with an expansion port which is reserved for future applications. Please note that this expansion port does not have a standardized point out, and therefore only devices provided by SPEAG can be connected. Devices from any other supplier could seriously damage the measurement server.

Data Acquisition Electronics

The data acquisition electronics (DAE4) consist of a highly sensitive electrometer-grade preamplifier with auto-zeroing, a channel and gain-switching multiplexer, a fast 16 bit AD-converter and a command decoder with a control logic unit. Transmission to the measurement server is accomplished through an optical downlink for data and status information, as well as an optical uplink for commands and the clock.

The mechanical probe mounting device includes two different sensor systems for frontal and sideways probe contacts. They are used for mechanical surface detection and probe collision detection.

The input impedance of both the DAE4 as well as of the DAE3 box is 200M Ω ; the inputs are symmetrical and floating. Common mode rejection is above 80 dB.

EX3DV4 E-Field Probes

Frequency	10 MHz to > 6 GHz Linearity: ± 0.2 dB (30 MHz to 6 GHz)
Directivity	± 0.3 dB in TSL (rotation around probe axis) ± 0.5 dB in TSL (rotation normal to probe axis)
Dynamic Range	10 µW/g to > 100 mW/g Linearity: ± 0.2 dB (noise: typically < 1 µW/g)
Dimensions	Overall length: 337 mm (Tip: 20 mm) Tip diameter: 2.5 mm (Body: 12 mm) Typical distance from probe tip to dipole centers: 1 mm
Application	High precision dosimetric measurements in any exposure scenario (e.g., very strong gradient fields); the only probe that enables compliance testing for frequencies up to 6 GHz with precision of better 30%.
Compatibility	DASY3, DASY4, DASY52 SAR and higher, EASY4/MRI

Robots

The DASY5 system uses the high precision industrial robot. The robot offers the same features important for our application:

- High precision (repeatability 0.02mm)
- High reliability (industrial design)
- Low maintenance costs (virtually maintenance free due to direct drive gears; no belt drives)
- Jerk-free straight movements (brushless synchrony motors; no stepper motors)
- Low ELF interference (motor control fields shielded via the closed metallic construction shields)

The above mentioned robots are controlled by the Staubli CS8c robot controllers. All information regarding the use and maintenance of the robot arm and the robot controller is contained on the CDs delivered along with the robot. Paper manuals are available upon request direct from Staubli.

Area Scans

Area scans are defined prior to the measurement process being executed with a user defined variable spacing between each measurement point (integral) allowing low uncertainty measurements to be conducted. Scans defined for FCC applications utilize a 15mm 2 step integral, with 1.5mm interpolation used to locate the peak SAR area used for zoom scan assessments.

Where the system identifies multiple SAR peaks (which are within 25% of peak value) the system will provide the user with the option of assessing each peak location individually for zoom scan averaging.

Zoom Scan (Cube Scan Averaging)

The averaging zoom scan volume utilized in the DASY5 software is in the shape of a cube and the side dimension of a 1 g or 10 g mass is dependent on the density of the liquid representing the simulated tissue. A density of 1000 kg/m³ is used to represent the head and body tissue density and not the phantom liquid density, in order to be consistent with the definition of the liquid dielectric properties, i.e. the side length of the 1g cube is 10mm, with the side length of the 10g cube is 21.5mm.

When the cube intersects with the surface of the phantom, it is oriented so that 3 vertices touch the surface of the shell or the center of a face is tangent to the surface. The face of the cube closest to the surface is modified in order to conform to the tangent surface.

The zoom scan integer steps can be user defined so as to reduce uncertainty, but normal practice for typical test applications (including FCC) utilize a physical step of 7 x 7 x 7 (5mmx5mmx5mm) providing a volume of 30 mm in the X & Y & Z axis.

Tissue Dielectric Parameters for Head and Body Phantoms

The head tissue dielectric parameters recommended by the IEEE SCC-34/SC-2 in P1528 have been incorporated in the following table. These head parameters are derived from planar layer models simulating the highest expected SAR for the dielectric properties and tissue thickness variations in a human head. Other head and body tissue parameters that have not been specified in P1528 are derived from the tissue dielectric parameters computed from the 4-Cole-Cole equations described in Reference [12] and extrapolated according to the head parameters specified in P1528.

Recommended Tissue Dielectric Parameters for Head and Body

Frequency (MHz)	Head Tissue		Body Tissue	
	ϵ_r	σ (S/m)	ϵ_r	σ (S/m)
150	52.3	0.76	61.9	0.80
300	45.3	0.87	58.2	0.92
450	43.5	0.87	56.7	0.94
835	41.5	0.90	55.2	0.97
900	41.5	0.97	55.0	1.05
915	41.5	0.98	55.0	1.06
1450	40.5	1.20	54.0	1.30
1610	40.3	1.29	53.8	1.40
1800-2000	40.0	1.40	53.3	1.52
2450	39.2	1.80	52.7	1.95
3000	38.5	2.40	52.0	2.73
5800	35.3	5.27	48.2	6.00

EQUIPMENT LIST AND CALIBRATION

Equipments List & Calibration Information

Equipment	Model	S/N	Calibration Date	Calibration Due Date
DASY5 Test Software	DASY52.8	N/A	NCR	NCR
DASY5 Measurement Server	DASY5 4.5.12	1470	NCR	NCR
Data Acquisition Electronics	DAE4	1459	2017/9/15	2018/9/15
E-Field Probe	EX3DV4	7441	2017/11/23	2018/11/22
Dipole, 450MHz	D450V3	1096	2016/11/07	2019/11/06
Mounting Device	MD4HHTV5	BJPCTC0152	NCR	NCR
Oval Flat Phantom	ELI V8.0	2051	NCR	NCR
Simulated Tissue 450 MHz Head	TS-450-H	1709045001	Each Time	/
Simulated Tissue 450 MHz Body	TS-450-B	1709045002	Each Time	/
Network Analyzer	8753C	3033A02857	2017/8/31	2018/8/31
Dielectric assessment kit	1253	SM DAK 040 CA	NCR	NCR
Signal Generator	N5182B	MY51350142	2017/5/4	2018/5/4
Power Meter	EPM-441A	GB37481494	2017/12/11	2018/12/11
Power Amplifier	ZVA-213-S+	SN054 201245	NCR	NCR
Directional Coupler	488Z	N/A	NCR	NCR
Attenuator	20dB, 100W	N/A	NCR	NCR
Attenuator	3dB, 150W	N/A	NCR	NCR

SAR MEASUREMENT SYSTEM VERIFICATION

Liquid Verification

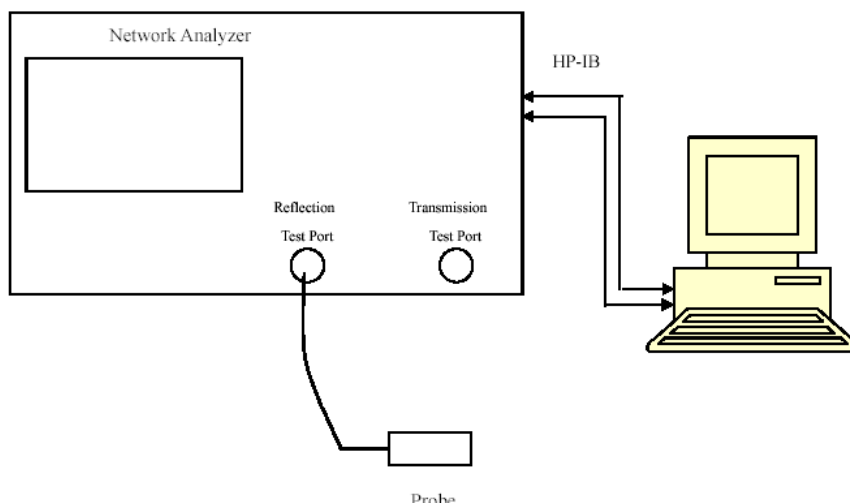

Liquid Verification Setup Block Diagram

Liquid Verification Results

Frequency (MHz)	Liquid Type	Liquid Parameter		Target Value		Delta (%)		Tolerance (%)
		ϵ_r	σ (S/m)	ϵ_r	σ (S/m)	$\Delta\epsilon_r$	$\Delta\sigma$ (S/m)	
400.0125	Simulated Tissue 450 MHz Head	44.726	0.849	43.5	0.87	2.82	-2.41	± 5
417	Simulated Tissue 450 MHz Head	44.701	0.851	43.5	0.87	2.76	-2.18	± 5
435	Simulated Tissue 450 MHz Head	44.653	0.853	43.5	0.87	2.65	-1.95	± 5
450	Simulated Tissue 450 MHz Head	44.532	0.855	43.5	0.87	2.37	-1.72	± 5
450.0125	Simulated Tissue 450 MHz Head	44.532	0.855	43.5	0.87	2.37	-1.72	± 5
452	Simulated Tissue 450 MHz Head	44.531	0.856	43.5	0.87	2.37	-1.61	± 5
469	Simulated Tissue 450 MHz Head	44.164	0.858	43.5	0.87	1.53	-1.38	± 5
469.9875	Simulated Tissue 450 MHz Head	44.162	0.859	43.5	0.87	1.52	-1.26	± 5
488.5	Simulated Tissue 450 MHz Head	44.067	0.861	43.5	0.87	1.3	-1.03	± 5
507	Simulated Tissue 450 MHz Head	44.024	0.863	43.5	0.87	1.2	-0.8	± 5
511.9875	Simulated Tissue 450 MHz Head	43.953	0.868	43.5	0.87	1.04	-0.23	± 5

*Liquid Verification above was performed on 2017/12/26.

Frequency (MHz)	Liquid Type	Liquid Parameter		Target Value		Delta (%)		Tolerance (%)
		ϵ_r	σ (S/m)	ϵ_r	σ (S/m)	$\Delta\epsilon_r$	$\Delta\sigma$ (S/m)	
400.0125	Simulated Tissue 450 MHz Body	57.964	0.916	57.2	0.93	1.34	-1.51	±5
417	Simulated Tissue 450 MHz Body	57.866	0.916	57.03	0.94	1.47	-2.55	±5
435	Simulated Tissue 450 MHz Body	57.759	0.917	56.85	0.94	1.6	-2.45	±5
450	Simulated Tissue 450 MHz Body	57.661	0.918	56.7	0.94	1.69	-2.34	±5
450.0125	Simulated Tissue 450 MHz Body	57.659	0.918	56.7	0.94	1.69	-2.34	±5
452	Simulated Tissue 450 MHz Body	57.657	0.918	56.69	0.94	1.71	-2.34	±5
469	Simulated Tissue 450 MHz Body	57.587	0.924	56.63	0.94	1.69	-1.7	±5
469.9875	Simulated Tissue 450 MHz Body	57.586	0.925	56.62	0.94	1.71	-1.6	±5
488.5	Simulated Tissue 450 MHz Body	57.501	0.927	56.55	0.94	1.68	-1.38	±5
507	Simulated Tissue 450 MHz Body	57.304	0.932	56.48	0.94	1.46	-0.85	±5
511.9875	Simulated Tissue 450 MHz Body	57.094	0.935	56.4	0.95	1.23	-1.58	±5

*Liquid Verification above was performed on 2017/12/25.

System Accuracy Verification

Prior to the assessment, the system validation kit was used to test whether the system was operating within its specifications of $\pm 10\%$. The validation results are tabulated below. And also the corresponding SAR plot is attached as well in the SAR plots files.

The spacing distance s in the **System Verification Setup Block Diagram** is given by the following:

- a) $s = 15 \text{ mm} \pm 0,2 \text{ mm}$ for $300 \text{ MHz} \leq f \leq 1\,000 \text{ MHz}$;
- b) $s = 10 \text{ mm} \pm 0,2 \text{ mm}$ for $1\,000 \text{ MHz} < f \leq 3\,000 \text{ MHz}$;
- c) $s = 10 \text{ mm} \pm 0,2 \text{ mm}$ for $3\,000 \text{ MHz} < f \leq 6\,000 \text{ MHz}$.
- d) $s = 0 \text{ mm}$ for $f = 150 \text{ MHz}$ (Loop Antenna).

System Verification Setup Block Diagram

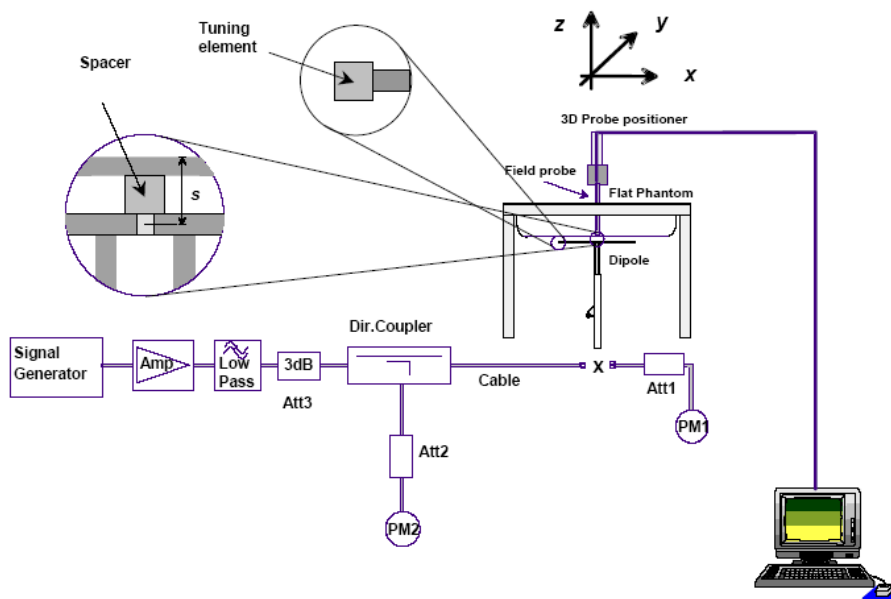

System Accuracy Check Results

Date	Frequency Band	Liquid Type	Input Power (mW)	Measured SAR (W/kg)	Normalized to 1W (W/kg)	Target Value (W/kg)	Delta (%)	Tolerance (%)
2017/12/26	450 MHz	450MHz Head	100	1g 0.433	4.33	4.53	-4.42	± 10
2017/12/25	450 MHz	450MHz Body	100	1g 0.428	4.28	4.55	-5.93	± 10

*The SAR values above are normalized to 1 Watt forward power.

SAR SYSTEM VALIDATION DATA

System Performance 450 MHz Head

DUT: Dipole 450 MHz; Type: D450V3; Serial: 1096

Communication System: CW; Frequency: 450 MHz; Duty Cycle: 1:1
 Medium parameters used: $f = 450 \text{ MHz}$; $\sigma = 0.855 \text{ S/m}$; $\epsilon_r = 44.532$; $\rho = 1000 \text{ kg/m}^3$
 Phantom section: Flat Section

DASY5 Configuration:

- Probe: EX3DV4 - SN7441; ConvF(10.97, 10.97, 10.97); Calibrated: 2017/11/23;
- Sensor-Surface: 1.4mm (Mechanical Surface Detection)
- Electronics: DAE4 Sn1459; Calibrated: 2017/9/15
- Phantom: ELI v8.0; Type: QDOVA004AA; Serial: 2051
- Measurement SW: DASY52, Version 52.8 (8);

Area Scan (41x201x1): Interpolated grid: $dx=1.500 \text{ mm}$, $dy=1.500 \text{ mm}$
 Maximum value of SAR (interpolated) = 0.586 W/kg

Zoom Scan (5x5x7)/Cube 0: Measurement grid: $dx=8\text{mm}$, $dy=8\text{mm}$, $dz=5\text{mm}$
 Reference Value = 23.11 V/m; Power Drift = -0.03 dB
 Peak SAR (extrapolated) = 0.675 W/kg
SAR(1 g) = 0.433 W/kg; SAR(10 g) = 0.296 W/kg
 Maximum value of SAR (measured) = 0.574 W/kg

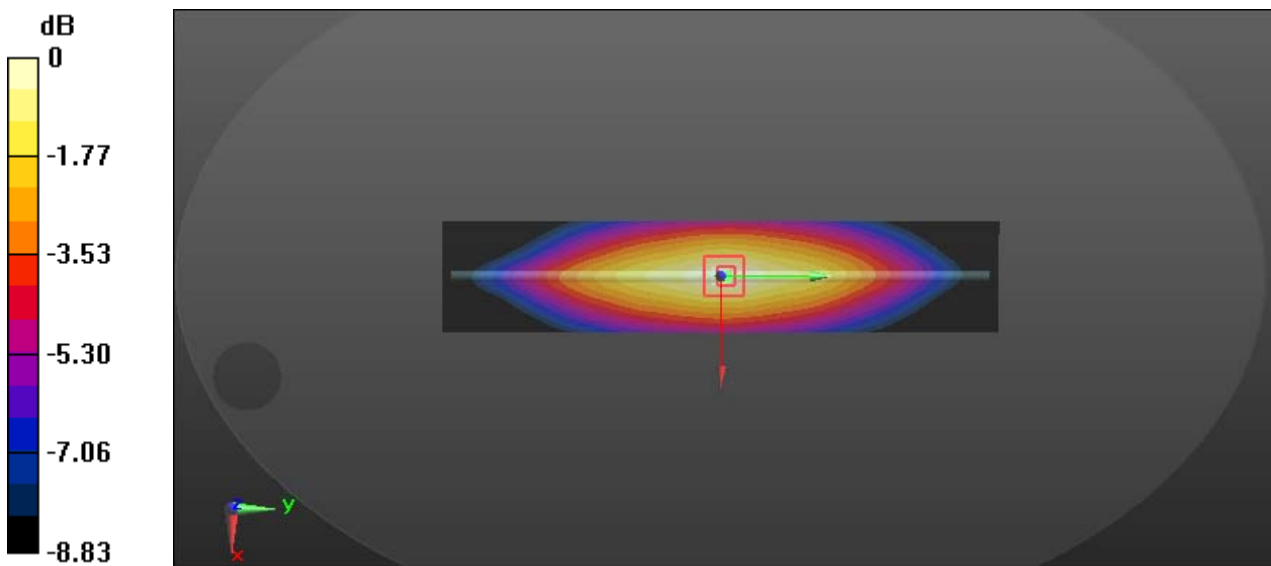

0 dB = 0.574 W/kg = -2.41 dBW/kg

System Performance 450 MHz Body

DUT: Dipole 450 MHz; Type: D450V3; Serial: 1096

Communication System: CW; Frequency: 450 MHz; Duty Cycle: 1:1

Medium parameters used: $f = 450 \text{ MHz}$; $\sigma = 0.918 \text{ S/m}$; $\epsilon_r = 57.661$; $\rho = 1000 \text{ kg/m}^3$

Phantom section: Flat Section

DASY5 Configuration:

- Probe: EX3DV4 - SN7441; ConvF(12.08, 12.08, 12.08); Calibrated: 2017/11/23;
- Sensor-Surface: 1.4mm (Mechanical Surface Detection)
- Electronics: DAE4 Sn1459; Calibrated: 2017/9/15
- Phantom: ELI v8.0; Type: QDOVA004AA; Serial: 2051
- Measurement SW: DASY52, Version 52.8 (8);

Area Scan (41x201x1): Interpolated grid: $dx=1.500 \text{ mm}$, $dy=1.500 \text{ mm}$

Maximum value of SAR (interpolated) = 0.588 W/kg

Zoom Scan (5x5x7)/Cube 0: Measurement grid: $dx=8\text{mm}$, $dy=8\text{mm}$, $dz=5\text{mm}$

Reference Value = 21.87 V/m; Power Drift = -0.05 dB

Peak SAR (extrapolated) = 0.674 W/kg

SAR(1 g) = 0.428 W/kg; SAR(10 g) = 0.286 W/kg

Maximum value of SAR (measured) = 0.579 W/kg

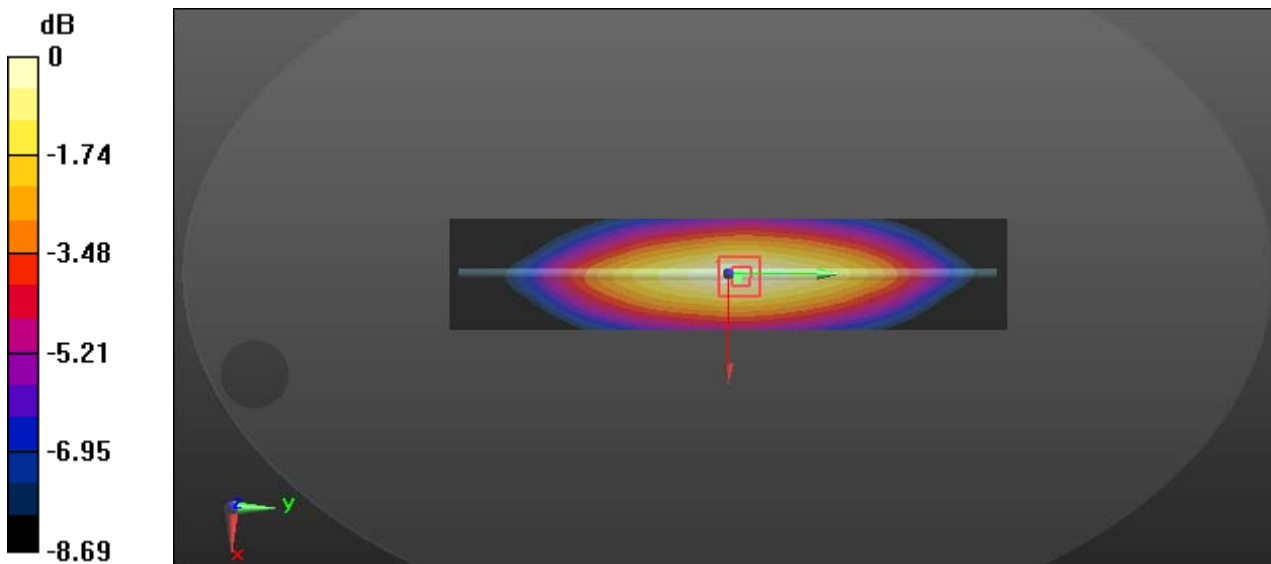

0 dB = 0.579 W/kg = -2.37 dBW/kg

EUT TEST STRATEGY AND METHODOLOGY

Test Positions for Device Operating Next to a Person’s Ear

This category includes most wireless handsets with fixed, retractable or internal antennas located toward the top half of the device, with or without a foldout, sliding or similar keypad cover. The handset should have its earpiece located within the upper ¼ of the device, either along the centerline or off-centered, as perceived by its users. This type of handset should be positioned in a normal operating position with the “test device reference point” located along the “vertical centerline” on the front of the device aligned to the “ear reference point”. The “test device reference point” should be located at the same level as the center of the earpiece region. The “vertical centerline” should bisect the front surface of the handset at its top and bottom edges. A “ear reference point” is located on the outer surface of the head phantom on each ear spacer. It is located 1.5 cm above the center of the ear canal entrance in the “phantom reference plane” defined by the three lines joining the center of each “ear reference point” (left and right) and the tip of the mouth.

A handset should be initially positioned with the earpiece region pressed against the ear spacer of a head phantom. For the SCC-34/SC-2 head phantom, the device should be positioned parallel to the “N-F” line defined along the base of the ear spacer that contains the “ear reference point”. For interim head phantoms, the device should be positioned parallel to the cheek for maximum RF energy coupling. The “test device reference point” is aligned to the “ear reference point” on the head phantom and the “vertical centerline” is aligned to the “phantom reference plane”. This is called the “initial ear position”. While maintaining these three alignments, the body of the handset is gradually adjusted to each of the following positions for evaluating SAR:

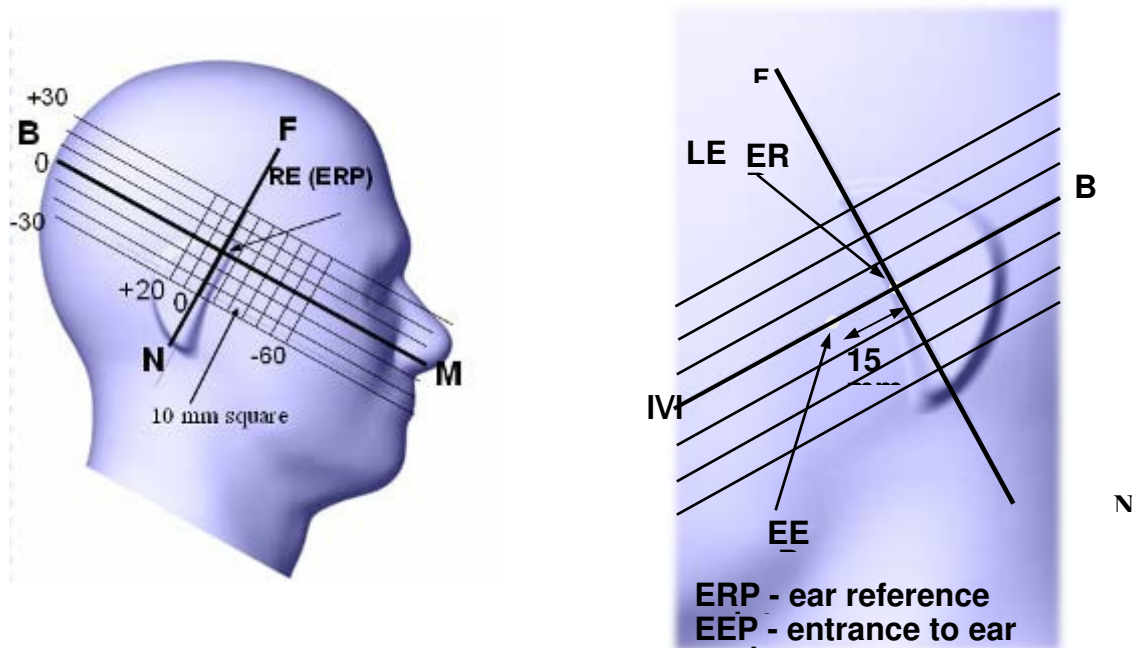

Cheek/Touch Position

The device is brought toward the mouth of the head phantom by pivoting against the “ear reference point” or along the “N-F” line for the SCC-34/SC-2 head phantom.

This test position is established:

When any point on the display, keypad or mouthpiece portions of the handset is in contact with the phantom.

(or) When any portion of a foldout, sliding or similar keypad cover opened to its intended self-adjusting normal use position is in contact with the cheek or mouth of the phantom.

For existing head phantoms – when the handset loses contact with the phantom at the pivoting point, rotation should continue until the device touches the cheek of the phantom or breaks its last contact from the ear spacer.

Cheek /Touch Position

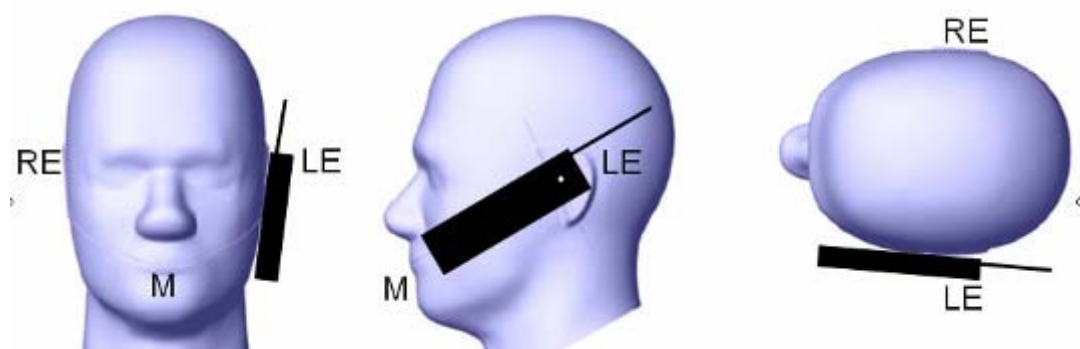

Ear/Tilt Position

With the handset aligned in the “Cheek/Touch Position”:

1) If the earpiece of the handset is not in full contact with the phantom’s ear spacer (in the “Cheek/Touch position”) and the peak SAR location for the “Cheek/Touch” position is located at the ear spacer region or corresponds to the earpiece region of the handset, the device should be returned to the “initial ear position” by rotating it away from the mouth until the earpiece is in full contact with the ear spacer.

2) (otherwise) The handset should be moved (translated) away from the cheek perpendicular to the line passes through both “ear reference points” (note: one of these ear reference points may not physically exist on a split head model) for approximate 2-3 cm. While it is in this position, the device handset is tilted away from the mouth with respect to the “test device reference point” until the inside angle between the vertical centerline on the front surface of the phone and the horizontal line passing through the ear reference point is by 15 80°. After the tilt, it is then moved (translated) back toward the head perpendicular to the line passes through both “ear reference points” until the device touches the phantom or the ear spacer. If the antenna touches the head first, the positioning process should be repeated with a tilt angle less than 15° so that the device and its antenna would touch the phantom simultaneously. This test position may require a device holder or positioner to achieve the translation and tilting with acceptable positioning repeatability.

If a device is also designed to transmit with its keypad cover closed for operating in the head position, such positions should also be considered in the SAR evaluation. The device should be tested on the left and right side of the head phantom in the “Cheek/Touch” and “Ear/Tilt” positions. When applicable, each configuration should be tested with the antenna in its fully extended and fully retracted positions. These test configurations should be tested at the high, middle and low frequency channels of each operating mode; for example, AMPS, CDMA, and TDMA. If the SAR measured at the middle channel for each test configuration (left, right, Cheek/Touch, Tilt/Ear, extended and retracted) is at least 2.0 dB lower than the SAR limit, testing at the high and low channels is optional for such test configuration(s). If the transmission band of the test device is less than 10 MHz, testing at the high and low frequency channels is optional.

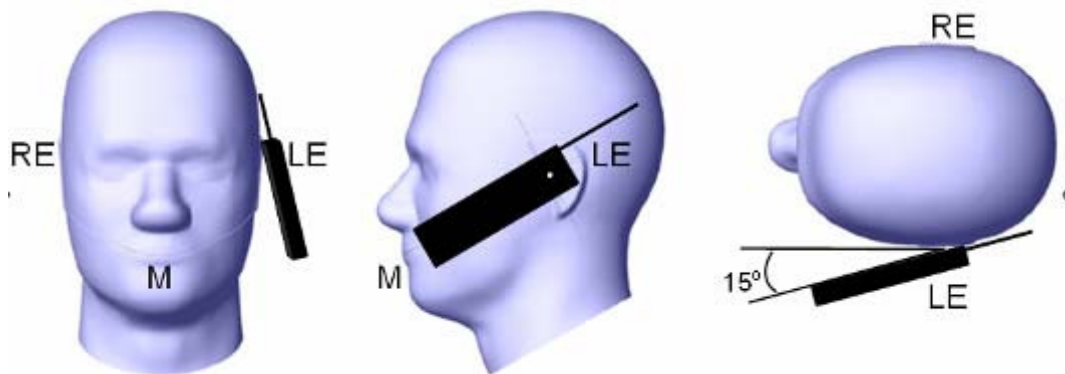
Ear /Tilt 15° Position**Test positions for body-worn and other configurations**

Body-worn operating configurations should be tested with the belt-clips and holsters attached to the device and positioned against a flat phantom in normal use configurations. Devices with a headset output should be tested with a headset connected to the device. When multiple accessories that do not contain metallic components are supplied with the device, the device may be tested with only the accessory that dictates the closest spacing to the body. When multiple accessories that contain metallic components are supplied with the device, the device must be tested with each accessory that contains a unique metallic component. If multiple accessories share an identical metallic component (e.g., the same metallic belt-clip used with different holsters with no other metallic components), only the accessory that dictates the closest spacing to the body must be tested.

Body-worn accessories may not always be supplied or available as options for some devices that are intended to be authorized for body-worn use. A separation distance of 1.5 cm between the back of the device and a flat phantom is recommended for testing body-worn SAR compliance under such circumstances. Other separation distances may be used, but they should not exceed 2.5 cm. In these cases, the device may use body-worn accessories that provide a separation distance greater than that tested for the device provided however that the accessory contains no metallic components.

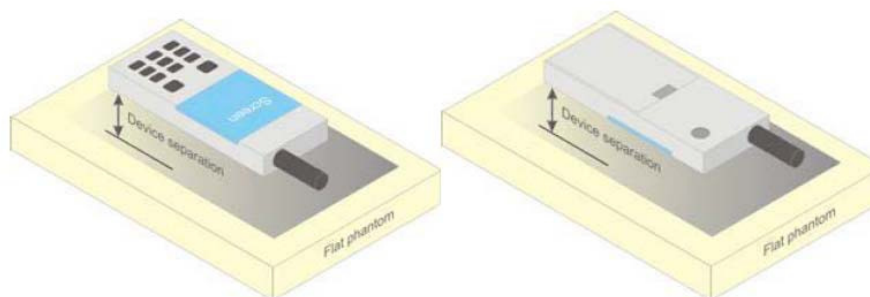

Figure 5 – Test positions for body-worn devices

Test Distance for SAR Evaluation

For this case the DUT(Device Under Test) is set directly against the phantom, the test distance is 0mm for Body Back mode; for Face Up mode the distance is 25mm.

SAR Evaluation Procedure

The evaluation was performed with the following procedure:

Step 1: Measurement of the SAR value at a fixed location above the ear point or central position was used as a reference value for assessing the power drop. The SAR at this point is measured at the start of the test and then again at the end of the testing.

Step 2: The SAR distribution at the exposed side of the head was measured at a distance of 4 mm from the inner surface of the shell. The area covered the entire dimension of the head or radiating structures of the EUT, the horizontal grid spacing was 15 mm x 15 mm, and the SAR distribution was determined by integrated grid of 1.5mm x 1.5mm. Based on these data, the area of the maximum absorption was determined by spline interpolation. The first Area Scan covers the entire dimension of the EUT to ensure that the hotspot was correctly identified.

Step 3: Around this point, a volume of 30 mm x 30 mm x 30 mm was assessed by measuring 7x 7 x 7 points. On the basis of this data set, the spatial peak SAR value was evaluated under the following procedure:

1) The data at the surface were extrapolated, since the center of the dipoles is 1.2 mm away from the tip of the probe and the distance between the surface and the lowest measuring point is 1.3 mm. The extrapolation was based on a least square algorithm. A polynomial of the fourth order was calculated through the points in z-axes. This polynomial was then used to evaluate the points between the surface and the probe tip.

2) The maximum interpolated value was searched with a straightforward algorithm. Around this maximum the SAR values averaged over the spatial volumes (1 g or 10 g) were computed by the 3D-Spline interpolation algorithm. The 3D-Spline is composed of three one dimensional splines with the "Not a knot"-condition (in x, y and z-directions). The volume was integrated with the trapezoidal-algorithm. One thousand points (10 x 10 x 10) were interpolated to calculate the averages.

All neighboring volumes were evaluated until no neighboring volume with a higher average value was found.

Step 4: Re-measurement of the SAR value at the same location as in Step 1. If the value changed by more than 5%, the evaluation was repeated.

CONDUCTED OUTPUT POWER MEASUREMENT

Provision Applicable

The measured peak output power should be greater and within 5% than EMI measurement.

Test Procedure

The RF output of the transmitter was connected to the input of the EMI Test Receiver through sufficient attenuation.

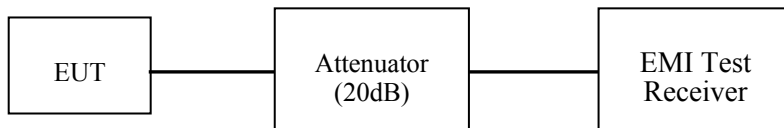

The EMI Test Receiver setting:

RBW	VBW
100 kHz	300 kHz

Maximum Target Output Power

Mode		Maximum output Power(With tolerance)
PTT(400-512 MHz)	FM_12.5kHz	4.0 (W)
	FM_25kHz	
	4FSK_12.5kHz	

Test Results:

Band/Test Mode		Frequency (MHz)	Output Power(W)	Power level
PTT (400-512 MHz)	FM 12.5 kHz	400.0125	3.86	High
		417	3.84	High
		435	3.86	High
		452	3.82	High
		469.9875	3.87	High
		450.0125	3.86	High
		469	3.87	High
		488.5	3.89	High
		507	3.84	High
		511.9875	3.84	High

Band/Test Mode		Frequency (MHz)	Output Power(W)	Power level
PTT (400-512 MHz)	FM 25 kHz	400.0125	3.83	High
		417	3.84	High
		435	3.85	High
		452	3.88	High
		469.9875	3.81	High
		450.0125	3.89	High
		469	3.84	High
		488.5	3.86	High
		507	3.89	High
	511.9875	3.85	High	
	4FSK 12.5 kHz	400.0125	3.87	High
		417	3.95	High
		435	3.98	High
		452	3.88	High
		469.9875	3.99	High
		450.0125	3.81	High
		469	3.82	High
		488.5	3.91	High
		507	3.87	High
511.9875		3.81	High	

SAR MEASUREMENT RESULTS

This page summarizes the results of the performed dosimetric evaluation.

SAR Test Data

Environmental Conditions

Temperature:	21.3-23.1 °C	21.7-23.0 °C
Relative Humidity:	40%	41%
ATM Pressure:	102.2 kPa	101.6 kPa
Test Date:	2017/12/25	2017/12/26

Testing was performed by Yun Yu, Brave Lu, Jayce Chen.

Test Result:

Antenna 1(400-470 MHz):

Pre-Scan all 5 Channels, the peak SAR located on 435 MHz for Face Up mode and 417 MHz for Body Back mode.

Test Mode	Frequency (MHz)	Max. Meas. Power (W)	Maximum output Power(W)	1 g SAR Value(W/kg)					
				Scaled Factor	Meas. SAR	Scaled SAR	50%	Plot	
Face Up (25 mm)	FM 12.5 kHz	400.0125	3.86	4	1.034	2.74	2.833	1.42	1#
		417	3.84	4	1.04	6.38	6.635	3.32	2#
		435	3.86	4	1.034	7.21	7.455	3.73	3#
		452	3.82	4	1.045	4.53	4.734	2.37	4#
		469.9875	3.87	4	1.032	5.1	5.263	2.63	5#
	FM 25 kHz	400.0125	3.83	4	1.042	3.1	3.23	1.62	6#
		417	3.84	4	1.04	6.81	7.082	3.54	7#
		435	3.85	4	1.037	7.03	7.29	3.65	8#
		452	3.88	4	1.029	4.68	4.816	2.41	9#
		469.9875	3.81	4	1.047	4.96	5.193	2.6	10#
	4FSK 12.5 kHz	400.0125	/	/	/	/	/	/	/
		417	/	/	/	/	/	/	/
		435	3.98	4	1.005	3.32	3.337	1.67	11#
		452	/	/	/	/	/	/	/
		469.9875	/	/	/	/	/	/	/
Body Back (0 mm)	FM 12.5 kHz	400.0125	3.86	4	1.034	5.38	5.563	2.78	12#
		417	3.84	4	1.04	10.8	11.232	5.62	13#
		435	3.86	4	1.034	7.82	8.086	4.04	14#
		452	3.82	4	1.045	5.28	5.518	2.76	15#
		469.9875	3.87	4	1.032	6.29	6.491	3.25	16#
	FM 25 kHz	400.0125	3.83	4	1.042	4.98	5.189	2.59	17#
		417	3.84	4	1.04	10.1	10.504	5.25	18#
		435	3.85	4	1.037	7.87	8.161	4.08	19#
		452	3.88	4	1.029	5.41	5.567	2.78	20#
		469.9875	3.81	4	1.047	6.29	6.586	3.29	21#
	4FSK 12.5 kHz	400.0125	/	/	/	/	/	/	/
		417	3.84	4	1.04	4.24	4.41	2.21	22#
		435	/	/	/	/	/	/	/
		452	/	/	/	/	/	/	/
		469.9875	/	/	/	/	/	/	/

Antenna 2(450-512 MHz):

Pre-Scan all 5 Channels, the peak SAR located on 488.5 MHz for Face Up mode and 469MHz for Body Back mode.

Test Mode		Frequency (MHz)	Max. Meas. Power (W)	Maximum output Power(W)	1 g SAR Value(W/kg)				
					Scaled Factor	Meas. SAR	Scaled SAR	50%	Plot
Face Up (25 mm)	FM 12.5 kHz	450.0125	3.86	4	1.034	5.12	5.294	2.65	23#
		469	3.87	4	1.032	5.22	5.387	2.69	24#
		488.5	3.89	4	1.027	6.89	7.076	3.54	25#
		507	3.84	4	1.04	6.18	6.427	3.21	26#
		511.9875	3.84	4	1.04	4.42	4.597	2.3	27#
	FM 25 kHz	450.0125	/	/	/	/	/	/	/
		469	/	/	/	/	/	/	/
		488.5	3.86	4	1.034	6.16	6.369	3.18	28#
		507	/	/	/	/	/	/	/
		511.9875	/	/	/	/	/	/	/
	4FSK 12.5 kHz	450.0125	/	/	/	/	/	/	/
		469	/	/	/	/	/	/	/
		488.5	3.91	4	1.022	3.26	3.332	1.67	29#
		507	/	/	/	/	/	/	/
		511.9875	/	/	/	/	/	/	/
Body Back (0 mm)	FM 12.5 kHz	450.0125	3.86	4	1.034	10.6	10.96	5.48	30#
		469	3.87	4	1.032	11.3	11.662	5.83	31#
		488.5	3.89	4	1.027	9.51	9.767	4.88	32#
		507	3.84	4	1.04	7.63	7.935	3.97	33#
		511.9875	3.84	4	1.04	7.43	7.727	3.86	34#
	FM 25 kHz	450.0125	3.89	4	1.027	10.2	10.475	5.24	35#
		469	3.84	4	1.04	11.2	11.648	5.82	36#
		488.5	3.86	4	1.034	10	10.34	5.17	37#
		507	3.89	4	1.027	9.28	9.531	4.77	38#
		511.9875	3.85	4	1.037	7.66	7.943	3.97	39#
	4FSK 12.5 kHz	450.0125	/	/	/	/	/	/	/
		469	3.82	4	1.045	5.58	5.831	2.92	40#
		488.5	/	/	/	/	/	/	/
		507	/	/	/	/	/	/	/
		511.9875	/	/	/	/	/	/	/

Note:

1. When the 1-g SAR is $\leq 3.5W/kg$, testing for other channels are optional.
2. KDB 447498 D01 - A duty factor of 50% should be applied to determine compliance for radios with maximum operating duty factors $\leq 50\%$. The 50% duty factor only applies to exposure conditions where the radio operates with a mechanical PTT button.
3. Passive body-worn and audio accessories generally do not apply to the head SAR of PTT radios.
4. The whole antenna and radiating structures that may contribute to the measured SAR or influence the SAR distribution has been included in the area scan.

SAR Measurement Variability

In accordance with published RF Exposure KDB procedure 865664 D01 SAR measurement 100 MHz to 6 GHz v01. These additional measurements are repeated after the completion of all measurements requiring the same head or body tissue-equivalent medium in a frequency band. The test device should be returned to ambient conditions (normal room temperature) with the battery fully charged before it is re-mounted on the device holder for the repeated measurement(s) to minimize any unexpected variations in the repeated results

- 1) Repeated measurement is not required when the original highest measured SAR is < 0.80 W/kg.
- 2) When the original highest measured SAR is ≥ 0.80 W/kg, repeat that measurement once.
- 3) Perform a second repeated measurement only if the ratio of largest to smallest SAR for the original and first repeated measurements is > 1.20 or when the original or repeated measurement is ≥ 1.45 W/kg (~ 10% from the 1-g SAR limit).
- 4) Perform a third repeated measurement only if the original, first or second repeated measurement is ≥ 1.5 W/kg and the ratio of largest to smallest SAR for the original, first and second repeated measurements is > 1.20.
- 5) The same procedures should be adapted for measurements according to occupational exposure limits by applying a factor of 2.5 for extremity exposure and a factor of 5 for occupational exposure to the corresponding SAR thresholds.

Note: The same procedures should be adapted for measurements according to extremity and occupational exposure limits by applying a factor of 2.5 for extremity exposure and a factor of 5 for occupational exposure to the corresponding SAR thresholds.

The Highest Measured SAR Configuration in Each Frequency Band

Head(Face Up)

Frequency Band	Freq.(MHz)	EUT Position	Meas. SAR (W/kg)		Largest to Smallest SAR Ratio
			Original	Repeated	
(350-550 MHz) PTT_FM 12.5kHz	435	Face Up	7.21	7.06	1.03

Body(Body Back)

Frequency Band	Freq.(MHz)	EUT Position	Meas. SAR (W/kg)		Largest to Smallest SAR Ratio
			Original	Repeated	
(350-550 MHz) PTT_FM 12.5kHz	469	Body Back	11.3	11	1.03

Note:

1. Second Repeated Measurement is not required since the ratio of the largest to smallest SAR for the original and first repeated measurement is not > 1.20.
2. The measured SAR results **do not** have to be scaled to the maximum tune-up tolerance to determine if repeated measurements are required.
3. SAR measurement variability must be assessed for each frequency band, which is determined by the **SAR probe calibration point and tissue-equivalent medium** used for the device measurements.

SAR Plots

Please Refer to the Attachment.

APPENDIX A MEASUREMENT UNCERTAINTY

The uncertainty budget has been determined for the measurement system and is given in the following Table.

Measurement uncertainty evaluation for IEEE1528-2013 SAR test

Source of uncertainty	Tolerance/uncertainty ± %	Probability distribution	Divisor	ci (1 g)	ci (10 g)	Standard uncertainty ± %, (1 g)	Standard uncertainty ± %, (10 g)
Measurement system							
Probe calibration	6.55	N	1	1	1	6.6	6.6
Axial Isotropy	4.7	R	√3	1	1	2.7	2.7
Hemispherical Isotropy	9.6	R	√3	0	0	0.0	0.0
Boundary effect	1.0	R	√3	1	1	0.6	0.6
Linearity	4.7	R	√3	1	1	2.7	2.7
Detection limits	1.0	R	√3	1	1	0.6	0.6
Readout electronics	0.3	N	1	1	1	0.3	0.3
Response time	0.0	R	√3	1	1	0.0	0.0
Integration time	0.0	R	√3	1	1	0.0	0.0
RF ambient conditions – noise	1.0	R	√3	1	1	0.6	0.6
RF ambient conditions–reflections	1.0	R	√3	1	1	0.6	0.6
Probe positioner mech. Restrictions	0.8	R	√3	1	1	0.5	0.5
Probe positioning with respect to phantom shell	6.7	R	√3	1	1	3.9	3.9
Post-processing	2.0	R	√3	1	1	1.2	1.2
Test sample related							
Test sample positioning	2.8	N	1	1	1	2.8	2.8
Device holder uncertainty	6.3	N	1	1	1	6.3	6.3
Drift of output power	5.0	R	√3	1	1	2.9	2.9
Phantom and set-up							
Phantom uncertainty (shape and thickness tolerances)	4.0	R	√3	1	1	2.3	2.3
Liquid conductivity target)	5.0	R	√3	0.64	0.43	1.8	1.2
Liquid conductivity meas.)	2.5	N	1	0.64	0.43	1.6	1.1
Liquid permittivity target)	5.0	R	√3	0.6	0.49	1.7	1.4
Liquid permittivity meas.)	2.5	N	1	0.6	0.49	1.5	1.2
Combined standard uncertainty		RSS				12.2	12.0
Expanded uncertainty 95 % confidence interval)						24.3	23.9

Measurement uncertainty evaluation for IEC62209-2 SAR test

Source of uncertainty	Tolerance/uncertainty ± %	Probability distribution	Divisor	ci (1 g)	ci (10 g)	Standard uncertainty ± %, (1 g)	Standard uncertainty ± %, (10 g)
Measurement system							
Probe calibration	6.55	N	1	1	1	6.6	6.6
Axial Isotropy	4.7	R	√3	1	1	2.7	2.7
Hemispherical Isotropy	9.6	R	√3	0	0	0.0	0.0
Linearity	4.7	R	√3	1	1	2.7	2.7
Modulation Response	0.0	R	√3	1	1	0.0	0.0
Detection limits	1.0	R	√3	1	1	0.6	0.6
Boundary effect	1.0	R	√3	1	1	0.6	0.6
Readout electronics	0.3	N	1	1	1	0.3	0.3
Response time	0.0	R	√3	1	1	0.0	0.0
Integration time	0.0	R	√3	1	1	0.0	0.0
RF ambient conditions – noise	1.0	R	√3	1	1	0.6	0.6
RF ambient conditions–reflections	1.0	R	√3	1	1	0.6	0.6
Probe positioner mech. Restrictions	0.8	R	√3	1	1	0.5	0.5
Probe positioning with respect to phantom shell	6.7	R	√3	1	1	3.9	3.9
Post-processing	2.0	R	√3	1	1	1.2	1.2
Test sample related							
Device holder Uncertainty	6.3	N	1	1	1	6.3	6.3
Test sample positioning	2.8	N	1	1	1	2.8	2.8
Power scaling	4.5	R	√3	1	1	2.6	2.6
Drift of output power	5.0	R	√3	1	1	2.9	2.9
Phantom and set-up							
Phantom uncertainty (shape and thickness tolerances)	4.0	R	√3	1	1	2.3	2.3
Algorithm for correcting SAR for deviations in permittivity and conductivity	1.9	N	1	1	0.84	1.1	0.9
Liquid conductivity (meas.)	2.5	N	1	0.64	0.43	1.6	1.1
Liquid permittivity (meas.)	2.5	N	1	0.6	0.49	1.5	1.2
Temp. unc. - Conductivity	1.7	R	√3	0.78	0.71	0.8	0.7
Temp. unc. - Permittivity	0.3	R	√3	0.23	0.26	0.0	0.0
Combined standard uncertainty		RSS				12.2	12.1
Expanded uncertainty 95 % confidence interval)						24.5	24.2

APPENDIX B EUT TEST POSITION PHOTOS

Please Refer to the Attachment.

APPENDIX C CALIBRATION CERTIFICATES

Please Refer to the Attachment.

******* END OF REPORT *******