



中认信通
CHINA CERTIFICATION ICT CO., LTD (DONGGUAN)



TEST REPORT

Applicant: Hytera Communications Corporation Limited

Address: Hytera Tower, Hi-Tech Industrial Park North, 9108# Beihuan Road,
Nanshan District, Shenzhen, 518057 China

FCC ID: YAMMD612VHF

Product Name: Digital Mobile Radio

**Model Number: MD612 VHF, MD615 VHF, MD616 VHF,
MD618 VHF, MD619 VHF, MD622 VHF,
MD625 VHF, MD626 VHF, MD628 VHF,
MD629 VHF, MD61X, MD62X**

**Standard(s): FCC PART 22, 74, 80 and 90
ANSI C63.26-2015
TIA-603-E-2016**

The above equipment has been tested and found compliant with the requirement of the relative standards by China Certification ICT Co., Ltd (Dongguan)

Report Number: CR22080001-00D

Date Of Issue: 2022-09-16

Reviewed By: Sun Zhong

Sun Zhong

Title: Manager

Test Laboratory: China Certification ICT Co., Ltd (Dongguan)

No. 113, Pingkang Road, Dalang Town, Dongguan,
Guangdong, China

Tel: +86-769-82016888

Test Facility

The Test site used by China Certification ICT Co., Ltd (Dongguan) to collect test data is located on the No. 113, Pingkang Road, Dalang Town, Dongguan, Guangdong, China.

The lab has been recognized as the FCC accredited lab under the KDB 974614 D01 and is listed in the FCC Public Access Link (PAL) database, FCC Registration No. : 442868, the FCC Designation No. : CN1314.

The lab has been recognized by Innovation, Science and Economic Development Canada to test to Canadian radio equipment requirements, the CAB identifier: CN0123.

Declarations

China Certification ICT Co., Ltd (Dongguan) is not responsible for the authenticity of any test data provided by the applicant. Data included from the applicant that may affect test results are marked with a triangle symbol “▲”. Customer model name, addresses, names, trademarks etc. are not considered data.

Unless otherwise stated the results shown in this test report refer only to the sample(s) tested.

This report cannot be reproduced except in full, without prior written approval of the Company.

This report is valid only with a valid digital signature. The digital signature may be available only under the Adobe software above version 7.0.

This report may contain data that are not covered by the accreditation scope and shall be marked with an asterisk “★”.

CONTENTS

TEST FACILITY	2
DECLARATIONS.....	2
1. GENERAL INFORMATION	5
1.1 PRODUCT DESCRIPTION FOR EQUIPMENT UNDER TEST (EUT)	5
1.2 DESCRIPTION OF TEST CONFIGURATION.....	7
1.2.2 Support Equipment List and Details	7
1.2.3 Support Cable List and Details	7
1.2.4 Block Diagram of Test Setup.....	8
1.3 MEASUREMENT UNCERTAINTY	9
2. SUMMARY OF TEST RESULTS	10
3. REQUIREMENTS AND TEST PROCEDURES	11
3.1 TRANSMITTER FREQUENCY STABILITY	11
3.1.1 Applicable Standard.....	11
3.1.2 Test Procedure	12
3.1.3 EUT Setup Block Diagram	13
3.2 TRANSMITTER OUTPUT POWER	14
3.2.1 Applicable Standard.....	14
3.2.2 Test Procedure	15
3.2.3 EUT Setup Block Diagram	15
3.3 OCCUPIED BANDWIDTH & EMISSION MASK.....	16
3.3.1 Applicable Standard.....	16
3.3.2 Test Procedure	17
3.3.3 EUT Setup Block Diagram	19
3.4 TRANSMITTER UNWANTED EMISSIONS(CONDUCTED).....	20
3.4.1 Applicable Standard.....	20
3.4.2 Test Procedure	21
3.4.3 EUT Setup Block Diagram	22
3.5 TRANSIENT FREQUENCY BEHAVIOR	23
3.5.1 Applicable Standard.....	23
3.5.2 Test Procedure	23
3.6 MODULATION CHARACTERISTICS.	25
3.6.1 Applicable Standard.....	25
3.6.2 Test Procedure	25
3.6.3 EUT Setup Block Diagram	26
3.7 TRANSMITTER UNWANTED EMISSIONS(RADIATED)	27
3.7.1 Applicable Standard.....	27
4. Test DATA AND RESULTS	31
4.6 FREQUENCY STABILITY:.....	31
4.2 RF OUTPUT POWER.....	33
4.3 OCCUPIED BANDWIDTH & EMISSION MASK:	39
4.4 SPURIOUS EMISSIONS AT ANTENNA TERMINALS:	51
4.5 MODULATION CHARACTERISTIC:.....	57

4.6 TRANSIENT FREQUENCY BEHAVIOR.....62
4.7 RADIATED SPURIOUS EMISSIONS:64

1. GENERAL INFORMATION

1.1 Product Description for Equipment under Test (EUT)

EUT Name:	Digital Mobile Radio
EUT Model:	MD612 VHF,MD622 VHF
Multiple Models:	MD615 VHF, MD616 VHF, MD618 VHF, MD619 VHF, MD625 VHF, MD626 VHF, MD628 VHF, MD629 VHF, MD61X, MD62X
Operation Frequency:	136-174 MHz
Modulation Type:	FM, 4FSK
Channel Spacing:	12.5 kHz /25 kHz
Rated Output Power: (Conducted)	High Power Level: 50W Low Power Level: 5W
Rated Input Voltage:	DC 13.6V from Vehicle Battery
Serial Number:	CR22080001-RF-S1(Model: MD612 VHF) CR22080001-RF-S2(Model: MD622 VHF)
EUT Received Date:	2022.08.02
EUT Received Status:	Good
<p>Note: The Multiple models are electrically identical with the test model. Please refer to the declaration letter for more detail, which was provided by manufacturer. All tests were performed with model: MD612 VHF, except Radiation emission below 1GHz was tested with model: MD612 VHF, MD622 VHF.</p>	

Accessory Information:

Accessory Description	Manufacturer	Model	Parameters
Hand microphone	Hytera Communications Corporation Limited	Unknown	Unknown
GPS Antenna		Unknown	Unknown
GPS Module		Unknown	Unknown

Antenna Information Detail▲:

Antenna	Antenna Manufacturer	Antenna Type	input impedance (Ohm)	Antenna Gain /Frequency Range
Antenna 1	KENBOTONG TECHNOLOGY CO., LTD.	Helical	50	0 dBi/136-174MHz

Test Frequency Detail:

Per C63.26-2015, section 5.1, the frequencies below was performed for test:

Modulation/ Channel Bandwidth	Test Channel	Frequency (MHz)	Rule Part
FM 12.5kHz	Lowest	136.0125	For Federal
	Middle	155.7525	For Part 90
	Highest	173.9875	For Federal
	Additional	161.1000	For Part 74
	Additional	150.8125	For Part 22
4FSK 12.5kHz	Lowest	136.0125	For Federal
	Middle	155.7525	For Part 90
	Highest	173.9875	For Federal
	Additional	161.1000	For Part 74
	Additional	150.8125	For Part 22
FM 25kHz	Additional	161.1000	For Part 74
	Additional	150.8125	For Part 22
	Additional	154.0125	For Part 80

1.2 Description of Test Configuration

1.2.1 EUT Operation Condition:

EUT Operation Mode:	The system was configured for testing in Engineering Mode, which was provided by the manufacturer.
Equipment Modifications:	No
EUT Exercise Software:	KL_CPS_V2.1.01.003
The software was provided by manufacturer.	

1.2.2 Support Equipment List and Details

Manufacturer	Description	Model	Serial Number
api	Load	50oml	50oml Load
BEW	Coaxial Attenuator	TS300-6-40	213311
ZHAOXIN	DC Power Supply	RXN-6010D	21R6010D0912386

1.2.3 Support Cable List and Details

Cable Description	Shielding Cable	Ferrite Core	Length (m)	From Port	To
RF Cable	Yes	No	0.2	EUT	Attenuator
DC Power Cable	No	No	2.0	DC Power Supply	EUT
Hand Microphone Cable	No	No	1.2	EUT	Hand Microphone
GPS Module Cable	Yes	No	0.8	EUT	GPS Module
GPS RF Cable	Yes	No	1.2	GPS Module	GPS Antenna

1.2.4 Block Diagram of Test Setup

Radiation Emission Test:

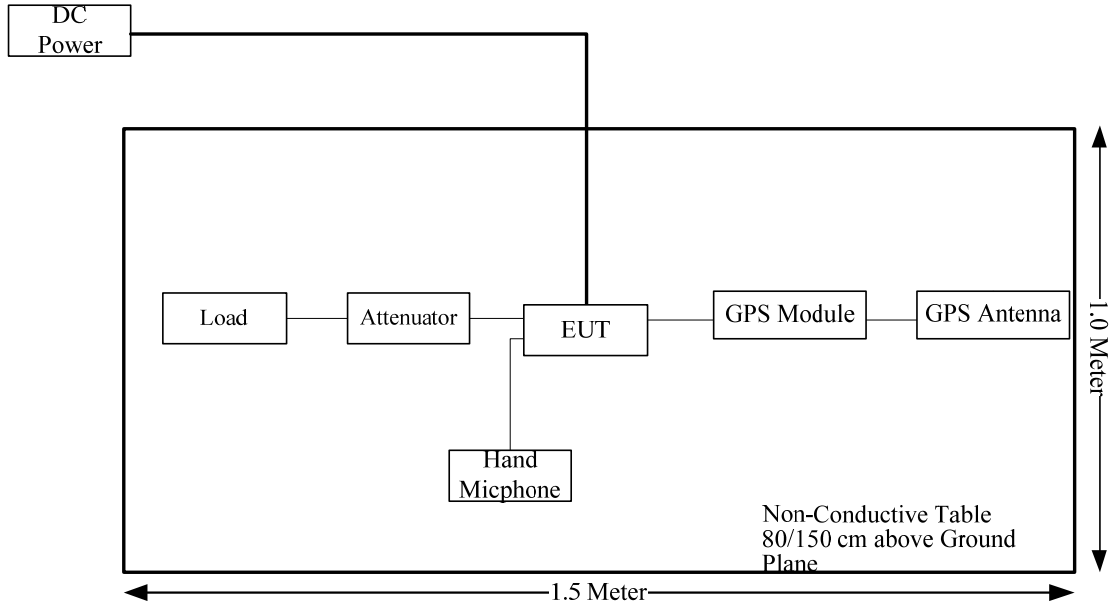

1.3 Measurement Uncertainty

Otherwise required by the applicant or Product Regulations, Decision Rule in this report did not consider the uncertainty. The extended uncertainty given in this report is obtained by combining the standard uncertainty times the coverage factor K with the 95% confidence interval.

Parameter	Measurement Uncertainty
Occupied Channel Bandwidth	±5 %
RF output power, conducted	±0.61dB
Power Spectral Density, conducted	±0.61 dB
Unwanted Emissions, radiated	30M~200MHz: 4.15 dB,200M~1GHz: 5.61 dB,1G~6GHz: 5.14 dB, 6G~18GHz: 5.93 dB,18G~26.5G:5.47 dB,26.5G~40G:5.63 dB
Unwanted Emissions, conducted	±1.26 dB
Temperature	±1 °C
Humidity	±5%
DC and low frequency voltages	±0.4%
Duty Cycle	1%
RF Frequency	±0.082×10 ⁻⁶
Audio Frequency/Low Pass Filter Response	4.02%
Modulation Limiting	1.19%

2. SUMMARY OF TEST RESULTS

Standard/Rule(s)	Description of Test	Results
§2.1055; § 22.355; §74.464; §80.209; §90.213	Frequency Stability	Compliant
§2.1046; § 22.727; §80.215; §74.461; §90.205	RF Output Power	Compliant
§2.1049;§22.357;§ 22.731; §74.462;§80.205; §80.207 §90.209; §90.210	Occupied Bandwidth & Emission Mask	Compliant
§2.1051; §22.861; §74.462; §80.211;§90.210	Spurious Emission at Antenna Terminal	Compliant
§2.1053;§22.861; §74.462;§80.211;§90.210	Spurious Radiated Emissions	Compliant
§90.214	Transient Frequency Behavior	Compliant
§2.1047	Modulation Characteristic	Compliant

3. REQUIREMENTS AND TEST PROCEDURES

3.1 Transmitter Frequency Stability

3.1.1 Applicable Standard

FCC §90.213

In the 150-174 MHz band, fixed and base stations with a 12.5 kHz channel bandwidth must have a frequency stability of 2.5 ppm. Fixed and base stations with a 6.25 kHz channel bandwidth must have a frequency stability of 1.0 ppm.

In the 150-174 MHz band, mobile stations designed to operate with a 12.5 kHz channel bandwidth or designed to operate on a frequency specifically designated for itinerant use or designed for low-power operation of two watts or less, must have a frequency stability of 5.0 ppm. Mobile stations designed to operate with a 6.25 kHz channel bandwidth must have a frequency stability of 2.0 ppm.

In the 421-512 MHz band, mobile stations designed to operate with a 12.5 kHz channel bandwidth must have a frequency stability of 2.5 ppm. Mobile stations designed to operate with a 6.25 kHz channel bandwidth must have a frequency stability of 1.0 ppm.

FCC §22.355

Except as otherwise provided in this part, the carrier frequency of each transmitter in the Public Mobile Services must be maintained within the tolerances given in Table C-1 of this section.

Table C-1 - Frequency Tolerance for Transmitters in the Public Mobile Services

Frequency range (MHz)	Base, fixed (ppm)	Mobile >3 watts (ppm)	Mobile ≤3 watts (ppm)
25 to 50	20.0	20.0	50.0
50 to 450	5.0	5.0	50.0
450 to 512	2.5	5.0	5.0
821 to 896	1.5	2.5	2.5
928 to 929	5.0	n/a	n/a
929 to 960	1.5	n/a	n/a
2110 to 2220	10.0	n/a	n/a

FCC §74.464

For operations on frequencies above 25 MHz using authorized bandwidths up to 30 kHz, the licensee of a remote pickup broadcast station or system shall maintain the operating frequency of each station in compliance with the frequency tolerance requirements of §90.213 of this chapter. For all other operations, the licensee of a remote pickup broadcast station or system shall maintain the operating frequency of each station in accordance with the following:

Frequency range	Tolerance (percent)	
	Base station	Mobile station
25 to 30 MHz:		
3 W or less	.002	.005
Over 3 W	.002	.002
30 to 300 MHz:		
3 W or less	.0005	.005
Over 3 W	.0005	.0005
300 to 500 MHz, all powers	.00025	.0005

FCC §80.209

- (a) The frequency tolerance requirements applicable to transmitters in the maritime services are shown in the following table. Tolerances are given as parts in 10^6 unless shown in Hz.

Frequency bands and categories of stations	Tolerances ¹
(5) Band 156-162 MHz:	
(i) Coast stations:	
For carriers licensed to operate with a carrier power:	
Below 3 watts	10.
3 to 100 watts	5. ⁷
(ii) Ship stations	10. ⁴
(iii) Survival craft stations operating on 121.500 MHz	50.
(iv) EPIRBs:	
(7) Band 400-466 MHz:	
(i) EPIRBs operating on 406-406.1 MHz	5.
(ii) On-board stations	5.
(iii) Radiolocation and telecommand stations.	5.

3.1.2 Test Procedure

Frequency Stability vs. Temperature: The equipment under test was connected to an external power supply and the RF output was connected to a frequency counter via feed-through attenuators. The EUT was placed inside the temperature chamber. The DC or AC leads and RF output cable exited the chamber through an opening made for the purpose.

After the temperature stabilized for approximately 20 minutes, the frequency output was recorded from the counter.

3.1.3 EUT Setup Block Diagram

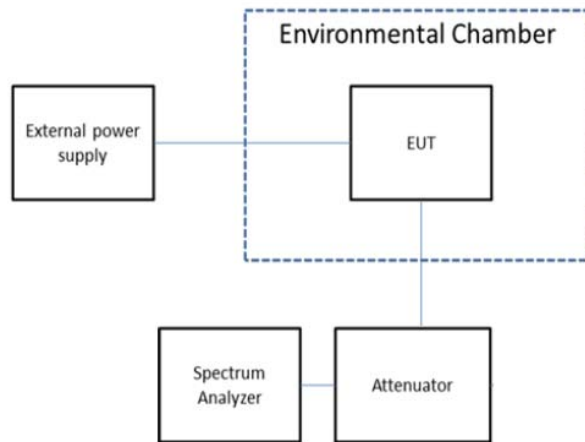

3.2 Transmitter Output Power

3.2.1 Applicable Standard

FCC §90.205

(d) 150-174 MHz. (1) The maximum allowable station ERP is dependent upon the station's antenna HAAT and required service area and will be authorized in accordance with table 1. Applicants requesting an ERP in excess of that listed in table 1 must submit an engineering analysis based upon generally accepted engineering practices and standards that includes coverage contours to demonstrate that the requested station parameters will not produce coverage in excess of that which the applicant requires.

(h) 450-470 MHz.

(1) The maximum allowable station effective radiated power (ERP) is dependent upon the station's antenna HAAT and required service area and will be authorized in accordance with table 2. Applicants requesting an ERP in excess of that listed in table 2 must submit an engineering analysis based upon generally accepted engineering practices and standards that includes coverage contours to demonstrate that the requested station parameters will not produce coverage in excess of that which the applicant requires.

(2) Applications for stations where special circumstances exist that make it necessary to deviate from the ERP and antenna heights in Table 2 will be submitted to the frequency coordinator accompanied by a technical analysis, based upon generally accepted engineering practices and standards, that demonstrates that the requested station parameters will not produce a signal strength in excess of 39 dBu at any point along the edge of the requested service area. The coordinator may then recommend any ERP appropriate to meet this condition.

(3) An applicant for a station with a service area radius greater than 32 km (20 mi) must justify the requested service area radius, which may be authorized only in accordance with table 2, note 4. For base stations with service areas greater than 80 km, all operations 80 km or less from the base station will be on a primary basis and all operations outside of 80 km from the base station will be on a secondary basis and will be entitled to no protection from primary operations.

(s) The output power shall not exceed by more than 20 percent either the output power shown in the Radio Equipment List [available in accordance with §90.203(a)(1)] for transmitters included in this list or when not so listed, the manufacturer's rated output power for the particular transmitter specifically listed on the authorization.

FCC §22.727

(a) *Maximum ERP.* The effective radiated power (ERP) of central office and rural subscriber station transmitters must not exceed the applicable limits in this paragraph under any circumstances.

Frequency range (MHz)	Maximum ERP (watts)
152-153	1400
157-159	150
454-455	3500
459-460	150

FCC §74.461

(a) Transmitter power is the power at the transmitter output terminals and delivered to the antenna, antenna transmission line, or any other impedance-matched, radio frequency load. For the purpose of this Subpart, the transmitter power is the carrier power.

(b) The authorized transmitter power for a remote pickup broadcast station shall be limited to that necessary for satisfactory service and, in any event, shall not be greater than 100 watts, except that a station to be operated aboard an aircraft shall normally be limited to a maximum authorized power of 15 watts. Specific authorization to operate stations on board aircraft with an output power exceeding 15 watts will be issued only upon an adequate engineering showing of need, and of the procedures that will be taken to avoid harmful interference to other licensees.

FCC §80.215

(e)(3) On board stations 456-468 MHz - 4W

(m) For radiodetermination transmitters using A1D, A2D, F1D, F2D, G1D and G2D emissions on 154.585 MHz, 159.480 MHz, 160.725 MHz, 160.785 MHz, 454.000 MHz and 459.000 MHz the mean output power of the unmodulated carrier must not exceed 25 watts.

3.2.2 Test Procedure

Before performing this measurement, the power of the EUT shall be set or controlled to the maximum rating of the range for which equipment certification or verification is sought.

Except where otherwise specified, tests shall be performed at the ambient temperature, at the manufacturer's rated supply voltage, and with the transmitter modulating signal representative (i.e. typical) of those encountered in a real system operation.

The spectrum analyzer shall be configured with a resolution bandwidth that encompasses the entire occupied bandwidth (see section 6.7) of the EUT. If the spectrum analyzer's largest available resolution bandwidth is smaller than the occupied bandwidth of the EUT, it is permitted to use a narrower resolution bandwidth plus numerical integration, in linear power terms, over the occupied bandwidth of the transmitter in order to measure its output power, except when the emission is a wideband noise-like signal and being measured for peak power. For transmitters with constant envelope modulation, RF output power and field strength measurements performed on the fundamental frequency can be carried out with an unmodulated carrier. The method used shall be described in the test report.

3.2.3 EUT Setup Block Diagram

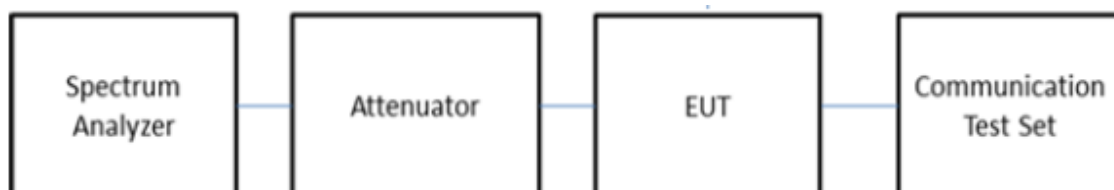

3.3 Occupied Bandwidth & Emission Mask

3.3.1 Applicable Standard

FCC §90.209

(a) Each authorization issued to a station licensed under this part will show an emission designator representing the class of emission authorized. The designator will be prefixed by a specified necessary bandwidth. This number does not necessarily indicate the bandwidth occupied by the emission at any instant. In those cases where §2.202 of this chapter does not provide a formula for the computation of necessary bandwidth, the occupied bandwidth, as defined in part 2 of this chapter, may be used in lieu of the necessary bandwidth.

(b) (5) Unless specified elsewhere, channel spacings and bandwidths that will be authorized in the following frequency bands are given in the following table: STANDARD CHANNEL SPACING/BANDWIDTH

FCC §90.210

Emission Mask D—12.5 kHz channel bandwidth equipment. For transmitters designed to operate with a 12.5 kHz channel bandwidth, any emission must be attenuated below the power (P) of the highest emission contained within the authorized bandwidth as follows:

- (1) On any frequency from the center of the authorized bandwidth f_0 to 5.625 kHz removed from f_0 : Zero dB.
- (2) On any frequency removed from the center of the authorized bandwidth by a displacement frequency (f_d in kHz) of more than 5.625 kHz but no more than 12.5 kHz: At least $7.27(f_d - 2.88 \text{ kHz})$ dB.
- (3) On any frequency removed from the center of the authorized bandwidth by a displacement frequency (f_d in kHz) of more than 12.5 kHz: At least $50 + 10 \log (P)$ dB or 70 dB, whichever is the lesser attenuation.
- (4) The reference level for showing compliance with the emission mask shall be established using a resolution bandwidth sufficiently wide (usually two or three times the channel bandwidth) to capture the true peak emission of the equipment under test. In order to show compliance with the emission mask up to and including 50 kHz removed from the edge of the authorized bandwidth, adjust the resolution bandwidth to 100 Hz with the measuring instrument in a peak hold mode. A sufficient number of sweeps must be measured to insure that the emission profile is developed. If video filtering is used, its bandwidth must not be less than the instrument resolution bandwidth. For emissions beyond 50 kHz from the edge of the authorized bandwidth, see paragraph (o) of this section. If it can be shown that use of the above instrumentation settings do not accurately represent the true interference potential of the equipment under test, an alternate procedure may be used provided prior Commission approval is obtained.

FCC §22.359

(a) *Out of band emissions.* The power of any emission outside of the authorized operating frequency ranges must be attenuated below the transmitting power (P) by a factor of at least $43 + 10 \log (P)$ dB.

(b) *Measurement procedure.* Compliance with these rules is based on the use of measurement instrumentation employing a resolution bandwidth of 30 kHz or more. In the 60 kHz bands immediately outside and adjacent to the authorized frequency range or channel, a resolution bandwidth of at least one percent of the emission bandwidth of the fundamental emission of the transmitter may be employed. A narrower resolution bandwidth is permitted in all cases to improve measurement accuracy provided the measured power is integrated over the full required measurement bandwidth (i.e., 30 kHz or 1 percent of emission bandwidth, as specified). The emission bandwidth is defined as the width of the signal between two points, one below the carrier center frequency and one above the carrier center frequency, outside of which all emissions are attenuated at least 26 dB below the transmitter power.

FCC §74.462

(a) Each authorization for a new remote pickup broadcast station or system shall require the use of certificated equipment and such equipment shall be operated in accordance with emission specifications included in the grant of certification and as prescribed in paragraphs (b), (c), and (d) of this section.

FCC §80.205

(a) An emission designator shows the necessary bandwidth for each class of emission of a station except that in ship earth stations it shows the occupied or necessary bandwidth, whichever is greater. The following table gives the class of emission and corresponding emission designator and authorized bandwidth:

Class of emission	Emission designator	Authorized bandwidth (kHz)
F3E ^B	16KOF3E	20.0

FCC §80.211

The mean power when using emissions other than those in paragraphs (a), (b), (c) and (d) of this section:

- (1) On any frequency removed from the assigned frequency by more than 50 percent up to and including 100 percent of the authorized bandwidth: At least 25 dB;
- (2) On any frequency removed from the assigned frequency by more than 100 percent up to and including 250 percent of the authorized bandwidth: At least 35 dB; and
- (3) On any frequency removed from the assigned frequency by more than 250 percent of the authorized bandwidth: At least $43 + 10 \log_{10}$ (mean power in watts) dB.

3.3.2 Test Procedure

The occupied bandwidth or the “99% emission bandwidth” is defined as the frequency range between two points, one above and the other below the carrier frequency, within which 99% of the total transmitted power of the fundamental transmitted emission is contained. The occupied bandwidth shall be reported for all equipment in addition to the specified bandwidth required in the applicable RSSs.

In some cases, the “x dB bandwidth” is required, which is defined as the frequency range between two points, one at the lowest frequency below and one at the highest frequency above the carrier frequency, at which the maximum power level of the transmitted emission is attenuated x dB below the maximum in-band power level of the modulated signal, where the two points are on the outskirts of the in-band emission.

The following conditions shall be observed for measuring the occupied bandwidth and x dB bandwidth:

- The transmitter shall be operated at its maximum carrier power measured under normal test conditions.
- The span of the spectrum analyzer shall be set large enough to capture all products of the modulation process, including the emission skirts, around the carrier frequency, but small enough to avoid having other emissions (e.g. on adjacent channels) within the span.
- The detector of the spectrum analyzer shall be set to “Sample”. However, a peak, or peak hold, may be used in place of the sampling detector since this usually produces a wider bandwidth than the actual bandwidth (worst-case measurement). Use of a peak hold (or “Max Hold”) may be necessary to determine the occupied / x dB bandwidth if the device is not transmitting continuously.
- The resolution bandwidth (RBW) shall be in the range of 1% to 5% of the actual occupied / x dB bandwidth and the video bandwidth (VBW) shall not be smaller than three times the RBW value. Video averaging is not permitted.

Note: It may be necessary to repeat the measurement a few times until the RBW and VBW are in compliance with the above requirement.

For the 99% emission bandwidth, the trace data points are recovered and directly summed in linear power level terms. The recovered amplitude data points, beginning at the lowest frequency, are placed in a running sum until 0.5% of the total is reached, and that frequency recorded. The process is repeated for the highest frequency data points (starting at the highest frequency, at the right side of the span, and going down in frequency). This frequency is then recorded. The difference between the two recorded frequencies is the occupied bandwidth (or the 99% emission bandwidth).

Emission Mask D for Transmitters Equipped With or Without an Audio Low-Pass Filter

The power of any emission shall be attenuated below the transmitter output power P (dBW) as specified in Table.

Displacement Frequency, f_d (kHz)	Minimum Attenuation (dB)	Resolution Bandwidth (Hz)
$5.625 < f_d \leq 12.5$	$7.27(f_d - 2.88)$	Specified in Section 4.2.2
$f_d > 12.5$	Whichever is the lesser: 70 or $50 + 10 \log_{10}(p)$	Specified in Section 4.2.2

In order to show compliance with the emission mask up to and including 50 kHz removed from the edge of the authorized bandwidth, adjust the resolution bandwidth to 100 Hz with the measuring instrument in a peak mode. For emissions beyond 50 kHz from the edge of the authorized bandwidth, the resolution bandwidth shall be 100 kHz for frequencies at or below 1 GHz, and 1 MHz for frequencies above 1 GHz. However, for emission mask F, at a displacement frequency of less than 3.75 kHz, the resolution bandwidth shall be 30 Hz.

3.3.3 EUT Setup Block Diagram

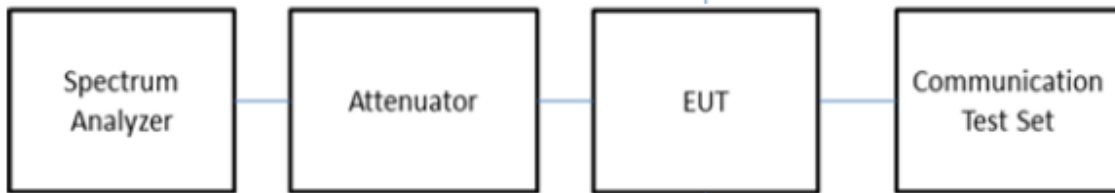

3.4 Transmitter Unwanted Emissions(Conducted)

3.4.1 Applicable Standard

FCC §90.210

Emission Mask D—12.5 kHz channel bandwidth equipment. For transmitters designed to operate with a 12.5 kHz channel bandwidth, any emission must be attenuated below the power (P) of the highest emission contained within the authorized bandwidth as follows:

- (5) On any frequency from the center of the authorized bandwidth f_0 to 5.625 kHz removed from f_0 : Zero dB.
- (6) On any frequency removed from the center of the authorized bandwidth by a displacement frequency (f_d in kHz) of more than 5.625 kHz but no more than 12.5 kHz: At least $7.27(f_d - 2.88 \text{ kHz})$ dB.
- (7) On any frequency removed from the center of the authorized bandwidth by a displacement frequency (f_d in kHz) of more than 12.5 kHz: At least $50 + 10 \log(P)$ dB or 70 dB, whichever is the lesser attenuation.
- (8) The reference level for showing compliance with the emission mask shall be established using a resolution bandwidth sufficiently wide (usually two or three times the channel bandwidth) to capture the true peak emission of the equipment under test. In order to show compliance with the emission mask up to and including 50 kHz removed from the edge of the authorized bandwidth, adjust the resolution bandwidth to 100 Hz with the measuring instrument in a peak hold mode. A sufficient number of sweeps must be measured to insure that the emission profile is developed. If video filtering is used, its bandwidth must not be less than the instrument resolution bandwidth. For emissions beyond 50 kHz from the edge of the authorized bandwidth, see paragraph (o) of this section. If it can be shown that use of the above instrumentation settings do not accurately represent the true interference potential of the equipment under test, an alternate procedure may be used provided prior Commission approval is obtained.

FCC §22.359

- (a) *Out of band emissions.* The power of any emission outside of the authorized operating frequency ranges must be attenuated below the transmitting power (P) by a factor of at least $43 + 10 \log(P)$ dB.
- (b) *Measurement procedure.* Compliance with these rules is based on the use of measurement instrumentation employing a resolution bandwidth of 30 kHz or more. In the 60 kHz bands immediately outside and adjacent to the authorized frequency range or channel, a resolution bandwidth of at least one percent of the emission bandwidth of the fundamental emission of the transmitter may be employed. A narrower resolution bandwidth is permitted in all cases to improve measurement accuracy provided the measured power is integrated over the full required measurement bandwidth (i.e., 30 kHz or 1 percent of emission bandwidth, as specified). The emission bandwidth is defined as the width of the signal between two points, one below the carrier center frequency and one above the carrier center frequency, outside of which all emissions are attenuated at least 26 dB below the transmitter power.

FCC §74.462

(c) For emissions on frequencies above 25 MHz with authorized bandwidths up to 30 kHz, the emissions shall comply with the emission mask and transient frequency behavior requirements of §§90.210 and 90.214 of this chapter. For all other emissions, the mean power of emissions shall be attenuated below the mean output power of the transmitter in accordance with the following schedule:

- (1) On any frequency removed from the assignment frequency by more than 50 percent up to and including 100 percent of the authorized bandwidth: at least 25 dB;
- (2) On any frequency removed from the assigned frequency by more than 100 percent up to and including 250 percent of the authorized bandwidth: at least 35 dB;
- (3) On any frequency removed from the assigned frequency by more than 250 percent on the authorized bandwidth; at least 43 plus $10 \log_{10}$ (mean output power, in watts) dB.

FCC §80.211

The mean power when using emissions other than those in paragraphs (a), (b), (c) and (d) of this section:

- (1) On any frequency removed from the assigned frequency by more than 50 percent up to and including 100 percent of the authorized bandwidth: At least 25 dB;
- (2) On any frequency removed from the assigned frequency by more than 100 percent up to and including 250 percent of the authorized bandwidth: At least 35 dB; and
- (3) On any frequency removed from the assigned frequency by more than 250 percent of the authorized bandwidth: At least 43 plus $10 \log_{10}$ (mean power in watts) dB.

3.4.2 Test Procedure

In order to show compliance with the emission mask up to and including 50 kHz removed from the edge of the authorized bandwidth, adjust the resolution bandwidth to 100 Hz with the measuring instrument in a peak mode. For emissions beyond 50 kHz from the edge of the authorized bandwidth, the resolution bandwidth shall be 100 kHz for frequencies at or below 1 GHz, and 1 MHz for frequencies above 1 GHz. However, for emission mask F, at a displacement frequency of less than 3.75 kHz, the resolution bandwidth shall be 30 Hz.

In measuring unwanted emissions, the spectrum shall be investigated from 30 MHz or the lowest radio frequency signal generated or used in the equipment, whichever is lower, without going below 9 kHz, up to at least the applicable frequency given below:

- (a) If the equipment operates below 10 GHz: to the tenth harmonic of the highest fundamental frequency or to 40 GHz, whichever is lower.
- (b) If the equipment operates at or above 10 GHz and below 30 GHz: to the fifth harmonic of the highest fundamental frequency or to 100 GHz, whichever is lower.
- (c) If the equipment operates at or above 30 GHz: to the fifth harmonic of the highest fundamental frequency or to 200 GHz, whichever is lower, unless specified otherwise in the applicable RSS.

(d) If the equipment contains a digital device that is exclusively used for enabling the operation of the radio apparatus: the spectrum shall be investigated according to the conditions specified in paragraphs (a) through (c) of this section or the range applicable to the digital device, as shown in table 2, whichever is the higher frequency range of investigation.

Table 2 – Frequency range for radiated measurement for equipment with a digital device

Highest frequency generated, operated or used in the equipment (MHz)	Upper frequency limit of measurement range (MHz)
< 1.705	30
1.705-108	1000
108-500	2000
500-1000	5000
> 1000	5 th harmonic of the highest frequency or 40 GHz, whichever is lower

It is not necessary to report the amplitude of spurious emissions attenuated more than 20 dB below the permissible value

3.4.3 EUT Setup Block Diagram

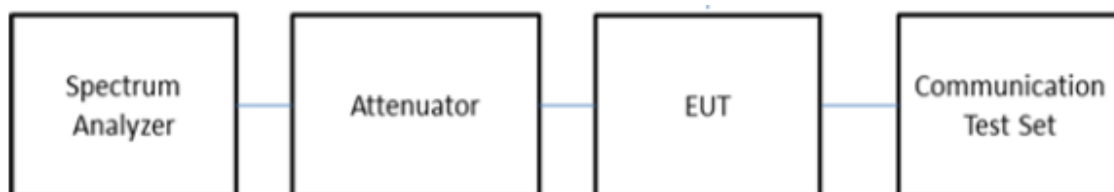

3.5 Transient Frequency Behavior

3.5.1 Applicable Standard

FCC §90.214

Transmitters designed to operate in the 150-174 MHz and 421-512 MHz frequency bands must maintain transient frequencies within the maximum frequency difference limits during the time intervals indicated:

Time intervals ^{1 2}	Maximum frequency difference ³	All equipment	
		150 to 174 MHz	421 to 512 MHz
Transient Frequency Behavior for Equipment Designed to Operate on 12.5 kHz Channels			
t_1 ⁴	±12.5 kHz	5.0 ms	10.0 ms
t_2	±6.25 kHz	20.0 ms	25.0 ms
t_3 ⁴	±12.5 kHz	5.0 ms	10.0 ms

3.5.2 Test Procedure

TIA-603-E Clause 2.2.19

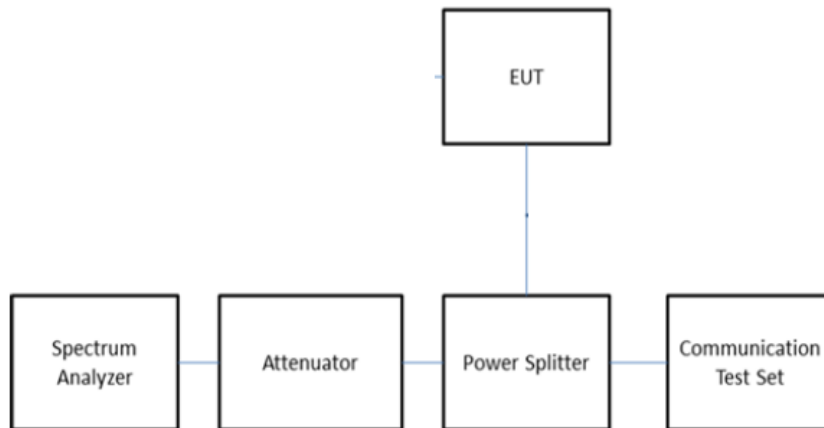

- Connect the equipment as illustrated.
- Connect the output of the standard transmitter load to the RF power meter. Supply sufficient attenuation via the RF attenuator to provide a level that is approximately 40 dB below the maximum allowable input to the modulation domain analyzer.
- Unkey the transmitter.
- Disconnect the RF power meter and connect the modulation domain analyzer in its place. Set the envelope trigger of the modulation domain analyzer to the minimum level that will trigger when the transmitter is keyed.
- Reduce the attenuation of the RF attenuator so that the input to the to the modulation domain analyzer is increased by 30 dB when the transmitter is keyed.
- Set the modulation domain analyzer to trigger on the rising edge of the waveform in order to capture a single-shot turn-on of the transmitter signal.
- Adjust the display of the modulation domain analyzer for proper viewing of the transmitter transient behavior. Set the timebase reference to the left for observing the transmitter turn-on transient.
- Key the transmitter.
- Observe the stored display of the modulation domain analyzer. The signal trace shall be maintained within the allowable limits during the periods t_1 and t_2 , and shall also remain within limits following t_2 .

- j) Adjust the modulation domain analyzer to trigger on the falling edge of the transmitter waveform in order to capture a single-shot turn-off transient of the transmitter signal.
- k) Adjust the display of the modulation domain analyzer for proper viewing of the transmitter transient behavior. Set the timebase reference to the right for observing the transmitter turn-off transient.
- l) Unkey the transmitter.
- m) Observe the stored display of the modulation domain analyzer. The signal trace shall be maintained within the allowable limits during the period t_3 .

3.6 Modulation characteristics.

3.6.1 Applicable Standard

FCC §2.1047

(a) Voice modulated communication equipment. A curve or equivalent data showing the frequency response of the audio modulating circuit over a range of 100 to 5000 Hz shall be submitted. For equipment required to have an audio low-pass filter, a curve showing the frequency response of the filter, or of all circuitry installed between the modulation limiter and the modulated stage shall be submitted.

(b) Equipment which employs modulation limiting. A curve or family of curves showing the percentage of modulation versus the modulation input voltage shall be supplied. The information submitted shall be sufficient to show modulation limiting capability throughout the range of modulating frequencies and input modulating signal levels employed.

(c) Single sideband and independent sideband radiotelephone transmitters which employ a device or circuit to limit peak envelope power. A curve showing the peak envelope power output versus the modulation input voltage shall be supplied. The modulating signals shall be the same in frequency as specified in paragraph (c) of §2.1049 for the occupied bandwidth tests.

(d) Other types of equipment. A curve or equivalent data which shows that the equipment will meet the modulation requirements of the rules under which the equipment is to be licensed.

3.6.2 Test Procedure

C63.26-2015, Clause 5.3.2 Modulation limiting test methodology

Modulation limiting is the ability of a transmitter circuit to limit the transmitter from producing deviations in excess of a rated system deviation.

- a) Connect the equipment as illustrated in Figure 1.
- b) Adjust the transmitter per the manufacturer's procedure for full rated system deviation.
- c) Set the test receiver to measure peak positive deviation. Set the audio bandwidth for ≤ 0.25 Hz to ≥ 15000 Hz. Turn the de-emphasis function off.
- d) Apply a 1000 Hz modulating signal to the transmitter from the audio frequency generator, and adjust the level to obtain 60% of full rated system deviation. This is the 0 dB reference level.
- e) Increase the level from the audio generator by 20 dB in 5 dB increments recording the deviation as measured from the test receiver in each step. Verify that the audio level used to make the OBW measurement is included in the sweep.
- f) Repeat for step e) at 300 Hz, 2500 Hz and 3000 Hz at a minimum using the 0 dB reference level obtained in step d).
- g) Set the test receiver to measure peak negative deviation and repeat step d) through step f).
- h) The values recorded in step f) and step g) are the modulation limiting.
- i) Plot the data set as a percentage of deviation relative to the 0 dB reference point versus input voltage.

C63.26-2015, Clause 5.3.3.2 Audio frequency response test methodology—Constant Input

- a) Connect the equipment as illustrated in Figure 3.
- b) Set the test receiver to measure peak positive deviation. Set the audio bandwidth for ≤ 50 Hz to ≥ 15000 Hz. Turn the de-emphasis function off.
- c) Adjust the transmitter per the manufacturer's procedure for full rated system deviation.
- d) Apply a 1000 Hz tone and adjust the audio frequency generator to produce 20% of the rated system deviation.
- e) Set the test receiver to measure rms deviation and record the deviation reading as DEVREF.
- f) Set the audio frequency generator to the desired test frequency between 300 Hz and 3000 Hz.

3.6.3 EUT Setup Block Diagram

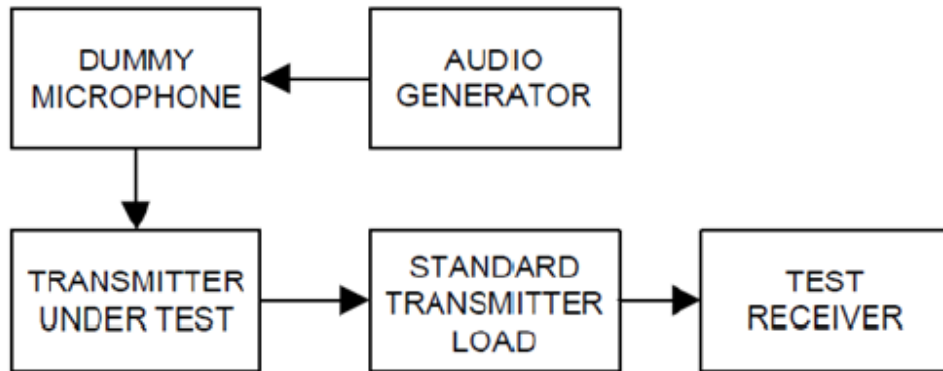

3.7 Transmitter Unwanted Emissions(Radiated)

3.7.1 Applicable Standard

FCC §90.210

Emission Mask D—12.5 kHz channel bandwidth equipment. For transmitters designed to operate with a 12.5 kHz channel bandwidth, any emission must be attenuated below the power (P) of the highest emission contained within the authorized bandwidth as follows:

On any frequency from the center of the authorized bandwidth f_0 to 5.625 kHz removed from f_0 :
Zero dB.

On any frequency removed from the center of the authorized bandwidth by a displacement frequency (f_d in kHz) of more than 5.625 kHz but no more than 12.5 kHz: At least $7.27(f_d - 2.88 \text{ kHz})$ dB.

On any frequency removed from the center of the authorized bandwidth by a displacement frequency (f_d in kHz) of more than 12.5 kHz: At least $50 + 10 \log(P)$ dB or 70 dB, whichever is the lesser attenuation.

The reference level for showing compliance with the emission mask shall be established using a resolution bandwidth sufficiently wide (usually two or three times the channel bandwidth) to capture the true peak emission of the equipment under test. In order to show compliance with the emission mask up to and including 50 kHz removed from the edge of the authorized bandwidth, adjust the resolution bandwidth to 100 Hz with the measuring instrument in a peak hold mode. A sufficient number of sweeps must be measured to insure that the emission profile is developed. If video filtering is used, its bandwidth must not be less than the instrument resolution bandwidth. For emissions beyond 50 kHz from the edge of the authorized bandwidth, see paragraph (o) of this section. If it can be shown that use of the above instrumentation settings do not accurately represent the true interference potential of the equipment under test, an alternate procedure may be used provided prior Commission approval is obtained.

FCC §22.359

(a) *Out of band emissions.* The power of any emission outside of the authorized operating frequency ranges must be attenuated below the transmitting power (P) by a factor of at least $43 + 10 \log(P)$ dB.

(b) *Measurement procedure.* Compliance with these rules is based on the use of measurement instrumentation employing a resolution bandwidth of 30 kHz or more. In the 60 kHz bands immediately outside and adjacent to the authorized frequency range or channel, a resolution bandwidth of at least one percent of the emission bandwidth of the fundamental emission of the transmitter may be employed. A narrower resolution bandwidth is permitted in all cases to improve measurement accuracy provided the measured power is integrated over the full required measurement bandwidth (i.e., 30 kHz or 1 percent of emission bandwidth, as specified). The emission bandwidth is defined as the width of the signal between two points, one below the carrier center frequency and one above the carrier center frequency, outside of which all emissions are attenuated at least 26 dB below the transmitter power.

FCC §74.462

(c) For emissions on frequencies above 25 MHz with authorized bandwidths up to 30 kHz, the emissions shall comply with the emission mask and transient frequency behavior requirements of §§90.210 and

90.214 of this chapter. For all other emissions, the mean power of emissions shall be attenuated below the mean output power of the transmitter in accordance with the following schedule:

- (1) On any frequency removed from the assignment frequency by more than 50 percent up to and including 100 percent of the authorized bandwidth: at least 25 dB;
- (2) On any frequency removed from the assigned frequency by more than 100 percent up to and including 250 percent of the authorized bandwidth: at least 35 dB;
- (3) On any frequency removed from the assigned frequency by more than 250 percent on the authorized bandwidth; at least 43 plus $10 \log_{10}$ (mean output power, in watts) dB.

FCC §80.211

The mean power when using emissions other than those in paragraphs (a), (b), (c) and (d) of this section:

- (1) On any frequency removed from the assigned frequency by more than 50 percent up to and including 100 percent of the authorized bandwidth: At least 25 dB;
- (2) On any frequency removed from the assigned frequency by more than 100 percent up to and including 250 percent of the authorized bandwidth: At least 35 dB; and
- (3) On any frequency removed from the assigned frequency by more than 250 percent of the authorized bandwidth: At least 43 plus $10 \log_{10}$ (mean power in watts) dB.

3.7.2 Test setup:

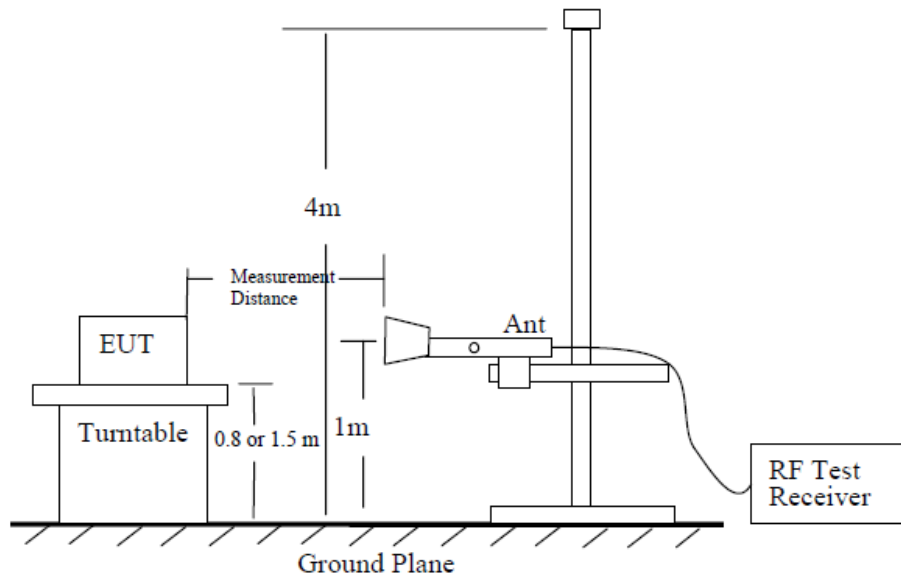

Figure 6—Test site-up for radiated ERP and/or EIRP measurements

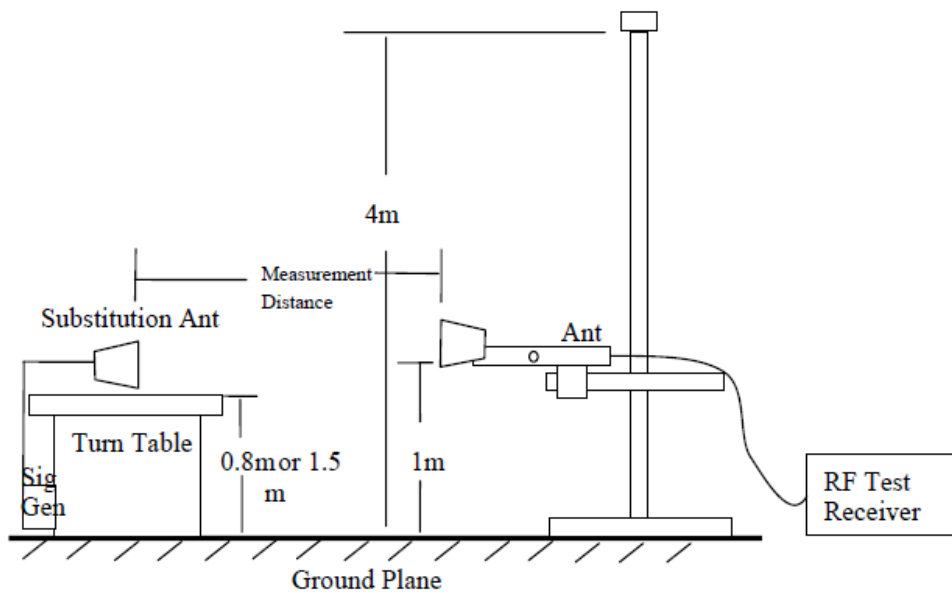

Figure 7—Substitution method set-up for radiated emission

3.7.3 Test Procedure:

- a) Place the EUT in the center of the turntable. The EUT shall be configured to transmit into the standard non-radiating load (for measuring radiated spurious emissions), connected with cables of minimal length unless specified otherwise. If the EUT uses an adjustable antenna, the antenna shall be positioned to the length that produces the worst case emission at the fundamental operating frequency.
- b) Each emission under consideration shall be evaluated:
 - 1) Raise and lower the measurement antenna in accordance 5.5.2, as necessary to enable detection of the maximum emission amplitude relative to measurement antenna height.
 - 2) Rotate the EUT through 360° to determine the maximum emission level relative to the axial position.
 - 3) Return the turntable to the azimuth where the highest emission amplitude level was observed.
 - 4) Vary the measurement antenna height again through 1 m to 4 m again to find the height associated with the maximum emission amplitude.
 - 5) Record the measured emission amplitude level and frequency using the appropriate RBW.
- c) Repeat step b) for each emission frequency with the measurement antenna oriented in both the horizontal and vertical polarizations to determine the orientation that gives the maximum emissions amplitude.
- d) Set-up the substitution measurement with the reference point of the substitution antenna located as near as possible to where the center of the EUT radiating element was located during the initial EUT measurement.
- e) Maintain the previous measurement instrument settings and test set-up, with the exception that the EUT is removed and replaced by the substitution antenna.
- f) Connect a signal generator to the substitution antenna; locate the signal generator so as to minimize any potential influences on the measurement results. Set the signal generator to the frequency where emissions are detected, and set an output power level such that the radiated signal can be detected by the measurement instrument, with sufficient dynamic range relative to the noise floor.
- g) For each emission that was detected and measured in the initial test [i.e., in step b) and step c)]:
 - 1) Vary the measurement antenna height between 1 m to 4 m to maximize the received (measured) signal amplitude.
 - 2) Adjust the signal generator output power level until the amplitude detected by the measurement instrument equals the amplitude level of the emission previously measured directly in step b) and step c).
 - 3) Record the output power level of the signal generator when equivalence is achieved in step 2).
- h) Repeat step e) through step g) with the measurement antenna oriented in the opposite polarization.
- i) Calculate the emission power in dBm referenced to a half-wave dipole using the following equation:

$$P_e = P_s(\text{dBm}) - \text{cable loss (dB)} + \text{antenna gain (dBd)}$$
 where
 - P_e = equivalent emission power in dBm
 - P_s = source (signal generator) power in dBm
 NOTE—dBd refers to the measured antenna gain in decibels relative to a half-wave dipole.
- j) Correct the antenna gain of the substitution antenna if necessary to reference the emission power to a half-wave dipole. When using measurement antennas with the gain specified in dBi, the equivalent dipole-referenced gain can be determined from: $\text{gain (dBd)} = \text{gain (dBi)} - 2.15 \text{ dB}$. If necessary, the antenna gain can be calculated from calibrated antenna factor information
- k) Provide the complete measurement results as a part of the test report.

4. Test DATA AND RESULTS

4.6 FREQUENCY STABILITY:

Serial Number:	CR22080001-RF-S1	Test Date:	2022-08-12
Test Site:	RF	Test Mode:	Transmitting
Tester:	Rinka Li	Test Result:	Pass

Environmental Conditions:

Temperature: (°C)	27.8	Relative Humidity: (%)	46.5	ATM Pressure: (kPa)	100.3
----------------------	------	------------------------------	------	------------------------	-------

Test Equipment List and Details:

Manufacturer	Description	Model	Serial Number	Calibration Date	Calibration Due Date
R&S	Signal Analyzer	FSIQ26	831929/006	2022-07-15	2023-07-14
zhuoxiang	Coaxial Cable	SMA-178	211002	Each time	N/A
YINSAIGE	Coaxial Cable	SS402	SJ0100002	Each time	N/A
Weinschel	Coaxial Attenuators	53-20-34	LN751	Each time	N/A
BACL	TEMP&HUMI Test Chamber	BTH-150-40	30174	2022-04-06	2023-04-05
UNI-T	Multimeter	UT39A+	C210582554	2021-09-30	2022-09-29

* Statement of Traceability: China Certification ICT Co., Ltd (Dongguan) attests that all calibrations have been performed, traceable to National Primary Standards and International System of Units (SI).

Test Data:

FCC Part 90:

Un-modulation, Reference Frequency: 155.7525 MHz, Limit: ±5 ppm			
Temperature (°C)	Voltage Supplied (V _{DC})	Measured Frequency (MHz)	Frequency Error (ppm)
-30	13.6	155.7526019	0.65
-20		155.7525992	0.64
-10		155.7525945	0.61
0		155.7525920	0.59
10		155.7525918	0.59
20		155.7525870	0.56
30		155.7525854	0.55
40		155.7525838	0.54
50		155.7525811	0.52
20		10.8	155.7525796
20	15.6	155.7525780	0.50

FCC Part 80:

Un-modulation, Reference Frequency: 154.0125MHz, Limit: ±5.0 ppm			
Temperature (°C)	Voltage Supplied (V_{DC})	Measured Frequency (MHz)	Frequency Error (ppm)
-30	13.6	154.012601	0.66
-20		154.012598	0.64
-10		154.012597	0.63
0		154.012592	0.60
10		154.012587	0.57
20		154.012587	0.56
30		154.012587	0.56
40		154.012586	0.56
50		154.012583	0.54
20		10.8	154.012580
20	15.6	154.012579	0.51

FCC Part 74:

Un-modulation, Reference Frequency: 161.1 MHz, Limit: ±5.0 ppm			
Temperature (°C)	Voltage Supplied (V_{DC})	Measured Frequency (MHz)	Frequency Error (ppm)
-30	13.6	161.1000181	0.11
-20		161.1000169	0.10
-10		161.1000149	0.09
0		161.1000115	0.07
10		161.1000109	0.07
20		161.1000087	0.05
30		161.1000063	0.04
40		161.1000039	0.02
50		161.1000031	0.02
20		10.8	161.1000031
20	15.6	161.1000017	0.01

FCC Part 22:

Un-modulation, Reference Frequency: 150.8125MHz, Limit: ±5.0 ppm			
Temperature (°C)	Voltage Supplied (V_{DC})	Measured Frequency (MHz)	Frequency Error (ppm)
-30	13.6	150.8125983	0.65
-20		150.8125951	0.63
-10		150.8125908	0.60
0		150.8125900	0.60
10		150.8125891	0.59
20		150.8125870	0.58
30		150.8125840	0.56
40		150.8125835	0.55
50		150.8125808	0.54
20		10.8	150.8125792
20	15.6	150.8125779	0.52

4.2 RF OUTPUT POWER

Serial Number:	CR22080001-RF-S1	Test Date:	2022-08-12
Test Site:	RF	Test Mode:	Transmitting
Tester:	Rinka Li	Test Result:	Pass

Environmental Conditions:

Temperature: (°C)	27.8	Relative Humidity: (%)	46.5	ATM Pressure: (kPa)	100.3
----------------------	------	------------------------------	------	------------------------	-------

Test Equipment List and Details:

Manufacturer	Description	Model	Serial Number	Calibration Date	Calibration Due Date
R&S	Spectrum Analyzer	FSV40	101474	2022-07-15	2023-07-14
zhuoxiang	Coaxial Cable	SMA-178	211002	Each time	N/A
YINSAIGE	Coaxial Cable	SS402	SJ0100002	Each time	N/A
Weinschel	Coaxial Attenuators	53-20-34	LN751	Each time	N/A
HP	RF Communications Test Set	8920A	3438A05209	2022-07-15	2023-07-14

* Statement of Traceability: China Certification ICT Co., Ltd (Dongguan) attests that all calibrations have been performed, traceable to National Primary Standards and International System of Units (SI).

Test Data:

Channel Separation	Test Modulation	Test Channel	Test Frequency (MHz)	Conducted Output Power (dBm)		Limit (dBm)	
				High Power Level	Low Power Level	High Power Level	Low Power Level
12.5kHz	FM	Low	136.0125	47.02	37.04	47.78	37.78
		Middle	155.7525	46.97	37.00	47.78	37.78
		High	173.9875	47.03	37.03	47.78	37.78
		Additional	150.8125	47.02	37.03	47.78	37.78
		Additional	161.1000	47.00	37.01	47.78	37.78
	4FSK	Low	136.0125	46.94	36.90	47.78	37.78
		Middle	155.7525	46.91	36.89	47.78	37.78
		High	173.9875	46.97	36.92	47.78	37.78
		Additional	150.8125	46.96	36.94	47.78	37.78
		Additional	161.1000	46.91	36.88	47.78	37.78
25kHz	FM	Additional	150.8125	46.92	36.92	47.78	37.78
		Additional	161.1000	47.00	36.99	47.78	37.78
		Additional	154.0125	47.05	37.08	47.78	37.78

Note: The high rated power level is 50W(47dBm), and low rated power level is 5W(37dBm).

The output power shall not exceed by more than 20 percent the manufacturer's rated output power for the particular transmitter specifically listed on the authorization.

FM, 12.5kHz:

Low Channel, 136.0125 MHz High Power

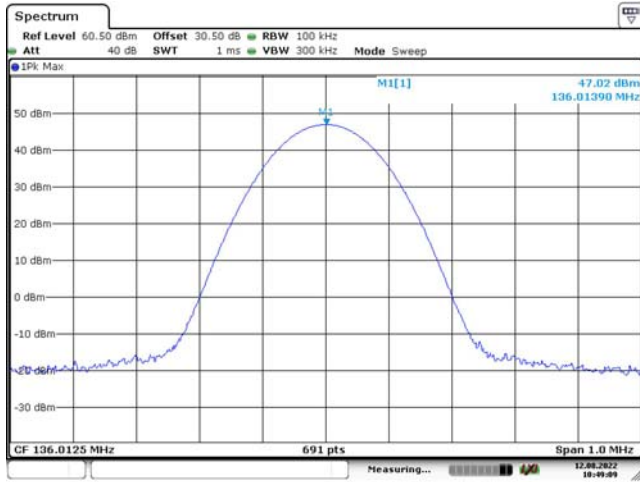

Date: 12.AUG.2022 10:49:09

Low Channel, 136.0125 MHz Low Power

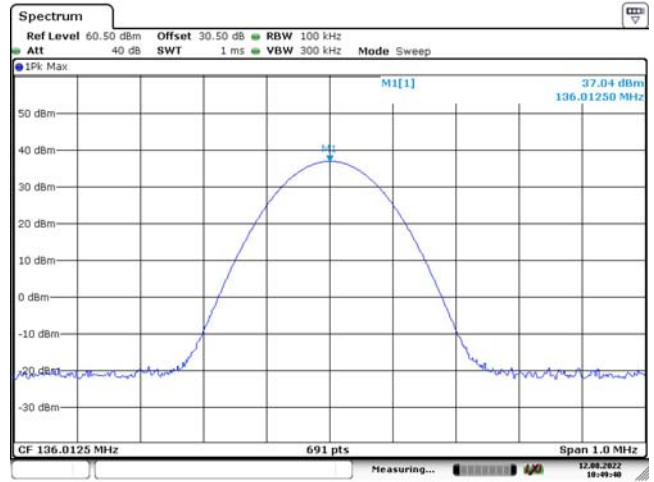

Date: 12.AUG.2022 10:49:40

Middle Channel, 155.7525 MHz High Power

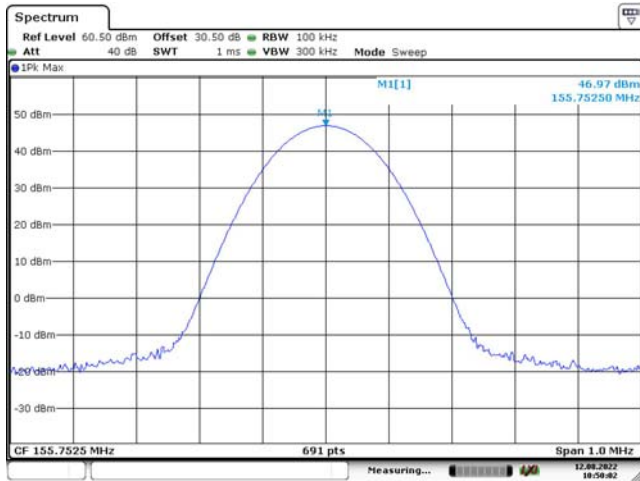

Date: 12.AUG.2022 10:50:03

Middle Channel, 155.7525 MHz Low Power

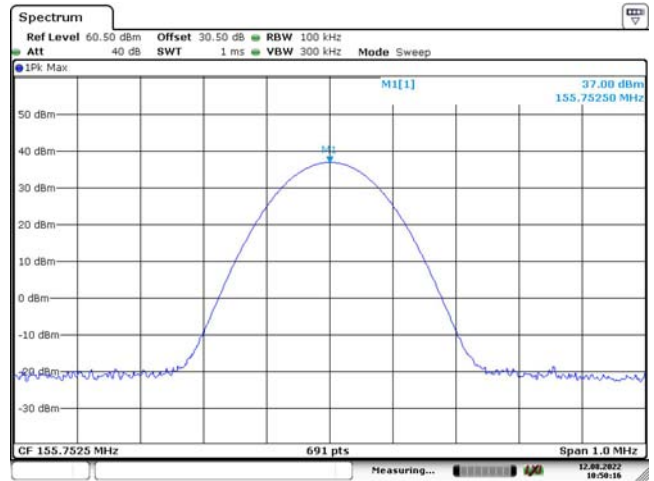

Date: 12.AUG.2022 10:50:16

High Channel, 173.9875 MHz High Power

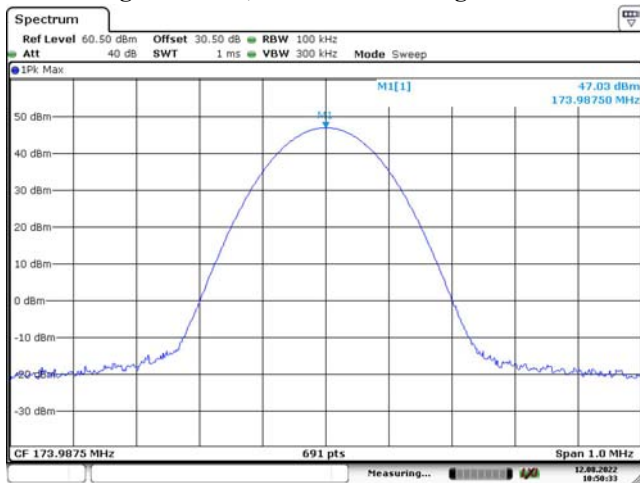

Date: 12.AUG.2022 10:50:33

High Channel, 173.9875 MHz Low Power

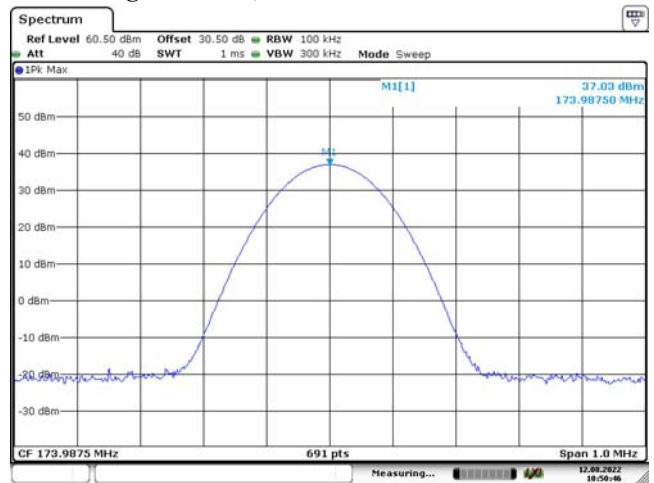

Date: 12.AUG.2022 10:50:46

Additional, For Part 22, 150.8125 MHz High Power

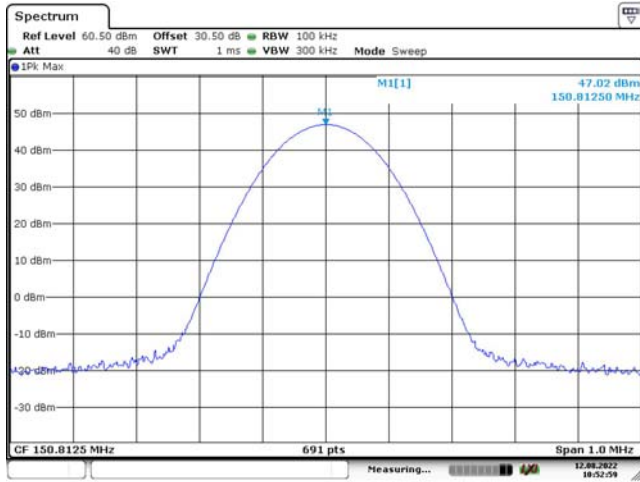

Date: 12.AUG.2022 10:52:59

Additional, For Part 22, 150.8125 MHz Low Power

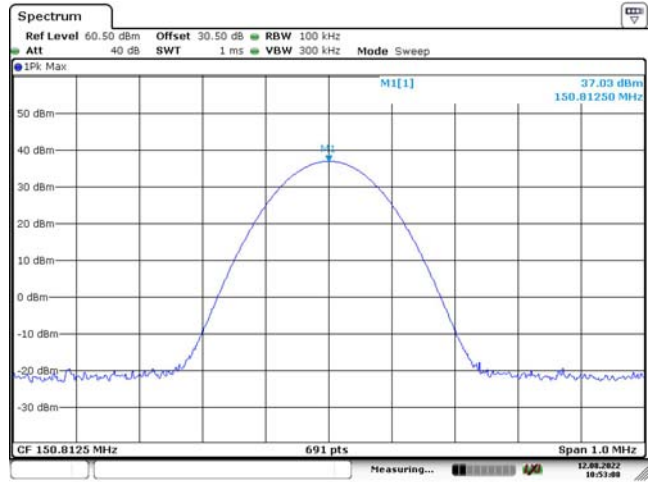

Date: 12.AUG.2022 10:53:08

Additional, For Part 74, 161.1 MHz High Power

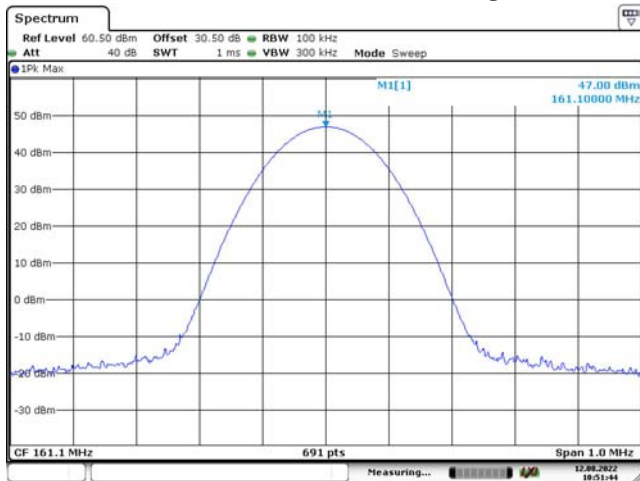

Date: 12.AUG.2022 10:51:45

Additional, For Part 74, 161.1 MHz Low Power

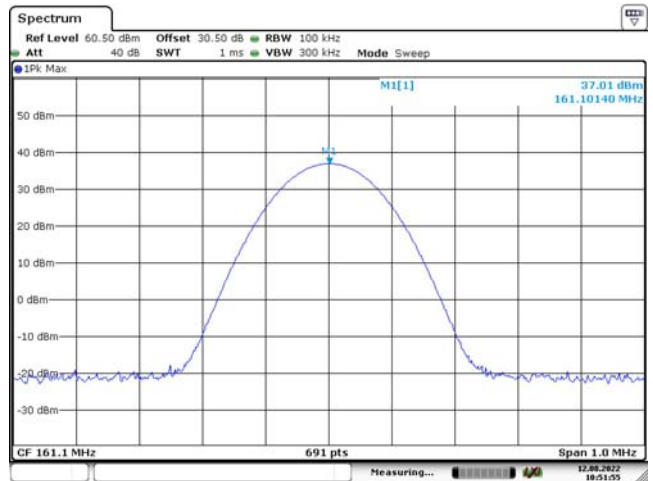

Date: 12.AUG.2022 10:51:55

4FSK, 12.5kHz:

Low Channel, 136.0125 MHz High Power

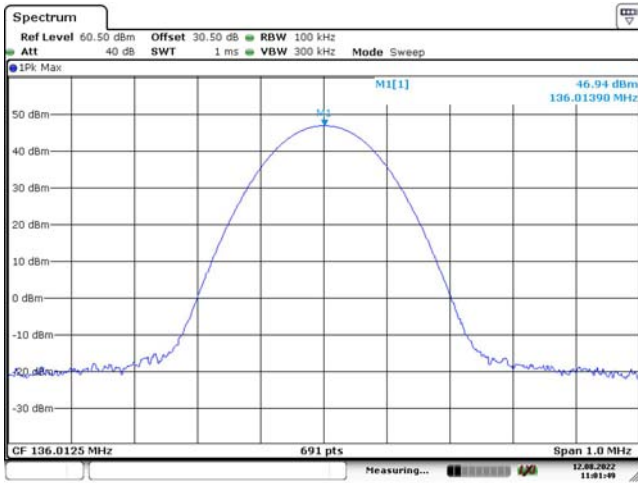

Low Channel, 136.0125 MHz Low Power

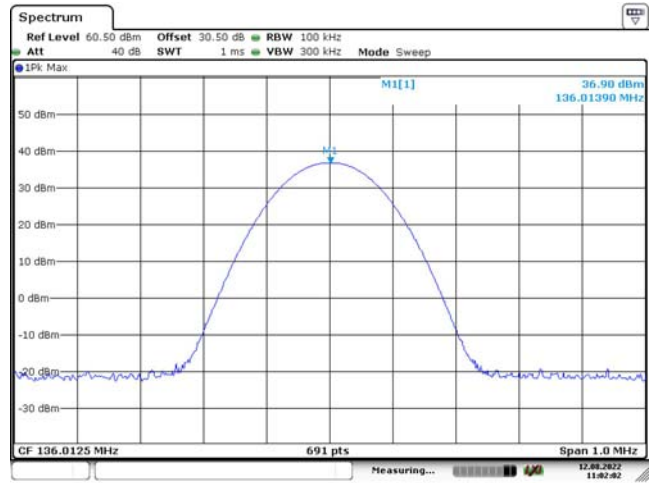

Middle Channel, 155.7525 MHz High Power

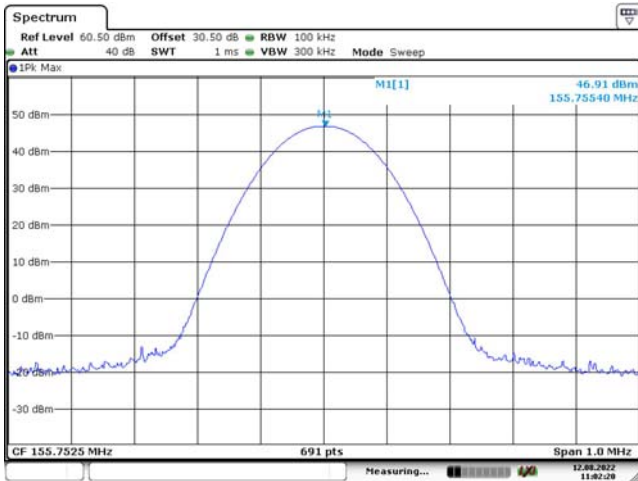

Middle Channel, 155.7525 MHz Low Power

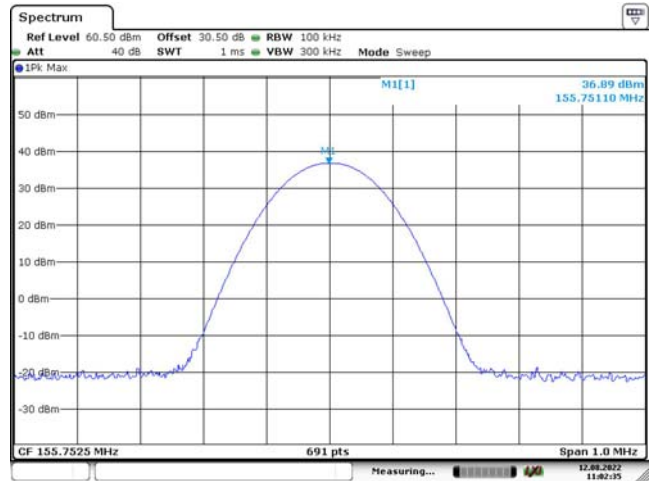

High Channel, 173.9875 MHz High Power

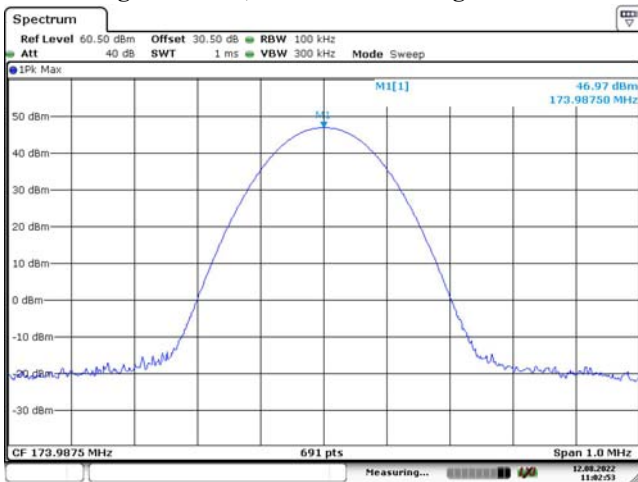

High Channel, 173.9875 MHz Low Power

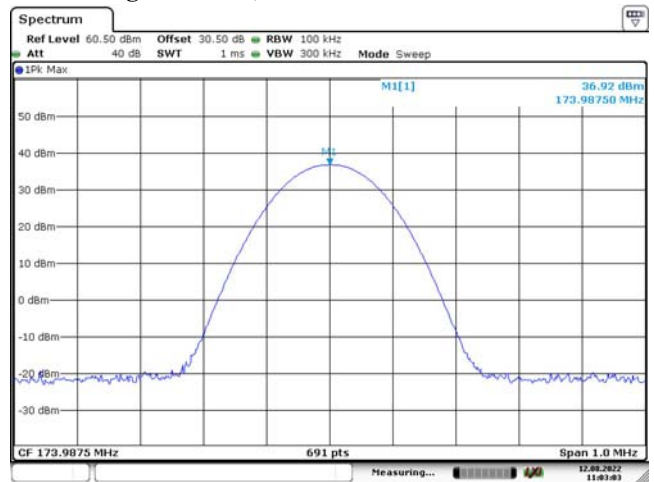

FM, 25kHz:

Additional Channel, Part 80, 154.0125 MHz High Power

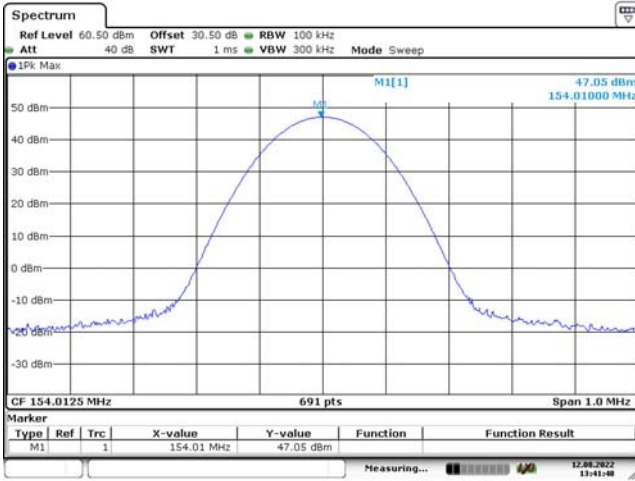

Date: 12.AUG.2022 13:41:48

Additional Channel, Part 80, 154.0125 MHz Low Power

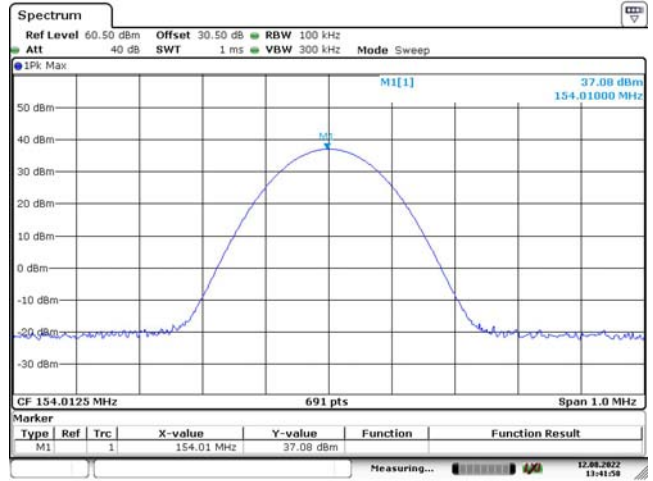

Date: 12.AUG.2022 13:41:58

Additional Channel, Part 74, 161.1 MHz High Power

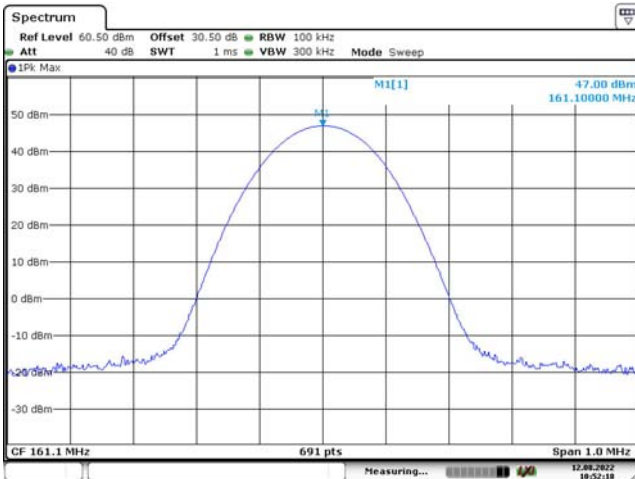

Date: 12.AUG.2022 10:52:19

Additional Channel, Part 22, 161.1 MHz Low Power

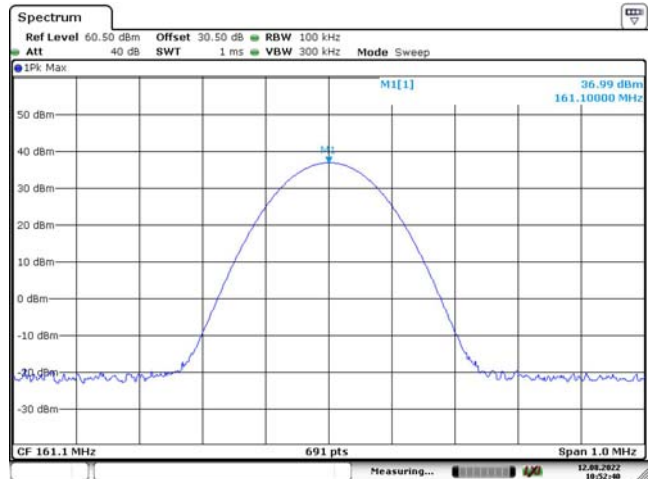

Date: 12.AUG.2022 10:52:40

Additional Channel, Part 22, 150.8125 MHz High Power

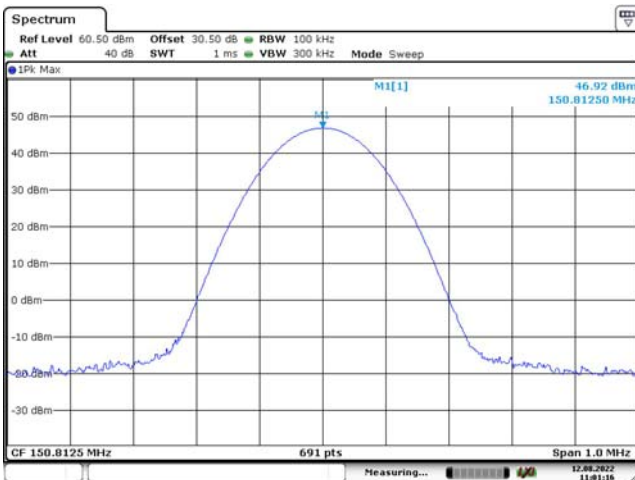

Date: 12.AUG.2022 11:01:16

Additional Channel, Part 22, 150.8125 MHz Low Power

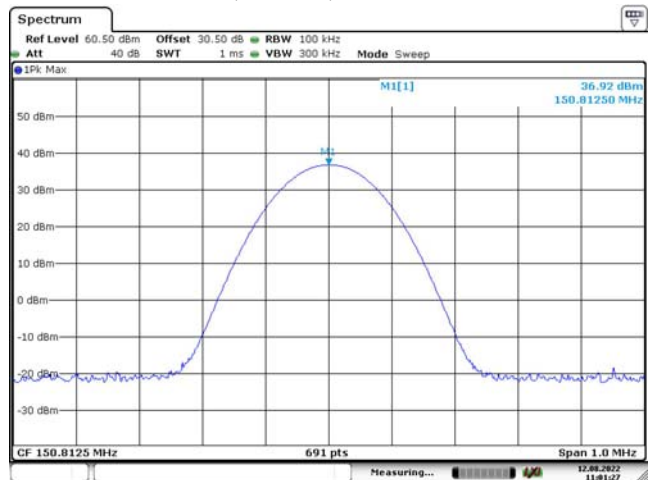

Date: 12.AUG.2022 11:01:27

4.3 OCCUPIED BANDWIDTH & EMISSION MASK:

Serial Number:	CR22080001-RF-S1	Test Date:	2022-08-12
Test Site:	RF	Test Mode:	Transmitting
Tester:	Rinka Li	Test Result:	Pass

Environmental Conditions:

Temperature: (°C)	27.8	Relative Humidity: (%)	46.5	ATM Pressure: (kPa)	100.3
----------------------	------	------------------------------	------	------------------------	-------

Test Equipment List and Details:

Manufacturer	Description	Model	Serial Number	Calibration Date	Calibration Due Date
R&S	Spectrum Analyzer	FSV40	101474	2022-07-15	2023-07-14
zhuoxiang	Coaxial Cable	SMA-178	211002	Each time	N/A
YINSAIGE	Coaxial Cable	SS402	SJ0100002	Each time	N/A
Weinschel	Coaxial Attenuators	53-20-34	LN751	Each time	N/A
HP	RF Communications Test Set	8920A	3438A05209	2022-07-15	2023-07-14

* Statement of Traceability: China Certification ICT Co., Ltd (Dongguan) attests that all calibrations have been performed, traceable to National Primary Standards and International System of Units (SI).

Test Data:

Modulation Mode	Channel Separation	Test Frequency (MHz)	High Power Level		Low Power Level	
			99% Occupied Bandwidth (kHz)	26 dB Bandwidth (kHz)	99% Occupied Bandwidth (kHz)	26 dB Bandwidth (kHz)
FM	12.5kHz	136.0125	9.81	10.25	9.81	10.25
		155.7525	7.47	10.25	7.47	10.25
		173.9875	5.21	10.25	5.21	10.25
		150.8125	5.21	10.25	9.81	10.25
		161.1000	5.30	10.25	5.30	10.25
4FSK	12.5kHz	136.0125	7.47	9.55	7.38	9.81
		155.7525	7.47	9.90	7.29	9.90
		173.9875	7.12	9.12	7.38	9.55
		150.8125	7.29	9.20	7.38	9.38
		161.1000	7.21	9.29	7.38	9.55
FM	25kHz	150.8125	14.47	15.77	14.04	15.77
		161.1000	12.74	15.77	12.59	15.63
		154.0125	14.47	15.77	14.47	15.77

Note: Emission bandwidth was based on calculation method instead of measurement.
Emission Designator: Per CFR 47 §2.201& §2.202, $BW = 2M + 2D$

For FM Mode (Channel Spacing: 12.5 kHz)

Emission Designator: 11K0F3E

In this case, the maximum modulating frequency is 3.0 kHz with a 2.5 kHz deviation.

$$BW = 2(M+D) = 2*(3.0 \text{ kHz} + 2.5 \text{ kHz}) = 11 \text{ kHz} = 11K0$$

F3E portion of the designator represents an FM voice transmission

Therefore, the entire designator for 12.5 kHz channel spacing FM mode is 11K0F3E.

For FM Mode (Channel Spacing: 25 kHz)

Emission Designator: 16K0F3E

In this case, the maximum modulating frequency is 3.0 kHz with a 5.0 kHz deviation.

$$BW = 2(M+D) = 2*(3.0 \text{ kHz} + 5.0 \text{ kHz}) = 16 \text{ kHz} = 16K0$$

F3E portion of the designator represents an FM voice transmission

Therefore, the entire designator for 25 kHz channel spacing FM mode is 16K0F3E.

For Digital Mode (Channel Spacing: 12.5 kHz)

Emission Designator: 7K60F1D and 7K60F1E

The 99% energy rule (title 47CFR 2.1049) was used for digital mode. It basically states that 99% of the modulation energy falls within X kHz, in this case, 7.60 kHz. The emission mask was obtained from 47CFR 90.210(d).

F1D and F1E portion of the designator indicates digital information.

Therefore, the entire designator for 12.5 kHz channel spacing digital mode is 7K60F1D and 7K60F1E.

FM, 12.5kHz, High Power:

Low Channel

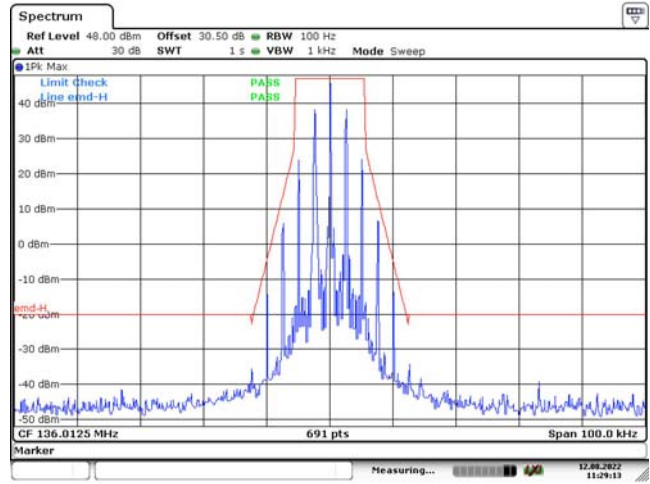
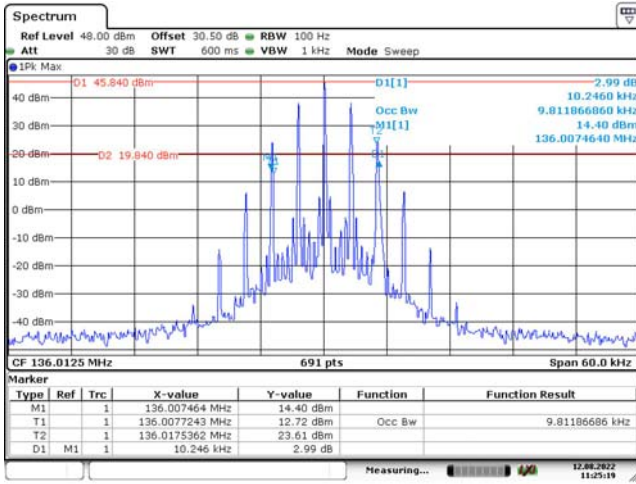

Date: 12.AUG.2022 11:25:19

Date: 12.AUG.2022 11:29:13

Middle Channel

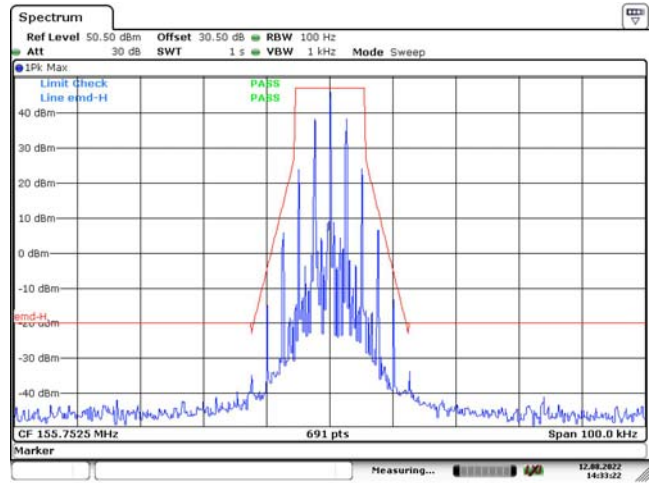
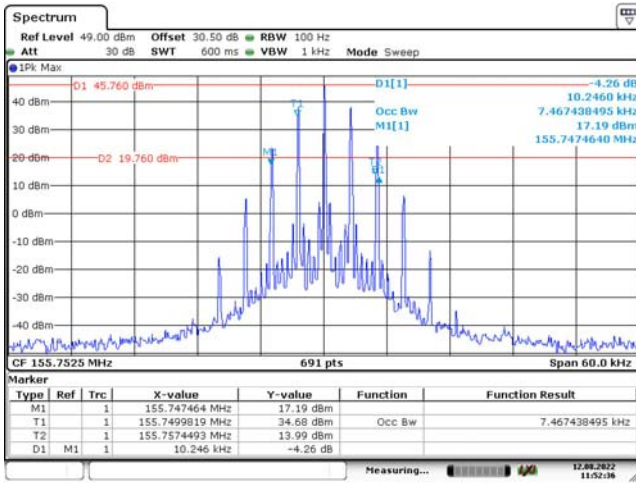

Date: 12.AUG.2022 11:52:36

Date: 12.AUG.2022 14:33:22

High Channel

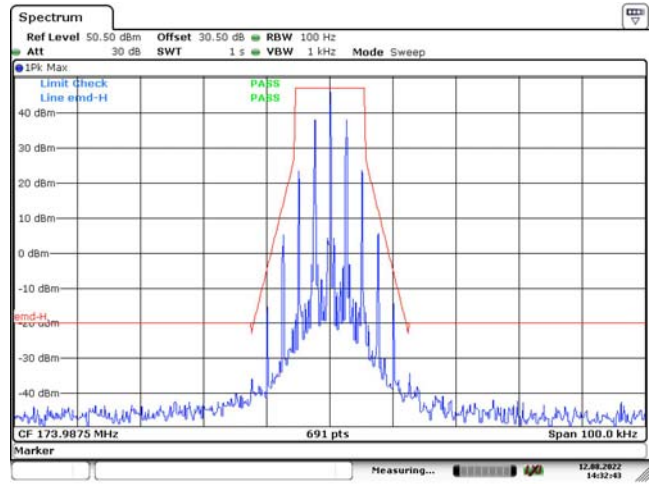
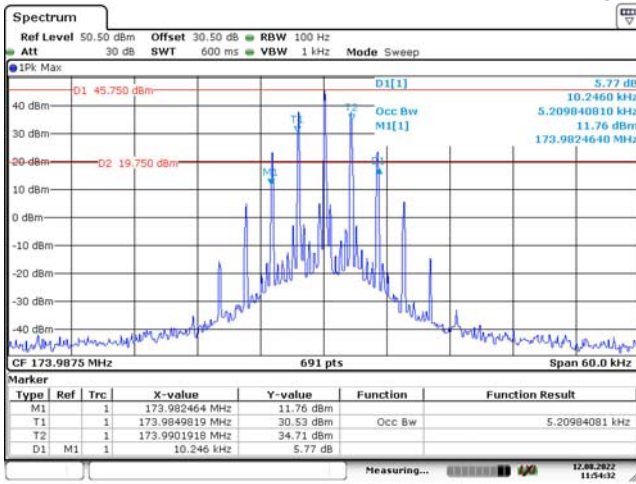

Date: 12.AUG.2022 11:54:32

Date: 12.AUG.2022 14:32:44

Additional Channel Part 74, 161.1 MHz

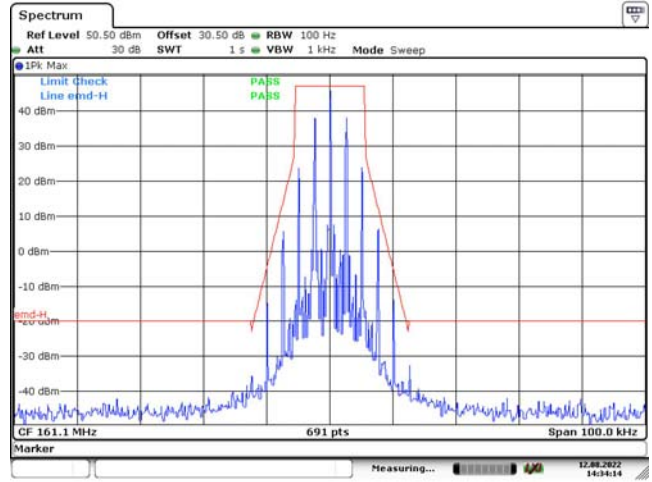
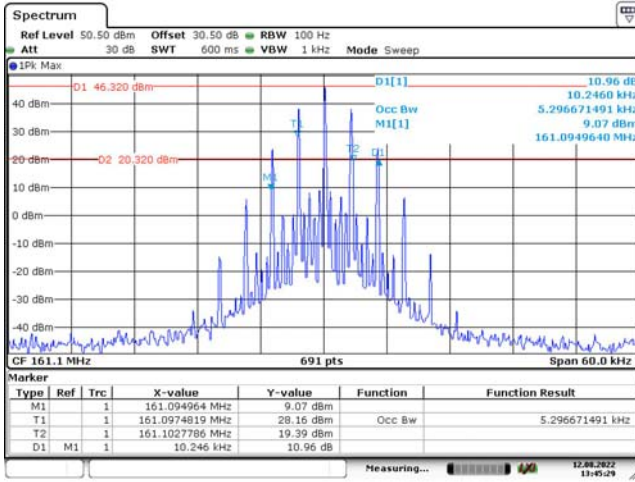

Date: 12.AUG.2022 13:45:30

Date: 12.AUG.2022 14:34:15

Additional Channel Part 22, 150.8125 MHz

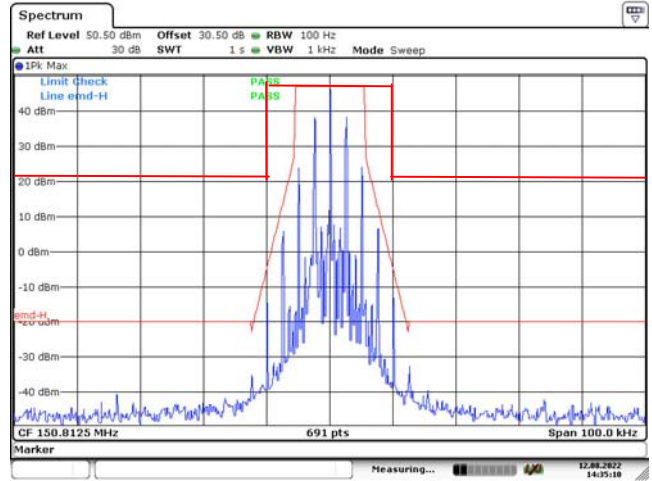
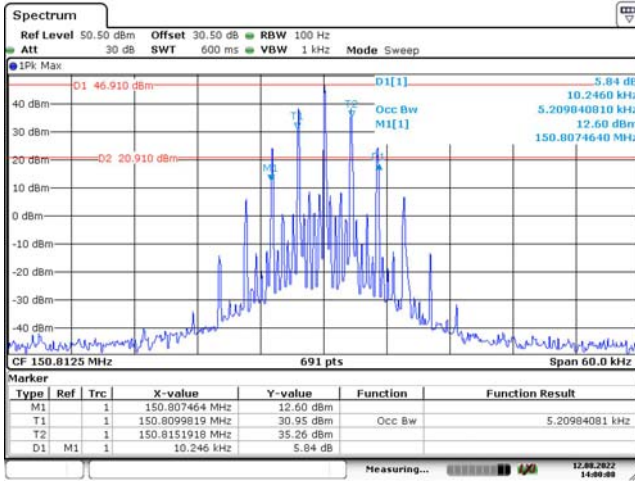

Date: 12.AUG.2022 14:00:09

Date: 12.AUG.2022 14:35:10

FM, 12.5kHz, Low Power:

Low Channel

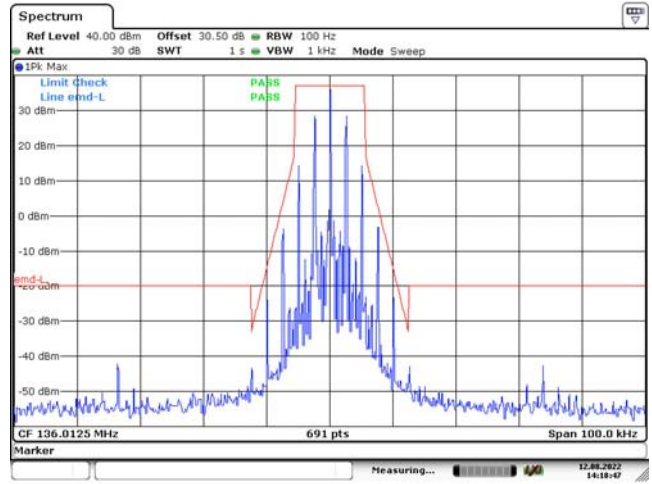
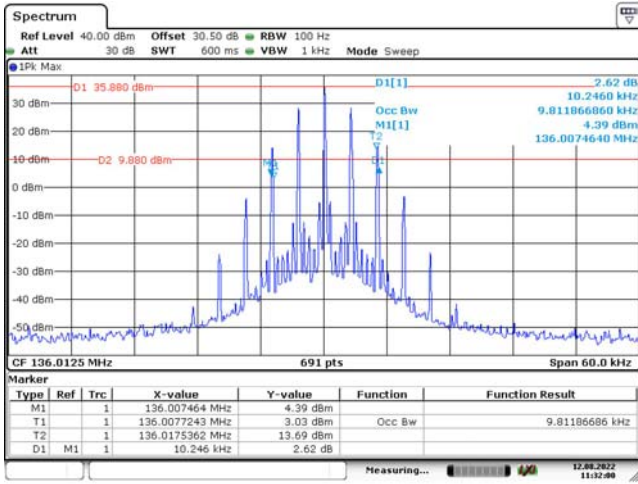

Date: 12.AUG.2022 11:32:00

Date: 12.AUG.2022 14:18:47

Middle Channel

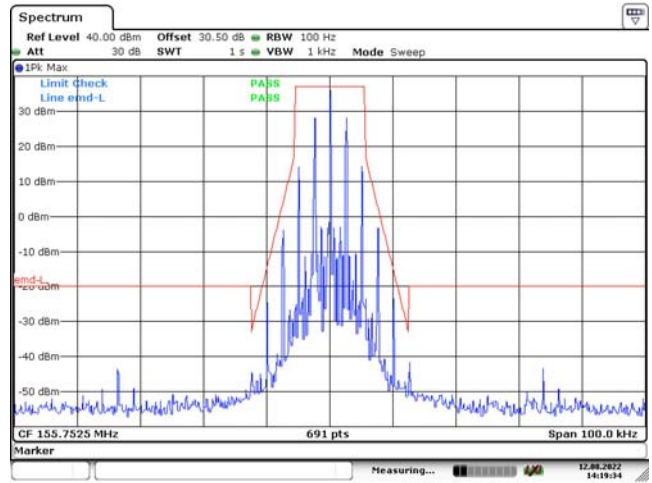
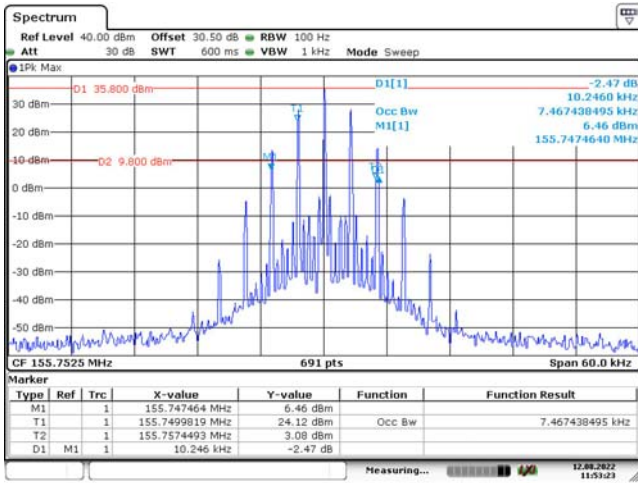

Date: 12.AUG.2022 11:53:23

Date: 12.AUG.2022 14:19:35

High Channel

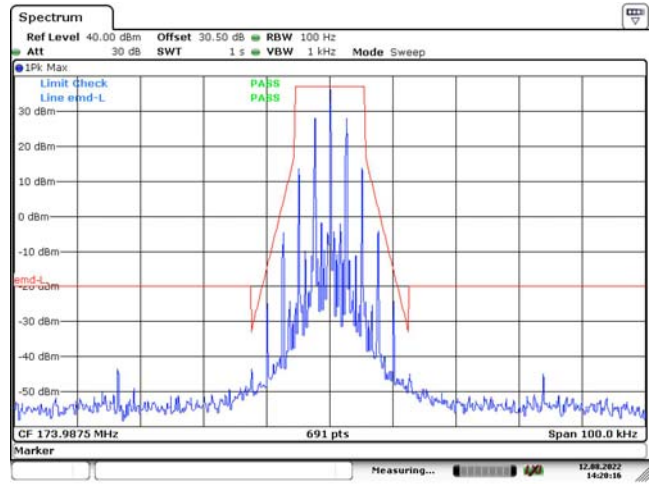
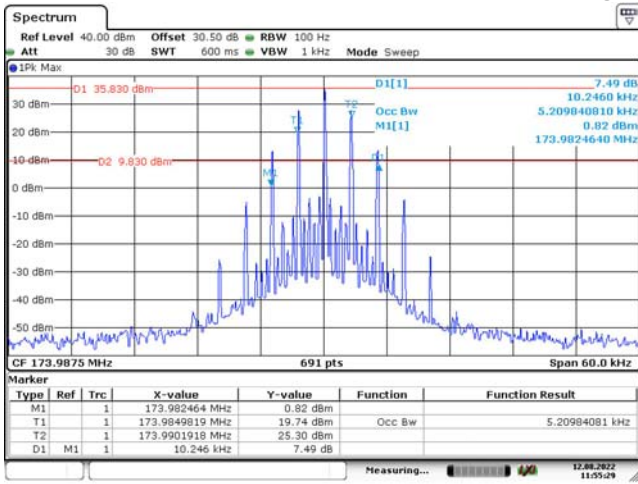

Date: 12.AUG.2022 11:55:29

Date: 12.AUG.2022 14:20:17

Additional Channel Part 74, 161.1 MHz

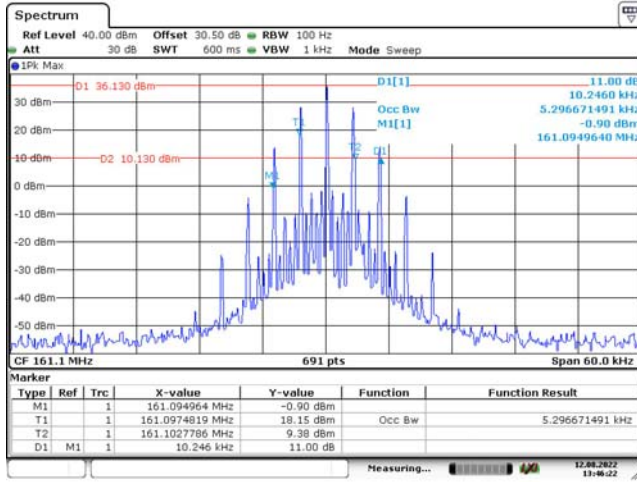

Date: 12.AUG.2022 13:46:22

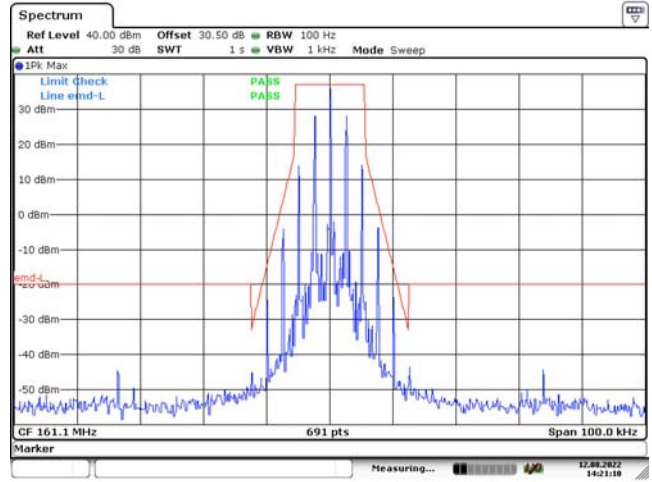

Date: 12.AUG.2022 14:21:10

Additional Channel Part 22, 150.8125 MHz

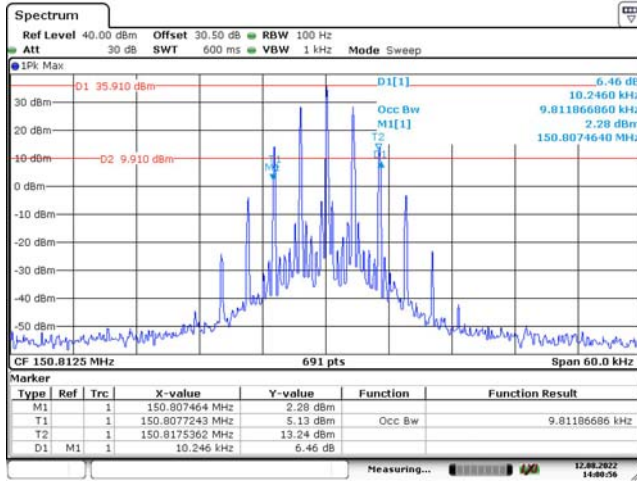

Date: 12.AUG.2022 14:00:56

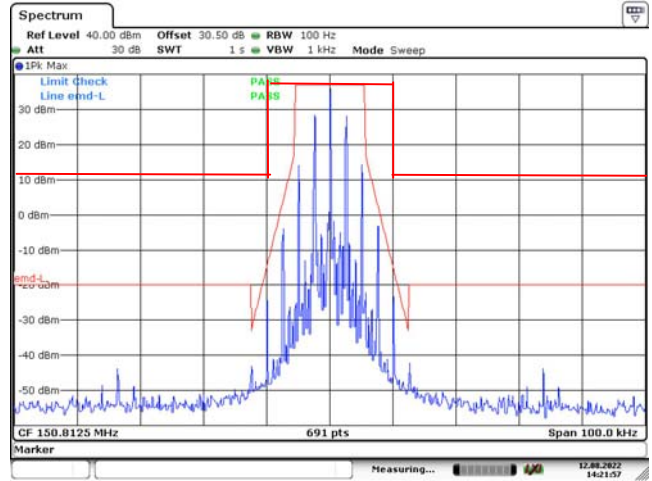

Date: 12.AUG.2022 14:21:58

4FSK, 12.5kHz, High Power:

Low Channel

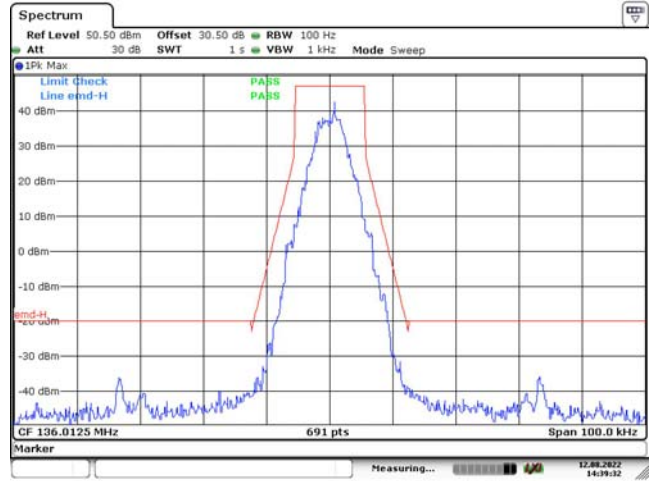
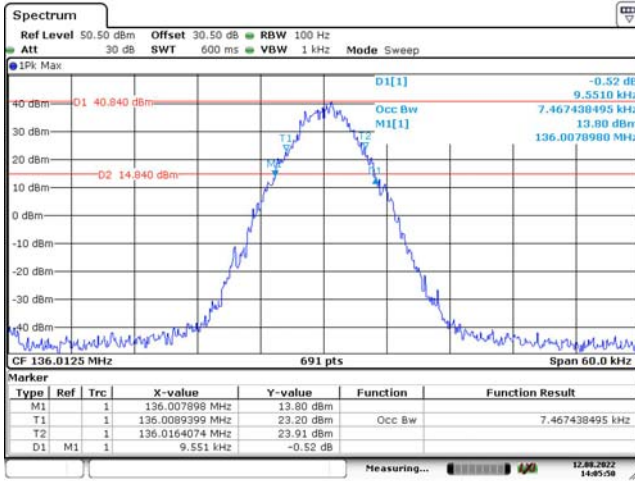

Date: 12.AUG.2022 14:05:50

Date: 12.AUG.2022 14:39:32

Middle Channel

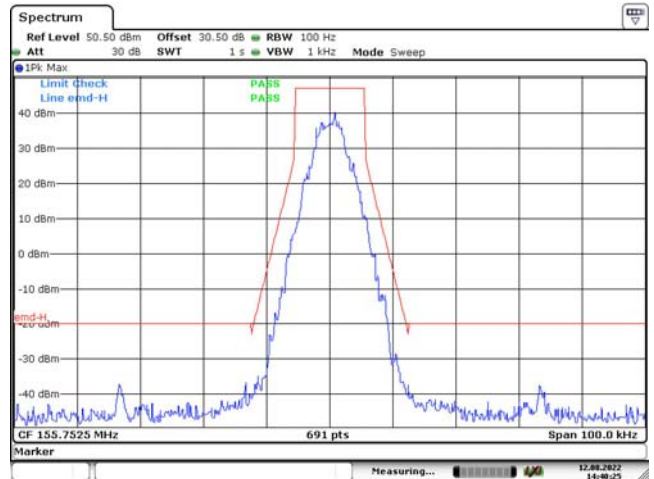
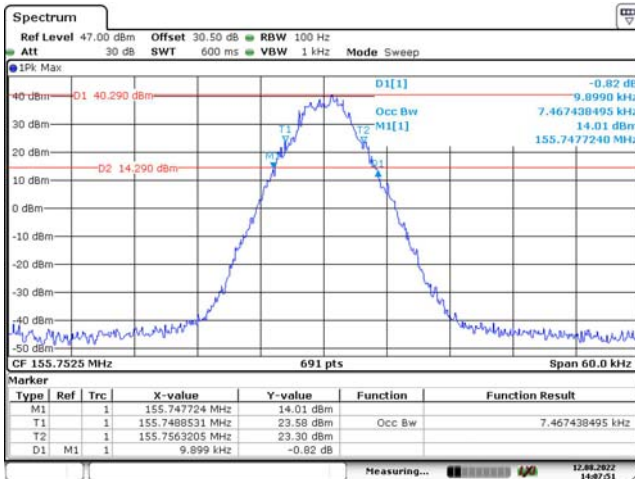

Date: 12.AUG.2022 14:07:52

Date: 12.AUG.2022 14:40:26

High Channel

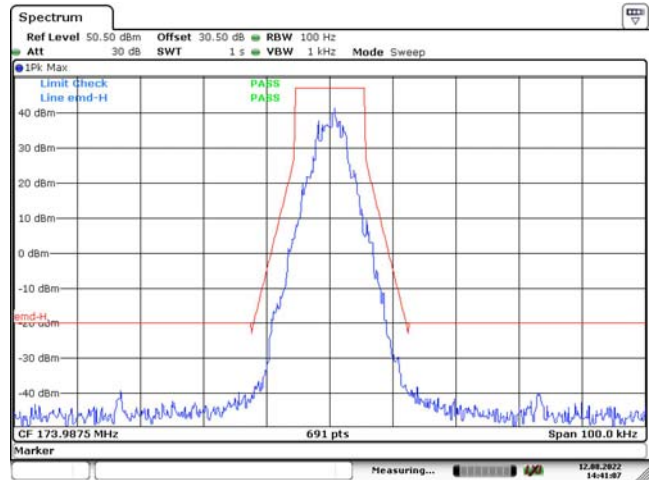
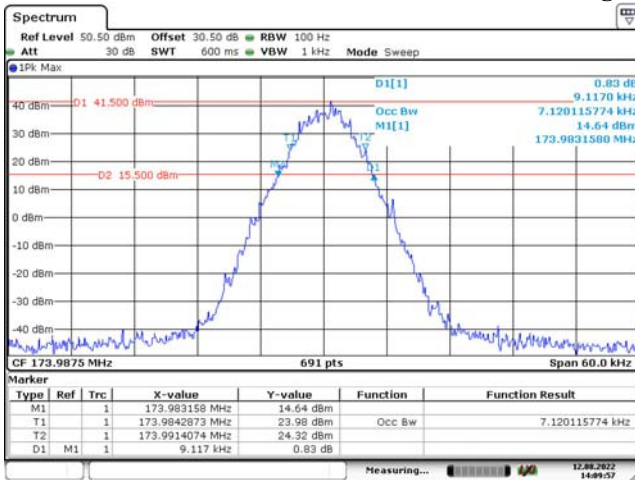

Date: 12.AUG.2022 14:09:57

Date: 12.AUG.2022 14:41:07

Additional Channel Part 74, 161.1 MHz

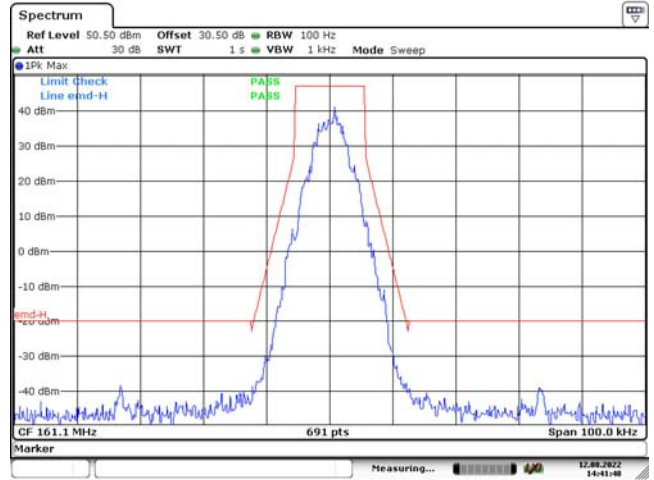
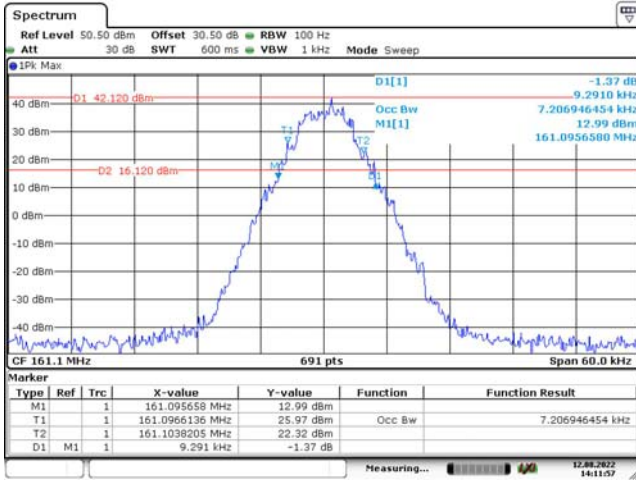

Additional Channel Part 22, 150.8125 MHz

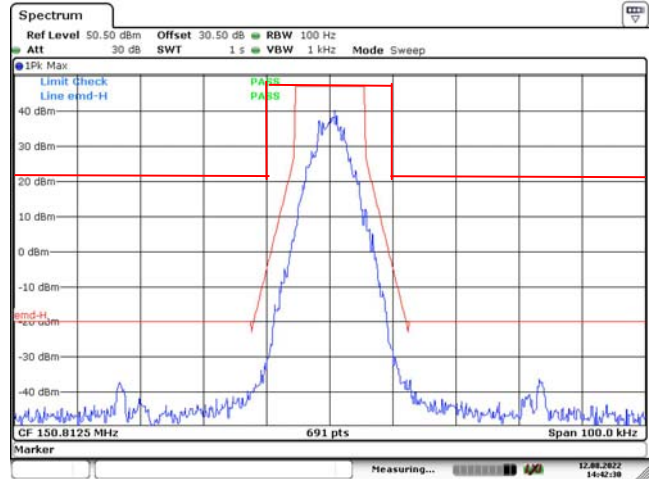
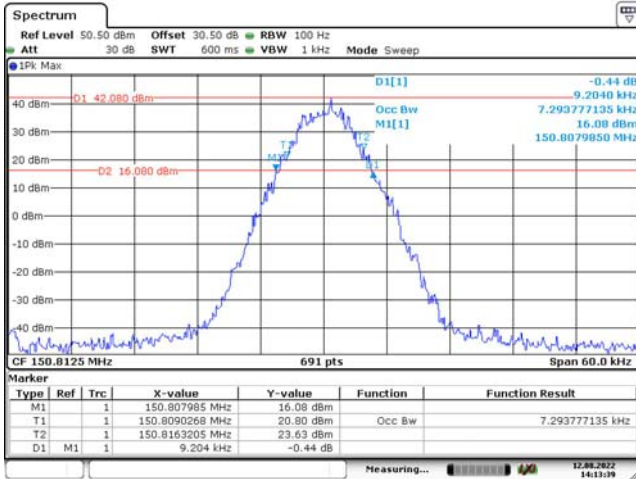

4FSK, 12.5kHz, Low Power:

Low Channel

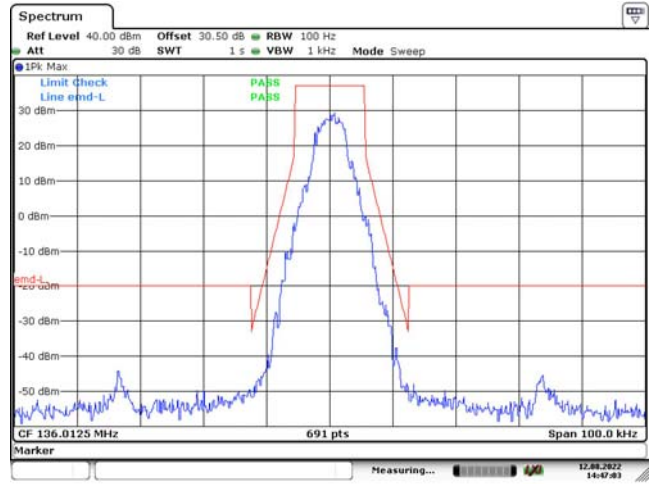
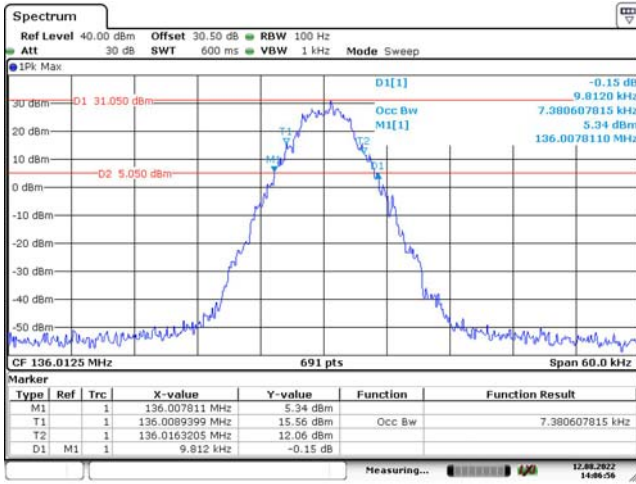

Date: 12.AUG.2022 14:06:56

Date: 12.AUG.2022 14:47:04

Middle Channel

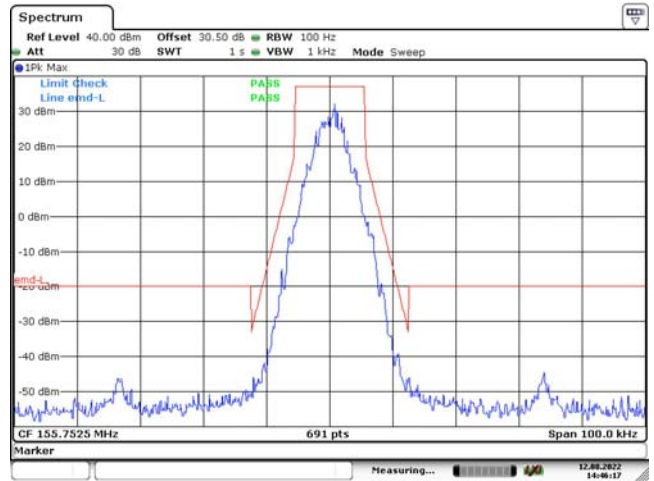
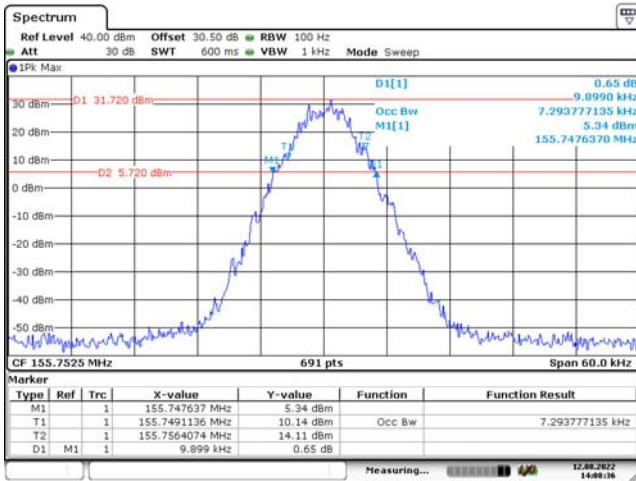

Date: 12.AUG.2022 14:08:37

Date: 12.AUG.2022 14:46:18

High Channel

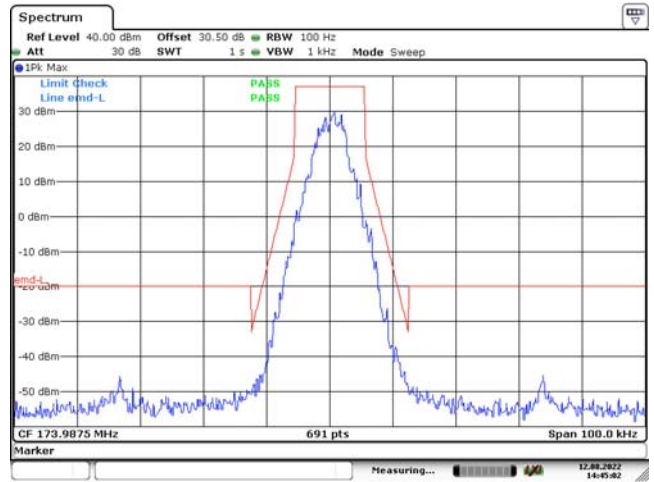
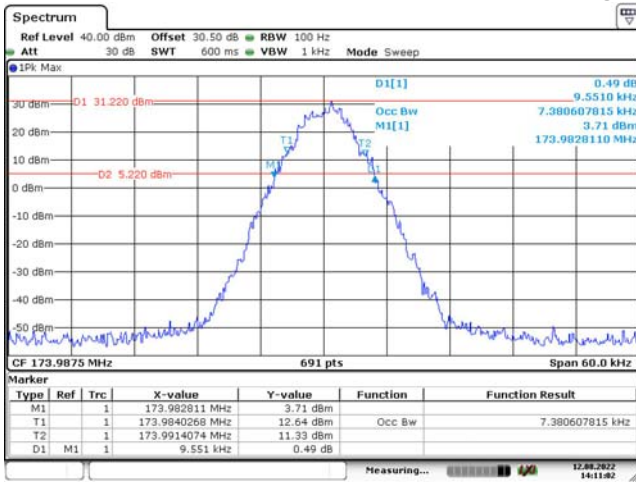

Date: 12.AUG.2022 14:11:02

Date: 12.AUG.2022 14:45:02

Additional Channel Part 74, 161.1 MHz

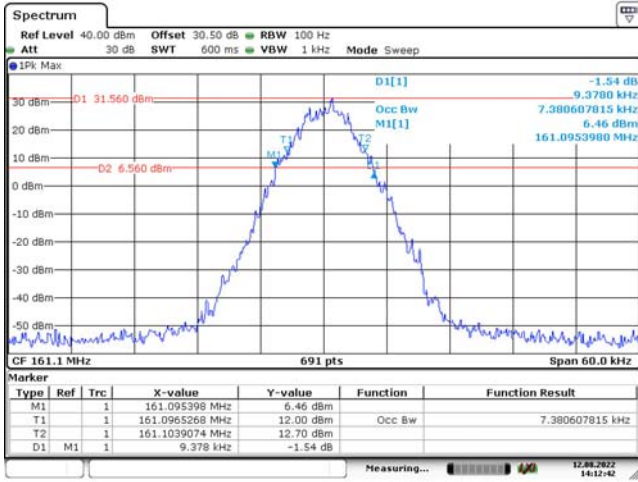

Date: 12.AUG.2022 14:12:43

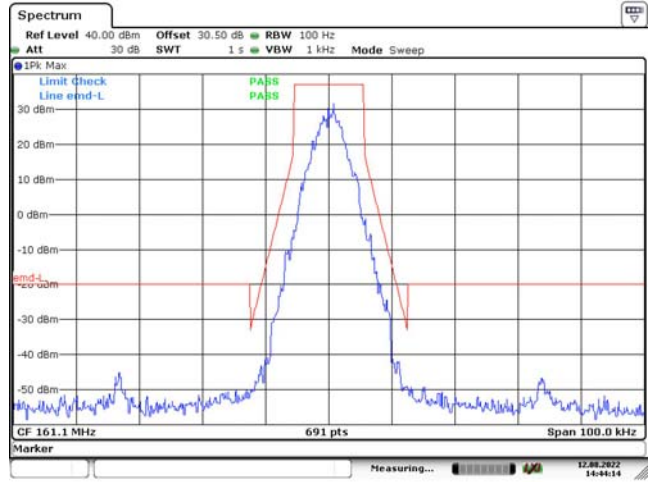

Date: 12.AUG.2022 14:44:14

Additional Channel Part 22, 150.8125 MHz

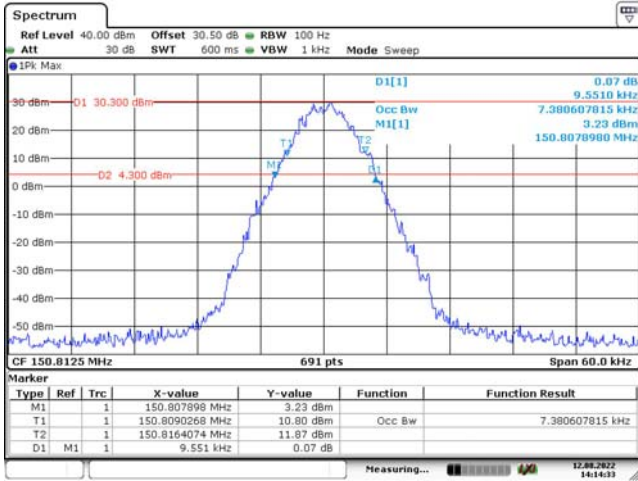

Date: 12.AUG.2022 14:14:33

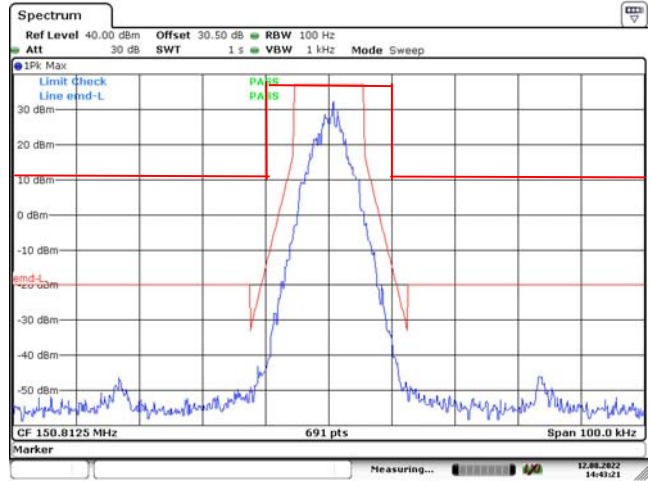

Date: 12.AUG.2022 14:43:21

FM, 25 kHz, High Power:

Additional Channel Part 80, 154.0125 MHz

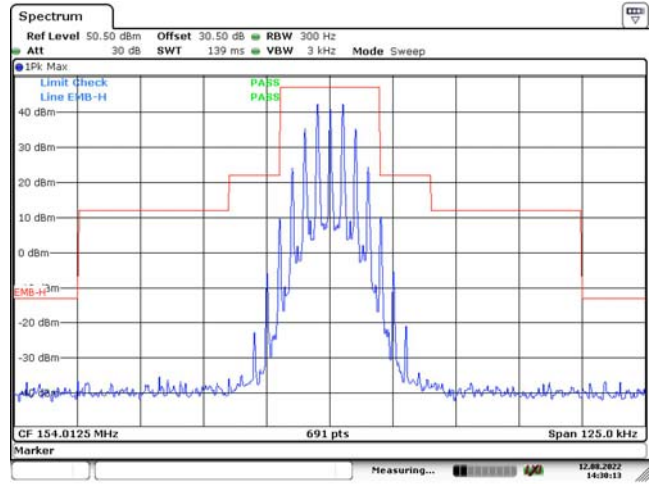
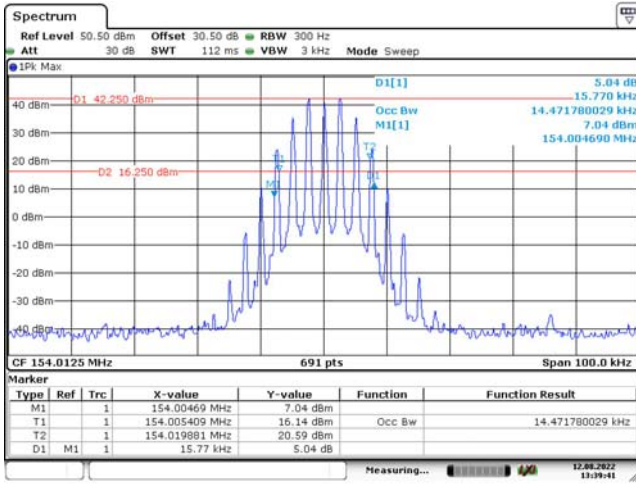

Date: 12.AUG.2022 13:39:41

Date: 12.AUG.2022 14:30:13

Additional Channel Part 74, 161.1 MHz

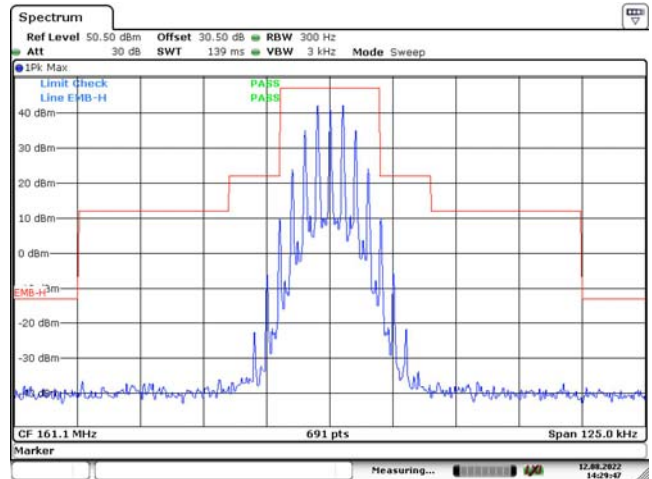
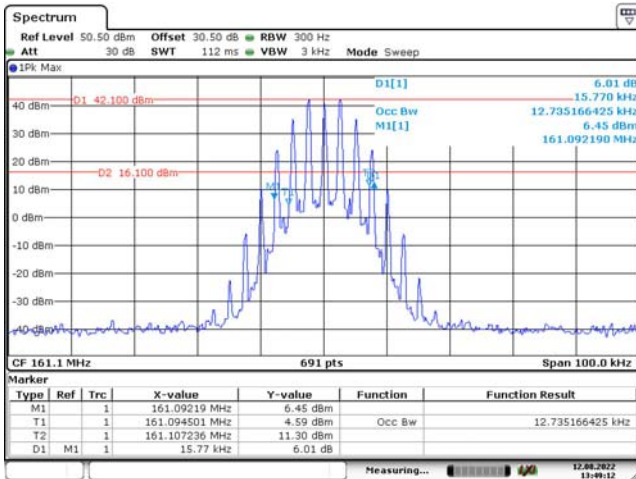

Date: 12.AUG.2022 13:49:13

Date: 12.AUG.2022 14:29:47

Additional Channel Part 22, 150.8125 MHz

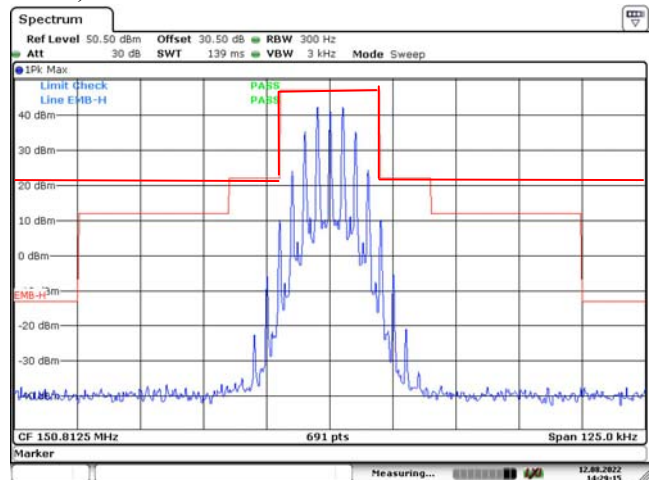
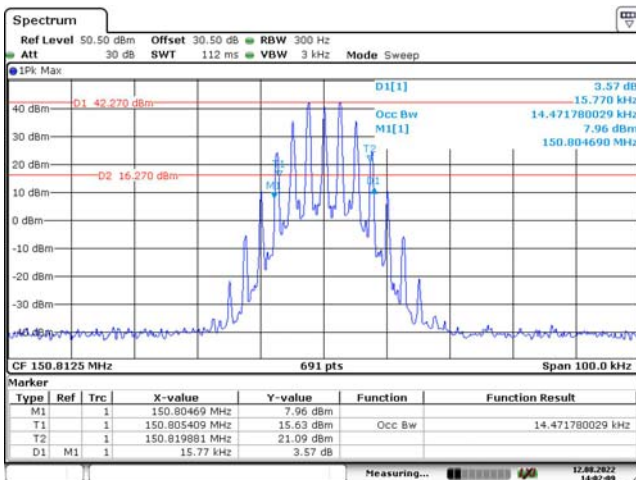

Date: 12.AUG.2022 14:02:10

Date: 12.AUG.2022 14:29:15

FM, 25 kHz, Low Power:

Additional Channel Part 80, 154.0125 MHz

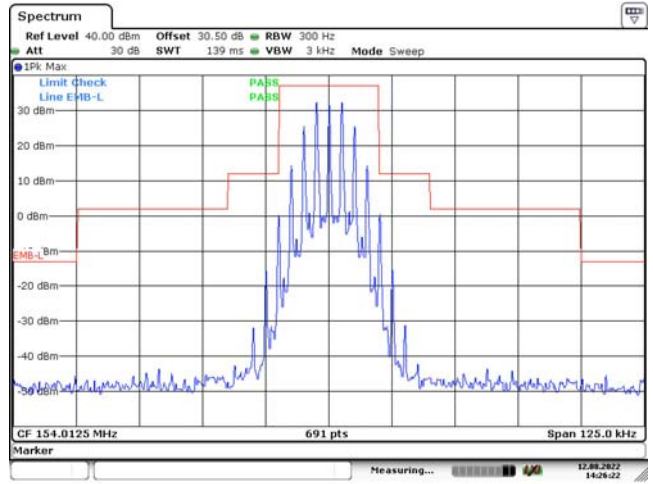
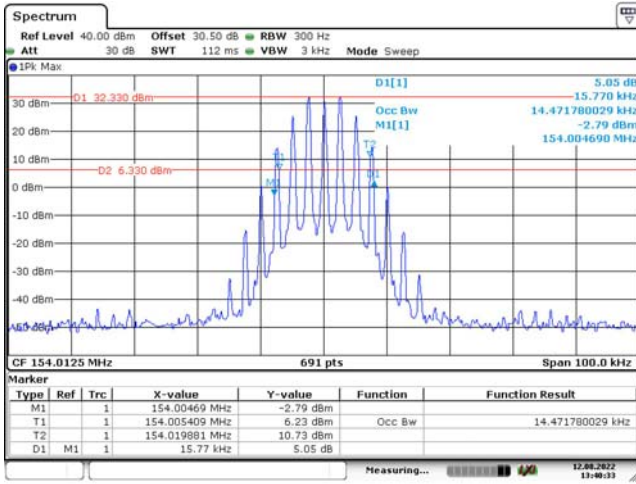

Date: 12.AUG.2022 13:40:33

Date: 12.AUG.2022 14:26:23

Additional Channel Part 74, 161.1 MHz

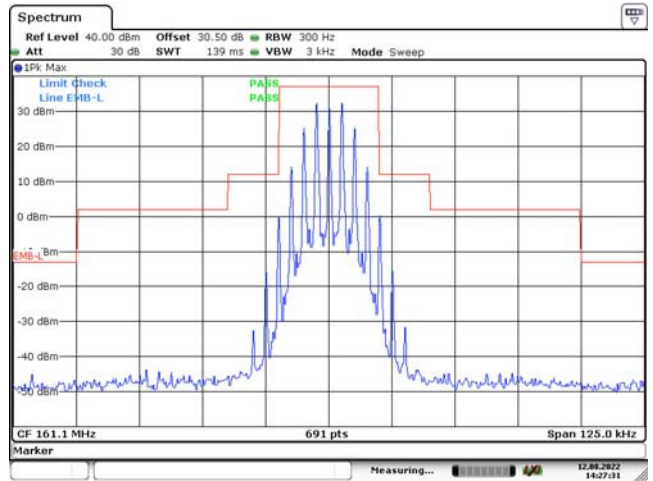
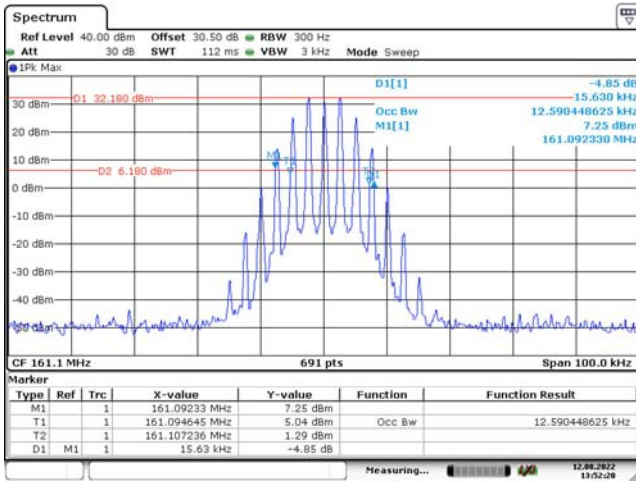

Date: 12.AUG.2022 13:52:20

Date: 12.AUG.2022 14:27:31

Additional Channel Part 22, 150.8125 MHz

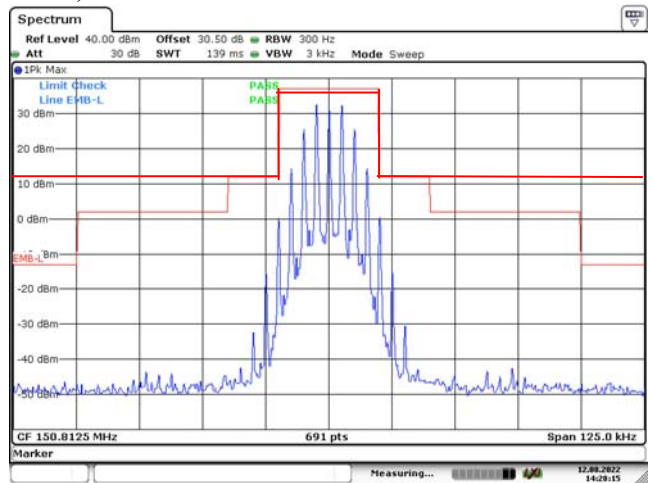
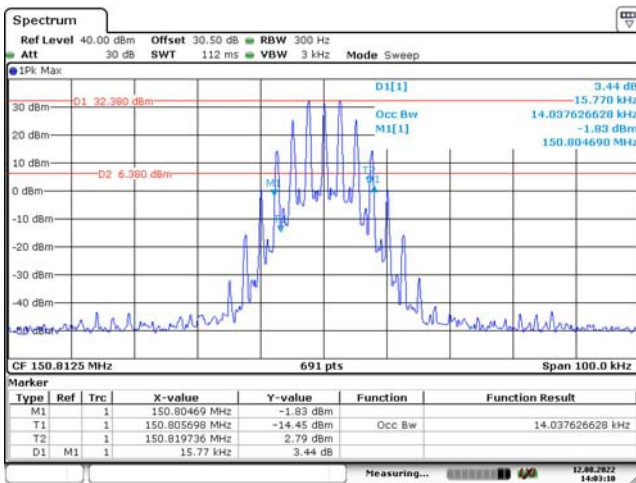

Date: 12.AUG.2022 14:03:11

Date: 12.AUG.2022 14:28:15

4.4 SPURIOUS EMISSIONS AT ANTENNA TERMINALS:

Serial Number:	CR22080001-RF-S1	Test Date:	2022-08-12
Test Site:	RF	Test Mode:	Transmitting
Tester:	Rinka Li	Test Result:	Pass

Environmental Conditions:

Temperature: (°C)	27.8	Relative Humidity: (%)	46.5	ATM Pressure: (kPa)	100.3
----------------------	------	------------------------------	------	------------------------	-------

Test Equipment List and Details:

Manufacturer	Description	Model	Serial Number	Calibration Date	Calibration Due Date
R&S	Spectrum Analyzer	FSV40	101474	2022-07-15	2023-07-14
zhuoxiang	Coaxial Cable	SMA-178	211002	Each time	N/A
YINSAIGE	Coaxial Cable	SS402	SJ0100002	Each time	N/A
Weinschel	Coaxial Attenuators	53-20-34	LN751	Each time	N/A
HP	RF Communications Test Set	8920A	3438A05209	2022-07-15	2023-07-14

* Statement of Traceability: China Certification ICT Co., Ltd (Dongguan) attests that all calibrations have been performed, traceable to National Primary Standards and International System of Units (SI).

Test Data:

Note: Only High power was tested.

FM, 12.5kHz:

Low Channel, 136.0125 MHz

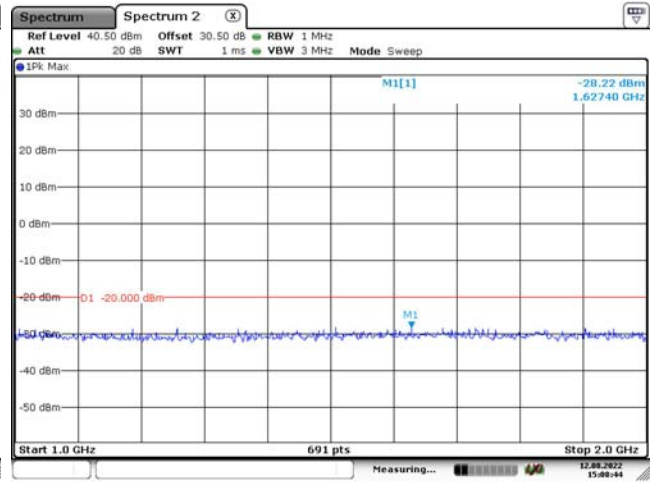
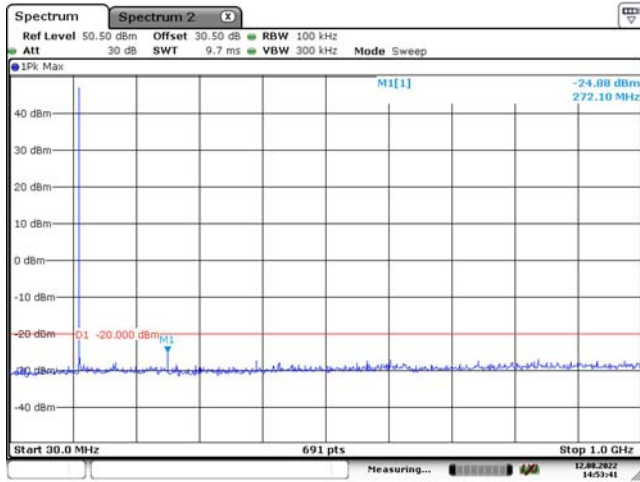

Date: 12.AUG.2022 14:53:42

Date: 12.AUG.2022 15:08:44

Middle Channel, 155.7525 MHz

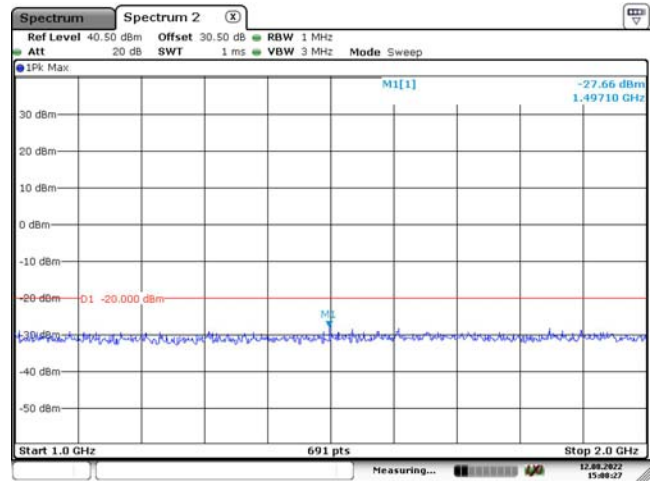
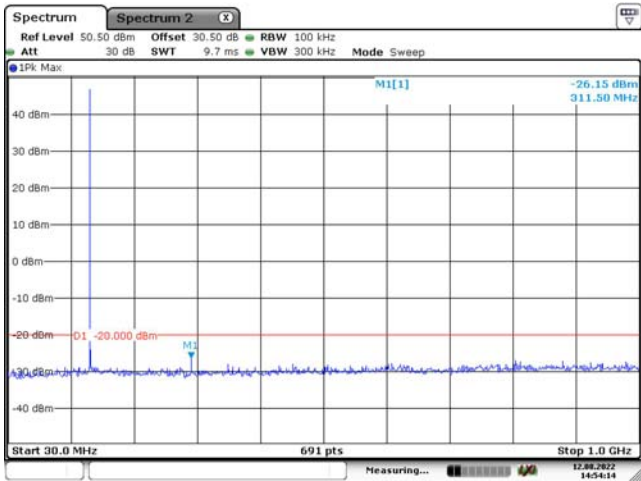

Date: 12.AUG.2022 14:54:15

Date: 12.AUG.2022 15:08:27

High Channel, 173.9875 MHz

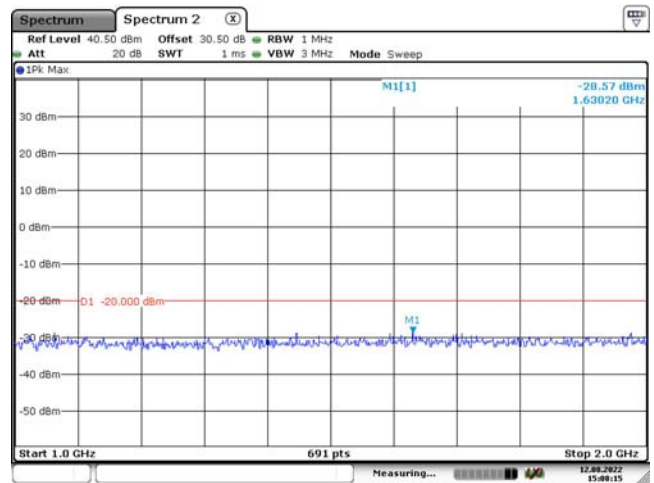
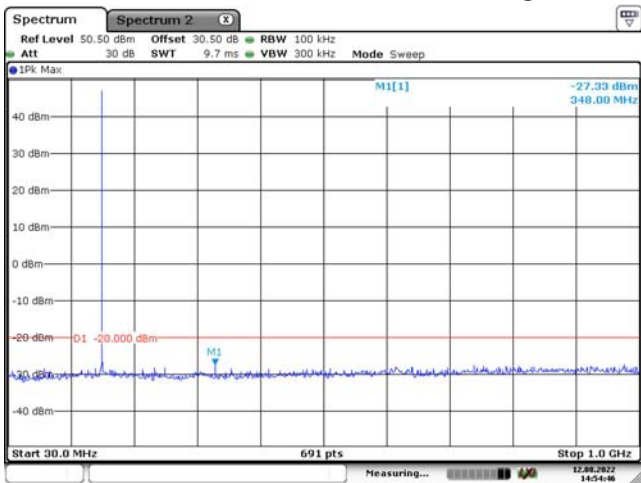

Date: 12.AUG.2022 14:54:46

Date: 12.AUG.2022 15:08:15

Part 74, FM,12.5kHz, 161.1 MHz

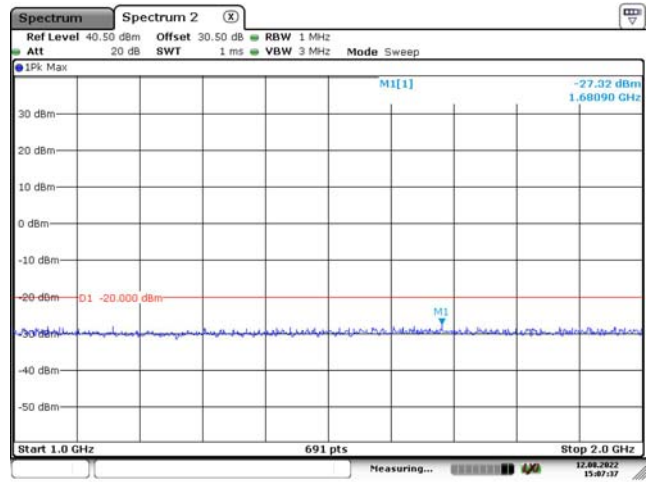
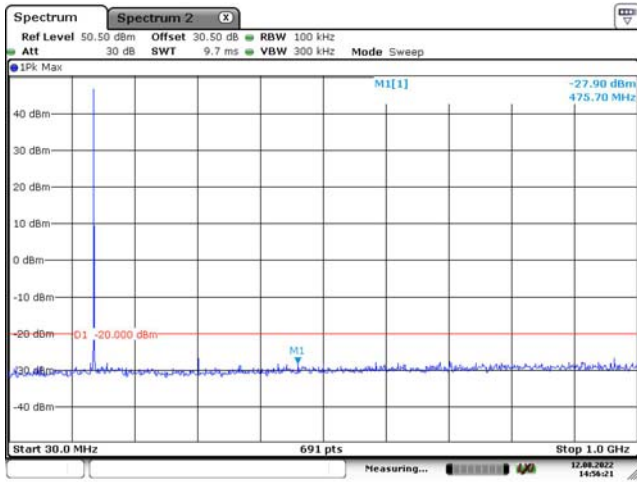

Part 22, FM,12.5kHz, 150.8125 MHz

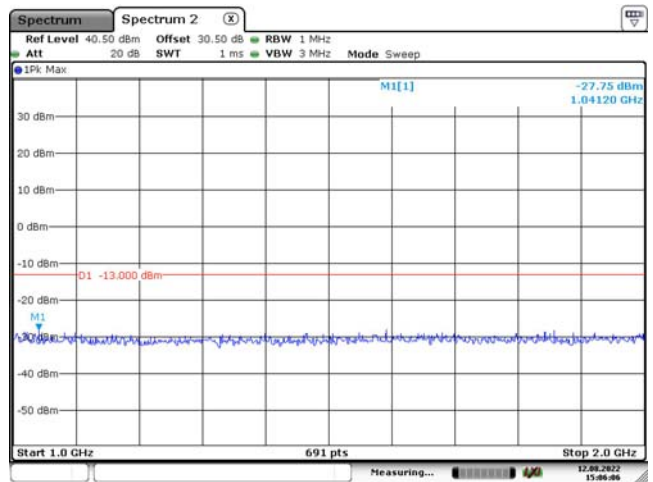
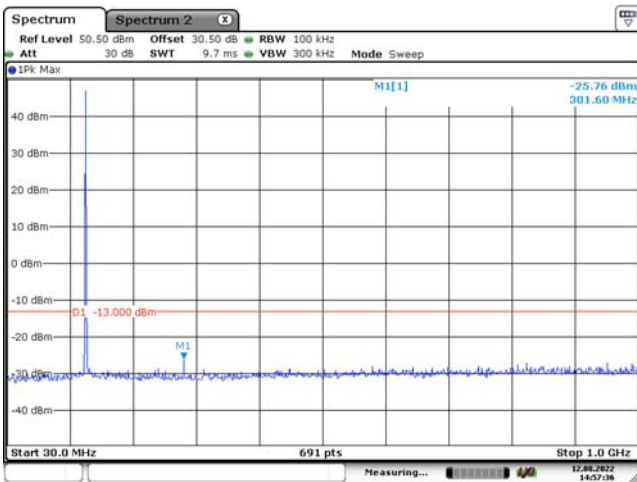

4FSK, 12.5kHz:

Low Channel, 136.0125 MHz

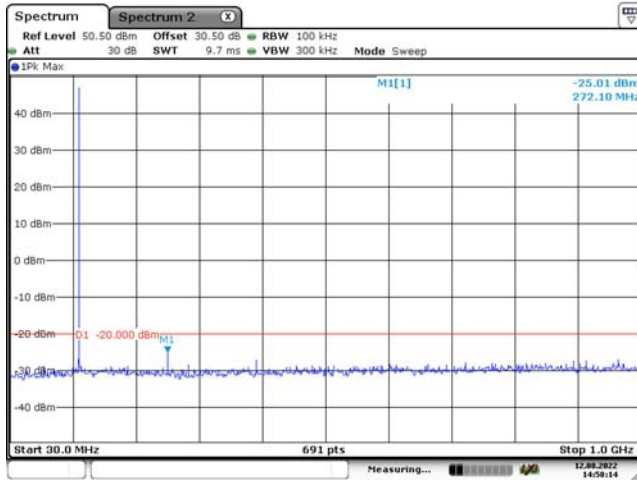

Date: 12.AUG.2022 14:58:14

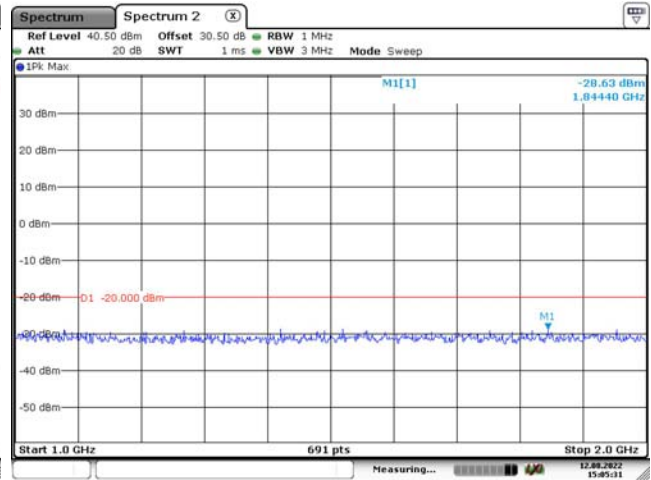

Date: 12.AUG.2022 15:05:32

Middle Channel, 155.7525 MHz

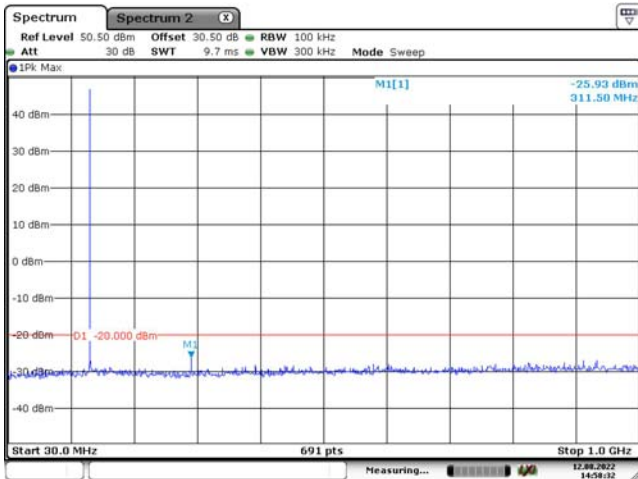

Date: 12.AUG.2022 14:58:33

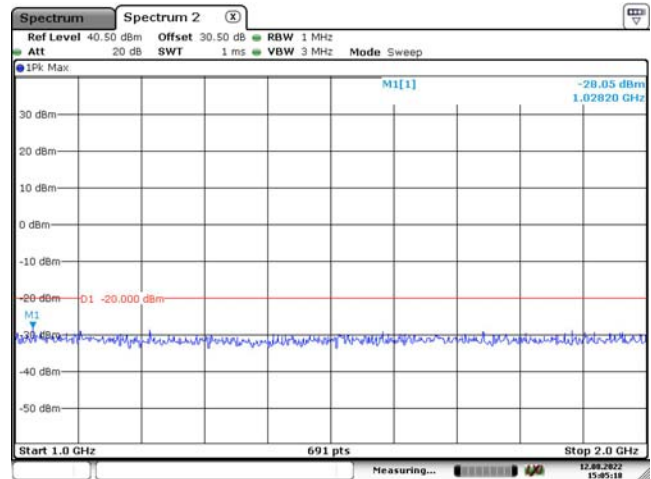

Date: 12.AUG.2022 15:05:18

High Channel, 173.9875 MHz

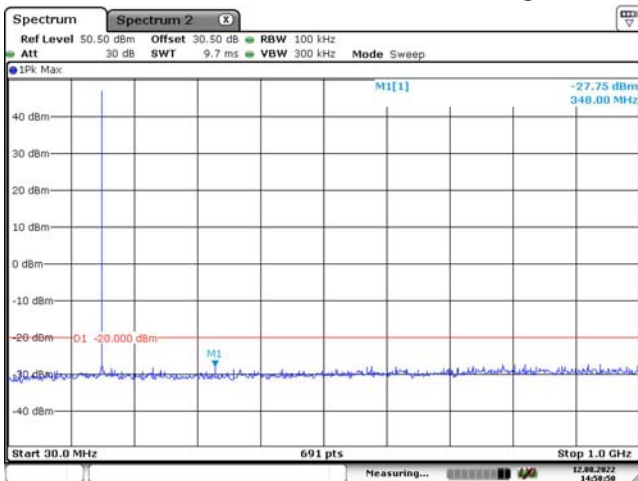

Date: 12.AUG.2022 14:58:50

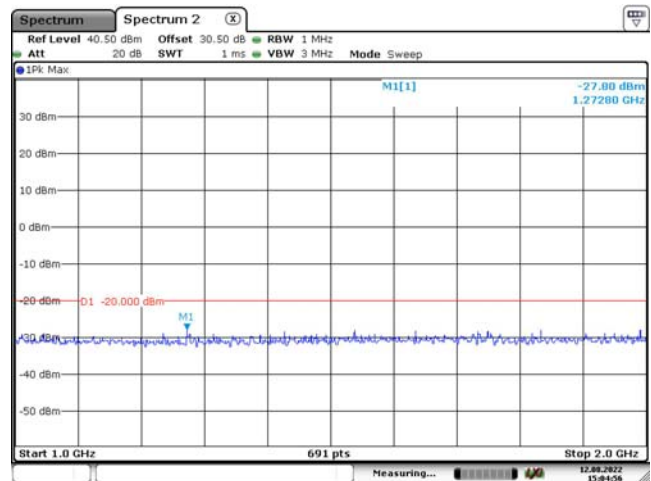

Date: 12.AUG.2022 15:04:57

Part 74, FM, 12.5kHz, 161.1 MHz

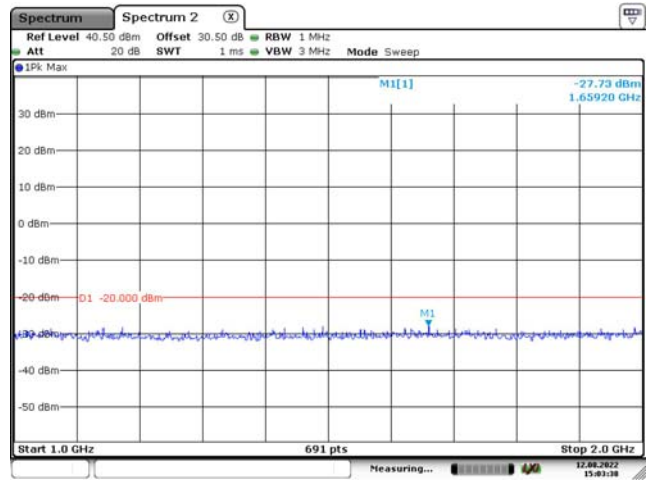
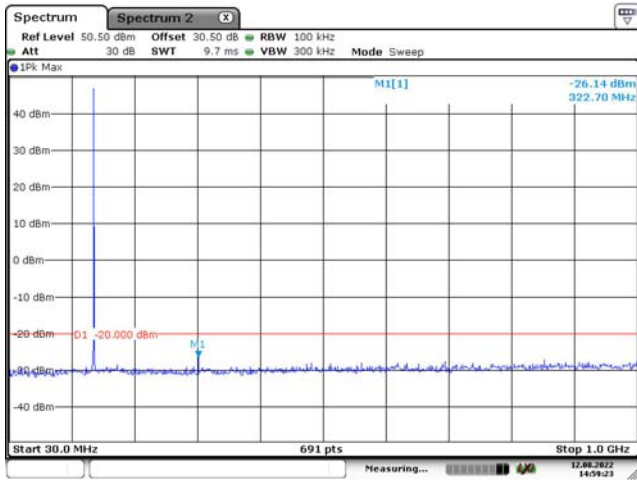

Part 22, FM, 12.5kHz, 150.8125 MHz

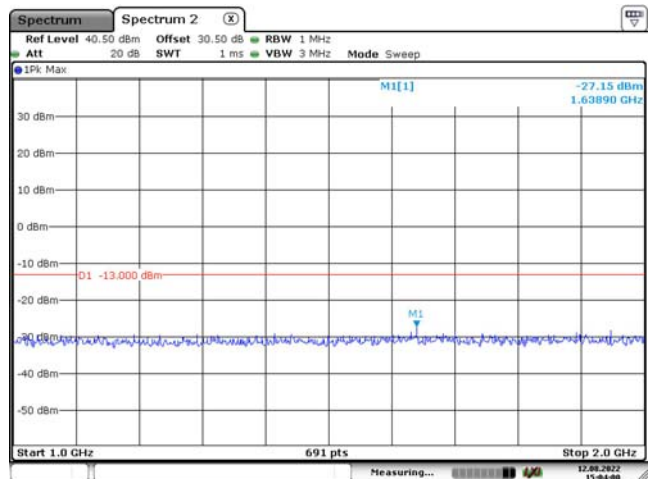
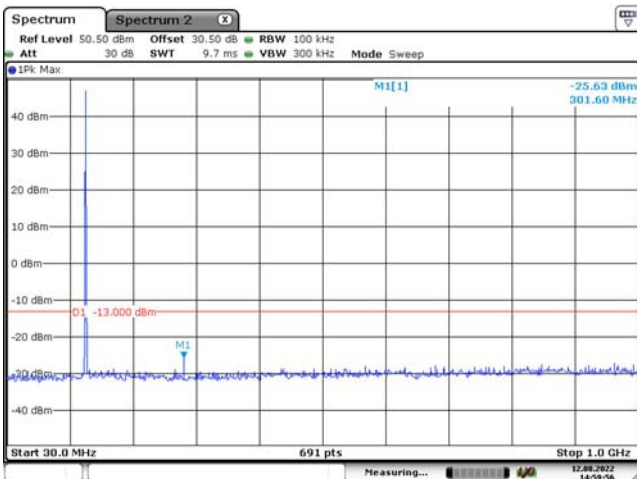

Part 80, FM, 25kHz, 154.0125 MHz

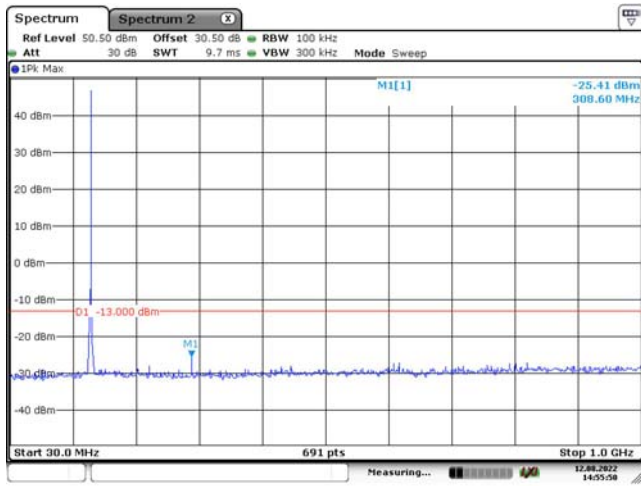

Date: 12.AUG.2022 14:55:51

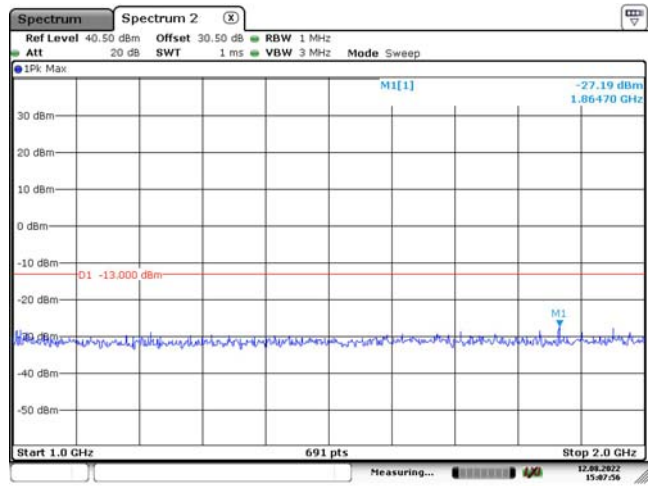

Date: 12.AUG.2022 15:07:57

Part 74, FM, 25kHz, 161.1000 MHz

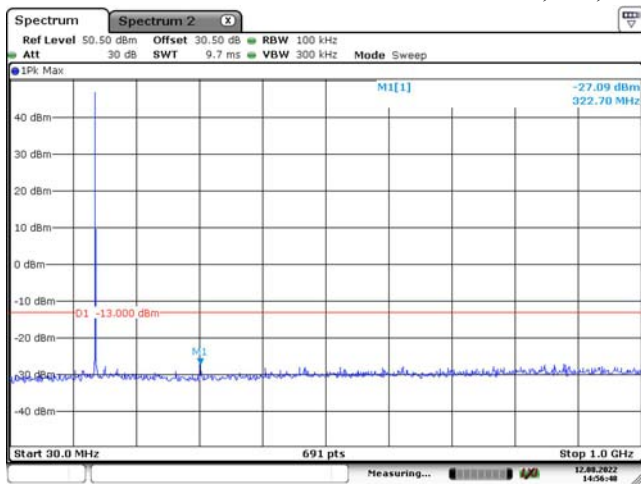

Date: 12.AUG.2022 14:56:48

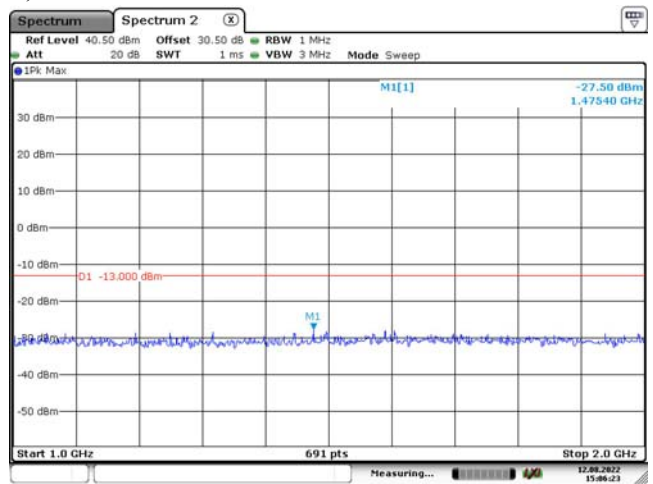

Date: 12.AUG.2022 15:06:23

Part 22, FM, 25kHz, 150.8125 MHz

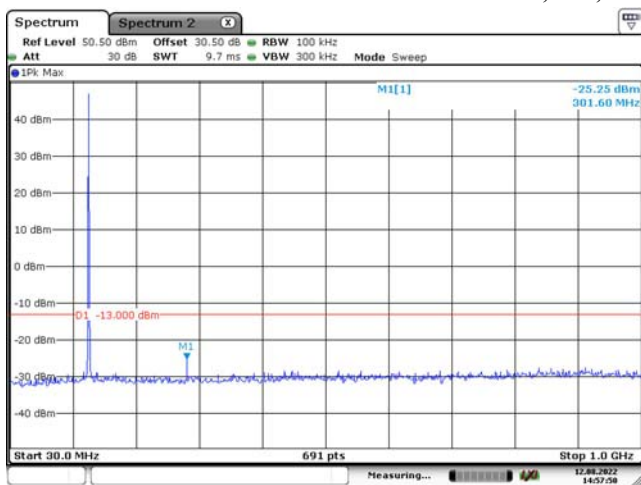

Date: 12.AUG.2022 14:57:50

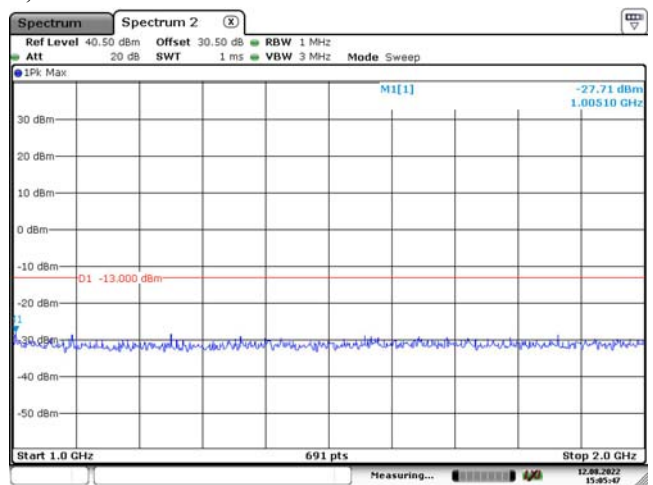

Date: 12.AUG.2022 15:05:48

4.5 MODULATION CHARACTERISTIC:

Serial Number:	CR22080001-RF-S1	Test Date:	2022-08-12
Test Site:	RF	Test Mode:	Transmitting
Tester:	Rinka Li	Test Result:	Pass

Environmental Conditions:

Temperature: (°C)	27.8	Relative Humidity: (%)	46.5	ATM Pressure: (kPa)	100.3
----------------------	------	------------------------------	------	------------------------	-------

Test Equipment List and Details:

Manufacturer	Description	Model	Serial Number	Calibration Date	Calibration Due Date
zhuoxiang	Coaxial Cable	SMA-178	211002	Each time	N/A
YINSAIGE	Coaxial Cable	SS402	SJ0100002	Each time	N/A
Weinschel	Coaxial Attenuators	53-20-34	LN751	Each time	N/A
HP	RF Communications Test Set	8920A	3438A05209	2022-07-15	2023-07-14

* Statement of Traceability: China Certification ICT Co., Ltd (Dongguan) attests that all calibrations have been performed, traceable to National Primary Standards and International System of Units (SI).

Test Data:

Audio Frequency Response – High Power

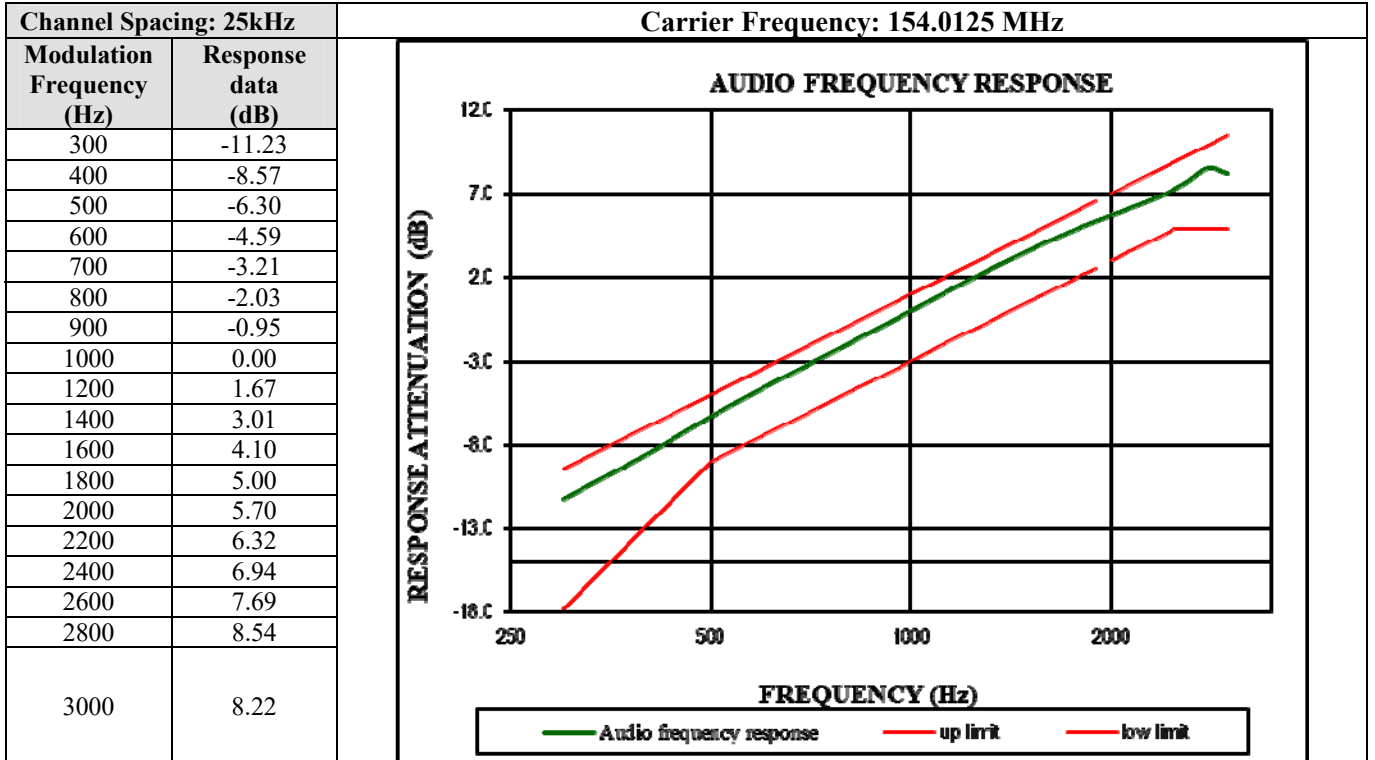
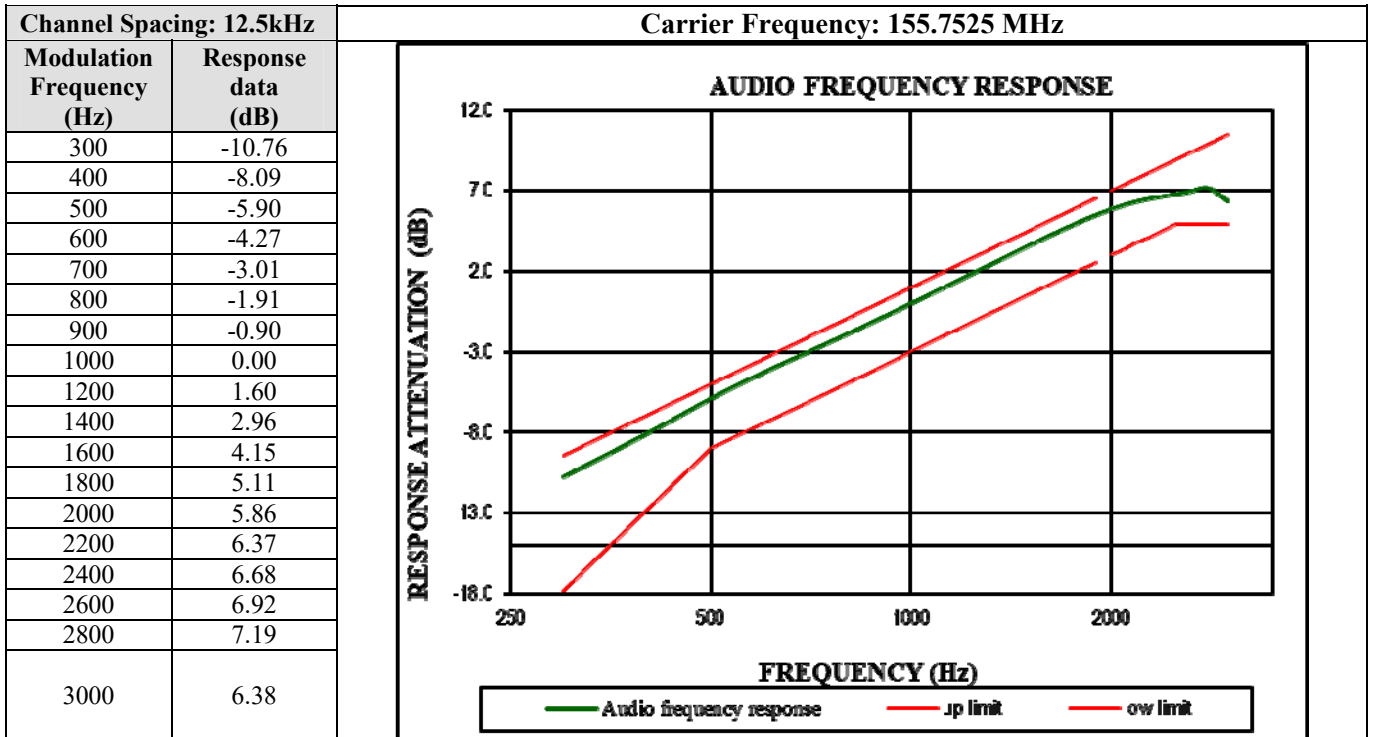

Modulation Limiting – High Power

Audio Frequency (Hz)	Carrier Frequency: 155.7525 MHz				Limit [kHz]
	Instantaneous		Steady-state		
	Deviation (@+20dB) [kHz]	Deviation (@-20dB) [kHz]	Deviation (@+20dB) [kHz]	Deviation (@-20dB) [kHz]	
300	0.621	0.078	0.606	0.041	2.5
400	0.806	0.091	0.784	0.085	2.5
500	1.045	0.105	0.997	0.086	2.5
600	1.255	0.134	1.244	0.117	2.5
700	1.451	0.137	1.439	0.128	2.5
800	1.631	0.154	1.585	0.110	2.5
900	1.736	0.173	1.710	0.091	2.5
1000	1.866	0.184	1.856	0.110	2.5
1200	1.968	0.214	1.909	0.202	2.5
1400	1.993	0.256	1.990	0.250	2.5
1600	2.008	0.274	1.990	0.257	2.5
1800	1.999	0.297	1.989	0.294	2.5
2000	1.965	0.311	1.930	0.269	2.5
2200	1.956	0.336	1.955	0.295	2.5
2400	1.898	0.353	1.866	0.347	2.5
2600	1.865	0.379	1.804	0.329	2.5
2800	1.807	0.373	1.754	0.316	2.5
3000	1.645	0.346	1.628	0.289	2.5

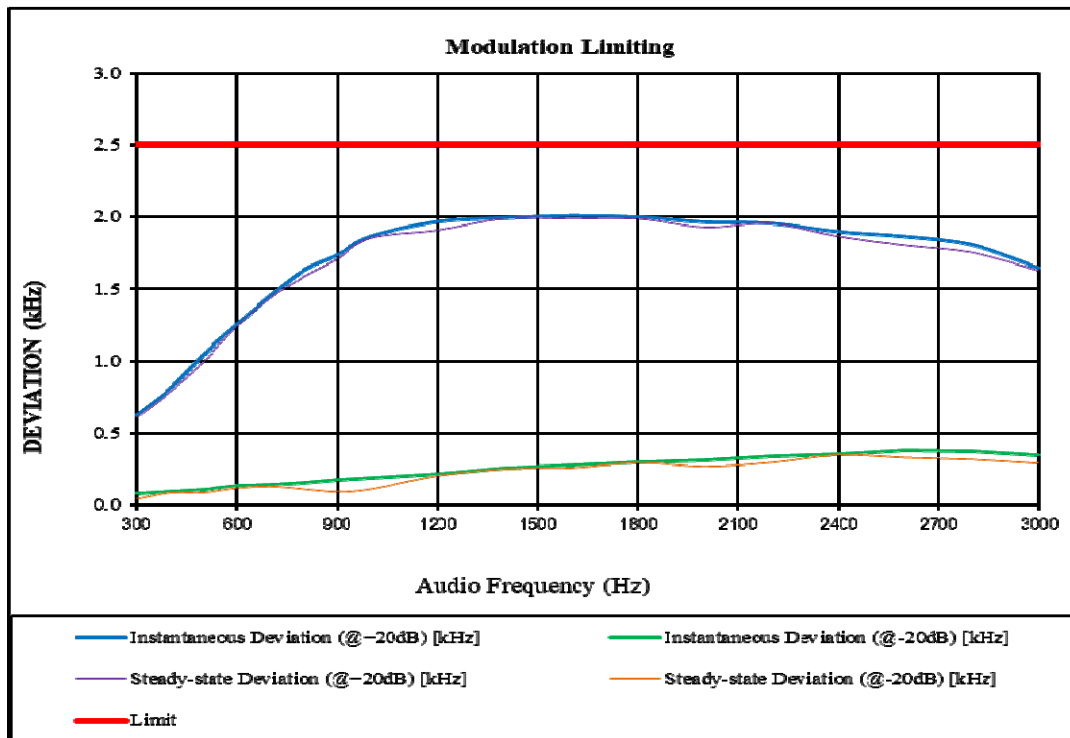

Channel Spacing: 25kHz		Carrier Frequency: 154.0125 MHz			
Audio Frequency (Hz)	Instantaneous		Steady-state		Limit [kHz]
	Deviation (@+20dB) [kHz]	Deviation (@-20dB) [kHz]	Deviation (@+20dB) [kHz]	Deviation (@-20dB) [kHz]	
300	1.148	0.138	1.114	0.101	5
400	1.532	0.152	1.518	0.116	5
500	1.976	0.188	1.971	0.154	5
600	2.384	0.223	2.333	0.195	5
700	2.755	0.254	2.715	0.227	5
800	3.097	0.276	3.058	0.224	5
900	3.299	0.312	3.265	0.286	5
1000	3.518	0.351	3.465	0.288	5
1200	3.702	0.407	3.648	0.396	5
1400	3.798	0.476	3.785	0.465	5
1600	3.831	0.528	3.818	0.514	5
1800	3.818	0.575	3.814	0.563	5
2000	3.719	0.604	3.681	0.559	5
2200	3.664	0.674	3.646	0.625	5
2400	3.692	0.751	3.665	0.733	5
2600	3.886	0.806	3.827	0.753	5
2800	4.078	0.874	4.048	0.832	5
3000	3.848	0.841	3.821	0.837	5

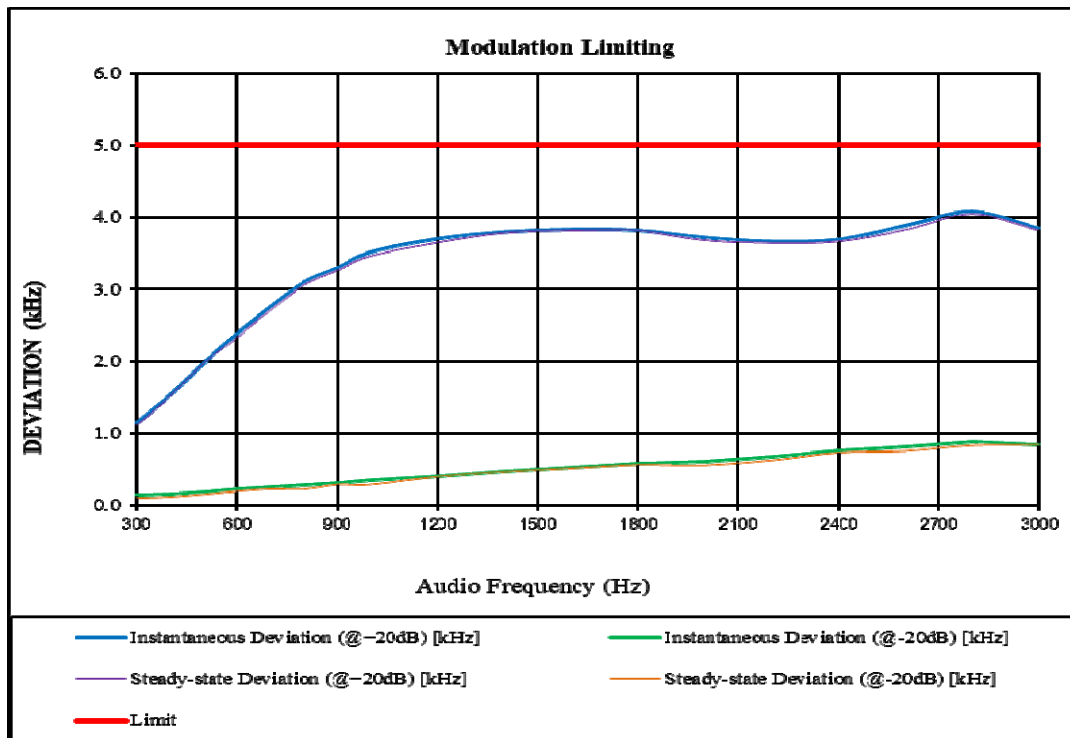

Audio Frequency Low Pass Filter Response – High Power

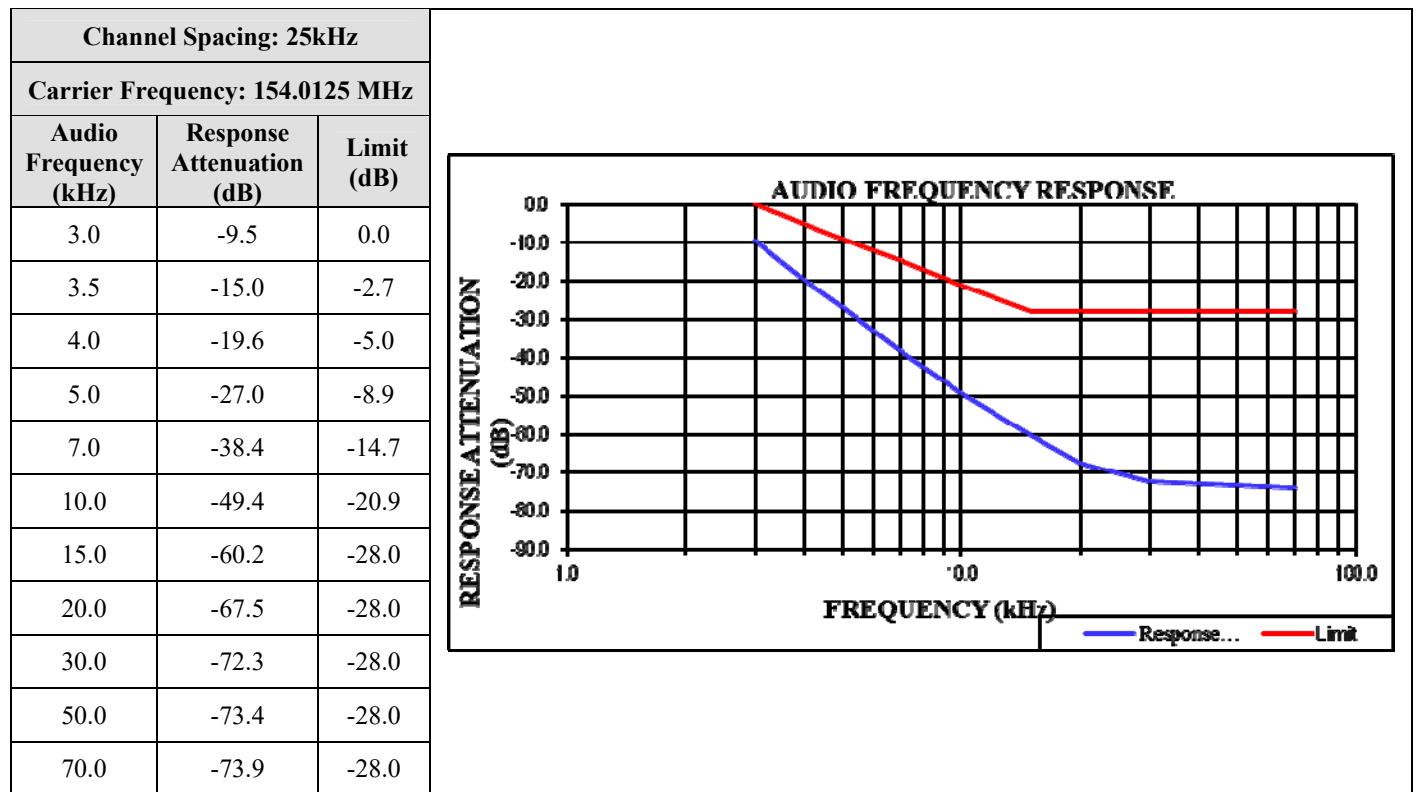
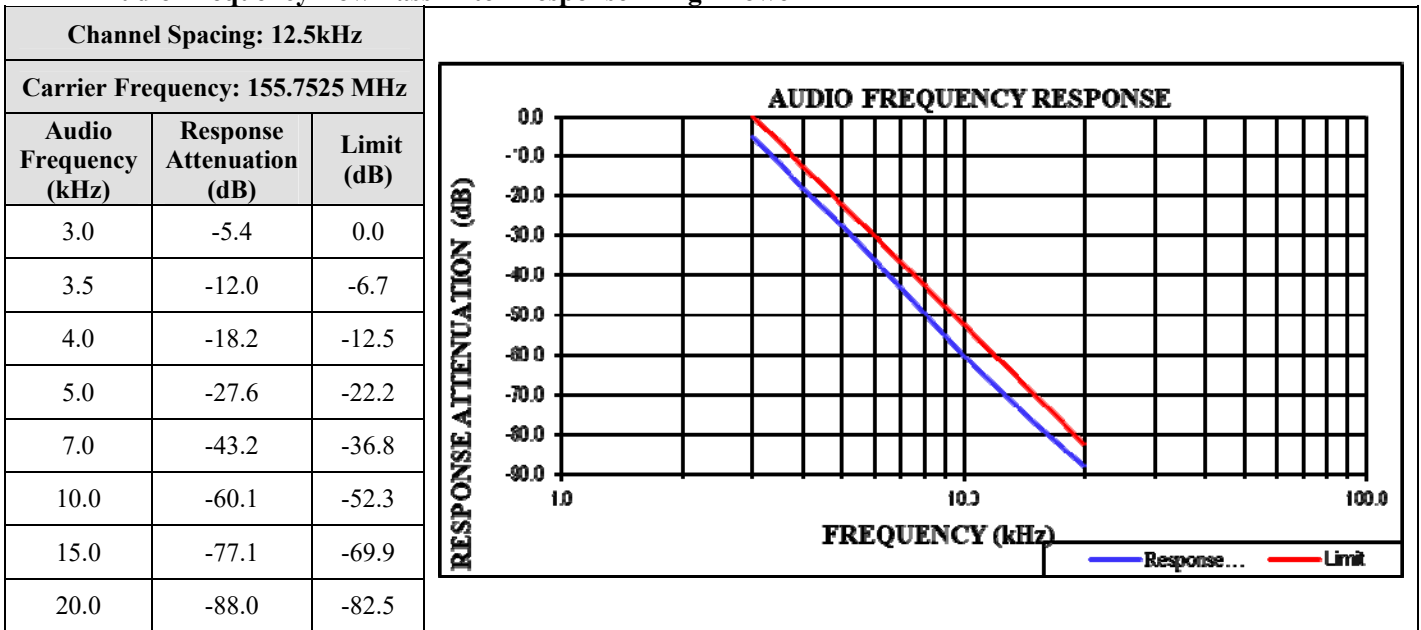

4.6 TRANSIENT FREQUENCY BEHAVIOR

Serial Number:	CR22080001-RF-S1	Test Date:	2022-09-19
Test Site:	RF	Test Mode:	Transmitting
Tester:	Rinka Li	Test Result:	Pass

Environmental Conditions:

Temperature: (°C)	27.8	Relative Humidity: (%)	46.5	ATM Pressure: (kPa)	100.3
----------------------	------	------------------------------	------	------------------------	-------

Test Equipment List and Details:

Manufacturer	Description	Model	Serial Number	Calibration Date	Calibration Due Date
R&S	Signal Analyzer	FSIQ26	831929/006	2022-07-15	2023-07-14
zhuoxiang	Coaxial Cable	SMA-178	211002	Each time	N/A
YINSAIGE	Coaxial Cable	SS402	SJ0100002	Each time	N/A
Weinschel	Coaxial Attenuators	53-20-34	LN751	Each time	N/A
HP	RF Communications Test Set	8920A	3438A05209	2022-07-15	2023-07-14

* Statement of Traceability: China Certification ICT Co., Ltd (Dongguan) attests that all calibrations have been performed, traceable to National Primary Standards and International System of Units (SI).

Test Data:

Channel Spacing (kHz)	Transient Period (ms)	Transient Frequency	Result
12.5	5(t ₁)	±12.5 kHz	Pass
	20(t ₂)	±6.25 kHz	
	5(t ₃)	±12.5 kHz	

Note: During the time from the end of t₂ to the beginning of t₃, the frequency difference must not exceed the limits specified in §90.213:

For 155.7525 MHz 12.5kHz mode, limit is: 155.7525 MHz* 5ppm = 0.779kHz

Turn ON

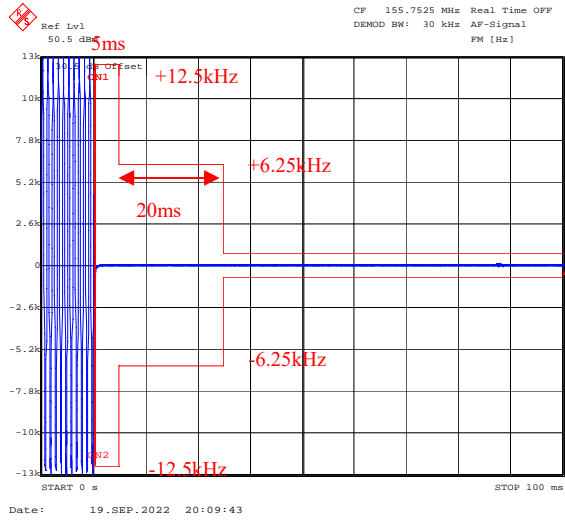

Turn OFF

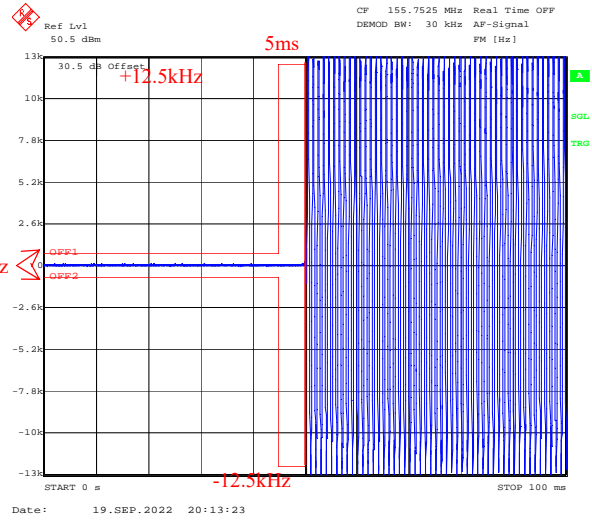

4.7 RADIATED SPURIOUS EMISSIONS:

Serial Number:	CR22080001-RF-S1	Test Date:	2022-09-06~2022-09-07
Test Site:	966-1/966-2	Test Mode:	Transmit
Tester:	Carl Xue	Test Result:	Pass

Environmental Conditions:

Temperature: (°C)	26.1~26.7	Relative Humidity: (%)	51~54	ATM Pressure: (kPa)	100.1~100.7
----------------------	-----------	---------------------------	-------	---------------------------	-------------

Test Equipment List and Details:

Manufacturer	Description	Model	Serial Number	Calibration Date	Calibration Due Date
Sunol Sciences	Antenna	JB6	A082520-5	2020-10-19	2023-10-18
R&S	EMI Test Receiver	ESR3	102724	2022-07-15	2023-07-14
TIMES MICROWAVE	Coaxial Cable	LMR-600-UltraFlex	C-0470-02	2022-07-17	2023-07-16
TIMES MICROWAVE	Coaxial Cable	LMR-600-UltraFlex	C-0780-01	2022-07-17	2023-07-16
Sonoma	Amplifier	310N	186165	2022-07-17	2023-07-16
EMCO	Adjustable Dipole Antenna	3121C	9109-756	N/A	N/A
MICRO-COAX	Coaxial Cable	UFA210B-0-0720- 300300	99G1448	2022-07-17	2023-07-16
Agilent	Signal Generator	E8247C	MY43321352	2022-04-01	2023-03-31
ETS-Lindgren	Horn Antenna	3115	9912-5985	2020-10-13	2023-10-12
R&S	Spectrum Analyzer	FSV40	101591	2022-07-15	2023-07-14
MICRO-COAX	Coaxial Cable	UFA210A-1-1200- 70U300	217423-008	2022-08-07	2023-08-06
MICRO-COAX	Coaxial Cable	UFA210A-1-2362- 300300	235780-001	2022-08-07	2023-08-06
Mini	Pre-amplifier	ZVA-183-S+	5969001149	2021-11-10	2022-11-09
AH	Double Ridge Guide Horn Antenna	SAS-571	1396	2021-10-18	2024-10-17
MICRO-COAX	Coaxial Cable	UFA210B-0-0720- 300300	99G1448	2022-07-17	2023-07-16

** Statement of Traceability: China Certification ICT Co., Ltd (Dongguan) attests that all calibrations have been performed, traceable to National Primary Standards and International System of Units (SI).*

Model: MD612 VHF:
30MHz - 2GHz:
Part 90

Frequency (MHz)	Polar (H/V)	Receiver Reading (dB μ V)	Substituted Method			Absolute Level (dBm)	Limit (dBm)	Margin (dB)
			Substituted Level (dBm)	Antenna Gain (dBd/dBi)	Cable Loss (dB)			
FM, Frequency: 136.0125MHz-12.5 kHz								
272.03	H	64.01	-47.37	0.00	0.31	-47.68	-20.00	27.68
272.03	V	65.41	-44.61	0.00	0.31	-44.92	-20.00	24.92
408.04	H	66.53	-42.49	0.00	0.40	-42.89	-20.00	22.89
408.04	V	70.54	-35.39	0.00	0.40	-35.79	-20.00	15.79
544.05	H	46.74	-59.22	0.00	0.47	-59.69	-20.00	39.69
544.05	V	47.00	-56.14	0.00	0.47	-56.61	-20.00	36.61
680.06	H	37.20	-67.45	0.00	0.52	-67.97	-20.00	47.97
680.06	V	34.20	-67.56	0.00	0.52	-68.08	-20.00	48.08
816.08	H	38.95	-62.89	0.00	0.55	-63.44	-20.00	43.44
816.08	V	42.18	-56.19	0.00	0.55	-56.74	-20.00	36.74
952.09	H	39.18	-58.55	0.00	0.59	-59.14	-20.00	39.14
952.09	V	40.05	-55.24	0.00	0.59	-55.83	-20.00	35.83
1088.10	H	43.24	-58.67	7.35	0.67	-51.99	-20.00	31.99
1088.10	V	40.05	-62.31	7.35	0.67	-55.63	-20.00	35.63
1224.11	H	36.42	-66.41	7.73	0.69	-59.37	-20.00	39.37
1224.11	V	36.75	-66.75	7.73	0.69	-59.71	-20.00	39.71
1360.13	H	35.90	-67.42	8.11	0.77	-60.08	-20.00	40.08
1360.13	V	37.25	-66.28	8.11	0.77	-58.94	-20.00	38.94
4FSK, Frequency: 136.0125MHz-12.5 kHz								
272.03	H	80.05	-31.33	0.00	0.31	-31.64	-20.00	11.64
272.03	V	84.55	-25.47	0.00	0.31	-25.78	-20.00	5.78
408.04	H	64.77	-44.25	0.00	0.40	-44.65	-20.00	24.65
408.04	V	72.67	-33.26	0.00	0.40	-33.66	-20.00	13.66
544.05	H	48.35	-57.61	0.00	0.47	-58.08	-20.00	38.08
544.05	V	59.59	-43.55	0.00	0.47	-44.02	-20.00	24.02
680.06	H	41.37	-63.28	0.00	0.52	-63.80	-20.00	43.80
680.06	V	52.89	-48.87	0.00	0.52	-49.39	-20.00	29.39
816.08	H	43.11	-58.73	0.00	0.55	-59.28	-20.00	39.28
816.08	V	43.07	-55.30	0.00	0.55	-55.85	-20.00	35.85
952.09	H	42.22	-55.51	0.00	0.59	-56.10	-20.00	36.10
952.09	V	40.92	-54.37	0.00	0.59	-54.96	-20.00	34.96
1088.10	H	45.07	-56.84	7.35	0.67	-50.16	-20.00	30.16
1088.10	V	44.00	-58.36	7.35	0.67	-51.68	-20.00	31.68
1224.11	H	37.41	-65.42	7.73	0.69	-58.38	-20.00	38.38
1224.11	V	36.07	-67.43	7.73	0.69	-60.39	-20.00	40.39
1360.13	H	35.51	-67.81	8.11	0.77	-60.47	-20.00	40.47
1360.13	V	36.40	-67.13	8.11	0.77	-59.79	-20.00	39.79

Frequency (MHz)	Polar (H/V)	Receiver Reading (dBμV)	Substituted Method			Absolute Level (dBm)	Limit (dBm)	Margin (dB)
			Substituted Level (dBm)	Antenna Gain (dBd/dBi)	Cable Loss (dB)			
FM, Frequency: 155.7525MHz-12.5 kHz								
311.51	H	70.66	-39.89	0.00	0.34	-40.23	-20.00	20.23
311.51	V	64.66	-43.85	0.00	0.34	-44.19	-20.00	24.19
467.26	H	62.08	-45.55	0.00	0.42	-45.97	-20.00	25.97
467.26	V	59.94	-43.90	0.00	0.42	-44.32	-20.00	24.32
623.01	H	28.31	-76.45	0.00	0.48	-76.93	-20.00	56.93
623.01	V	27.36	-75.79	0.00	0.48	-76.27	-20.00	56.27
778.76	H	43.70	-59.11	0.00	0.54	-59.65	-20.00	39.65
778.76	V	41.78	-57.50	0.00	0.54	-58.04	-20.00	38.04
934.52	H	37.24	-61.02	0.00	0.66	-61.68	-20.00	41.68
934.52	V	36.00	-59.68	0.00	0.66	-60.34	-20.00	40.34
1090.27	H	39.12	-62.74	7.35	0.67	-56.06	-20.00	36.06
1090.27	V	39.18	-63.14	7.35	0.67	-56.46	-20.00	36.46
1246.02	H	37.35	-65.45	7.79	0.68	-58.34	-20.00	38.34
1246.02	V	36.27	-67.14	7.79	0.68	-60.03	-20.00	40.03
1401.77	H	35.99	-67.72	8.22	0.71	-60.21	-20.00	40.21
1401.77	V	35.30	-68.45	8.22	0.71	-60.94	-20.00	40.94
1557.53	H	39.35	-64.62	8.57	0.80	-56.85	-20.00	36.85
1557.53	V	37.34	-66.69	8.57	0.80	-58.92	-20.00	38.92
4FSK, Frequency: 155.7525MHz-12.5 kHz								
311.51	H	84.90	-25.65	0.00	0.34	-25.99	-20.00	5.99
311.51	V	79.24	-29.27	0.00	0.34	-29.61	-20.00	9.61
467.26	H	77.59	-30.04	0.00	0.42	-30.46	-20.00	10.46
467.26	V	65.72	-38.12	0.00	0.42	-38.54	-20.00	18.54
623.01	H	64.57	-40.19	0.00	0.48	-40.67	-20.00	20.67
623.01	V	48.02	-55.13	0.00	0.48	-55.61	-20.00	35.61
778.76	H	53.82	-48.99	0.00	0.54	-49.53	-20.00	29.53
778.76	V	51.79	-47.49	0.00	0.54	-48.03	-20.00	28.03
934.52	H	42.44	-55.82	0.00	0.66	-56.48	-20.00	36.48
934.52	V	36.12	-59.56	0.00	0.66	-60.22	-20.00	40.22
1090.27	H	39.85	-62.01	7.35	0.67	-55.33	-20.00	35.33
1090.27	V	40.02	-62.30	7.35	0.67	-55.62	-20.00	35.62
1246.02	H	38.46	-64.34	7.79	0.68	-57.23	-20.00	37.23
1246.02	V	38.55	-64.86	7.79	0.68	-57.75	-20.00	37.75
1401.77	H	36.41	-67.30	8.22	0.71	-59.79	-20.00	39.79
1401.77	V	36.60	-67.15	8.22	0.71	-59.64	-20.00	39.64
1557.53	H	48.59	-55.38	8.57	0.80	-47.61	-20.00	27.61
1557.53	V	46.34	-57.69	8.57	0.80	-49.92	-20.00	29.92

Frequency (MHz)	Polar (H/V)	Receiver Reading (dBμV)	Substituted Method			Absolute Level (dBm)	Limit (dBm)	Margin (dB)
			Substituted Level (dBm)	Antenna Gain (dBd/dBi)	Cable Loss (dB)			
FM, Frequency: 173.9875MHz-12.5 kHz								
347.98	H	72.62	-40.66	0.00	0.36	-41.02	-20.00	21.02
347.98	V	69.34	-38.22	0.00	0.36	-38.58	-20.00	18.58
521.96	H	51.71	-54.70	0.00	0.41	-55.11	-20.00	35.11
521.96	V	57.05	-45.86	0.00	0.41	-46.27	-20.00	26.27
695.95	H	51.37	-53.25	0.00	0.55	-53.80	-20.00	33.80
695.95	V	49.96	-51.42	0.00	0.55	-51.97	-20.00	31.97
869.94	H	31.32	-68.89	0.00	0.58	-69.47	-20.00	49.47
869.94	V	30.03	-67.09	0.00	0.58	-67.67	-20.00	47.67
1043.93	H	46.08	-56.74	7.22	0.65	-50.17	-20.00	30.17
1043.93	V	43.47	-59.67	7.22	0.65	-53.10	-20.00	33.10
1217.91	H	38.74	-64.10	7.71	0.69	-57.08	-20.00	37.08
1217.91	V	37.35	-66.18	7.71	0.69	-59.16	-20.00	39.16
1391.90	H	36.71	-66.92	8.20	0.72	-59.44	-20.00	39.44
1391.90	V	36.58	-67.12	8.20	0.72	-59.64	-20.00	39.64
1565.89	H	41.47	-62.58	8.58	0.80	-54.80	-20.00	34.80
1565.89	V	39.26	-64.85	8.58	0.80	-57.07	-20.00	37.07
1739.88	H	36.39	-67.58	8.79	0.85	-59.64	-20.00	39.64
1739.88	V	36.60	-67.53	8.79	0.85	-59.59	-20.00	39.59
4FSK, Frequency: 173.9875MHz-12.5 kHz								
347.98	H	78.10	-31.90	0.00	0.36	-32.26	-20.00	12.26
347.98	V	74.24	-33.32	0.00	0.36	-33.68	-20.00	13.68
521.96	H	66.88	-39.53	0.00	0.41	-39.94	-20.00	19.94
521.96	V	62.68	-40.23	0.00	0.41	-40.64	-20.00	20.64
695.95	H	51.63	-52.99	0.00	0.55	-53.54	-20.00	33.54
695.95	V	51.10	-50.28	0.00	0.55	-50.83	-20.00	30.83
869.94	H	55.18	-45.03	0.00	0.58	-45.61	-20.00	25.61
869.94	V	45.40	-51.72	0.00	0.58	-52.30	-20.00	32.30
1043.93	H	46.27	-56.55	7.22	0.65	-49.98	-20.00	29.98
1043.93	V	42.86	-60.28	7.22	0.65	-53.71	-20.00	33.71
1217.91	H	40.04	-62.80	7.71	0.69	-55.78	-20.00	35.78
1217.91	V	38.62	-64.91	7.71	0.69	-57.89	-20.00	37.89
1391.90	H	40.65	-62.98	8.20	0.72	-55.50	-20.00	35.50
1391.90	V	40.04	-63.66	8.20	0.72	-56.18	-20.00	36.18
1565.89	H	51.97	-52.08	8.58	0.80	-44.30	-20.00	24.30
1565.89	V	48.78	-55.33	8.58	0.80	-47.55	-20.00	27.55
1739.88	H	43.21	-60.76	8.79	0.85	-52.82	-20.00	32.82
1739.88	V	37.62	-66.51	8.79	0.85	-58.57	-20.00	38.57

Part 74

Frequency (MHz)	Polar (H/V)	Receiver Reading (dBμV)	Substituted Method			Absolute Level (dBm)	Limit (dBm)	Margin (dB)
			Substituted Level (dBm)	Antenna Gain (dBd/dBi)	Cable Loss (dB)			
FM, Frequency: 161.1 MHz-12.5 kHz								
322.20	H	77.99	-32.39	0.00	0.34	-32.73	-20.00	12.73
322.20	V	68.33	-39.90	0.00	0.34	-40.24	-20.00	20.24
483.30	H	62.13	-45.12	0.00	0.42	-45.54	-20.00	25.54
483.30	V	58.40	-44.88	0.00	0.42	-45.30	-20.00	25.30
644.40	H	44.57	-60.15	0.00	0.52	-60.67	-20.00	40.67
644.40	V	33.97	-68.66	0.00	0.52	-69.18	-20.00	49.18
805.50	H	36.98	-65.18	0.00	0.56	-65.74	-20.00	45.74
805.50	V	40.27	-58.34	0.00	0.56	-58.90	-20.00	38.90
966.60	H	29.15	-68.14	0.00	0.59	-68.73	-20.00	48.73
966.60	V	27.35	-67.63	0.00	0.59	-68.22	-20.00	48.22
1127.70	H	38.63	-63.36	7.46	0.64	-56.54	-20.00	36.54
1127.70	V	37.21	-65.34	7.46	0.64	-58.52	-20.00	38.52
1288.80	H	37.16	-65.58	7.91	0.70	-58.37	-20.00	38.37
1288.80	V	36.34	-66.90	7.91	0.70	-59.69	-20.00	39.69
1449.90	H	37.09	-66.49	8.36	0.75	-58.88	-20.00	38.88
1449.90	V	36.12	-67.53	8.36	0.75	-59.92	-20.00	39.92
1611.00	H	43.14	-61.22	8.63	0.82	-53.41	-20.00	33.41
1611.00	V	41.16	-63.24	8.63	0.82	-55.43	-20.00	35.43
FM, Frequency: 161.1 MHz-25 kHz								
322.20	H	71.56	-38.82	0.00	0.34	-39.16	-13.00	26.16
322.20	V	65.07	-43.16	0.00	0.34	-43.50	-13.00	30.50
483.30	H	57.13	-50.12	0.00	0.42	-50.54	-13.00	37.54
483.30	V	55.14	-48.14	0.00	0.42	-48.56	-13.00	35.56
644.40	H	35.40	-69.32	0.00	0.52	-69.84	-13.00	56.84
644.40	V	33.95	-68.68	0.00	0.52	-69.20	-13.00	56.20
805.50	H	39.71	-62.45	0.00	0.56	-63.01	-13.00	50.01
805.50	V	39.07	-59.54	0.00	0.56	-60.10	-13.00	47.10
966.60	H	29.72	-67.57	0.00	0.59	-68.16	-13.00	55.16
966.60	V	28.62	-66.36	0.00	0.59	-66.95	-13.00	53.95
1127.70	H	36.34	-65.65	7.46	0.64	-58.83	-13.00	45.83
1127.70	V	36.19	-66.36	7.46	0.64	-59.54	-13.00	46.54
1288.80	H	37.22	-65.52	7.91	0.70	-58.31	-13.00	45.31
1288.80	V	36.71	-66.53	7.91	0.70	-59.32	-13.00	46.32
1449.90	H	35.84	-67.74	8.36	0.75	-60.13	-13.00	47.13
1449.90	V	36.38	-67.27	8.36	0.75	-59.66	-13.00	46.66
1611.00	H	40.22	-64.14	8.63	0.82	-56.33	-13.00	43.33
1611.00	V	41.99	-62.41	8.63	0.82	-54.60	-13.00	41.60

Frequency (MHz)	Polar (H/V)	Receiver Reading (dB μ V)	Substituted Method			Absolute Level (dBm)	Limit (dBm)	Margin (dB)
			Substituted Level (dBm)	Antenna Gain (dBd/dBi)	Cable Loss (dB)			
4FSK, Frequency: 161.1 MHz-12.5 kHz								
322.20	H	86.71	-23.67	0.00	0.34	-24.01	-20.00	4.01
322.20	V	70.81	-37.42	0.00	0.34	-37.76	-20.00	17.76
483.30	H	79.07	-28.18	0.00	0.42	-28.60	-20.00	8.60
483.30	V	65.39	-37.89	0.00	0.42	-38.31	-20.00	18.31
644.40	H	66.46	-38.26	0.00	0.52	-38.78	-20.00	18.78
644.40	V	48.58	-54.05	0.00	0.52	-54.57	-20.00	34.57
805.50	H	58.72	-43.44	0.00	0.56	-44.00	-20.00	24.00
805.50	V	45.56	-53.05	0.00	0.56	-53.61	-20.00	33.61
966.60	H	50.49	-46.80	0.00	0.59	-47.39	-20.00	27.39
966.60	V	38.19	-56.79	0.00	0.59	-57.38	-20.00	37.38
1127.70	H	41.30	-60.69	7.46	0.64	-53.87	-20.00	33.87
1127.70	V	41.57	-60.98	7.46	0.64	-54.16	-20.00	34.16
1288.80	H	40.66	-62.08	7.91	0.70	-54.87	-20.00	34.87
1288.80	V	39.37	-63.87	7.91	0.70	-56.66	-20.00	36.66
1449.90	H	41.00	-62.58	8.36	0.75	-54.97	-20.00	34.97
1449.90	V	38.64	-65.01	8.36	0.75	-57.40	-20.00	37.40
1611.00	H	51.90	-52.46	8.63	0.82	-44.65	-20.00	24.65
1611.00	V	48.79	-55.61	8.63	0.82	-47.80	-20.00	27.80

Part 22

Frequency (MHz)	Polar (H/V)	Receiver Reading (dB μ V)	Substituted Method			Absolute Level (dBm)	Limit (dBm)	Margin (dB)
			Substituted Level (dBm)	Antenna Gain (dBd/dBi)	Cable Loss (dB)			
FM, Frequency: 150.8125 MHz-12.5 kHz								
301.63	H	75.13	-35.57	0.00	0.34	-35.91	-13.00	22.91
301.63	V	75.52	-33.25	0.00	0.34	-33.59	-13.00	20.59
452.44	H	65.54	-42.44	0.00	0.43	-42.87	-13.00	29.87
452.44	V	68.45	-35.91	0.00	0.43	-36.34	-13.00	23.34
603.25	H	38.64	-66.16	0.00	0.50	-66.66	-13.00	53.66
603.25	V	43.82	-59.81	0.00	0.50	-60.31	-13.00	47.31
754.06	H	43.66	-59.72	0.00	0.52	-60.24	-13.00	47.24
754.06	V	40.80	-59.11	0.00	0.52	-59.63	-13.00	46.63
904.88	H	46.11	-53.04	0.00	0.55	-53.59	-13.00	40.59
904.88	V	44.44	-51.88	0.00	0.55	-52.43	-13.00	39.43
1055.69	H	36.53	-66.04	7.26	0.65	-59.43	-13.00	46.43
1055.69	V	36.12	-66.81	7.26	0.65	-60.20	-13.00	47.20
1206.50	H	36.18	-66.67	7.68	0.69	-59.68	-13.00	46.68
1206.50	V	35.99	-67.58	7.68	0.69	-60.59	-13.00	47.59
1357.31	H	36.57	-66.72	8.10	0.78	-59.40	-13.00	46.40
1357.31	V	35.60	-67.91	8.10	0.78	-60.59	-13.00	47.59
1508.13	H	37.55	-65.97	8.51	0.76	-58.22	-13.00	45.22
1508.13	V	37.16	-66.45	8.51	0.76	-58.70	-13.00	45.70
FM, Frequency: 150.8125MHz-25 kHz								
301.63	H	75.36	-35.34	0.00	0.34	-35.68	-13.00	22.68
301.63	V	77.50	-31.27	0.00	0.34	-31.61	-13.00	18.61
452.44	H	68.54	-39.44	0.00	0.43	-39.87	-13.00	26.87
452.44	V	69.89	-34.47	0.00	0.43	-34.90	-13.00	21.90
603.25	H	38.22	-66.58	0.00	0.50	-67.08	-13.00	54.08
603.25	V	45.54	-58.09	0.00	0.50	-58.59	-13.00	45.59
754.06	H	45.71	-57.67	0.00	0.52	-58.19	-13.00	45.19
754.06	V	41.64	-58.27	0.00	0.52	-58.79	-13.00	45.79
904.88	H	45.87	-53.28	0.00	0.55	-53.83	-13.00	40.83
904.88	V	44.99	-51.33	0.00	0.55	-51.88	-13.00	38.88
1055.69	H	36.34	-66.23	7.26	0.65	-59.62	-13.00	46.62
1055.69	V	35.75	-67.18	7.26	0.65	-60.57	-13.00	47.57
1206.50	H	38.58	-64.27	7.68	0.69	-57.28	-13.00	44.28
1206.50	V	35.92	-67.65	7.68	0.69	-60.66	-13.00	47.66
1357.31	H	35.45	-67.84	8.10	0.78	-60.52	-13.00	47.52
1357.31	V	36.11	-67.40	8.10	0.78	-60.08	-13.00	47.08
1508.13	H	36.96	-66.56	8.51	0.76	-58.81	-13.00	45.81
1508.13	V	36.60	-67.01	8.51	0.76	-59.26	-13.00	46.26

Frequency (MHz)	Polar (H/V)	Receiver Reading (dB μ V)	Substituted Method			Absolute Level (dBm)	Limit (dBm)	Margin (dB)
			Substituted Level (dBm)	Antenna Gain (dBd/dBi)	Cable Loss (dB)			
4FSK, Frequency: 150.8125 MHz-12.5 kHz								
301.63	H	81.27	-29.43	0.00	0.34	-29.77	-13.00	16.77
301.63	V	86.10	-22.67	0.00	0.34	-23.01	-13.00	10.01
452.44	H	68.08	-39.90	0.00	0.43	-40.33	-13.00	27.33
452.44	V	75.06	-29.30	0.00	0.43	-29.73	-13.00	16.73
603.25	H	49.58	-55.22	0.00	0.50	-55.72	-13.00	42.72
603.25	V	64.01	-39.62	0.00	0.50	-40.12	-13.00	27.12
754.06	H	47.59	-55.79	0.00	0.52	-56.31	-13.00	43.31
754.06	V	56.54	-43.37	0.00	0.52	-43.89	-13.00	30.89
904.88	H	46.27	-52.88	0.00	0.55	-53.43	-13.00	40.43
904.88	V	50.44	-45.88	0.00	0.55	-46.43	-13.00	33.43
1055.69	H	35.57	-67.00	7.26	0.65	-60.39	-13.00	47.39
1055.69	V	35.35	-67.58	7.26	0.65	-60.97	-13.00	47.97
1206.50	H	35.98	-66.87	7.68	0.69	-59.88	-13.00	46.88
1206.50	V	36.64	-66.93	7.68	0.69	-59.94	-13.00	46.94
1357.31	H	36.39	-66.90	8.10	0.78	-59.58	-13.00	46.58
1357.31	V	36.53	-66.98	8.10	0.78	-59.66	-13.00	46.66
1508.13	H	41.11	-62.41	8.51	0.76	-54.66	-13.00	41.66
1508.13	V	39.73	-63.88	8.51	0.76	-56.13	-13.00	43.13

Part 80

Frequency (MHz)	Polar (H/V)	Receiver Reading (dB μ V)	Substituted Method			Absolute Level (dBm)	Limit (dBm)	Margin (dB)
			Substituted Level (dBm)	Antenna Gain (dBd/dBi)	Cable Loss (dB)			
FM, Frequency: 154.0125 MHz-25 kHz								
308.03	H	70.34	-40.26	0.00	0.34	-40.60	-13.00	27.60
308.03	V	70.71	-37.89	0.00	0.34	-38.23	-13.00	25.23
462.04	H	63.02	-44.73	0.00	0.41	-45.14	-13.00	32.14
462.04	V	66.89	-37.14	0.00	0.41	-37.55	-13.00	24.55
616.05	H	30.56	-74.22	0.00	0.48	-74.70	-13.00	61.70
616.05	V	29.52	-73.80	0.00	0.48	-74.28	-13.00	61.28
770.06	H	41.01	-62.00	0.00	0.55	-62.55	-13.00	49.55
770.06	V	43.86	-55.64	0.00	0.55	-56.19	-13.00	43.19
924.08	H	39.68	-58.89	0.00	0.62	-59.51	-13.00	46.51
924.08	V	41.45	-54.46	0.00	0.62	-55.08	-13.00	42.08
1078.09	H	35.23	-66.88	7.32	0.66	-60.22	-13.00	47.22
1078.09	V	35.25	-67.29	7.32	0.66	-60.63	-13.00	47.63
1232.10	H	37.67	-65.15	7.75	0.68	-58.08	-13.00	45.08
1232.10	V	37.17	-66.30	7.75	0.68	-59.23	-13.00	46.23
1386.11	H	36.09	-67.48	8.18	0.73	-60.03	-13.00	47.03
1386.11	V	35.37	-68.30	8.18	0.73	-60.85	-13.00	47.85
1540.13	H	38.16	-65.65	8.55	0.78	-57.88	-13.00	44.88
1540.13	V	36.84	-67.05	8.55	0.78	-59.28	-13.00	46.28

Note 1: The unit of antenna gain is dBd for frequency below 1GHz and is dBi for frequency above 1GHz.

Note 2:

Absolute Level = Substituted Level - Cable loss + Antenna Gain

Margin = Limit - Absolute Level

Model: MD622 VHF
30MHz - 1GHz:
Part 90

Frequency (MHz)	Polar (H/V)	Receiver Reading (dB μ V)	Substituted Method			Absolute Level (dBm)	Limit (dBm)	Margin (dB)
			Substituted Level (dBm)	Antenna Gain (dBd/dBi)	Cable Loss (dB)			
FM, Frequency: 136.0125MHz-12.5 kHz								
272.03	H	63.81	-47.57	0.00	0.31	-47.88	-20.00	27.88
272.03	V	52.22	-57.80	0.00	0.31	-58.11	-20.00	38.11
408.04	H	56.94	-52.08	0.00	0.40	-52.48	-20.00	32.48
408.04	V	57.79	-48.14	0.00	0.40	-48.54	-20.00	28.54
544.05	H	36.32	-69.64	0.00	0.47	-70.11	-20.00	50.11
544.05	V	36.65	-66.49	0.00	0.47	-66.96	-20.00	46.96
680.06	H	31.76	-72.89	0.00	0.52	-73.41	-20.00	53.41
680.06	V	31.55	-70.21	0.00	0.52	-70.73	-20.00	50.73
816.08	H	31.45	-70.39	0.00	0.55	-70.94	-20.00	50.94
816.08	V	31.56	-66.81	0.00	0.55	-67.36	-20.00	47.36
952.09	H	31.82	-65.91	0.00	0.59	-66.50	-20.00	46.50
952.09	V	31.99	-63.30	0.00	0.59	-63.89	-20.00	43.89
4FSK, Frequency: 136.0125MHz-12.5 kHz								
272.03	H	62.58	-48.80	0.00	0.31	-49.11	-20.00	29.11
272.03	V	51.40	-58.62	0.00	0.31	-58.93	-20.00	38.93
408.04	H	57.11	-51.91	0.00	0.40	-52.31	-20.00	32.31
408.04	V	58.14	-47.79	0.00	0.40	-48.19	-20.00	28.19
544.05	H	35.62	-70.34	0.00	0.47	-70.81	-20.00	50.81
544.05	V	38.07	-65.07	0.00	0.47	-65.54	-20.00	45.54
680.06	H	31.35	-73.30	0.00	0.52	-73.82	-20.00	53.82
680.06	V	31.25	-70.51	0.00	0.52	-71.03	-20.00	51.03
816.08	H	30.80	-71.04	0.00	0.55	-71.59	-20.00	51.59
816.08	V	31.03	-67.34	0.00	0.55	-67.89	-20.00	47.89
952.09	H	31.32	-66.41	0.00	0.59	-67.00	-20.00	47.00
952.09	V	31.52	-63.77	0.00	0.59	-64.36	-20.00	44.36

Frequency (MHz)	Polar (H/V)	Receiver Reading (dB μ V)	Substituted Method			Absolute Level (dBm)	Limit (dBm)	Margin (dB)
			Substituted Level (dBm)	Antenna Gain (dBd/dBi)	Cable Loss (dB)			
FM, Frequency: 155.7525MHz-12.5 kHz								
311.51	H	67.29	-43.26	0.00	0.34	-43.60	-20.00	23.60
311.51	V	66.96	-41.55	0.00	0.34	-41.89	-20.00	21.89
467.26	H	48.47	-59.16	0.00	0.42	-59.58	-20.00	39.58
467.26	V	47.62	-56.22	0.00	0.42	-56.64	-20.00	36.64
623.01	H	34.22	-70.54	0.00	0.48	-71.02	-20.00	51.02
623.01	V	32.56	-70.59	0.00	0.48	-71.07	-20.00	51.07
778.76	H	31.90	-70.91	0.00	0.54	-71.45	-20.00	51.45
778.76	V	31.77	-67.51	0.00	0.54	-68.05	-20.00	48.05
934.52	H	31.67	-66.59	0.00	0.66	-67.25	-20.00	47.25
934.52	V	30.83	-64.85	0.00	0.66	-65.51	-20.00	45.51
4FSK, Frequency: 155.7525MHz-12.5 kHz								
311.51	H	67.42	-43.13	0.00	0.34	-43.47	-20.00	23.47
311.51	V	67.28	-41.23	0.00	0.34	-41.57	-20.00	21.57
467.26	H	48.87	-58.76	0.00	0.42	-59.18	-20.00	39.18
467.26	V	48.54	-55.30	0.00	0.42	-55.72	-20.00	35.72
623.01	H	32.86	-71.90	0.00	0.48	-72.38	-20.00	52.38
623.01	V	32.70	-70.45	0.00	0.48	-70.93	-20.00	50.93
778.76	H	31.33	-71.48	0.00	0.54	-72.02	-20.00	52.02
778.76	V	30.87	-68.41	0.00	0.54	-68.95	-20.00	48.95
934.52	H	30.93	-67.33	0.00	0.66	-67.99	-20.00	47.99
934.52	V	31.85	-63.83	0.00	0.66	-64.49	-20.00	44.49

Frequency (MHz)	Polar (H/V)	Receiver Reading (dB μ V)	Substituted Method			Absolute Level (dBm)	Limit (dBm)	Margin (dB)
			Substituted Level (dBm)	Antenna Gain (dBd/dBi)	Cable Loss (dB)			
FM, Frequency: 173.9875MHz-12.5 kHz								
347.98	H	74.97	-35.03	0.00	0.36	-35.39	-20.00	15.39
347.98	V	69.40	-38.16	0.00	0.36	-38.52	-20.00	18.52
521.96	H	57.93	-48.48	0.00	0.41	-48.89	-20.00	28.89
521.96	V	53.15	-49.76	0.00	0.41	-50.17	-20.00	30.17
695.95	H	37.93	-66.69	0.00	0.55	-67.24	-20.00	47.24
695.95	V	33.01	-68.37	0.00	0.55	-68.92	-20.00	48.92
869.94	H	36.33	-63.88	0.00	0.58	-64.46	-20.00	44.46
869.94	V	34.39	-62.73	0.00	0.58	-63.31	-20.00	43.31
4FSK, Frequency: 173.9875MHz-12.5 kHz								
347.98	H	74.30	-35.70	0.00	0.36	-36.06	-20.00	16.06
347.98	V	69.71	-37.85	0.00	0.36	-38.21	-20.00	18.21
521.96	H	56.87	-49.54	0.00	0.41	-49.95	-20.00	29.95
521.96	V	53.15	-49.76	0.00	0.41	-50.17	-20.00	30.17
695.95	H	36.99	-67.63	0.00	0.55	-68.18	-20.00	48.18
695.95	V	31.65	-69.73	0.00	0.55	-70.28	-20.00	50.28
869.94	H	35.03	-65.18	0.00	0.58	-65.76	-20.00	45.76
869.94	V	31.96	-65.16	0.00	0.58	-65.74	-20.00	45.74

Part 74

Frequency (MHz)	Polar (H/V)	Receiver Reading (dBμV)	Substituted Method			Absolute Level (dBm)	Limit (dBm)	Margin (dB)
			Substituted Level (dBm)	Antenna Gain (dBd/dBi)	Cable Loss (dB)			
FM, Frequency: 161.1 MHz-12.5 kHz								
322.20	H	77.25	-33.13	0.00	0.34	-33.47	-20.00	13.47
322.20	V	70.44	-37.79	0.00	0.34	-38.13	-20.00	18.13
483.30	H	62.85	-44.40	0.00	0.42	-44.82	-20.00	24.82
483.30	V	54.89	-48.39	0.00	0.42	-48.81	-20.00	28.81
644.40	H	43.58	-61.14	0.00	0.52	-61.66	-20.00	41.66
644.40	V	33.78	-68.85	0.00	0.52	-69.37	-20.00	49.37
805.50	H	31.41	-70.75	0.00	0.56	-71.31	-20.00	51.31
805.50	V	31.10	-67.51	0.00	0.56	-68.07	-20.00	48.07
966.60	H	30.93	-66.36	0.00	0.59	-66.95	-20.00	46.95
966.60	V	31.28	-63.70	0.00	0.59	-64.29	-20.00	44.29
FM, Frequency: 161.1 MHz-25 kHz								
322.20	H	78.59	-31.79	0.00	0.34	-32.13	-13.00	19.13
322.20	V	69.06	-39.17	0.00	0.34	-39.51	-13.00	26.51
483.30	H	64.90	-42.35	0.00	0.42	-42.77	-13.00	29.77
483.30	V	53.59	-49.69	0.00	0.42	-50.11	-13.00	37.11
644.40	H	47.55	-57.17	0.00	0.52	-57.69	-13.00	44.69
644.40	V	33.87	-68.76	0.00	0.52	-69.28	-13.00	56.28
805.50	H	33.78	-68.38	0.00	0.56	-68.94	-13.00	55.94
805.50	V	31.32	-67.29	0.00	0.56	-67.85	-13.00	54.85
966.60	H	31.09	-66.20	0.00	0.59	-66.79	-13.00	53.79
966.60	V	30.86	-64.12	0.00	0.59	-64.71	-13.00	51.71
4FSK, Frequency: 161.1 MHz-12.5 kHz								
322.20	H	77.64	-32.74	0.00	0.34	-33.08	-20.00	13.08
322.20	V	69.97	-38.26	0.00	0.34	-38.60	-20.00	18.60
483.30	H	62.27	-44.98	0.00	0.42	-45.40	-20.00	25.40
483.30	V	54.21	-49.07	0.00	0.42	-49.49	-20.00	29.49
644.40	H	44.40	-60.32	0.00	0.52	-60.84	-20.00	40.84
644.40	V	32.62	-70.01	0.00	0.52	-70.53	-20.00	50.53
805.50	H	31.80	-70.36	0.00	0.56	-70.92	-20.00	50.92
805.50	V	31.47	-67.14	0.00	0.56	-67.70	-20.00	47.70
966.60	H	30.83	-66.46	0.00	0.59	-67.05	-20.00	47.05
966.60	V	31.35	-63.63	0.00	0.59	-64.22	-20.00	44.22

Part 22

Frequency (MHz)	Polar (H/V)	Receiver Reading (dB μ V)	Substituted Method			Absolute Level (dBm)	Limit (dBm)	Margin (dB)
			Substituted Level (dBm)	Antenna Gain (dBd/dBi)	Cable Loss (dB)			
FM, Frequency: 150.8125 MHz-12.5 kHz								
301.63	H	64.79	-45.91	0.00	0.34	-46.25	-13.00	33.25
301.63	V	65.59	-43.18	0.00	0.34	-43.52	-13.00	30.52
452.44	H	51.12	-56.86	0.00	0.43	-57.29	-13.00	44.29
452.44	V	49.21	-55.15	0.00	0.43	-55.58	-13.00	42.58
603.25	H	31.74	-73.06	0.00	0.50	-73.56	-13.00	60.56
603.25	V	31.96	-71.67	0.00	0.50	-72.17	-13.00	59.17
754.06	H	32.54	-70.84	0.00	0.52	-71.36	-13.00	58.36
754.06	V	30.72	-69.19	0.00	0.52	-69.71	-13.00	56.71
904.88	H	31.63	-67.52	0.00	0.55	-68.07	-13.00	55.07
904.88	V	31.76	-64.56	0.00	0.55	-65.11	-13.00	52.11
FM, Frequency: 150.8125MHz-25 kHz								
301.63	H	64.53	-46.17	0.00	0.34	-46.51	-13.00	33.51
301.63	V	66.10	-42.67	0.00	0.34	-43.01	-13.00	30.01
452.44	H	49.64	-58.34	0.00	0.43	-58.77	-13.00	45.77
452.44	V	49.68	-54.68	0.00	0.43	-55.11	-13.00	42.11
603.25	H	32.49	-72.31	0.00	0.50	-72.81	-13.00	59.81
603.25	V	32.60	-71.03	0.00	0.50	-71.53	-13.00	58.53
754.06	H	30.72	-72.66	0.00	0.52	-73.18	-13.00	60.18
754.06	V	30.77	-69.14	0.00	0.52	-69.66	-13.00	56.66
904.88	H	32.94	-66.21	0.00	0.55	-66.76	-13.00	53.76
904.88	V	32.09	-64.23	0.00	0.55	-64.78	-13.00	51.78
4FSK, Frequency: 150.8125 MHz-12.5 kHz								
301.63	H	65.52	-45.18	0.00	0.34	-45.52	-13.00	32.52
301.63	V	65.80	-42.97	0.00	0.34	-43.31	-13.00	30.31
452.44	H	49.81	-58.17	0.00	0.43	-58.60	-13.00	45.60
452.44	V	49.02	-55.34	0.00	0.43	-55.77	-13.00	42.77
603.25	H	32.60	-72.20	0.00	0.50	-72.70	-13.00	59.70
603.25	V	31.99	-71.64	0.00	0.50	-72.14	-13.00	59.14
754.06	H	32.02	-71.36	0.00	0.52	-71.88	-13.00	58.88
754.06	V	30.79	-69.12	0.00	0.52	-69.64	-13.00	56.64
904.88	H	31.33	-67.82	0.00	0.55	-68.37	-13.00	55.37
904.88	V	32.62	-63.70	0.00	0.55	-64.25	-13.00	51.25

Part 80:

Frequency (MHz)	Polar (H/V)	Receiver Reading (dB μ V)	Substituted Method			Absolute Level (dBm)	Limit (dBm)	Margin (dB)
			Substituted Level (dBm)	Antenna Gain (dBd/dBi)	Cable Loss (dB)			
FM, Frequency: 154.0125 MHz-25 kHz								
308.03	H	69.36	-41.24	0.00	0.34	-41.58	-13.00	28.58
308.03	V	68.51	-40.09	0.00	0.34	-40.43	-13.00	27.43
462.04	H	50.39	-57.36	0.00	0.41	-57.77	-13.00	44.77
462.04	V	48.46	-55.57	0.00	0.41	-55.98	-13.00	42.98
616.05	H	31.11	-73.67	0.00	0.48	-74.15	-13.00	61.15
616.05	V	31.57	-71.75	0.00	0.48	-72.23	-13.00	59.23
770.06	H	30.91	-72.10	0.00	0.55	-72.65	-13.00	59.65
770.06	V	31.83	-67.67	0.00	0.55	-68.22	-13.00	55.22
924.08	H	30.94	-67.63	0.00	0.62	-68.25	-13.00	55.25
924.08	V	31.44	-64.47	0.00	0.62	-65.09	-13.00	52.09

Note 1: The unit of antenna gain is dBd for frequency below 1GHz and is dBi for frequency above 1GHz.

Note 2:

Absolute Level = Substituted Level - Cable loss + Antenna Gain

Margin = Limit - Absolute Level

===== END OF REPORT =====