



QUICK REFERENCE GUIDE

DIGITAL MOBILE RADIO



is the trademark or registered trademark of Hytera Communications Corporation Limited.

© 2020 Hytera Communications Corporation Limited. All Rights Reserved.

Address: Hytera Tower, Hi-Tech Industrial Park North, 9108#Beihuan Road,
Nanshan District, Shenzhen, People's Republic of China

Postcode: 518057

<http://www.hytera.com>



190335437 06073207

5202010062847A

Product Overview

Product Layout

Front Panel

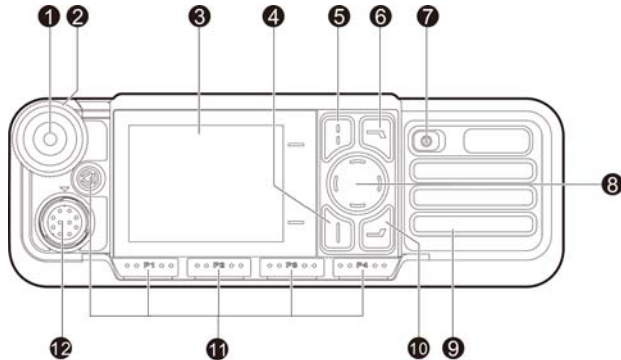

No.	Part Name	No.	Part Name
1	Smart Knob	7	On-Off Key
2	LED Indicator	8	Navigation Key
3	LCD Display	9	Speaker
4	OK/Menu Key	10	P5/Answer Key
5	Back/Subgroup Key	11	Programmable Keys
6	P6/End Key	12	Aviation Port

Rear Panel

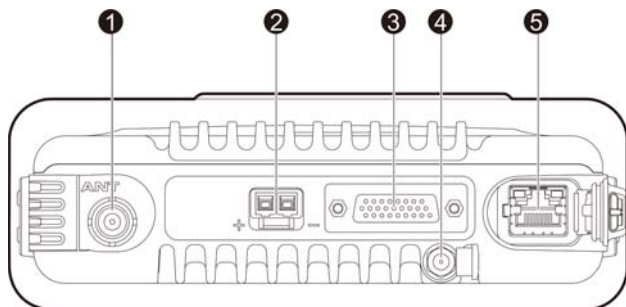

No.	Part Name	No.	Part Name
1	RF Antenna Connector	4	GPS Antenna Connector
2	Power Inlet	5	Network Port
3	Accessory Connector	/	/



NOTE

The GPS antenna connector is used only by radios with the GPS feature.

Palm Microphone

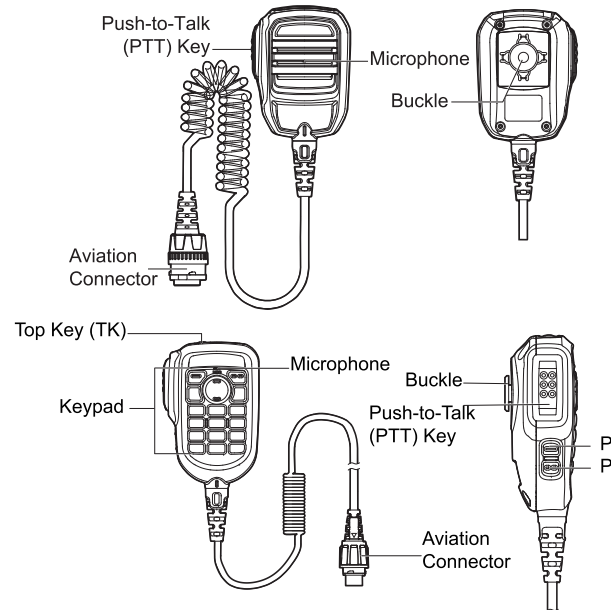

NOTE

The palm microphone without keypad is available for the conventional radio and the one with keypad is for the trunking radio.

Programmable Keys

You can request your dealer to program the following keys as shortcuts to assignable radio features:

- Radio: **TK**, **P1** key, **P2** key, **P3** key, **P4** key, **P5/Answer** key, and **P6/End** key.
- Palm microphone with keypad: **TK**, **P1** key, and **P2** key.

Installation

Instructions

Before installing the radio in a vehicle, read the following instructions carefully:

- Before installation, check the ground polarity and voltage of the vehicle power. The radio must work with a 13.6 V±15% negative ground electrical system.
- Before installation, check how long the screws will extend from the bottom surface of the radio. Drill the mounting hole cautiously to avoid damage to the vehicle wiring and other parts.
- Before you install the radio in the mounting bracket, connect the antenna and power cord to the radio. Use the dedicated antenna and power cord provided by the Company for digital radios.
- Install the radio with the mounting bracket supplied by the Company, to avoid accidental radio looseness. The loose radio may cause bodily injury.
- Install the radio in a location where you can reach the front panel conveniently.
- Keep sufficient clearance at the back of the radio for wiring.
- Use the fuse with the same _____ for DC power cord upon replacement.
- If any other devices are in the vicinity of the radio, keep the antenna of these devices at least 10 m away from that of the radio.

Tools

- Electric drill
- Phillips screwdriver
- T20 torx screwdriver

Parts

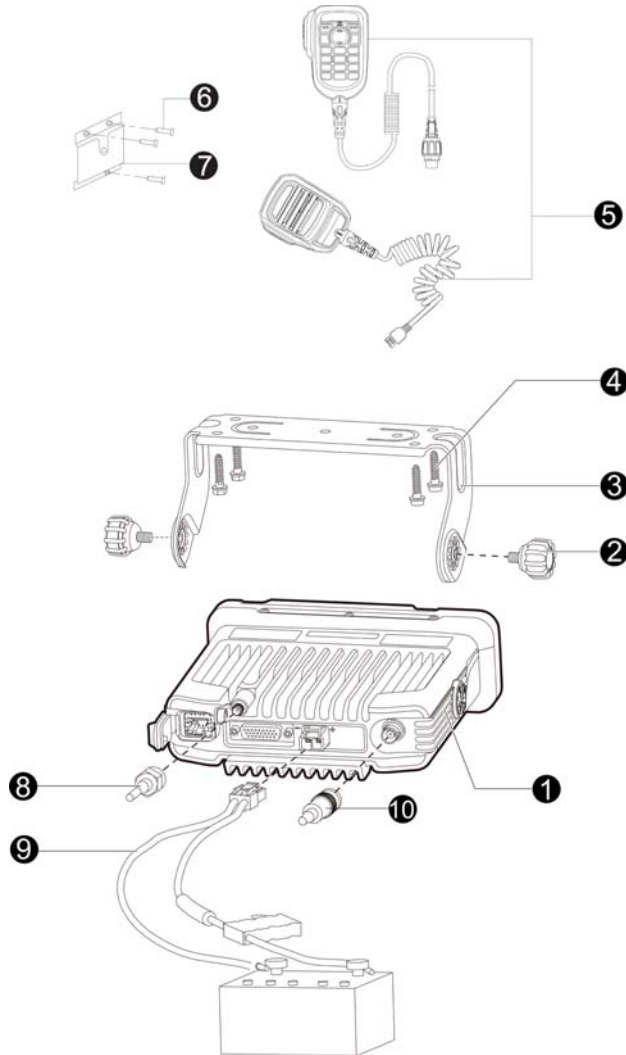

No.	Part Name	No.	Part Name
1	Radio	6	Screw (4 mm x 16 mm)
2	Locking Knobs	7	Microphone Hanger
3	Mounting Bracket	8	GPS Antenna
4	Screw (4.8 mm x 20 mm)	9	Power Cord (with fuse)
5	Palm Microphone	10	RF Antenna



NOTE

- The RF antenna must be purchased separately.
- The GPS antenna is available only for radios with the GPS feature.
- The palm microphone without keypad (with ⑥ and ⑦) is available for the conventional radio, and the one with keypad (with ⑥ and ⑦) is for the trunking radio.

Procedure

Installing the TF Card

1. Release the latch on both sides of the plastic upper cover.



2. Hold the front panel, and then pull and remove the plastic upper cover.

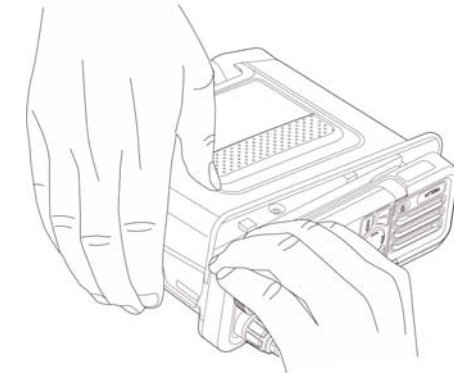

3. Insert the TF card to the metal card slot properly as

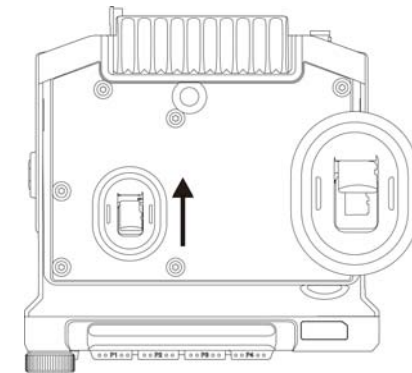

4. Align the concave side of the plastic upper cover with the aluminum chassis, and then press the cover until the latches are properly locked.

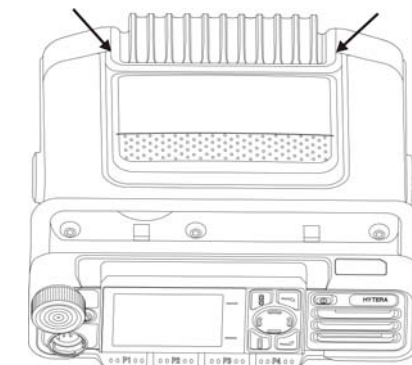

Installing the Radio

1. Select a location, drill holes based on the shape of the mounting bracket, and then use the screws (4.8 mm x 20 mm) to secure the bracket.
2. Connect the RF antenna, GPS antenna, and power cord to the radio.
3. Slide the radio into the mounted bracket, and then secure it by using the locking knobs.
4. Install the microphone hanger in a location where you can reach it easily, and then use the screws (4 mm x 16 mm) to secure it.
5. Align the triangle index on the palm microphone with the installation index, plug the connector into the radio, and then rotate the connector clockwise to secure it.
6. Place the palm microphone on the hanger.

Basic Operations

Turning On or Off the Radio

- To turn on the radio, long press the **On-Off** key.
- To turn off the radio, press the **On-Off** key.

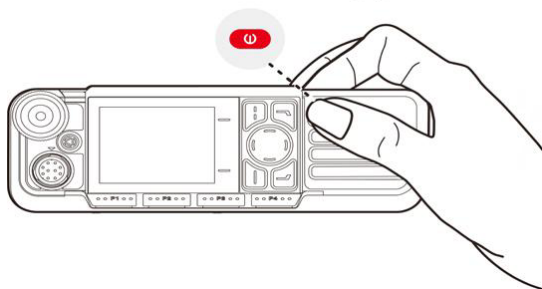

Adjusting the Volume

To increase or decrease the volume, rotate the **Smart** knob clockwise or counter-clockwise.

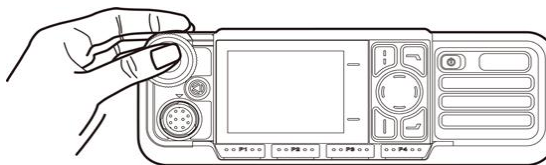

Switching the Operation Mode

The radio can operate in conventional mode, or digital/analog trunking mode (enabled by your dealer).

To switch the operation mode, do either of the following:

- Go to **Menu > Mode**, press the **Navigation** key up or down to select the mode, and then press the **OK/Menu** key.
- Press the preprogrammed **Operation Mode Switch** key.

Conventional Mode

Selecting a Zone

Go to **Menu > Zone**, press the **Navigation** key up or down to select the zone, and then press the **OK/Menu** key.

Selecting a Channel Through Smart Knob

On the home screen, press the **Smart** knob, and then rotate the knob within 5s.

Through Menu

1. Go to **Menu > Zone**.
2. Press the **Navigation** key up or down to select the zone.
3. Press the **Navigation** key up or down to select the channel.
4. Press the **OK/Menu** key.

Trunking Mode

Selecting a Group or Private Contact Through Smart Knob

On the home screen, press the **Smart** knob, and then rotate the knob within 5s.

Through Menu









1. On the home screen, press the **Back/Subgroup** key, or go to **Menu > Subgroup**.
2. Press the **Navigation** key up or down to select the subgroup.
3. Press the **Navigation** key up or down to select the group or private contact.
4. Press the **OK/Menu** key.







Selecting a Subgroup

1. On the home screen, press the **Back/Subgroup** key, or go to **Menu > Subgroup**.
2. Press the **Navigation** key up or down to select the subgroup.
3. Press the **OK/Menu** key.

Status Indications

LCD Icons

Icon	Radio Status
	The radio detects no signal.
	The number of bars indicates the signal strength.
	The radio operates in low power mode.
	The radio operates in high power mode.
	An accessory is connected.
	The Mode Automatic Switch feature is enabled.
	The radio is scanning.
	The Voice Operated Transmit (VOX) feature is enabled.
	The radio operates in silent mode.

	The radio operates in profile 1.
	The radio operates in profile 2.
	The radio is in emergency mode.
	There is/are missed call(s).
	There is/are unread message(s).
	The inbox is full.

For more status icons, refer to the User Manual.

LED Indicators

LED Indicator	Radio Status
Flashes green	The radio is being turned on.
Flashes green slowly	The radio is standby in trunking mode.
Glows green	The radio is receiving.
Glows red	The radio is transmitting.
Flashes red	The radio is establishing a call in trunking mode. This indication is applicable only to the calling radio.
Flashes orange slowly	<ul style="list-style-type: none"> Conventional mode: The radio is scanning or roaming. Trunking mode: The radio is scanning.
Flashes orange rapidly	<ul style="list-style-type: none"> Conventional mode: The radio is operating in emergency mode. Trunking mode: The radio is establishing a Full Off Air Call Set-up (FOACSU) private call. This indication is applicable only to the called radio.
Glows orange	Call hang time: No voice is being transmitted or received during a call. Within such a period, you can press and hold the PTT key and speak.

Flashes blue every 3s	The BT feature is enabled, but no BT device is connected.
Flashes blue every 1.5s	A BT device is connected.
Flashes blue every 0.1s	The BT feature is being disabled.

Call Services

Call on Digital Channel

Through Smart Knob

1. On the home screen, press the **Smart** knob.
2. Rotate the **Smart** knob within 5s to select the digital channel or contact.
3. Press and hold the **PTT** key.

Through Menu

1. Go to **Menu > Contact** or **Zone/Subgroup**.
2. Press the **Navigation** key up or down to select the contact.
3. Press and hold the **PTT** key.

Call on Analog Channel

Call Without Signaling

1. On the home screen, press the **Smart** knob.
2. Rotate the **Smart** knob within 5s to select the analog channel.
3. Press and hold the **PTT** key.

Call with Signaling

1. Go to **Menu > Contact > Contact/Favorite**, or press the preprogrammed **Contact List** key.

2. Press the **Navigation** key up or down to select the contact.
3. Press and hold the **PTT** key, or press the preprogrammed **One Touch Call/Menu** key.

Emergency Call

The Emergency feature is configured and enabled by your dealer. For details, refer to the User Manual.

For details on more features and operations, please visit our website at <http://www.hytera.com> or scan the QR code to download the User Manual.



FCC/ISED Statement

This device complies with part 15 of the FCC/ISED Rules. Operation is subject to the following two conditions:

(1) This device may not cause harmful interference, and (2) this device must accept any interference received, including interference that may cause undesired operation.

Ce dispositif est conforme à la partie 15 des règles FCC/ISED. L'opération est soumise aux deux conditions suivantes :

(1) Cet appareil ne peut pas causer d'interférences nocives et (2) cet appareil doit accepter toute interférence reçue, y compris toute interférence susceptible de provoquer un fonctionnement indésirable.

Any changes or modifications not expressly approved by the party responsible for compliance could void the user's authority to operate the equipment. Toute modification ou modification non expressément approuvée par la partie responsable de la conformité pourrait annuler le pouvoir de l'utilisateur d'exploiter l'équipement.

This equipment has been tested and found to comply with the limits for a Class B digital device, pursuant to part 15 of the FCC/ISED Rules. These limits are designed to provide reasonable protection against harmful interference in a residential installation. This equipment generates, uses and can radiate radio frequency energy and, if not installed and used in accordance with the instructions, may cause harmful interference to radio communications. However, there is no guarantee that interference will not occur in a particular installation. If this equipment does cause harmful interference to radio or television reception, which can be determined by turning the equipment off and on, the user is encouraged to try to correct the interference by one or more of the following measures:

- Reorient or relocate the receiving antenna.
- Increase the separation between the equipment and receiver.
- Connect the equipment into an outlet on a circuit different from that to which the receiver is connected.
- Consult the dealer or an experienced radio/TV technician for help.

Cet équipement a été testé et s'est avéré conforme aux limites d'un appareil numérique de classe B, conformément à la partie 15 des règles de la FCC/ISED. Ces limites sont conçues pour fournir une protection raisonnable contre les interférences nocives dans une installation résidentielle. Cet équipement génère, utilise et peut émettre de l'énergie par radiofréquence et, s'il n'est pas installé et utilisé conformément aux instructions, peut causer des interférences nocives aux communications radio. Toutefois, il n'y a aucune garantie que des interférences ne se produiront pas dans une installation particulière. Si cet équipement cause des interférences nuisibles à la réception de la radio ou de la télévision, qui peuvent être déterminées en éteignant et en allumant l'équipement, l'utilisateur est encouragé à essayer de corriger l'interférence par une ou plusieurs des mesures suivantes :

- Réorienter ou déplacer l'antenne de réception.
- Augmenter la séparation entre l'équipement et le récepteur.
- Connectez l'équipement dans une prise sur un circuit différent de celui auquel le récepteur est connecté.
- Consultez le concessionnaire ou un technicien expérimenté en radio/télévision pour obtenir de l'aide.

FCC Radiation Exposure Statement:

This equipment complies with FCC radiation exposure limits set forth for an occupational/controlled environment.

This transmitter must not be co-located or operating in conjunction with any other antenna or transmitter. This equipment should be installed and operated with minimum distance **35cm** between the radiator & your body.

ISED Radiation Exposure Statement:

This equipment complies with ISED RF radiation exposure limits set forth for an occupational/controlled environment. This transmitter must not be co-located or operating in conjunction with any other antenna or transmitter. This equipment should be installed and operated with minimum distance **35cm** between the radiator & your body.

IC exposition aux radiations:

Cet équipement est conforme avec ISED les limites d'exposition aux rayonnements définies pour un environnement professionnel/contrôlé. Cet émetteur ne doit pas être co-localisés ou fonctionner en conjonction avec une autre antenne ou émetteur. Cet équipement doit être installé et utilisé avec une distance minimale de **35cm** entre le radiateur & votre corps.

UHF Antenna Installation

Only allowed to use auxiliary antennas (TQC-400FG-W) or smaller gains. Larger gains Antenna may lead to non-compliance with the requirements. Uniquement autorisé à utiliser des antennes auxiliaires (TQC-400FG-W) ou des gains plus petits. Gains plus importants L'antenne peut conduire au non-respect des exigences.