



# TEST REPORT

**Report Reference No.**..... : **TRE1805007001** R/C.....: 87410

**FCC ID**..... : **YAMGTW-RFID**

**Applicant's name**..... : **Hytera Communications Corporation Limited**

**Address**..... : Hytera Tower, Hi-Tech Industrial Park North, 9108# Beihuan Road, Nanshan District, Shenzhen, People's Republic of China

**Manufacturer**..... : Hytera Communications Corporation Limited

**Address**..... : Hytera Tower, Hi-Tech Industrial Park North, 9108# Beihuan Road, Nanshan District, Shenzhen, People's Republic of China

**Test item description** ..... : **Patrol Beacon**

**Trade Mark** ..... : Hytera

**Model/Type reference**..... : GTW-RFID\_In

**Listed Model(s)** ..... : GTW-RFID\_Out

**Standard** ..... : **FCC CFR Title 47 Part 15 Subpart C Section 15.249**

**Date of receipt of test sample**..... : May.09,2018

**Date of testing**..... : May.09,2018-May.17,2018

**Date of issue**..... : May.17,2018

**Result**..... : **PASS**

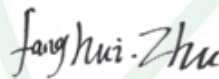
**Compiled by**  
( position+printedname+signature).... : File administrators Fanghui Zhu 

**Supervised by**  
(position+printedname+signature)..... : Project Engineer Chaohui Ouyang 

**Approved by**  
(position+printedname+signature)..... : RF Manager Hans Hu 

**Testing Laboratory Name** ..... : **Shenzhen Huatongwei International Inspection Co., Ltd.**

**Address**..... : 1/F, Bldg 3, Hongfa Hi-tech Industrial Park, Genyu Road, Tianliao, Gongming, Shenzhen, China

**Shenzhen Huatongwei International Inspection Co., Ltd. All rights reserved.**

This publication may be reproduced in whole or in part for non-commercial purposes as long as the Shenzhen Huatongwei International Inspection Co., Ltd. is acknowledged as copyright owner and source of the material. Shenzhen Huatongwei International Inspection Co., Ltd. takes no responsibility for and will not assume liability for damages resulting from the reader's interpretation of the reproduced material due to its placement and context.

*The test report merely correspond to the test sample.*

## Contents

<b>1.</b>	<b><u>TEST STANDARDS AND REPORT VERSION</u></b>	<b>3</b>
1.1.	Test Standards	3
1.2.	Report version information	3
<b>2.</b>	<b><u>TEST DESCRIPTION</u></b>	<b>4</b>
<b>3.</b>	<b><u>SUMMARY</u></b>	<b>5</b>
3.1.	Client Information	5
3.2.	Product Description	5
3.3.	EUT operation mode	5
3.4.	EUT configuration	6
3.5.	Modifications	6
<b>4.</b>	<b><u>TEST ENVIRONMENT</u></b>	<b>7</b>
4.1.	Address of the test laboratory	7
4.2.	Test Facility	7
4.3.	Environmental conditions	8
4.4.	Statement of the measurement uncertainty	8
4.5.	Equipments Used during the Test	9
<b>5.</b>	<b><u>TEST CONDITIONS AND RESULTS</u></b>	<b>11</b>
5.1.	Antenna requirement	11
5.2.	AC Power Conducted Emissions	12
5.3.	20 dB Occupied Bandwidth	13
5.4.	Radiated field strength of the fundamental signal	14
5.5.	Radiated Spurious Emissions and Bandedge Emission	16
<b>6.</b>	<b><u>TEST SETUP PHOTOS OF THE EUT</u></b>	<b>21</b>
<b>7.</b>	<b><u>EXTERNAL AND INTERNAL PHOTOS OF THE EUT</u></b>	<b>22</b>

## 1. TEST STANDARDS AND REPORT VERSION

### 1.1. Test Standards

The tests were performed according to following standards:

[FCC Rules Part 15.249](#): Operation within the bands 902-928 MHz, 2400-2483.5 MHz, 5725-5875 MHz, and 24.0-24.25 GHz.

[ANSI C63.10-2013](#): American National Standard for Testing Unlicensed Wireless Devices.

### 1.2. Report version information

Revision No.	Date of issue	Description
N/A	2018-01-29	Original

## 2. TEST DESCRIPTION

Test Item	Section in CFR 47	Result	Test Engineer
Antenna requirement	15.203	Pass	Baozhu Hu
AC Power Line Conducted Emissions	15.207	N/A	N/A
20dB Occupied Bandwidth	15.215/15.249	Pass	Baozhu Hu
Field strength of the Fundamental signal	15.249(a)	Pass	Jiuru Pan
Spurious Emissions	15.209/15.249(a)	Pass	Jiuru Pan
Band edge Emissions	15.205/15.249(d)	Pass	Jiuru Pan

Remark: The measurement uncertainty is not included in the test result.

### 3. SUMMARY

#### 3.1. Client Information

Applicant:	Hytera Communications Corporation Limited
Address:	Hytera Tower, Hi-Tech Industrial Park North, 9108# Beihuan Road, Nanshan District, Shenzhen, People's Republic of China
Manufacturer:	Hytera Communications Corporation Limited
Address:	Hytera Tower, Hi-Tech Industrial Park North, 9108# Beihuan Road, Nanshan District, Shenzhen, People's Republic of China

#### 3.2. Product Description

Name of EUT:	<b>Patrol Beacon</b>
Trade Mark:	Hytera
Model No.:	GTW-RFID_In
Listed Model(s):	GTW-RFID_Out
Power supply:	DC3V 2*AA Size Battery
Adapter information:	-
<b>RF Specification</b>	
Operation frequency:	2450MHz
Channel number:	1
Modulation Type:	GFSK
Antenna type:	Integral antenna
Antenna gain:	-2.2dBi

#### 3.3. EUT operation mode

- **Test frequency list**

According to section 15.31(m), regards to the operating frequency range over 10 MHz, must select three channel which were tested. the Lowest frequency, the middle frequency, and the highest frequency of channel were selected to perform the test, please see the above gray bottom.

Channel	Frequency (MHz)
1	2450

- **TEST MODE**

For RF test items
The engineering test program was provided and enabled to make EUT continuous transmit.
For AC power line conducted emissions:
The EUT was set to connect with large package sizes transmission.

Note: New battery is used during all test

### 3.4. EUT configuration

The following peripheral devices and interface cables were connected during the measurement:

- - supplied by the manufacturer
- - supplied by the lab

		Manufacturer :	/
		Model No. :	/
		Manufacturer :	/
		Model No. :	/

### 3.5. Modifications

No modifications were implemented to meet testing criteria.

## **4. TEST ENVIRONMENT**

### **4.1. Address of the test laboratory**

Laboratory: Shenzhen Huatongwei International Inspection Co., Ltd.

Address: 1/F, Bldg 3, Hongfa Hi-tech Industrial Park, Genyu Road, Tianliao, Gongming, Shenzhen, China

Phone: 86-755-26748019 Fax: 86-755-26748089

### **4.2. Test Facility**

The test facility is recognized, certified, or accredited by the following organizations:

#### **CNAS-Lab Code: L1225**

Shenzhen Huatongwei International Inspection Co., Ltd. has been assessed and proved to be in compliance with CNAS-CL01 Accreditation Criteria for Testing and Calibration Laboratories (identical to ISO/IEC17025: 2005 General Requirements) for the Competence of Testing and Calibration Laboratories.

#### **A2LA-Lab Cert. No. 3902.01**

Shenzhen Huatongwei International Inspection Co., Ltd. EMC Laboratory has been accredited by A2LA for technical competence in the field of electrical testing, and proved to be in compliance with ISO/IEC 17025: 2005 General Requirements for the Competence of Testing and Calibration Laboratories and any additional program requirements in the identified field of testing.

#### **FCC-Registration No.: 762235**

Shenzhen Huatongwei International Inspection Co., Ltd. EMC Laboratory has been registered and fully described in a report filed with the FCC (Federal Communications Commission). The acceptance letter from the FCC is maintained in our files. Registration 762235.

#### **IC-Registration No.: 5377B-1**

Two 3m Alternate Test Site of Shenzhen Huatongwei International Inspection Co., Ltd. has been registered by Certification and Engineering Bureau of Industry Canada for the performance of radiated measurements with Registration No. 5377B-1.

#### **ACA**

Shenzhen Huatongwei International Inspection Co., Ltd. EMC Laboratory can also perform testing for the Australian C-Tick mark as a result of our A2LA accreditation.

### 4.3. Environmental conditions

During the measurement the environmental conditions were within the listed ranges:

Temperature:	15~35°C
Relative Humidity:	30~60 %
Air Pressure:	950~1050mba

### 4.4. Statement of the measurement uncertainty

The data and results referenced in this document are true and accurate. The reader is cautioned that there may be errors in calibration limits of the equipment and facilities. The measurement uncertainty was calculated for all measurements listed in this test report according to TR-100028-01 "Electromagnetic compatibility and Radio spectrum Matters (ERM);Uncertainties in the measurement of mobile radio equipment characteristics;Part 1" and TR-100028-02 "Electromagnetic compatibility and Radio spectrum Matters (ERM);Uncertainties in the measurementof mobile radio equipment characteristics;Part 2" and is documented in the Shenzhen Huatongwei International Inspection Co., Ltd quality system according to ISO/IEC 17025. Further more, component and process variability of devices similar to that tested may result in additional deviation. The manufacturer has the sole responsibility of continued compliance of the device.

Here after the best measurement capability for Shenzhen Huatongwei is reported:

Test Items	Measurement Uncertainty	Notes
Conducted spurious emissions 9KHz-30MHz	3.39 dB	(1)
Radiated Emissions 30~1000MHz	4.24 dB	(1)
Radiated Emissions 1~18GHz	5.16 dB	(1)
Radiated Emissions 18-40GHz	5.54 dB	(1)
Occupied Bandwidth	-----	(1)

(1) This uncertainty represents an expanded uncertainty expressed at approximately the 95% confidence level using a coverage factor of k=1.96.



**4.5. Equipments Used during the Test**

<b>Conducted Emissions</b>						
Item	Test Equipment	Manufacturer	Model No.	Serial No.	Last Cal. (mm-dd-yy)	Next Cal. (mm-dd-yy)
1	EMI Test Receiver	R&S	ESCI	101247	11/11/2017	11/10/2018
2	Artificial Mains	SCHWARZBECK	NNLK 8121	573	11/11/2017	11/10/2018
3	2-Line V-Network	R&S	ESH3-Z5	100049	11/11/2017	11/10/2018
4	Pulse Limiter	R&S	ESH3-Z2	101488	11/11/2017	11/10/2018
5	RF Connection Cable	HUBER+SUHNER	EF400	N/A	11/21/2017	11/20/2018
6	Test Software	R&S	ES-K1	N/A	N/A	N/A

<b>Radiated Emissions</b>						
Item	Test Equipment	Manufacturer	Model No.	Serial No.	Last Cal. (mm-dd-yy)	Next Cal. (mm-dd-yy)
1	Semi-Anechoic Chamber	Albatross projects	SAC-3m-01	C11121	10/16/2016	10/15/2019
2	EMI Test Receiver	R&S	ESCI	100900	11/11/2017	11/10/2018
3	Loop Antenna	R&S	HFH2-Z2	100020	11/20/2017	11/19/2020
4	Ultra-Broadband Antenna	SCHWARZBECK	VULB9163	538	4/5/2017	4/4/2020
5	Horn Antenna	SCHWARZBECK	9120D	1011	3/27/2017	3/26/2020
6	Broadband Horn Antenna	SCHWARZBECK	BBHA9170	BBHA9170 472	3/27/2017	3/26/2020
7	Pre-amplifier	SCHWARZBECK	BBV 9743	9743-0022	10/18/2017	10/17/2018
8	Broadband Pre-amplifier	SCHWARZBECK	BBV 9718	9718-248	10/18/2017	10/17/2018
9	Spectrum Analyzer	R&S	FSP40	100597	11/11/2017	11/10/2018
10	RF Connection Cable	HUBER+SUHNER	RE-7-FL	N/A	11/21/2017	11/20/2018
11	RF Connection Cable	HUBER+SUHNER	RE-7-FH	N/A	11/21/2017	11/20/2018
12	Test Software	Audix	E3	N/A	N/A	N/A
13	Test Software	R&S	ES-K1	N/A	N/A	N/A
14	Turntable	Maturo Germany	TT2.0-1T	N/A	N/A	N/A
15	Antenna Mast	Maturo Germany	CAM-4.0-P-12	N/A	N/A	N/A

<b>RF Conducted Test</b>						
Item	Test Equipment	Manufacturer	Model No.	Serial No.	Last Cal. (mm-dd-yy)	Next Cal. (mm-dd-yy)
1	Spectrum Analyzer	R&S	FSV40	100048	11/11/2017	11/10/2018
2	EXA Signal Analyzer	Agilent	N9020A	184247	9/22/2017	9/21/2018
3	Power Meter	Agilent	U2021XA	178231	9/22/2017	9/21/2018
4	OSP	R&S	OSP120	101317	N/A	N/A

## 5. TEST CONDITIONS AND RESULTS

### 5.1. Antenna requirement

#### Requirement

##### **FCC CFR Title 47 Part 15 Subpart C Section 15.203:**

An intentional radiator shall be designed to ensure that no antenna other than that furnished by the responsible party shall be used with the device. The use of a permanently attached antenna or of an antenna that uses a unique coupling to the intentional radiator, the manufacturer may design the unit so that a broken antenna can be replaced by the user, but the use of a standard antenna jack or electrical connector is prohibited.

#### **Refer to statement below for compliance.**

The manufacturer may design the unit so that the user can replace a broken antenna, but the use of a standard antenna jack or electrical connector is prohibited. Further, this requirement does not apply to intentional radiators that must be professionally installed.

#### TEST RESULTS

**Passed**       **Not Applicable**

The directional gain of the antenna less than 6 dBi, please refer to the below antenna photo.

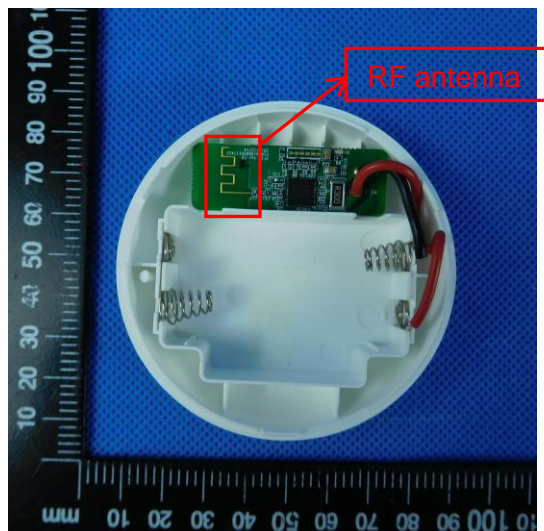

## 5.2. AC Power Conducted Emissions

### LIMIT

FCC CFR Title 47 Part 15 Subpart C Section 15.207:

Frequency range (MHz)	Limit (dBuV)	
	Quasi-peak	Average
0.15-0.5	66 to 56*	56 to 46*
0.5-5	56	46
5-30	60	50

\* Decreases with the logarithm of the frequency.

### TEST CONFIGURATION

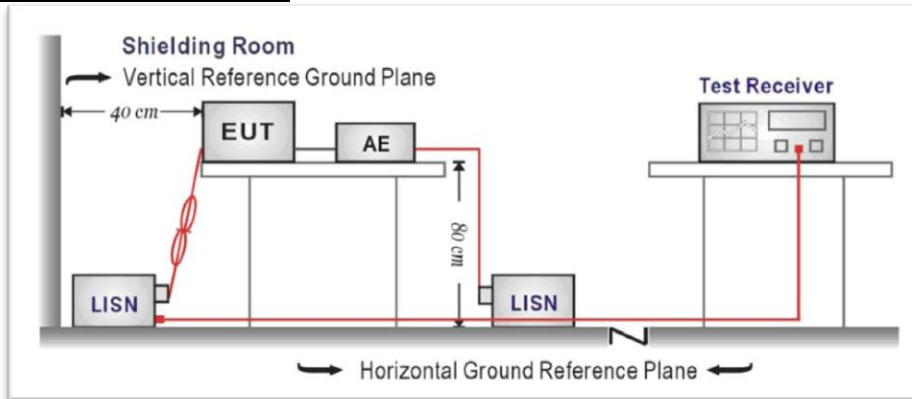

### TEST PROCEDURE

1. The EUT was setup according to ANSI C63.10:2013
2. The EUT was placed on a plat form of nominal size, 1 m by 1.5 m, raised 10 cm above the conducting ground plane. The vertical conducting plane was located 40 cm to the rear of the EUT. All other surfaces of EUT were at least 10 cm from any other grounded conducting surface.
3. The EUT and simulators are connected to the main power through a line impedance stabilization network (LISN). The LISN provides a 50ohm / 50uH coupling impedance for the measuring equipment.
4. The peripheral devices are also connected to the main power through a LISN. (Please refer to the block diagram of the test setup and photographs)
5. Each current-carrying conductor of the EUT power cord, except the ground (safety) conductor, was individually connected through a LISN to the input power source.
6. The excess length of the power cord between the EUT and the LISN receptacle were folded back and forth at the center of the lead to form a bundle not exceeding 40 cm in length.
7. Conducted emissions were investigated over the frequency range from 0.15MHz to 30MHz using a receiver bandwidth of 9 kHz.
8. During the above scans, the emissions were maximized by cable manipulation.

### TEST RESULTS

Passed       Not Applicable

### 5.3. 20 dB Occupied Bandwidth

**Limit**

Operation frequency range 2400MHz~2483.5MHz.

**TEST CONFIGURATION**

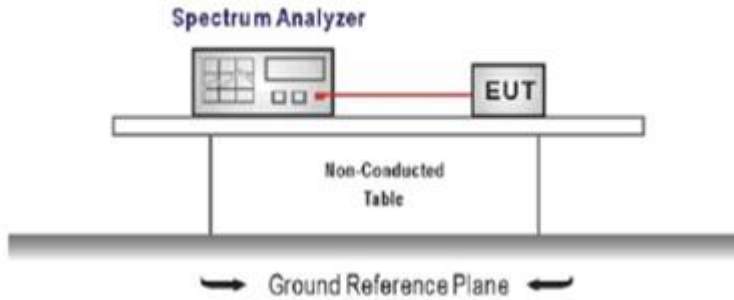

**TEST PROCEDURE**

1. The transmitter output was connected to the spectrum analyzer through an attenuator, the path loss was compensated to the results for each measurement.
2. Set to the maximum power setting and enable the EUT transmit continuously
3. Use the following spectrum analyzer settings:  
 Span = approximately 2 to 3 times the 20 dB bandwidth, centered on a hopping channel  
 RBW  $\geq$  1% of the 20 dB bandwidth, VBW  $\geq$  RBW  
 Sweep = auto, Detector function = peak, Trace = max hold
4. Measure and record the results in the test report.

**TEST MODE:**

Please refer to the clause 3.3

**TEST RESULTS**

Passed       Not Applicable

Channel Frequency(MHz)	20dB Bandwidth(MHz)	Result
2450	1.06	PASS

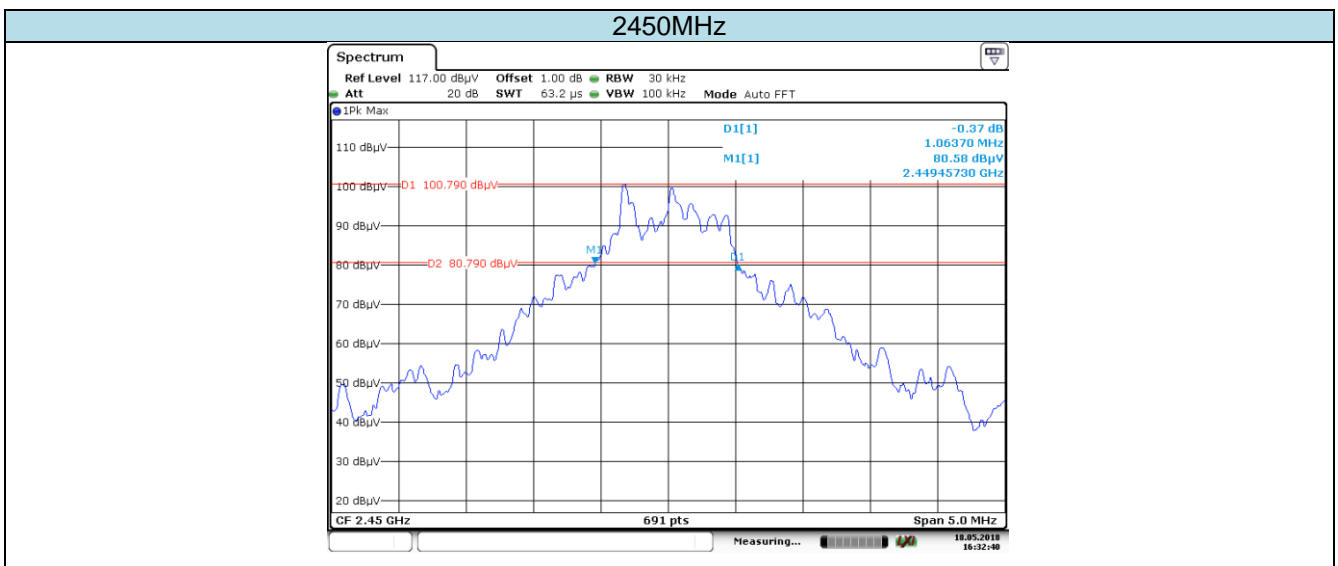

### 5.4. Radiated field strength of the fundamental signal

#### LIMIT

Fundamental frequency	Field strength of fundamental (millivolts/meter)	Field strength of harmonics (microvolts/meter)
902-928 MHz	50 (94dBuV/m @3m)	500 (54dBuV/m @3m)
2400-2483.5 MHz	50 (94dBuV/m @3m)	500 (54dBuV/m @3m)
5725-5875 MHz	50 (94dBuV/m @3m)	500 (54dBuV/m @3m)
24.0-24.25 GHz	250 (108dBuV/m @3m)	2500 (68dBuV/m @3m)

Frequencies above 1000 MHz, the field strength limits are based on average limits

#### TEST CONFIGURATION

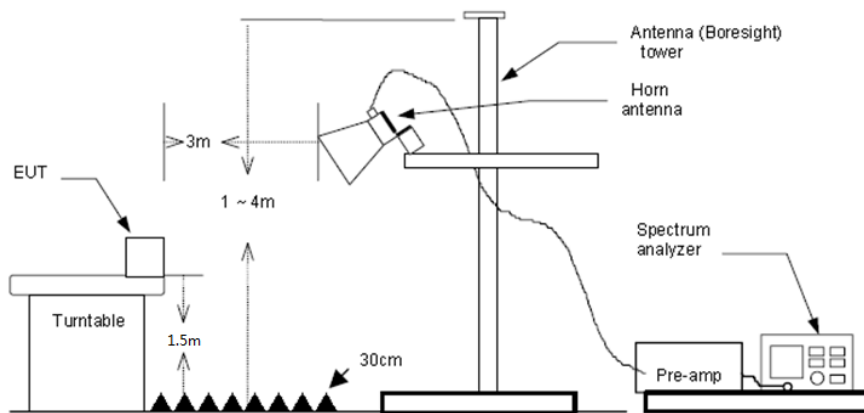

#### TEST PROCEDURE

1. The EUT was setup and tested according to ANSI C63.10:2013 requirements.
2. The EUT is placed on a turn table which is 1.5 meter above ground. The turn table is rotated 360 degrees to determine the position of the maximum emission level.
3. The EUT was positioned such that the distance from antenna to the EUT was 3 meters.
4. The antenna is scanned from 1 meter to 4 meters to find out the maximum emission level. This is repeated for both horizontal and vertical polarization of the antenna. In order to find the maximum emission, all of the interface cables were manipulated according to ANSI C63.10:2013 on radiated measurement.
5. The receiver set as follow:  
 RBW=1MHz, VBW=3MHz Peak detector for Peak value.  
 RBW=1MHz, VBW=3MHz RMS detector for Average value.

#### TEST MODE:

Please refer to the clause 3.3

#### TEST RESULTS

Passed       Not Applicable

Frequency (MHz)	Read Level (dBuV)	Antenna Factor (dB/m)	Cable Loss (dB)	Preamp Factor (dB)	Level (dBuV/m)	Limit Line (dBuV/m)	Over Limit (dB)	Polarization	Test value
2449.66	37.80	27.40	6.80	0.00	72.00	114.00	-42.00	Vertical	Peak
2450.08	49.30	27.40	6.80	0.00	83.50	114.00	-30.50	Horizontal	Peak
2449.76	37.10	27.40	6.80	0.00	71.30	94.00	-22.70	Vertical	Average
2449.24	43.40	27.40	6.80	0.00	77.60	94.00	-16.40	Horizontal	Average

### 5.5. Radiated Spurious Emissions and Bandedge Emission

**LIMIT**

**FCC CFR Title 47 Part 15 Subpart C Section 15.209**

Frequency	Limit (dBuV/m @3m)	Value
30MHz~88MHz	40.00	Quasi-peak
88MHz~216MHz	43.50	Quasi-peak
216MHz~960MHz	46.00	Quasi-peak
960MHz~1GHz	54.00	Quasi-peak
Above 1GHz	54.00	Average
	74.00	Peak

**TEST CONFIGURATION**

- 9 kHz ~ 30 MHz

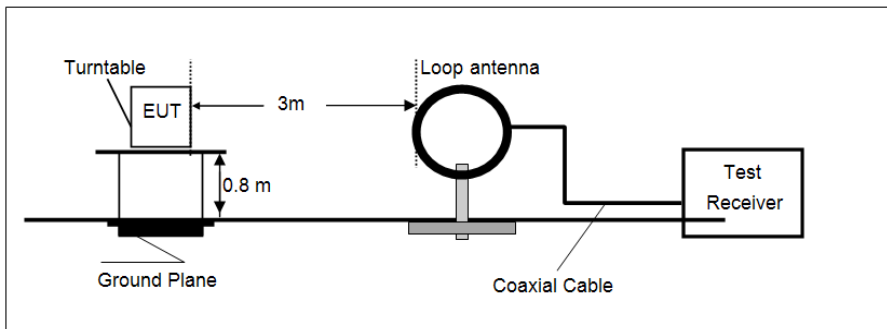

- 30 MHz ~ 1 GHz

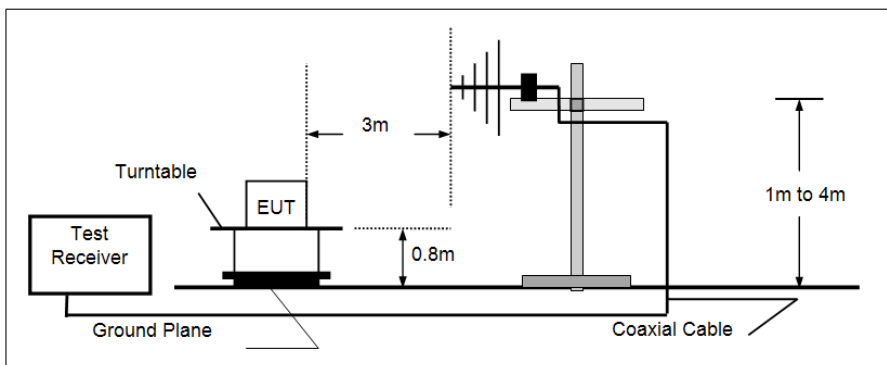

- Above 1 GHz

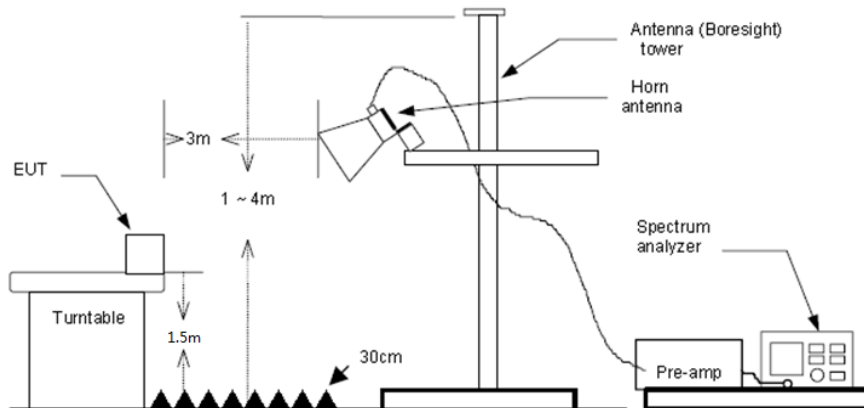



**TEST PROCEDURE**

1. The EUT was setup and tested according to ANSI C63.10:2013 requirements.
2. The EUT is placed on a turn table which is 0.8 meter above ground for below 1 GHz, and 1.5 m for above 1 GHz. The turn table is rotated 360 degrees to determine the position of the maximum emission level.
3. The EUT was set 3 meters from the receiving antenna, which was mounted on the top of a variable height antenna tower.
4. For each suspected emission, the EUT was arranged to its worst case and then tune the Antenna tower (from 1 m to 4 m) and turntable (from 0 degree to 360 degrees) to find the maximum reading. A pre-amp and a high pass filter are used for the test in order to get better signal level to comply with the guidelines.
5. Set to the maximum power setting and enable the EUT transmit continuously.
6. Use the following spectrum analyzer settings
  - (1) Span shall wide enough to fully capture the emission being measured;
  - (2) Below 1 GHz:  
RBW=120 kHz, VBW=300 kHz, Sweep=auto, Detector function=QP, Trace=max hold;  
If the emission level of the EUT measured by the peak detector is 3 dB lower than the applicable limit, the peak emission level will be reported. Otherwise, the emission measurement will be repeated using the quasi-peak detector and reported.
  - (3) From 1 GHz to 10<sup>th</sup> harmonic:  
RBW=1MHz, VBW=3MHz Peak detector for Peak value.  
RBW=1MHz, VBW=3MHz RMS detector for Average value.

**TEST MODE:**

Please refer to the clause 3.3

**TEST RESULTS**

**Passed**       **Not Applicable**

Note:

- 1) Above 1GHz Final Level =Receiver Read level + Antenna Factor + Cable Loss – Preamplifier Factor
- 2) The emission levels of other frequencies are very lower than the limit and not show in test report.

**Radiated Spurious Emissions****■ 9 kHz ~ 30 MHz**

The EUT was pre-scanned the frequency band (9 kHz ~ 30 MHz), found the radiated level lower than the limit, so don't show on the report.

■ 30 MHz ~ 1 GHz

Polarization:

Vertical

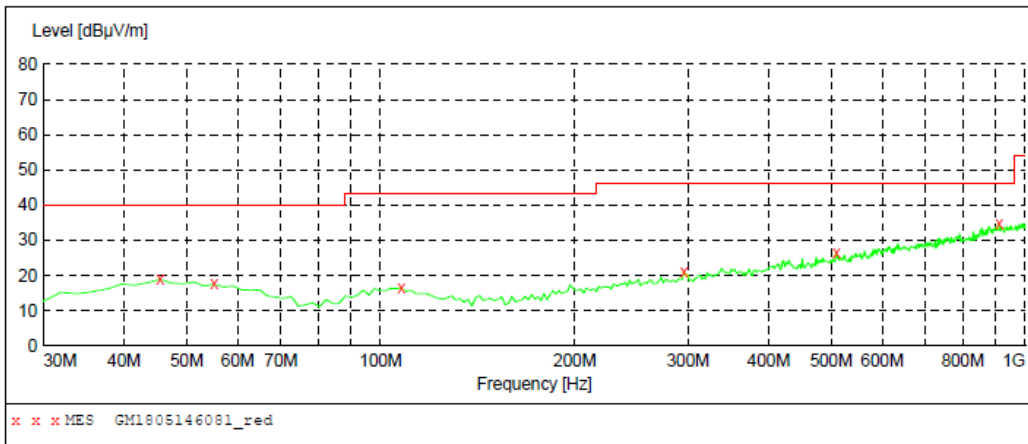

**MEASUREMENT RESULT: "GM1805146081\_red"**

5/14/2018 6:03PM

Frequency MHz	Level dBµV/m	Transd dB	Limit dBµV/m	Margin dB	Det.	Height cm	Azimuth deg	Polarization
45.520000	18.90	-8.8	40.0	21.1	QP	100.0	63.00	VERTICAL
55.220000	17.60	-9.2	40.0	22.4	QP	100.0	249.00	VERTICAL
107.600000	16.50	-10.6	43.5	27.0	QP	100.0	63.00	VERTICAL
295.780000	21.10	-7.3	46.0	24.9	QP	100.0	145.00	VERTICAL
509.180000	26.60	-1.5	46.0	19.4	QP	100.0	0.00	VERTICAL
910.760000	34.70	6.9	46.0	11.3	QP	100.0	0.00	VERTICAL

Polarization:

Horizontal

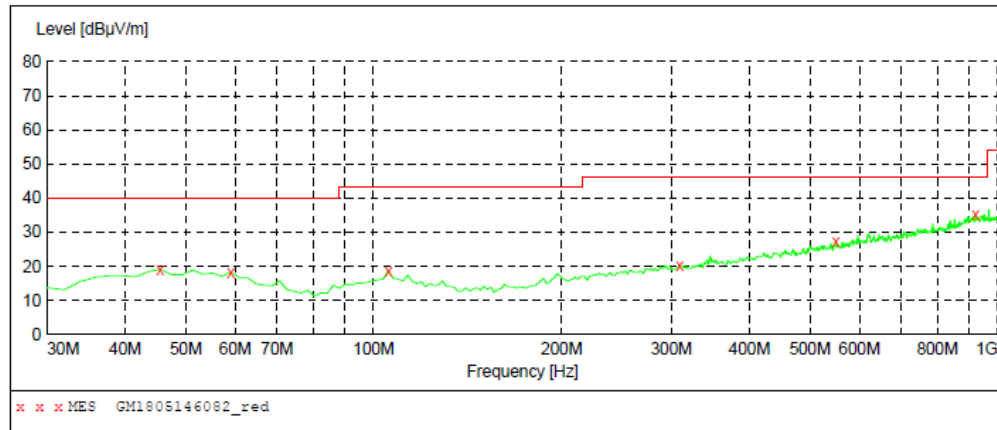

**MEASUREMENT RESULT: "GM1805146082\_red"**

5/14/2018 6:06PM

Frequency MHz	Level dBµV/m	Transd dB	Limit dBµV/m	Margin dB	Det.	Height cm	Azimuth deg	Polarization
45.520000	19.20	-8.8	40.0	20.8	QP	100.0	252.00	HORIZONTAL
59.100000	18.30	-9.8	40.0	21.7	QP	100.0	267.00	HORIZONTAL
105.660000	18.80	-10.5	43.5	24.7	QP	300.0	325.00	HORIZONTAL
309.360000	20.40	-7.1	46.0	25.6	QP	100.0	293.00	HORIZONTAL
549.920000	27.10	-0.8	46.0	18.9	QP	300.0	360.00	HORIZONTAL
920.460000	35.20	7.0	46.0	10.8	QP	300.0	93.00	HORIZONTAL

■ Above 1 GHz

Test channel					2450MHz				
Frequency (MHz)	Read Level (dBuV)	Antenna Factor (dB/m)	Cable Loss (dB)	Preamp Factor (dB)	Level (dBuV/m)	Limit Line (dBuV/m)	Over Limit (dB)	Polarization	Test value
1173.94	37.27	26.10	4.60	37.24	30.73	74.00	-43.27	Vertical	Peak
4045.06	34.17	29.79	8.82	36.72	36.06	74.00	-37.94	Vertical	Peak
5747.59	32.46	31.84	10.51	34.28	40.53	74.00	-33.47	Vertical	Peak
7470.56	32.37	36.16	12.30	33.07	47.76	74.00	-26.24	Vertical	Peak
1385.18	36.53	25.94	4.97	37.12	30.32	74.00	-43.68	Horizontal	Peak
3561.64	34.57	29.19	8.21	37.09	34.88	74.00	-39.12	Horizontal	Peak
5151.68	33.77	31.69	9.79	35.08	40.17	74.00	-33.83	Horizontal	Peak
6331.33	33.23	33.16	11.00	33.79	43.60	74.00	-30.40	Horizontal	Peak

Remark:

1. Final Level = Receiver Read level + Antenna Factor + Cable Loss – Pre-amplifier Factor
2. The peak level is lower than average limit (54 dBuV/m), this data is too weak; instrument of signal is unable to test.
3. The emission levels of other frequencies are very lower than the limit and not shown in test report.

**Bandedge Emission**

Low edge									
Frequency (MHz)	Read Level (dBuV)	Antenna Factor (dB/m)	Cable Loss (dB)	Preamplifier Factor (dB)	Level (dBuV/m)	AV Limit (dBuV/m)	Over Limit (dB)	Polarization	Test value
2310.00	31.81	28.05	6.62	37.59	28.89	54.00	-25.11	Vertical	Peak
2390.03	31.78	27.65	6.75	37.59	28.59	54.00	-25.41	Vertical	Peak
2400.18	31.87	27.60	6.77	37.59	28.65	54.00	-25.35	Vertical	Peak
2310.00	32.56	28.05	6.62	37.59	29.64	54.00	-24.36	Horizontal	Peak
2390.03	31.90	27.65	6.75	37.59	28.71	54.00	-25.29	Horizontal	Peak
2400.18	33.00	27.60	6.77	37.59	29.78	54.00	-24.22	Horizontal	Peak

High edge									
Frequency (MHz)	Read Level (dBuV)	Antenna Factor (dB/m)	Cable Loss (dB)	Preamplifier Factor (dB)	Level (dBuV/m)	AV Limit (dBuV/m)	Over Limit (dB)	Polarization	Test value
2483.48	25.64	27.26	6.83	37.59	22.14	54.00	-31.86	Vertical	Peak
2500.00	24.79	27.20	6.84	37.59	21.24	54.00	-32.76	Vertical	Peak
2483.48	26.72	27.26	6.83	37.59	23.22	54.00	-30.78	Horizontal	Peak
2500.00	24.62	27.20	6.84	37.59	21.07	54.00	-32.93	Horizontal	Peak

## Remark:

1. Final Level = Receiver Read level + Antenna Factor + Cable Loss – Preamplifier Factor
2. The peak level is lower than average limit(54dBuV/m), this data is the too weak instrument of signal is unable to test.
3. The emission levels of other frequencies are very lower than the limit and not show in test report.

## 6. TEST SETUP PHOTOS OF THE EUT

Radiated Emissions

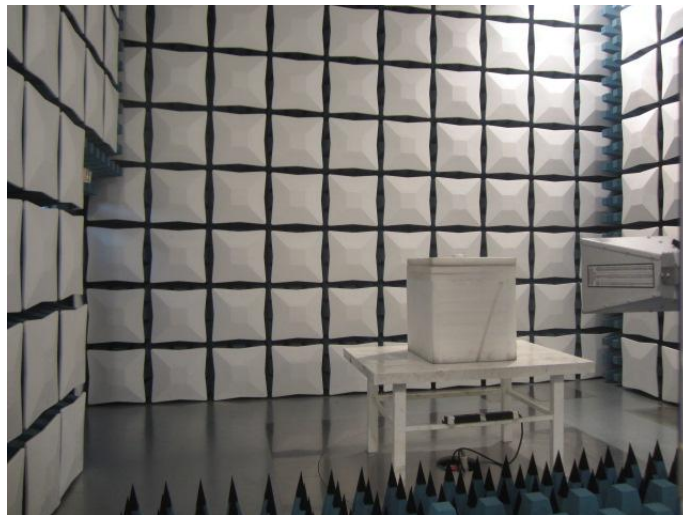

## 7. EXTERNAL AND INTERNAL PHOTOS OF THE EUT

### External Photos

GTW-RFID\_In

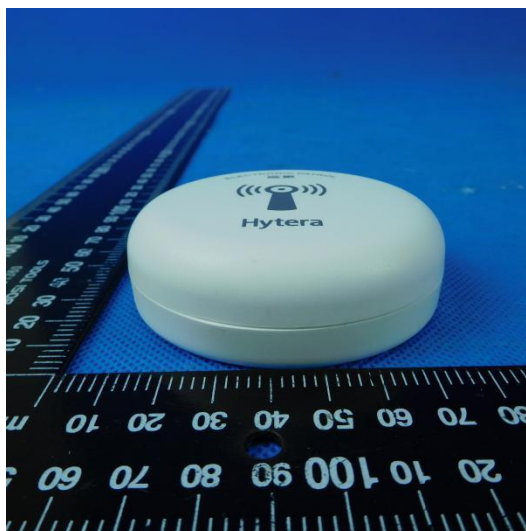
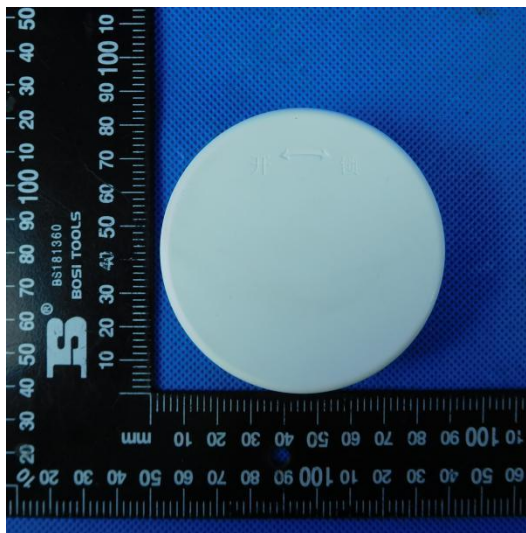



GTW-RFID\_Out

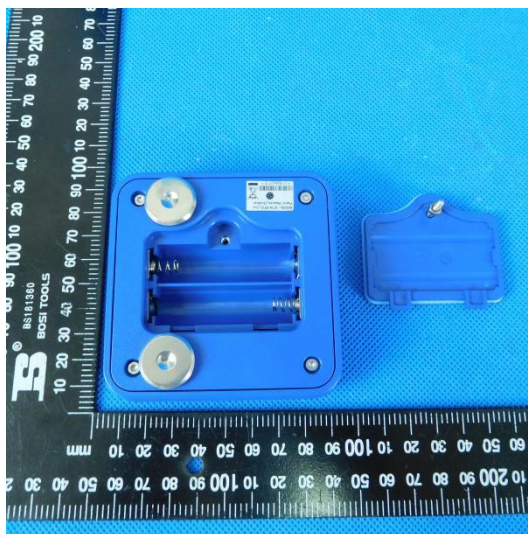
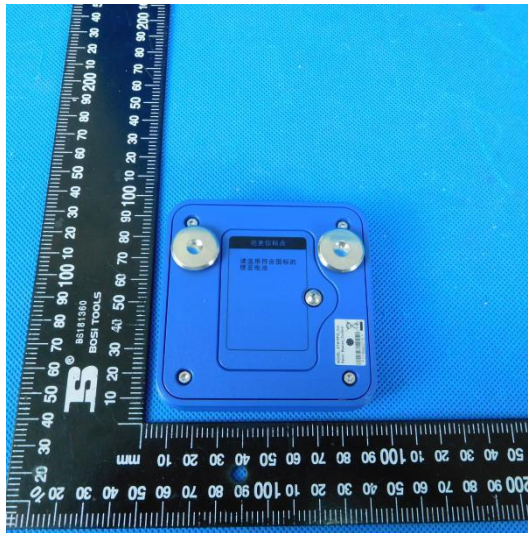
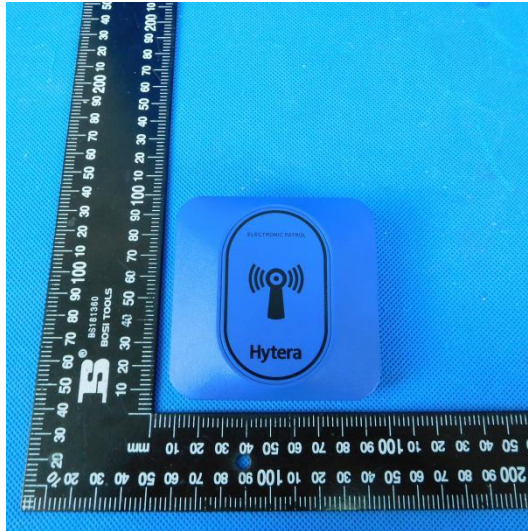

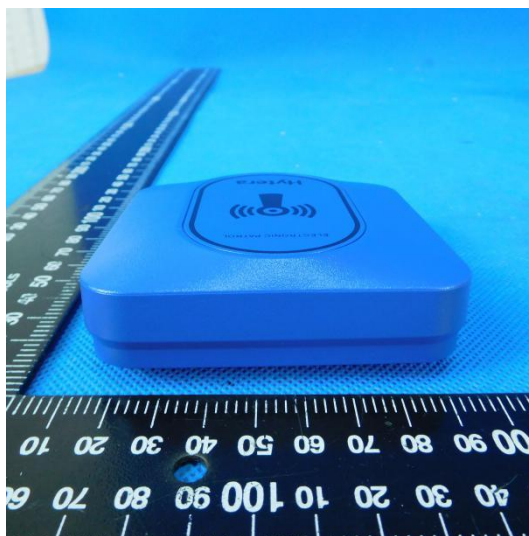
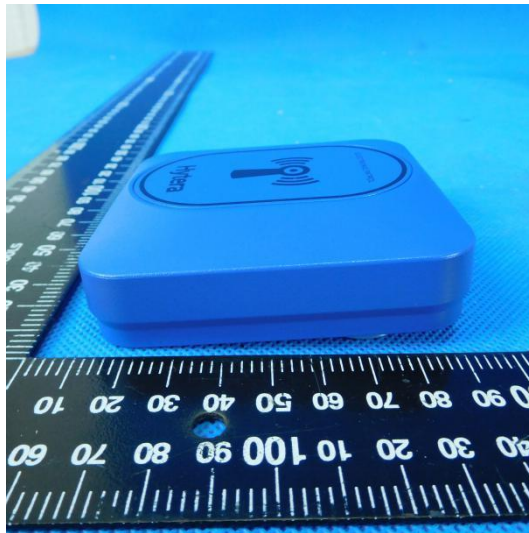
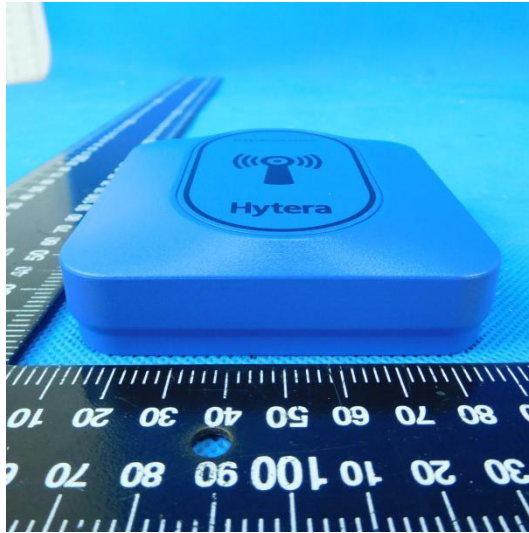



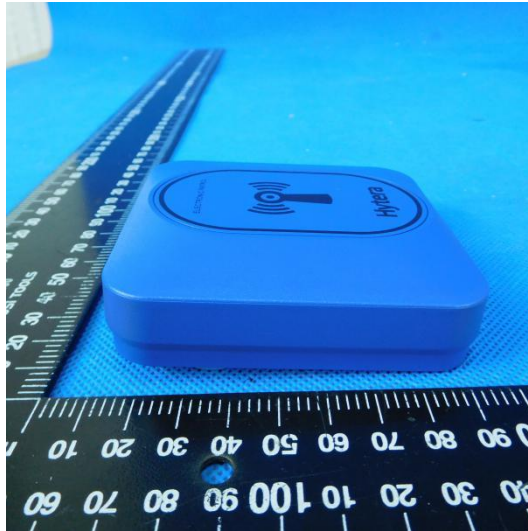

### Internal Photos

GTW-RFID\_In

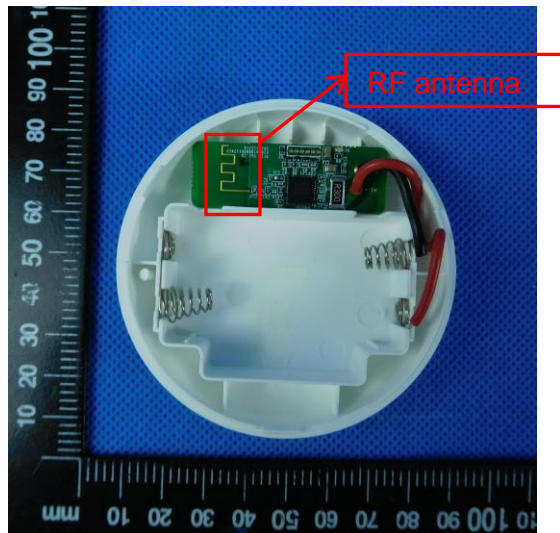
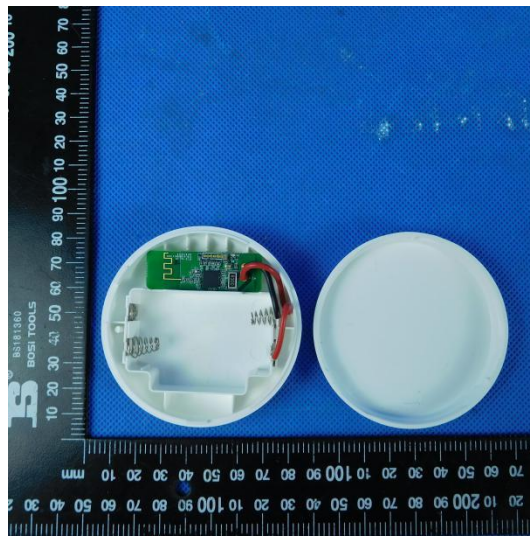

GTW-RFID\_Out

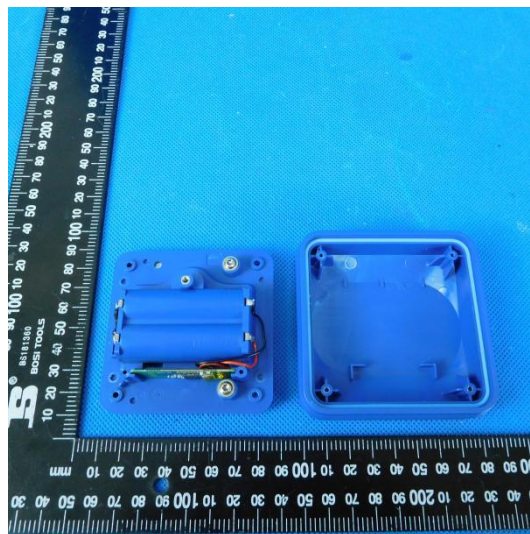

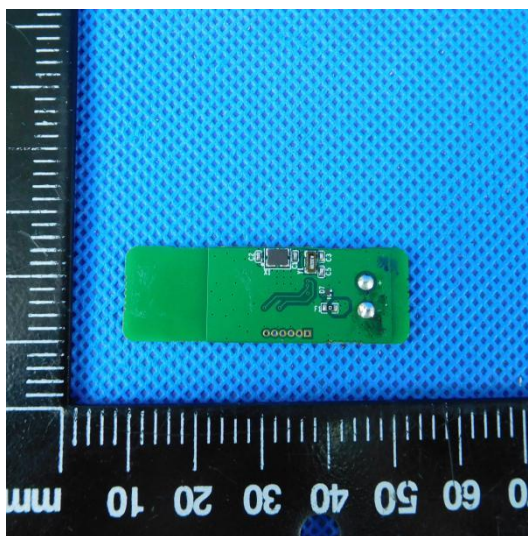
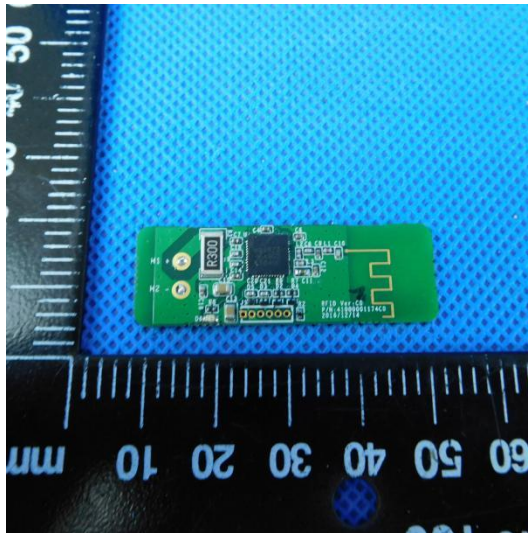
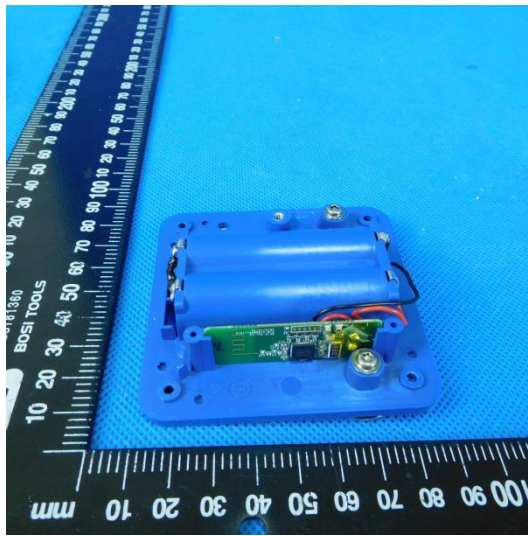



-----End of Report-----