



# TEST REPORT

**Report Reference No.....:** TRE17080230 R/C.....: 51070

**FCC ID.....:** YAMGTW-RFCD

**Applicant's name.....:** Hytera Communications Corporation Limited

Address .....: Hytera Tower, Hi-Tech Industrial Park North, 9108# Beihuan Road, Nanshan District, Shenzhen, People's Republic of China

Manufacturer.....: Hytera Communications Corporation Limited

Address .....: Hytera Tower, Hi-Tech Industrial Park North, 9108# Beihuan Road, Nanshan District, Shenzhen, People's Republic of China

**Test item description .....** **Patrol Beacon Tool**

Trade Mark .....: Hytera

Model/Type reference .....: GTW-RFCD

Listed Model(s).....: -

**Standard .....** **FCC CFR Title 47 Part 15 Subpart C Section 15.249**

Date of receipt of test sample.....: Aug. 31, 2017

Date of testing.....: Sept. 01, 2017 – Sept. 14, 2017

Date of issue.....: Sept. 14, 2017

**Result.....:** **PASS**

Compiled by  
( position+printedname+signature) ...: File administrators Shayne Zhu

Supervised by  
(position+printedname+signature) ...: Project Engineer Cary Luo

Approved by  
(position+printedname+signature) ...: RF Manager Hans Hu

**Testing Laboratory Name .....** **Shenzhen Huatongwei International Inspection Co., Ltd.**

Address .....: 1/F, Bldg 3, Hongfa Hi-tech Industrial Park, Genyu Road, Tianliao, Gongming, Shenzhen, China

**Shenzhen Huatongwei International Inspection Co., Ltd. All rights reserved.**

This publication may be reproduced in whole or in part for non-commercial purposes as long as the Shenzhen Huatongwei International Inspection Co., Ltd. is acknowledged as copyright owner and source of the material. Shenzhen Huatongwei International Inspection Co., Ltd. takes no responsibility for and will not assume liability for damages resulting from the reader's interpretation of the reproduced material due to its placement and context.

## Contents

<b>1.</b>	<b><u>TEST STANDARDS AND TEST DESCRIPTION</u></b>	<b>3</b>
1.1.	Test Standards	3
1.2.	Report version	3
<b>2.</b>	<b><u>TEST DESCRIPTION</u></b>	<b>4</b>
<b>3.</b>	<b><u>SUMMARY</u></b>	<b>5</b>
3.1.	Client Information	5
3.2.	Product Description	5
3.3.	EUT operation mode	5
3.4.	EUT configuration	5
3.5.	Modifications	5
<b>4.</b>	<b><u>TEST ENVIRONMENT</u></b>	<b>6</b>
4.1.	Address of the test laboratory	6
4.2.	Test Facility	6
4.3.	Environmental conditions	7
4.4.	Statement of the measurement uncertainty	7
4.5.	Equipments Used during the Test	8
<b>5.</b>	<b><u>TEST CONDITIONS AND RESULTS</u></b>	<b>9</b>
5.1.	Antenna requirement	9
5.2.	AC Power Conducted Emissions	10
5.3.	20 dB Occupied Bandwidth	11
5.4.	Radiated Emissions	12
<b>6.</b>	<b><u>TEST SETUP PHOTOS OF THE EUT</u></b>	<b>16</b>
<b>7.</b>	<b><u>EXTERNAL AND INTERNAL PHOTOS OF THE EUT</u></b>	<b>18</b>

# **1. TEST STANDARDS AND TEST DESCRIPTION**

## **1.1. Test Standards**

The tests were performed according to following standards:

[FCC Rules Part 15.249](#): Operation within the bands 902-928 MHz, 2400-2483.5 MHz, 5725-5875 MHz, and 24.0-24.25 GHz.

[ANSI C63.10-2013](#): American National Standard for Testing Unlicensed Wireless Devices.

## **1.2. Report version**

Version No.	Date of issue	Description
00	Sept. 14, 2017	Original

## **2. Test Description**

Test Item	Section in CFR 47	Result
Antenna requirement	15.203	Pass
AC Power Line Conducted Emissions	15.207	N/A
20dB Occupied Bandwidth	15.215/15.249	Pass
Field strength of the Fundamental signal	15.249(a)	Pass
Spurious Emissions	15.209/15.249(a)	Pass
Band edge Emissions	15.205/15.249(d)	Pass

Remark: The measurement uncertainty is not included in the test result.

### 3. SUMMARY

#### 3.1. Client Information

Applicant:	Hytera Communications Corporation Limited
Address:	Hytera Tower, Hi-Tech Industrial Park North, 9108# Beihuan Road, Nanshan District, Shenzhen, People's Republic of China
Manufacturer:	Hytera Communications Corporation Limited
Address:	Hytera Tower, Hi-Tech Industrial Park North, 9108# Beihuan Road, Nanshan District, Shenzhen, People's Republic of China

#### 3.2. Product Description

Name of EUT:	Patrol Beacon Tool
Trade Mark:	Hytera
Model No.:	GTW-RFCD
Listed Model(s):	-
Power supply:	DC 4.5V
Adapter information :	-
Operation frequency:	2450MHz
Channel number:	1
Modulation Type:	GFSK
Antenna type:	Integral antenna
Antenna gain:	-2.2dBi

#### 3.3. EUT operation mode

For RF test items
The engineering test program was provided and enabled to make EUT continuous transmit.
For AC power line conducted emissions:
The EUT was set to connect with large package sizes transmission.

Note: New battery is used during all test

#### 3.4. EUT configuration

The following peripheral devices and interface cables were connected during the measurement:

- - supplied by the manufacturer
- - supplied by the lab

	Manufacturer :	/
	Model No. :	/
	Manufacturer :	/
	Model No. :	/

#### 3.5. Modifications

No modifications were implemented to meet testing criteria.

## **4. TEST ENVIRONMENT**

### **4.1. Address of the test laboratory**

Laboratory: Shenzhen Huatongwei International Inspection Co., Ltd.

Address: 1/F, Bldg 3, Hongfa Hi-tech Industrial Park, Genyu Road, Tianliao, Gongming, Shenzhen, China

Phone: 86-755-26748019 Fax: 86-755-26748089

### **4.2. Test Facility**

The test facility is recognized, certified, or accredited by the following organizations:

#### **CNAS-Lab Code: L1225**

Shenzhen Huatongwei International Inspection Co., Ltd. has been assessed and proved to be in compliance with CNAS-CL01 Accreditation Criteria for Testing and Calibration Laboratories (identical to ISO/IEC17025: 2005 General Requirements) for the Competence of Testing and Calibration Laboratories.

#### **A2LA-Lab Cert. No. 3902.01**

Shenzhen Huatongwei International Inspection Co., Ltd. EMC Laboratory has been accredited by A2LA for technical competence in the field of electrical testing, and proved to be in compliance with ISO/IEC 17025: 2005 General Requirements for the Competence of Testing and Calibration Laboratories and any additional program requirements in the identified field of testing.

#### **FCC-Registration No.: 762235**

Shenzhen Huatongwei International Inspection Co., Ltd. EMC Laboratory has been registered and fully described in a report filed with the FCC (Federal Communications Commission). The acceptance letter from the FCC is maintained in our files. Registration 762235.

#### **IC-Registration No.: 5377B-1**

Two 3m Alternate Test Site of Shenzhen Huatongwei International Inspection Co., Ltd. has been registered by Certification and Engineering Bureau of Industry Canada for the performance of radiated measurements with Registration No. 5377B-1.

#### **ACA**

Shenzhen Huatongwei International Inspection Co., Ltd. EMC Laboratory can also perform testing for the Australian C-Tick mark as a result of our A2LA accreditation.

### 4.3. Environmental conditions

During the measurement the environmental conditions were within the listed ranges:

Temperature:	15~35°C
Relative Humidity:	30~60 %
Air Pressure:	950~1050mba

### 4.4. Statement of the measurement uncertainty

The data and results referenced in this document are true and accurate. The reader is cautioned that there may be errors in calibration limits of the equipment and facilities. The measurement uncertainty was calculated for all measurements listed in this test report according to TR-100028-01 "Electromagnetic compatibility and Radio spectrum Matters (ERM);Uncertainties in the measurement of mobile radio equipment characteristics;Part 1" and TR-100028-02 "Electromagnetic compatibility and Radio spectrum Matters (ERM);Uncertainties in the measurement of mobile radio equipment characteristics;Part 2" and is documented in the Shenzhen Huatongwei International Inspection Co., Ltd quality system according to ISO/IEC 17025. Further more, component and process variability of devices similar to that tested may result in additional deviation. The manufacturer has the sole responsibility of continued compliance of the device.

Here after the best measurement capability for Shenzhen Huatongwei is reported:

Test Items	Measurement Uncertainty	Notes
Conducted spurious emissions 9KHz-30MHz	3.39 dB	(1)
Radiated Emissions 30~1000MHz	4.24 dB	(1)
Radiated Emissions 1~18GHz	5.16 dB	(1)
Radiated Emissions 18-40GHz	5.54 dB	(1)
Occupied Bandwidth	-----	(1)

(1) This uncertainty represents an expanded uncertainty expressed at approximately the 95% confidence level using a coverage factor of  $k=1.96$ .

#### 4.5. Equipments Used during the Test

Line Conducted Emission (AC Main)					
Item	Test Equipment	Manufacturer	Model No.	Serial No.	Last Cal.
1	EMI Test Receiver	R&S	ESCI	101247	2016/11/13
2	Artificial Mains	Shwarzbeck	NNLK 8121	573	2016/11/13
3	Pulse Limiter	R&S	ESH3-Z2	101488	2016/11/13
4	Test Software	R&S	ES-K1	N/A	N/A
5	Test cable	ENVIROFLEX	3651	1101902	2016/11/13

20dB Occupied Bandwidth					
Item	Test Equipment	Manufacturer	Model No.	Serial No.	Last Cal
1	Spectrum Analyzer	Rohde&Schwarz	FSP	1164.4391.40	2016/11/13
2	Power Meter	Anritsu	ML2480B	100798	2016/11/13
3	Power Sensor	Anritsu	MA2411B	100258	2016/11/13
4	Test cable	FARPU	MCX-J	N/A	2016/11/13
5	Temporary antenna connector	D-LENP	NJ-SMAK	N/A	2016/11/13

The temporary antenna connector is soldered on the PCB board in order to perform conducted tests and this temporary antenna connector is listed in the equipment list.

Field strength of the Fundamental signal/ Spurious Emissions/ Band edge					
Item	Test Equipment	Manufacturer	Model No.	Serial No.	Last Cal.
1	EMI Test Receiver	Rohde&Schwarz	ESI 26	100009	2016/11/13
2	RF Test Panel	Rohde&Schwarz	TS / RSP	335015/0017	N/A
3	EMI Test Software	Rohde&Schwarz	ESK1	N/A	N/A
4	Loop Antenna	Rohde&Schwarz	HZ-9	838622\013	2016/11/13
5	Ultra-Broadband Antenna	ShwarzBeck	VULB9163	538	2016/11/13
6	Horn Antenna	ShwarzBeck	9120D	1011	2016/11/13
7	Broadband Horn Antenna	Shwarzbeck	BBHA9170	BBHA917047 2	2016/11/13
8	Preamplifier	Shwarzbeck	BBV9742	9742-196	2016/11/13
9	Broadband Preamplifier	Shwarzbeck	BBV 9721	9721-102	2016/11/13
10	Broadband Preamplifier	Shwarzbeck	BBV 9718	9718-247	2016/11/13
11	Turn Table	MATURO	TT2.0	/	N/A
12	Antenna Mast	MATURO	TAM-4.0-P	/	N/A
13	EMI Test Software	Audix	E3	N/A	N/A
14	Test Software	R&S	ES-K1	N/A	N/A
15	Test cable	Siva Cables Italy	RG 58A/U	W14.02	2016/11/13

The Cal.Interval was one year



## 5. TEST CONDITIONS AND RESULTS

### 5.1. Antenna requirement

#### Requirement

##### **FCC CFR Title 47 Part 15 Subpart C Section 15.203:**

An intentional radiator shall be designed to ensure that no antenna other than that furnished by the responsible party shall be used with the device. The use of a permanently attached antenna or of an antenna that uses a unique coupling to the intentional radiator, the manufacturer may design the unit so that a broken antenna can be replaced by the user, but the use of a standard antenna jack or electrical connector is prohibited.

#### **Refer to statement below for compliance.**

The manufacturer may design the unit so that the user can replace a broken antenna, but the use of a standard antenna jack or electrical connector is prohibited. Further, this requirement does not apply to intentional radiators that must be professionally installed.

#### **Test Result:**

The directional gain of the antenna less than -2.2dBi, please refer to the below antenna photo.

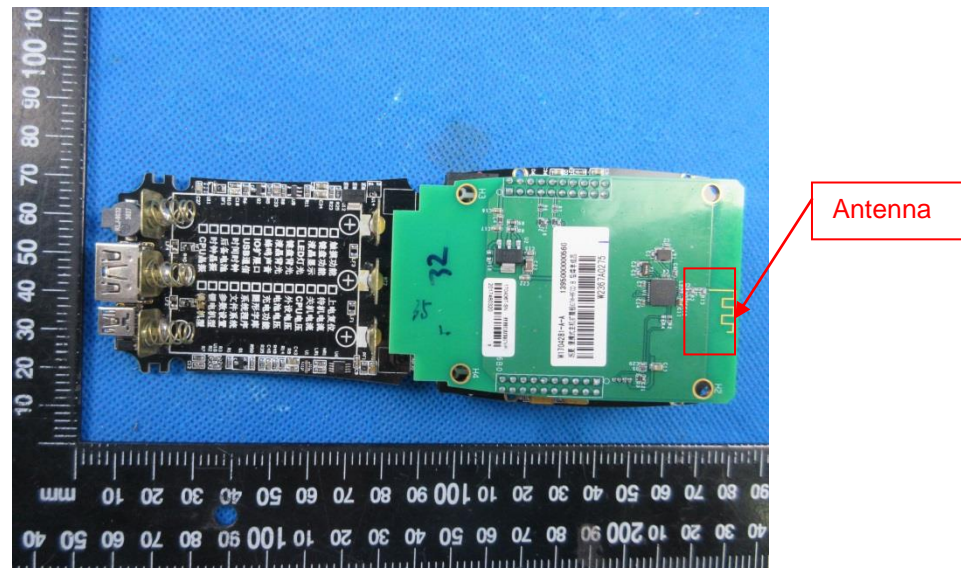

## 5.2. AC Power Conducted Emissions

### LIMIT

FCC CFR Title 47 Part 15 Subpart C Section 15.207:

Frequency range (MHz)	Limit (dBuV)	
	Quasi-peak	Average
0.15-0.5	66 to 56*	56 to 46*
0.5-5	56	46
5-30	60	50

\* Decreases with the logarithm of the frequency.

### TEST CONFIGURATION

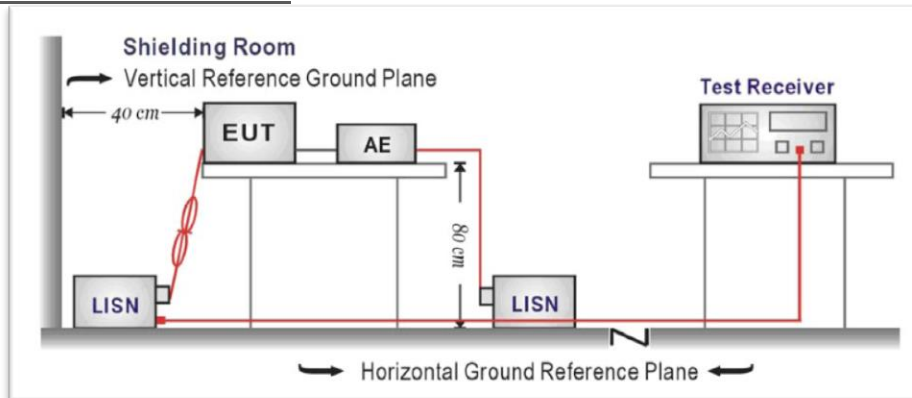

### TEST PROCEDURE

1. The EUT was setup according to ANSI C63.10:2013 for compliance to FCC 47CFR 15.247 requirements.
2. The EUT was placed on a plat form of nominal size, 1 m by 1.5 m, raised 10 cm above the conducting ground plane. The vertical conducting plane was located 40 cm to the rear of the EUT. All other surfaces of EUT were at least 10 cm from any other grounded conducting surface.
3. The EUT and simulators are connected to the main power through a line impedance stabilization network (LISN). The LISN provides a 50ohm / 50uH coupling impedance for the measuring equipment.
4. The peripheral devices are also connected to the main power through a LISN. (Please refer to the block diagram of the test setup and photographs)
5. Each current-carrying conductor of the EUT power cord, except the ground (safety) conductor, was individually connected through a LISN to the input power source.
6. The excess length of the power cord between the EUT and the LISN receptacle were folded back and forth at the center of the lead to form a bundle not exceeding 40 cm in length.
7. Conducted emissions were investigated over the frequency range from 0.15MHz to 30MHz using a receiver bandwidth of 9 kHz.
8. During the above scans, the emissions were maximized by cable manipulation.

### TEST RESULTS

Passed       Not Applicable

### 5.3. 20 dB Occupied Bandwidth

#### Limit

Operation frequency range 2400MHz~2483.5MHz.

#### TEST CONFIGURATION

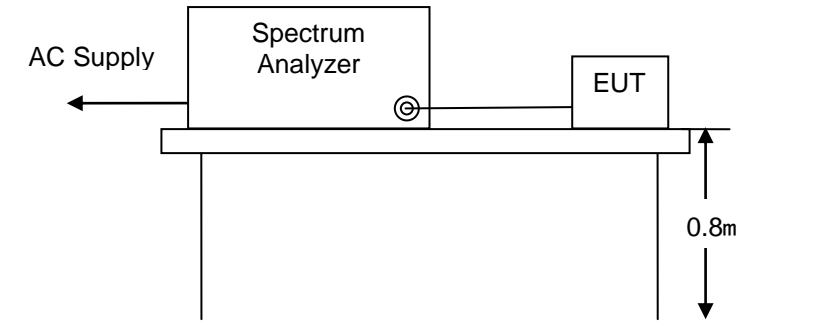

#### TEST PROCEDURE

- 1.As required by 47 CFR 15.215 and 47 CFR 15.249
2. The EUT connected to the spectrum analyzer was operated in linear scale and 5.0MHz span mode after tuning to the transmitter frequency.

#### TEST RESULTS

Channel Frequency(MHz)	20dB Bandwidth(MHz)	Result
2450	1.14	PASS



### 5.4. Radiated Emissions

#### LIMIT

For intentional device, according to § 15.209(a), the general requirement of field strength of radiated emission from intentional radiators at a distance of 3 meters shall not exceed the following table:

Frequency (MHz)	Distance(Meters)	Radiated(dBuV/m)	Radiated(µV/m)
0.009 - 0.490	300	$20 \cdot \log(2400/F(\text{kHz}))$	$2400/F(\text{kHz})$
0.490 - 1.705	30	$20 \cdot \log(24000/F(\text{kHz}))$	$24000/F(\text{kHz})$
1.705 - 30.0	30	29.54	30
30-88	3	40.0	100
88-216	3	43.5	150
216-960	3	46.0	200
Above 960	3	54.0	500

Remark:At frequencies below 30MHz, Limit 3m(dBuV)=Limit xm(dBuV)+20log(xm/3m);  
 At frequencies below 30MHz, Limit 3m(dBuV)=Limit xm(dBuV)+40log(xm/3m),x replace the number 10.30.300.

In addition to the provisions of §15.249, the field strength of emissions from intentional radiators operated under this section shall not exceed thefollowing:

Fundamental frequency	Field strength of fundamental (millivolts/meter)	Field strength of harmonics (microvolts/meter)
902-928 MHz	50	500
2400-2483.5 MHz	50	500
5725-5875 MHz	50	500
24.0-24.25 GHz	250	2500

#### TEST CONFIGURATION

Radiated Emission Test Set-Up  
 Frequency range 9KHz–30MHz

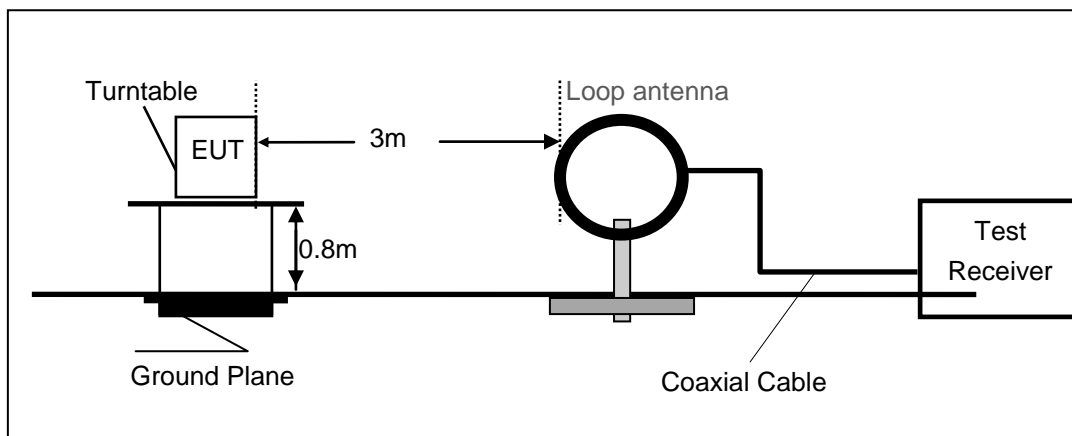

Frequency range 30MHz – 1000MHz

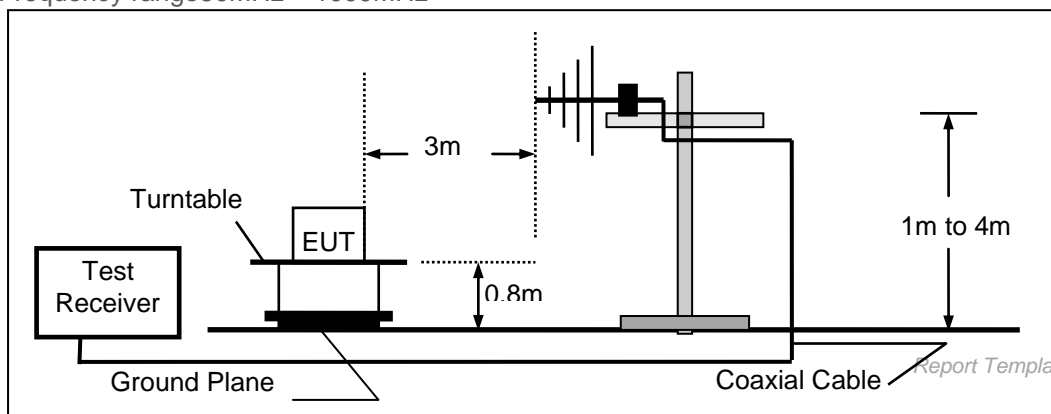

Frequency range above 1GHz-25GHz

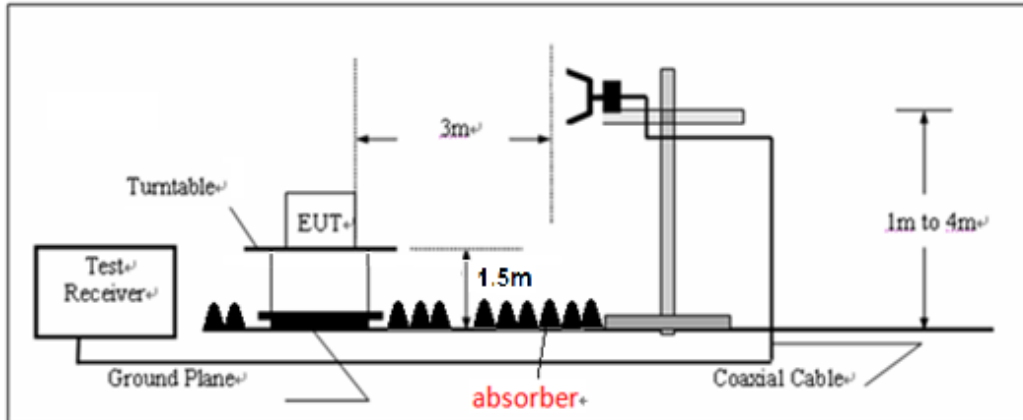

### TEST PROCEDURE

1. The EUT was tested according to ANSI C63.10:2013 for compliance to FCC 47CFR 15.247 requirements.
2. The EUT is placed on a turn table which is 0.8/1.5 meter above ground plane. The turn table is rotated 360 degrees to determine the position of the maximum emission level.
3. The EUT was positioned such that the distance from antenna to the EUT was 3 meters.
4. The antenna is scanned from 1 meter to 4 meters to find out the maximum emission level. This is repeated for both horizontal and vertical polarization of the antenna.
5. Use the following spectrum analyzer settings
  - (1) Span shall wide enough to fully capture the emission being measured;
  - (2) Below 1GHz, RBW=120KHz, VBW=300KHz, Sweep=auto, Detector function=QP, Trace=max hold; If the emission level of the EUT measured by the peak detector is 3 dB lower than the applicable limit, the peak emission level will be reported. Otherwise, the emission measurement will be repeated using the quasi-peak detector and reported.
  - (3) Above 1GHz, RBW=1MHz, VBW=3MHz Peak detector for Peak value  
RBW=1MHz, VBW=3MHz RMS detector for Average value.

Remark: "floor-standing equipment" Where possible, the antenna(s) of the EUT shall be located at a height of 1.5 m above the floor, and the intentional radiator circuitry shall be located within the system at a height of at least 0.8 m above the floor.

### TEST RESULTS

#### ■ 9kHz ~ 30MHz

The EUT was pre-scanned the frequency band (9KHz~30MHz), found the radiated level lower than the limit, so don't show on the report.

■ 30MHz ~ 1GHz

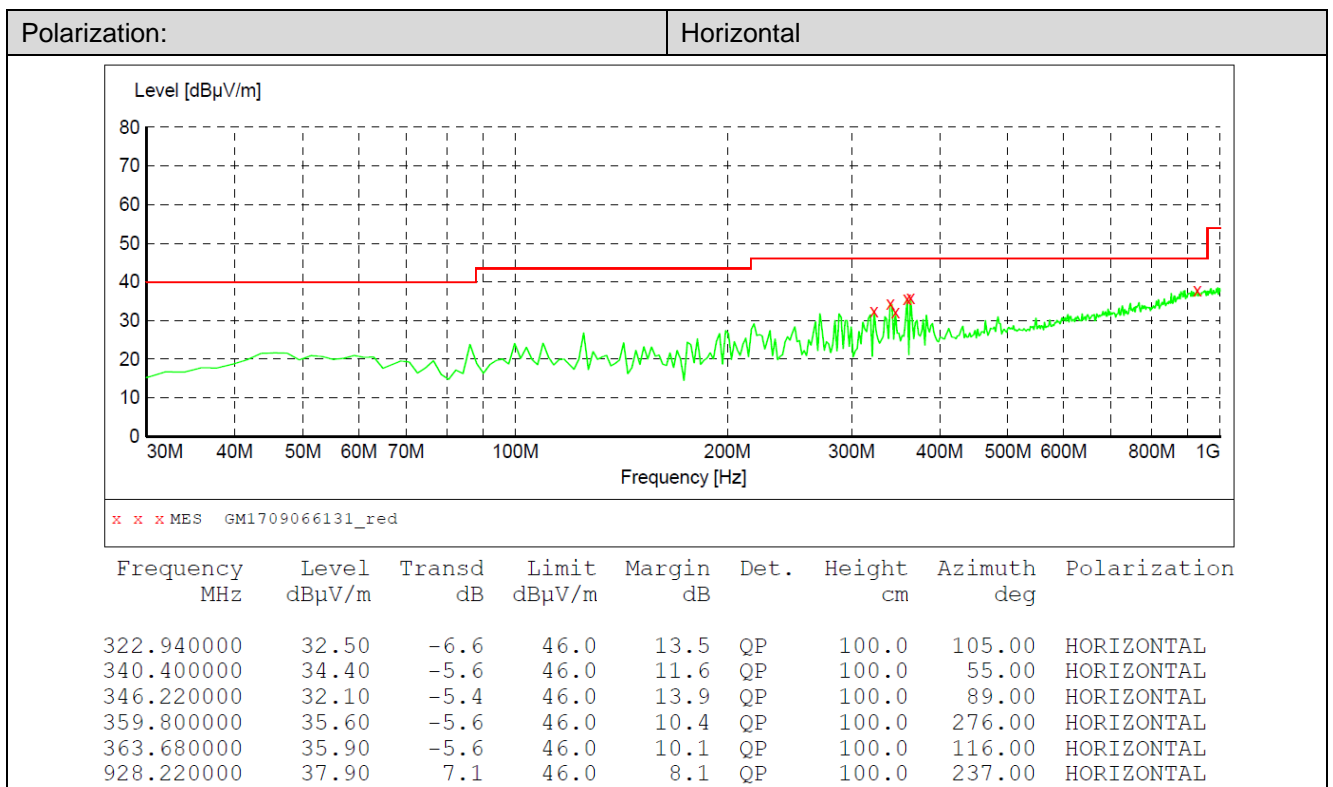
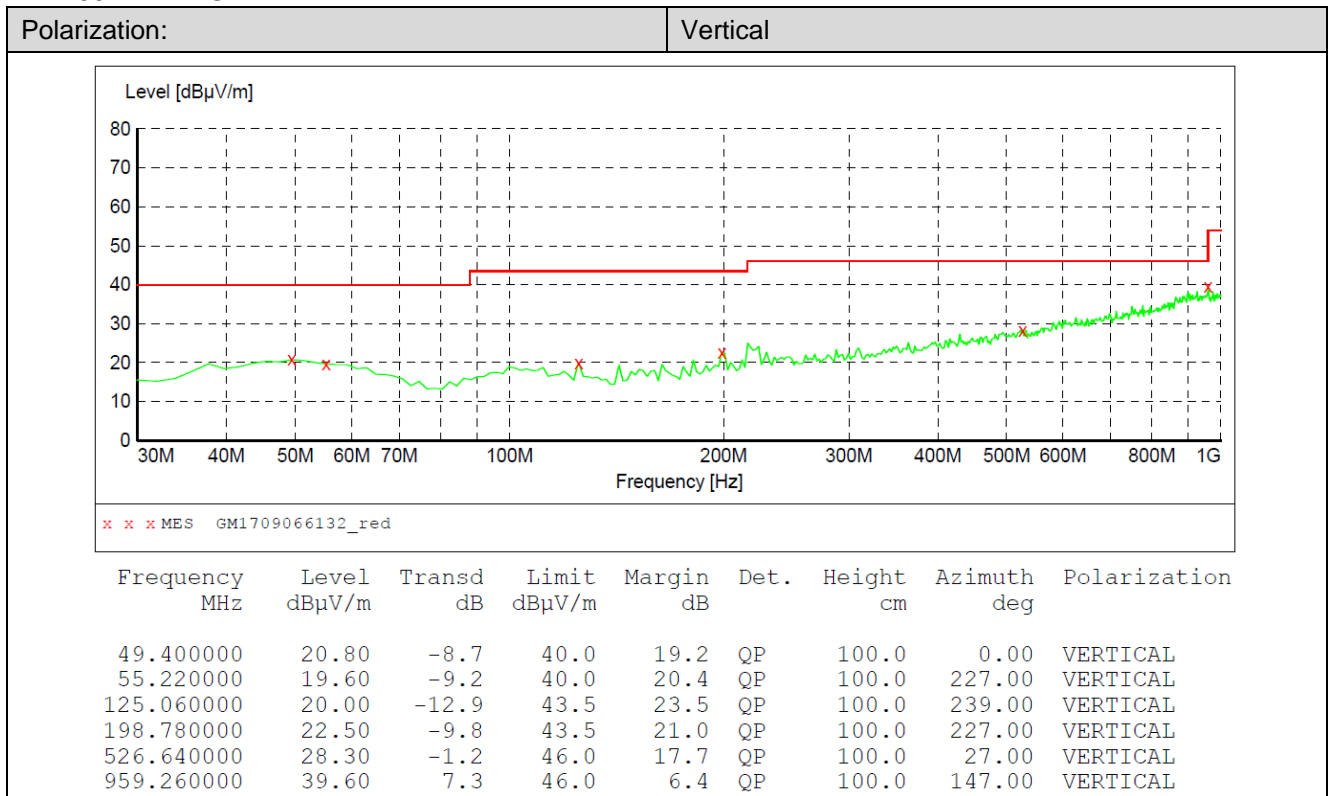

■ 1GHz ~ 25GHz

Radiated emissions of fundamental emissions									
Frequency (MHz)	Read Level (dB $\mu$ V)	Antenna Factor (dB)	Cable Loss (dB)	Preamp Factor (dB)	Level (dB $\mu$ V/m) @3m	FCC Limit (dB $\mu$ V/m) @3m	Margin (dB)	Detector	Polarization
2450	88.81	27.40	6.81	37.88	85.14	114	-28.86	Peak	Horizontal
2450	95.42	27.40	6.81	37.88	91.75	114	-22.25	Peak	Vertical

Radiated emissions of harmonics emissions									
Frequency (MHz)	Read Level (dB $\mu$ V)	Antenna Factor (dB)	Cable Loss (dB)	Preamp Factor (dB)	Level (dB $\mu$ V/m) @3m	FCC Limit (dB $\mu$ V/m) @3m	Margin (dB)	Detector	Polarization
4900	44.42	31.41	9.61	36.68	48.76	74	-25.24	Peak	Horizontal
4900	40.25	31.41	9.61	36.68	44.59	74	-29.41	Peak	Vertical
7350	34.26	36.29	11.99	34.94	47.6	74	-26.4	Peak	Horizontal
7350	32.42	36.29	11.99	34.94	45.76	74	-28.24	Peak	Vertical

Spurious radiated emissions									
Frequency (MHz)	Read Level (dB $\mu$ V)	Antenna Factor (dB)	Cable Loss (dB)	Preamp Factor (dB)	Level (dB $\mu$ V/m) @3m	FCC Limit (dB $\mu$ V/m) @3m	Margin (dB)	Detector	Polarization
1431.047	37.69	25.87	5.09	36.50	32.15	74	-41.85	Peak	Horizontal
3890.255	36.32	29.69	8.63	38.18	36.46	74	-37.54	Peak	
4547.396	34.78	30.80	9.37	37.32	37.63	74	-36.37	Peak	
7454.429	33.86	36.19	12.25	34.86	47.44	74	-26.56	Peak	
1398.336	37.82	25.90	5.00	36.46	32.26	74	-41.74	Peak	Vertical
4039.212	36.77	29.78	8.81	38.02	37.34	74	-36.66	Peak	
6071.417	33.55	32.50	10.79	35.39	41.45	74	-32.55	Peak	
8200.463	33.29	36.70	12.77	34.55	48.21	74	-25.79	Peak	

Band edge emissions									
Frequency (MHz)	Read Level (dB $\mu$ V)	Antenna Factor (dB)	Cable Loss (dB)	Preamp Factor (dB)	Level (dB $\mu$ V/m)	Limit Line (dB $\mu$ V/m)	Margin Limit (dB)	Polarization	Detector
2400	45.32	27.60	6.77	37.90	41.79	74	-32.21	Horizontal	Peak
2400	45.41	27.60	6.77	37.90	41.88	74	-32.12	Vertical	
2483.5	44.39	27.85	6.83	37.87	41.2	74	-32.8	Horizontal	
2483.5	46.78	27.85	6.83	37.87	43.59	74	-30.41	Vertical	

Note:

Level= Read Level+ Antenna Factor+ Cable Loss- Preamp Factor

Margin Limit = Level- Limit Line

Peak Level lower than the average limit, so the average Level don't show on the report.



## 6. Test Setup Photos of the EUT

Radiated Emissions

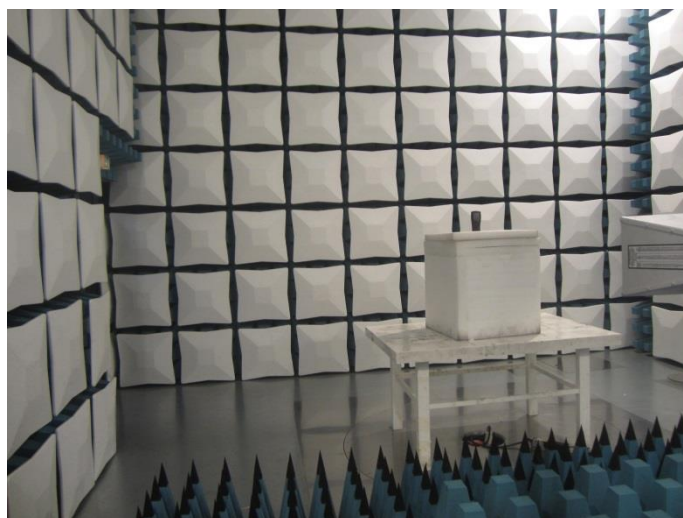



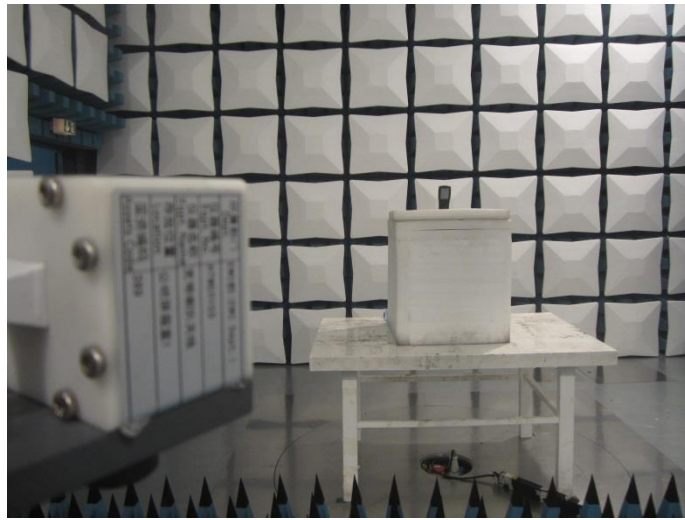

## 7. External and Internal Photos of the EUT

### External Photos of the EUT



### Internal Photos of the EUT

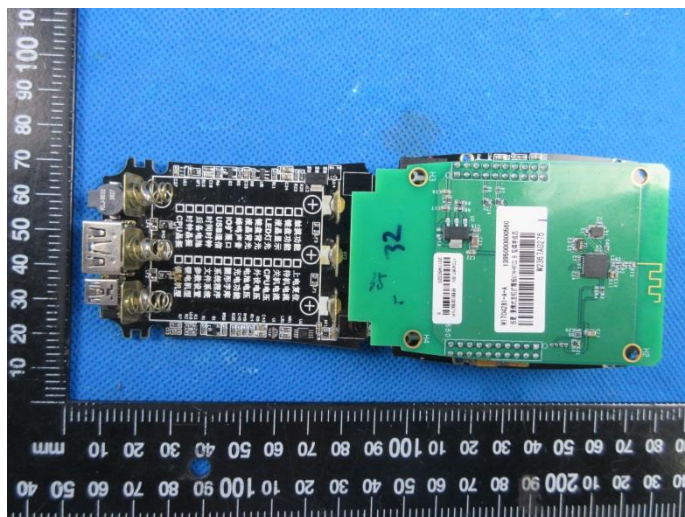
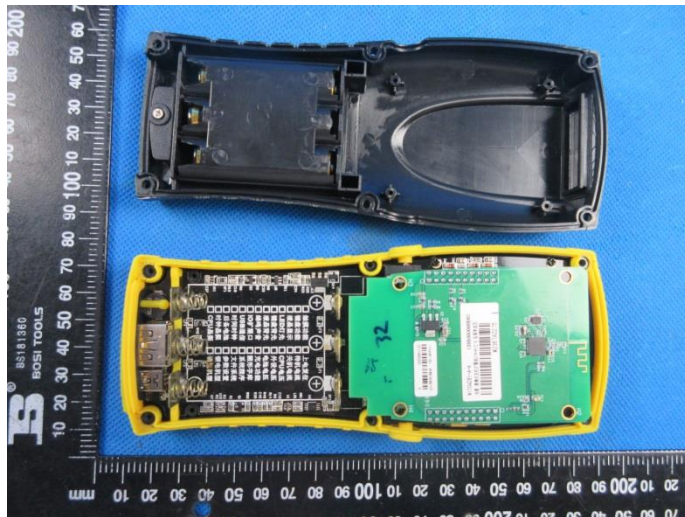



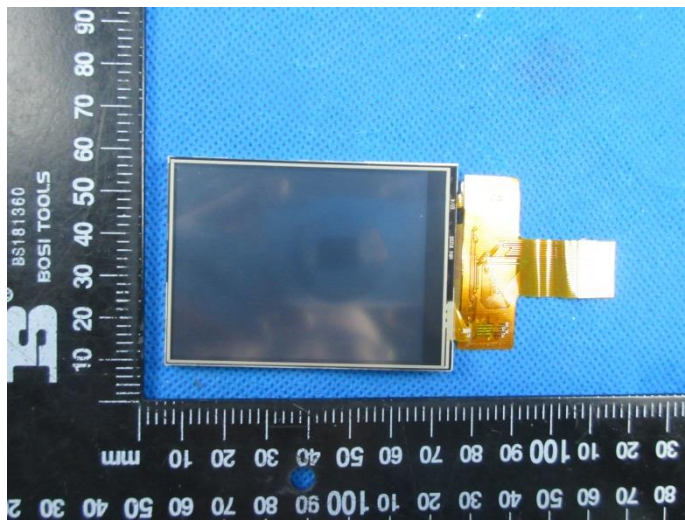
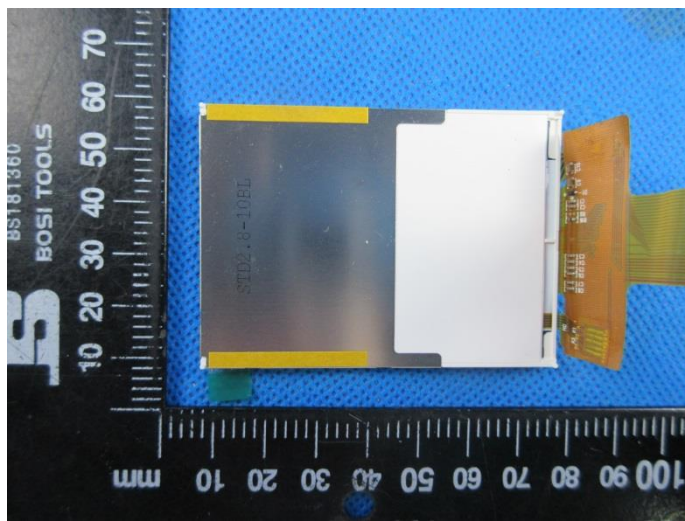
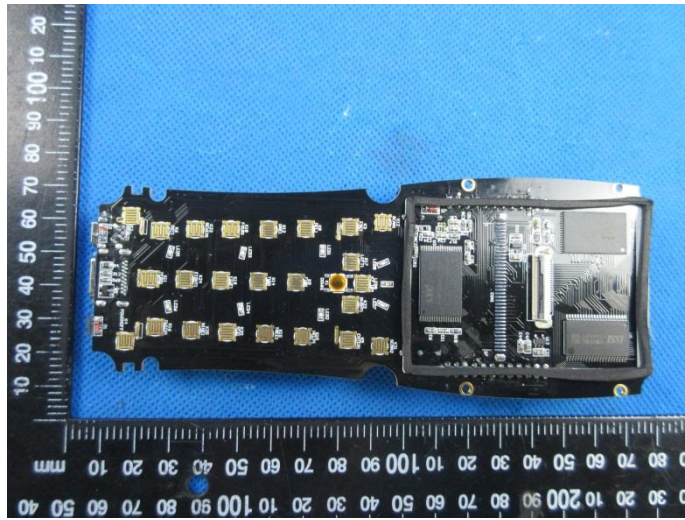

-----End of Report-----