

DS-6210 Base Station Owner's Manual

Version: V00

Release Date: July 29th, 2011

Copyright Information

Hytera is the trademark or registered trademark of Hytera Communications Co., Ltd. (the Company) in PRC and/or other countries or areas. The Company retains the ownership of its trademarks and product names. All other trademarks and/or product names that may be used in this manual are properties of their respective owners.

The product described in this manual may include the Company's computer programs stored in memory or other media. Laws in PRC and/or other countries or areas protect the exclusive rights of the Company with respect to its computer programs. The purchase of this product shall not be deemed to grant, either directly or by implication, any rights to the purchaser regarding the Company's computer programs. Any of the Company's computer programs may not be copied, modified, distributed, decompiled, or reverse-engineered in any manner without the prior written consent of the Company.

Disclaimer

The Company endeavors to achieve the accuracy and completeness of this manual, but no warranty of accuracy or reliability is given. All the specifications and designs are subject to change without notice due to continuous technology development. No part of this manual may be copied, modified, translated, or distributed in any manner without the express written permission of us.

If you have any suggestions or would like to learn more details, please visit our website at:

<http://www.hytera.com>.

Contents

Preface	1
1. Checking Items in the Package	2
2. Product Controls	3
2.1 Base Station Interface Unit	3
2.1.1 Antenna Connector	3
2.1.2 Extended Interface Board	4
2.1.3 Power Supply Module	5
2.2 Cartridge	5
2.3 Channel Unit	5
2.3.1 Function	6
2.3.2 Front Panel	6
2.3.3 LED Indicator	7
2.4 Base Station Controller Unit (BSCU)	8
2.4.1 Function	9
2.4.2 Front Panel	9
2.4.3 LED Indicator	10
2.4.4 Power Support Unit (PSU)	11
2.4.5 Function	11
2.4.6 Front Panel	12
2.4.7 LED Indicator	13
2.4.8 Interconnect Backboard (ICB)	13
2.4.9 Front Side	14
2.4.10 Back Side	14
2.5 Fan Unit (FAN)	16
2.5.1 Front Panel	16
2.5.2 LED Indicator	17
2.5.3 Rear Panel	17
2.6 Divider Unit (DIU)	18
2.6.1 Function	18
2.6.2 Front Panel	19
2.6.3 Rear Panel	19
2.7 Router	20
2.7.1 Function	20
2.7.2 Front Panel	20
2.7.3 Rear Panel	21
2.7.4 LED Indicator	21

2.8 Combiner (COM).....	22
2.8.1 Function.....	23
2.8.2 Rear Panel.....	23
3. Installation	24
3.1 Cable Layout.....	24
3.2 Safety Information.....	25
3.2.1 Power Supply.....	25
3.2.2 Working at Heights.....	25
3.3 Installation Preparation	26
3.3.1 Technical Files	26
3.3.2 Personnel	26
3.3.3 Tools	26
3.4 Unpacking Inspection.....	27
3.4.1 Check before Unpacking.....	27
3.4.2 Unpacking Wooden Case	27
3.4.3 Unpacking Cartons	29
3.4.4 Inspections.....	29
3.5 Installing the Cabinet	29
3.5.1 Determine the Installation Position	29
3.5.2 Installing the Cabinet	31
3.6 Installing Modules into the Cabinet	32
3.6.1 Module Layout	32
3.6.2 Installation Procedures	32
3.7 Installing Cables	36
3.7.1 Equipment Status.....	36
3.7.2 Cables	37
3.8 Examination after Installation.....	37
3.8.1 Equipment Status.....	37
3.8.2 Examining the Cabinet.....	38
3.8.3 Examining Cables.....	38
3.8.4 Power On and Examination	39
3.8.5 Environment Examination	39
4. Basic Operations	40
4.1 Powering on	40
4.2 Powering off.....	40
5. Troubleshooting	41
6. Routine Maintenance	42
6.1 Purpose	42

6.2 Tasks42

A Abbreviations43

Figures

Figure 2-1 Components of Base Station Interface Unit	3
Figure 2-2 Antenna Connector	4
Figure 2-3 Extended Interface Board	4
Figure 2-4 Components of Power Supply Module	5
Figure 2-5 Full Configuration for Main Chassis	5
Figure 2-6 Logical Architecture of Channel Unit	6
Figure 2-7 Front Panel of CHU	7
Figure 2-8 Logic Architecture of BSCU	8
Figure 2-9 Front Panel of BSCU	9
Figure 2-10 Front Panel of PSU	12
Figure 2-11 ICB (front side)	14
Figure 2-12 ICB (back side)	15
Figure 2-13 Front Panel of FAN	16
Figure 2-14 Rear Panel of FAN	17
Figure 2-15 Diagram of DIU	18
Figure 2-16 Front Panel of DIU	19
Figure 2-17 Rear Panel of DIU	19
Figure 2-18 Front Panel of Router	20
Figure 2-19 Rear Panel of Router	21
Figure 2-20 Logic Diagram of Four Combiners	23
Figure 2-21 Rear Panel of Combiner	23
Figure 3-1 Diagram of Cable Connection	24
Figure 3-2 Remove the Cover	28
Figure 3-3 Place the Wooden Case Upright	28
Figure 3-4 Layout of holes for a Single Cabinet	30

Figure 3-5 Layout of holes for Combined Cabinet.....	31
Figure 3-6 Tighten the Bolt.....	32
Figure 3-7 Layout of Modules in the Cabinet.....	32
Figure 3-8 Opening the Cabinet Door	33
Figure 3-9 Disassembling the Side Door.....	33
Figure 3-10 Loosening the Ejector	34
Figure 3-11 Installing the BSCU	34
Figure 3-12 Installing the FAN.....	35
Figure 3-13 Removing the FAN.....	35
Figure 3-14 Installing the Divider Unit	35
Figure 3-15 Installing the Combiner Unit.....	36
Figure 3-16 Cable Diagram	36
Figure 3-17 External Cable Connection	37

Tables

Figure 1-1 Packing List.....	2
Table 2-1 Descriptions on CHU Front Panel	7
Table 2-2 Descriptions on CHU Indicators	8
Table 2-3 Descriptions on BSCU Front Panel	9
Table 2-4 Descriptions on BSCU Indicators	11
Table 2-5 Descriptions on PSU	12
Table 2-6 Descriptions on PSU Front Panel.....	13
Table 2-7 Descriptions on PSU Indicators.....	13
Table 2-8 Description on ICB (front side)	14
Table 2-9 Description on ICB Interfaces (Back Side)	16
Table 2-10 Description on ICB DIP Switch	16
Table 2-11 Descriptions on FAN Indicators.....	17
Table 2-12 Descriptions on FAN Front Panel.....	18
Table 2-13 Descriptions on FAN DIP Switch Settings.....	18
Table 2-14 Descriptions on DIU Front Panel.....	19
Table 2-15 Descriptions on DIU Rear Panel	20
Table 2-16 Description on DIU Address Setting	20
Table 2-17 Descriptions on Router Rear Panel.....	21
Table 2-18 Descriptions on Router Indicators	22
Table 2-19 Descriptions on COM Front Panel.....	23
Table 3-1 Technical Files	26
Table 3-2 Tools and Meter	26
Table 3-3 Cables Description	37
Table 3-4 Checklist of Cabinet Installation	38
Table 3-5 Checklist of Cables	38
Table 3-6 Checklist of Power Situation.....	39

Table 3-7 Checklist of Environment on Site39

Table 7-1 Troubleshooting41





This page is intentionally left blank.

Preface

This section describes the conventions and revision history of this document.

Documentation Conventions

Instructional Icons

Icon	Description
 Tip	Indicates information that can help you make better use of your product.
 Note	Indicates references that can further describe the related topics.
 Caution	Indicates situations that could cause data loss or equipment damage.
 Warning	Indicates situations that could cause minor personal injury.
 Danger	Indicates situations that could cause major personal injury or even death.

Notational Conventions

Item	Description
“ ”	This symbol is used to describe name of an interface control item. For example, click “OK”.
【 】	This symbol is used to describe name of a button for a terminal. For example, press the PTT key.
->	This symbol is used to direct you to access multi-level menus. For example, to select “New” from the “File” menu, we will describe it as follows: File->New.

Revision History

Version	Release Date	Description
V00	July 29 th , 2011	Initial Release.

1. Checking Items in the Package

No.	Item	Qty. (PCS)
1	Base Station Controller Unit (BSCU)	1
2	Channel Unit (CHU)	4
3	Power Support Unit (PSU)	2
4	Fan Unit	1
5	Divider Unit (DIU)	1
6	Combiner Unit (COM)	1
7	Cabinet Kit	1

Figure 1-1 Packing List

2. Product Controls

2.1 Base Station Interface Unit

The base station interface unit on top of the cabinet consists of the antenna connector, extended interface board and power supply module. See [Figure 2-1](#).

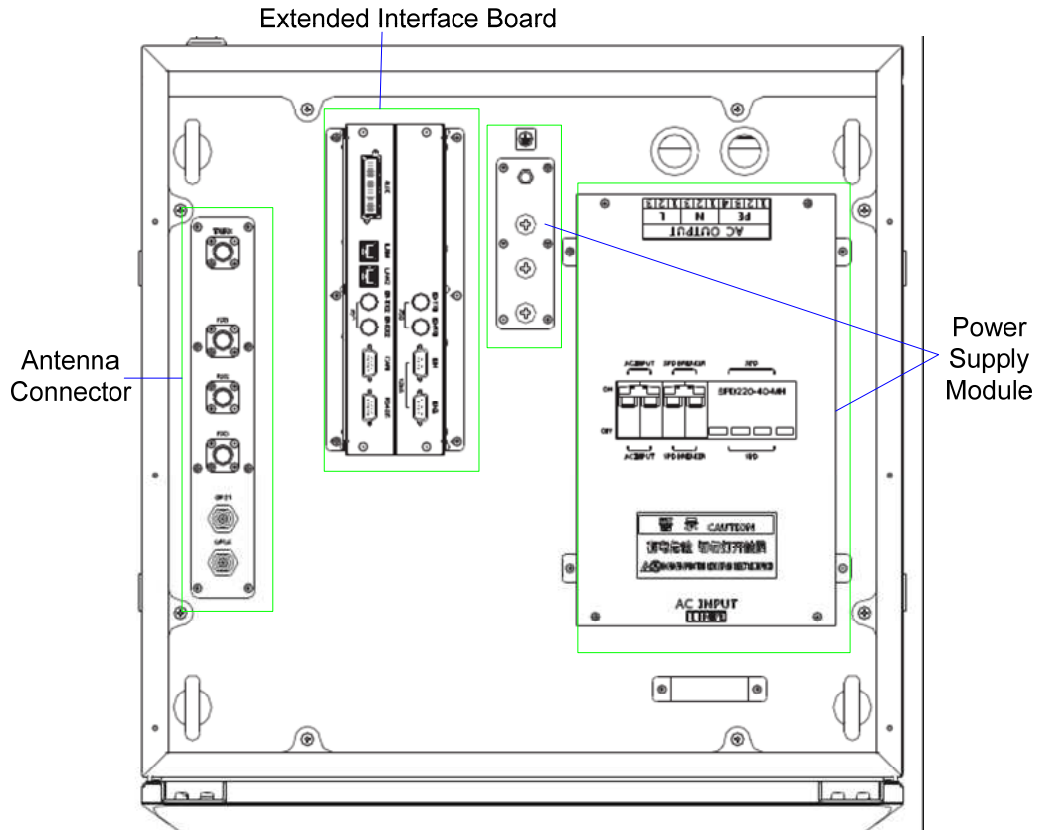

Figure 2-1 Components of Base Station Interface Unit

2.1.1 Antenna Connector

The antenna connector is described in [Figure 2-2](#).

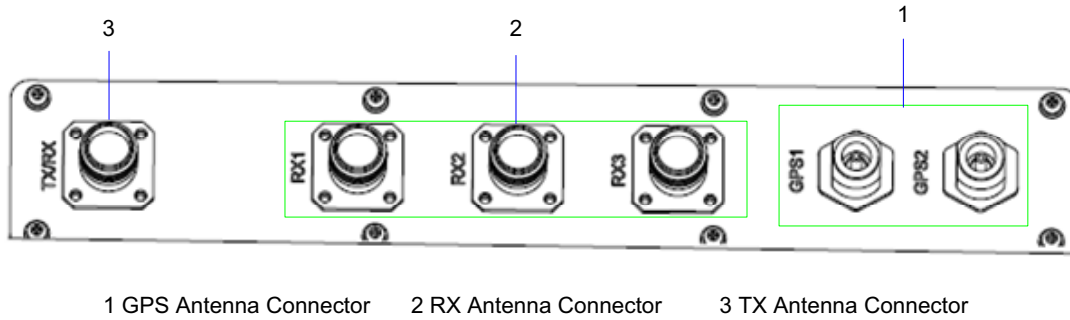

Figure 2-2 Antenna Connector

2.1.2 Extended Interface Board

The extended interface board consists of core network interface, extended interface and monitor interface. See [Figure 2-3](#).

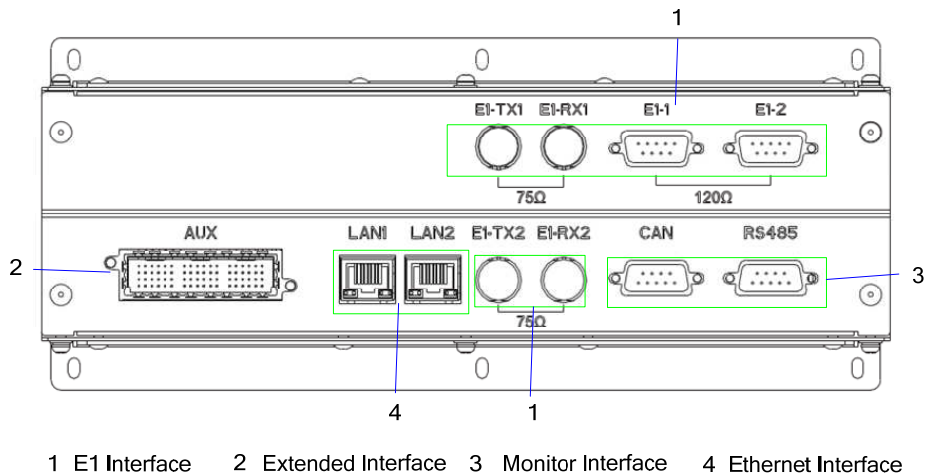

Figure 2-3 Extended Interface Board

Core network interface

The core network interface contains 4-path EI interface and 2-path Ethernet interface.

Extended interface

The extended interface has 8-path extended signals. It is applied to connect to four interconnect relay units of another cabinet, in case of combining two cabinets.

Monitor Interface

The monitor interface includes one bus port and one RS485 port.

2.1.3 Power Supply Module

The power supply module is described below.

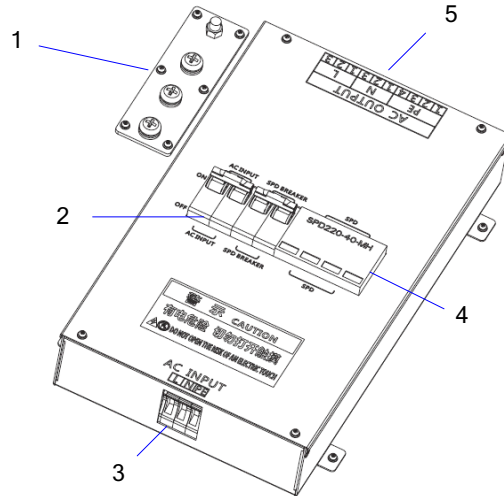

1 Ground Row 2 Circuit Breaker 3 AC Input Terminal
4 Surge Protection Device 5 AC Output Terminal

Figure 2-4 Components of Power Supply Module

2.2 Cartridge

In accordance with the IEC60297 standard, the cartridge is 19 inches in width and 7U in height. Each cartridge can accommodate four CHUs, two BSCUs and two PSUs. See [Figure 2-5](#).

C H U	C H U	C H U	C H U	B S C U	B S C U	P S U	P S U
01	02	03	04	05	06	07	08

Figure 2-5 Full Configuration for Main Chassis

2.3 Channel Unit

The CHU logically includes power amplification, TX excitation unit, baseband signal processing unit and diversity receiver. See [Figure 2-6](#).

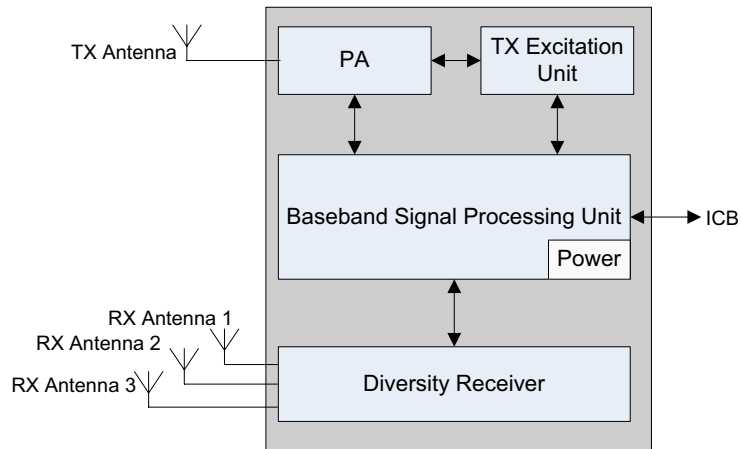

Figure 2-6 Logical Architecture of Channel Unit

2.3.1 Function

The CHU processes and converts protocols for the physical layer and data link layer of the PDT air interface. Physically it consists of channel board, TX board and RX board.

- CHB: be capable of signal processing, channel encoding/decoding, interleaver and de-interleaver, modulation/demodulation, RF signal loop-back test and fail-soft.
- TXB: be capable of modulating, upward frequency conversion, filtering and D/A conversion from carrier baseband RX signal to RF signal, as well as amplifying the downlink signal.
- RXB: be capable of filtering, demodulating, downward frequency conversion, AGC and A/D conversion from three-path carrier signal to baseband signal, as well as amplifying the uplink signal.

2.3.2 Front Panel

The front panel of CHU is described as follows.

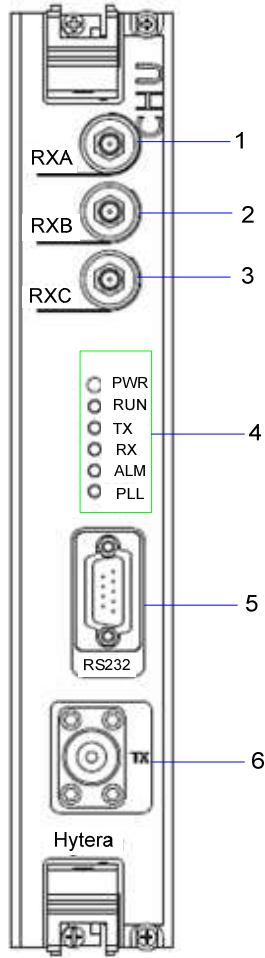

Figure 2-7 Front Panel of CHU

No.	Name	Description
1	RXA	Diversity RX antenna input.
2	RXB	RX antenna input.
3	RXC	Diversity RX antenna input.
4	LED panel	LED indicator
5	RS232	For commissioning.
6	TX	For transmitting.

Table 2-1 Descriptions on CHU Front Panel

2.3.3 LED Indicator

The CHU indicators are described in [Table 2-2](#).

Name	Color	Status	Description
PWR	Green	On	Power supply is in good working condition.
		Off	Power is failure.
RUN	Green	On	CHU is communicating with BSCU normally.
		Flashing	CHU is starting.
		Off	CHU is repeating.
TX	Green	On	CHU is allocating channel.
		Off	The TX channel is free.
RX	Green	On	Carrier signal is present.
		Off	The RX channel is free.
ALM	Red	On	The CHU is failure.
		Off	The CHU works properly.
PLL	Red	On	An alarm is issued due to PLL unlock.
		Off	The PLL works properly.

Table 2-2 Descriptions on CHU Indicators

2.4 Base Station Controller Unit (BSCU)

The BSCU logically consists of clock board, main control board, clock buffer, Ethernet switch, micro processor unit and power supply. See [Figure 2-8](#).

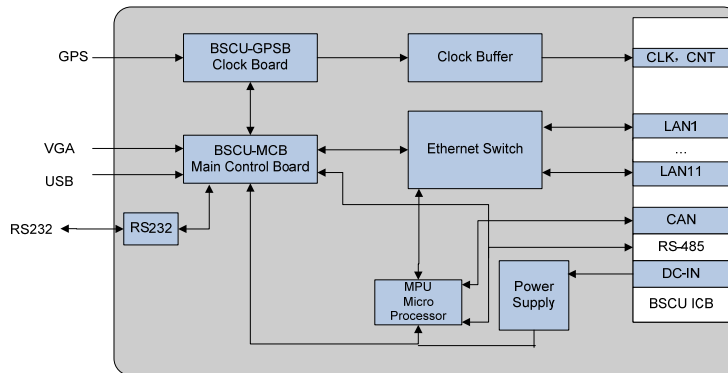

Figure 2-8 Logic Architecture of BSCU

2.4.1 Function

The BSCU is mainly in charge of managing the wireless link resources within the coverage, so as to allocate them to different calls.

2.4.2 Front Panel

The front panel of BSCU is illustrated as follows.

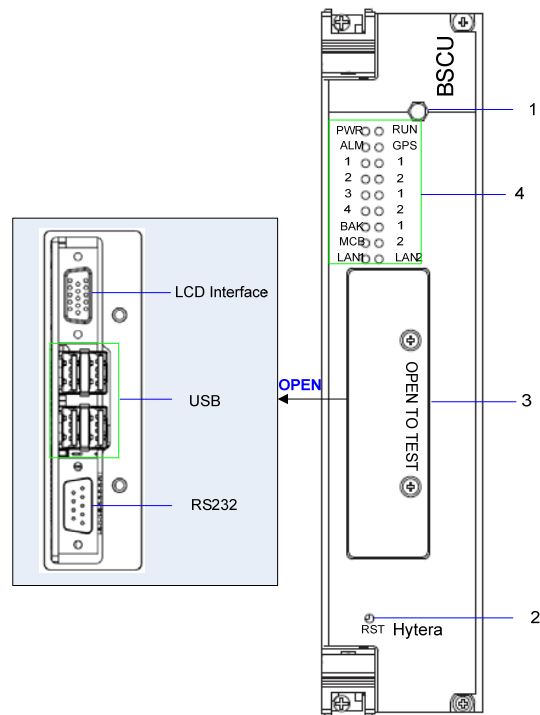

Figure 2-9 Front Panel of BSCU

No.	Name	Qty.	Description
1	SMA Interface	1	GPS signal input.
2	RST Key	1	BSCU reset.
3	Commissioning Interface	1	Video graphics array.
		4	USB.
		1	RS232.
4	LED Panel	1	LED Indicator

Table 2-3 Descriptions on BSCU Front Panel

2.4.3 LED Indicator

The BSCU indicators are described in [Table 2-4](#).

Name	Color	Status	Description
PWR	Green	On	Power supply is in good working condition.
		Off	Power is failure.
RUN	Green	Flashing rapidly	The BSCU operates in master mode.
		Flashing slowly	BSCU operates in slave mode.
		On	The BSCU is starting.
		Off	The BSCU does not work properly.
GPS	Green	Flashing	Functions are disabled locally.
		On	Functions are disabled via GPS.
		Off	Functions are enabled via GPS.
ALM	Red	On	The BSCU is alarming.
		Off	The BSCU works properly.
CHU1-4	Green	On	The BSCU links with the CHU properly.
		Flashing	Data is being transferred or received between BSCU and CHU.
		Off	The link is abnormal or not connected between BSCU and CHU.
IRU1-3	Green	On	The BSCU links with the IRU properly.
		Flashing	Data is being transferred or received between BSCU and IRU.
		Off	The link is abnormal or not connected between BSCU and CHU.

Name	Color	Status	Description
BAK	Green	On	The active BSCU links with the standby BSCU properly.
		Flashing	Data is being transferred or received between the standby BSCU and active BSCU.
		Off	The link is abnormal or not connected between the standby BSCU and active BSCU.
MCB	Green	On	The BSCU links with the MCB properly.
		Flashing	Data is being transferred or received between BSCU and MCB.
		Off	The link is abnormal or not connected between BSCU and MCB.
LAN1-2	Green	On	The BSCU links with the LNA properly.
		Flashing	Data is being transferred or received between BSCU and LAN.
		Off	The link is abnormal or not connected between BSCU and LAN.

Table 2-4 Descriptions on BSCU Indicators

2.4.4 Power Support Unit (PSU)

The PSU consists of power monitoring board, power module and LED panel.

2.4.5 Function

All functions of PSU are described in [Table 2-5](#).

No.	Item	Description
1	External power supply input	90~264V AC 47~63Hz
2	Voltage output (for main device)	13.5V DC
3	Voltage output (for CHU PA)	HVCC (13.5V DC)

No.	Item	Description
4	Voltage output (for other power supply from the CHU)	LVCC (13.5V DC)
5	Voltage output (for BSCU)	BSC_V (13.2V DC)
6	I/O interface	It is connected to 2 BSCUs and outputs three channel signals. The first two is used for resetting PSU, and the last for installation status of PSU.
7	Monitor Interface	It is connected to 2 BSCUs respectively, and outputs two signals including RS485 and CAN-BUS.

Table 2-5 Descriptions on PSU

2.4.6 Front Panel

The front panel of PSU is illustrated as follows.

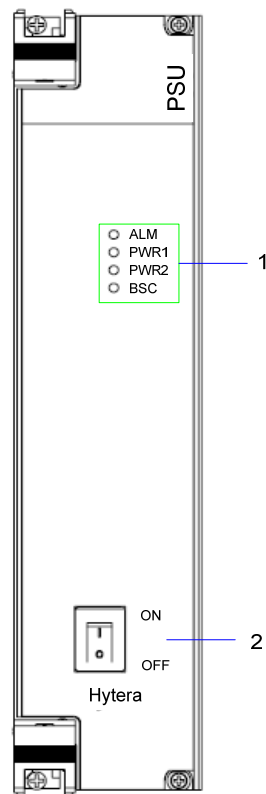

Figure 2-10 Front Panel of PSU

No.	Name	Qty.	Description
1	LED Panel	1	LED indicator
2	ON/ OFF Switch	1	Power Switch

Table 2-6 Descriptions on PSU Front Panel

2.4.7 LED Indicator

The PSU indicators are described in [Table 2-7](#).

Name	Color	Status	Description
ALM	Red	On	Major alarm.
		Blinking per second	Minor alarm.
		Off	The PSU works properly.
PWR1	Green	On	Path 1 outputs normally.
		Flashing	Path 1 outputs HVCC or LVCC alarm.
		Off	No voltage is available in Path 1.
PWR2	Green	On	Path 2 outputs normally.
		Flashing	Path 2 outputs HVCC or LVCC alarm.
		Off	No voltage is available in Path 2.
BSC	Green	On	The output voltage for BSC is normal.
		Blinking per second	An alarm is issued due to over-voltage or low voltage for BSC.
		Off	The voltage for BSC is failure.

Table 2-7 Descriptions on PSU Indicators



Note:

The power module has two-path outputs including VCC and LVCC.

2.4.8 Interconnect Backboard (ICB)

The ICB is utilized to achieve power interconnection, synchronization clock interconnection, signaling,

voice and data interconnection, monitor interconnection, and I/O interconnection.

2.4.9 Front Side

The front side of ICB is described below.

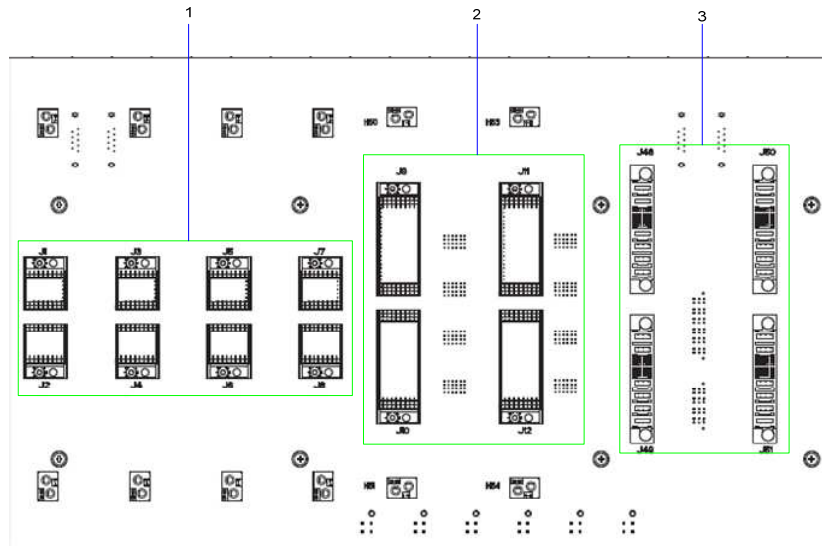

Figure 2-11 ICB (front side)

No.	Name	Qty.	Description
1	CHU Interface	4	For signal from CHU to ICB.
2	BSCU Interface	2	For signal from BSCU to ICB.
3	PSU Interface	2	For signal from PSU to ICB.

Table 2-8 Description on ICB (front side)

2.4.10 Back Side

The back side of ICB is described below.

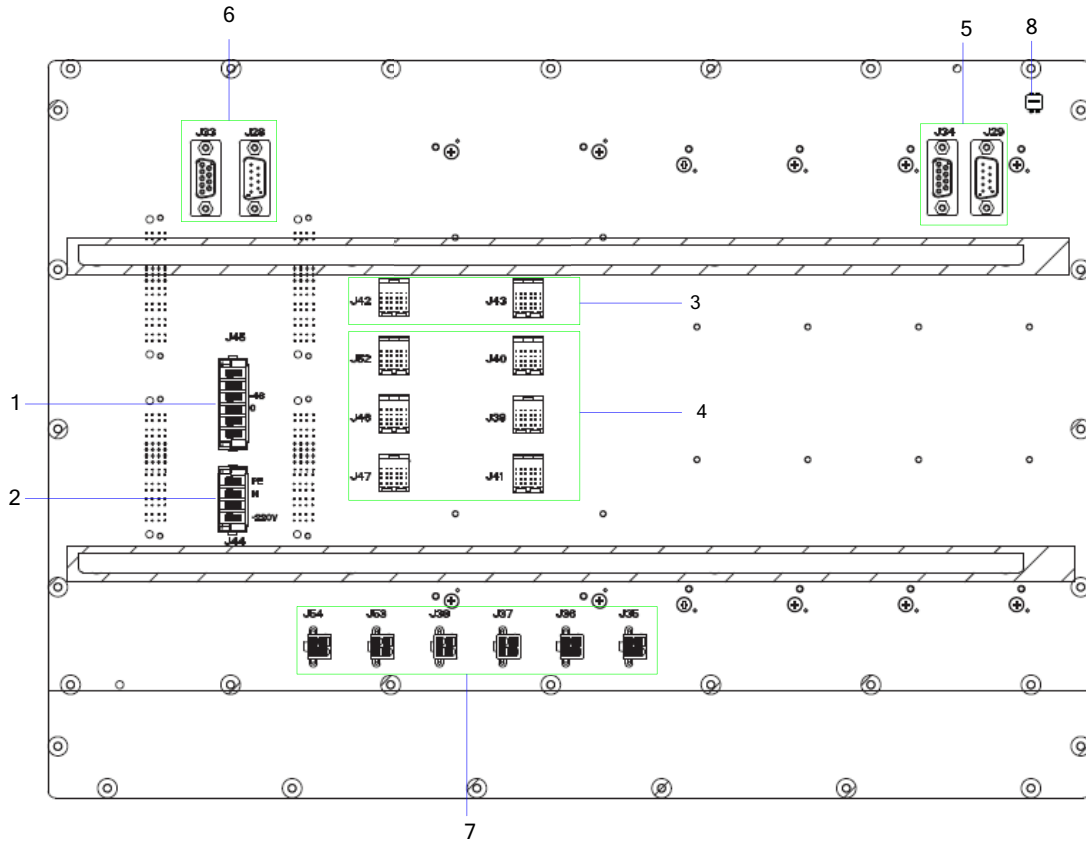

Figure 2-12 ICB (back side)

No.	Name	Qty.	Description
1	DC Power Inlet	1	DC power input: -48V(NA now)
2	AC Power Inlet	1	AC power input: 110V/220V
3	EC Interface	2	For interconnecting two cartridges in the cabinet.
4	EIB Interface	6	For interconnecting two EC cartridges and four IRUs between two cabinets, and also working as the signal interface from EIB to ICB in the core network interface board.
5	Monitor Interconnection Interface	2	For RS485 bus.
6	Monitor Interconnection Interface	2	For CAN-BUS.

No.	Name	Qty.	Description
7	Power Outlet	6	DC power (+13.2V) for BSCU, FAN and DIU.
8	DIP Switch	1	For setting the cartridge address.

Table 2-9 Description on ICB Interfaces (Back Side)

The settings of DIP switch are described in [Table 2-10](#).

No.	4	3	2	1	Description	Remark
1	X	ON	X	ON	Address for main chassis.	X: reserved.
2	X	ON	X	OFF	Address for the first extended chassis.	
3	X	OFF	X	ON	Address for the second extended chassis.	
4	X	OFF	X	OFF	Address for the third extended chassis.	

Table 2-10 Description on ICB DIP Switch

2.5 Fan Unit (FAN)

The FAN consists of a fan cartridge and two independent plugged sub-rack modules. The fan monitor board is located on the back side of fan cartridge. It can accommodate two independent fan sub-racks modules, each of which has three fans, four LEDs and two temperature sensors.

2.5.1 Front Panel

The front panel is illustrated in [Figure 2-13](#).

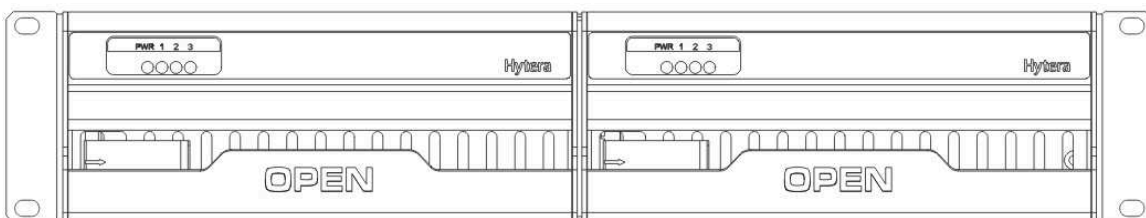

Figure 2-13 Front Panel of FAN

2.5.2 LED Indicator

The FAN indicators are described in [Table 2-11](#).

Name	Color	Status	Description
PWR	Red	On	Power supply is in good working condition.
		Off	Power is failure.
1	Green	On	FAN1 works properly.
		Off	FAN1 is out of operation or not installed.
		Blinking per second	FAN1 does not work properly.
2	Green	On	FAN2 works properly.
		Off	FAN2 is out of operation or not installed.
		Blinking per second	FAN2 does not work properly.
3	Green	On	FAN3 works properly.
		Off	FAN3 is out of operation or not installed.
		Blinking per second	FAN3 does not work properly.

Table 2-11 Descriptions on FAN Indicators

2.5.3 Rear Panel

The rear panel of FAN is described below.

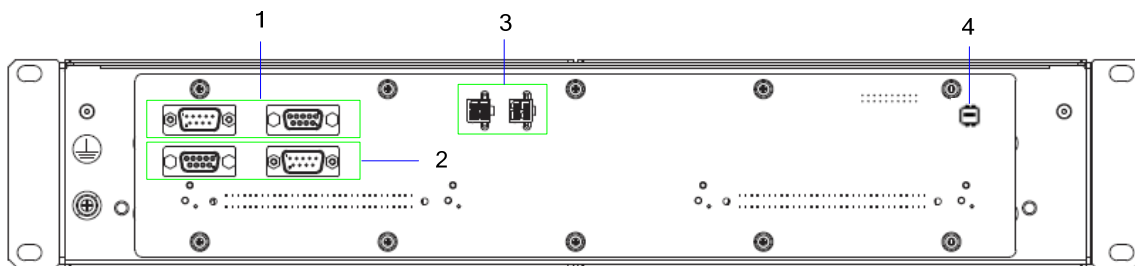

Figure 2-14 Rear Panel of FAN

No.	Name	Qty.	Description
1	RS485 Monitor Interface	2	For connecting ICB and DIU.
2	CAN-BUS Monitor Interface	2	
3	Power Inlet	2	For connecting ICB.
4	DIP Switch	1	For setting the fan address.

Table 2-12 Descriptions on FAN Front Panel

The settings of DIP switch are described in [Table 2-13](#).

No.	4	3	2	1	Description	Note
1	ON	ON	X	X	The first FAN address	X: reserved.
2	ON	OFF	X	X	The second FAN address	
3	OFF	ON	X	X	The third FAN address	
4	OFF	OFF	X	X	The fourth FAN address	

Table 2-13 Descriptions on FAN DIP Switch Settings

2.6 Divider Unit (DIU)

The logic diagram of DIU is described in [Figure 2-15](#).

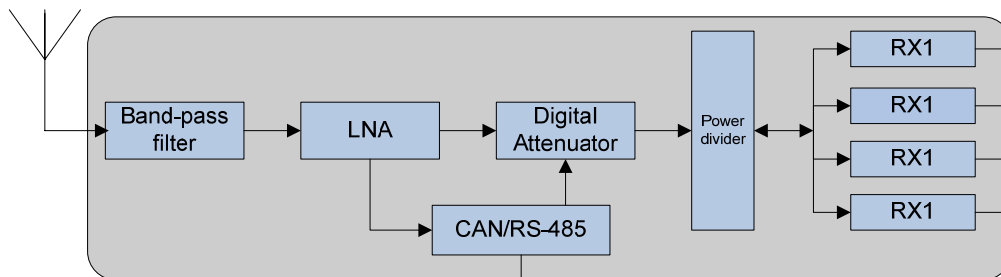

Figure 2-15 Diagram of DIU

2.6.1 Function

The DIU is in charge of allocating the received signal to each transceiver.

2.6.2 Front Panel

The front panel of DIU is illustrated as follows.

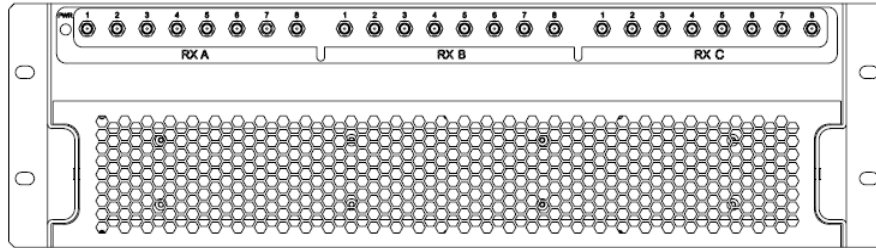

Figure 2-16 Front Panel of DIU

No.	Name	Qty.	Description
1	RXA	8	Diversity RX antenna output.
2	RXB	8	RX antenna output.
3	RXC	8	Diversity RX antenna output.

Table 2-14 Descriptions on DIU Front Panel

2.6.3 Rear Panel

The rear panel of DIU is described below.

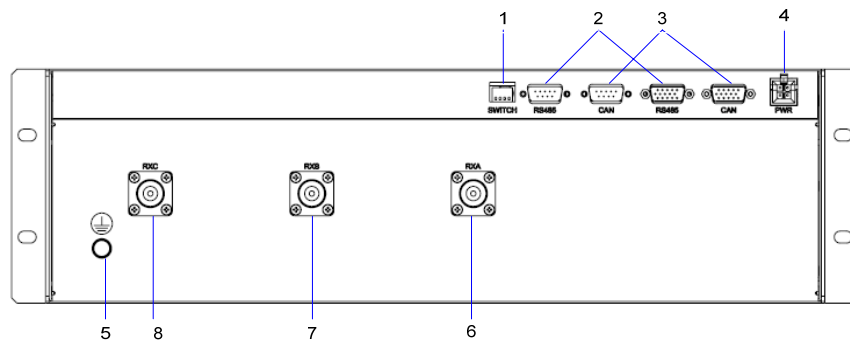

Figure 2-17 Rear Panel of DIU

No.	Name	Qty.	Description
1	SWITCH	1	For setting the DIU address
2	RS485	2	Monitor Interface
3	CAN-BUS	2	Monitor Interface

No.	Name	Qty.	Description
4	PWR	1	Power Inlet
5		1	For grounding
6	RXA	1	Diversity RX antenna A
7	RXB	1	Diversity RX antenna B
8	RXC	1	Diversity RX antenna C

Table 2-15 Descriptions on DIU Rear Panel

The setting of DIU address is specified in [Table 2-16](#).

No.	1	2	3	4	Description	Note
1	ON	ON	X	X	The first DIU address	X: reserved.
2	ON	OFF	X	X	The second DIU address	
3	OFF	ON	X	X	The third DIU address	
4	OFF	OFF	X	X	The fourth DIU address	

Table 2-16 Description on DIU Address Setting

2.7 Router

2.7.1 Function

The router is used for selecting the routing device for message flow or data grouping.

2.7.2 Front Panel

The front panel of router is described in [Figure 2-18](#).

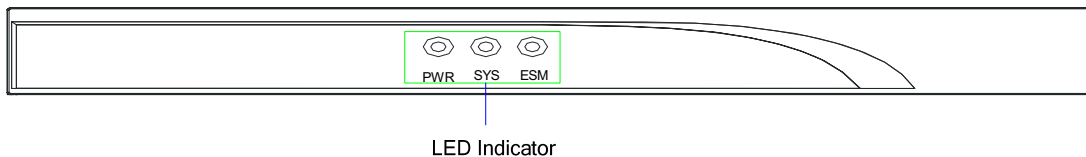

Figure 2-18 Front Panel of Router

2.7.3 Rear Panel

The rear panel of router is described as follows.

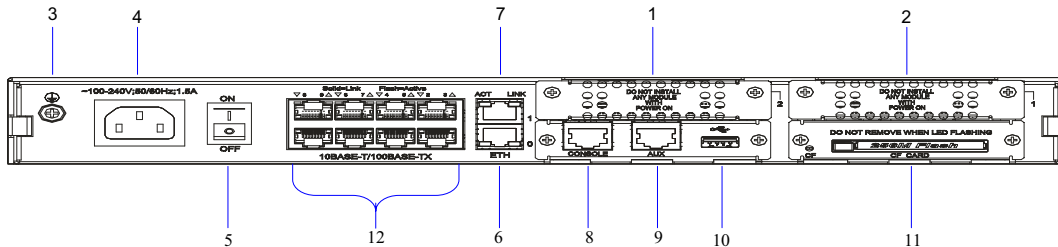

Figure 2-19 Rear Panel of Router

No.	Name	No.	Name
1	SIC Slot 2	2	SIC Slot 1
3	Ground Port	4	Power Inlet
5	Power Switch	6	Ethernet Port (LAN0)
7	Ethernet Port (LAN1)	8	Configuration Port (CON)
9	Auxiliary Port (AUX)	10	USB Port
11	CF Card	12	L2 Switch Port (LAN2-LAN9)

Table 2-17 Descriptions on Router Rear Panel

2.7.4 LED Indicator

The router indicators are described in [Table 2-18](#).

Name	Color	Status	Description
Front Panel	PWR	On	Power supply is in good working condition.
		Off	Power is failure.
	Green	Flashing rapidly	The system is starting.
		Flashing slowly	The system works properly.
Yellow	Flashing rapidly	The system is failure.	

Name		Color	Status	Description
	ESM	-	Off	The system does not work properly.
		Green	On	The ESM card works properly.
			Flash Slowly	The router is starting.
		Yellow	On	The ESM card is failure.
		-	Off	The ESM card is not inserted.
Rear Panel	LINK	-	On	The link is not connected.
			Off	The link has been connected.
	ACT	-	Flashing	Data is being transferred or received.
			Off	No data is being transferred or received.
	CF	Green	On	The CF card has been inserted.
			Flashing	The CF card is reading or writing.
		Yellow	On	The CF card is failure.
		-	Off	The CF card is not inserted or identified.

Table 2-18 Descriptions on Router Indicators

2.8 Combiner (COM)

The COM is classified into broadband hybrid combiner, manual tune cavity combiner, and auto tune cavity combiner. The broadband hybrid combiner is applied to the base station with two-carrier, while the manual tune cavity combiner to the base station with more than two-carrier. The logic diagram of four combiners is shown in [Figure 2-20](#).

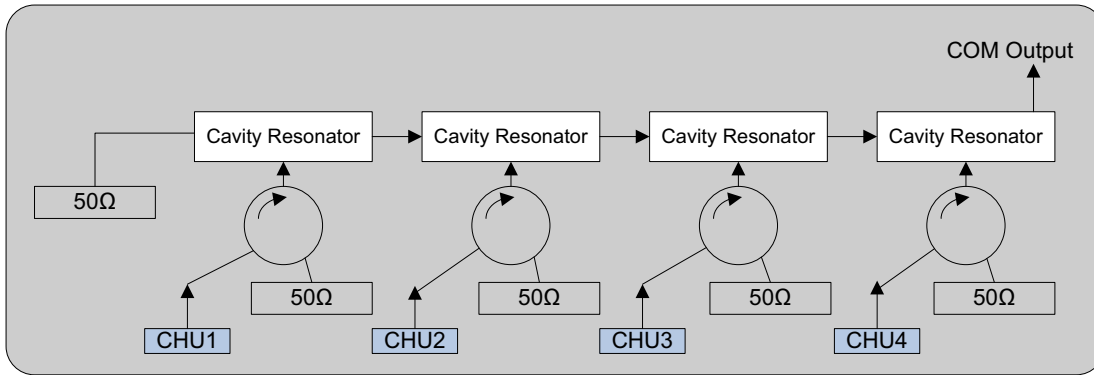

Figure 2-20 Logic Diagram of Four Combiners

2.8.1 Function

The COM is used to integrate multiple carriers from the base station sub-system into one output port to transmit by an antenna.

2.8.2 Rear Panel

The rear panel of combiner is described below.

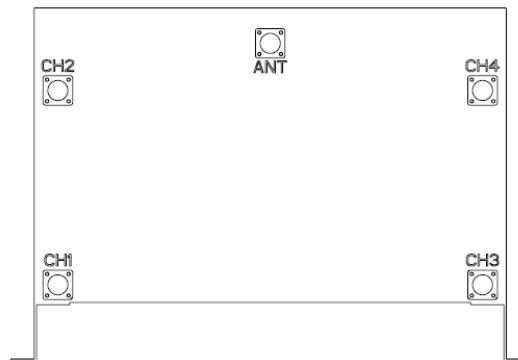

Figure 2-21 Rear Panel of Combiner

No.	Name	Description
1	ANT	For combing output
2	CH1	For carrier input 1
3	CH2	For carrier input 2
4	CH3	For carrier input 3
5	CH4	For carrier input 4

Table 2-19 Descriptions on COM Front Panel

3. Installation

3.1 Cable Layout

The cable layout of base station is shown [Figure 3-1](#).

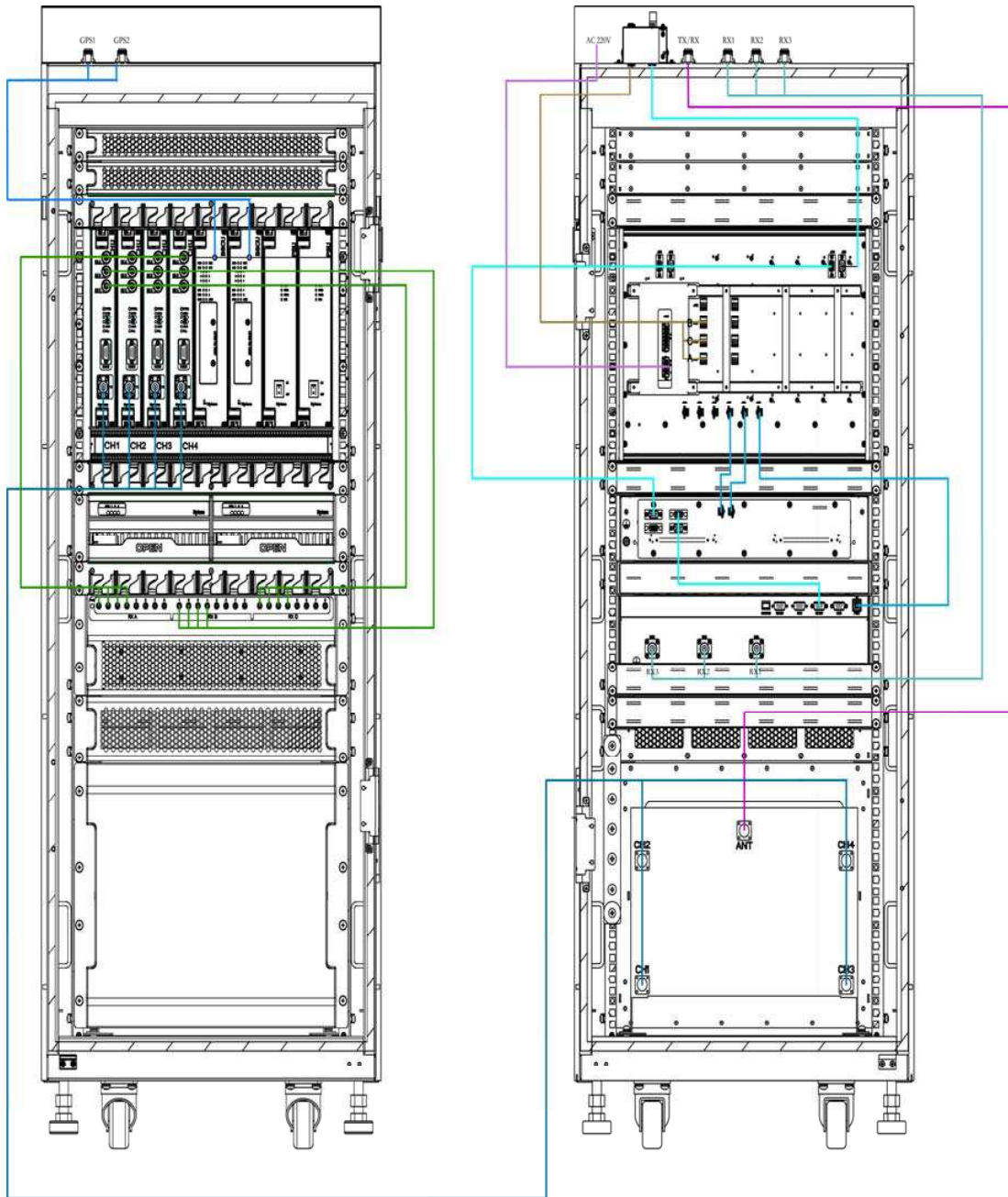

Figure 3-1 Cable Layout

3.2 Safety Information

To reduce the chance of accident, please read the safety precautions very carefully before installation, maintenance and operations.

3.2.1 Power Supply

Danger:

Some components of the power system carry hazardous voltage in operation. Direct contact or indirect contact through moist objects with these components will result in fatal injury.

- Never wear conductive objects such as watches, bracelets, rings and etc during operation.
- Do use special tools in high voltage and AC operation.
- Do keep moisture out of the power system during operation in moist environment.
- The equipment should be well earthed in time to avoid damage by lightning strikes in thunderstorm.
- Do turn off the power before assembly or disassembly
- Do verify the compliance of the cable and cable label prior to connection.
- Ensure that the equipment is well earthed before powering on.
- Turn off the power immediately when water or moisture is found on the cabinet,
- Make sure all switches of power distribution box are set to off before installation each module in the cabinet

3.2.2 Working at Heights

Warning:

Cautions shall be taken to prevent objects from falling during working at heights.

- Safety protection measures (e.g. wearing a hamlet or the safety belt) shall be taken.
- The heat-retaining clothes shall be worn before operation in cold areas.
- Make sure that the ladder is safe for use. Overweight on the ladder is strictly prohibited.
- Protective measures shall be taken if the slant of the ladder is more than 5m or the ladder is placed on a high ground (>3m)
- Handle and use all equipment and tools with care to avoid falling.

3.3 Installation Preparation

3.3.1 Technical Files

The following table lists the files associated with hardware installation.

File type	File Name	Description
Instructional file for installation	Network Planning Drawing	Provided by the R&D engineers or technical sales.
	Site Survey Report	It is filled by the investigation engineer on site.
Manuals	DS-6210 PDT Trunking System	Shipped with the equipment
	DS-6210 PDT Trunking Base Station Hardware Description Manual	
	DS-6210 PDT Trunking Base Station Service Manual	
Other files	Packing List	Shipped with the equipment

Table 3-1 Technical Files

3.3.2 Personnel

Only the adequately trained personnel with satisfactory knowledge of the system can carry out the installation and tuning. The number of installation persons is subject to engineering progress and environment.

3.3.3 Tools

The following tools and meter are required before installation.

General Tools	Claw hammer, slot type screwdriver, large Phillips screwdriver, wrench, paper knife, connector board and A type ladder.
Special Tools	ESD-preventive wrist strap, cable peeler and crimping pliers.
Meter	Multimeter

Table 3-2 Tools and Meter

3.4 Unpacking Inspection

3.4.1 Check before Unpacking

After the equipment arrives at the installation site, you should:

- Check against the packing list, including total amount, customer address, and etc.
- Contact us in case of any mistake.
- Check the packaging case is in good condition and not placed upside down.

If the outer package is damaged seriously or soaked, please contact us immediately.



Note:

To protect the equipment and investigate the cause, please properly keep the package box, equipment and packing materials, and take photo.

If the above check results are good, unpack and check the equipment.

3.4.2 Unpacking Wooden Case



Caution:

- Keep the wooden case far away from intense shock during transportation.
- Never touch the parts with dirty glove during transportation.

Tools	Claw hammer and slot type screwdriver
-------	---------------------------------------

If space permitting, carry the wooden case into or near the computer room before unpacking. This can prevent the chassis from being damaged.

To unpack the wooden case, do as follows:

Step 1 Wear the ESD-preventive glove.

Step 2 Lay the wooden case horizontally on the ground. Do keep the side with frame down.

Insert one end of the slot type screwdriver into the seam between the cover and the case body by the claw hammer; then remove all nails, as shown in [Figure 3-2](#).



Figure 3-2 Removing the Cover

Step 3 Remove the cover. The wooden case may contain the carton or cabinet. As for the former, directly take out the carton from the wooden case and unpack as instructed in [Step 6](#). As for the latter, proceed to the next steps.

⚠Caution:

Pay attention to the nails on the cover, to avoid hand injuries.

Step 4 Place the wooden case in an upright position. Do keep the side of the cabinet with wheel down



Figure 3-3 Erecting the Wooden Case

Step 5 Remove the foam plate.

Step 6 Slide the cabinet out of the wooden case slowly.

3.4.3 Unpacking Cartons

Tool	Paper knife
-------------	-------------

To open a carton, do as follows:

Step 1 Check the type and quantity of articles inside the carton according to labels, and cut the straps along the seam of the carton cover by the paper knife.

 **Caution:**

Use moderate force to avoid damaging the articles inside.

Step 2 Remove the foam plates and articles.

3.4.4 Inspections

After unpacking all wooden cases and cartons, carefully check the name, type, quantity of goods against the Packing List, and then accept them.

3.5 Installing the Cabinet

3.5.1 Determine the Installation Position

Determine the installation position of the cabinet according to the installation chart. The available space for maintenance should be preserved and be no less than 600mm around the front and back door, as shown in [Figure 3-4](#) and [Figure 3-5](#).

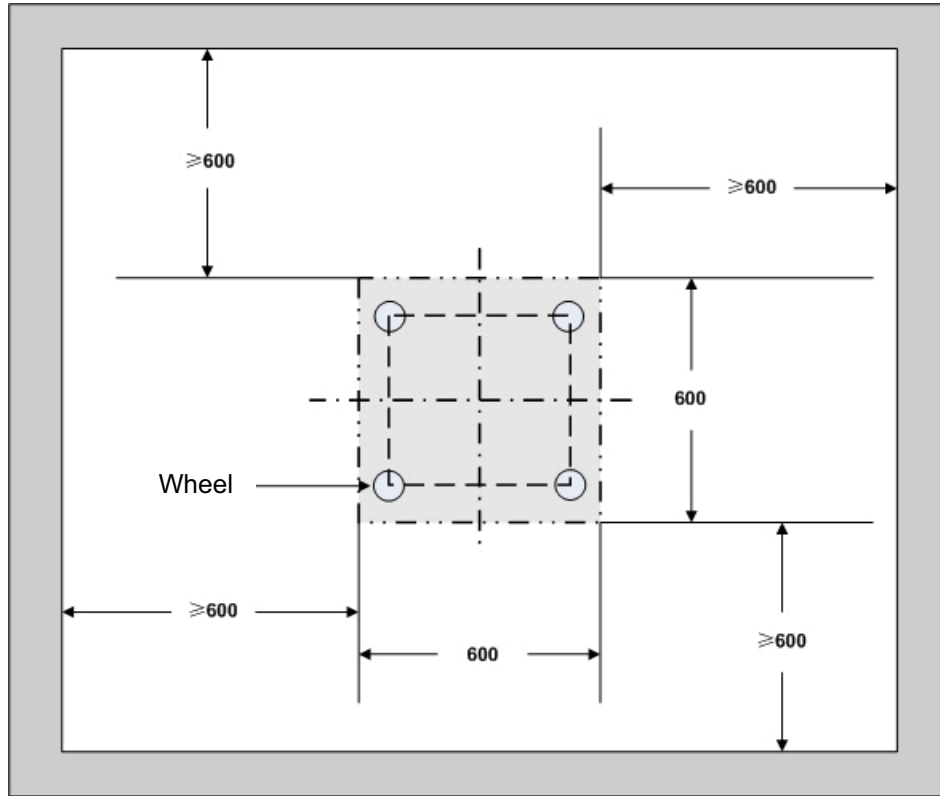

Figure 3-4 Layout of holes for a Single Cabinet

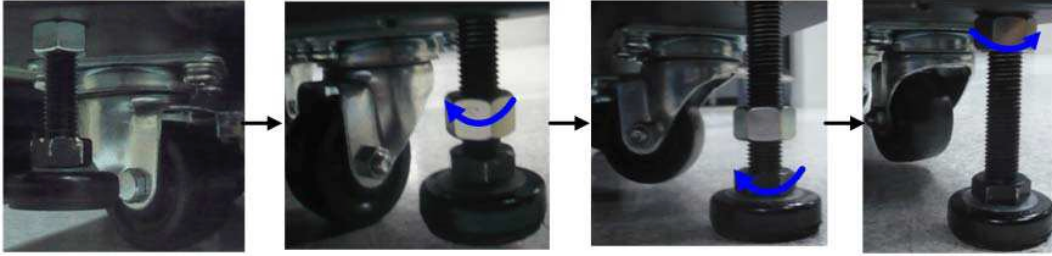

Figure 3-6 Tightening the Bolt

3.6 Installing Modules into the Cabinet

3.6.1 Module Layout

The position of all modules to be installed is shown in [Figure 3-7](#).

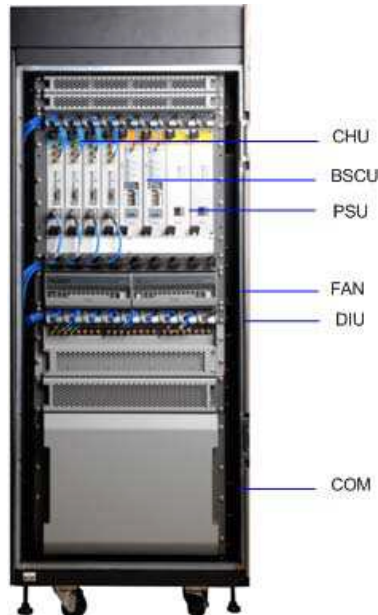

Figure 3-7 of Module Layout

3.6.2 Installation Procedures

Step 1 Open the front and back door, as shown in [Figure 3-8](#).

1. Unlock and remove the key in case of the keyhole in a vertical position.
2. Firmly press **PUSH** until the door knob is bounced.
3. Turn the door knob to the right.
4. Pull the door knob outwards and open the cabinet door.

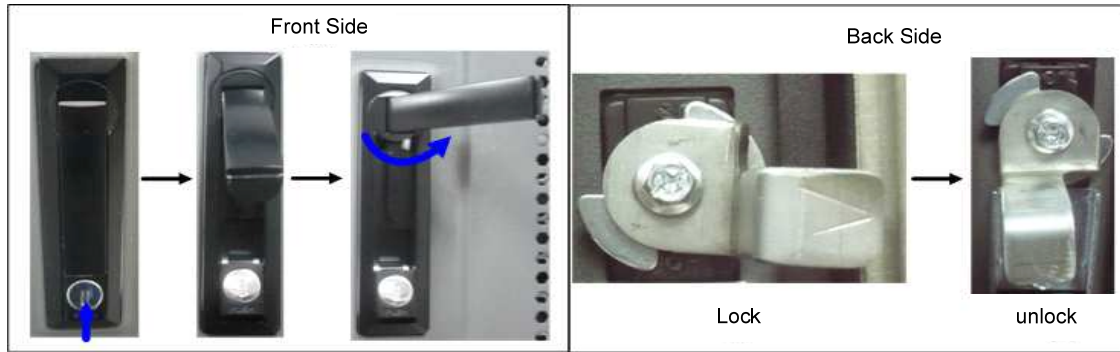

Figure 3-8 Opening the Cabinet Door

Step 2 Disassemble the side doors as shown in [Figure 3-9](#).

1. Remove the eight screws on the frame.
2. Press down on the two latches and pull out the side door outwards.

⚠ Caution:

Care shall be taken to avoid injuries upon pulling out the side door outwards.

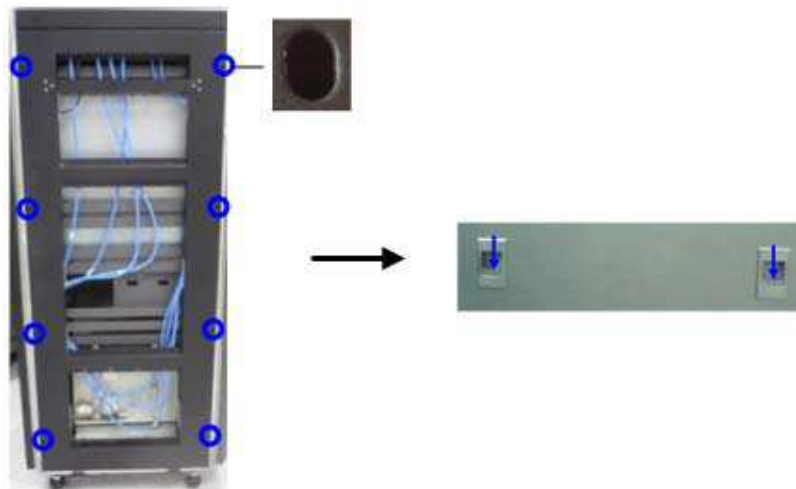

Figure 3-9 Disassembling the Side Door

Step 3 Insert the modules into the cartridge (take the BSCU installation for example)

📝 Note:

Make sure the power switch is set to OFF before installing the PSU.

1. Loosen the two ejectors as shown in [Figure 3-10](#).

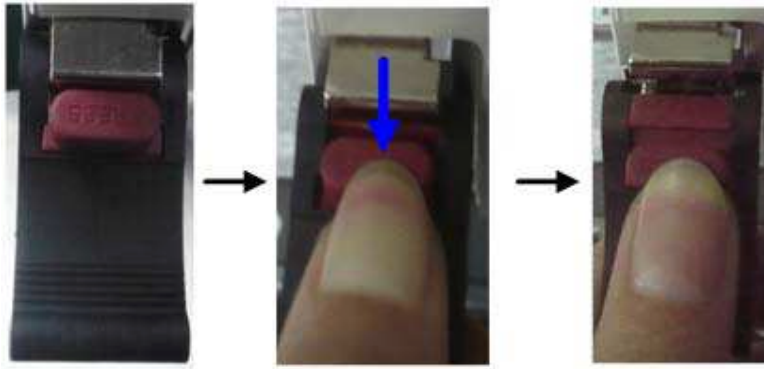

Figure 3-10 Loosening the Ejector

2. Slide the BSCU along the guide rails smoothly as shown in [Figure 3-11 \(1\)](#) .
3. Perform the step 1 in a reverse way to lock the two ejectors.
4. Tighten the two screws on the two ejectors and the board respectively as shown in [Figure 3-11 \(2\)](#) .

 **Note:**

Loosen the two ejectors and draw out the module in case of removing it during installation.

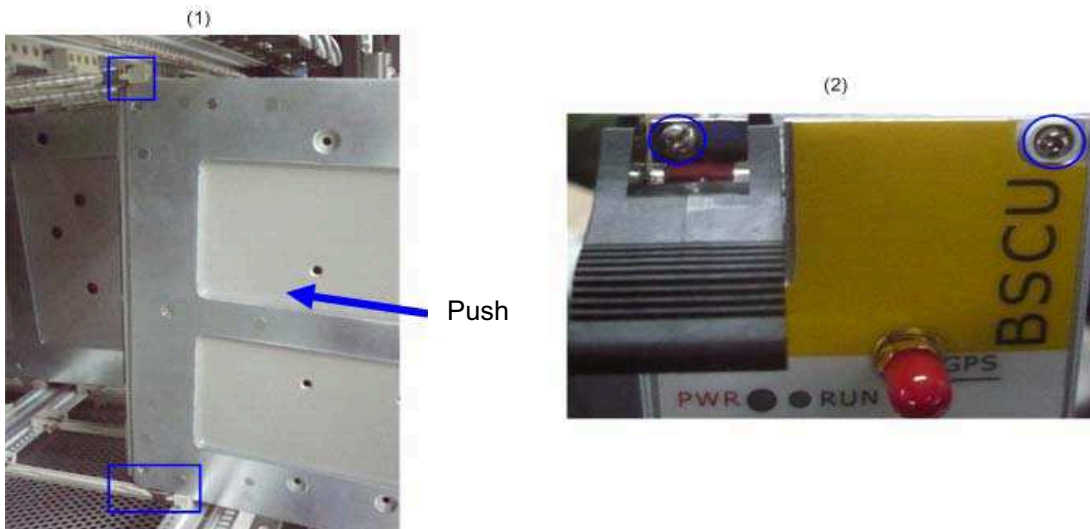

Figure 3-11 Installing the BSCU

Step 4 Install the FAN as shown in [Figure 3-12](#).

Slide the FAN along the guide rails smoothly until a click is heard.



Figure 3-12 Installing the FAN

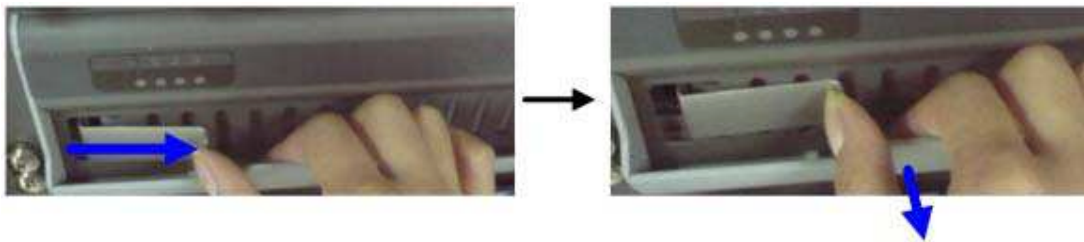

Figure 3-13 Removing the FAN

 **Note:**

Pull the latch inwards and pull out the FAN in case of removing it during installation. See [Figure 3-13](#).

Step 5 Install the DIU as shown in [Figure 3-14](#).

1. Slide the DIU along the guide rails.
2. Fasten all screws to fix the DIU.

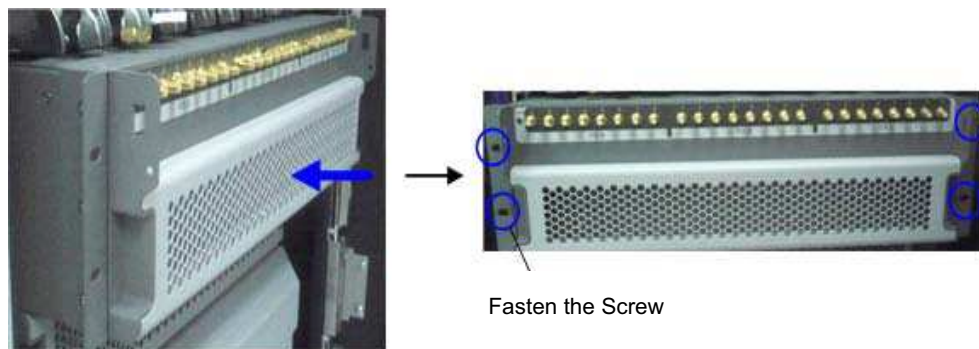

Figure 3-14 Installing the Divider Unit

Step 6 Install the COM as shown in [Figure 3-15](#).

1. Slide the COM along the guide rails.
2. Fasten the four screws.

⚠ Caution:

Handle with care as the COM is heavy.

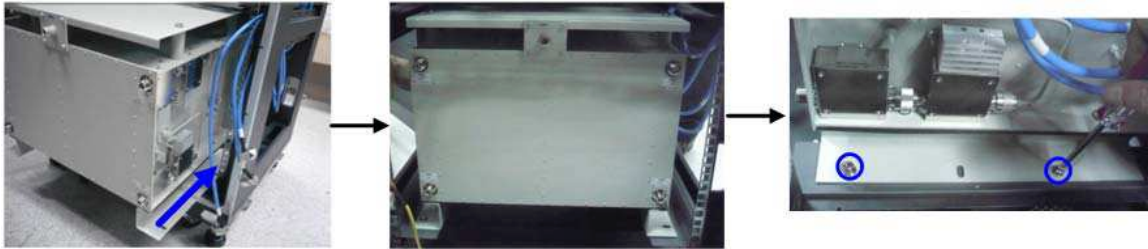

Figure 3-15 Installing the Combiner Unit

Step 7 Connect all cables as shown in [Figure 3-16](#).

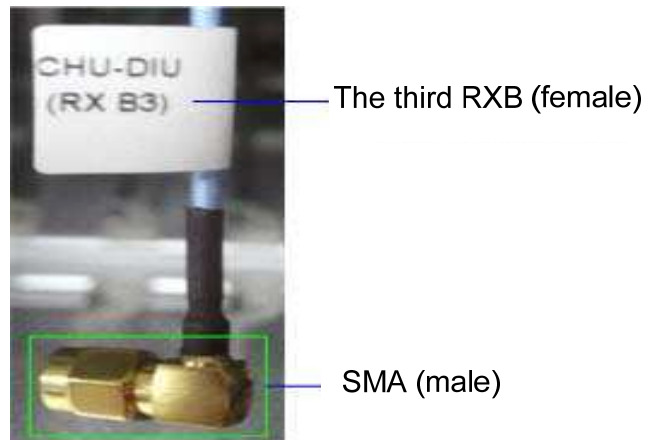

Figure 3-16 Cable Diagram

Step 8 Install the side doors.

1. Align the side door with the frame and firmly press the latch.
2. Fasten the eight screws.

3.7 Installing Cables

3.7.1 Equipment Status

The equipment shall be in the following status before connecting cables:

- The cabinet has been installed.
- All modules have been installed and the power switch is set to OFF.

3.7.2 Cables

Cables are described in [Table 3-3](#) and their positions are shown in [Figure 3-17](#). Installation positions are located on top of the cabinet.

Name	Color	Remark
Base Station Ground Cable (40m)	Yellowish green	16 mm ² , 49-core, and 450/750V Subject to the actual needs.
AC Power Cord (15m)	Black	Subject to the actual needs
RF Jumpers (3 pcs)	Black	1/2 inch, N-Male to N-Male

Table 3-3 Cables Description

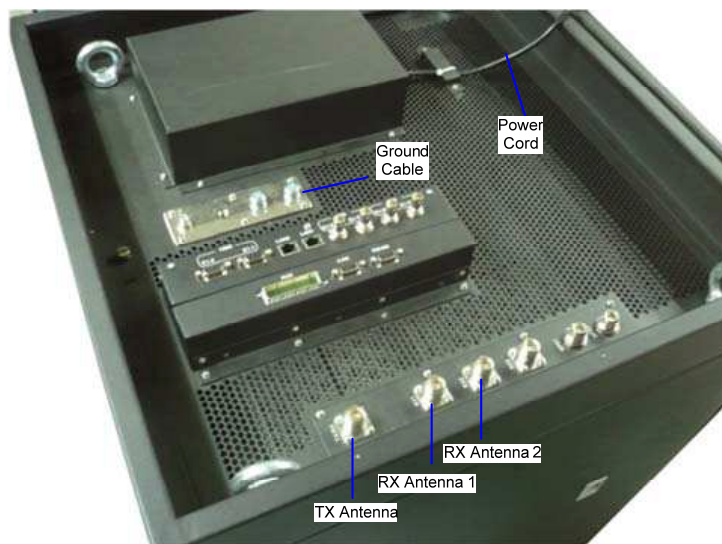

Figure 3-17 External Cable Connection

3.8 Examination after Installation

3.8.1 Equipment Status

The equipment shall be in the following status prior to hardware examination.

- The cabinet has been installed.

- All modules have been installed.
- The external power has been installed and all cables have been connected.
- All switches of the power distribution box are set to OFF.

3.8.2 Examining the Cabinet

The following requirements shall be met after installation.

No.	Check Item
1	The position of the cabinet should conform to the design drawing.
2	All modules should be installed correctly.
3	All cables within the cabinet should be connected properly.
4	The side door should be installed and the grounding cables should be connected properly.
5	All screws should be tightened. Be sure to put flat washers and spring washers on all bolts correctly.
6	The cabinet should be placed horizontally and orderly.
7	The surface of the cabinet should be clean and well painted. No dust and other sundries are in the cabinet.
8	All labels should be correct, clear and not be missed.
9	The plastic dust cap on top of the cabinet should be installed properly.

Table 3-4 Checklist of Cabinet Installation

3.8.3 Examining Cables

The following requirements should be met after connection.

No.	Check Item
1	All cables should not be damaged.
2	All cables are one-piece cables, without any joint in the middle.
3	Excess grounding cables should be cut off.

Table 3-5 Checklist of Cables

3.8.4 Power On and Examination

Caution:

First measure the resistance of all power connectors and ground connectors using the multimeter and check whether short circuit occurs.

The procedures are described as follows:

Step 1 Check the input voltage (220V) from the main power and whether the live line and null line connect correctly.

Step 2 All switches of PSU are set to ON.

Step 3 Check whether all modules are powered properly.

Name	Normal Power Indication
CHU	The PWR indicator on the front panel glows and the ALM indicator goes out.
BSCU	The PWR indicator on the front panel glows and the ALM indicator goes out.
PSU	The PWR indicator on the front panel glows and the ALM indicator goes out.
FAN	The PWR indicator on the front panel glows.

Table 3-6 Checklist of Power Situation

Note:

If the LED on the front panel does not work correctly, please re-power it on or re-insert the module after disconnecting power. If it doesn't solve the problem, please contact us.

3.8.5 Environment Examination

The following table lists the check item of environment on site.

No.	Check Item
1	The equipment room should be clean and tidy.
2	No sundries should be placed in the grooves, at the bottom of the cabinet or around the cabinet.
3	The floor in the equipment room should be free from sundries.

Table 3-7 Checklist of Environment on Site

4. Basic Operations

4.1 Powering on

All switches of the PSU are set to ON.

4.2 Powering off

All switches of the PSU are set to OFF.

5. Troubleshooting

Phenomena	Solution
The PWR LED does not light up.	Check the power supply.
The ALM LED on the PSU glows red.	Disconnect the power and replace the PSU.
The ALM LED on the CHU glows red.	Replace the CHU.
The ALM LED on the BSCU glows red.	Replace the BSCU.

Table 5-1 Troubleshooting

6. Routine Maintenance

6.1 Purpose

Routine maintenance is to ensure stable and reliable operation of the equipment. It can help to know the operation status of the equipment, so as to detect the potential troubles and remove them on time.

The routine maintenance should achieve the following objects:

- Remove all potential troubles to keep the system work properly.
- Ensure all performance and service specifications meet requirements.
- Ensure good collaboration with the entire network.
- Make sure that new equipment or the extended equipment accesses to the network properly.

6.2 Tasks

- Clean the equipment room regularly.
- Check the working status of the base station regularly. If the abnormal situation occurs, deal with it in time.
- Clean up the dust regularly.

A Abbreviations

Abbr.	Full Name
AGC	Auto Gain Control
BSCU	Base Station Controller Unit
BSCU-MB	Base Station Controller Unit Main Board
BSS	Base Station Sub-system
CAN	Controller Area Network
CC	Call Control
CCL	Call Control Layer
CHB	Channel Board
CHU	Channel Unit
COM	Combiner
CPCI	Compact Peripheral Component Interconnect
DIU	Divider Unit
DLL	Data Link Layer
EC	Extended Chassis
EIB	Extended Interface Board
ETSI	European Telecommunications Standards Institute
FAN	Fan Unit
GPI	General Purpose Input
GPIO	General Purpose Input Output
GPO	General Purpose Output
GPS	Global Positioning System
GPSB	GPS Clock Board

Abbr.	Full Name
ICB	Interconnect Backboard
IO	Input and Output
IRU	Interconnect Relay Unit
LLC	Logical Link Control
LNA	Low Noise Amplifier
MAC	Media Access Control
MC	Main Chassis
MCB	Main Control Board
MM	Mobile Management
MPSC	Machine-Frame Power Support Component
MPU	Micro Processor Unit
PAB	Power Amplifier Board
PCI	Peripheral Component Interconnect
PICMG	PCI Industrial Computer Manufacture's Group
PDT	Professional Digital Trunking
PSB	Package Switch Board
PSU	Power Support Unit
RFDS	Radio Frequency Distributing System
RT	Router
RXB	Receive Board
TDM	Time Division Multiplex
TMA	Tower Mounted Amplifier
TSCU	Trunking Station Control Unit
EXB	Excitation Board

Abbr.	Full Name
VGA	Video Graphics Array

FCC Warning:

Any Changes or modifications not expressly approved by the party responsible for compliance could void the user's authority to operate the equipment.

This device complies with part 15 of the FCC Rules. Operation is subject to the following two conditions: (1) This device may not cause harmful interference, and (2) this device must accept any interference received, including interference that may cause undesired operation.

This equipment complies with FCC radiation exposure limits set forth for an uncontrolled environment .This equipment should be installed and operated with minimum distance 2.7 m between the radiator& your body.