



**中认信通**  
CHINA CERTIFICATION ICT CO., LTD (DONGGUAN)



## SAR TEST REPORT

**Applicant: Hytera Communications Corporation Limited**

**Address:** Hytera Tower, Hi-Tech Industrial Park North, 9108# Beihuan Road,  
Nanshan District, Shenzhen, 518057 China

**FCC ID: YAMP516LF**

**Product Name: Digital Portable Radio**

**Model Number: BP516 LF**

**Multiple Numbers: BP512 LF, BP51X**

**Standard(s): 47 CFR Part 2(2.1093)**

The above equipment has been tested and found compliant with the requirement of the relative standards by China Certification ICT Co., Ltd (Dongguan)

**Report Number: CR22060025-20**

**Date Of Issue: 2022-07-11**

**Reviewed By: Sun Zhong** *Sun Zhong*

Title: Manager

**Test Laboratory:** China Certification ICT Co., Ltd (Dongguan)  
No. 113, Pingkang Road, Dalang Town, Dongguan,  
Guangdong, China  
Tel: +86-769-82016888

## SAR TEST RESULTS SUMMARY

Operation Frequency Bands	Highest Reported 1g SAR (W/kg)		Limits (W/kg)
	Head Face Up (Gap 25mm)	Body-Worn (Gap 0mm)	
PTT(462.5500-467.7125MHz)	0.29	0.31	1.6
<b>Maximum Simultaneous Transmission SAR</b>			
Items	Head Face Up (Gap 25mm)	Body-Worn (Gap 0mm)	Limits
Sum SAR(W/kg)	0.41	0.42	1.6
SPLSR	N/A	N/A	0.04
EUT Received Date:	2022/06/14		
Tested Date:	2022/06/25		
Tested Result:	Pass		

## Test Facility

The Test site used by China Certification ICT Co., Ltd (Dongguan) to collect test data is located on the No. 113, Pingkang Road, Dalang Town, Dongguan, Guangdong, China.

The lab has been recognized as the FCC accredited lab under the KDB 974614 D01 and is listed in the FCC Public Access Link (PAL) database, FCC Registration No. : 442868, the FCC Designation No. : CN1314.

The lab has been recognized by Innovation, Science and Economic Development Canada to test to Canadian radio equipment requirements, the CAB identifier: CN0123.

## Declarations

China Certification ICT Co., Ltd (Dongguan) is not responsible for the authenticity of any test data provided by the applicant. Data included from the applicant that may affect test results are marked with a triangle symbol “▲”. Customer model name, addresses, names, trademarks etc. are not considered data.

Unless otherwise stated the results shown in this test report refer only to the sample(s) tested.

This report cannot be reproduced except in full, without prior written approval of the Company.

This report is valid only with a valid digital signature. The digital signature may be available only under the Adobe software above version 7.0.

This report may contain data that are not covered by the accreditation scope and shall be marked with an asterisk “★”.

## CONTENTS

<b>SAR TEST RESULTS SUMMARY .....</b>	<b>2</b>
<b>TEST FACILITY .....</b>	<b>3</b>
<b>DECLARATIONS.....</b>	<b>3</b>
<b>1. GENERAL INFORMATION .....</b>	<b>6</b>
<b>1.1 PRODUCT DESCRIPTION FOR EQUIPMENT UNDER TEST (EUT) .....</b>	<b>6</b>
<b>1.2 TEST SPECIFICATION, METHODS AND PROCEDURES .....</b>	<b>7</b>
<b>1.3 SAR LIMITS.....</b>	<b>8</b>
<b>2. SAR MEASUREMENT SYSTEM .....</b>	<b>9</b>
<b>3. EQUIPMENT LIST AND CALIBRATION .....</b>	<b>16</b>
<b>3.1 EQUIPMENTS LIST &amp; CALIBRATION INFORMATION .....</b>	<b>16</b>
<b>4. SAR MEASUREMENT SYSTEM VERIFICATION .....</b>	<b>17</b>
<b>4.1 LIQUID VERIFICATION .....</b>	<b>17</b>
<b>4.2 SYSTEM ACCURACY VERIFICATION .....</b>	<b>18</b>
<b>4.3 SAR SYSTEM VALIDATION DATA.....</b>	<b>19</b>
<b>5. EUT TEST STRATEGY AND METHODOLOGY .....</b>	<b>20</b>
<b>5.1 TEST POSITIONS FOR DEVICE OPERATING NEXT TO A PERSON'S EAR.....</b>	<b>20</b>
<b>5.2 CHEEK/TOUCH POSITION.....</b>	<b>21</b>
<b>5.3 EAR/TILT POSITION.....</b>	<b>21</b>
<b>5.4 TEST POSITIONS FOR BODY-WORN AND OTHER CONFIGURATIONS .....</b>	<b>22</b>
<b>5.5 TEST DISTANCE FOR SAR EVALUATION.....</b>	<b>23</b>
<b>5.6 SAR EVALUATION PROCEDURE .....</b>	<b>24</b>
<b>6. CONDUCTED OUTPUT POWER MEASUREMENT .....</b>	<b>25</b>
<b>6.1 TEST PROCEDURE.....</b>	<b>25</b>
<b>6.2 MAXIMUM TARGET OUTPUT POWER.....</b>	<b>25</b>
<b>6.3 TEST RESULTS: .....</b>	<b>26</b>
<b>7. STANDALONE SAR TEST EXCLUSION CONSIDERATIONS .....</b>	<b>27</b>
<b>7.1 STANDALONE SAR TEST EXCLUSION CONSIDERATIONS .....</b>	<b>28</b>
<b>7.2 STANDALONE SAR ESTIMATION: .....</b>	<b>29</b>
<b>8. SAR MEASUREMENT RESULTS .....</b>	<b>30</b>
<b>8.1 SAR TEST DATA .....</b>	<b>30</b>
<b>9. SAR MEASUREMENT VARIABILITY .....</b>	<b>31</b>

---

<b>10. SAR SIMULTANEOUS TRANSMISSION DESCRIPTION .....</b>	<b>32</b>
<b>11. SAR PLOTS .....</b>	<b>33</b>
<b>APPENDIX A MEASUREMENT UNCERTAINTY .....</b>	<b>37</b>
<b>APPENDIX B EUT TEST POSITION PHOTOS .....</b>	<b>39</b>
<b>APPENDIX C CALIBRATION CERTIFICATES .....</b>	<b>41</b>

## 1. GENERAL INFORMATION

### 1.1 Product Description for Equipment under Test (EUT)

<b>Device Type:</b>	Portable
<b>Exposure Category:</b>	General Population/Uncontrolled Exposure
<b>Antenna Type(s):</b>	Integral Antenna
<b>Body-Worn Accessories:</b>	Belt Clip
<b>Face-Head Accessories:</b>	None
<b>Operation Mode:</b>	PTT_FM, Bluetooth
<b>Frequency Band:</b>	<b>462MHz</b> (462.5500-462.7250MHz) <b>467MHz</b> (467.5625-467.7125 MHz) Bluetooth: 2402-2480 MHz
<b>RF Conducted Output Power:</b>	<b>462MHz</b> (462.5500-462.7250MHz): 26.72 dBm <b>467MHz</b> (467.5625-467.7125 MHz): 26.81 dBm Bluetooth(BDR/EDR): 7.79 dBm BLE: 7.14 dBm
<b>Power Source:</b>	7.4VDC Rechargeable Battery
<b>Serial Number:</b>	CR22060025-SA-S1
<b>Normal Operation:</b>	Face Up and Body-worn

## **1.2 Test Specification, Methods and Procedures**

The tests documented in this report were performed in accordance with FCC 47 CFR § 2.1093, IEEE 1528-2013, the following FCC Published RF exposure KDB procedures:

KDB 447498 D04 Interim General RF Exposure Guidance v01  
KDB 865664 D01 SAR Measurement 100 MHz to 6 GHz v01r04  
KDB 865664 D02 RF Exposure Reporting v01r02  
KDB 643646 D01 SAR Test for PTT Radios v01r03

TCB Workshop April 2019: RF Exposure Procedures

**1.3 SAR Limits****FCC Limit**

EXPOSURE LIMITS	SAR (W/kg)	
	(General Population / Uncontrolled Exposure Environment)	(Occupational / Controlled Exposure Environment)
Spatial Average (averaged over the whole body)	0.08	0.4
Spatial Peak (averaged over any 1 g of tissue)	<b>1.60</b>	8.0
Spatial Peak (hands/wrists/feet/ankles averaged over 10 g)	4.0	20.0

Population/Uncontrolled Environments are defined as locations where there is the exposure of individual who have no knowledge or control of their exposure.

Occupational/Controlled Environments are defined as locations where there is exposure that may be incurred by people who are aware of the potential for exposure (i.e. as a result of employment or occupation).



## 2. SAR MEASUREMENT SYSTEM

These measurements were performed with the automated near-field scanning system DASY5 from Schmid & Partner Engineering AG (SPEAG) which is the Fifth generation of the system shown in the figure hereinafter:



### DASY5 System Description

The DASY5 system for performing compliance tests consists of the following items:

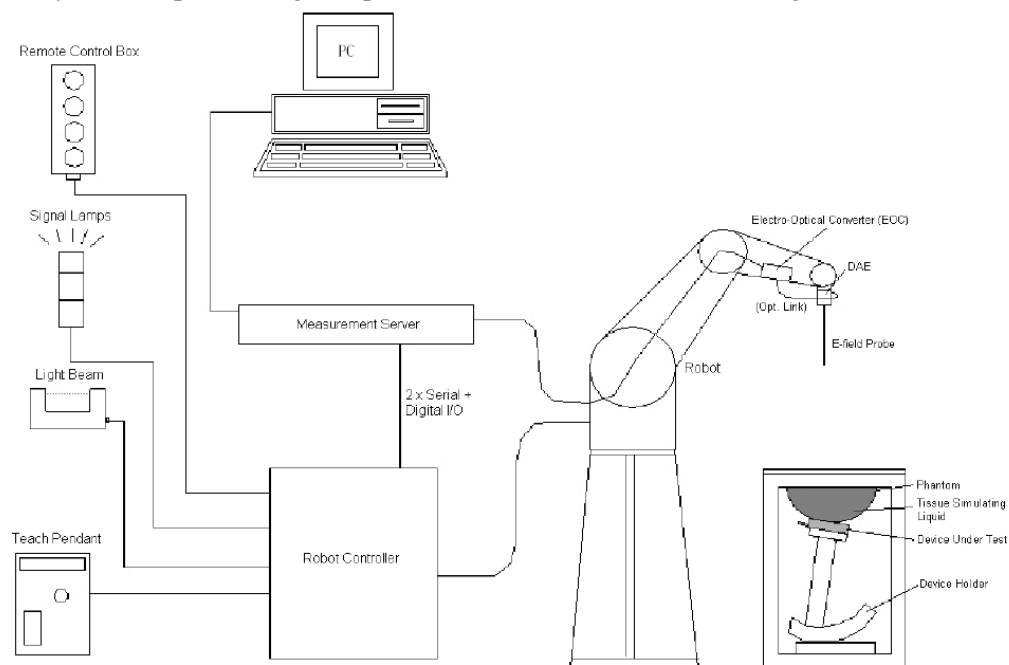

- A standard high precision 6-axis robot with controller, teach pendant and software. An arm extension for accommodating the data acquisition electronics (DAE).
- An isotropic field probe optimized and calibrated for the targeted measurement.
- A data acquisition electronics (DAE) which performs the signal application, signal multiplexing, AD-conversion, offset measurements, mechanical surface detection, collision detection, etc. The unit is battery powered with standard or rechargeable batteries. The signal is optically transmitted to the EOC.
- The Electro-optical converter (EOC) performs the conversion from optical to electrical signals for the digital communication to the DAE. To use optical surface detection, a special version of the EOC is required. The EOC signal is transmitted to the measurement server.
- The function of the measurement server is to perform the time critical tasks such as signal filtering, control of the robot operation and fast movement interrupts.
- The Light Beam used is for probe alignment. This improves the (absolute) accuracy of the probe positioning.
- A computer running Win7 professional operating system and the DASY52 software.
- Remote control and teach pendant as well as additional circuitry for robot safety such as warning lamps, etc.
- The phantom, the device holder and other accessories according to the targeted measurement.

### **DASY5 Measurement Server**

The DASY5 measurement server is based on a PC/104 CPU board with a 400MHz Intel ULV Celeron, 128MB chip-disk and 128MB RAM. The necessary circuits for communication with the DAE4 (or DAE3) electronics box, as well as the 16 bit AD-converter system for optical detection and digital I/O interface are contained on the DASY5 I/O board, which is directly connected to the PC/104 bus of the CPU board.



The measurement server performs all real-time data evaluation of field measurements and surface detection, controls robot movements and handles safety operation. The PC operating system cannot interfere with these time critical processes. All connections are supervised by a watchdog, and disconnection of any of the cables to the measurement server will automatically disarm the robot and disable all program-controlled robot movements. Furthermore, the measurement server is equipped with an expansion port which is reserved for future applications. Please note that this expansion port does not have a standardized point out, and therefore only devices provided by SPEAG can be connected. Devices from any other supplier could seriously damage the measurement server.

### **Data Acquisition Electronics**

The data acquisition electronics (DAE4) consist of a highly sensitive electrometer-grade preamplifier with auto-zeroing, a channel and gain-switching multiplexer, a fast 16 bit AD-converter and a command decoder with a control logic unit. Transmission to the measurement server is accomplished through an optical downlink for data and status information, as well as an optical uplink for commands and the clock.

The mechanical probe mounting device includes two different sensor systems for frontal and sideways probe contacts. They are used for mechanical surface detection and probe collision detection.

The input impedance of both the DAE4 as well as of the DAE3 box is 200M $\Omega$ ; the inputs are symmetrical and floating. Common mode rejection is above 80 dB.

**ES3DV2 E-Field Probes**

<b>Frequency</b>	10 MHz to > 4 GHz Linearity: $\pm 0.2$ dB (30 MHz to 4 GHz)
<b>Directivity</b>	$\pm 0.2$ dB in TSL (rotation around probe axis) $\pm 0.3$ dB in TSL (rotation normal to probe axis)
<b>Dynamic Range</b>	5 $\mu$ W/g to > 100 mW/g Linearity: $\pm 0.2$ dB (noise: typically < 1 $\mu$ W/g)
<b>Dimensions</b>	Overall length: 337 mm (Tip: 10 mm) Tip diameter: 4 mm (Body: 10 mm) Typical distance from probe tip to dipole centers: 4.0 mm
<b>Application</b>	General dosimetry up to 4 GHz Dosimetry in strong gradient fields Compliance tests of mobile phones
<b>Compatibility</b>	DASY3, DASY4, DASY52 SAR and higher, EASY4/MRI

**Calibration Frequency Points for ES3DV2 E-Field Probes SN: 3019 Calibrated: 2021/12/13**

Calibration Frequency Point(MHz)	Frequency Range(MHz)		Conversion Factor		
	From	To	X	Y	Z
150 Head	100	200	7.69	7.69	7.69
150 Body	100	200	7.51	7.51	7.51
450 Head	350	550	7.02	7.02	7.02
450 Body	350	550	6.95	6.95	6.95

### **SAM Twin Phantom**

The SAM twin phantom is a fiberglass shell phantom with 2mm shell thickness (except the ear region, where shell thickness increases to 6 mm). The phantom has three measurement areas:

- \_ Left Head
- \_ Right Head
- \_ Flat phantom

The phantom table for the DASY systems based on the robots have the size of 100 x 50 x 85 cm (L x W x H). For easy dislocation these tables have fork lift cut outs at the bottom.

The bottom plate contains three pairs of bolts for locking the device holder. The device holder positions are adjusted to the standard measurement positions in the three sections. Only one device holder is necessary if two phantoms are used (e.g., for different liquids)



A white cover is provided to cover the phantom during off-periods to prevent water evaporation and changes in the liquid parameters. Free space scans of devices on top of this phantom cover are possible. Three reference marks are provided on the phantom counter. These reference marks are used to teach the absolute phantom position relative to the robot.

### **Robots**

The DASY5 system uses the high precision industrial robot. The robot offers the same features important for our application:

- High precision (repeatability 0.02mm)
- High reliability (industrial design)
- Low maintenance costs (virtually maintenance free due to direct drive gears; no belt drives)
- Jerk-free straight movements (brushless synchrony motors; no stepper motors)
- Low ELF interference (motor control fields shielded via the closed metallic construction shields)

The above mentioned robots are controlled by the Staubli CS8c robot controllers. All information regarding the use and maintenance of the robot arm and the robot controller is contained on the CDs delivered along with the robot. Paper manuals are available upon request direct from Staubli.

## SAR Scan Procedures

### Step 1: Power Reference Measurement

The Power Reference Measurement and Power Drift Measurements are for monitoring the power drift of the device under test in the batch process. The minimum distance of probe sensors to surface determines the closest measurement point to phantom surface. The minimum distance of probe sensors to surface is 1.4 mm. This distance cannot be smaller than the distance of sensor calibration points to probe tip as defined in the probe properties.

### Step 2: Area Scans

Area scans are defined prior to the measurement process being executed with a user defined variable spacing between each measurement point (integral) allowing low uncertainty measurements to be conducted. Scans defined for FCC applications utilize a 15mm 2 step integral, with 1.5mm interpolation used to locate the peak SAR area used for zoom scan assessments.

Where the system identifies multiple SAR peaks (which are within 25% of peak value) the system will provide the user with the option of assessing each peak location individually for zoom scan averaging.

Area Scan Parameters extracted from KDB 865664 D01 SAR Measurement 100 MHz to 6 GHz

	$\leq 3$ GHz	$> 3$ GHz
Maximum distance from closest measurement point (geometric center of probe sensors) to phantom surface	5 mm $\pm$ 1 mm	$\frac{1}{2} \cdot \delta \cdot \ln(2)$ mm $\pm$ 0.5 mm
Maximum probe angle from probe axis to phantom surface normal at the measurement location	$30^\circ \pm 1^\circ$	$20^\circ \pm 1^\circ$
Maximum area scan spatial resolution: $\Delta x_{Area}$ , $\Delta y_{Area}$	$\leq 2$ GHz: $\leq 15$ mm 2 – 3 GHz: $\leq 12$ mm	3 – 4 GHz: $\leq 12$ mm 4 – 6 GHz: $\leq 10$ mm
	When the x or y dimension of the test device, in the measurement plane orientation, is smaller than the above, the measurement resolution must be $\leq$ the corresponding x or y dimension of the test device with at least one measurement point on the test device.	

### Step 3: Zoom Scan (Cube Scan Averaging)

The averaging zoom scan volume utilized in the DASY5 software is in the shape of a cube and the side dimension of a 1 g or 10 g mass is dependent on the density of the liquid representing the simulated tissue. A density of 1000 kg/m<sup>3</sup> is used to represent the head and body tissue density and not the phantom liquid density, in order to be consistent with the definition of the liquid dielectric properties, i.e. the side length of the 1g cube is 10mm, with the side length of the 10g cube is 21.5mm.

Zoom Scan Parameters extracted from KDB 865664 D01 SAR Measurement 100 MHz to 6 GHz

			≤ 3 GHz	> 3 GHz
Maximum zoom scan spatial resolution: $\Delta x_{Zoom}$ , $\Delta y_{Zoom}$			≤ 2 GHz: ≤ 8 mm 2 – 3 GHz: ≤ 5 mm*	3 – 4 GHz: ≤ 5 mm* 4 – 6 GHz: ≤ 4 mm*
Maximum zoom scan spatial resolution, normal to phantom surface	uniform grid: $\Delta z_{Zoom}(n)$		≤ 5 mm	3 – 4 GHz: ≤ 4 mm 4 – 5 GHz: ≤ 3 mm 5 – 6 GHz: ≤ 2 mm
	graded grid	$\Delta z_{Zoom}(1)$ : between 1 <sup>st</sup> two points closest to phantom surface	≤ 4 mm	3 – 4 GHz: ≤ 3 mm 4 – 5 GHz: ≤ 2.5 mm 5 – 6 GHz: ≤ 2 mm
		$\Delta z_{Zoom}(n>1)$ : between subsequent points	≤ 1.5 · $\Delta z_{Zoom}(n-1)$ mm	
Minimum zoom scan volume	x, y, z	≥ 30 mm	3 – 4 GHz: ≥ 28 mm 4 – 5 GHz: ≥ 25 mm 5 – 6 GHz: ≥ 22 mm	
Note: $\delta$ is the penetration depth of a plane-wave at normal incidence to the tissue medium; see IEEE Std 1528-2013 for details. * When zoom scan is required and the <i>reported</i> SAR from the <i>area scan based 1-g SAR estimation</i> procedures of KDB Publication 447498 is ≤ 1.4 W/kg, ≤ 8 mm, ≤ 7 mm and ≤ 5 mm zoom scan resolution may be applied, respectively, for 2 GHz to 3 GHz, 3 GHz to 4 GHz and 4 GHz to 6 GHz.				

### Step 4: Power Drift Measurement

The Power Drift Measurement measures the field at the same location as the most recent power reference measurement within the same procedure, and with the same settings. The Power Drift Measurement gives the field difference in dB from the reading conducted within the last Power Reference Measurement. This allows a user to monitor the power drift of the device under test within a batch process. The measurement procedure is the same as Step 1.

When the cube intersects with the surface of the phantom, it is oriented so that 3 vertices touch the surface of the shell or the center of a face is tangent to the surface. The face of the cube closest to the surface is modified in order to conform to the tangent surface.

The zoom scan integer steps can be user defined so as to reduce uncertainty, but normal practice for typical test applications (including FCC) utilize a physical step of 7 x 7 x 7 (5mmx5mmx5mm) providing a volume of 30 mm in the X & Y & Z axis.

## Tissue Dielectric Parameters for Head and Body Phantoms

The head tissue dielectric parameters recommended by the IEC 62209-1:2016

### Recommended Tissue Dielectric Parameters for Head liquid

**Table A.3 – Dielectric properties of the head tissue-equivalent liquid**

Frequency MHz	Relative permittivity $\epsilon_r$	Conductivity ( $\sigma$ ) S/m
300	45,3	0,87
450	43,5	0,87
<i>750</i>	<i>41,9</i>	<i>0,89</i>
835	41,5	0,90
900	41,5	0,97
1 450	40,5	1,20
<i>1 500</i>	<i>40,4</i>	<i>1,23</i>
<i>1 640</i>	<i>40,2</i>	<i>1,31</i>
<i>1 750</i>	<i>40,1</i>	<i>1,37</i>
1 800	40,0	1,40
1 900	40,0	1,40
2 000	40,0	1,40
<i>2 100</i>	<i>39,8</i>	<i>1,49</i>
<i>2 300</i>	<i>39,5</i>	<i>1,67</i>
2 450	39,2	1,80
<i>2 600</i>	<i>39,0</i>	<i>1,96</i>
3 000	38,5	2,40
<i>3 500</i>	<i>37,9</i>	<i>2,91</i>
<i>4 000</i>	<i>37,4</i>	<i>3,43</i>
<i>4 500</i>	<i>36,8</i>	<i>3,94</i>
<i>5 000</i>	<i>36,2</i>	<i>4,45</i>
<i>5 200</i>	<i>36,0</i>	<i>4,66</i>
<i>5 400</i>	<i>35,8</i>	<i>4,86</i>
<i>5 600</i>	<i>35,5</i>	<i>5,07</i>
<i>5 800</i>	<i>35,3</i>	<i>5,27</i>
<i>6 000</i>	<i>35,1</i>	<i>5,48</i>

NOTE For convenience, permittivity and conductivity values at those frequencies which are not part of the original data provided by Drossos et al. [33] or the extension to 5 800 MHz are provided (i.e. the values shown *in italics*). These values were linearly interpolated between the values in this table that are immediately above and below these values, except the values at 6 000 MHz that were linearly extrapolated from the values at 3 000 MHz and 5 800 MHz.

### 3. EQUIPMENT LIST AND CALIBRATION

#### 3.1 Equipments List & Calibration Information

Equipment	Model	S/N	Calibration Date	Calibration Due Date
DASY5 Test Software	DASY52.10	N/A	NCR	NCR
DASY5 Measurement Server	DASY5 4.5.12	1567	NCR	NCR
Data Acquisition Electronics	DAE4	1354	2021/9/1	2022/8/31
E-Field Probe	ES3DV2	3019	2021/12/13	2022/12/12
Mounting Device	MD4HHTV5	BJPCTC0152	NCR	NCR
Oval Flat Phantom	ELI V8.0	2051	NCR	NCR
Dipole, 450MHz	D450V3	1096	2019/11/27	2022/11/26
Simulated Tissue 450 MHz	TS-450	2109045001	Each Time	/
Network Analyzer	8753B	2828A00170	2021/10/26	2022/10/25
Dielectric assessment kit	1253	SM DAK 040 CA	NCR	NCR
MXG Vector Signal Generator	N5182B	MY51350144	2021/7/22	2022/7/21
Power Meter	EPM-441A/8484A	GB37481494	2021/7/22	2022/7/21
Power Amplifier	ZVA-183-S+	5969001149	NCR	NCR
Directional Coupler	441493	520Z	NCR	NCR
Attenuator	20dB, 100W	LN749	NCR	NCR
Attenuator	6dB, 150W	2754	NCR	NCR
Antenna	JB3	A060611-1	2020/11/10	2023/11/10
Signal Analyzer	FSIQ26	831929/006	2021/07/22	2022/07/21



## 4. SAR MEASUREMENT SYSTEM VERIFICATION

### 4.1 Liquid Verification

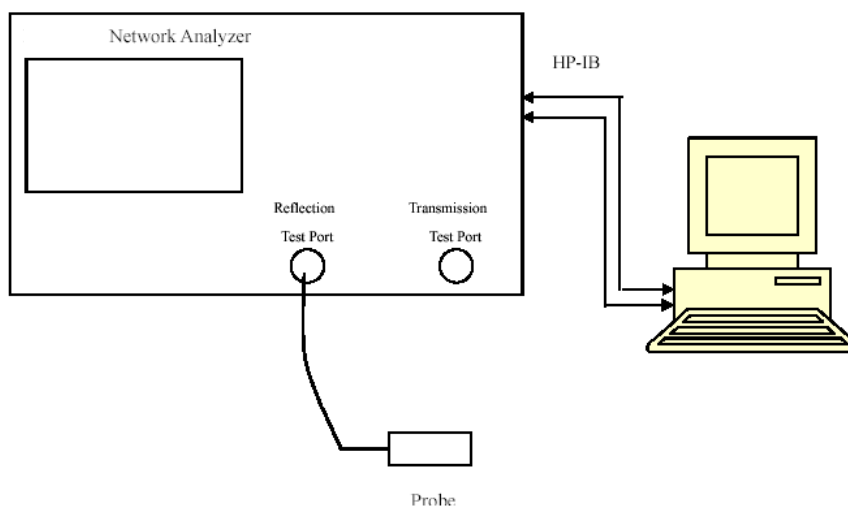

Liquid Verification Setup Block Diagram

### Liquid Verification Results

Frequency (MHz)	Liquid Type	Liquid Parameter		Target Value		Delta (%)		Tolerance (%)
		$\epsilon_r$	$\sigma$ (S/m)	$\epsilon_r$	$\sigma$ (S/m)	$\Delta\epsilon_r$	$\Delta\sigma$ (S/m)	
450	Simulated Tissue 450 MHz	43.413	0.894	43.5	0.87	-0.2	2.76	$\pm 10$
462.6375	Simulated Tissue 450 MHz	43.344	0.901	43.43	0.87	-0.2	3.56	$\pm 10$
467.6375	Simulated Tissue 450 MHz	43.263	0.905	43.41	0.87	-0.34	4.02	$\pm 10$

\*Liquid Verification above was performed on 2022/06/25.

### 4.2 System Accuracy Verification

Prior to the assessment, the system validation kit was used to test whether the system was operating within its specifications of  $\pm 10\%$ . The validation results are tabulated below. And also the corresponding SAR plot is attached as well in the SAR plots files.

The spacing distances in the **System Verification Setup Block Diagram** is given by the following:

- a)  $s = 15 \text{ mm} \pm 0,2 \text{ mm}$  for  $300 \text{ MHz} \leq f \leq 1 \text{ 000 MHz}$ ;
- b)  $s = 10 \text{ mm} \pm 0,2 \text{ mm}$  for  $1 \text{ 000 MHz} < f \leq 3 \text{ 000 MHz}$ ;
- c)  $s = 10 \text{ mm} \pm 0,2 \text{ mm}$  for  $3 \text{ 000 MHz} < f \leq 6 \text{ 000 MHz}$ .

### System Verification Setup Block Diagram

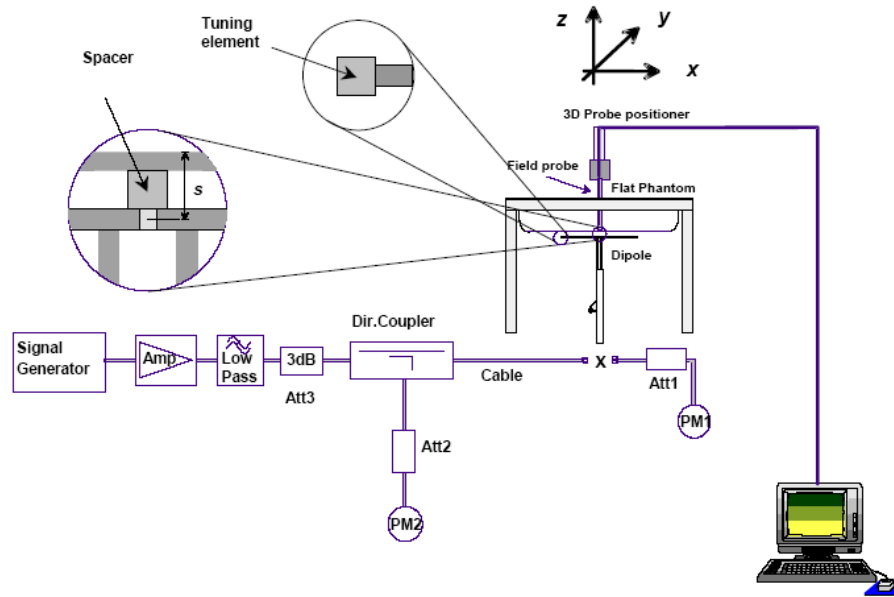

### System Accuracy Check Results

Date	Frequency Band	Liquid Type	Input Power (mW)	Measured SAR (W/kg)	Normalized to 1W (W/kg)	Target Value (W/kg)	Delta (%)	Tolerance (%)
2022/06/25	450 MHz	Simulated Tissue 450 MHz	100	1g 0.441	4.41	4.53	-2.65	$\pm 10$

\*The SAR values above are normalized to 1 Watt forward power.

### 4.3 SAR SYSTEM VALIDATION DATA

#### System Performance 450 MHz

**DUT: Dipole 450 MHz; Type: D450V3; Serial: 1096**

Communication System: CW; Frequency: 450 MHz; Duty Cycle: 1:1

Medium parameters used:  $f = 450$  MHz;  $\sigma = 0.894$  S/m;  $\epsilon_r = 43.413$ ;  $\rho = 1000$  kg/m<sup>3</sup>

Phantom section: Flat Section

DASY5 Configuration:

- Probe: ES3DV2 - SN3019; ConvF(7.02, 7.02, 7.02) @ 450 MHz; Calibrated: 2021/12/13
- Sensor-Surface: 4mm (Mechanical Surface Detection)
- Electronics: DAE4 Sn1354; Calibrated: 2021/9/1
- Phantom: ELI v8.0; Type: QDOVA002AA; Serial: TP:2051
- Measurement SW: DASY52, Version 52.10 (2); SEMCAD X Version 14.6.12 (7470)

**Area Scan (61x201x1):** Interpolated grid: dx=1.500 mm, dy=1.500 mm

Maximum value of SAR (interpolated) = 0.446 W/kg

**Zoom Scan (5x5x7)/Cube 0:** Measurement grid: dx=8mm, dy=8mm, dz=5mm

Reference Value = 20.61 V/m; Power Drift = 0.13 dB

Peak SAR (extrapolated) = 0.655 W/kg

**SAR(1 g) = 0.441 W/kg; SAR(10 g) = 0.295 W/kg**

Maximum value of SAR (measured) = 0.473 W/kg

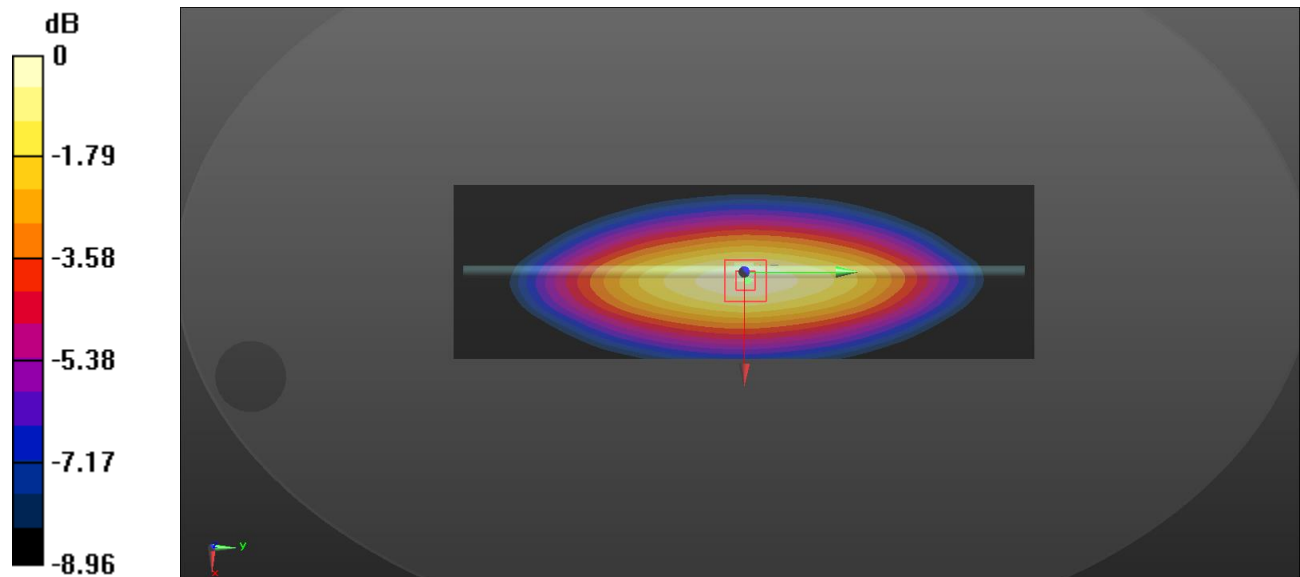

0 dB = 0.473 W/kg = -3.25 dBW/kg

## 5. EUT TEST STRATEGY AND METHODOLOGY

### 5.1 Test Positions for Device Operating Next to a Person’s Ear

This category includes most wireless handsets with fixed, retractable or internal antennas located toward the top half of the device, with or without a foldout, sliding or similar keypad cover. The handset should have its earpiece located within the upper ¼ of the device, either along the centerline or off-centered, as perceived by its users. This type of handset should be positioned in a normal operating position with the “test device reference point” located along the “vertical centerline” on the front of the device aligned to the “ear reference point”. The “test device reference point” should be located at the same level as the center of the earpiece region. The “vertical centerline” should bisect the front surface of the handset at its top and bottom edges. A “ear reference point” is located on the outer surface of the head phantom on each ear spacer. It is located 1.5 cm above the center of the ear canal entrance in the “phantom reference plane” defined by the three lines joining the center of each “ear reference point” (left and right) and the tip of the mouth.

A handset should be initially positioned with the earpiece region pressed against the ear spacer of a head phantom. For the SCC-34/SC-2 head phantom, the device should be positioned parallel to the “N-F” line defined along the base of the ear spacer that contains the “ear reference point”. For interim head phantoms, the device should be positioned parallel to the cheek for maximum RF energy coupling. The “test device reference point” is aligned to the “ear reference point” on the head phantom and the “vertical centerline” is aligned to the “phantom reference plane”. This is called the “initial ear position”. While maintaining these three alignments, the body of the handset is gradually adjusted to each of the following positions for evaluating SAR:

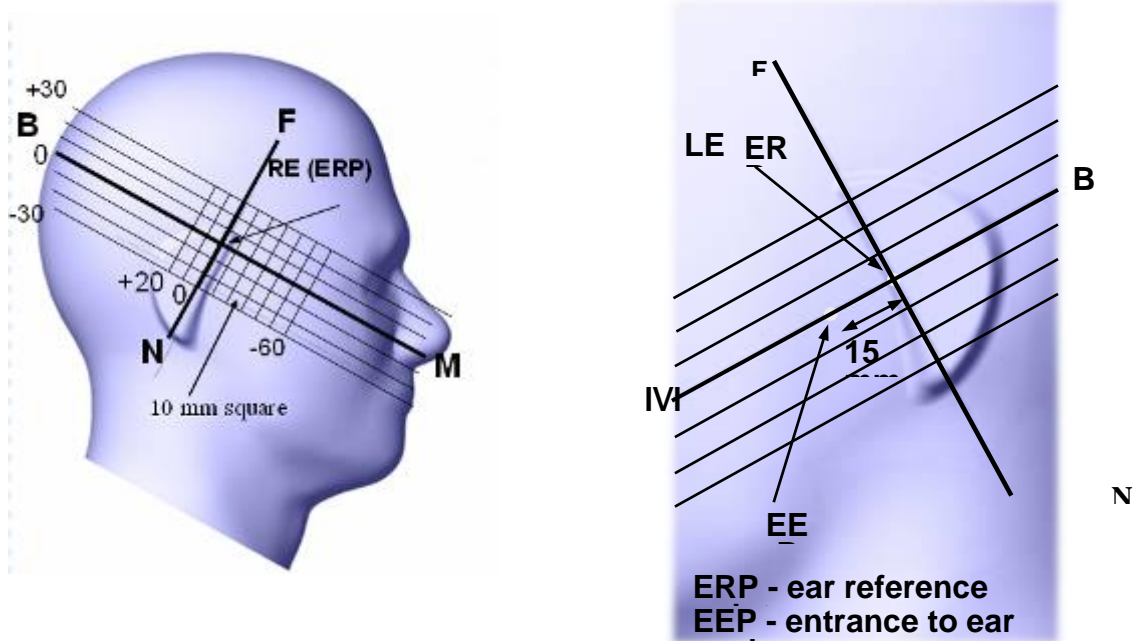

## 5.2 Cheek/Touch Position

The device is brought toward the mouth of the head phantom by pivoting against the “ear reference point” or along the “N-F” line for the SCC-34/SC-2 head phantom.

This test position is established:

When any point on the display, keypad or mouthpiece portions of the handset is in contact with the phantom.

(or) When any portion of a foldout, sliding or similar keypad cover opened to its intended self-adjusting normal use position is in contact with the cheek or mouth of the phantom.

For existing head phantoms – when the handset loses contact with the phantom at the pivoting point, rotation should continue until the device touches the cheek of the phantom or breaks its last contact from the ear spacer.

### Cheek /Touch Position

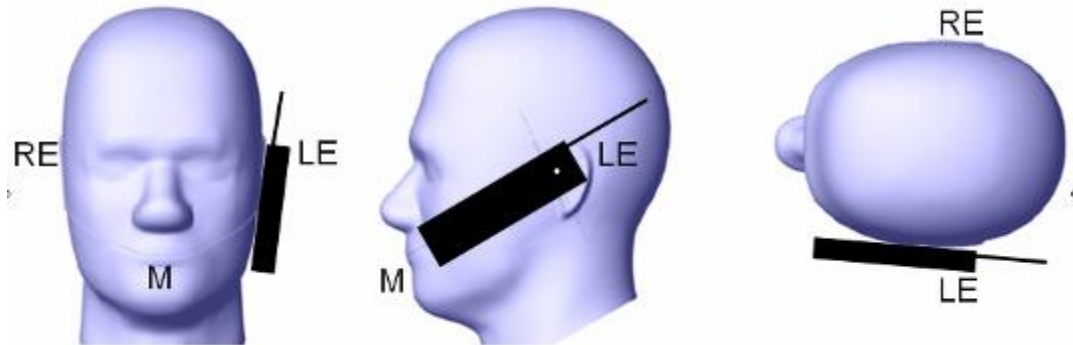

## 5.3 Ear/Tilt Position

With the handset aligned in the “Cheek/Touch Position”:

1) If the earpiece of the handset is not in full contact with the phantom’s ear spacer (in the “Cheek/Touch position”) and the peak SAR location for the “Cheek/Touch” position is located at the ear spacer region or corresponds to the earpiece region of the handset, the device should be returned to the “initial ear position” by rotating it away from the mouth until the earpiece is in full contact with the ear spacer.

2) (otherwise) The handset should be moved (translated) away from the cheek perpendicular to the line passes through both “ear reference points” (note: one of these ear reference points may not physically exist on a split head model) for approximate 2-3 cm. While it is in this position, the device handset is tilted away from the mouth with respect to the “test device reference point” until the inside angle between the vertical centerline on the front surface of the phone and the horizontal line passing through the ear reference point is by 15 80°. After the tilt, it is then moved (translated) back toward the head perpendicular to the line passes through both “ear reference points” until the device touches the phantom or the ear spacer. If the antenna touches the head first, the positioning process should be repeated with a tilt angle less than 15° so that the device and its antenna would touch the phantom simultaneously. This test position may require a device holder or positioner to achieve the translation and tilting with acceptable positioning repeatability.

If a device is also designed to transmit with its keypad cover closed for operating in the head position, such positions should also be considered in the SAR evaluation. The device should be tested on the left and

right side of the head phantom in the “Cheek/Touch” and “Ear/Tilt” positions. When applicable, each configuration should be tested with the antenna in its fully extended and fully retracted positions. These test configurations should be tested at the high, middle and low frequency channels of each operating mode; for example, AMPS, CDMA, and TDMA. If the SAR measured at the middle channel for each test configuration (left, right, Cheek/Touch, Tilt/Ear, extended and retracted) is at least 2.0 dB lower than the SAR limit, testing at the high and low channels is optional for such test configuration(s). If the transmission band of the test device is less than 10 MHz, testing at the high and low frequency channels is optional.

#### Ear /Tilt 15° Position

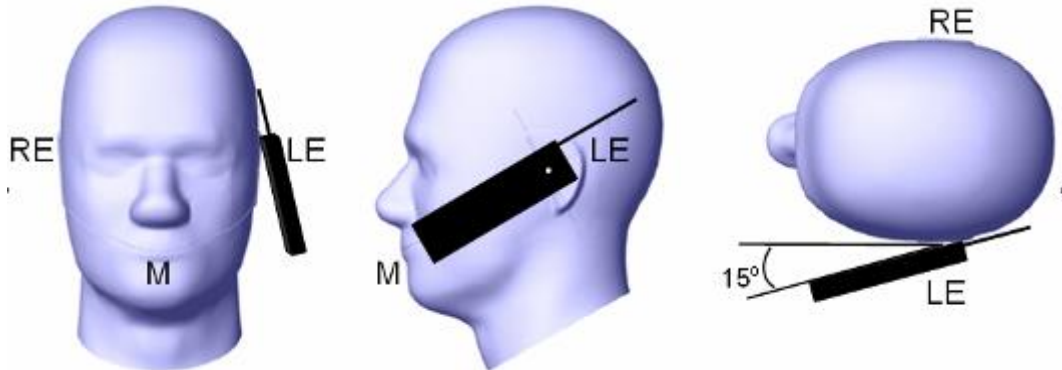

#### **5.4 Test positions for body-worn and other configurations**

Body-worn operating configurations should be tested with the belt-clips and holsters attached to the device and positioned against a flat phantom in normal use configurations. Devices with a headset output should be tested with a headset connected to the device. When multiple accessories that do not contain metallic components are supplied with the device, the device may be tested with only the accessory that dictates the closest spacing to the body. When multiple accessories that contain metallic components are supplied with the device, the device must be tested with each accessory that contains a unique metallic component. If multiple accessories share an identical metallic component (e.g., the same metallic belt-clip used with different holsters with no other metallic components), only the accessory that dictates the closest spacing to the body must be tested.

Body-worn accessories may not always be supplied or available as options for some devices that are intended to be authorized for body-worn use. A separation distance of 1.5 cm between the back of the device and a flat phantom is recommended for testing body-worn SAR compliance under such circumstances. Other separation distances may be used, but they should not exceed 2.5 cm. In these cases, the device may use body-worn accessories that provide a separation distance greater than that tested for the device provided however that the accessory contains no metallic components.

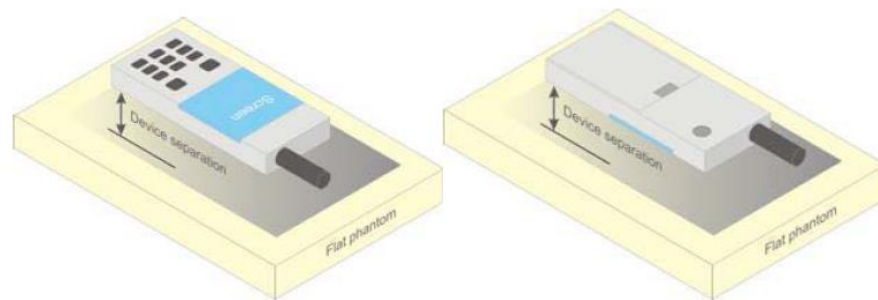

Figure 5 – Test positions for body-worn devices

### 5.5 Test Distance for SAR Evaluation

In this case the DUT(Device Under Test) is set directly against the phantom, the test distance is 0mm for Body Back mode; for Face Up mode the distance is 25mm.

## 5.6 SAR Evaluation Procedure

The evaluation was performed with the following procedure:

Step 1: Measurement of the SAR value at a fixed location above the ear point or central position was used as a reference value for assessing the power drop. The SAR at this point is measured at the start of the test and then again at the end of the testing.

Step 2: The SAR distribution at the exposed side of the head was measured at a distance of 4 mm from the inner surface of the shell. The area covered the entire dimension of the head or radiating structures of the EUT, the horizontal grid spacing was 15 mm x 15 mm, and the SAR distribution was determined by integrated grid of 1.5mm x 1.5mm. Based on these data, the area of the maximum absorption was determined by spline interpolation. The first Area Scan covers the entire dimension of the EUT to ensure that the hotspot was correctly identified.

Step 3: Around this point, a volume of 30 mm x 30 mm x 30 mm was assessed by measuring 7x 7 x 7 points. On the basis of this data set, the spatial peak SAR value was evaluated under the following procedure:

- 1) The data at the surface were extrapolated, since the center of the dipoles is 1.2 mm away from the tip of the probe and the distance between the surface and the lowest measuring point is 1.3 mm. The extrapolation was based on a least square algorithm. A polynomial of the fourth order was calculated through the points in z-axes. This polynomial was then used to evaluate the points between the surface and the probe tip.

- 2) The maximum interpolated value was searched with a straightforward algorithm. Around this maximum the SAR values averaged over the spatial volumes (1 g or 10 g) were computed by the 3D-Spline interpolation algorithm. The 3D-Spline is composed of three one dimensional splines with the "Not a knot"-condition (in x, y and z-directions). The volume was integrated with the trapezoidal-algorithm. One thousand points (10 x 10 x 10) were interpolated to calculate the averages.

All neighboring volumes were evaluated until no neighboring volume with a higher average value was found.

Step 4: Re-measurement of the SAR value at the same location as in Step 1. If the value changed by more than 5%, the evaluation was repeated.



## 6. CONDUCTED OUTPUT POWER MEASUREMENT

### 6.1 Test Procedure

The RF output of the transmitter was connected to the input of the Signal Analyzer through sufficient attenuation.

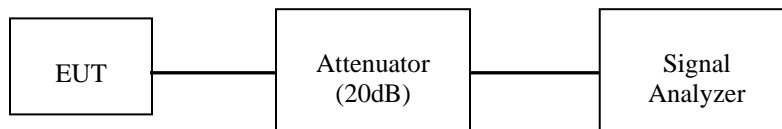

The Signal Analyzer setting:

RBW	VBW
100 kHz	300 kHz

### 6.2 Maximum Target Output Power

Frequency Band	Max. tune-up tolerance power limit for Production(dBm)
462MHz(462.5500-462.7250MHz)	27
467MHz(467.5625-467.7125 MHz)	27
Bluetooth BDR/EDR	8
BLE_1M	7.5
BLE_2M	7.5

**6.3 Test Results:**

Mode	Frequency (MHz)	Conducted Output Power(dBm)
462MHz(462.5500-462.7250MHz)	462.6375	26.72
467MHz(467.5625-467.7125 MHz)	467.6375	26.81

**Note:**

Per IEEE1528:2013, the width of the transmit frequency band,  $\Delta f = f_{\text{high}} - f_{\text{low}}$  (where  $f_{\text{high}}$  is the highest frequency in the band and  $f_{\text{low}}$  is the lowest) does not exceeds 1% of its center frequency  $f_c$  .then only **center frequency** need be tested.

**Bluetooth:**

Mode	Channel frequency (MHz)	RF Output Power (dBm)
BDR(GFSK)	2402	7.27
	2441	5.89
	2480	4.06
EDR( $\pi/4$ -DQPSK)	2402	7.75
	2441	6.34
	2480	4.67
EDR(8DPSK)	2402	<b>7.79</b>
	2441	6.46
	2480	4.83
BLE_1M	2402	7.14
	2440	5.78
	2480	3.89
BLE_2M	2402	7.02
	2440	5.74
	2480	3.91

## 7. STANDALONE SAR TEST EXCLUSION CONSIDERATIONS

### Antennas Location:

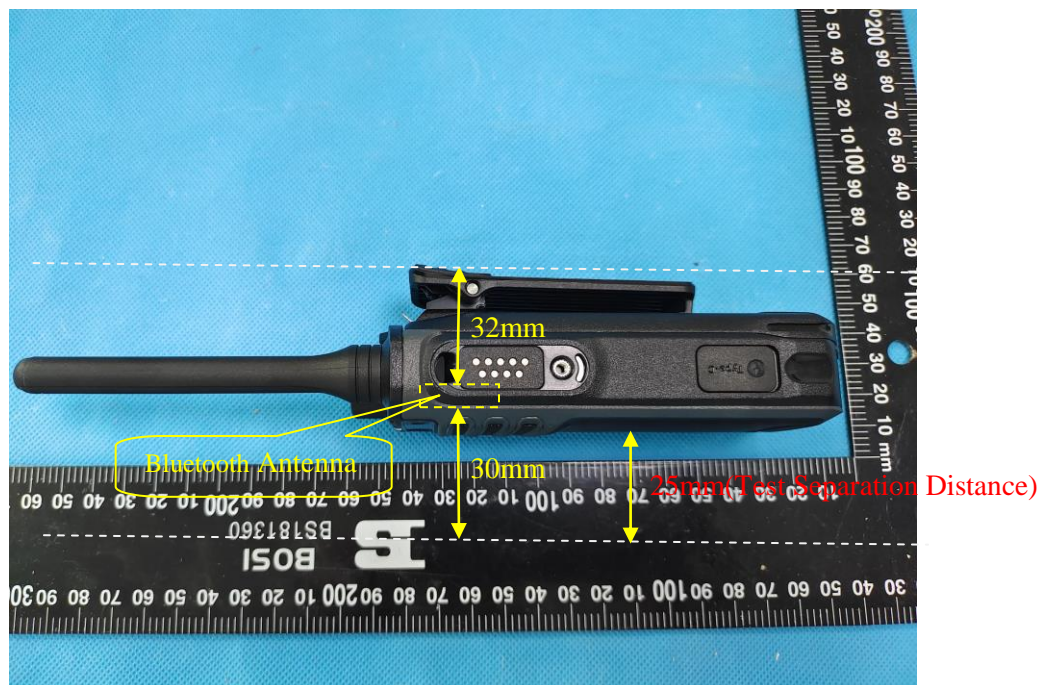
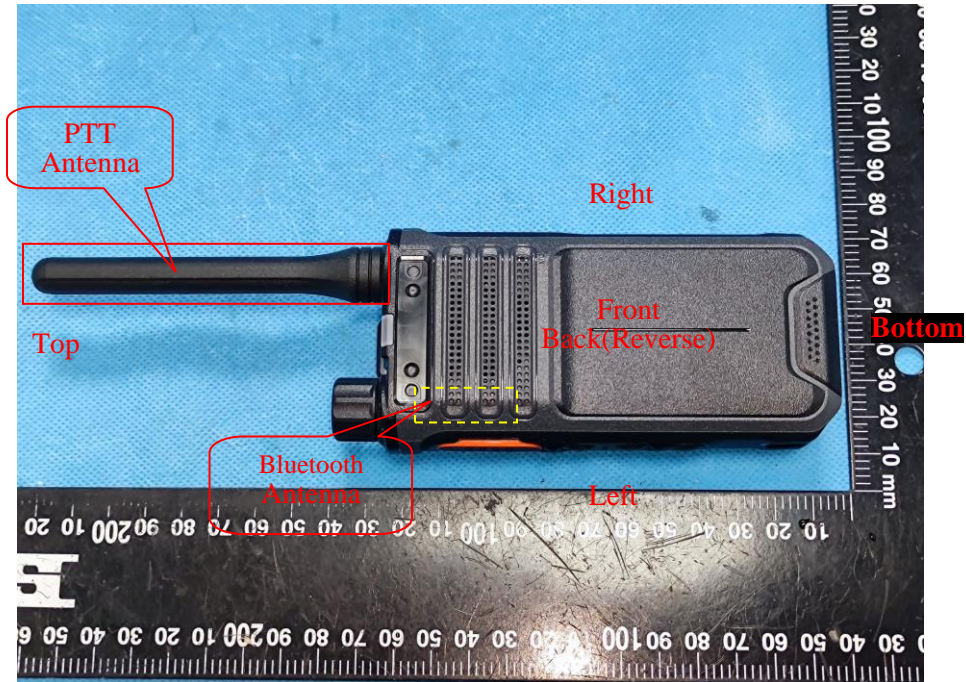

## 7.1 Standalone SAR test exclusion considerations

Mode	Frequency (MHz)	Distance (cm)	SAR-Based Exemption Threshold		Conducted output power including Tune-up Tolerance (dBm)	Antenna Gain (dBi)	EIRP (dBm)	SAR Test Exclusion
			(mW)	(dBm)				
Bluetooth	2480	3.0	82.48	19.16	8	0	8	YES

*Note: The bluetooth based peak power for calculation.*

### NOTE:

According to 447498 D04 Interim General RF Exposure Guidance v01, clause 2.1.3 1- SAR-Based Exemption:

The SAR-based exemption formula of §1.1307(b)(3)(i)(B), repeated here as Formula (B.2), applies for single fixed, mobile, and portable RF sources with available maximum time-averaged power or effective radiated power (ERP), whichever is greater, of less than or equal to the threshold  $P_{th}$  (mW).

This method shall only be used at separation distances from 0.5 cm to 40 cm and at frequencies from 0.3 GHz to 6 GHz (inclusive).  $P_{th}$  is given by Formula (B.2).

$$P_{th} \text{ (mW)} = \begin{cases} ERP_{20 \text{ cm}} (d/20 \text{ cm})^x & d \leq 20 \text{ cm} \\ ERP_{20 \text{ cm}} & 20 \text{ cm} < d \leq 40 \text{ cm} \end{cases} \quad (\text{B.2})$$

where

$$x = -\log_{10} \left( \frac{60}{ERP_{20 \text{ cm}} \sqrt{f}} \right)$$

and  $f$  is in GHz,  $d$  is the separation distance (cm), and  $ERP_{20 \text{ cm}}$  is per Formula (B.1).

$$ERP_{20 \text{ cm}} \text{ (mW)} = \begin{cases} 2040f & 0.3 \text{ GHz} \leq f < 1.5 \text{ GHz} \\ 3060 & 1.5 \text{ GHz} \leq f \leq 6 \text{ GHz} \end{cases} \quad (\text{B.1})$$

## 7.2 Standalone SAR estimation:

Mode	Frequency (MHz)	Distance (cm)	$P_{ant}$ (mW)	$P_{th}$ (mW)	Estimated 1-g (W/kg)
BT Head	2480	3.0	6.31	82.48	0.12
BT Body	2480	3.2	6.31	93.27	0.11

*Note: The bluetooth based peak power for calculation*

According to 447498 D04 Interim General RF Exposure Guidance v01, Appendix E: SAR Estimations for Simultaneous Transmission Test Exemptions:

### E.1 Estimated SAR

When an antenna qualifies for test exemption in single transmitter/antenna mode, its actual SAR value may not be available, because it was not required to be measured. In this case, the SAR contribution of that antenna to simultaneous transmission must be estimated relative to the SAR or MPE based exemption criteria for the applicable terms in the equation of § 1.1307(b)(3)(ii)(B) (see also Appendix C), by multiplying the corresponding ratio by the SAR limit of 1.6 W/kg for 1-g SAR. This is referred to as *estimated SAR*.

For instance, a given antenna may qualify for a SAR-based exemption according to Section B.4, with  $P_{ant} < P_{th}$ , where  $P_{ant}$  is maximum time-averaged power or effective radiated power (ERP), whichever is greater, and  $P_{th}$  is defined in Formula (B.2). Then, per the preceding paragraph, the estimated SAR is computed as  $SAR_{est} = 1.6 \cdot P_{ant} / P_{th}$  [W/kg].

When SAR is estimated, the peak SAR location is assumed to be at the feed-point or geometric center of the antenna, whichever provides a smaller antenna separation distance, and this location must be clearly identified in test reports. The estimated SAR is used only to determine simultaneous transmission SAR test exemption; it shall not be reported as the standalone SAR.

## 8. SAR MEASUREMENT RESULTS

This page summarizes the results of the performed dosimetric evaluation.

### 8.1 SAR Test Data

#### Environmental Conditions

<b>Temperature:</b>	22.1-23.9 °C
<b>Relative Humidity:</b>	41 %
<b>ATM Pressure:</b>	100.8 kPa
<b>Test Date:</b>	2022/06/25

*Testing was performed by Karl Gong, Ken Zong, Way Li.*

#### Test Results:

Test Mode	Frequency (MHz)	Worn accessories	Max. Meas. Power (dBm)	Max. Rated Power (dBm)	1 g SAR Value(W/kg)				
					Scaled Factor	Meas. SAR	50%	Scaled SAR	Plot
Head Face Up (25 mm)	462.6375	None	26.72	27	1.067	0.546	0.273	<b>0.29</b>	<b>1#</b>
	467.6375	None	26.81	27	1.045	0.438	0.219	0.23	2#
Body Back (0 mm)	462.6375	Belt Clip	26.72	27	1.067	0.579	0.2895	<b>0.31</b>	<b>3#</b>
	467.6375	Belt Clip	26.81	27	1.045	0.533	0.2665	0.28	4#

#### Note:

1. For a PTT, only simplex communication technology was supported, so the SAR value need to be corrected by Multiplying 50%.
2. Passive body-worn and audio accessories generally do not apply to the head SAR of PTT radios.
3. The whole antenna and radiating structures that may contribute to the measured SAR or influence the SAR distribution has been included in the area scan.

## 9. SAR MEASUREMENT VARIABILITY

In accordance with published RF Exposure KDB procedure 865664 D01 SAR measurement 100 MHz to 6 GHz v01. These additional measurements are repeated after the completion of all measurements requiring the same head or body tissue-equivalent medium in a frequency band. The test device should be returned to ambient conditions (normal room temperature) with the battery fully charged before it is re-mounted on the device holder for the repeated measurement(s) to minimize any unexpected variations in the repeated results

- 1) Repeated measurement is not required when the original highest measured SAR is  $< 0.80$  W/kg; steps 2) through 4) do not apply.
- 2) When the original highest measured SAR is  $\geq 0.80$  W/kg, repeat that measurement once.
- 3) Perform a second repeated measurement only if the ratio of largest to smallest SAR for the original and first repeated measurements is  $> 1.20$  or when the original or repeated measurement is  $\geq 1.45$  W/kg (~ 10% from the 1-g SAR limit).
- 4) Perform a third repeated measurement only if the original, first or second repeated measurement is  $\geq 1.5$  W/kg and the ratio of largest to smallest SAR for the original, first and second repeated measurements is  $> 1.20$ .

*Note: The same procedures should be adapted for measurements according to extremity and occupational exposure limits by applying a factor of 2.5 for extremity exposure and a factor of 5 for occupational exposure to the corresponding SAR thresholds.*

### The Highest Measured SAR Configuration in Each Frequency Band

#### Head(Face Up)

SAR probe calibration point	Frequency Band	Freq.(MHz)	EUT Position	Meas. SAR (W/kg)		Largest to Smallest SAR Ratio
				Original	Repeated	
/	/	/	/	/	/	/

#### Body(Body Back)

SAR probe calibration point	Frequency Band	Freq.(MHz)	EUT Position	Meas. SAR (W/kg)		Largest to Smallest SAR Ratio
				Original	Repeated	
/	/	/	/	/	/	/

#### Note:

1. Second Repeated Measurement is not required since the ratio of the largest to smallest SAR for the original and first repeated measurement is not  $> 1.20$ .
2. The measured SAR results **do not** have to be scaled to the maximum tune-up tolerance to determine if repeated measurements are required.
3. SAR measurement variability must be assessed for each frequency band, which is determined by the **SAR probe calibration point and tissue-equivalent medium** used for the device measurements.

## 10. SAR SIMULTANEOUS TRANSMISSION DESCRIPTION

### Simultaneous Transmission:

Description of Simultaneous Transmit Capabilities		
Transmitter Combination	Simultaneous?	Hotspot?
PTT + Bluetooth	√	×

### Simultaneous and Hotspot SAR test exclusion considerations:

Mode(SAR1+SAR2)	Position	Reported SAR(W/kg)		$\Sigma$ SAR < 1.6W/kg
		SAR1	SAR2	
PTT + Bluetooth	Face Up	0.29	0.12	0.41
	Body Back	0.31	0.11	0.42

### Conclusion:

Sum of SAR:  $\Sigma$ SAR  $\leq$  1.6 W/kg therefore simultaneous transmission SAR with Volume Scans is **not required**.



## 11. SAR PLOTS

Plot 1#: FM 12.5kHz\_462.6375MHz\_Face Up

**DUT: Digital Portable Radio; Type: BP516 LF; Serial: CR22060025-SA-S1**

Communication System: FM; Frequency: 462.637 MHz; Duty Cycle: 1:1

Medium parameters used:  $f = 462.637$  MHz;  $\sigma = 0.901$  S/m;  $\epsilon_r = 43.344$ ;  $\rho = 1000$  kg/m<sup>3</sup>

Phantom section: Flat Section

DASY5 Configuration:

- Probe: ES3DV2 - SN3019; ConvF(7.02, 7.02, 7.02) @ 462.637 MHz; Calibrated: 2021/12/13
- Sensor-Surface: 4mm (Mechanical Surface Detection)
- Electronics: DAE4 Sn1354; Calibrated: 2021/9/1
- Phantom: ELI v8.0; Type: QDOVA002AA; Serial: TP:2051
- Measurement SW: DASY52, Version 52.10 (2); SEMCAD X Version 14.6.12 (7470)

**Area Scan (71x121x1):** Interpolated grid:  $dx=1.500$  mm,  $dy=1.500$  mm

Maximum value of SAR (interpolated) = 0.552 W/kg

**Zoom Scan (5x5x4)/Cube 0:** Measurement grid:  $dx=8$ mm,  $dy=8$ mm,  $dz=5$ mm

Reference Value = 16.73 V/m; Power Drift = 0.18 dB

Peak SAR (extrapolated) = 0.670 W/kg

**SAR(1 g) = 0.546 W/kg; SAR(10 g) = 0.430 W/kg**

Maximum value of SAR (measured) = 0.568 W/kg

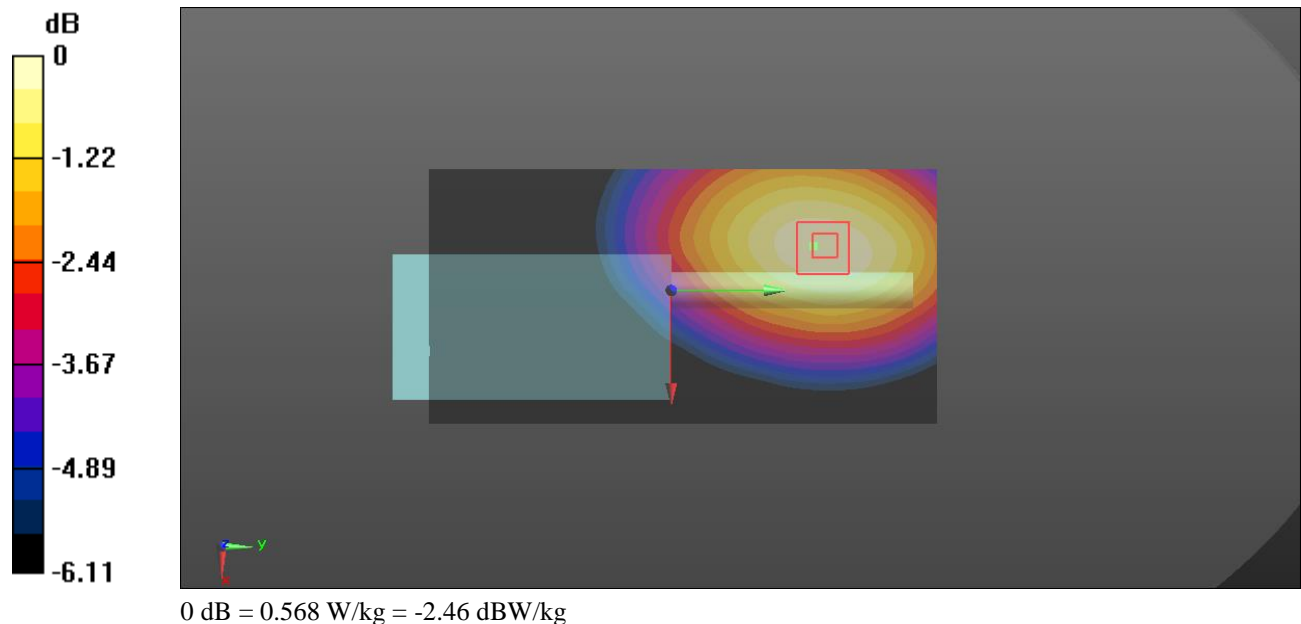

**Plot 2#: FM 12.5kHz\_467.6375MHz\_Face Up****DUT: Digital Portable Radio; Type: BP516 LF; Serial: CR22060025-SA-S1**

Communication System: FM; Frequency: 467.637 MHz; Duty Cycle: 1:1

Medium parameters used:  $f = 467.637$  MHz;  $\sigma = 0.905$  S/m;  $\epsilon_r = 43.263$ ;  $\rho = 1000$  kg/m<sup>3</sup>

Phantom section: Flat Section

DASY5 Configuration:

- Probe: ES3DV2 - SN3019; ConvF(7.02, 7.02, 7.02) @ 467.637 MHz; Calibrated: 2021/12/13
- Sensor-Surface: 4mm (Mechanical Surface Detection)
- Electronics: DAE4 Sn1354; Calibrated: 2021/9/1
- Phantom: ELI v8.0; Type: QDOVA002AA; Serial: TP:2051
- Measurement SW: DASY52, Version 52.10 (2); SEMCAD X Version 14.6.12 (7470)

**Area Scan (71x121x1):** Interpolated grid: dx=1.500 mm, dy=1.500 mm

Maximum value of SAR (interpolated) = 0.455 W/kg

**Zoom Scan (5x5x4)/Cube 0:** Measurement grid: dx=8mm, dy=8mm, dz=5mm

Reference Value = 13.66 V/m; Power Drift = 0.03 dB

Peak SAR (extrapolated) = 0.532 W/kg

**SAR(1 g) = 0.438 W/kg; SAR(10 g) = 0.345 W/kg**

Maximum value of SAR (measured) = 0.459 W/kg

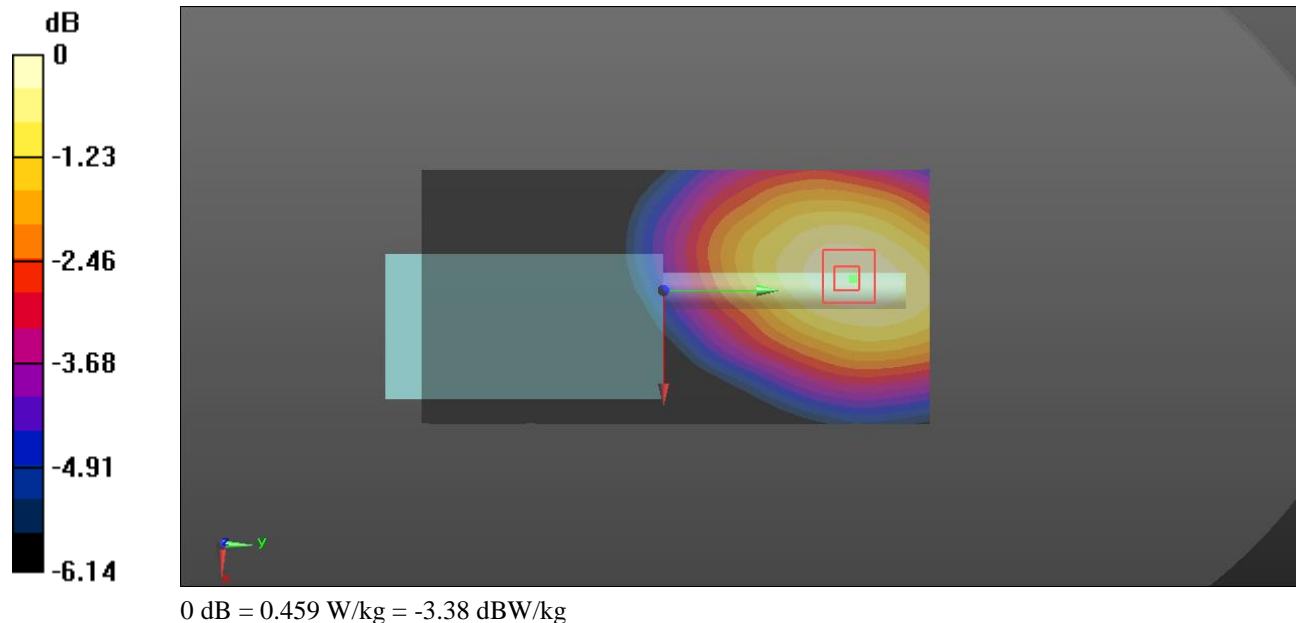

**Plot 3#: FM 12.5kHz\_462.6375MHz\_Body Back****DUT: Digital Portable Radio; Type: BP516 LF; Serial: CR22060025-SA-S1**

Communication System: FM; Frequency: 462.637 MHz; Duty Cycle: 1:1

Medium parameters used:  $f = 462.637$  MHz;  $\sigma = 0.901$  S/m;  $\epsilon_r = 43.344$ ;  $\rho = 1000$  kg/m<sup>3</sup>

Phantom section: Flat Section

DASY5 Configuration:

- Probe: ES3DV2 - SN3019; ConvF(7.02, 7.02, 7.02) @ 462.637 MHz; Calibrated: 2021/12/13
- Sensor-Surface: 4mm (Mechanical Surface Detection)
- Electronics: DAE4 Sn1354; Calibrated: 2021/9/1
- Phantom: ELI v8.0; Type: QDOVA002AA; Serial: TP:2051
- Measurement SW: DASY52, Version 52.10 (2); SEMCAD X Version 14.6.12 (7470)

**Area Scan (71x121x1):** Interpolated grid: dx=1.500 mm, dy=1.500 mm

Maximum value of SAR (interpolated) = 0.583 W/kg

**Zoom Scan (5x5x4)/Cube 0:** Measurement grid: dx=8mm, dy=8mm, dz=5mm

Reference Value = 17.06 V/m; Power Drift = 0.18 dB

Peak SAR (extrapolated) = 0.725 W/kg

**SAR(1 g) = 0.579 W/kg; SAR(10 g) = 0.446 W/kg**

Maximum value of SAR (measured) = 0.608 W/kg

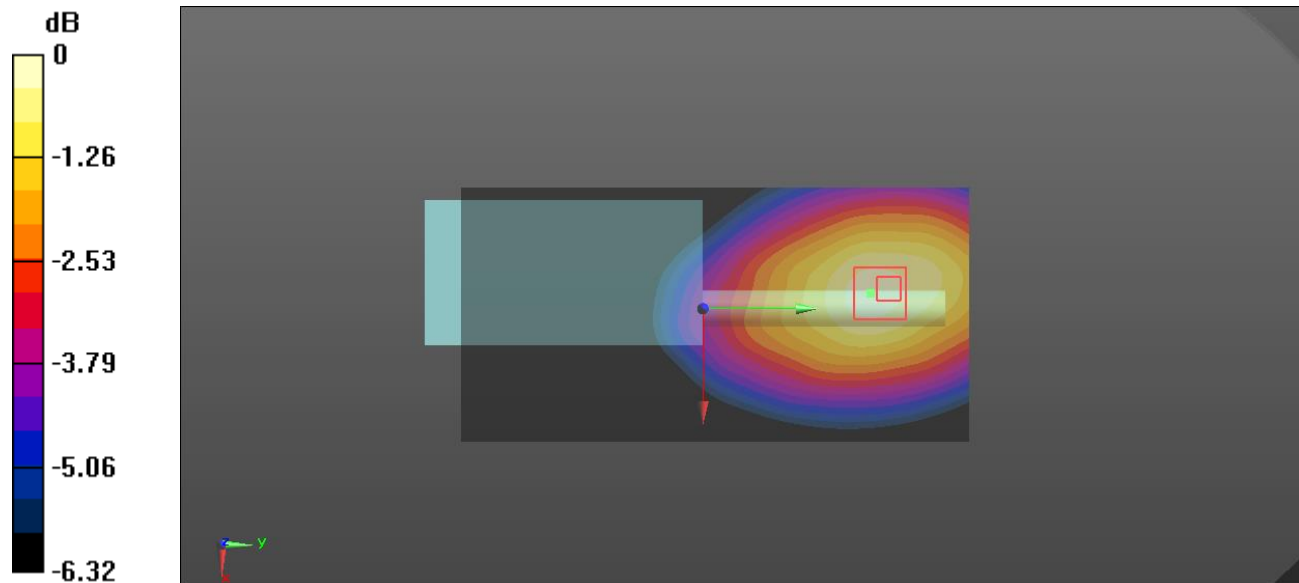

0 dB = 0.608 W/kg = -2.16 dBW/kg

**Plot 4#: FM 12.5kHz\_467.6375MHz\_Body Back****DUT: Digital Portable Radio; Type: BP516 LF; Serial: CR22060025-SA-S1**

Communication System: FM; Frequency: 467.637 MHz; Duty Cycle: 1:1

Medium parameters used:  $f = 467.637$  MHz;  $\sigma = 0.905$  S/m;  $\epsilon_r = 43.263$ ;  $\rho = 1000$  kg/m<sup>3</sup>

Phantom section: Flat Section

DASY5 Configuration:

- Probe: ES3DV2 - SN3019; ConvF(7.02, 7.02, 7.02) @ 467.637 MHz; Calibrated: 2021/12/13
- Sensor-Surface: 4mm (Mechanical Surface Detection)
- Electronics: DAE4 Sn1354; Calibrated: 2021/9/1
- Phantom: ELI v8.0; Type: QDOVA002AA; Serial: TP:2051
- Measurement SW: DASY52, Version 52.10 (2); SEMCAD X Version 14.6.12 (7470)

**Area Scan (71x121x1):** Interpolated grid: dx=1.500 mm, dy=1.500 mm

Maximum value of SAR (interpolated) = 0.553 W/kg

**Zoom Scan (5x5x4)/Cube 0:** Measurement grid: dx=8mm, dy=8mm, dz=5mm

Reference Value = 17.06 V/m; Power Drift = 0.06 dB

Peak SAR (extrapolated) = 0.666 W/kg

**SAR(1 g) = 0.533 W/kg; SAR(10 g) = 0.412 W/kg**

Maximum value of SAR (measured) = 0.563 W/kg

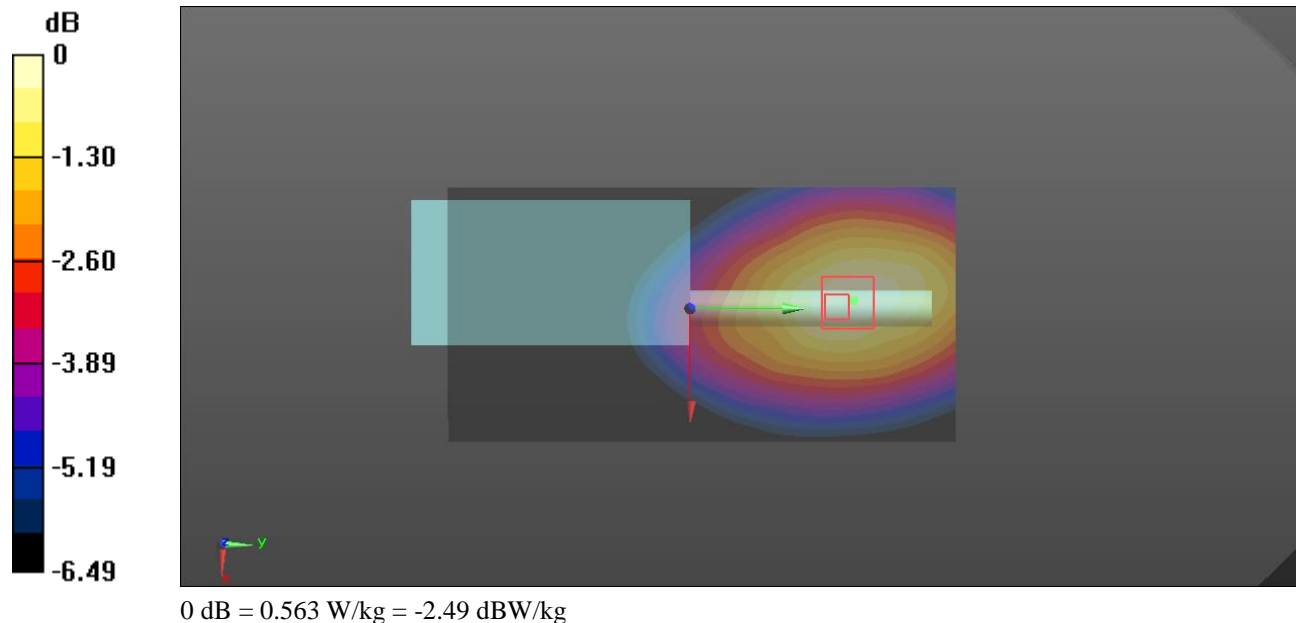

## APPENDIX A MEASUREMENT UNCERTAINTY

The uncertainty budget has been determined for the measurement system and is given in the following Table.

Measurement uncertainty evaluation for IEEE1528-2013 SAR test

Source of uncertainty	Tolerance/ uncertainty ± %	Probability distribution	Divisor	ci (1 g)	ci (10 g)	Standard uncertainty ± %, (1 g)	Standard uncertainty ± %, (10 g)
<b>Measurement system</b>							
Probe calibration	6.55	N	1	1	1	6.3	6.3
Axial Isotropy	4.7	R	$\sqrt{3}$	1	1	2.7	2.7
Hemispherical Isotropy	9.6	R	$\sqrt{3}$	0	0	0.0	0.0
Boundary effect	1.0	R	$\sqrt{3}$	1	1	0.6	0.6
Linearity	4.7	R	$\sqrt{3}$	1	1	2.7	2.7
Detection limits	1.0	R	$\sqrt{3}$	1	1	0.6	0.6
Readout electronics	0.3	N	1	1	1	0.3	0.3
Response time	0.0	R	$\sqrt{3}$	1	1	0.0	0.0
Integration time	0.0	R	$\sqrt{3}$	1	1	0.0	0.0
RF ambient conditions – noise	1.0	R	$\sqrt{3}$	1	1	0.6	0.6
RF ambient conditions– reflections	1.0	R	$\sqrt{3}$	1	1	0.6	0.6
Probe positioner mech. Restrictions	0.8	R	$\sqrt{3}$	1	1	0.5	0.5
Probe positioning with respect to phantom shell	6.7	R	$\sqrt{3}$	1	1	3.9	3.9
Post-processing	2.0	R	$\sqrt{3}$	1	1	1.2	1.2
<b>Test sample related</b>							
Test sample positioning	2.8	N	1	1	1	2.8	2.8
Device holder uncertainty	6.3	N	1	1	1	6.3	6.3
Drift of output power	5.0	R	$\sqrt{3}$	1	1	2.9	2.9
<b>Phantom and set-up</b>							
Phantom uncertainty (shape and thickness tolerances)	4.0	R	$\sqrt{3}$	1	1	2.3	2.3
Liquid conductivity target)	5.0	R	$\sqrt{3}$	0.64	0.43	1.8	1.2
Liquid conductivity meas.)	2.5	N	1	0.64	0.43	1.6	1.1
Liquid permittivity target)	5.0	R	$\sqrt{3}$	0.6	0.49	1.7	1.4
Liquid permittivity meas.)	2.5	N	1	0.6	0.49	1.5	1.2
Combined standard uncertainty		RSS				12.2	12.0
Expanded uncertainty 95 % confidence interval)						24.1	23.7

## Measurement uncertainty evaluation for IEC62209-1 SAR test

Source of uncertainty	Tolerance/ uncertainty ± %	Probability distribution	Divisor	ci (1 g)	ci (10 g)	Standard uncertainty ± %, (1 g)	Standard uncertainty ± %, (10 g)
<b>Measurement system</b>							
Probe calibration	6.55	N	1	1	1	6.3	6.3
Axial Isotropy	4.7	R	$\sqrt{3}$	1	1	2.7	2.7
Hemispherical Isotropy	9.6	R	$\sqrt{3}$	0	0	0.0	0.0
Boundary effect	1.0	R	$\sqrt{3}$	1	1	0.6	0.6
Linearity	4.7	R	$\sqrt{3}$	1	1	2.7	2.7
Detection limits	1.0	R	$\sqrt{3}$	1	1	0.6	0.6
Readout electronics	0.3	N	1	1	1	0.3	0.3
Response time	0.0	R	$\sqrt{3}$	1	1	0.0	0.0
Integration time	0.0	R	$\sqrt{3}$	1	1	0.0	0.0
RF ambient conditions – noise	1.0	R	$\sqrt{3}$	1	1	0.6	0.6
Probe positioning with respect to phantom shell	6.7	R	$\sqrt{3}$	1	1	3.9	3.9
Probe positioner mech. Restrictions	0.8	R	$\sqrt{3}$	1	1	0.5	0.5
RF ambient conditions– reflections	1.0	R	$\sqrt{3}$	1	1	0.6	0.6
Post-processing	2.0	R	$\sqrt{3}$	1	1	1.2	1.2
<b>Test sample related</b>							
Test sample positioning	2.8	N	1	1	1	2.8	2.8
Device holder uncertainty	6.3	N	1	1	1	6.3	6.3
Drift of output power	5.0	R	$\sqrt{3}$	1	1	2.9	2.9
<b>Phantom and set-up</b>							
Phantom uncertainty (shape and thickness tolerances)	4.0	R	$\sqrt{3}$	1	1	2.3	2.3
Liquid conductivity target)	5.0	R	$\sqrt{3}$	0.64	0.43	1.8	1.2
Liquid conductivity meas.)	2.5	N	1	0.64	0.43	1.6	1.1
Liquid permittivity target)	5.0	R	$\sqrt{3}$	0.6	0.49	1.7	1.4
Liquid permittivity meas.)	2.5	N	1	0.6	0.49	1.5	1.2
Combined standard uncertainty		RSS				12.2	12.0
Expanded uncertainty 95 % confidence interval)						24.0	23.6

## APPENDIX B EUT TEST POSITION PHOTOS

Liquid depth  $\geq 15\text{cm}$

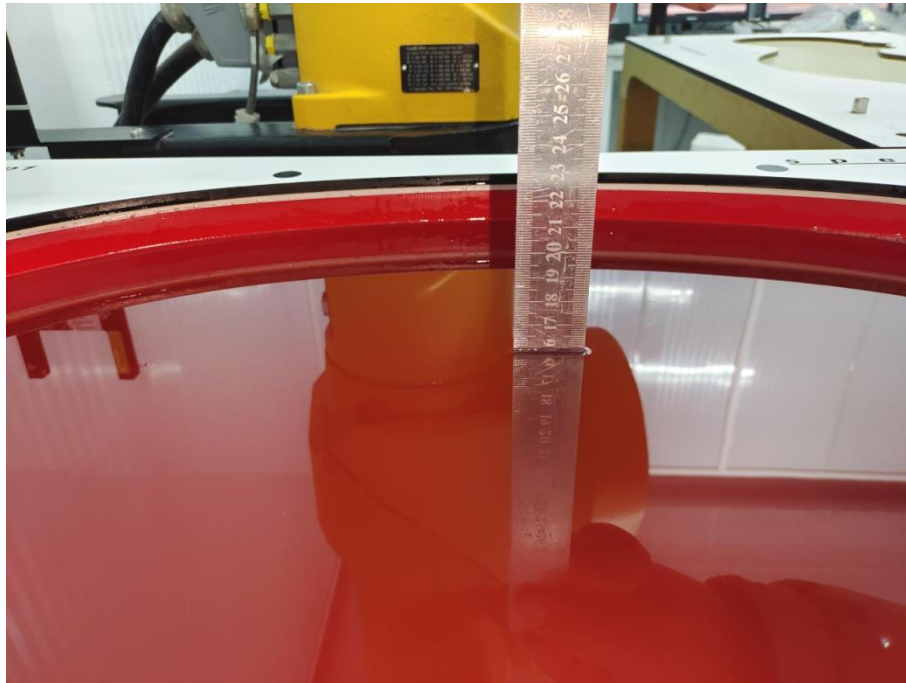

**Face Up Setup Photo (25mm)**

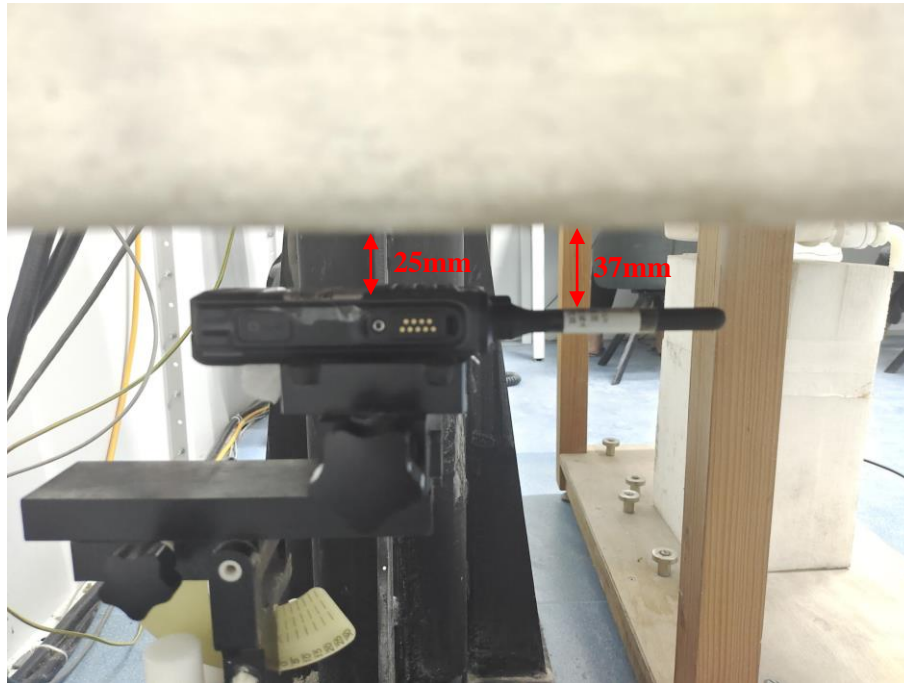

**Body Back Setup Photo (0mm)**

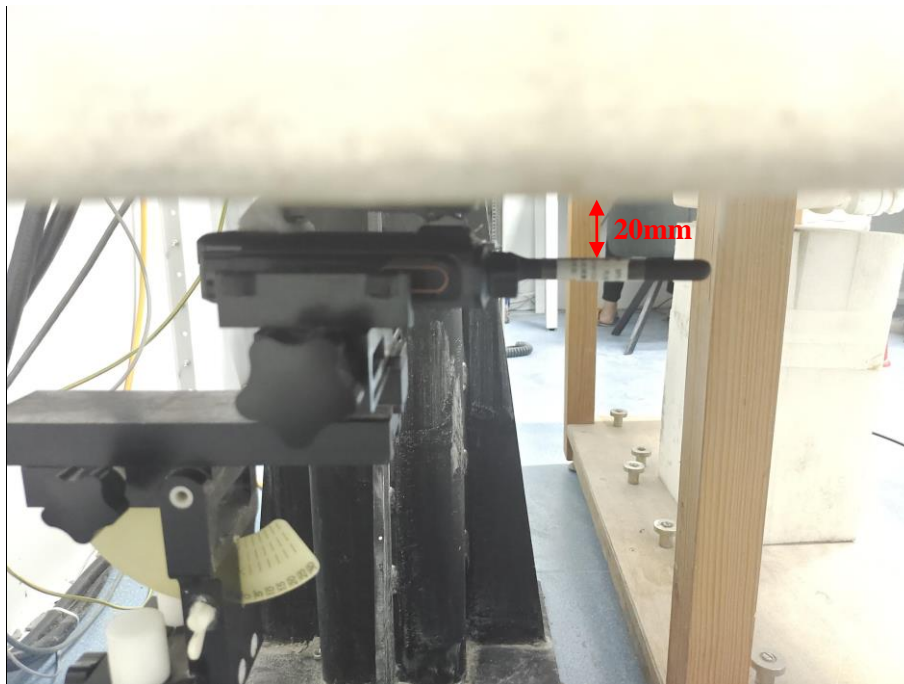



---

## **APPENDIX C CALIBRATION CERTIFICATES**

---

**Please Refer to the Attachment.**

**\*\*\*\*\* END OF REPORT \*\*\*\*\***