

<b>Prüfbericht-Nr.:</b> <i>Test Report No.:</i>	50104142 001	<b>Auftrags-Nr.:</b> <i>Order No.:</i>	114068357	<b>Seite 1 von 32</b> <i>Page 1 of 32</i>	
<b>Kunden-Referenz-Nr.:</b> <i>Client Reference No.:</i>	N/A	<b>Auftragsdatum:</b> <i>Order date:</i>	17-Aug-2017		
<b>Auftraggeber:</b> <i>Client:</i>	InnoComm Mobile Technology Corp. 3F, No. 6, Hsin Ann Rd., Hsinchu Science Park, TW-30078 Hsinchu, Taiwan, R.O.C.				
<b>Prüfgegenstand:</b> <i>Test item:</i>	BLE Single Mode Module				
<b>Bezeichnung / Typ-Nr.:</b> <i>Identification / Type No.:</i>	BM10_AN R2				
<b>Auftrags-Inhalt:</b> <i>Order content:</i>	FCC Part15C / IC RSS-247 Test report (BLE)				
<b>Prüfgrundlage:</b> <i>Test specification:</i>	FCC 47CFR Part 15: Subpart C Section 15.247 RSS-247 (02-2017)				
<b>Wareneingangsdatum:</b> <i>Date of receipt:</i>	21-Aug-2017				
<b>Prüfmuster-Nr.:</b> <i>Test sample No.:</i>	A000606121-001 A000606121-002				
<b>Prüfzeitraum:</b> <i>Testing period:</i>	07-Sep-2017 - 11-Oct-2017				
<b>Ort der Prüfung:</b> <i>Place of testing:</i>	EMC/RF Laboratory Taipei				
<b>Prüflaboratorium:</b> <i>Testing laboratory:</i>	TUV Rheinland Taiwan Ltd.				
<b>Prüfergebnis*:</b> <i>Test result*:</i>	Pass				
<b>Report Date / tested by:</b>			<b>kontrolliert von / reviewed by:</b>		
17-Oct-2017 Jack Chang /Project Manager			17-Oct-2017 Arvin Ho/Vice General Manager		
<b>Datum</b> <i>Date</i>	<b>Name / Stellung</b> <i>Name / Position</i>	<b>Unterschrift</b> <i>Signature</i>	<b>Datum</b> <i>Date</i>	<b>Name / Stellung</b> <i>Name / Position</i>	<b>Unterschrift</b> <i>Signature</i>
<b>Sonstiges / Other:</b>					
<b>Zustand des Prüfgegenstandes bei Anlieferung:</b> <i>Condition of the test item at delivery:</i>			Prüfmuster vollständig und unbeschädigt <i>Test item complete and undamaged</i>		
* Legende: 1 = sehr gut    2 = gut    3 = befriedigend    4 = ausreichend    5 = mangelhaft P(ass) = entspricht o.g. Prüfgrundlage(n)    F(ail) = entspricht nicht o.g. Prüfgrundlage(n)    N/A = nicht anwendbar    N/T = nicht getestet					
Legend: 1 = very good    2 = good    3 = satisfactory    4 = sufficient    5 = poor P(ass) = passed a.m. test specification(s)    F(ail) = failed a.m. test specification(s)    N/A = not applicable    N/T = not tested					
<b>Dieser Prüfbericht bezieht sich nur auf das o.g. Prüfmuster und darf ohne Genehmigung der Prüfstelle nicht auszugsweise vervielfältigt werden. Dieser Bericht berechtigt nicht zur Verwendung eines Prüfzeichens.</b> <i>This test report only relates to the a. M. Test sample. Without permission of the test center this test report is not permitted to be duplicated in extracts. This test report does not entitle to carry any test mark.</i>					

## TEST SUMMARY

### **5.1.1 ANTENNA REQUIREMENT**

*RESULT: Passed*

### **5.1.2 PEAK OUTPUT POWER**

*RESULT: Passed*

### **5.1.3 6dB BANDWIDTH 99% BANDWIDTH**

*RESULT: Passed*

### **5.1.4 POWER DENSITY**

*RESULT: Passed*

### **5.1.5 CONDUCTED SPURIOUS EMISSIONS AND FREQUENCY BAND EDGE MEASURED IN 100KHz BANDWIDTH**

*RESULT: Passed*

### **5.1.6 SPURIOUS EMISSION**

*RESULT: Passed*

### **6.1.1 ELECTROMAGNETIC FIELDS**

*RESULT: Passed*

## Contents

<b>1.</b>	<b>GENERAL REMARKS .....</b>	<b>5</b>
<b>1.1</b>	<b>COMPLEMENTARY MATERIALS.....</b>	<b>5</b>
<b>2.</b>	<b>TEST SITES .....</b>	<b>6</b>
<b>2.1</b>	<b>TEST FACILITY.....</b>	<b>6</b>
<b>2.2</b>	<b>LIST OF TEST AND MEASUREMENT INSTRUMENTS.....</b>	<b>7</b>
<b>2.3</b>	<b>TRACEABILITY .....</b>	<b>8</b>
<b>2.4</b>	<b>CALIBRATION .....</b>	<b>8</b>
<b>2.5</b>	<b>MEASUREMENT UNCERTAINTY .....</b>	<b>8</b>
<b>3.</b>	<b>GENERAL PRODUCT INFORMATION.....</b>	<b>9</b>
<b>3.1</b>	<b>PRODUCT FUNCTION AND INTENDED USE .....</b>	<b>9</b>
<b>3.2</b>	<b>SYSTEM DETAILS AND RATINGS.....</b>	<b>9</b>
<b>3.3</b>	<b>INDEPENDENT OPERATION MODES.....</b>	<b>10</b>
<b>3.4</b>	<b>NOISE GENERATING AND NOISE SUPPRESSING PARTS .....</b>	<b>10</b>
<b>3.5</b>	<b>SUBMITTED DOCUMENTS.....</b>	<b>10</b>
<b>4.</b>	<b>TEST SET-UP AND OPERATION MODES.....</b>	<b>11</b>
<b>4.1</b>	<b>PRINCIPLE OF CONFIGURATION SELECTION .....</b>	<b>11</b>
<b>4.2</b>	<b>TEST OPERATION AND TEST SOFTWARE.....</b>	<b>11</b>
<b>4.3</b>	<b>SPECIAL ACCESSORIES AND AUXILIARY EQUIPMENT .....</b>	<b>11</b>
<b>4.4</b>	<b>COUNTERMEASURES TO ACHIEVE EMC COMPLIANCE.....</b>	<b>12</b>
<b>4.5</b>	<b>TEST SETUP DIAGRAM .....</b>	<b>12</b>
<b>5.</b>	<b>TEST RESULTS .....</b>	<b>15</b>
<b>5.1</b>	<b>TRANSMITTER REQUIREMENT &amp; TEST SUITES .....</b>	<b>15</b>
5.1.1	<i>Antenna Requirement .....</i>	<i>15</i>
5.1.2	<i>Peak Output Power.....</i>	<i>16</i>
5.1.3	<i>6dB Bandwidth 99% Bandwidth.....</i>	<i>18</i>
5.1.4	<i>Power Density.....</i>	<i>27</i>
5.1.5	<i>Conducted spurious emissions and Frequency Band Edge measured in 100kHz Bandwidth.....</i>	<i>31</i>
5.1.6	<i>Spurious Emission .....</i>	<i>37</i>
<b>6.</b>	<b>SAFETY HUMAN EXPOSURE .....</b>	<b>38</b>
<b>6.1</b>	<b>RADIO FREQUENCY EXPOSURE COMPLIANCE .....</b>	<b>38</b>
6.1.1	<i>Electromagnetic Fields.....</i>	<i>38</i>
<b>7.</b>	<b>PHOTOGRAPHS OF THE TEST SET-UP.....</b>	<b>39</b>

<b>8.</b>	<b>LIST OF TABLES .....</b>	<b>42</b>
<b>9.</b>	<b>LIST OF PHOTOGRAPHS.....</b>	<b>42</b>

## 1. General Remarks

### 1.1 Complementary Materials

These attachments are integral parts of this test report:

**Appendix P: Photo Documentation internal view**  
(File Name: 50104142APPENDIX P)

**Appendix D: Test Result of Radiated Emissions**  
(File Name: 50104142APPENDIX D)

Test Specifications

The following standards were applied.

#### Table 1: Applied Standard and Test Levels

Radio
FCC CFR47 Part 15: Subpart C Section 15.247
RSS-247 Issue 2 (Feb 2017)
RSS-Gen, Issue 4, November 2014
ANSI C63.10:2013
KDB558074 D01 DTS Meas Guidance v03r05

## 2. Test Sites

### 2.1 Test Facility

TUV Rheinland Taiwan Ltd.  
Taipei Office

11F. No.758, Sec. 4, Bade Rd., Songshan Dist.  
Taipei City 105  
Taiwan (R.O.C.)

FCC RegistrationNo.: 340738  
IC Canada Registration No.: 9465A-1  
TAF Accredited NCC Test Lab. No.:0759  
TAF ISO17025 Certification effective periods: 2016-Jul-1<sup>st</sup> to 2019-Jun-30<sup>th</sup>



**Testing Laboratory**  
**0759**

## 2.2 List of Test and Measurement Instruments

**Table 2: List of Test and Measurement Equipment**

Kind of Equipment	Manu-facturer	Type	S/N	Last Calibration	Next Calibration
Test Software	Farad	EZ_EMG	Ver. TUV3A1	N/A	N/A
EMI Test Receiver	R&S	ESR7	101062	2017/09/25	2018/09/25
EMI Test Receiver	R&S	ESR7	101549	2016/09/22	2017/09/22
Spectrum Analyzer	R&S	FSV 40	100921	2017/05/02	2018/05/01
Spectrum Analyzer	Agilent	N9010A	MY53470241	2017/05/23	2018/05/22
Preamplifier (30MHz -1GHz)	HP	8447F	2805A03335	2017/08/14	2018/08/14
Preamplifier (18 GHz -40 GHz)	COM-POWER	PAM-840	461257	2016/12/01	2017/12/01
Pre-Amplifier (1GHz~18GHz)	EM Electronics	EM01G18G	060558	2016/11/17	2017/11/17
Bilog Antenna	TESEQ	CBL6111D	29802	2017/07/12	2018/07/12
Horn Antenna	ETS-Lindgren	3117	138160	2017/05/25	2018/05/25
Horn Antenna (18GHz~40GHz)	COM-POWER	AH-840	101031	2016/11/22	2017/11/22
Loop Antenna	Schwarzbeck	FMZB 1513	1513-076	2017/06/14	2018/06/14
EMI Test Receiver	R&S	ESCI7	100797	2016/12/30	2017/12/30
Bluetooth Tester	R&S	CBT	100866	2017/03/09	2018/03/08
Temp. & Humid. Chamber	Giant Force	GCT-099-40-S	MAF0103-007	2017/05/24	2018/05/24
Test Software	Audix	e3	Ver. 9	N/A	N/A
Test Software	Agilent	300328 testsystem	V2.1.1	N/A	N/A
Power sensor	Agilent	U2021XA	MY54020001	2017/03/08	2018/03/07

## 2.3 Traceability

All measurement equipment calibrations are traceable to NML(Taiwan)/NIST(USA) or where calibration is performed outside Taiwan, to equivalent nationally recognized standards organizations.

## 2.4 Calibration

Equipment requiring calibration is calibrated periodically in a suitably accredited Calibration Lab. Additionally all equipment is verified for proper performance on a regular schedule using in house standards or comparisons.

## 2.5 Measurement Uncertainty

The estimated combined standard uncertainty for radiated emissions and conducted emissions measurements.

**Table 3: Emission Measurement Uncertainty**

Parameter	Uncertainty
Radio Frequency	$\pm 1 \times 10^{-7}$
RF power, conducted	$\pm 1.5$ dB
RF power density, conducted	$\pm 3$ dB
spurious emissions, conducted	$\pm 3$ dB
all emissions, radiated	$\pm 6$ dB
Temperature	$\pm 1$ °C
Humidity	$\pm 5$ %
DC and low frequency voltages	$\pm 3$ %



### 3. General Product Information

#### 3.1 Product Function and Intended Use

The EUT is a Bluetooth Low Energy module. It is a Bluetooth (BLE5.0) compatible module enabling the user to communicate data through a Wireless interface.

For details refer to the User Guide, Data Sheet and Circuit Diagram.

#### 3.2 System Details and Ratings

**Table 4: Basic Information of EUT**

Item	EUT information
Kind of Equipment	BLE Single Mode Module
Type Designation	BM10_AN R2
FCC ID	YAIBM10R2
Brand Name	InnoComm Mobile

**Table 5: Technical Specification of EUT**

Technical Specification	Value
Operating Frequencies	2402~2480 MHz
Channel Spacing	2 MHz
Channel number	40
Operation Voltage	5V
Modulation	GFSK
Antenna gain	0.98 dBi

### **3.3 Independent Operation Modes**

Basic operation modes are:

- A. Transmitting
  - 1. Low channel
  - 2. Middle channel
  - 3. High channel
- B. Receiving
- C. Standby
- D. Off

### **3.4 Noise Generating and Noise Suppressing Parts**

Refer to the Circuit Diagram.

### **3.5 Submitted Documents**

- Circuit Diagram
- Instruction Manual
- Rating Label
- Technical Description

## 4. Test Set-up and Operation Modes

### 4.1 Principle of Configuration Selection

The equipment under test (EUT) was configured to measure its maximum power level. The test modes were adapted accordingly in reference to the instructions for use.

### 4.2 Test Operation and Test Software

Setup for testing: The EUT is a Bluetooth Low Energy module. It is a Bluetooth (BLE5.0) compatible module enabling the user to communicate data through a Wireless interface.

This software was running on the laptop computer connected to the EUT. It was used to enable the operation modes listed in section 3.3 as appropriate.

The samples were used as follows:

Conducted: **A000606121-001**

Radiation: **A000606121-002**

Full test was applied on all test modes, but only worst case was shown

### 4.3 Special Accessories and Auxiliary Equipment

The product has been tested together with the following additional accessories:

Description	Manufacturer	Model No.	Serial No.
Notebook(EMC-06)	Lenovo	TP00048A	PB-0F8B2

## 4.4 Countermeasures to achieve EMC Compliance

The test sample which has been tested contained the noise suppression parts as described in the Constructional Data Form or the Technical Construction File. No additional measures were employed to achieve compliance.

## 4.5 Test Setup Diagram

### Diagram of Measurement Configuration for Radiation Test

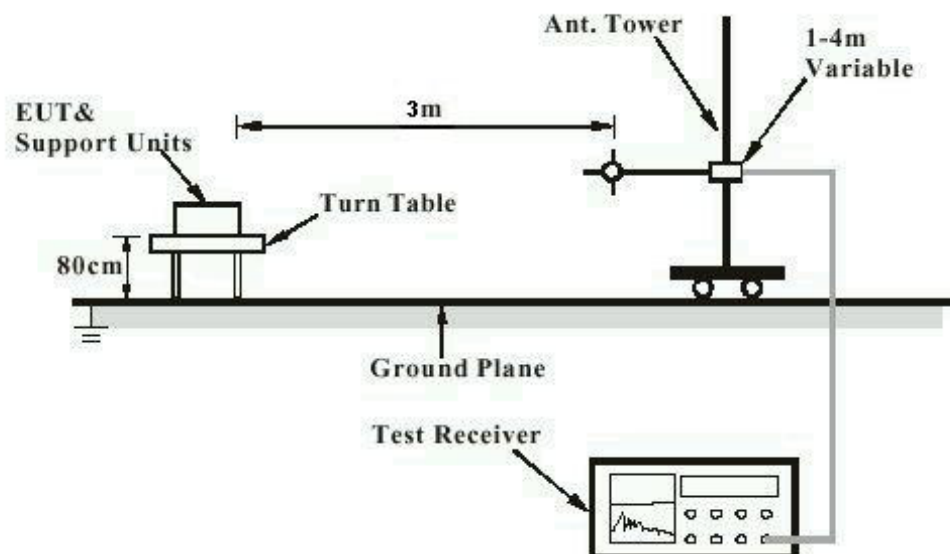

Note: Measurements above 1 GHz are done with a table height of 1.5m

**Diagram of Measurement Equipment Configuration for Mains Conduction Measurement (if applicable)**

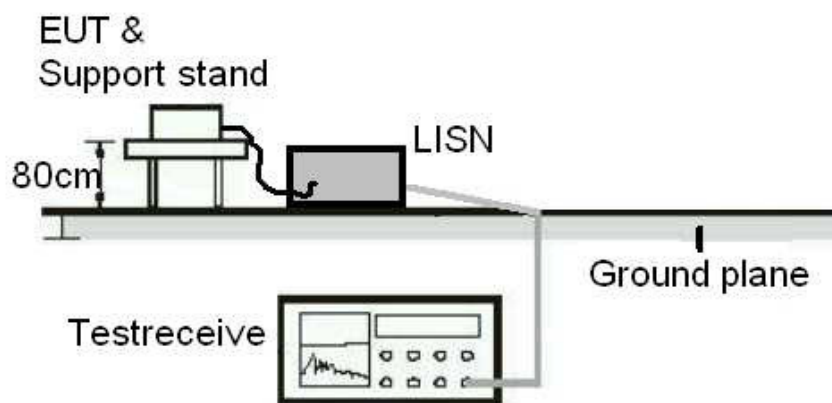

**Diagram of Measurement Equipment Configuration for Conducted Transmitter Measurement**

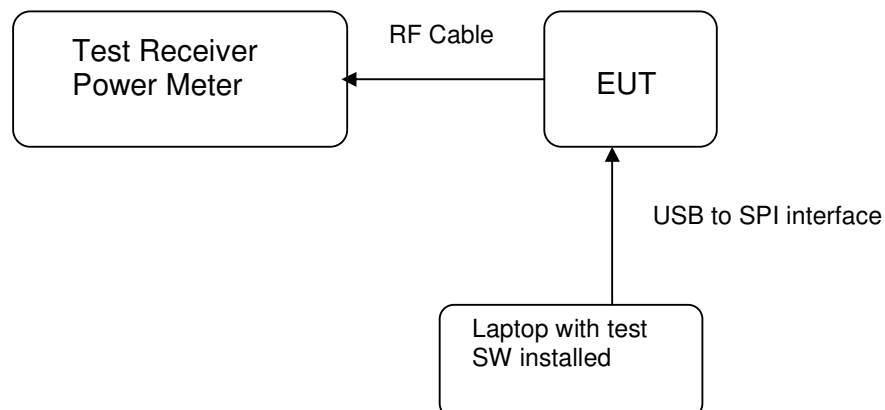

**Diagram of Measurement Equipment Configuration for Conducted Transmitter Measurement (Power meter)**

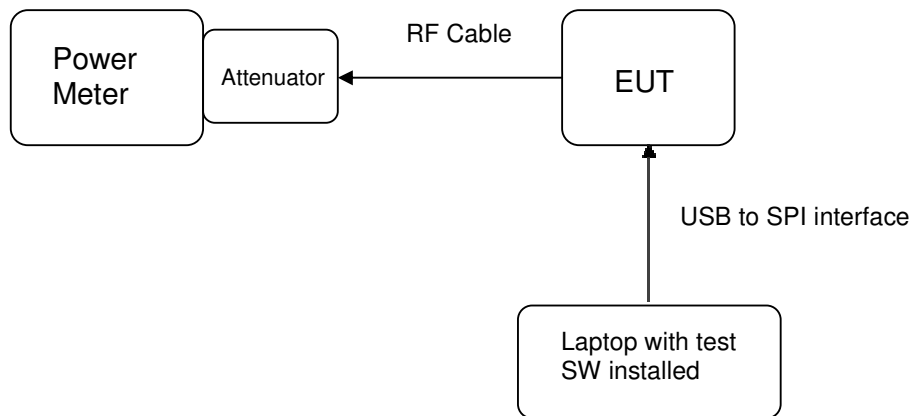

## 5. Test Results

### 5.1 Transmitter Requirement & Test Suites

#### 5.1.1 Antenna Requirement

**RESULT:** **Passed**

Test standard	:	LP0002(2016): 2.2, 3.10.1,3 FCC Part 15.247(b)(4), Part 15.203 and RSS- Gen 8.3
Requirement	:	use of approved antennas only with directional gains that do not exceed 6 dBi

According to the manufacturer declaration, the EUT has an antenna with a directional gain of 0.98 dBi. The antenna is PCB Antenna with no possibility of replacement with a non-approved antenna by the end-user. Therefore, the EUT is considered to comply with this provision.

Refer to EUT photo for details.

## 5.1.2 Peak Output Power

**RESULT:**
**Passed**

Test standard : LP0002(2016): 3.10.1, 2  
 FCC Part 15.247(b)(3), RSS-247 5.4(4)  
 Basic standard : ANSI C63.10:2013, KDB558074  
 Limit : 1 Watt  
 Kind of test site : Shielded room

**Test setup**

Test Channel : Low/ Middle/ High  
 Operation Mode : A  
 Ambient temperature : 20-24°C  
 Relative humidity : 50-65 %  
 Atmospheric pressure : 100-103 kPa

**Table 6: Test result of Peak Output Power (1M)**

Channel	Channel Frequency (MHz)	Output Power		Limit
		(dBm)	(W)	(W)
Low Channel	2402	5.13	0.00326	1
Middle Channel	2440	4.92	0.00310	1
High Channel	2480	4.72	0.00296	1

Pmax: 3.26 mW

**Table 7: Test result of AVG Output Power (1M)**

Channel	Channel Frequency (MHz)	Output Power		Limit
		(dBm)	(W)	(W)
Low Channel	2402	3.01	0.00200	1
Middle Channel	2440	2.81	0.00191	1
High Channel	2480	2.59	0.00182	1

Pmax: 2.00 mW



**Table 8: Test result of Peak Output Power (2M)**

Channel	Channel Frequency (MHz)	Output Power		Limit
		(dBm)	(W)	(W)
Low Channel	2402	5.09	0.00323	1
Middle Channel	2440	4.91	0.00310	1
High Channel	2480	4.71	0.00296	1

Pmax: 3.23 mW

**Table 9: Test result of AVG Output Power (2M)**

Channel	Channel Frequency (MHz)	Output Power		Limit
		(dBm)	(W)	(W)
Low Channel	2402	1.36	0.00137	1
Middle Channel	2440	1.14	0.00130	1
High Channel	2480	0.94	0.00124	1

Pmax: 1.37 mW

### 5.1.3 6dB Bandwidth 99% Bandwidth

**RESULT:**
**Passed**

Test standard : LP0002(2016): 3.10.1,6 (2)(A)  
 FCC Part 15.247(a)(2), RSS-247 5.2(1)  
 Basic standard : ANSI C63.10:2013, KDB558074  
 Kind of test site : Shielded room

**Test setup**

Test Channel : Low/ Middle/ High  
 Operation Mode : A  
 Ambient temperature : 20-24°C  
 Relative humidity : 50-65 %  
 Atmospheric pressure : 100-103 kPa

**Table 10: Test result of 6dB Bandwidth (1M)**

Channel	Channel Frequency (MHz)	6dB Bandwidth (kHz)	Limit (kHz)	Result
Low Channel	2402	694.4	>500	Pass
Mid Channel	2440	718.1	>500	Pass
High Channel	2480	722.8	>500	Pass

**Table 11: Test result of 6dB Bandwidth (2M)**

Channel	Channel Frequency (MHz)	6dB Bandwidth (kHz)	Limit (kHz)	Result
Low Channel	2402	1396	>500	Pass
Mid Channel	2440	1411	>500	Pass
High Channel	2480	1444	>500	Pass

**Table 12: Test result of 99% Bandwidth, 1M**

Channel	Channel Frequency (MHz)	99% Bandwidth (MHz)
Low Channel	2402	1.0375
Mid Channel	2440	1.0533
High Channel	2480	1.0501

**Table 13: Test result of 99% Bandwidth, 2M**

Channel	Channel Frequency (MHz)	99% Bandwidth (MHz)
Low Channel	2402	2.0546
Mid Channel	2440	2.0791
High Channel	2480	2.0794

## Test Plot of 6dB Bandwidth (1M)

### Low Channel

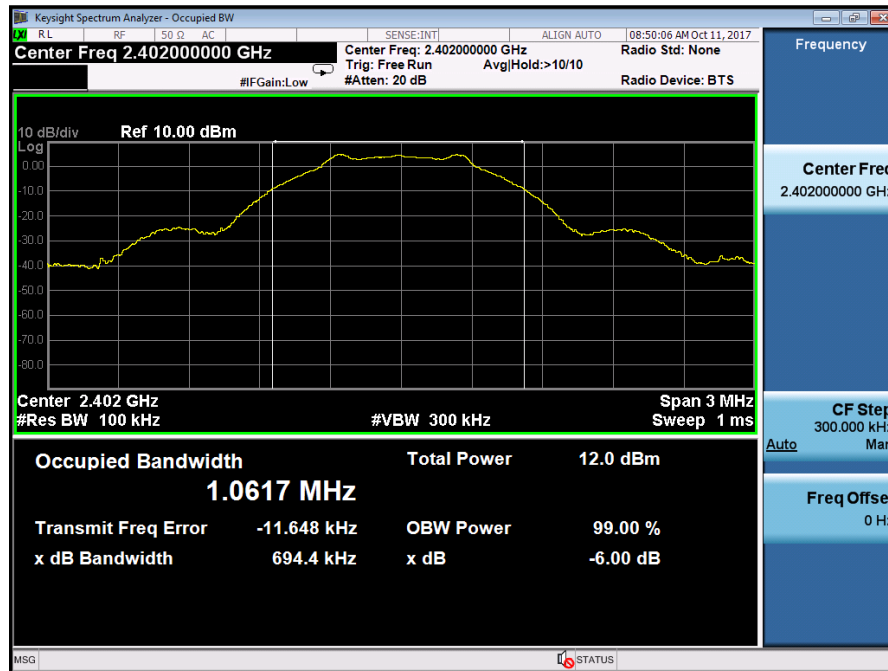

### Middle Channel

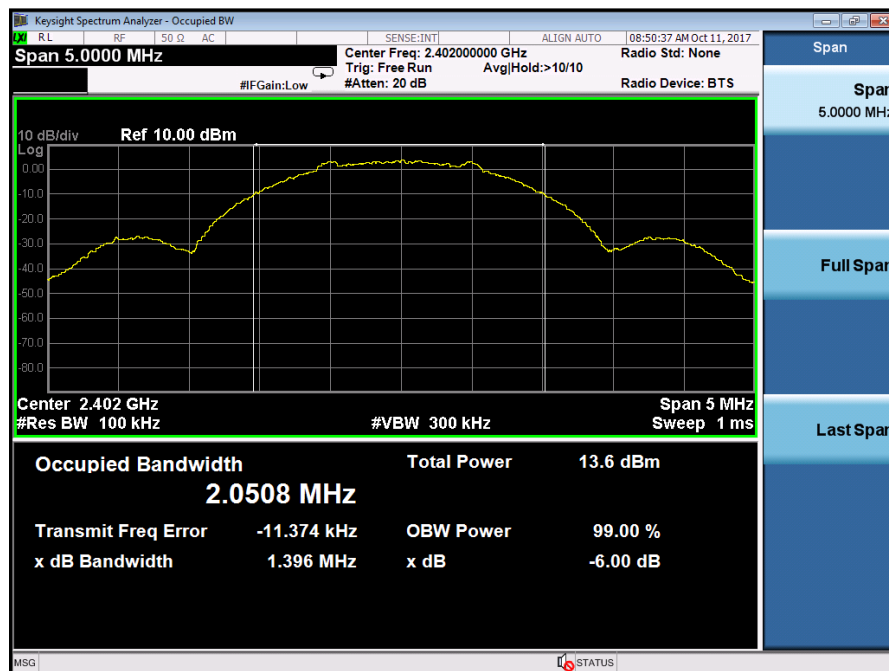

**High Channel**

**Test Plot of 6dB Bandwidth (2M)**
**Low Channel**

**Middle Channel**

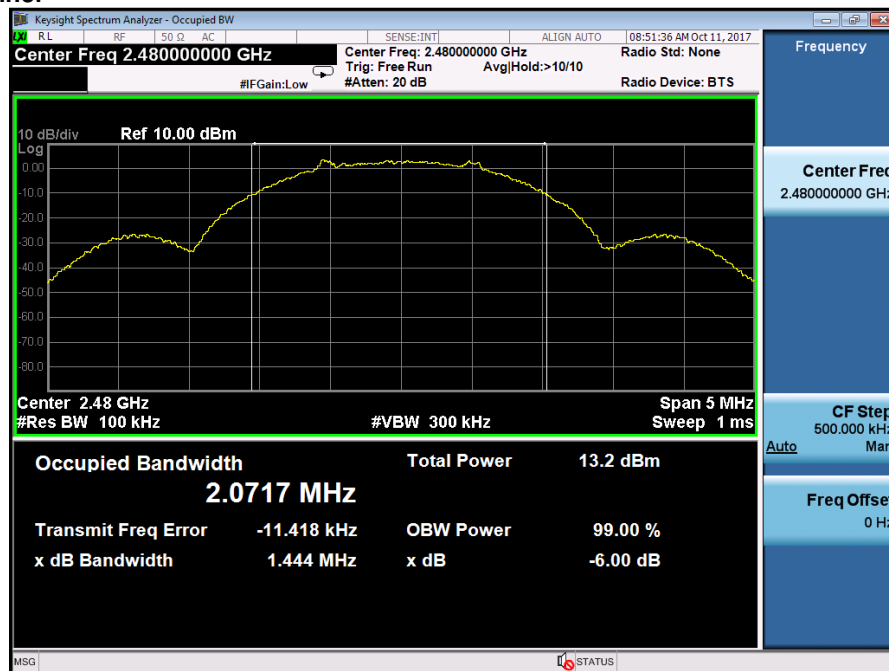
**High Channel**

## Test Plot of 99% Bandwidth 1M

### Low Channel



### Middle Channel

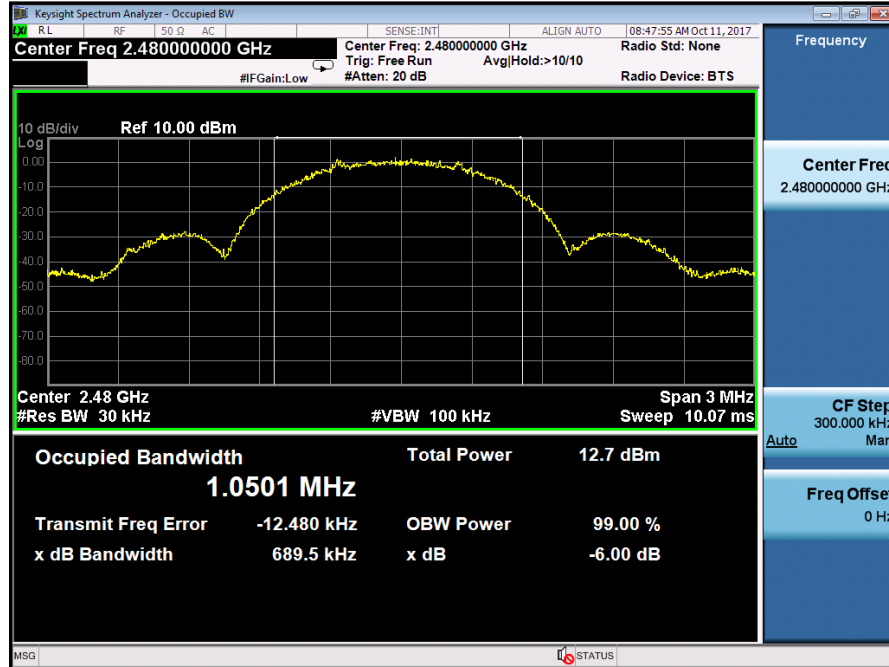

**High Channel**



## Test Plot of 99% Bandwidth 2M

### Low Channel



### Middle Channel



**High Channel**

### 5.1.4 Power Density

**RESULT:**
**Passed**

Test standard : LP0002(2016): 3.10.1,6 (2)(B)  
 FCC Part 15.247(e) , RSS-247 5.2(2)  
 Basic standard : ANSI C63.10:2013, KDB558074  
 Kind of test site : Shielded room

**Test setup**

Test Channel : Low/ Middle/ High  
 Operation Mode : A  
 Ambient temperature : 20-24°C  
 Relative humidity : 50-65 %  
 Atmospheric pressure : 100-103 kPa

**Table 8: Test result of Power Density 1M**

Channel	Channel Frequency (MHz)	Power Density	Limit
		(dBm)	(dBm)
Low Channel	2402	-7.532	8
Middle Channel	2440	-8.063	8
High Channel	2480	-7.529	8

**Table 9: Test result of Power Density 2M**

Channel	Channel Frequency (MHz)	Power Density	Limit
		(dBm)	(dBm)
Low Channel	2402	-9.481	8
Middle Channel	2440	-9.565	8
High Channel	2480	-10.598	8

## Test Plot of Power Density 1M

### Low Channel

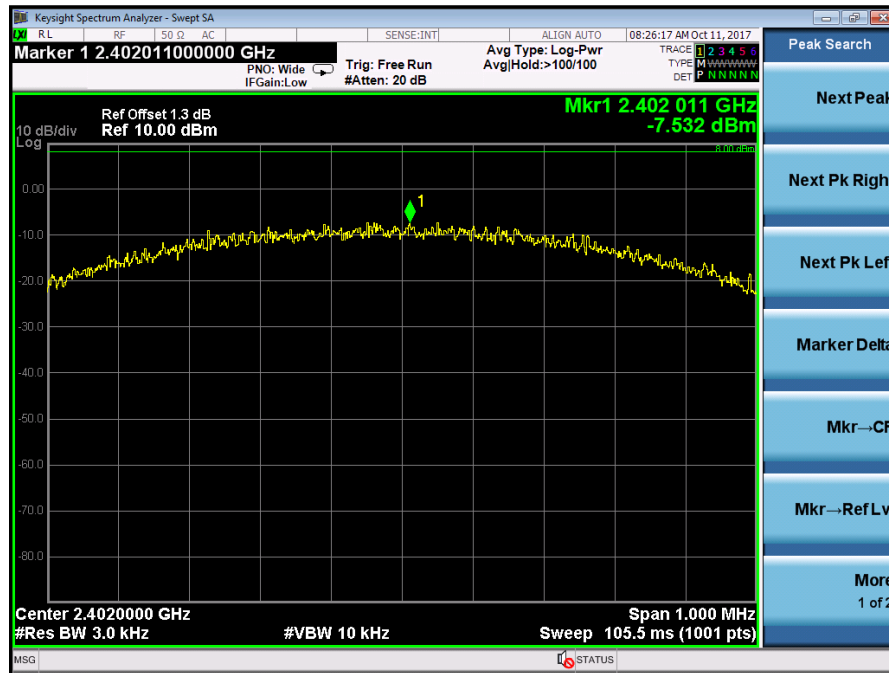

### Middle Channel

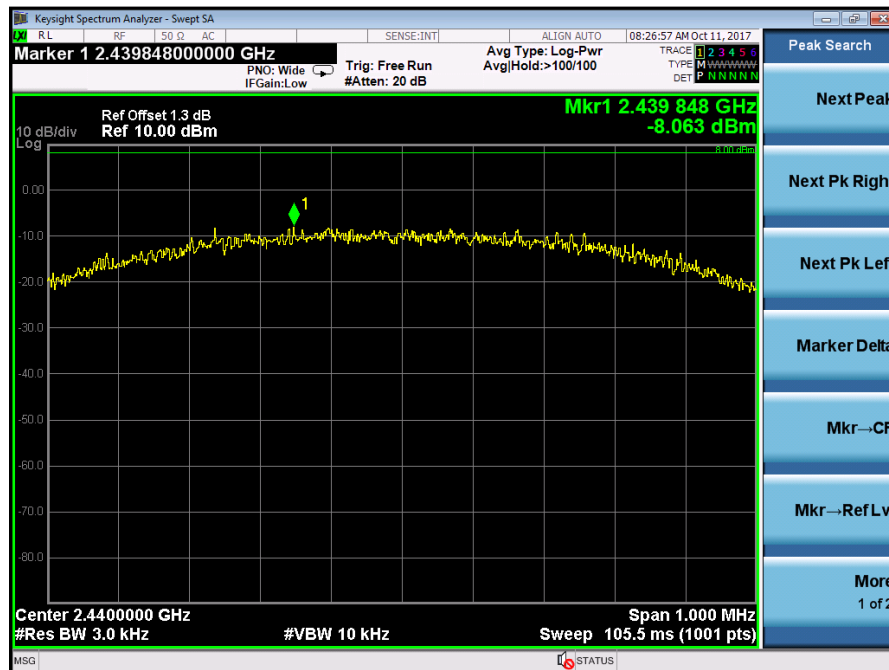

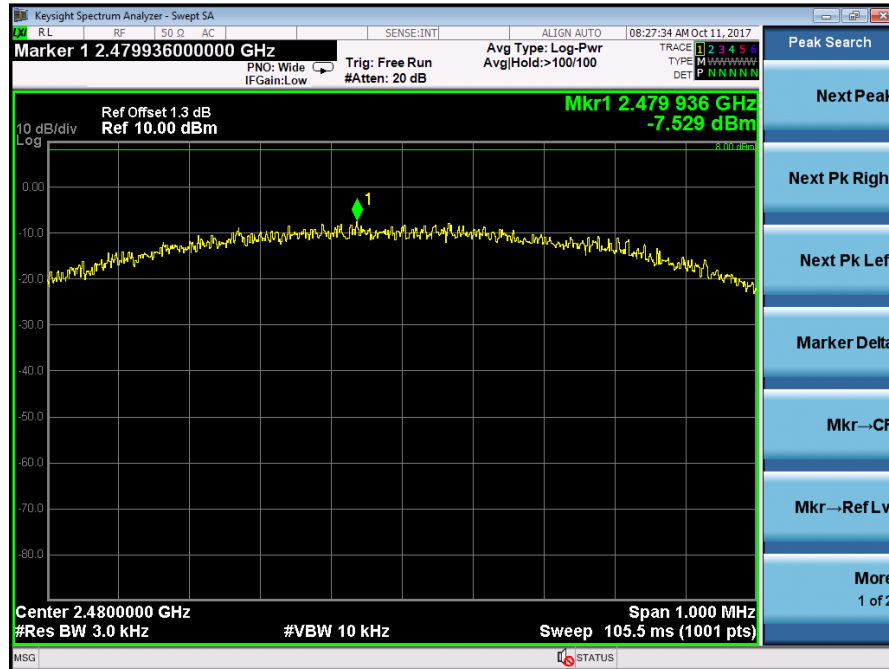
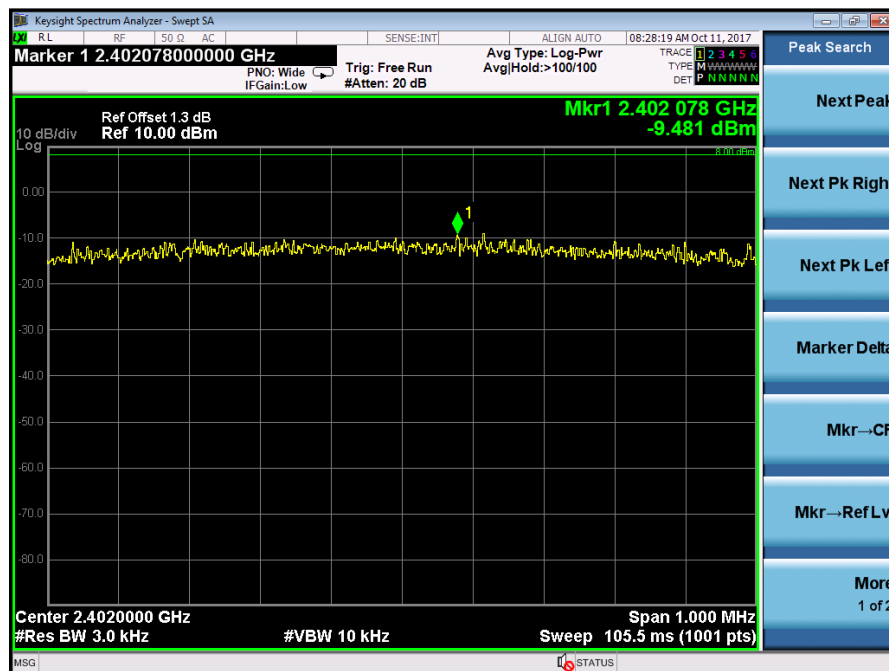
**High Channel**

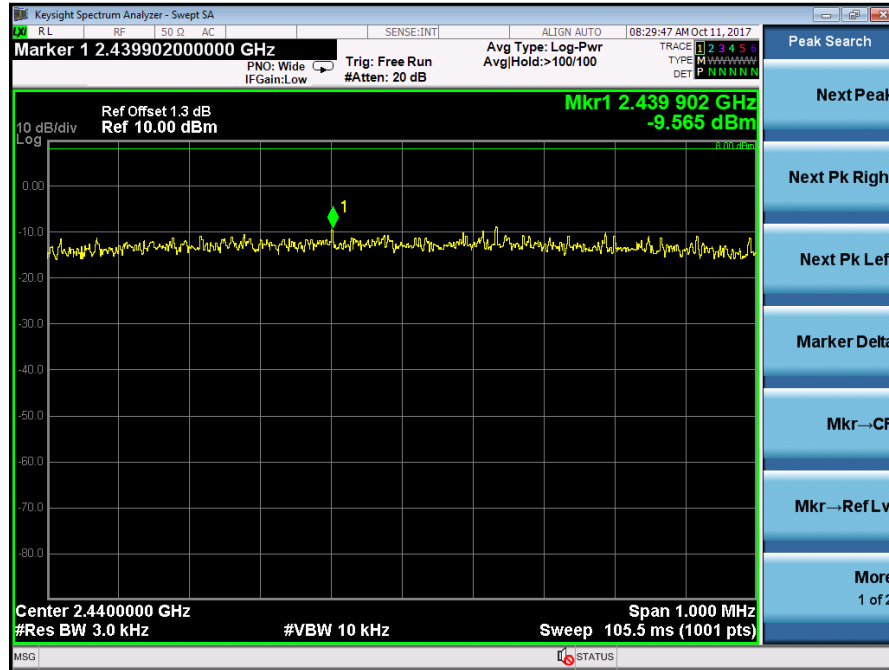
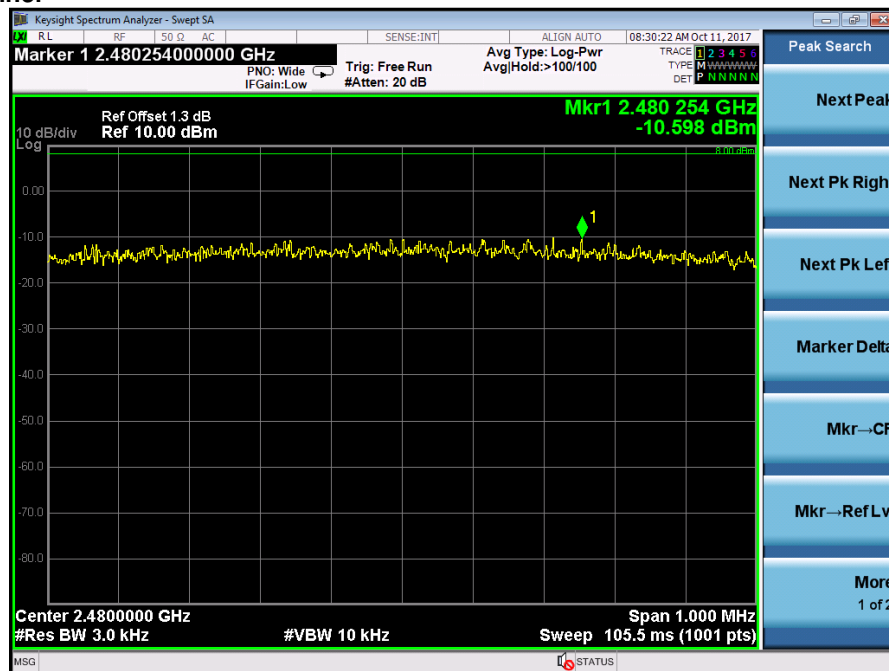
**Test Plot of Power Density 2M**
**Low Channel**

**Middle Channel**

**High Channel**

### 5.1.5 Conducted spurious emissions and Frequency Band Edge measured in 100kHz Bandwidth

**RESULT:** **Passed**

Test standard : LP0002(2016): 3.10.1,5  
FCC part 15.247(d), RSS-247 5.5  
Basic standard : ANSI C63.10:2013, KDB558074  
Limit : 20dB (below that in the 100kHz bandwidth within the  
band that contains the highest level of the desired power)  
Kind of test site : Shielded room

#### Test setup

Test Channel : Low/ High  
Operation mode : A  
Ambient temperature : 20-24°C  
Relative humidity : 50-65 %  
Atmospheric pressure : 100-103 kPa

All emissions are more than 20dB below fundamental, details refer to following test plot, and compliance is achieved as well.  
Due to the small size of the product and that there are no inductive components of significant size, 9kHz to 30MHz frequency range is not tested based on technical judgment.

## Test Plot 100kHz Conducted Emissions 1M

### Low Channel



### Middle Channel





**High Channel**

**Test Plot 100kHz Conducted Emissions 2M**
**Low Channel**

**Middle Channel**

**High Channel**

## Test Plot 100kHz RBW of Band Edge 1M

### Low Channel

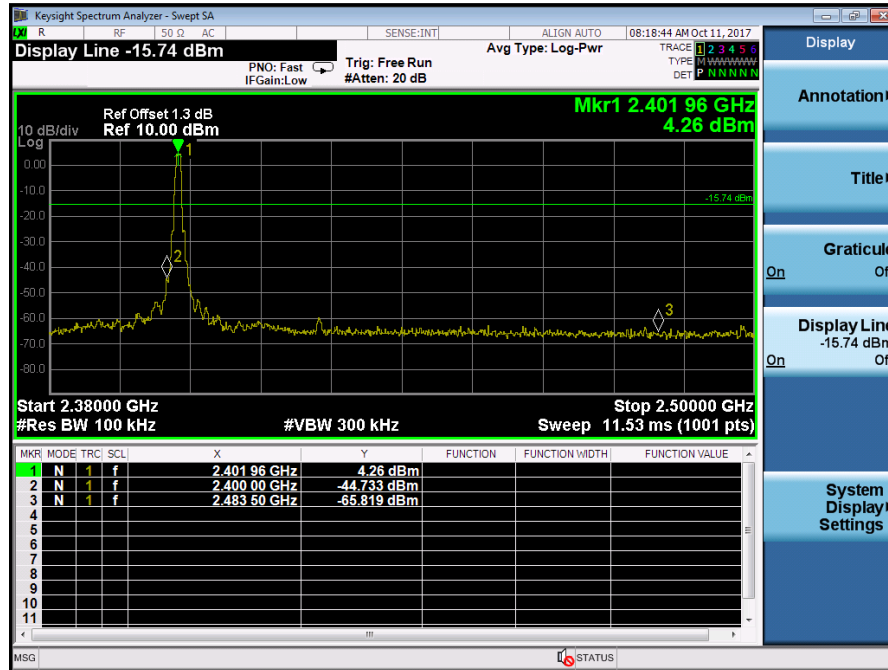

### High Channel

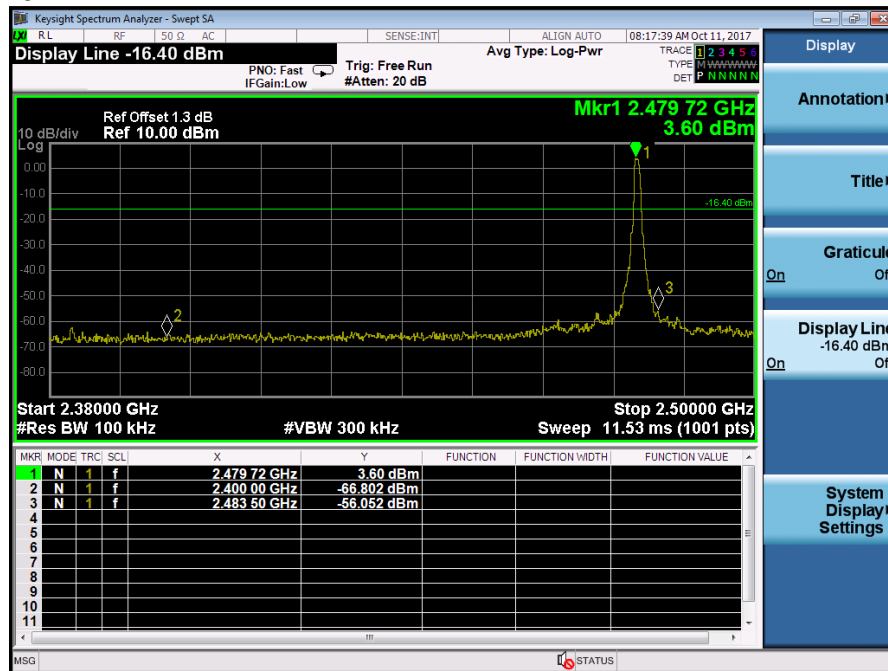

## Test Plot 100kHz RBW of Band Edge 2M

### Low Channel

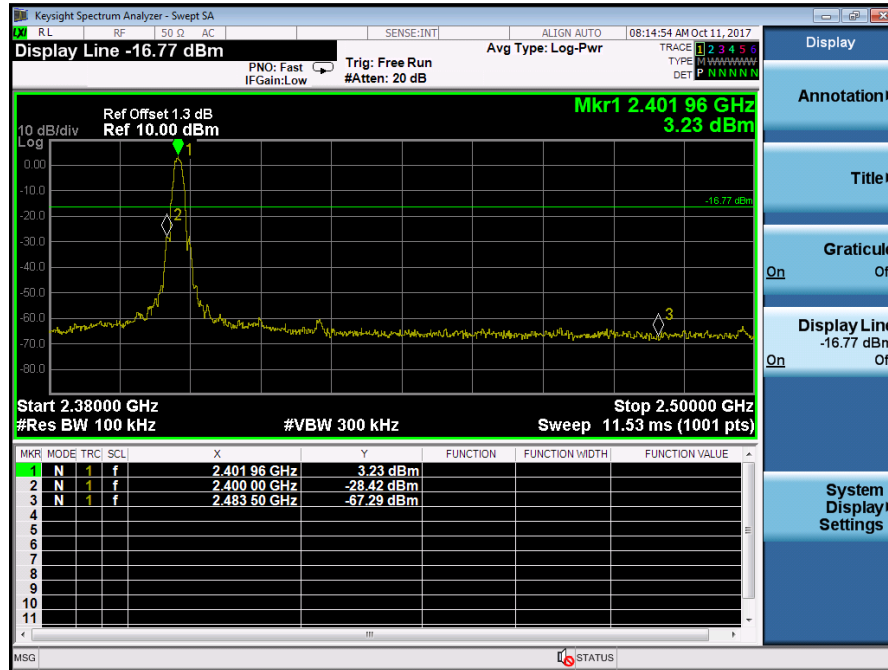

### High Channel

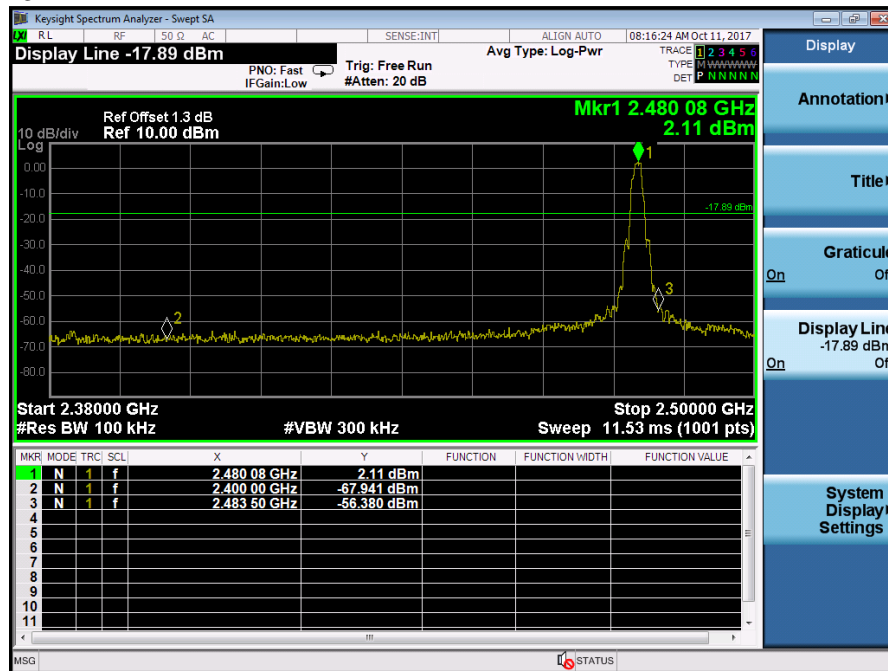

## 5.1.6 Spurious Emission

**RESULT:****Passed**

Test standard	:	FCC part 15.247(d), FCC 15.205, FCC 15.209, RSS-210 2.2, RSS-247 5.5 and RSS-Gen 8.9 LP0002(2016): 3.10.1,5
Basic standard	:	ANSI C63.10: 2009
Limits	:	Radiated emissions which fall in the restricted bands, as defined in FCC 15.205(a) and RSS-Gen i4, 8.9 (Table 6), must comply with the radiated emission limits specified in FCC 15.209(a) and RSS-Gen i4, 8.9 (Table 4 and 5). Radiated emissions which fall in the restricted bands, as defined in LP0002(2016): 2.7 , must comply with the radiated emission limits specified in LP0002(2016): 2.8 Emission radiated outside the specified frequency bands must comply with the radiated emission limits specified in FCC 15.209(a) and FCC 15.249(a), RSS-Gen i4, 8.9 (Table 4 and 5) and RSS-210 A2.9(a). Emission radiated outside the specified frequency bands must comply with the radiated emission limits specified in LP0002(2016): 2.8
Kind of test site	:	3m Semi-Anechoic Chamber

**Test setup**

Test Channel	:	Low/ Middle/ High
Operation mode	:	A, B

Remark: Testing was carried out within frequency range 30MHz to the tenth harmonic.

For details refer to Appendix D.

Testing was carried out within frequency range 30MHz to the tenth harmonic. For details refer to Appendix D. The Radiated Emissions testing was performed in the X, Y and Z axis orientation. The worst-case Axis orientation is recorded in this test report.

## 6. Safety Human exposure

### 6.1 Radio Frequency Exposure Compliance

#### 6.1.1 Electromagnetic Fields

**RESULT:****Passed**Test standard : FCC KDB Publication 447498 D01 v06  
RSS--102FCC:

Since maximum peak output power of the transmitter is 3.26 mW < 10mW, hence the EUT is excluded from SAR evaluation according to FCC KDB publication 447498 D01 v05: Mobile Portable RF Exposure

## 7. Photographs of the Test Set-Up

Photograph 1: Set-up for Spurious Emissions (Front View)

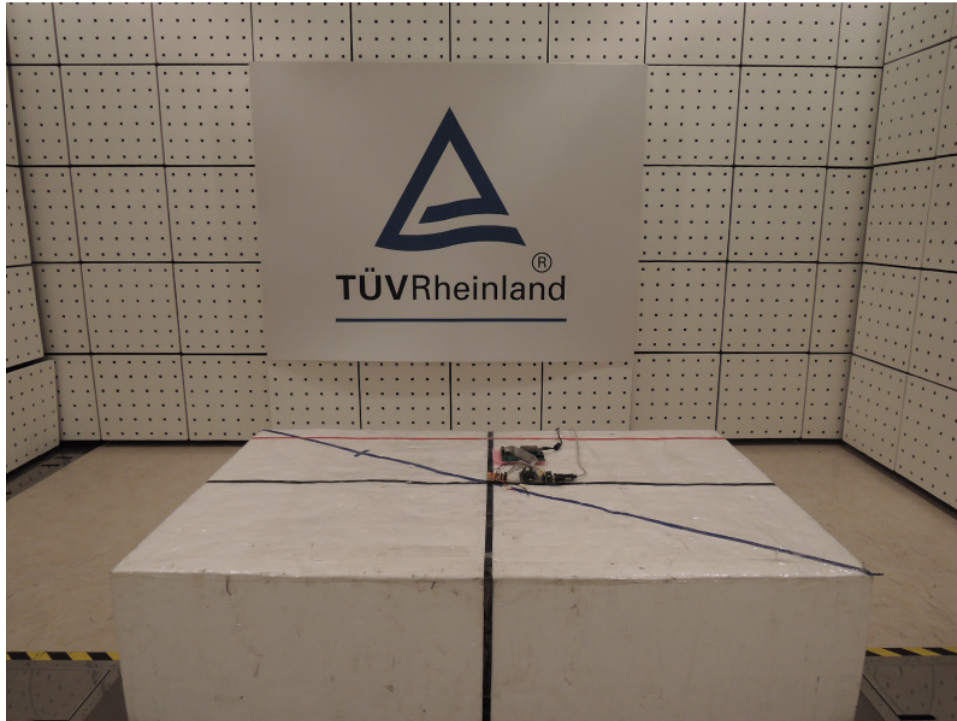



**Photograph 2: Set-up for Spurious Emissions (Back View 1)**

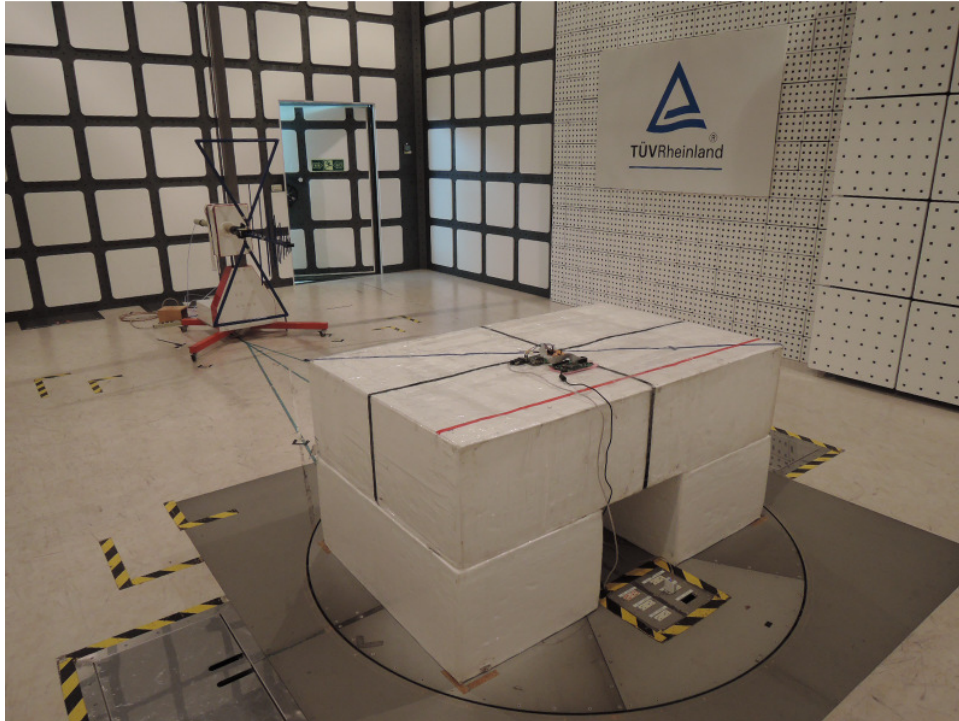

**Photograph 3: Set-up for Spurious Emissions (Back View 2)**

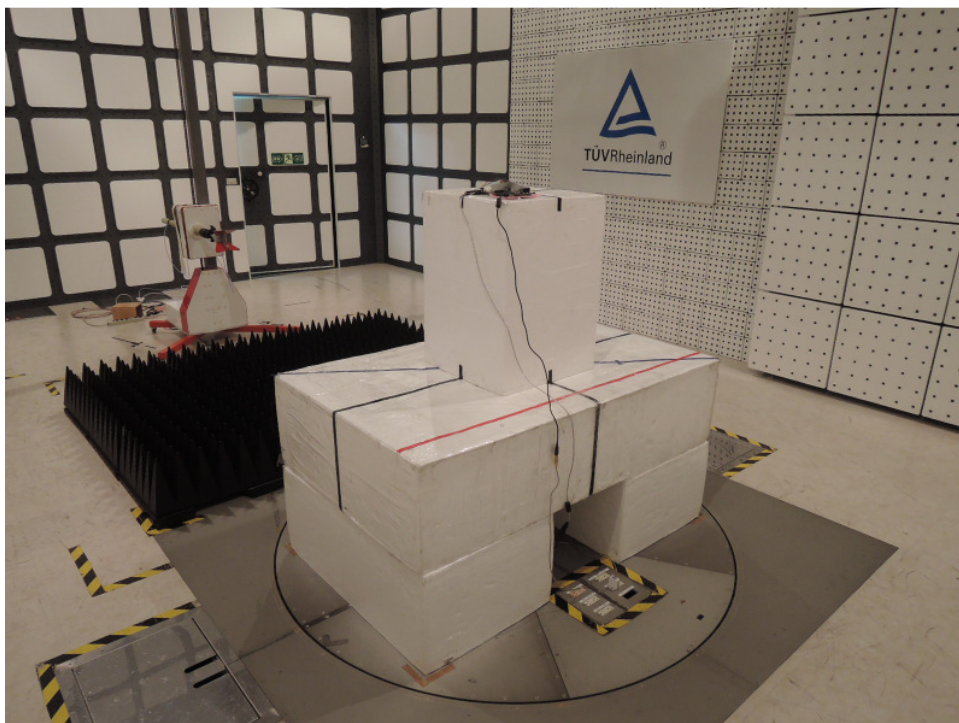



**Photograph 4: Set-up for Spurious Emissions (Back View 3)**

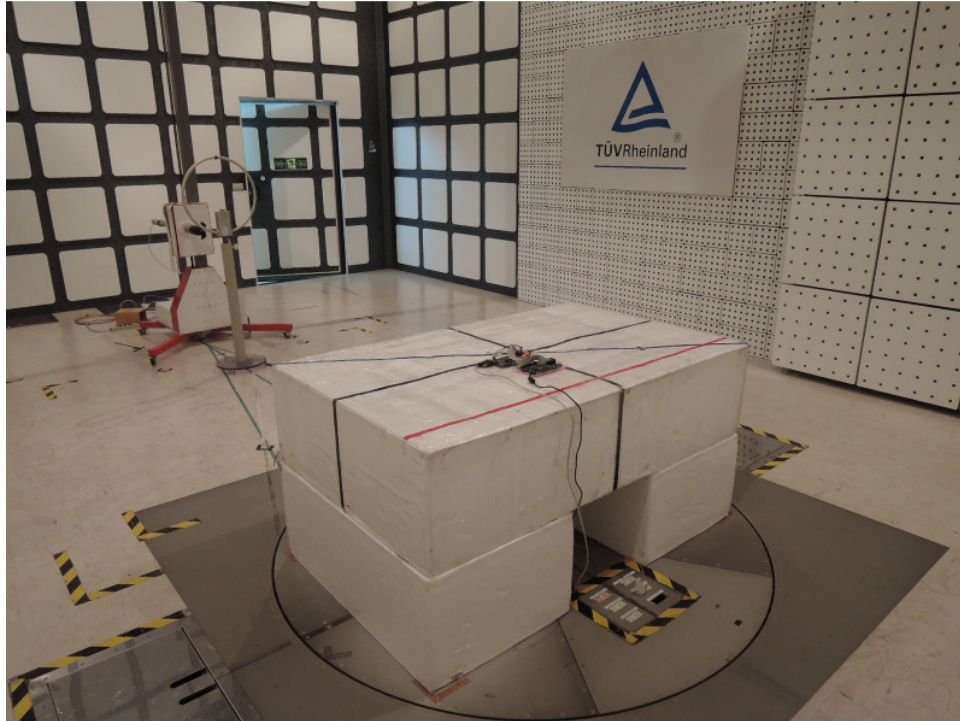

**Photograph 5: Set-up for Conducted testing**



## 8. List of Tables

Table 1: Applied Standard and Test Levels .....	5
Table 2: List of Test and Measurement Equipment .....	7
Table 3: Emission Measurement Uncertainty.....	8
Table 4: Basic Information of EUT .....	9
Table 5: Technical Specification of EUT .....	9
Table 6: Test result of Peak Output Power (1M) .....	16
Table 7: Test result of AVG Output Power (1M).....	16
Table 8: Test result of Peak Output Power (2M) .....	17
Table 9: Test result of AVG Output Power (2M),.....	17
Table 10: Test result of 6dB Bandwidth (1M) .....	18
Table 11: Test result of 6dB Bandwidth (2M) .....	18
Table 12: Test result of 99% Bandwidth, 1M.....	19
Table 13: Test result of 99% Bandwidth, 2M.....	19
Table 14: Test result of Power Density 1M .....	27
Table 15: Test result of Power Density 2M .....	27

## 9. List of Photographs

Photograph 1: Set-up for Spurious Emissions (Front View).....	39
Photograph 2: Set-up for Spurious Emissions (Back View 1) .....	40
Photograph 3: Set-up for Spurious Emissions (Back View 2) .....	40
Photograph 4: Set-up for Spurious Emissions (Back View 3) .....	41
Photograph 5: Set-up for Conducted testing .....	41