

MODIFICATION			
VER	DESCRIPTION	DATE	ENGINEER
R00	Release	05/14'14	
R01	新增破孔	07/30'14	
R02	取消破孔,新增雷雕文字	09/12'14	

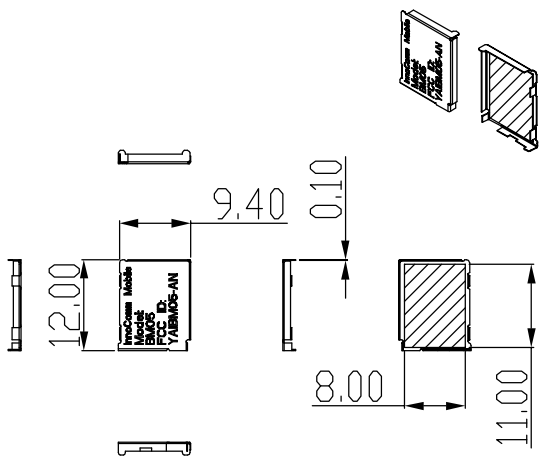

SCALE 1:1

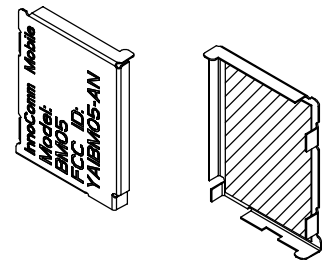

3D View

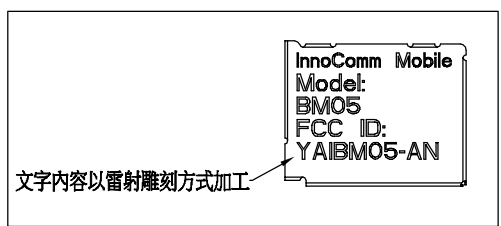

文字內容以雷射雕刻方式加工

InnoComm Mobile  
Model:  
BM05  
FCC ID:  
YAIBM05-AN

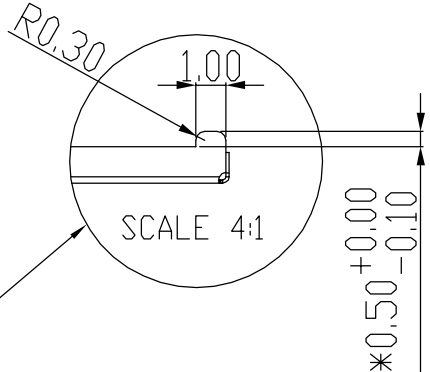

SCALE 4:1

Detail A

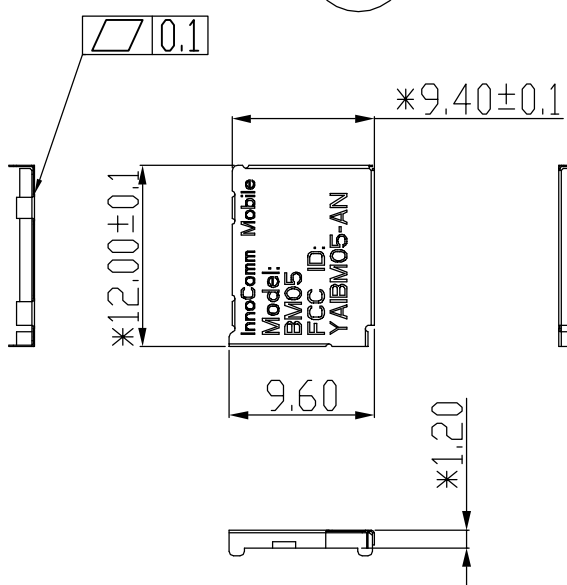
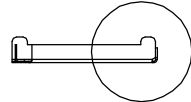

SCALE 2:1

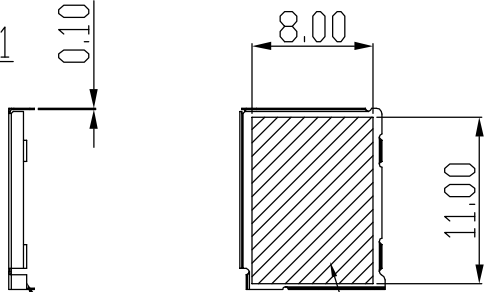

毛邊面需小於0.05mm

Kapton T=0.08mm(含背膠)

- NOTE:
1. 材質: 洋白銅
  2. 厚度: 0.1mm
  3. \*重點尺寸
  4. 需符合RoHS

InnoComm Mobile Technology Corp.

Drawn: Willey Lee  
Designed: Willey Lee

THESE DRAWINGS AND SPECIFICATIONS ARE THE PROPERTY OF INNOCOMM MOBILE TECHNOLOGY CORP. AND SHALL NOT BE REPRODUCED OR USED AS THE BASIS FOR THE MANUFACTURE OR DEVICES WITHOUT PERMISSION.

Checked:  
Approved:

DIMENSIONAL TOLERANCES±	V							
	M1	M2	S1	S2	P1	P2	C	
0-6	0.05	0.10	0.15	0.20	0.05	0.10	0.5	
6-30	0.10	0.20	0.15	0.25	0.10	0.15	1.0	
30-80	0.15	0.25	0.20	0.30	0.20	0.40	2.0	
80-180	0.15	0.30	0.25	0.45	0.40	0.80	3.0	
180-315	0.20	0.50	0.40	0.60	0.60	1.20	3.0	
315-800	0.30	0.80	0.70	1.10	0.80	1.50	4.0	

Material:  
Treatment:  
A4 SIZE

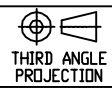

DWG TITL: shielding can for BM05 AN  
DWG NO: XXX-XXXX-XXXX  
REV: R02  
SHEET 1 OF 1

SCALE	2,000	UNITS	MM	USED ON	DWG NO.	XXX-XXXX-XXXX	DATE	2014/09/12
-------	-------	-------	----	---------	---------	---------------	------	------------