



TEST REPORT

Report No. : **CHTEW19030121** Report verification: 

Project No. : **SHT1903020602EW**

FCC ID..... : **YAHMA-810**

Applicant's name..... : **Venture Global Limited**

Address.....: Rm:1102,11/F.,Fabrico Industrial Building, 78-84 Kwai Cheong Road,Kwai Chung,N.T. HongKong,China

Manufacturer.....: Venture Global Limited

Address.....: Rm:1102,11/F.,Fabrico Industrial Building, 78-84 Kwai Cheong Road,Kwai Chung,N.T. HongKong,China

Test item description : Wireless Multi-Alert Receiver

Trade Mark : Guardman

Model/Type reference.....: MA-810

Listed Model(s) : -

Standard : **47 CFR FCC Part 15 Subpart B**

Date of receipt of test sample.....: Mar.08,2019

Date of testing.....: Mar.08,2019 ~ Mar.18,2019

Date of issue.....: Mar.19,2019

Result.....: **Pass**

Compiled by
 (position+printed name+signature)...: File administrators Yueming Li

Supervised by
 (position+printed name+signature)...: Project Engineer Tom Ouyang

Approved by
 (position+printed name+signature)...: RF Manager Hans Hu

Yueming Li

Tom Ouyang

Hans Hu

Testing Laboratory Name : **Shenzhen Huatongwei International Inspection Co., Ltd.**
Address.....: 1/F, Bldg 3, Hongfa Hi-tech Industrial Park, Genyu Road, Tianliao, Gongming, Shenzhen, China

Shenzhen Huatongwei International Inspection Co., Ltd. All rights reserved.

This publication may be reproduced in whole or in part for non-commercial purposes as long as the Shenzhen Huatongwei International Inspection Co., Ltd. is acknowledged as copyright owner and source of the material. Shenzhen Huatongwei International Inspection Co., Ltd. takes no responsibility for and will not assume liability for damages resulting from the reader's interpretation of the reproduced material due to its placement and context.

The test report merely corresponds to the test sample.

Contents

1.	<u>TEST STANDARDS AND REPORT VERSION</u>	<u>3</u>
1.1.	Test Standards	3
1.2.	Report version information	3
2.	<u>TEST DESCRIPTION</u>	<u>4</u>
3.	<u>SUMMARY.....</u>	<u>5</u>
3.1.	Client Information	5
3.2.	Product Description	5
3.3.	EUT operation mode	5
3.4.	Support unit used in test configuration	5
4.	<u>TEST ENVIRONMENT</u>	<u>6</u>
4.1.	Address of the test laboratory	6
4.2.	Test Facility	6
4.3.	Environmental conditions	7
4.4.	Statement of the measurement uncertainty	7
4.5.	Equipments Used during the Test	8
5.	<u>TEST CONDITIONS AND RESULTS</u>	<u>9</u>
5.1.	Conducted Emissions Test	9
5.2.	Radiated Emissions Test	12
6.	<u>TEST SETUP PHOTOS OF THE EUT</u>	<u>16</u>
7.	<u>EXTERNAL AND INTERNAL PHOTOS OF THE EUT</u>	<u>17</u>

1. TEST STANDARDS AND REPORT VERSION

1.1. Test Standards

The tests were performed according to following standards:

[47 CFR FCC Part 15 Subpart B](#) - Unintentional Radiators

[ANSI C63.4: 2014](#) – American National Standard for Methods of Measurement of Radio-Noise Emissions from Low-Voltage Electrical and Electronic Equipment in the Range of 9 kHz to 40GHz

1.2. Report version information

Revision No.	Date of issue	Description
N/A	2019-03-19	Original

2. TEST DESCRIPTION

Test Item	Section in CFR 47	Result	Test Engineer
Conducted Emissions	15.107(a)	PASS	Zhiwei Liu
Radiated Emissions	15.109(a)	PASS	Pan Xie

Note: The measurement uncertainty is not included in the test result.

3. SUMMARY

3.1. Client Information

Applicant:	Venture Global Limited
Address:	Rm:1102,11/F.,Fabrico Industrial Building, 78-84 Kwai Cheong Road,Kwai Chung,N.T. HongKong,China
Manufacturer:	Venture Global Limited
Address:	Rm:1102,11/F.,Fabrico Industrial Building, 78-84 Kwai Cheong Road,Kwai Chung,N.T. HongKong,China

3.2. Product Description

Name of EUT:	Wireless Multi-Alert Receiver
Trade Mark:	Guardman
Model No.:	MA-810
Listed Model(s)	-
Power supply:	DC 4.5V(3*AAA Size from battery)
Test Voltage:	AC 120V/60Hz
Adapter information:	-
Hardware Version:	V1.0
Software Version:	V2.0

3.3. EUT operation mode

Test mode	Describe
Receive mode	Keep EUT in receive state

3.4. Support unit used in test configuration

Item	Equipment	Manufacturer	Model No.	FCC ID / FCC DoC	Data Cable	Power Cord
1	ADAPTOR	Intertek	HKP06-0600300dG	FCC ID	N/A	N/A

4. TEST ENVIRONMENT

4.1. Address of the test laboratory

Laboratory: Shenzhen Huatongwei International Inspection Co., Ltd.

Address: 1/F, Bldg 3, Hongfa Hi-tech Industrial Park, Genyu Road, Tianliao, Gongming, Shenzhen, China

Phone: 86-755-26748019 Fax: 86-755-26748089

4.2. Test Facility

The test facility is recognized, certified, or accredited by the following organizations:

CNAS-Lab Code: L1225

Shenzhen Huatongwei International Inspection Co., Ltd. has been assessed and proved to be in compliance with CNAS-CL01 Accreditation Criteria for Testing and Calibration Laboratories (identical to ISO/IEC17025: 2005 General Requirements) for the Competence of Testing and Calibration Laboratories.

A2LA-Lab Cert. No. 3902.01

Shenzhen Huatongwei International Inspection Co., Ltd. EMC Laboratory has been accredited by A2LA for technical competence in the field of electrical testing, and proved to be in compliance with ISO/IEC 17025: 2005 General Requirements for the Competence of Testing and Calibration Laboratories and any additional program requirements in the identified field of testing.

FCC-Registration No.: 762235

Shenzhen Huatongwei International Inspection Co., Ltd. EMC Laboratory has been registered and fully described in a report filed with the FCC (Federal Communications Commission). The acceptance letter from the FCC is maintained in our files. Registration 762235.

IC-Registration No.: 5377B-1

Two 3m Alternate Test Site of Shenzhen Huatongwei International Inspection Co., Ltd. has been registered by Certification and Engineering Bureau of Industry Canada for the performance of radiated measurements with Registration No. 5377B-1.

ACA

Shenzhen Huatongwei International Inspection Co., Ltd. EMC Laboratory can also perform testing for the Australian C-Tick mark as a result of our A2LA accreditation.

4.3. Environmental conditions

During the measurement the environmental conditions were within the listed ranges:

Temperature:	15~35°C
Relative Humidity:	30~60 %
Air Pressure:	950~1050mba

4.4. Statement of the measurement uncertainty

The data and results referenced in this document are true and accurate. The reader is cautioned that there may be errors within the calibration limits of the equipment and facilities. The measurement uncertainty was calculated for all measurements listed in this test report acc. to CISPR 16 - 4 „Specification for radio disturbance and immunity measuring apparatus and methods – Part 4: Uncertainty in EMC Measurements“ and is documented in the Shenzhen Huatongwei International Inspection Co., Ltd quality system acc. to DIN EN ISO/IEC 17025. Furthermore, component and process variability of devices similar to that tested may result in additional deviation. The manufacturer has the sole responsibility of continued compliance of the device.

Hereafter the best measurement capability for Shenzhen Huatongwei laboratory is reported:

Test	Range	Measurement Uncertainty	Notes
Radiated Emissions	30~1000MHz	4.28 dB	(1)
Radiated Emissions	1~18GHz	5.16 dB	(1)
Conducted Disturbance	0.15~30MHz	3.35 dB	(1)

(1) This uncertainty represents an expanded uncertainty expressed at approximately the 95% confidence level using a coverage factor of $k=1.96$.

4.5. Equipments Used during the Test

● Conducted Emission						
Used	Test Equipment	Manufacturer	Model No.	Serial No.	Last Cal. Date (YY-MM-DD)	Next Cal. Date (YY-MM-DD)
●	Shielded Room	Albatross projects	N/A	N/A	2018/09/28	2023/09/27
●	EMI Test Receiver	R&S	ESCI	101247	2018/10/27	2019/10/26
●	Artificial Mains	SCHWARZBECK	NNLK 8121	573	2018/10/27	2019/10/26
●	Pulse Limiter	R&S	ESH3-Z2	100499	2018/10/27	2019/10/26
●	RF Connection Cable	HUBER+SUHNER	EF400	N/A	2018/11/15	2019/11/14
●	Test Software	R&S	ES-K1	N/A	N/A	N/A
○	Single Balanced Telecom Pair ISN	FCC	FCC-TLISN-T2-02	20371	2018/10/28	2019/10/27
○	Two Balanced Telecom Pairs ISN	FCC	FCC-TLISN-T4-02	20373	2018/10/28	2019/10/27
○	Four Balanced Telecom Pairs ISN	FCC	FCC-TLISN-T8-02	20375	2018/10/28	2019/10/27
○	V-Network	R&S	ESH3-Z6	100211	2018/10/27	2019/10/26
○	V-Network	R&S	ESH3-Z6	100210	2018/10/27	2019/10/26
○	2-Line V-Network	R&S	ESH3-Z5	100049	2018/10/27	2019/10/26

● Radiated Emission-6th test site						
Used	Test Equipment	Manufacturer	Model No.	Serial No.	Last Cal. Date (YY-MM-DD)	Next Cal. Date (YY-MM-DD)
●	Semi-Anechoic Chamber	Albatross projects	SAC-3m-02	N/A	2018/09/30	2021/09/29
●	EMI Test Receiver	R&S	ESCI	100900	2018/10/28	2019/10/27
○	Loop Antenna	R&S	HFH2-Z2	100020	2017/11/20	2020/11/19
●	Ultra-Broadband Antenna	SCHWARZBECK	VULB9163	546	2017/04/05	2020/04/04
●	Pre-Amplifier	SCHWARZBECK	BBV 9742	N/A	2018/11/15	2019/11/14
●	RF Connection Cable	HUBER+SUHNER	N/A	N/A	2018/09/28	2019/09/27
●	RF Connection Cable	HUBER+SUHNER	SUCOFLEX104	501184/4	2018/09/28	2019/09/27
●	Test Software	R&S	ES-K1	N/A	N/A	N/A
●	Turntable	Maturo Germany	TT2.0-1T	N/A	N/A	N/A
●	Antenna Mast	Maturo Germany	CAM-4.0-P-12	N/A	N/A	N/A

● Radiated emission-7th test site						
Used	Test Equipment	Manufacturer	Model No.	Serial No.	Last Cal. Date (YY-MM-DD)	Next Cal. Date (YY-MM-DD)
●	Semi-Anechoic Chamber	Albatross projects	SAC-3m-01	N/A	2018/09/30	2021/09/29
●	Spectrum Analyzer	R&S	FSP40	100597	2018/10/27	2019/10/26
●	Horn Antenna	SCHWARZBECK	9120D	1011	2017/03/27	2020/03/26
○	Pre-amplifier	BONN	BLWA0160-2M	1811887	2018/11/14	2019/11/13
●	Pre-amplifier	CD	PAP-0102	12004	2018/11/14	2019/11/13
●	Broadband Pre-amplifier	SCHWARZBECK	BBV 9718	9718-248	2018/04/28	2019/04/27
●	RF Connection Cable	HUBER+SUHNER	RE-7-FH	N/A	2018/11/15	2019/11/14
●	RF Connection Cable	HUBER+SUHNER	RE-7-FL	N/A	2018/11/15	2019/11/14
●	Test Software	Audix	E3	N/A	N/A	N/A
●	Turntable	Maturo Germany	TT2.0-1T	N/A	N/A	N/A
●	Antenna Mast	Maturo Germany	CAM-4.0-P-12	N/A	N/A	N/A

5. TEST CONDITIONS AND RESULTS

5.1. Conducted Emissions Test

LIMIT

FCC CFR Title 47 Part 15 Subpart B Section 15.107:

Frequency range (MHz)	Limit (dBuV)	
	Quasi-peak	Average
0.15-0.5	66 to 56*	56 to 46*
0.5-5	56	46
5-30	60	50

* Decreases with the logarithm of the frequency.

TEST CONFIGURATION

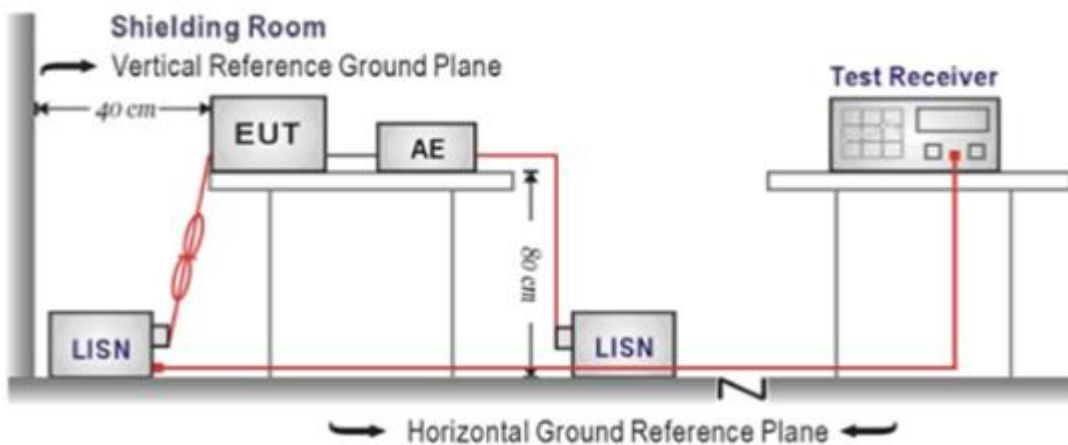

TEST PROCEDURE

1. The EUT was setup according to ANSI C63.4:2014
2. The EUT was placed on a platform of nominal size, 1 m by 1.5 m, raised 80 cm above the conducting ground plane. The vertical conducting plane was located 40 cm to the rear of the EUT. All other surfaces of EUT were at least 80 cm from any other grounded conducting surface.
3. The EUT and simulators are connected to the main power through a line impedance stabilization network (LISN). The LISN provides a 50ohm / 50uH coupling impedance for the measuring equipment.
4. The peripheral devices are also connected to the main power through a LISN. (Please refer to the block diagram of the test setup and photographs)
5. Each current-carrying conductor of the EUT power cord, except the ground (safety) conductor, was individually connected through a LISN to the input power source.
6. The excess length of the power cord between the EUT and the LISN receptacle were folded back and forth at the center of the lead to form a bundle not exceeding 40 cm in length.
7. Conducted emissions were investigated over the frequency range from 0.15MHz to 30MHz using a receiver bandwidth of 9 kHz.
8. During the above scans, the emissions were maximized by cable manipulation.

TEST MODE:

Please refer to the clause 3.3

TEST RESULTS

Passed Not Applicable

Test Line:

L

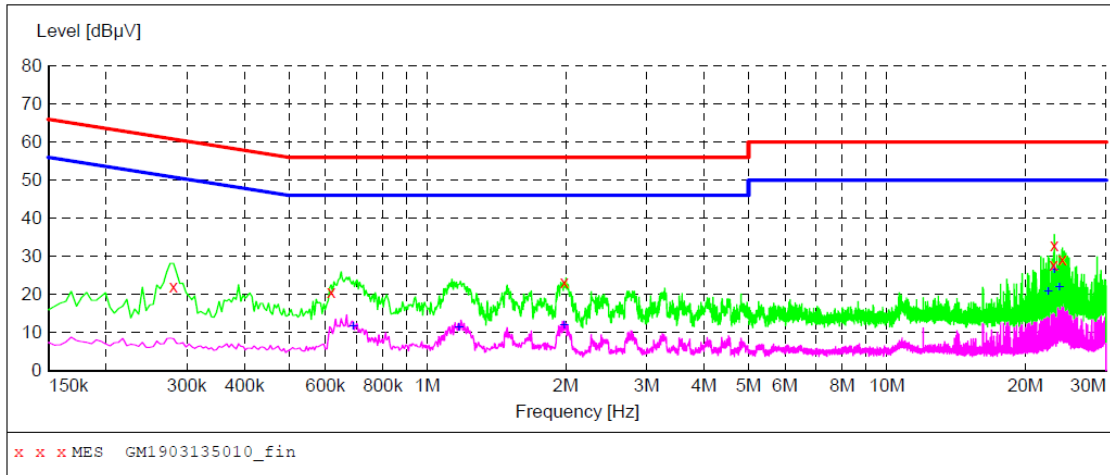

MEASUREMENT RESULT: "GM1903135010_fin"

3/13/2019 10:12AM

Frequency MHz	Level dBµV	Transd dB	Limit dBµV	Margin dB	Detector	Line	PE
0.280500	22.20	10.2	61	38.6	QP	L1	GND
0.618000	20.00	10.0	56	36.0	QP	L1	GND
1.986000	23.80	10.0	56	32.2	QP	L1	GND
23.068500	27.90	10.4	60	32.1	QP	L1	GND
23.127000	33.00	10.4	60	27.0	QP	L1	GND
24.045000	29.10	10.4	60	30.9	QP	L1	GND

MEASUREMENT RESULT: "GM1903135010_fin2"

3/13/2019 10:12AM

Frequency MHz	Level dBµV	Transd dB	Limit dBµV	Margin dB	Detector	Line	PE
0.690000	12.80	10.0	46	33.2	AV	L1	GND
1.171500	11.60	10.0	46	34.4	AV	L1	GND
1.986000	13.50	10.0	46	32.5	AV	L1	GND
22.456500	20.60	10.4	50	29.4	AV	L1	GND
23.127000	26.30	10.4	50	23.7	AV	L1	GND
23.739000	21.70	10.4	50	28.3	AV	L1	GND

Test Line:

N

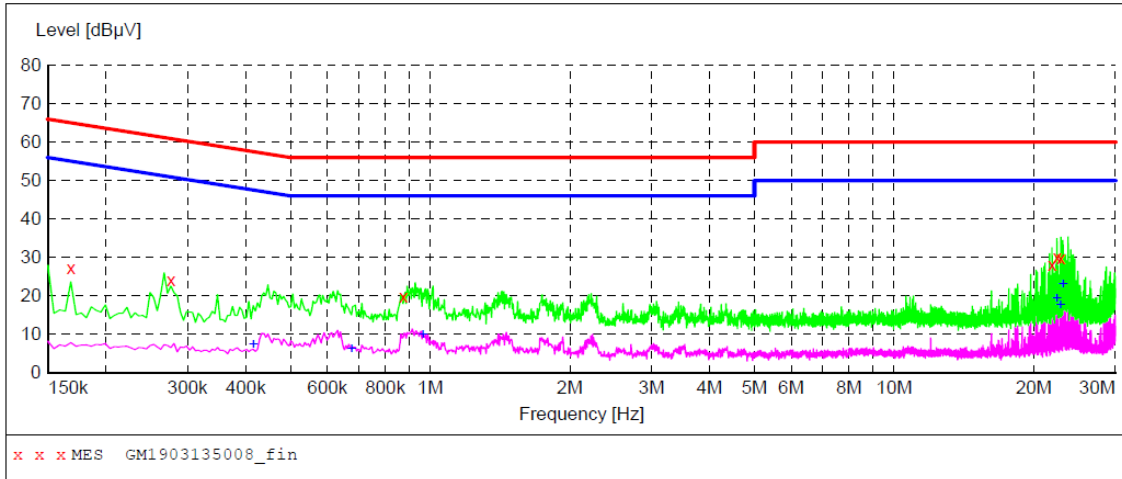

MEASUREMENT RESULT: "GM1903135008_fin"

3/13/2019 10:05AM

Frequency MHz	Level dBµV	Transd dB	Limit dBµV	Margin dB	Detector	Line	PE
0.168000	27.10	10.1	65	38.0	QP	N	GND
0.276000	24.10	10.2	61	36.8	QP	N	GND
0.874500	19.50	9.9	56	36.5	QP	N	GND
21.907500	28.10	10.4	60	31.9	QP	N	GND
22.456500	30.10	10.4	60	29.9	QP	N	GND
22.884000	29.70	10.4	60	30.3	QP	N	GND

MEASUREMENT RESULT: "GM1903135008_fin2"

3/13/2019 10:05AM

Frequency MHz	Level dBµV	Transd dB	Limit dBµV	Margin dB	Detector	Line	PE
0.415500	7.20	10.1	48	40.3	AV	N	GND
0.676500	6.30	10.0	46	39.7	AV	N	GND
0.964500	9.90	9.9	46	36.1	AV	N	GND
22.456500	19.20	10.4	50	30.8	AV	N	GND
22.884000	17.50	10.4	50	32.5	AV	N	GND
23.127000	23.00	10.4	50	27.0	AV	N	GND

5.2. Radiated Emissions Test

LIMIT

FCC CFR Title 47 Part 15 Subpart B Section 15.109

Frequency	Limit (dBuV/m @3m)	Value
30MHz-88MHz	40.00	Quasi-peak
88MHz-216MHz	43.50	Quasi-peak
216MHz-960MHz	46.00	Quasi-peak
960MHz-1GHz	54.00	Quasi-peak
Above 1GHz	54.00	Average
	74.00	Peak

TEST CONFIGURATION

➤ 30MHz ~ 1GHz

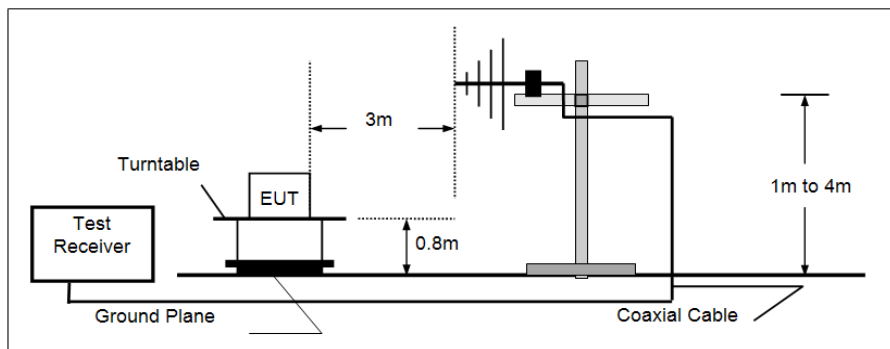

➤ Above 1GHz

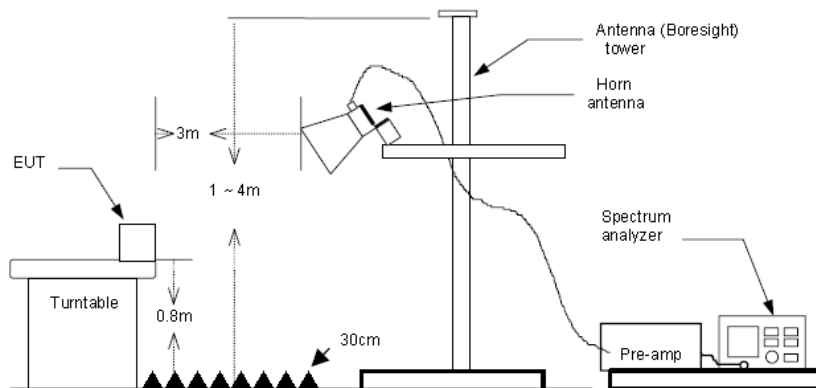

TEST PROCEDURE

1. The EUT was tested according to ANSI C63.4:2014.
2. The EUT is placed on a turn table which is 0.8 meter above ground.
3. The turn table is rotated 360 degrees to determine the position of the maximum emission level.
4. The EUT was positioned such that the distance from antenna to the EUT was 3 meters.
5. The antenna is scanned from 1 meter to 4 meters to find out the maximum emission level. This is repeated for both horizontal and vertical polarization of the antenna.
6. Use the following spectrum analyzer settings
 - (1) Span shall wide enough to fully capture the emission being measured;
 - (2) Below 1GHz,
 RBW=120KHz, VBW=300KHz, Sweep=auto, Detector function=peak, Trace=max hold;
 If the emission level of the EUT measured by the peak detector is 3 dB lower than the applicable limit, the peak emission level will be reported. Otherwise, the emission measurement will be repeated using the quasi-peak detector and reported.
 - (3) From 1GHz to 5th harmonic, RBW=1MHz, VBW=3MHz

TEST MODE:

Please refer to the clause 3.3

TEST RESULTS

Passed **Not Applicable**

Note: Final Level =Receiver Read level + Antenna Factor + Cable Loss – Preamplifier Factor

Polarization: Horizontal

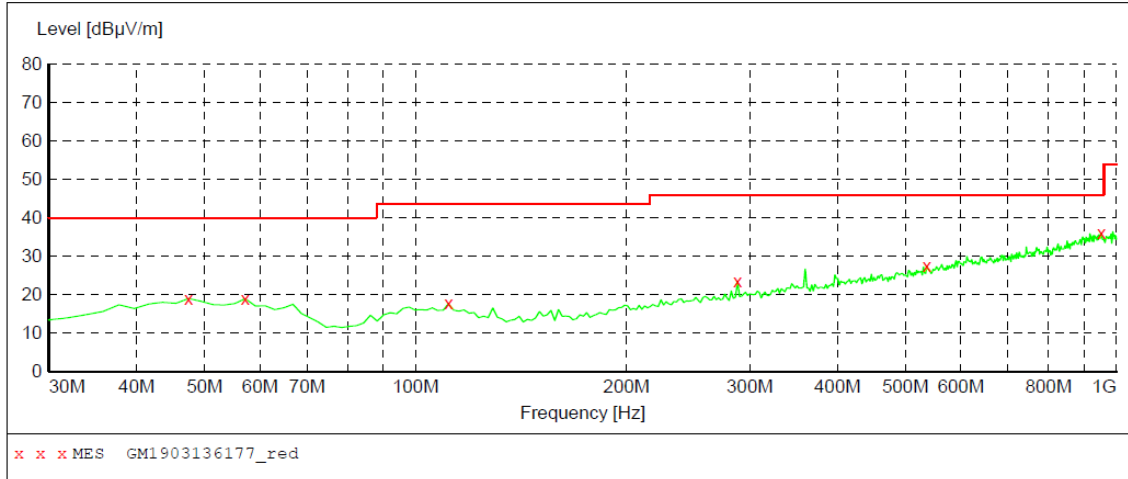

MEASUREMENT RESULT: "GM1903136177_red"

3/13/2019 7:02PM

Frequency MHz	Level dBuV/m	Transd dB	Limit dBuV/m	Margin dB	Det.	Height cm	Azimuth deg	Polarization
47.460000	19.00	-8.7	40.0	21.0	QP	300.0	3.00	HORIZONTAL
57.160000	19.00	-9.3	40.0	21.0	QP	300.0	357.00	HORIZONTAL
111.480000	17.70	-10.9	43.5	25.8	QP	300.0	360.00	HORIZONTAL
288.020000	23.50	-7.2	46.0	22.5	QP	100.0	192.00	HORIZONTAL
536.340000	27.50	-0.4	46.0	18.5	QP	300.0	360.00	HORIZONTAL
951.500000	36.00	8.2	46.0	10.0	QP	300.0	212.00	HORIZONTAL

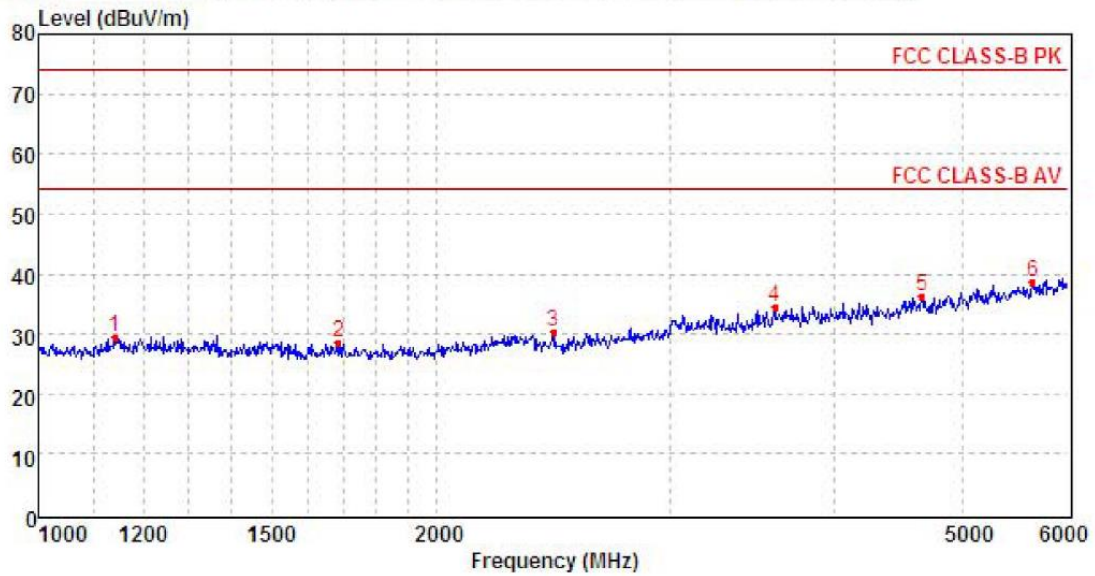

Mark	Frequency MHz	Reading dBuV/m	Antenna dB	Cable dB	Preamp dB	Level dBuV/m	Limit dBuV/m	Over limit	Remark
1	1141.78	36.38	25.84	4.53	37.26	29.49	74.00	-44.51	Peak
2	1687.41	35.00	25.16	5.74	37.29	28.61	74.00	-45.39	Peak
3	2449.49	33.75	27.40	6.80	37.59	30.36	74.00	-43.64	Peak
4	3600.63	34.02	29.30	8.27	37.06	34.53	74.00	-39.47	Peak
5	4652.15	31.74	31.06	9.48	36.00	36.28	74.00	-37.72	Peak
6	5645.39	30.99	31.71	10.34	34.34	38.70	74.00	-35.30	Peak

Polarization: Vertical

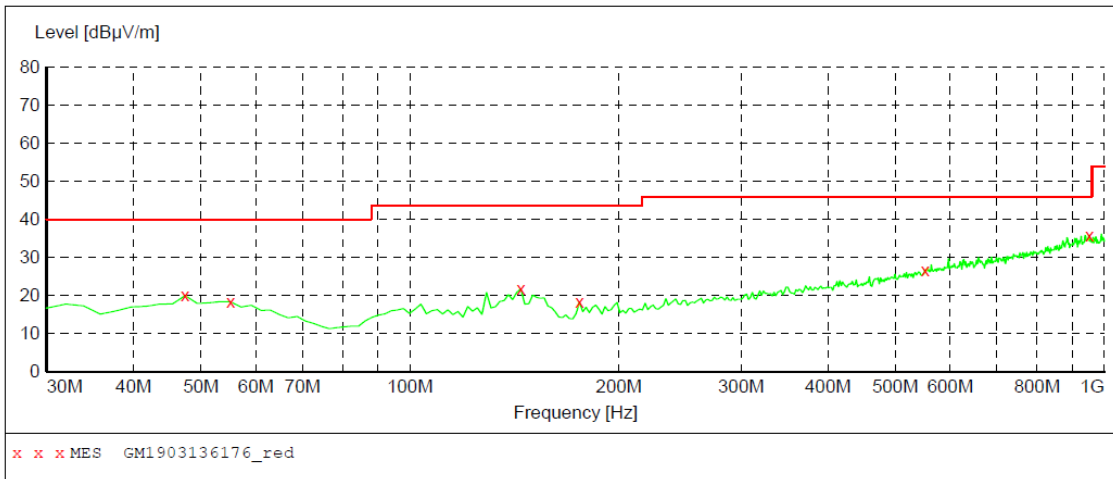

MEASUREMENT RESULT: "GM1903136176_red"

3/13/2019 6:58PM

Frequency MHz	Level dBuV/m	Transd dB	Limit dBuV/m	Margin dB	Det.	Height cm	Azimuth deg	Polarization
47.460000	20.00	-8.7	40.0	20.0	QP	100.0	31.00	VERTICAL
55.220000	18.30	-9.1	40.0	21.7	QP	100.0	3.00	VERTICAL
144.460000	21.70	-13.7	43.5	21.8	QP	100.0	97.00	VERTICAL
175.500000	18.30	-12.4	43.5	25.2	QP	100.0	23.00	VERTICAL
551.860000	26.80	0.0	46.0	19.2	QP	100.0	121.00	VERTICAL
951.500000	35.90	8.2	46.0	10.1	QP	100.0	167.00	VERTICAL

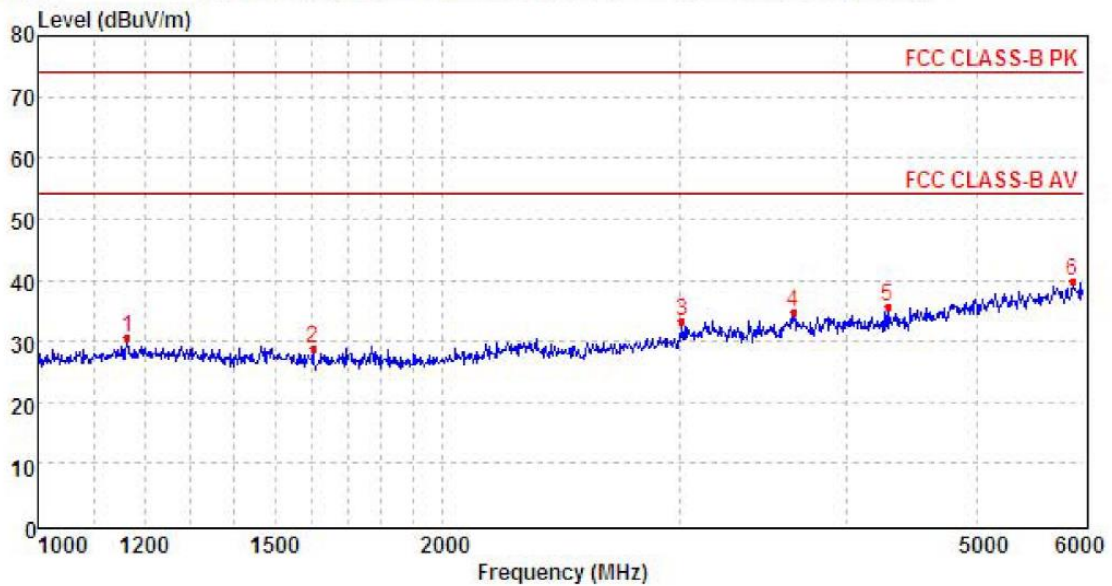

Mark	Frequency MHz	Reading dBuV/m	Antenna dB	Cable dB	Preamp dB	Level dBuV/m	Limit dBuV/m	Over limit	Remark
1	1164.51	37.23	26.02	4.58	37.24	30.59	74.00	-43.41	Peak
2	1601.97	35.64	24.91	5.57	37.19	28.93	74.00	-45.07	Peak
3	3015.37	34.70	28.63	7.50	37.57	33.26	74.00	-40.74	Peak
4	3646.07	34.29	29.30	8.32	37.02	34.89	74.00	-39.11	Peak
5	4284.09	32.86	30.17	9.02	36.49	35.56	74.00	-38.44	Peak
6	5882.90	31.02	32.27	10.62	34.21	39.70	74.00	-34.30	Peak

6. TEST SETUP PHOTOS OF THE EUT

Conducted Emissions (AC Mains)



Radiated Emissions (30MHz-1GHz)



Radiated Emissions (Above 1GHz)

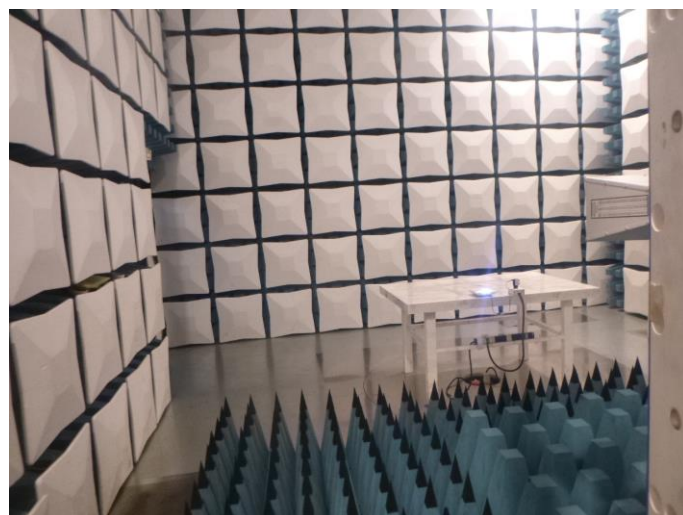

7. EXTERNAL AND INTERNAL PHOTOS OF THE EUT

External Photo

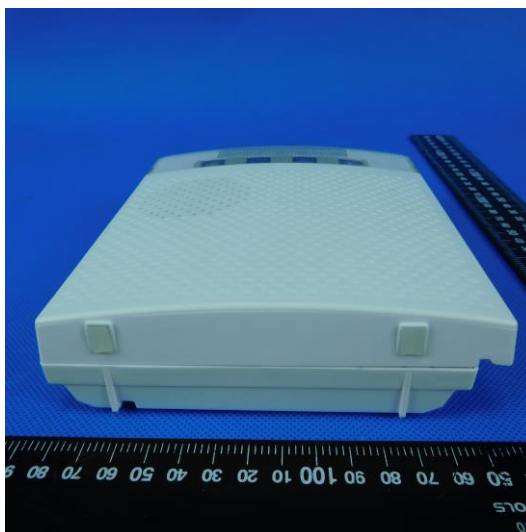

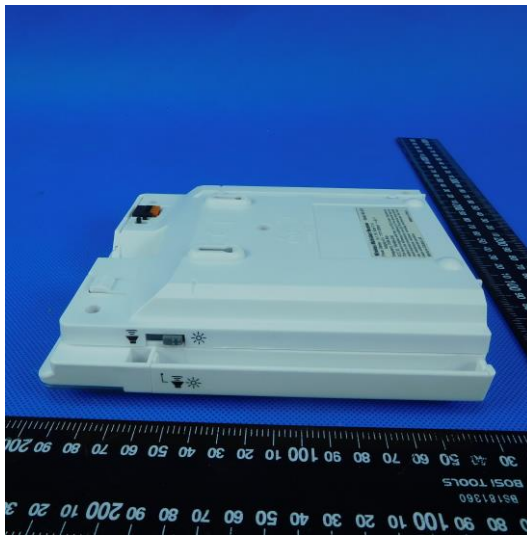
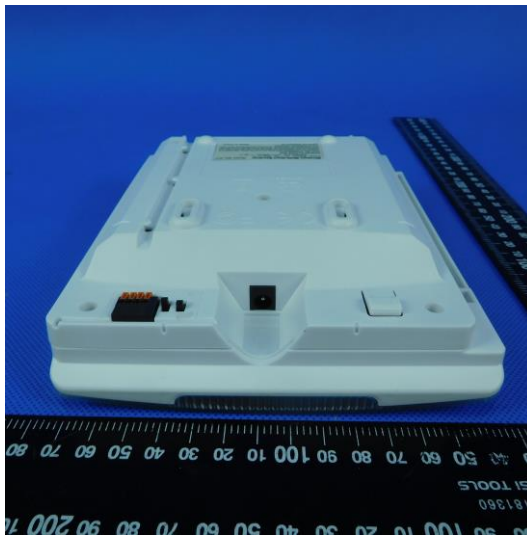
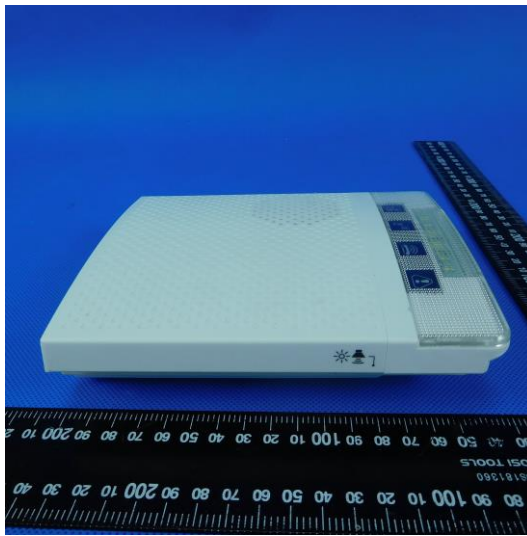

Internal Photo

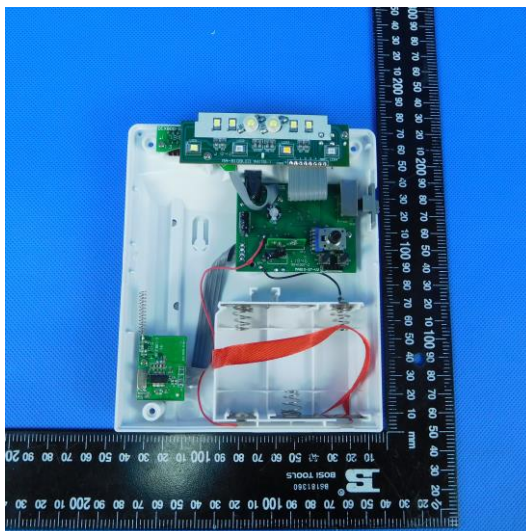
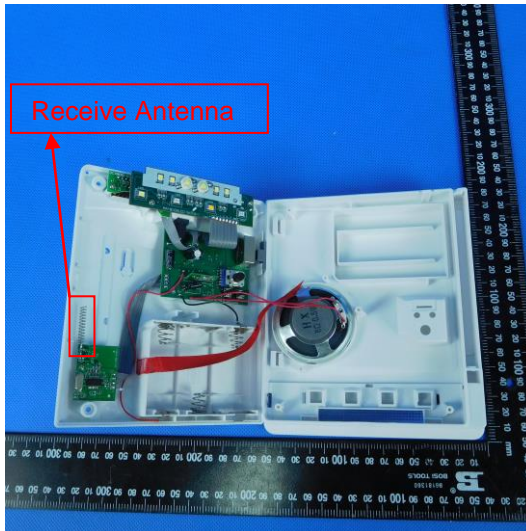
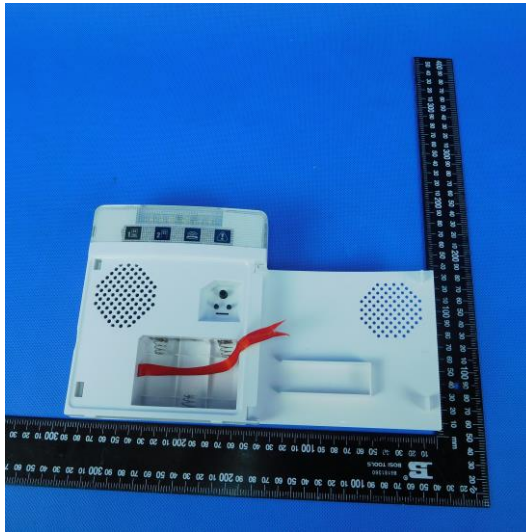

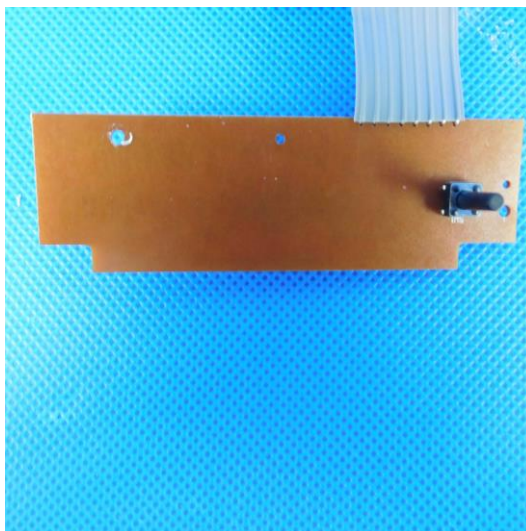
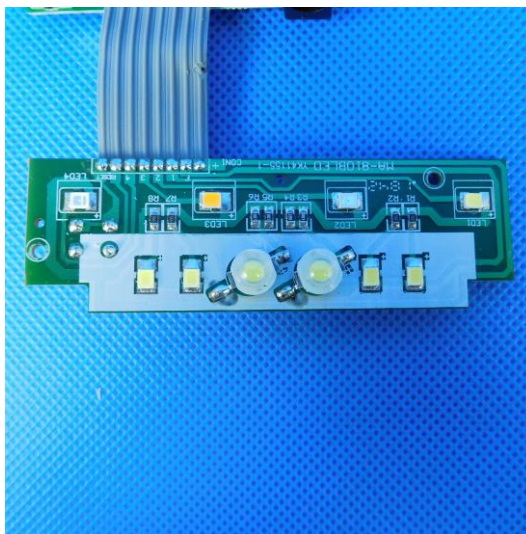
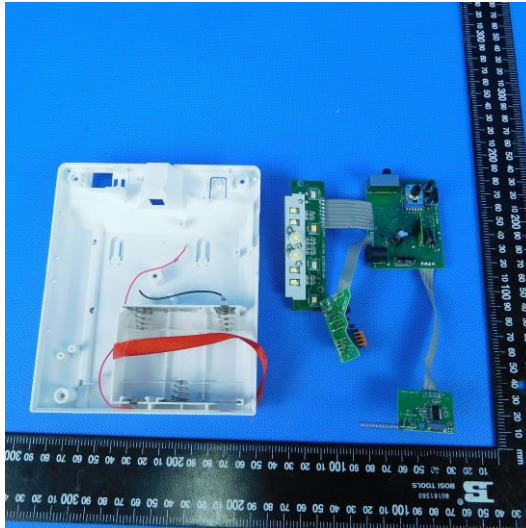

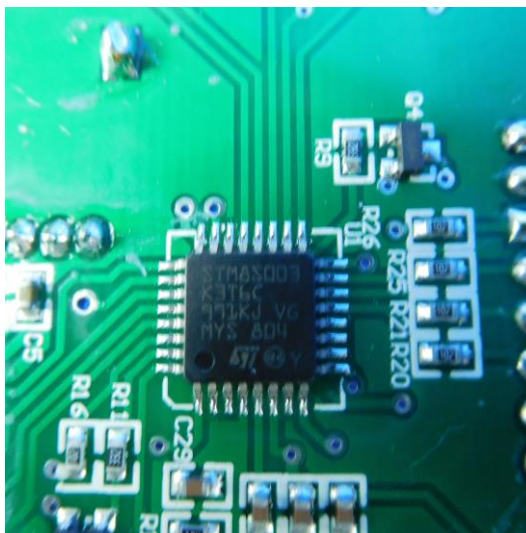
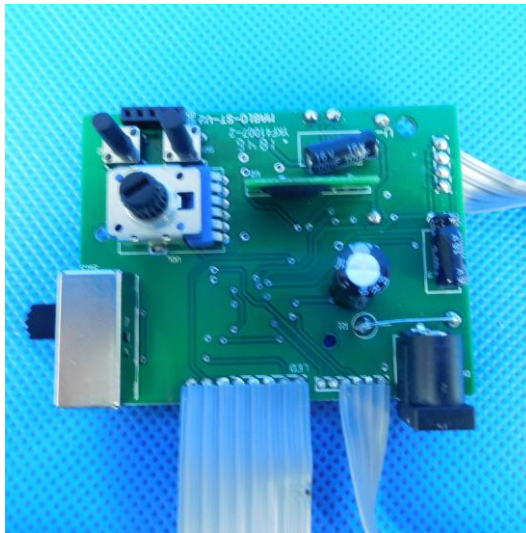
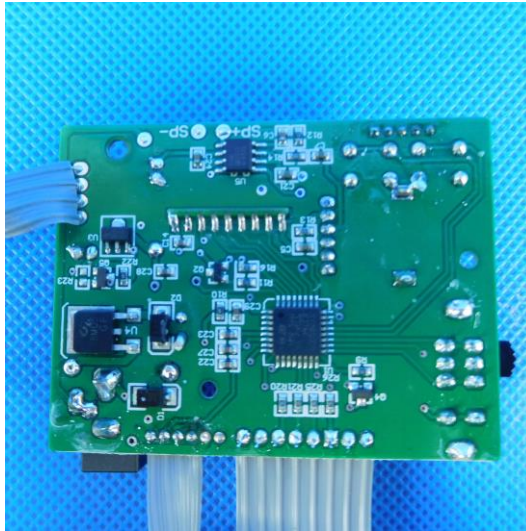

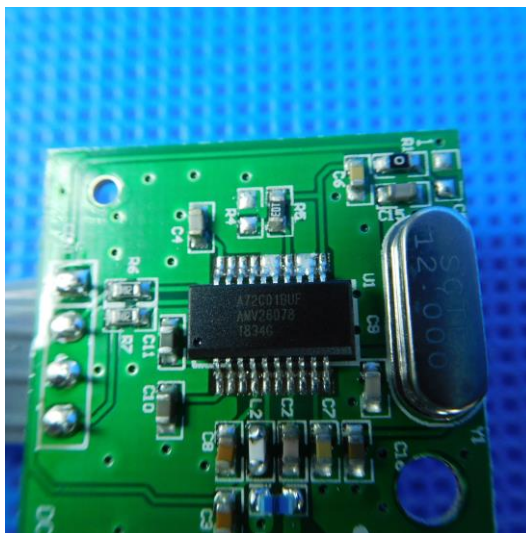
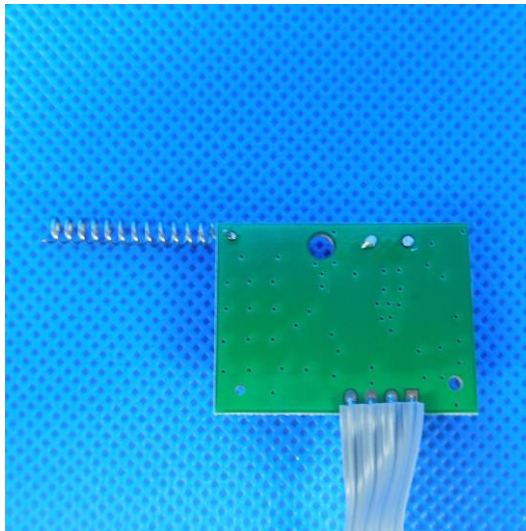

-----End of Report-----