

ELECTROMAGNETIC EMISSIONS COMPLIANCE REPORT

INTENTIONAL RADIATOR CERTIFICATION TO FCC PART 22 SUBPART H, PART 24 SUBPART E

OF

Product Name: GPS/GSM/GPRS Tracker

Brand Name: ATrack

Model Name: AT5

Model Difference: N/A

FCC ID: YA7-ATVT1013

Report No.: EH/2010/30038

Issue Date: Mar. 29, 2010

FCC Rule Part: 2 , 22H, 24E

Prepared for: ATrack Technology Inc.
6F, No. 58, Zhouzi Street, Neihu Dist., Taipei
City 11493, Taiwan (R.O.C)

Prepared by: SGS Taiwan Ltd.
Electronics & Communication Laboratory
No. 134, Wu Kung Rd., Wuku Industrial
Zone, Taipei County, Taiwan.



Note: This report shall not be reproduced except in full, without the written approval of SGS Taiwan Ltd. This document may be altered or revised by SGS Taiwan Ltd. personnel only, and shall be noted in the revision section of the document.

Unless otherwise stated the results shown in this test report refer only to the sample(s) tested and such sample(s) are retained for 90 days only.

除非另有說明，此報告結果僅對測試之樣品負責，同時此樣品僅保留90天。本報告未經本公司書面許可，不可部份複製。

This document is issued by the Company subject to its General Conditions of Service printed overleaf, available on request or accessible at www.sgs.com/terms_and_conditions.htm and, for electronic format documents, subject to Terms and Conditions for Electronic Documents at www.sgs.com/terms_e-document.htm. Attention is drawn to the limitation of liability, indemnification and jurisdiction issues defined therein. Any holder of this document is advised that information contained hereon reflects the Company's findings at the time of its intervention only and within the limits of Client's instructions, if any. The Company's sole responsibility is to its Client and this document does not exonerate parties to a transaction from exercising all their rights and obligations under the transaction documents. This document cannot be reproduced except in full, without prior written approval of the Company. Any unauthorized alteration, forgery or falsification of the content or appearance of this document is unlawful and offenders may be prosecuted to the fullest extent of the law.

VERIFICATION OF COMPLIANCE

Applicant: ATrack Technology Inc.
 6F, No. 58, Zhouzi Street, Neihu Dist., Taipei City 11493, Taiwan
 (R.O.C)

Product Name: GPS/GSM/GPRS Tracker

FCC ID: YA7-ATVT1013

Brand Name: ATrack

Model No.: AT5

Model Difference: N/A

File Number: EH/2010/30038

Date of test: Mar. 15, 2010 ~ Mar. 26, 2010

Date of EUT Received: Mar. 15, 2010

We hereby certify that:

The above equipment was tested by SGS Taiwan Ltd. Electronics & Communication Laboratory. The test data, data evaluation, test procedures, and equipment configurations shown in this report were made in accordance with the procedures given in TIA/EIA-603-C-2004 and the energy emitted by the sample EUT tested as described in this report is in compliance with conducted and radiated emission limits of FCC Rule PART 22 subpart H, PART 24 subpart E.

The test results of this report relate only to the tested sample identified in this report.

Test By:		Date:	Mar. 29, 2010
	_____ <i>Jason Wu / Asst. Supervisor</i>		_____
Prepared By:		Date:	Mar. 29, 2010
	_____ <i>Gigi Yeh / Clerk</i>		_____
Approved By:		Date:	Mar. 29, 2010
	_____ <i>Vincent Su / Manager</i>		_____

Unless otherwise stated the results shown in this test report refer only to the sample(s) tested and such sample(s) are retained for 90 days only.
 除非另有說明，此報告結果僅對測試之樣品負責，同時此樣品僅保留90天。本報告未經本公司書面許可，不可部份複製。
 This document is issued by the Company subject to its General Conditions of Service printed overleaf, available on request or accessible at www.sgs.com/terms_and_conditions.htm and, for electronic format documents, subject to Terms and Conditions for Electronic Documents at www.sgs.com/terms_e-document.htm. Attention is drawn to the limitation of liability, indemnification and jurisdiction issues defined therein. Any holder of this document is advised that information contained hereon reflects the Company's findings at the time of its intervention only and within the limits of Client's instructions, if any. The Company's sole responsibility is to its Client and this document does not exonerate parties to a transaction from exercising all their rights and obligations under the transaction documents. This document cannot be reproduced except in full, without prior written approval of the Company. Any unauthorized alteration, forgery or falsification of the content or appearance of this document is unlawful and offenders may be prosecuted to the fullest extent of the law.

Version

Version No.	Date	Description
00	Mar. 29, 2010	Initial creation of document

Unless otherwise stated the results shown in this test report refer only to the sample(s) tested and such sample(s) are retained for 90 days only.

除非另有說明，此報告結果僅對測試之樣品負責，同時此樣品僅保留90天。本報告未經本公司書面許可，不可部份複製。

This document is issued by the Company subject to its General Conditions of Service printed overleaf, available on request or accessible at www.sgs.com/terms_and_conditions.htm and, for electronic format documents, subject to Terms and Conditions for Electronic Documents at www.sgs.com/terms_e-document.htm. Attention is drawn to the limitation of liability, indemnification and jurisdiction issues defined therein. Any holder of this document is advised that information contained hereon reflects the Company's findings at the time of its intervention only and within the limits of Client's instructions, if any. The Company's sole responsibility is to its Client and this document does not exonerate parties to a transaction from exercising all their rights and obligations under the transaction documents. This document cannot be reproduced except in full, without prior written approval of the Company. Any unauthorized alteration, forgery or falsification of the content or appearance of this document is unlawful and offenders may be prosecuted to the fullest extent of the law.

Table of Contents

1	GENERAL INFORMATION	6
1.1	Related Submittal(s) / Grant (s)	7
1.2	Test Methodology	7
1.3	Test Facility	7
1.4	Special Accessories	7
1.5	Equipment Modifications	7
2	SYSTEM TEST CONFIGURATION	8
2.1.	EUT Configuration	8
2.2.	EUT Exercise	8
2.3.	Test Procedure	8
2.4.	Measurement Equipment Used:	9
2.5.	Configuration of Tested System	11
3	SUMMARY OF TEST RESULTS	12
4	DESCRIPTION OF TEST MODES	13
5	RF POWER OUTPUT MEASUREMENT	14
5.1	Standard Applicable	14
5.2	Test Set-up:	14
5.3	Measurement Procedure	14
5.4	Measurement Equipment Used:	14
5.5	Measurement Result:	15
6	ERP, EIRP MEASUREMENT	16
6.1	Standard Applicable	16
6.2	Test SET-UP (Block Diagram of Configuration)	16
6.3	Measurement Procedure	18
6.4	Measurement Equipment Used:	18
6.5	Measurement Result	19
7	99% OCCUPIED BANDWIDTH MEASUREMENT	20
7.1	Standard Applicable	20
7.2	Test Set-up:	20
7.3	Measurement Procedure	20
7.4	Measurement Equipment Used:	20
7.5	Measurement Result:	21
8	OUT OF BAND EMISSION AT ANTENNA TERMINALS	25
8.1	Standard Applicable	25

Unless otherwise stated the results shown in this test report refer only to the sample(s) tested and such sample(s) are retained for 90 days only.

除非另有說明，此報告結果僅對測試之樣品負責，同時此樣品僅保留90天。本報告未經本公司書面許可，不可部份複製。

This document is issued by the Company subject to its General Conditions of Service printed overleaf, available on request or accessible at www.sgs.com/terms_and_conditions.htm and, for electronic format documents, subject to Terms and Conditions for Electronic Documents at www.sgs.com/terms_e-document.htm. Attention is drawn to the limitation of liability, indemnification and jurisdiction issues defined therein. Any holder of this document is advised that information contained hereon reflects the Company's findings at the time of its intervention only and within the limits of Client's instructions, if any. The Company's sole responsibility is to its Client and this document does not exonerate parties to a transaction from exercising all their rights and obligations under the transaction documents. This document cannot be reproduced except in full, without prior written approval of the Company. Any unauthorized alteration, forgery or falsification of the content or appearance of this document is unlawful and offenders may be prosecuted to the fullest extent of the law.

8.2 Test SET-UP..... 25

8.3 Measurement Procedure..... 25

8.4 Measurement Equipment Used: 25

8.5 Measurement Result..... 26

9 FIELD STRENGTH OF SPURIOUS RADIATION MEASUREMENT 34

9.1 Standard Applicable 34

9.2 EUT Setup (Block Diagram of Configuration) 34

9.3 Measurement Procedure..... 36

9.4 Measurement Equipment Used: 36

9.5 Measurement Result..... 36

10 FREQUENCY STABILITY V.S. TEMPERATURE MEASUREMENT 49

10.1 Standard Applicable 49

10.2 Test Set-up: 49

10.3 Measurement Procedure..... 49

10.4 Measurement Equipment Used: 49

10.5 Measurement Result..... 50

11 FREQUENCY STABILITY V.S. VOLTAGE MEASUREMENT 51

11.1 Standard Applicable 51

11.2 Test Set-up: 51

11.3 Measurement Procedure..... 51

11.4 Measurement Equipment Used: 51

11.5 Measurement Result..... 52

Unless otherwise stated the results shown in this test report refer only to the sample(s) tested and such sample(s) are retained for 90 days only.
 除非另有說明，此報告結果僅對測試之樣品負責，同時此樣品僅保留90天。本報告未經本公司書面許可，不可部份複製。
 This document is issued by the Company subject to its General Conditions of Service printed overleaf, available on request or accessible at www.sgs.com/terms_and_conditions.htm and, for electronic format documents, subject to Terms and Conditions for Electronic Documents at www.sgs.com/terms_e-document.htm. Attention is drawn to the limitation of liability, indemnification and jurisdiction issues defined therein. Any holder of this document is advised that information contained hereon reflects the Company's findings at the time of its intervention only and within the limits of Client's instructions, if any. The Company's sole responsibility is to its Client and this document does not exonerate parties to a transaction from exercising all their rights and obligations under the transaction documents. This document cannot be reproduced except in full, without prior written approval of the Company. Any unauthorized alteration, forgery or falsification of the content or appearance of this document is unlawful and offenders may be prosecuted to the fullest extent of the law.

1 GENERAL INFORMATION

General:

Product Name	GPS/GSM/GPRS Tracker		
Brand Name	ATrack		
Model Name	AT5		
Model Difference	N/A		
Power Supply	3.7V Vdc re-chargeable battery or 12V/24V form car battery		
	Battery:	1. Model No.: LP086C-900, Brand Name: EIZON	

GSM:

Cellular Phone Standards Frequency Range and Power:	Operating Frequency		Rated Power
	GSM/GPRS 850, Class 10	824.2 MHz– 848.8 MHz	33 dBm
	GSM/GPRS 900, Class 10	880.2MHz – 914.8MHz	33 dBm
	GSM/GPRS 1800, Class 10	1710.2MHz – 1784.8MHz	30 dBm
	GSM/GPRS 1900, Class 10	1850.2MHz – 1909.8MHz	30 dBm
Hardware Version:	1.2		
Software Version:	1.07		
Type of Emission:	22H(GMSK): 824.2 - 848.8 MHz: 243KGXW 24E(GMSK): 1850.2 – 1909.8 MHz: 242KGXW		
IMEI:	357460030440890		

GPS:

Receiver Frequency	L1 Band, 1575.42MHz
Frequency Conversion os- cillator	19.2MHz
Antenna Designation	Patch Antenna

This test report applies for GSM/GPRS/850/1900 MHz.

The product sold in U.S use the GSM 850: 824.2~848.8MHz and GSM1900: 1850.2~1909.8MHz.

Unless otherwise stated the results shown in this test report refer only to the sample(s) tested and such sample(s) are retained for 90 days only.

除非另有說明，此報告結果僅對測試之樣品負責，同時此樣品僅保留90天。本報告未經本公司書面許可，不可部份複製。

This document is issued by the Company subject to its General Conditions of Service printed overleaf, available on request or accessible at www.sgs.com/terms_and_conditions.htm and, for electronic format documents, subject to Terms and Conditions for Electronic Documents at www.sgs.com/terms_e-document.htm. Attention is drawn to the limitation of liability, indemnification and jurisdiction issues defined therein. Any holder of this document is advised that information contained hereon reflects the Company's findings at the time of its intervention only and within the limits of Client's instructions, if any. The Company's sole responsibility is to its Client and this document does not exonerate parties to a transaction from exercising all their rights and obligations under the transaction documents. This document cannot be reproduced except in full, without prior written approval of the Company. Any unauthorized alteration, forgery or falsification of the content or appearance of this document is unlawful and offenders may be prosecuted to the fullest extent of the law.

1.1 Related Submittal(s) / Grant (s)

This submittal(s) (test report) is intended for FCC ID: YA7-ATVT1013 filing to comply with Section Part 22 subpart H, Part 24 subpart E.

1.2 Test Methodology

Both conducted and radiated testing were performed according to the procedures document on TIA/EIA 603C and FCC 47 CFR 2.1046, 2.1047, 2.1049, 2.1051, 2.1053, 2.1055, 2.1057.

1.3 Test Facility

The measurement facilities used to collect the 3m Radiated Emission and AC power line conducted data are located on the address of SGS Taiwan Ltd. Electronics & Communication Laboratory No. 134, Wu Kung Rd., Wuku Industrial Zone, Taipei Country, Taiwan which are constructed and calibrated to meet the FCC requirements in documents ANSI C63.4: 2003. FCC Registration Number are: 990257 and 236194, Canada Registration Number: 4620A-1

The 10 m Open Area Test Sites located on the address of SGS Taiwan Ltd. Electronics & Communication Laboratory No. 29, Pau-Tou-Tsuo Valley Chia-Pau Tsuen, Linkou Hsiang, Taipei county, which is constructed and calibrated to meet the CISPR 22/EN 55022 requirements. SGS Site No. 1(3 &10 meters) and FCC Registration Number: 94644.

1.4 Special Accessories

Not available for this EUT intended for grant.

1.5 Equipment Modifications

Not available for this EUT intended for grant.

Unless otherwise stated the results shown in this test report refer only to the sample(s) tested and such sample(s) are retained for 90 days only.

除非另有說明，此報告結果僅對測試之樣品負責，同時此樣品僅保留90天。本報告未經本公司書面許可，不可部份複製。

This document is issued by the Company subject to its General Conditions of Service printed overleaf, available on request or accessible at www.sgs.com/terms_and_conditions.htm and, for electronic format documents, subject to Terms and Conditions for Electronic Documents at www.sgs.com/terms_e-document.htm. Attention is drawn to the limitation of liability, indemnification and jurisdiction issues defined therein. Any holder of this document is advised that information contained hereon reflects the Company's findings at the time of its intervention only and within the limits of Client's instructions, if any. The Company's sole responsibility is to its Client and this document does not exonerate parties to a transaction from exercising all their rights and obligations under the transaction documents. This document cannot be reproduced except in full, without prior written approval of the Company. Any unauthorized alteration, forgery or falsification of the content or appearance of this document is unlawful and offenders may be prosecuted to the fullest extent of the law.

2 SYSTEM TEST CONFIGURATION

2.1. EUT Configuration

The EUT configuration for testing is installed on RF field strength measurement to meet the Commissions requirement and operating in a manner which intends to maximize its emission characteristics in a continuous normal application.

2.2. EUT Exercise

The EUT (Transmitter) was operated in the engineering mode to fix the Tx frequency which was for the purpose of the measurements.

2.3. Test Procedure

2.3.1 Conducted Measurement at Antenna Port:

According to measurement procured TIA/EIA 603C, the EUT is placed on a turn table which is 0.8 m above ground plane. A low loss of RF cable was used to connect the antenna port of EUT to measurement equipment.

2.3.2 Radiated Emissions (ERP/EIRP):

According to measurement procured TIA/EIA 603C and TIA/EIA IS-98 for Mobile stations. The EUT is placed on a turn table which is 0.8 m above ground plane. The turn table shall rotate 360 degrees to determine the position of maximum emission level. EUT is set 3m away from the receiving antenna which varied from 1m to 4m to find out the highest emission. And also, each emission was to be maximized by changing the polarization of receiving antenna both horizontal and vertical. In order to find out the max. emission, the relative positions of this hand-held transmitter (EUT) was rotated through three orthogonal axes according to the requirements.

A standard antenna was used to replace the EUT and connect to the SG. Adjust the SG output level to reach the max emission level which were measured above.

Unless otherwise stated the results shown in this test report refer only to the sample(s) tested and such sample(s) are retained for 90 days only.

除非另有說明，此報告結果僅對測試之樣品負責，同時此樣品僅保留90天。本報告未經本公司書面許可，不可部份複製。

This document is issued by the Company subject to its General Conditions of Service printed overleaf, available on request or accessible at www.sgs.com/terms_and_conditions.htm and, for electronic format documents, subject to Terms and Conditions for Electronic Documents at www.sgs.com/terms_e-document.htm. Attention is drawn to the limitation of liability, indemnification and jurisdiction issues defined therein. Any holder of this document is advised that information contained hereon reflects the Company's findings at the time of its intervention only and within the limits of Client's instructions, if any. The Company's sole responsibility is to its Client and this document does not exonerate parties to a transaction from exercising all their rights and obligations under the transaction documents. This document cannot be reproduced except in full, without prior written approval of the Company. Any unauthorized alteration, forgery or falsification of the content or appearance of this document is unlawful and offenders may be prosecuted to the fullest extent of the law.

2.4. Measurement Equipment Used:

Conducted Emission Test Site					
EQUIPMENT TYPE	MFR	MODEL NUMBER	SERIAL NUMBER	LAST CAL.	CAL DUE.
Spectrum Analyzer	Agilent	E4446A	MY43360126	04/19/2008	04/18/2010
Spectrum Analyzer	Agilent	E4440A	US41160416	01/23/2010	01/22/2012
Radio Communication Analyzer	R&S	CMU200	102189	05/13/2008	05/13/2010
800 – 1000MHz Filter	Micro-Tronics	BRM13462	001	01/04/2009	01/03/2011
1800 – 2000MHz Filter	Micro-Tronics	BRM13463	001	01/04/2009	01/03/2011
Temperature Chamber	TERCHY	MHG-120LF	911009	04/14/2008	04/13/2010
Temperature Chamber	GIANT FORCE	GTH-150-40-CP-AR	MAA0512-018	02/05/2010	02/04/2012
DC Block	Agilent	BLK-18	155452	07/05/2009	07/04/2010
Attenuator	Mini-Circuit	BW-S20W5	N/A	07/05/2009	07/04/2010
Attenuator	Mini-Circuit	BW-S10W5	N/A	07/05/2009	07/04/2010
Attenuator	Mini-Circuit	BW-S6W5	N/A	07/05/2009	07/04/2010
Splitter	Agilent	11636B	N/A	07/05/2009	07/04/2010
DC Power Supply	HP	6038A	2929A-07548	06/27/2009	06/26/2011
DC Power Supply	Topward	3303D	981327	10/26/2008	10/25/2010

Unless otherwise stated the results shown in this test report refer only to the sample(s) tested and such sample(s) are retained for 90 days only.
 除非另有說明，此報告結果僅對測試之樣品負責，同時此樣品僅保留90天。本報告未經本公司書面許可，不可部份複製。
 This document is issued by the Company subject to its General Conditions of Service printed overleaf, available on request or accessible at www.sgs.com/terms_and_conditions.htm and, for electronic format documents, subject to Terms and Conditions for Electronic Documents at www.sgs.com/terms_e-document.htm. Attention is drawn to the limitation of liability, indemnification and jurisdiction issues defined therein. Any holder of this document is advised that information contained hereon reflects the Company's findings at the time of its intervention only and within the limits of Client's instructions, if any. The Company's sole responsibility is to its Client and this document does not exonerate parties to a transaction from exercising all their rights and obligations under the transaction documents. This document cannot be reproduced except in full, without prior written approval of the Company. Any unauthorized alteration, forgery or falsification of the content or appearance of this document is unlawful and offenders may be prosecuted to the fullest extent of the law.

ERP, EIRP MEASUREMENT EQUIPMENT List 966 Chamber					
EQUIPMENT TYPE	MFR	MODEL NUMBER	SERIAL NUMBER	LAST CAL.	CAL DUE.
Spectrum Analyzer	R&S	FSP 40	100034	02/12/2010	02/11/2011
Bilog Antenna	SCHWAZBECK	VULB9160	9160-3136	11/19/2009	11/18/2010
Dipole Antenna	SCHWAZBECK	VHAP	908/909	07/10/2008	07/09/2010
Dipole Antenna	SCHWAZBECK	UHAP	891/892	07/10/2008	07/09/2010
Hor.n antenna	SCHWAZBECK	BBHA 9120D	309	05/09/2008	05/10/2010
Horn antenna	SCHWAZBECK	BBHA 9120D	9120D-673	05/09/2008	05/08/2010
Signal Generator	R&S	SMR40	100210	01/22/2010	01/21/2012
Signal Generator	Agilent	E4438C	MY45093613	05/22/2009	05/21/2010
Pre-Amplifier	Agilent	8447D	1937A02834	11/28/2009	11/27/2010
Pre-Amplifier	Agilent	8449B	3008A01973	01/04/2010	01/03/2011
Attenuator	Mini-Circuit	BW-S20W5	001	07/05/2009	07/04/2010
Attenuator	Mini-Circuit	BW-S10W5	001	07/05/2009	07/04/2010
Attenuator	Mini-Circuit	BW-S6W5	001	07/05/2009	07/04/2010
Radio Communication Analyzer	R&S	CMU200	102189	05/13/2008	05/13/2010
Turn Table	HD	DT420	N/A	N.C.R	N.C.R
Antenna Tower	HD	MA240-N	240/657	N.C.R	N.C.R
Controller	HD	HD100	N/A	N.C.R	N.C.R
Low Loss Cable	HUBER+SUHNER	SUCOFLEX 104PEA-10M	10m	01/04/2010	01/03/2011
Low Loss Cable	HUBER+SUHNER	SUCOFLEX 104PEA-3M	3m	01/04/2010	01/03/2011
3m Site	SGS	966 chamber	N/A	11/08/2009	11/07/2010

Unless otherwise stated the results shown in this test report refer only to the sample(s) tested and such sample(s) are retained for 90 days only.

除非另有說明，此報告結果僅對測試之樣品負責，同時此樣品僅保留90天。本報告未經本公司書面許可，不可部份複製。

This document is issued by the Company subject to its General Conditions of Service printed overleaf, available on request or accessible at www.sgs.com/terms_and_conditions.htm and, for electronic format documents, subject to Terms and Conditions for Electronic Documents at www.sgs.com/terms_e-document.htm. Attention is drawn to the limitation of liability, indemnification and jurisdiction issues defined therein. Any holder of this document is advised that information contained hereon reflects the Company's findings at the time of its intervention only and within the limits of Client's instructions, if any. The Company's sole responsibility is to its Client and this document does not exonerate parties to a transaction from exercising all their rights and obligations under the transaction documents. This document cannot be reproduced except in full, without prior written approval of the Company. Any unauthorized alteration, forgery or falsification of the content or appearance of this document is unlawful and offenders may be prosecuted to the fullest extent of the law.

2.5. Configuration of Tested System

Fig. 2-1 Configuration of Tested System (Fixed Channel)

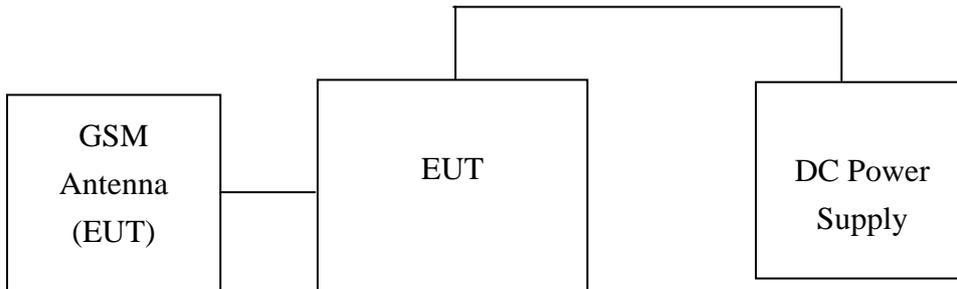

Fig. 2-2 Configuration of Tested System (Remote Side)

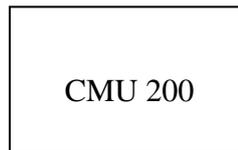

Table 2-1 Equipment Used in Tested System

Item	Equipment	Mfr/Brand	Model/Type No.	FCC ID	Series No.
1.	Radio Communication Analyzer	R&S	CMU200	N/A	102189
2.	DC Power Supply	Topward	3303A	N/A	715856

Unless otherwise stated the results shown in this test report refer only to the sample(s) tested and such sample(s) are retained for 90 days only.

除非另有說明，此報告結果僅對測試之樣品負責，同時此樣品僅保留90天。本報告未經本公司書面許可，不可部份複製。

This document is issued by the Company subject to its General Conditions of Service printed overleaf, available on request or accessible at www.sgs.com/terms_and_conditions.htm and, for electronic format documents, subject to Terms and Conditions for Electronic Documents at www.sgs.com/terms_e-document.htm. Attention is drawn to the limitation of liability, indemnification and jurisdiction issues defined therein. Any holder of this document is advised that information contained hereon reflects the Company's findings at the time of its intervention only and within the limits of Client's instructions, if any. The Company's sole responsibility is to its Client and this document does not exonerate parties to a transaction from exercising all their rights and obligations under the transaction documents. This document cannot be reproduced except in full, without prior written approval of the Company. Any unauthorized alteration, forgery or falsification of the content or appearance of this document is unlawful and offenders may be prosecuted to the fullest extent of the law.

3 SUMMARY OF TEST RESULTS

FCC Rules	Description Of Test	Result
§2.1046(a) §22.913(a)(2) §24.232(c)	RF Conducted Power Output	Compliant
§2.1046(a) §22.913(a)(2) §24.232(c)	ERP/EIRP measurement	Compliant
§2.1049(h)	99% Occupied Bandwidth	Compliant
§2.1051 §22.917(a) §24.238(a)	Out of Band Emissions at Antenna Terminals	Compliant
§2.1053 §22.917(a) §24.238(a)	Field Strength of Spurious Radiation (TX)	Compliant
§2.1055(a)(1) §22.355 §24.235	Frequency Stability vs. Temperature	Compliant
§2.1055(d)(2) §22.355 §24.235-	Frequency Stability vs. Voltage	Compliant

Unless otherwise stated the results shown in this test report refer only to the sample(s) tested and such sample(s) are retained for 90 days only.

除非另有說明，此報告結果僅對測試之樣品負責，同時此樣品僅保留90天。本報告未經本公司書面許可，不可部份複製。

This document is issued by the Company subject to its General Conditions of Service printed overleaf, available on request or accessible at www.sgs.com/terms_and_conditions.htm and, for electronic format documents, subject to Terms and Conditions for Electronic Documents at www.sgs.com/terms_e-document.htm. Attention is drawn to the limitation of liability, indemnification and jurisdiction issues defined therein. Any holder of this document is advised that information contained hereon reflects the Company's findings at the time of its intervention only and within the limits of Client's instructions, if any. The Company's sole responsibility is to its Client and this document does not exonerate parties to a transaction from exercising all their rights and obligations under the transaction documents. This document cannot be reproduced except in full, without prior written approval of the Company. Any unauthorized alteration, forgery or falsification of the content or appearance of this document is unlawful and offenders may be prosecuted to the fullest extent of the law.

4 DESCRIPTION OF TEST MODES

The EUT has been tested under operating condition.

EUT staying in continuous transmitting mode. Channel Low, Mid and High for each type band with rated data rate were chosen for full testing.

The field strength of spurious radiation emission was measured for GPRS 850 and 1900 bands, respectively.

Max ERP/EIRP measurement result:

	dBm	dB	W
GSM 850 Band	30.86	ERP	1.219
GSM 1900 Band	25.35	EIRP	0.343

Unless otherwise stated the results shown in this test report refer only to the sample(s) tested and such sample(s) are retained for 90 days only.

除非另有說明，此報告結果僅對測試之樣品負責，同時此樣品僅保留90天。本報告未經本公司書面許可，不可部份複製。

This document is issued by the Company subject to its General Conditions of Service printed overleaf, available on request or accessible at www.sgs.com/terms_and_conditions.htm and, for electronic format documents, subject to Terms and Conditions for Electronic Documents at www.sgs.com/terms_e-document.htm. Attention is drawn to the limitation of liability, indemnification and jurisdiction issues defined therein. Any holder of this document is advised that information contained hereon reflects the Company's findings at the time of its intervention only and within the limits of Client's instructions, if any. The Company's sole responsibility is to its Client and this document does not exonerate parties to a transaction from exercising all their rights and obligations under the transaction documents. This document cannot be reproduced except in full, without prior written approval of the Company. Any unauthorized alteration, forgery or falsification of the content or appearance of this document is unlawful and offenders may be prosecuted to the fullest extent of the law.

5 RF POWER OUTPUT MEASUREMENT

5.1 Standard Applicable

According to FCC §2.1046.

FCC 22.913(a) Mobile station are limited to 7W.

FCC 24.232(c) Peak Power Measurement.

5.2 Test Set-up:

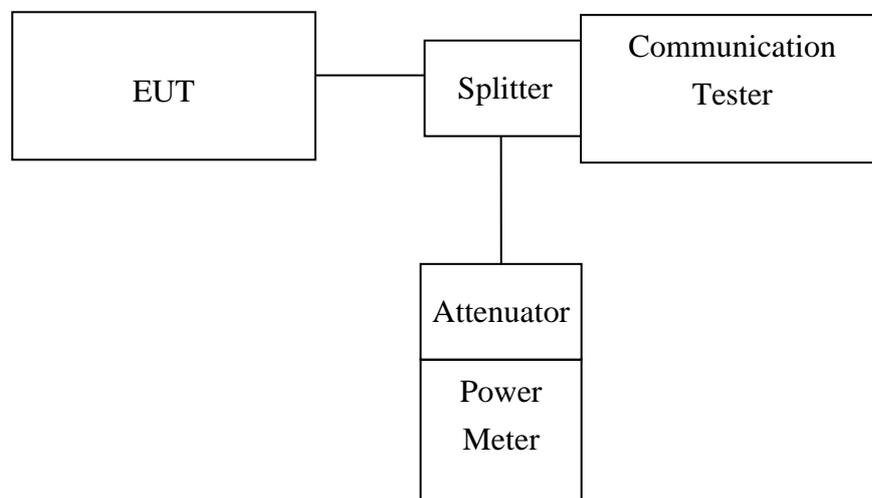

Note: Measurement setup for testing on Antenna connector

5.3 Measurement Procedure

The transmitter output was connected to a calibrated attenuator, the other end of which was connected to a power meter. Transmitter output was read off the power meter in dBm. The power output at the transmitter antenna port was determined by adding the value of the attenuator to the power meter reading.

5.4 Measurement Equipment Used:

Refer to section 2.4 in this report

Unless otherwise stated the results shown in this test report refer only to the sample(s) tested and such sample(s) are retained for 90 days only.

除非另有說明，此報告結果僅對測試之樣品負責，同時此樣品僅保留90天。本報告未經本公司書面許可，不可部份複製。

This document is issued by the Company subject to its General Conditions of Service printed overleaf, available on request or accessible at www.sgs.com/terms_and_conditions.htm and, for electronic format documents, subject to Terms and Conditions for Electronic Documents at www.sgs.com/terms_e-document.htm. Attention is drawn to the limitation of liability, indemnification and jurisdiction issues defined therein. Any holder of this document is advised that information contained hereon reflects the Company's findings at the time of its intervention only and within the limits of Client's instructions, if any. The Company's sole responsibility is to its Client and this document does not exonerate parties to a transaction from exercising all their rights and obligations under the transaction documents. This document cannot be reproduced except in full, without prior written approval of the Company. Any unauthorized alteration, forgery or falsification of the content or appearance of this document is unlawful and offenders may be prosecuted to the fullest extent of the law.

5.5 Measurement Result:

5.5.1 RF Conducted Output Power

5.5.1.1.: GSM (GMSK)

Result:

EUT Mode	Frequency (MHz)	CH	Peak Power (1DN 1UP) (dBm)	Avg. Power (1DN 1UP) (dBm)	Peak Power (1DN 2UP) (dBm)	Avg. Power (1DN 2UP) (dBm)
GPRS 850 (Class 10)	824.2	128	33.00	32.90	32.80	32.70
	836.6	190	32.90	32.80	32.80	32.70
	848.8	251	32.50	32.40	32.40	32.30

EUT Mode	Frequency (MHz)	CH	Peak Power (1DN 1UP) (dBm)	Avg. Power (1DN 1UP) (dBm)	Peak Power (1DN 2UP) (dBm)	Avg. Power (1DN 2UP) (dBm)
GPRS 1900 (Class 10)	1850.2	512	28.90	28.80	28.80	28.70
	1880.0	661	28.70	28.60	28.60	28.50
	1909.8	810	28.30	28.20	28.20	28.10

Maximum Power Reduction: PCS1900 band

PCL	0	1	2	3	4	5	6	7	8
Output power (dBm)	28.8	27.2	25.6	23.8	22.4	20.6	18.4	16.2	14.4
PCL	9	10	11	12	13	14	15	16	17
Output power (dBm)	12.4	10.3	8.4	6.2	4.2	1.7	0.1		

Note: The EUT output power was controlled by simulator. Set Communication Tester CMU200 PCL as above, and get the mobile phone output power reading.

Unless otherwise stated the results shown in this test report refer only to the sample(s) tested and such sample(s) are retained for 90 days only.
 除非另有說明，此報告結果僅對測試之樣品負責，同時此樣品僅保留90天。本報告未經本公司書面許可，不可部份複製。
 This document is issued by the Company subject to its General Conditions of Service printed overleaf, available on request or accessible at www.sgs.com/terms_and_conditions.htm and, for electronic format documents, subject to Terms and Conditions for Electronic Documents at www.sgs.com/terms_e-document.htm. Attention is drawn to the limitation of liability, indemnification and jurisdiction issues defined therein. Any holder of this document is advised that information contained hereon reflects the Company's findings at the time of its intervention only and within the limits of Client's instructions, if any. The Company's sole responsibility is to its Client and this document does not exonerate parties to a transaction from exercising all their rights and obligations under the transaction documents. This document cannot be reproduced except in full, without prior written approval of the Company. Any unauthorized alteration, forgery or falsification of the content or appearance of this document is unlawful and offenders may be prosecuted to the fullest extent of the law.

6 ERP, EIRP MEASUREMENT

6.1 Standard Applicable

According to FCC §2.1046

FCC 22.913(a) Mobile station are limited to 7W ERP.

FCC 24.232(c) Mobile station are limited to 2W EIRP.

6.2 Test SET-UP (Block Diagram of Configuration)

(A) Radiated Emission Test Set-Up, Frequency Below 1000MHz

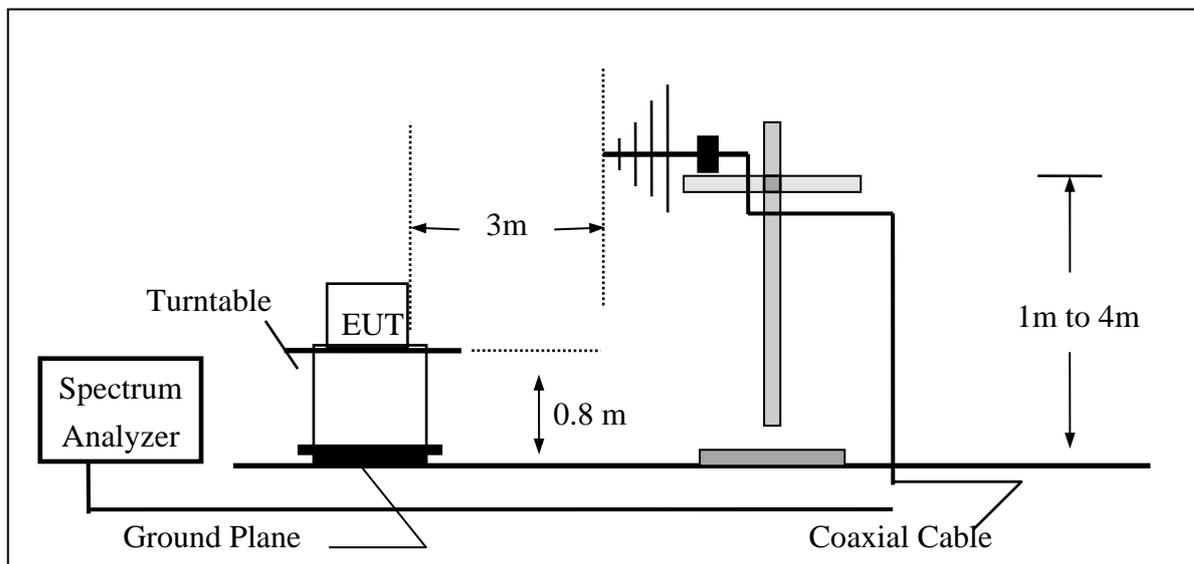

Unless otherwise stated the results shown in this test report refer only to the sample(s) tested and such sample(s) are retained for 90 days only.

除非另有說明，此報告結果僅對測試之樣品負責，同時此樣品僅保留90天。本報告未經本公司書面許可，不可部份複製。

This document is issued by the Company subject to its General Conditions of Service printed overleaf, available on request or accessible at www.sgs.com/terms_and_conditions.htm and, for electronic format documents, subject to Terms and Conditions for Electronic Documents at www.sgs.com/terms_e-document.htm. Attention is drawn to the limitation of liability, indemnification and jurisdiction issues defined therein. Any holder of this document is advised that information contained hereon reflects the Company's findings at the time of its intervention only and within the limits of Client's instructions, if any. The Company's sole responsibility is to its Client and this document does not exonerate parties to a transaction from exercising all their rights and obligations under the transaction documents. This document cannot be reproduced except in full, without prior written approval of the Company. Any unauthorized alteration, forgery or falsification of the content or appearance of this document is unlawful and offenders may be prosecuted to the fullest extent of the law.

(B) Radiated Emission Test Set-UP Frequency Over 1 GHz

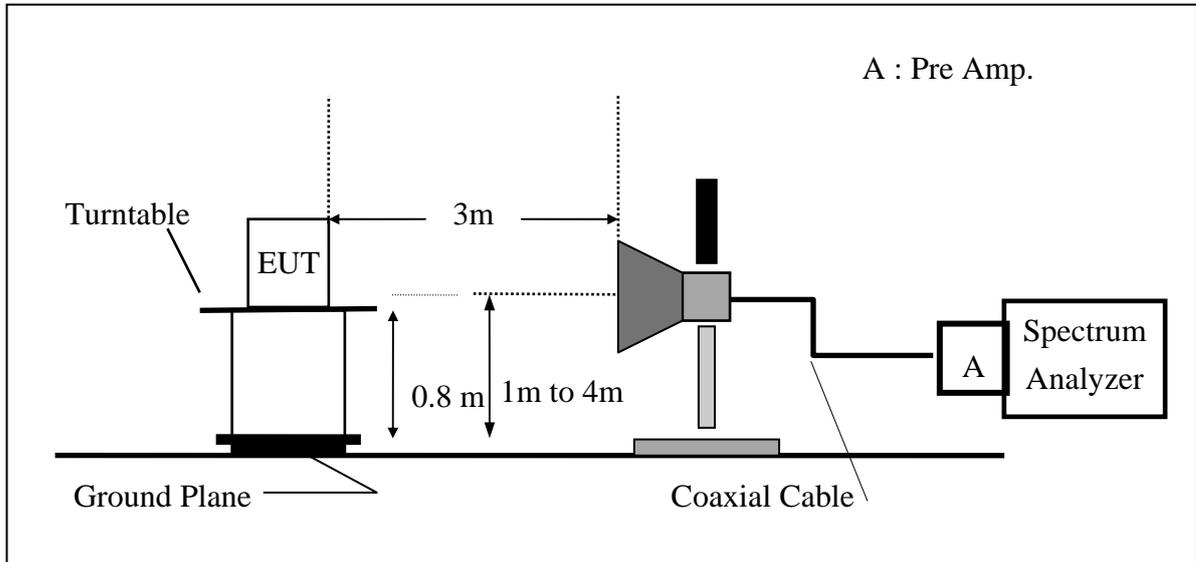

(C) Substituted Method Test Set-UP

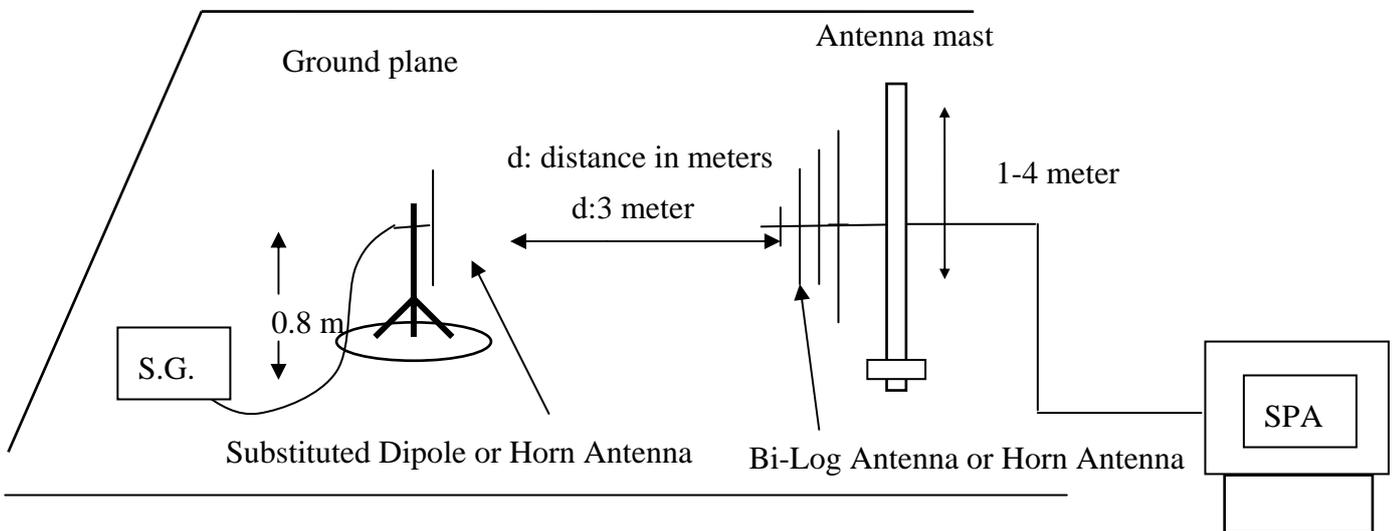

Unless otherwise stated the results shown in this test report refer only to the sample(s) tested and such sample(s) are retained for 90 days only.
 除非另有說明，此報告結果僅對測試之樣品負責，同時此樣品僅保留90天。本報告未經本公司書面許可，不可部份複製。
 This document is issued by the Company subject to its General Conditions of Service printed overleaf, available on request or accessible at www.sgs.com/terms_and_conditions.htm and, for electronic format documents, subject to Terms and Conditions for Electronic Documents at www.sgs.com/terms_e-document.htm. Attention is drawn to the limitation of liability, indemnification and jurisdiction issues defined therein. Any holder of this document is advised that information contained hereon reflects the Company's findings at the time of its intervention only and within the limits of Client's instructions, if any. The Company's sole responsibility is to its Client and this document does not exonerate parties to a transaction from exercising all their rights and obligations under the transaction documents. This document cannot be reproduced except in full, without prior written approval of the Company. Any unauthorized alteration, forgery or falsification of the content or appearance of this document is unlawful and offenders may be prosecuted to the fullest extent of the law.

6.3 Measurement Procedure

The EUT was placed on a non-conductive turntable using a non-conductive support. The radiated emission at the fundamental frequency was measured at 3 m with a test antenna and EMI spectrum analyzer.

During the measurement, the EUT was communication with the station. The highest emission was recorded with the rotation of the turntable and the lowering of the test antenna from 4m to 1m. The reading was recorded and the field strength (E in dBuV/m) was calculated.

ERP in frequency band 824 –850 MHz were measured using a substitution method. The EUT was replaced by dipole antenna connected, the S.G. output was recorded and ERP was calculated as follows:

EIRP in frequency band 1710-1755MHz and 1850 –1910MHz were measured using a substitution method. The EUT was replaced by a horn antenna connected, the S.G. output was recorded and EIRP was calculated as follows:

$$\text{ERP} = \text{S.G. output (dBm)} + \text{Antenna Gain (dBd)} - \text{Cable Loss (dB)}$$

$$\text{EIRP} = \text{S.G. output (dBm)} + \text{Antenna Gain (dBi)} - \text{Cable Loss (dB)}$$

6.4 Measurement Equipment Used:

Refer to section 2.4 in this report

Unless otherwise stated the results shown in this test report refer only to the sample(s) tested and such sample(s) are retained for 90 days only.

除非另有說明，此報告結果僅對測試之樣品負責，同時此樣品僅保留90天。本報告未經本公司書面許可，不可部份複製。

This document is issued by the Company subject to its General Conditions of Service printed overleaf, available on request or accessible at www.sgs.com/terms_and_conditions.htm and, for electronic format documents, subject to Terms and Conditions for Electronic Documents at www.sgs.com/terms_e-document.htm. Attention is drawn to the limitation of liability, indemnification and jurisdiction issues defined therein. Any holder of this document is advised that information contained hereon reflects the Company's findings at the time of its intervention only and within the limits of Client's instructions, if any. The Company's sole responsibility is to its Client and this document does not exonerate parties to a transaction from exercising all their rights and obligations under the transaction documents. This document cannot be reproduced except in full, without prior written approval of the Company. Any unauthorized alteration, forgery or falsification of the content or appearance of this document is unlawful and offenders may be prosecuted to the fullest extent of the law.

6.5 Measurement Result

EUT Mode	Frequency (MHz)	CH	EUT Pol.	Antenna Pol.	SPA Reading (dBuV)	S.G. Output (dBm)	Antenna Gain (dBi)	Cable Loss (dB)	ERP (dBm)	Limit (dBm)
GSM 850	824.20	128	E1	V	125.02	38.63	-7.87	3.62	27.13	38.45
				H	125.62	39.35	-7.87	3.62	27.85	38.45
	836.60	190	E1	V	124.35	38.10	-7.88	3.65	26.57	38.45
				H	122.76	36.53	-7.88	3.65	25.00	38.45
	848.80	251	E1	V	125.80	39.68	-7.88	3.68	28.12	38.45
				H	128.61	42.42	-7.88	3.68	30.86	38.45

Remark :

- (1) The RBW,VBW of SPA for frequency
 RBW=300 KHz, VBW=1MHz,

EUT Mode	Frequency (MHz)	CH	EUT Pol.	Antenna Pol.	SPA Reading (dBuV)	S.G. Output (dBm)	Antenna Gain (dBi)	Cable Loss (dB)	EIRP (dBm)	Limit (dBm)
PCS 1900	1850.20	512	E1	V	116.48	12.09	9.90	5.56	16.43	33.00
				H	125.47	21.29	9.90	5.84	25.35	33.00
	1880.00	661	E1	V	113.44	9.08	9.99	5.61	13.46	33.00
				H	124.77	20.63	9.99	5.61	25.00	33.00
	1909.80	810	E1	V	114.04	9.71	10.08	5.66	14.13	33.00
				H	124.22	20.11	10.08	5.66	24.53	33.00

Remark :

- (1) The RBW,VBW of SPA for frequency
 RBW=300 KHz, VBW=1MHz,

Unless otherwise stated the results shown in this test report refer only to the sample(s) tested and such sample(s) are retained for 90 days only.
 除非另有說明，此報告結果僅對測試之樣品負責，同時此樣品僅保留90天。本報告未經本公司書面許可，不可部份複製。
 This document is issued by the Company subject to its General Conditions of Service printed overleaf, available on request or accessible at www.sgs.com/terms_and_conditions.htm and, for electronic format documents, subject to Terms and Conditions for Electronic Documents at www.sgs.com/terms_e-document.htm. Attention is drawn to the limitation of liability, indemnification and jurisdiction issues defined therein. Any holder of this document is advised that information contained hereon reflects the Company's findings at the time of its intervention only and within the limits of Client's instructions, if any. The Company's sole responsibility is to its Client and this document does not exonerate parties to a transaction from exercising all their rights and obligations under the transaction documents. This document cannot be reproduced except in full, without prior written approval of the Company. Any unauthorized alteration, forgery or falsification of the content or appearance of this document is unlawful and offenders may be prosecuted to the fullest extent of the law.

7 99% OCCUPIED BANDWIDTH MEASUREMENT

7.1 Standard Applicable

According to FCC§2.1049(h).

7.2 Test Set-up:

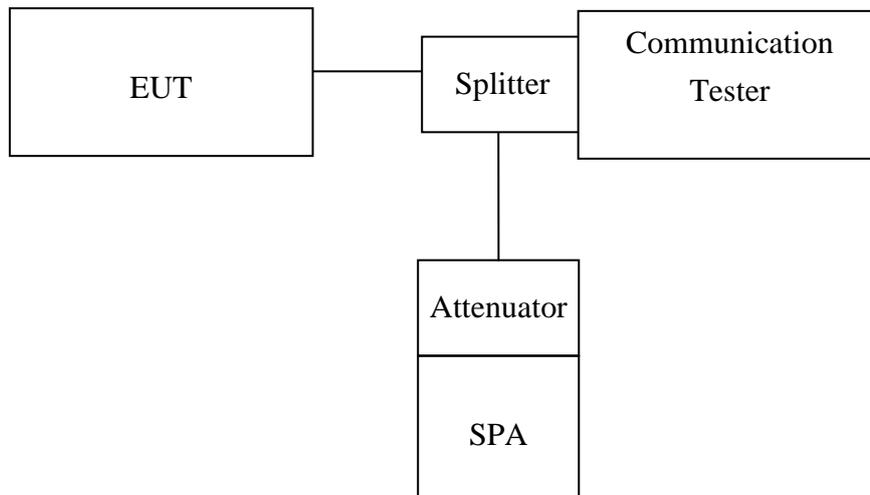

Note: Measurement setup for testing on Antenna connector

7.3 Measurement Procedure

The EUT's output RF connector was connected with a short cable to the spectrum analyzer, RBW (10/30KHz) was set to about 1% of emission BW, VBW= 3 times RBW(30/100KHz), -26dBc display line was placed on the screen (or 99% bandwidth), the occupied bandwidth is the delta frequency between the two points where the display line intersects the signal trace.

7.4 Measurement Equipment Used:

Refer to section 2.4 in this report

Unless otherwise stated the results shown in this test report refer only to the sample(s) tested and such sample(s) are retained for 90 days only.

除非另有說明，此報告結果僅對測試之樣品負責，同時此樣品僅保留90天。本報告未經本公司書面許可，不可部份複製。

This document is issued by the Company subject to its General Conditions of Service printed overleaf, available on request or accessible at www.sgs.com/terms_and_conditions.htm and, for electronic format documents, subject to Terms and Conditions for Electronic Documents at www.sgs.com/terms_e-document.htm. Attention is drawn to the limitation of liability, indemnification and jurisdiction issues defined therein. Any holder of this document is advised that information contained hereon reflects the Company's findings at the time of its intervention only and within the limits of Client's instructions, if any. The Company's sole responsibility is to its Client and this document does not exonerate parties to a transaction from exercising all their rights and obligations under the transaction documents. This document cannot be reproduced except in full, without prior written approval of the Company. Any unauthorized alteration, forgery or falsification of the content or appearance of this document is unlawful and offenders may be prosecuted to the fullest extent of the law.

7.5 Measurement Result:

EUT Mode	Frequency (MHz)	CH	99% Bandwidth (MHz)
GSM 850	824.20	128	0.2412
	836.60	190	0.2424
	848.80	251	0.2430

EUT Mode	Frequency (MHz)	CH	99% Bandwidth (MHz)
PCS 1900	1850.20	512	0.2419
	1880.00	661	0.2422
	1909.80	810	0.2427

Unless otherwise stated the results shown in this test report refer only to the sample(s) tested and such sample(s) are retained for 90 days only.

除非另有說明，此報告結果僅對測試之樣品負責，同時此樣品僅保留90天。本報告未經本公司書面許可，不可部份複製。

This document is issued by the Company subject to its General Conditions of Service printed overleaf, available on request or accessible at www.sgs.com/terms_and_conditions.htm and, for electronic format documents, subject to Terms and Conditions for Electronic Documents at www.sgs.com/terms_e-document.htm. Attention is drawn to the limitation of liability, indemnification and jurisdiction issues defined therein. Any holder of this document is advised that information contained hereon reflects the Company's findings at the time of its intervention only and within the limits of Client's instructions, if any. The Company's sole responsibility is to its Client and this document does not exonerate parties to a transaction from exercising all their rights and obligations under the transaction documents. This document cannot be reproduced except in full, without prior written approval of the Company. Any unauthorized alteration, forgery or falsification of the content or appearance of this document is unlawful and offenders may be prosecuted to the fullest extent of the law.

Figure 7-1: GSM Channel Low

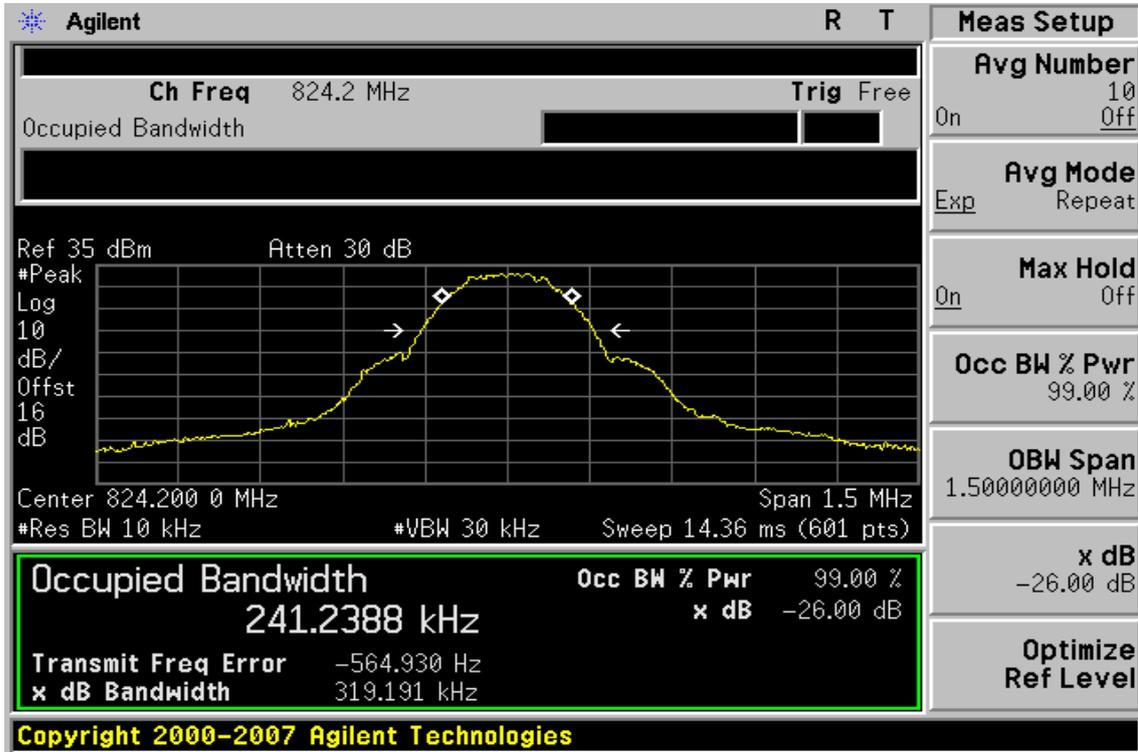
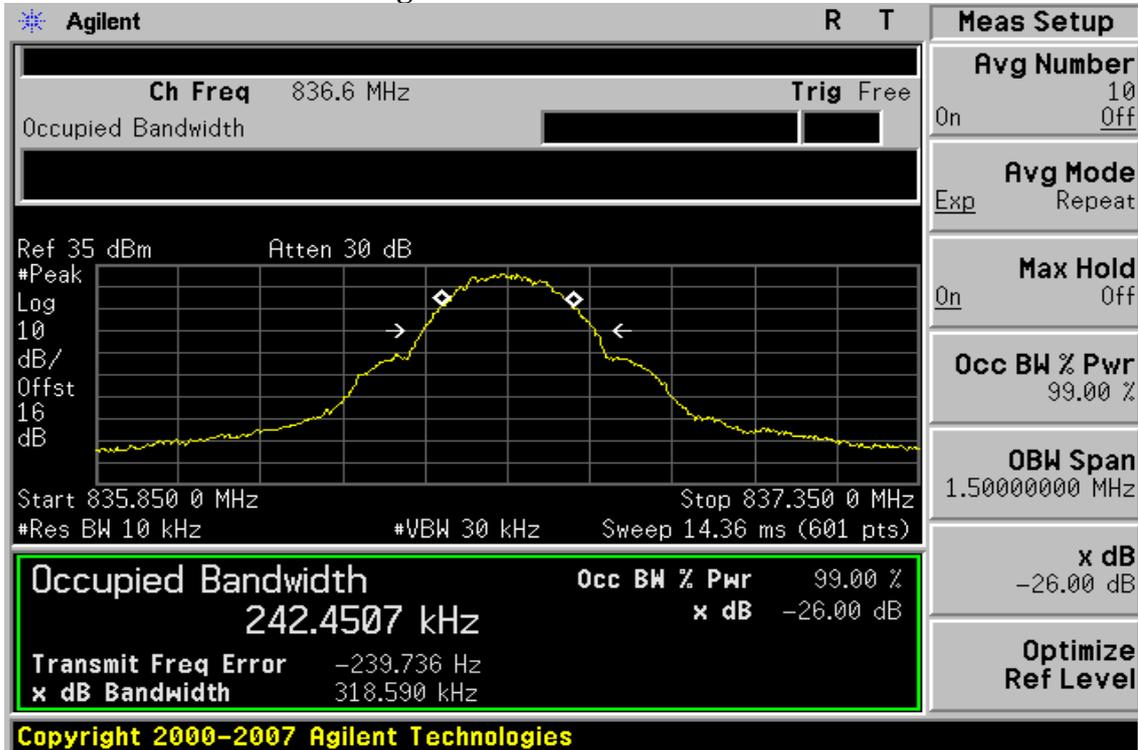

Figure 7-2 GSM Channel Mid



Unless otherwise stated the results shown in this test report refer only to the sample(s) tested and such sample(s) are retained for 90 days only.

除非另有說明，此報告結果僅對測試之樣品負責，同時此樣品僅保留90天。本報告未經本公司書面許可，不可部份複製。

This document is issued by the Company subject to its General Conditions of Service printed overleaf, available on request or accessible at www.sgs.com/terms_and_conditions.htm and, for electronic format documents, subject to Terms and Conditions for Electronic Documents at www.sgs.com/terms_e-document.htm. Attention is drawn to the limitation of liability, indemnification and jurisdiction issues defined therein. Any holder of this document is advised that information contained herein reflects the Company's findings at the time of its intervention only and within the limits of Client's instructions, if any. The Company's sole responsibility is to its Client and this document does not exonerate parties to a transaction from exercising all their rights and obligations under the transaction documents. This document cannot be reproduced except in full, without prior written approval of the Company. Any unauthorized alteration, forgery or falsification of the content or appearance of this document is unlawful and offenders may be prosecuted to the fullest extent of the law.

Figure 7-3: GSM Channel High

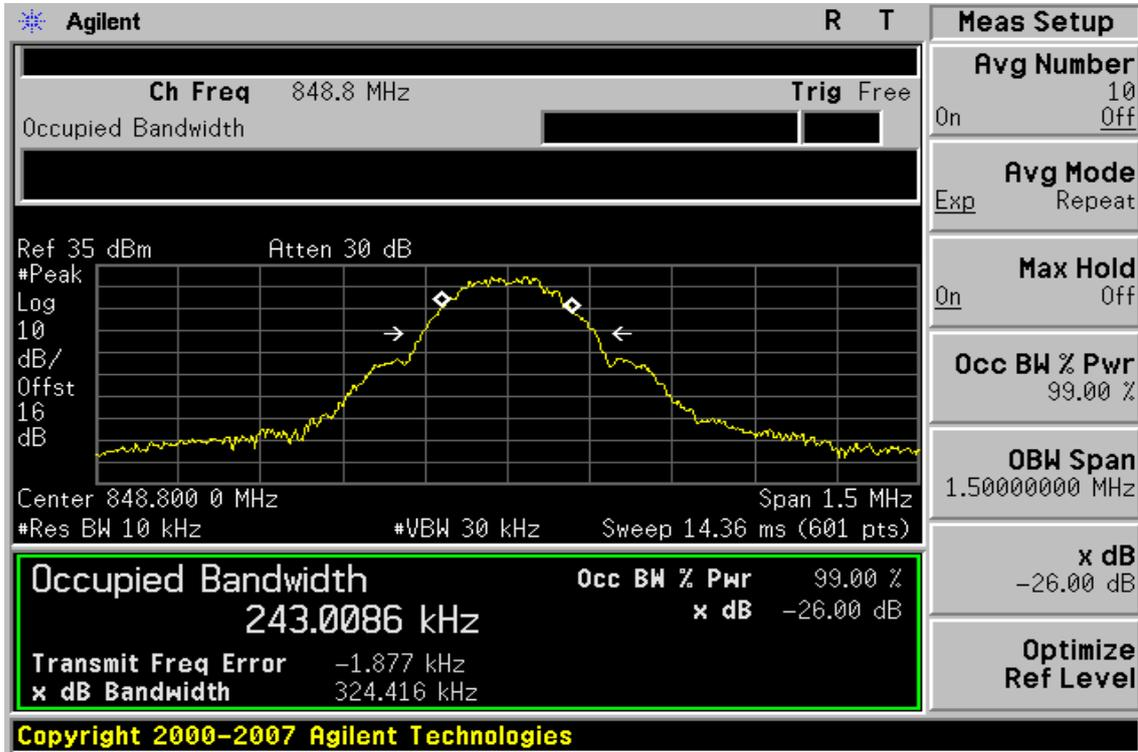
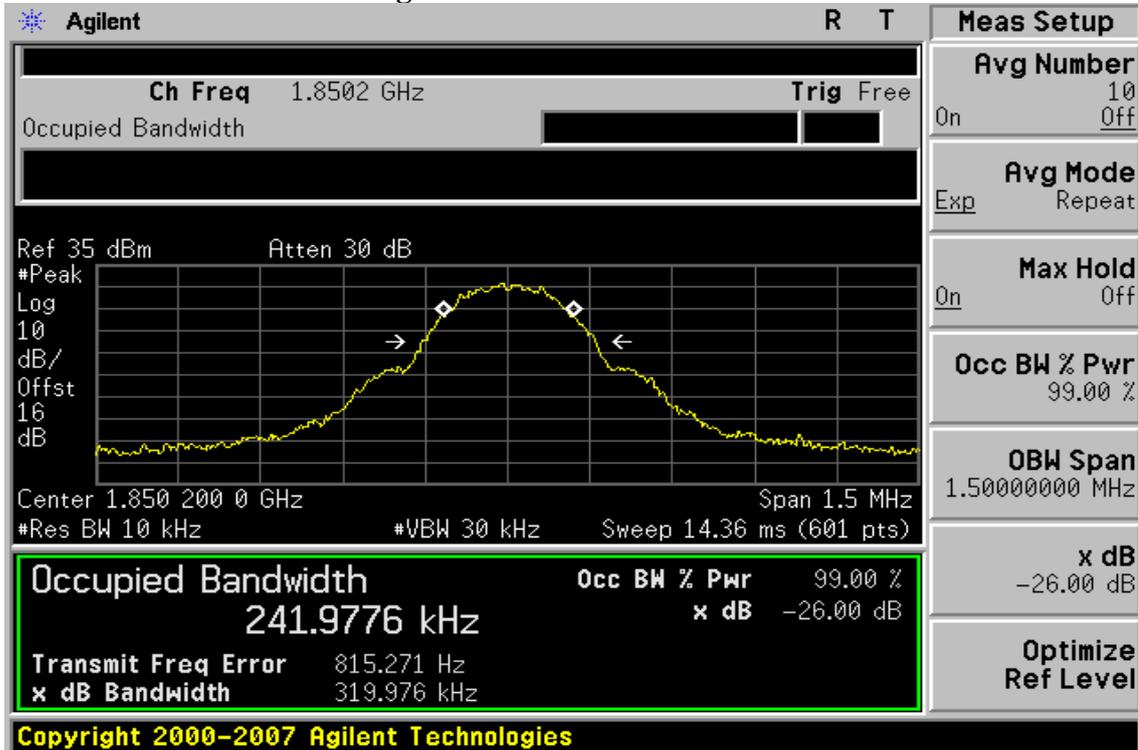

Figure 7-4: PCS Channel Low



Unless otherwise stated the results shown in this test report refer only to the sample(s) tested and such sample(s) are retained for 90 days only.

除非另有說明，此報告結果僅對測試之樣品負責，同時此樣品僅保留90天。本報告未經本公司書面許可，不可部份複製。

This document is issued by the Company subject to its General Conditions of Service printed overleaf, available on request or accessible at www.sgs.com/terms_and_conditions.htm and, for electronic format documents, subject to Terms and Conditions for Electronic Documents at www.sgs.com/terms_e-document.htm. Attention is drawn to the limitation of liability, indemnification and jurisdiction issues defined therein. Any holder of this document is advised that information contained herein reflects the Company's findings at the time of its intervention only and within the limits of Client's instructions, if any. The Company's sole responsibility is to its Client and this document does not exonerate parties to a transaction from exercising all their rights and obligations under the transaction documents. This document cannot be reproduced except in full, without prior written approval of the Company. Any unauthorized alteration, forgery or falsification of the content or appearance of this document is unlawful and offenders may be prosecuted to the fullest extent of the law.

Figure 7-5 PCS Channel Mid

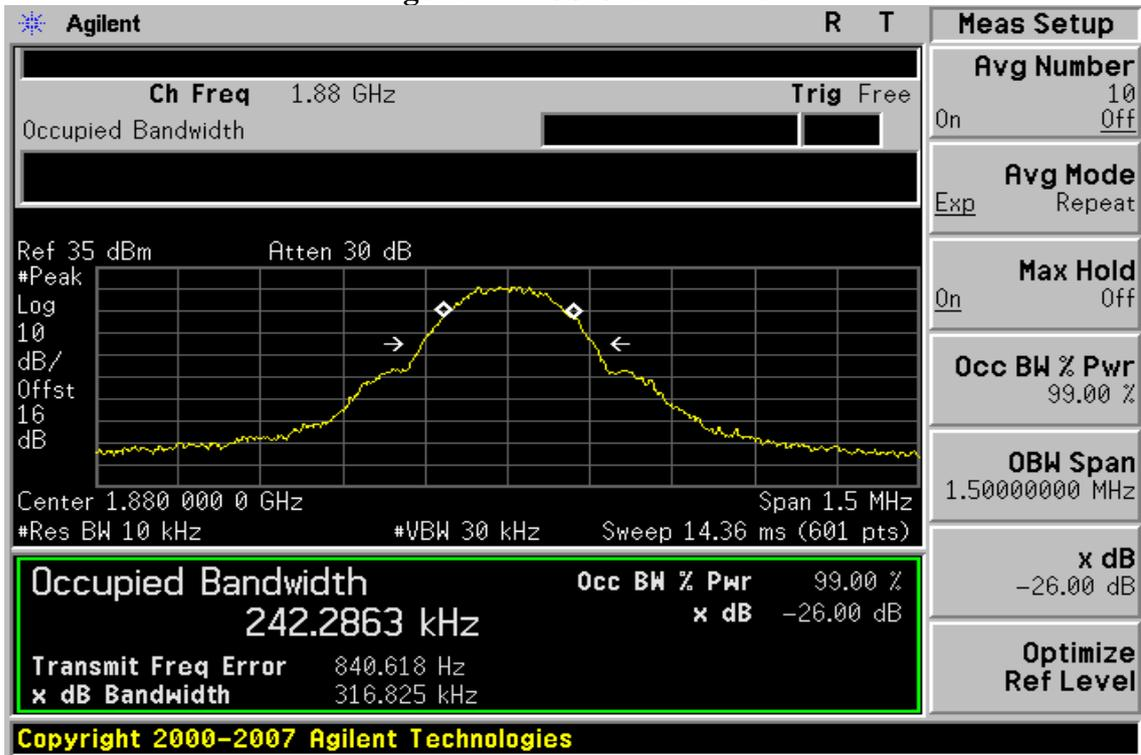
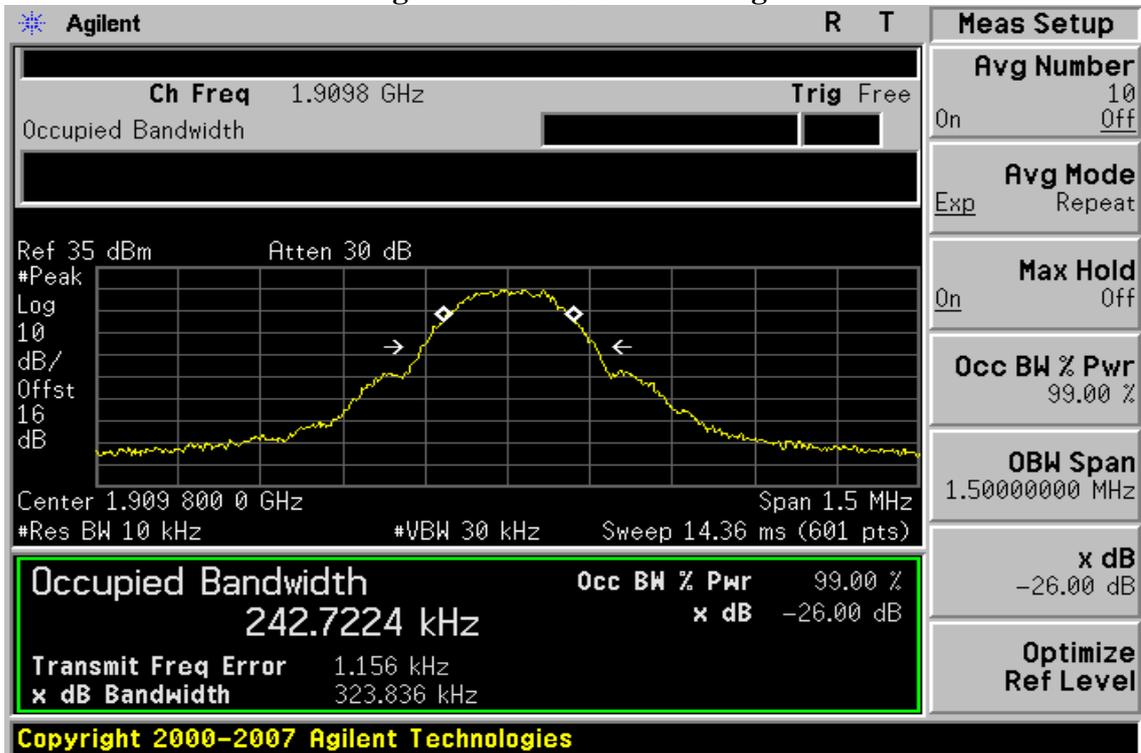

Figure 7-6: PCS Channel High



Unless otherwise stated the results shown in this test report refer only to the sample(s) tested and such sample(s) are retained for 90 days only.

除非另有說明，此報告結果僅對測試之樣品負責，同時此樣品僅保留90天。本報告未經本公司書面許可，不可部份複製。

This document is issued by the Company subject to its General Conditions of Service printed overleaf, available on request or accessible at www.sgs.com/terms_and_conditions.htm and, for electronic format documents, subject to Terms and Conditions for Electronic Documents at www.sgs.com/terms_e-document.htm. Attention is drawn to the limitation of liability, indemnification and jurisdiction issues defined therein. Any holder of this document is advised that information contained hereon reflects the Company's findings at the time of its intervention only and within the limits of Client's instructions, if any. The Company's sole responsibility is to its Client and this document does not exonerate parties to a transaction from exercising all their rights and obligations under the transaction documents. This document cannot be reproduced except in full, without prior written approval of the Company. Any unauthorized alteration, forgery or falsification of the content or appearance of this document is unlawful and offenders may be prosecuted to the fullest extent of the law.

8 OUT OF BAND EMISSION AT ANTENNA TERMINALS

8.1 Standard Applicable

According to FCC §2.1051.

FCC §22.917(a), §24.238(a) the magnitude of each spurious and harmonic emission that can be detected when the equipment is operated under the conditions specified in the instruction manual and/or alignment procedure, shall not be less than $43 + 10 \log$ (mean output power in watts) dBc below the mean power output outside a license's frequency block (-13dBm)

8.2 Test SET-UP

Refer to section 7.2 in this report

8.3 Measurement Procedure

The RF output of the transceiver was connected to a spectrum analyzer through appropriate attenuation. The resolution bandwidth of the spectrum analyzer was set at 1MHz, sufficient scans were taken to show the out of band Emissions if any up to 10th harmonic.

For the out of band: Set the RBW, VBW = 1MHz, Start=30MHz, Stop= 10 th harmonic. Limit = -13dBm

Band Edge Requirements: In the 1 MHz bands immediately outside and adjacent to the frequency block, a resolution bandwidth of at least 1 percent of the emission bandwidth of the fundamental emission of the transmitter may be employed to measure the out of band Emissions. Limit, -13dBm.

8.4 Measurement Equipment Used:

Refer to section 2.4 in this report

Unless otherwise stated the results shown in this test report refer only to the sample(s) tested and such sample(s) are retained for 90 days only.

除非另有說明，此報告結果僅對測試之樣品負責，同時此樣品僅保留90天。本報告未經本公司書面許可，不可部份複製。

This document is issued by the Company subject to its General Conditions of Service printed overleaf, available on request or accessible at www.sgs.com/terms_and_conditions.htm and, for electronic format documents, subject to Terms and Conditions for Electronic Documents at www.sgs.com/terms_e-document.htm. Attention is drawn to the limitation of liability, indemnification and jurisdiction issues defined therein. Any holder of this document is advised that information contained hereon reflects the Company's findings at the time of its intervention only and within the limits of Client's instructions, if any. The Company's sole responsibility is to its Client and this document does not exonerate parties to a transaction from exercising all their rights and obligations under the transaction documents. This document cannot be reproduced except in full, without prior written approval of the Company. Any unauthorized alteration, forgery or falsification of the content or appearance of this document is unlawful and offenders may be prosecuted to the fullest extent of the law.

8.5 Measurement Result

Figure 8-1: Out of Band emission at antenna terminals– GSM 850 Channel Lowest

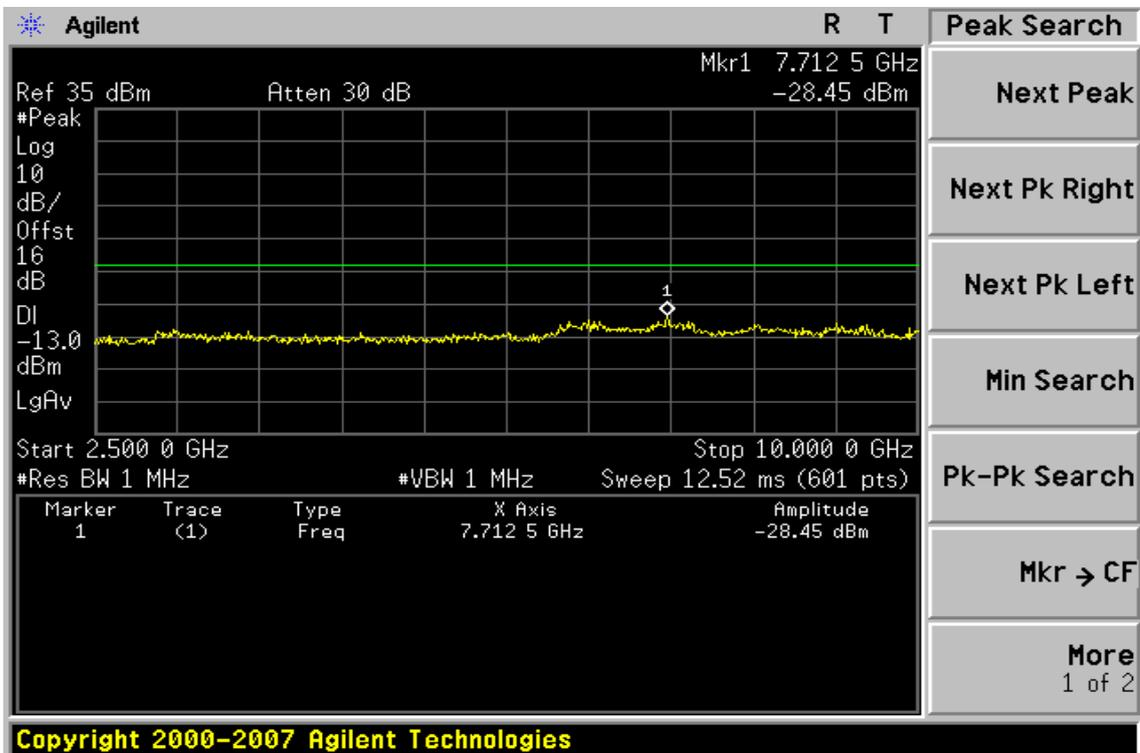
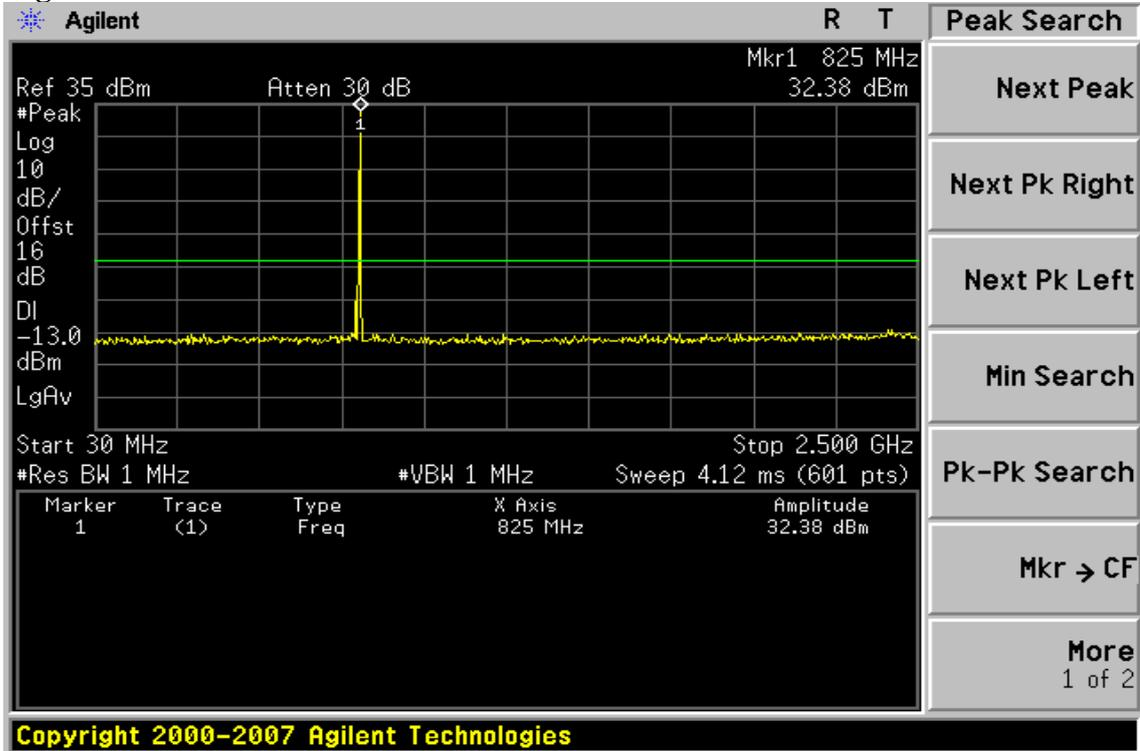

Unless otherwise stated the results shown in this test report refer only to the sample(s) tested and such sample(s) are retained for 90 days only. 除非另有說明，此報告結果僅對測試之樣品負責，同時此樣品僅保留90天。本報告未經本公司書面許可，不可部份複製。 This document is issued by the Company subject to its General Conditions of Service printed overleaf, available on request or accessible at www.sgs.com/terms_and_conditions.htm and, for electronic format documents, subject to Terms and Conditions for Electronic Documents at www.sgs.com/terms_e-document.htm. Attention is drawn to the limitation of liability, indemnification and jurisdiction issues defined therein. Any holder of this document is advised that information contained hereon reflects the Company's findings at the time of its intervention only and within the limits of Client's instructions, if any. The Company's sole responsibility is to its Client and this document does not exonerate parties to a transaction from exercising all their rights and obligations under the transaction documents. This document cannot be reproduced except in full, without prior written approval of the Company. Any unauthorized alteration, forgery or falsification of the content or appearance of this document is unlawful and offenders may be prosecuted to the fullest extent of the law.

Figure 8-2: Out of Band emission at antenna terminals –GSM 850 Channel Mid

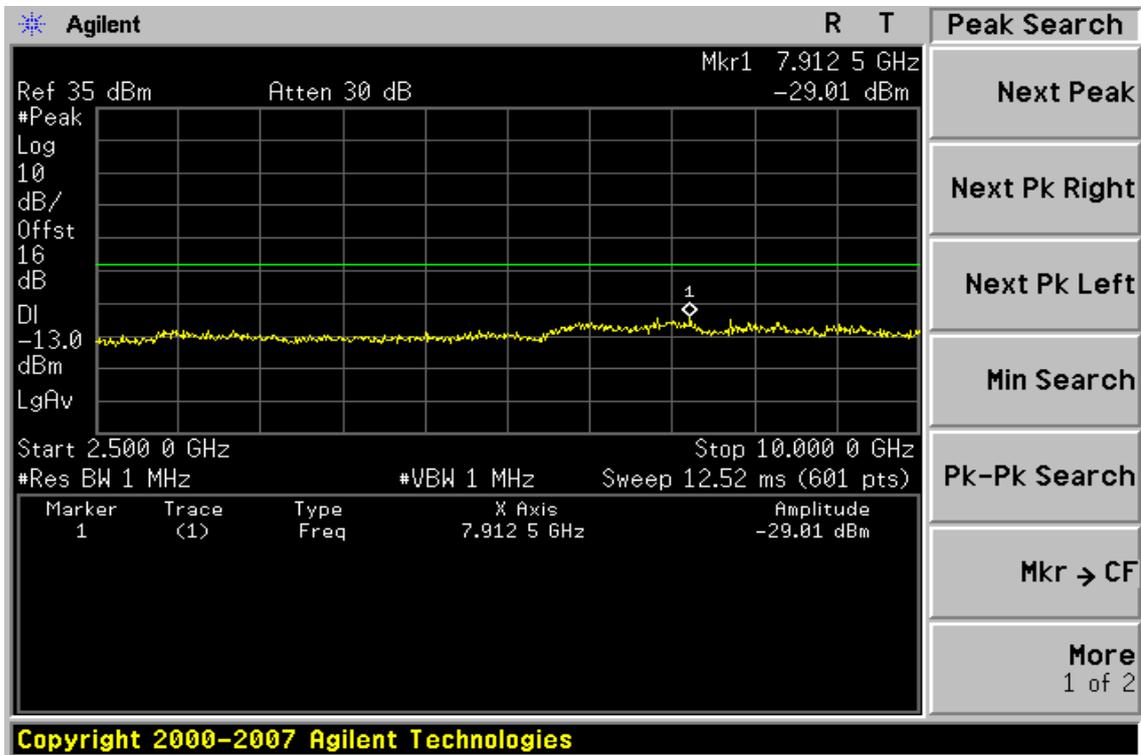
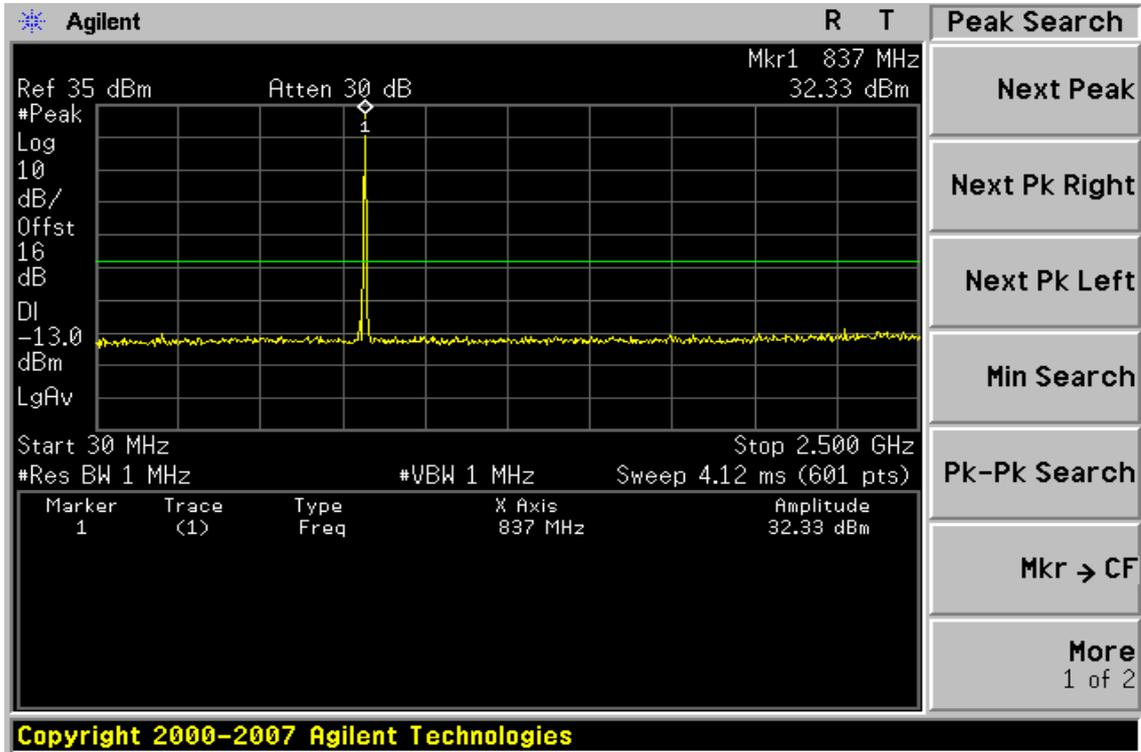

Unless otherwise stated the results shown in this test report refer only to the sample(s) tested and such sample(s) are retained for 90 days only.

除非另有說明，此報告結果僅對測試之樣品負責，同時此樣品僅保留90天。本報告未經本公司書面許可，不可部份複製。

This document is issued by the Company subject to its General Conditions of Service printed overleaf, available on request or accessible at www.sgs.com/terms_and_conditions.htm and, for electronic format documents, subject to Terms and Conditions for Electronic Documents at www.sgs.com/terms_e-document.htm. Attention is drawn to the limitation of liability, indemnification and jurisdiction issues defined therein. Any holder of this document is advised that information contained hereon reflects the Company's findings at the time of its intervention only and within the limits of Client's instructions, if any. The Company's sole responsibility is to its Client and this document does not exonerate parties to a transaction from exercising all their rights and obligations under the transaction documents. This document cannot be reproduced except in full, without prior written approval of the Company. Any unauthorized alteration, forgery or falsification of the content or appearance of this document is unlawful and offenders may be prosecuted to the fullest extent of the law.

Figure 8-3: Out of Band emission at antenna terminals–GSM 850 Channel Highest

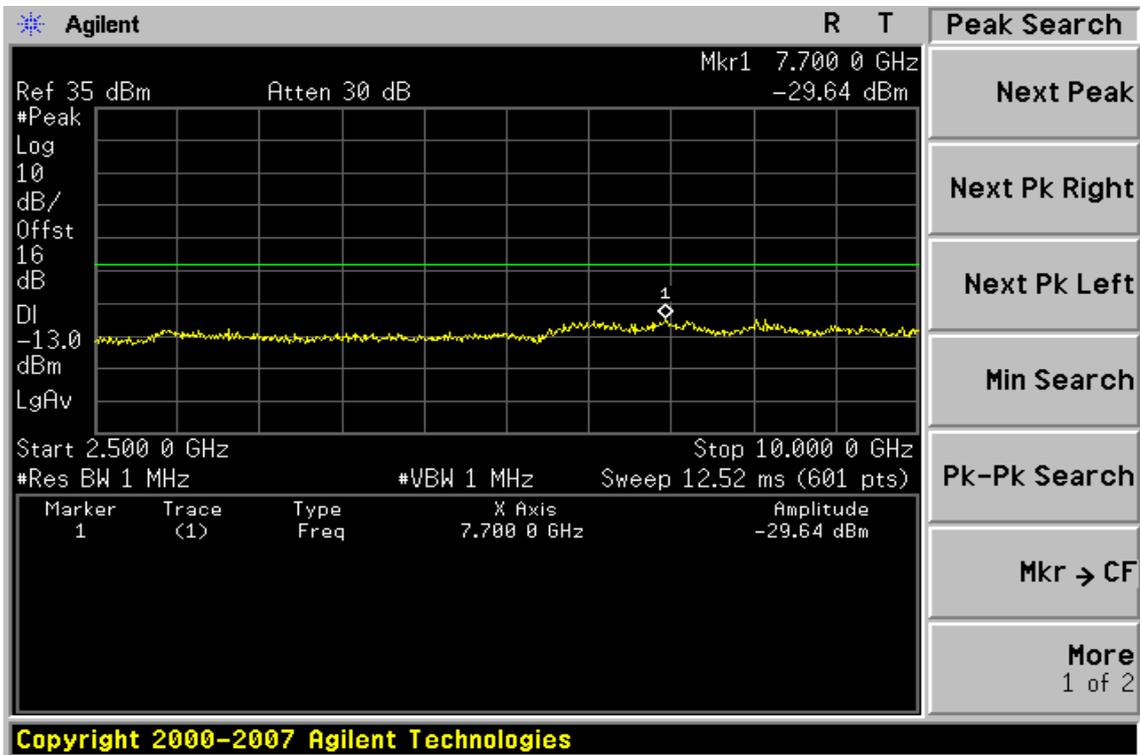
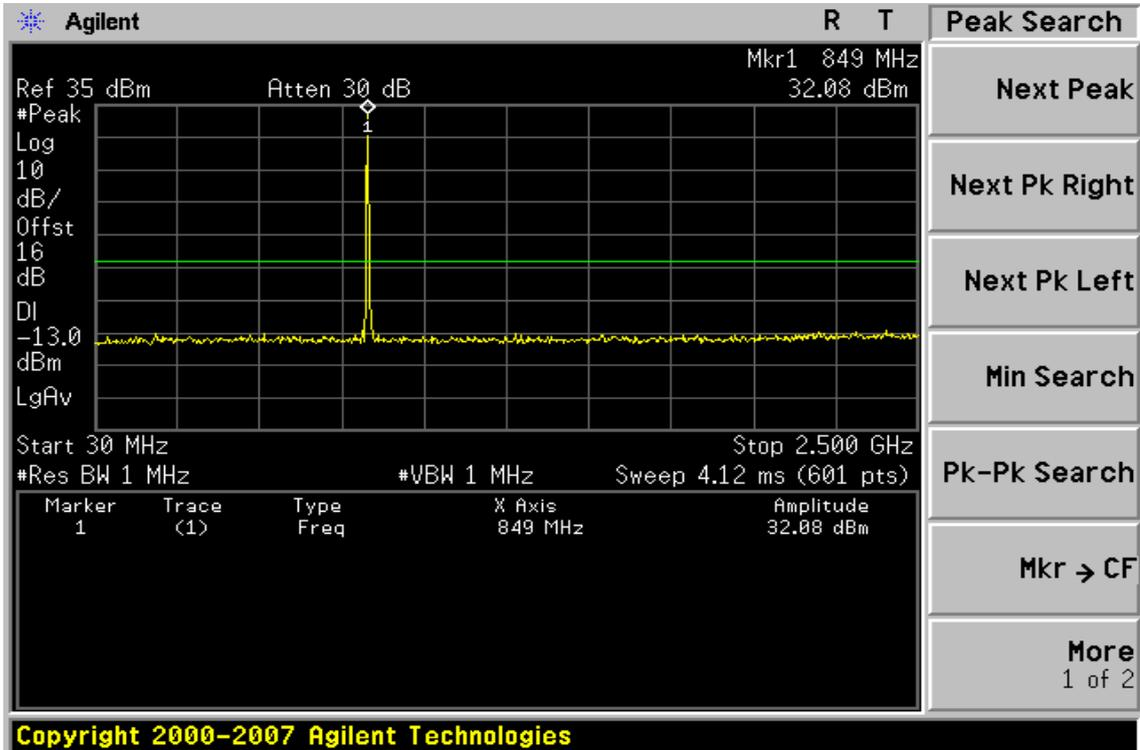

Unless otherwise stated the results shown in this test report refer only to the sample(s) tested and such sample(s) are retained for 90 days only.

除非另有說明，此報告結果僅對測試之樣品負責，同時此樣品僅保留90天。本報告未經本公司書面許可，不可部份複製。

This document is issued by the Company subject to its General Conditions of Service printed overleaf, available on request or accessible at www.sgs.com/terms_and_conditions.htm and, for electronic format documents, subject to Terms and Conditions for Electronic Documents at www.sgs.com/terms_e-document.htm. Attention is drawn to the limitation of liability, indemnification and jurisdiction issues defined therein. Any holder of this document is advised that information contained hereon reflects the Company's findings at the time of its intervention only and within the limits of Client's instructions, if any. The Company's sole responsibility is to its Client and this document does not exonerate parties to a transaction from exercising all their rights and obligations under the transaction documents. This document cannot be reproduced except in full, without prior written approval of the Company. Any unauthorized alteration, forgery or falsification of the content or appearance of this document is unlawful and offenders may be prosecuted to the fullest extent of the law.

Figure 8-4: Band edge emission at antenna terminals – GSM 850 Channel Lowest



Figure 8-5: Band edge emission at antenna terminals – GSM Channel Highest

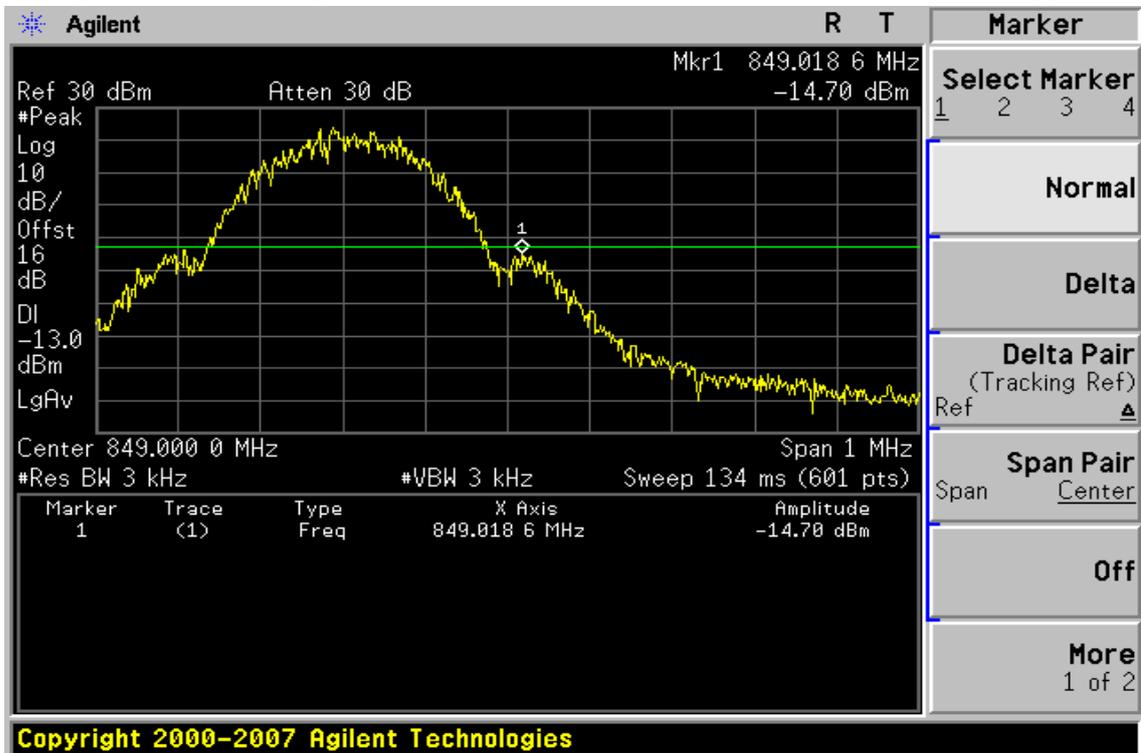

Unless otherwise stated the results shown in this test report refer only to the sample(s) tested and such sample(s) are retained for 90 days only.

除非另有說明，此報告結果僅對測試之樣品負責，同時此樣品僅保留90天。本報告未經本公司書面許可，不可部份複製。

This document is issued by the Company subject to its General Conditions of Service printed overleaf, available on request or accessible at www.sgs.com/terms_and_conditions.htm and, for electronic format documents, subject to Terms and Conditions for Electronic Documents at www.sgs.com/terms_e-document.htm. Attention is drawn to the limitation of liability, indemnification and jurisdiction issues defined therein. Any holder of this document is advised that information contained hereon reflects the Company's findings at the time of its intervention only and within the limits of Client's instructions, if any. The Company's sole responsibility is to its Client and this document does not exonerate parties to a transaction from exercising all their rights and obligations under the transaction documents. This document cannot be reproduced except in full, without prior written approval of the Company. Any unauthorized alteration, forgery or falsification of the content or appearance of this document is unlawful and offenders may be prosecuted to the fullest extent of the law.

Figure 8-6: Out of Band emission at antenna terminals– PCS 1900 Channel Lowest

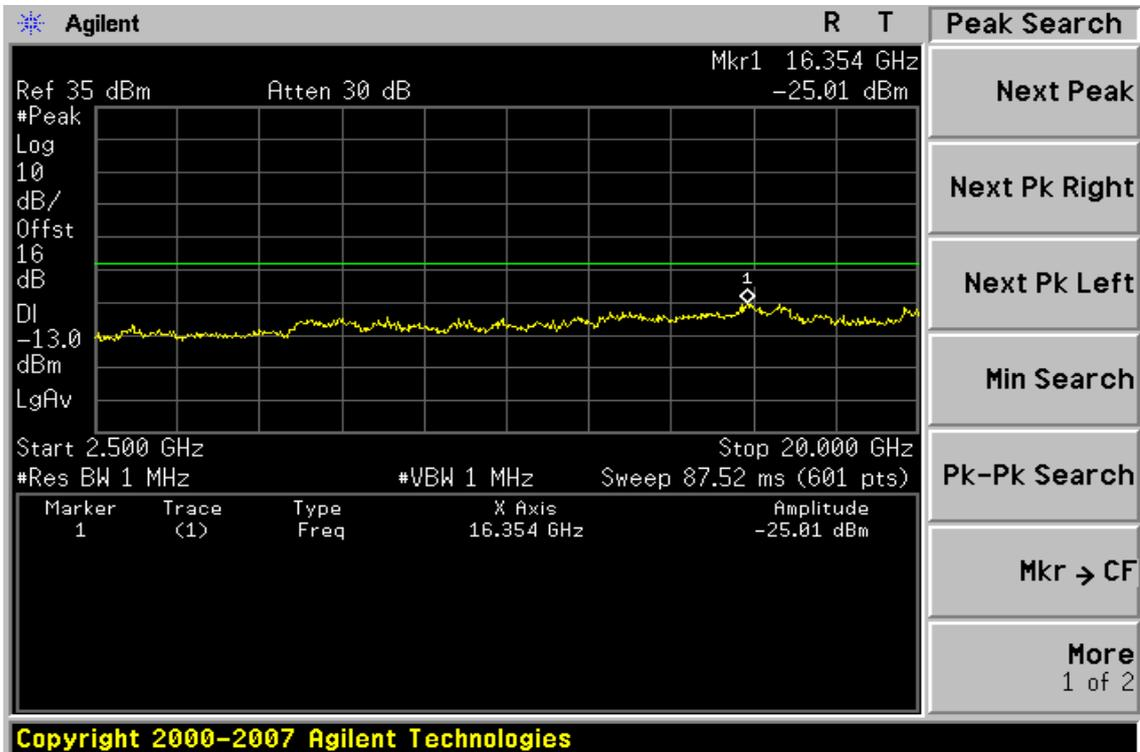
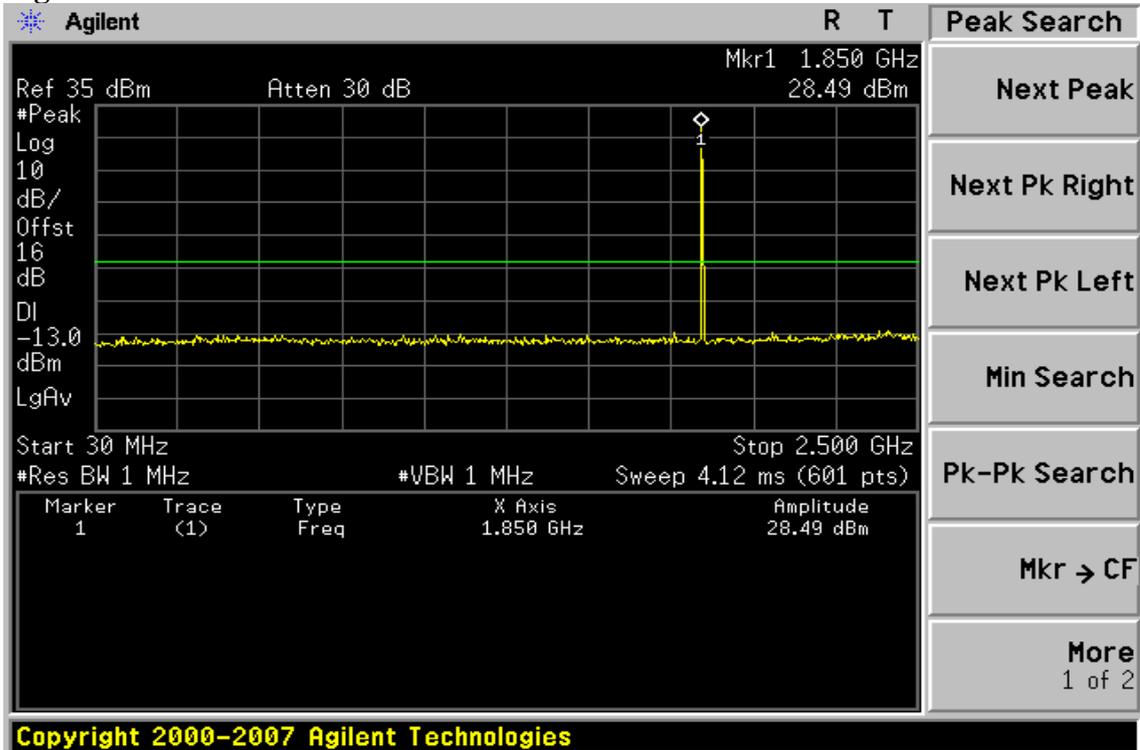

Unless otherwise stated the results shown in this test report refer only to the sample(s) tested and such sample(s) are retained for 90 days only. 除非另有說明，此報告結果僅對測試之樣品負責，同時此樣品僅保留90天。本報告未經本公司書面許可，不可部份複製。 This document is issued by the Company subject to its General Conditions of Service printed overleaf, available on request or accessible at www.sgs.com/terms_and_conditions.htm and, for electronic format documents, subject to Terms and Conditions for Electronic Documents at www.sgs.com/terms_e-document.htm. Attention is drawn to the limitation of liability, indemnification and jurisdiction issues defined therein. Any holder of this document is advised that information contained hereon reflects the Company's findings at the time of its intervention only and within the limits of Client's instructions, if any. The Company's sole responsibility is to its Client and this document does not exonerate parties to a transaction from exercising all their rights and obligations under the transaction documents. This document cannot be reproduced except in full, without prior written approval of the Company. Any unauthorized alteration, forgery or falsification of the content or appearance of this document is unlawful and offenders may be prosecuted to the fullest extent of the law.

Figure 8-7: Out of Band emission at antenna terminals –PCS 1900 Channel Mid

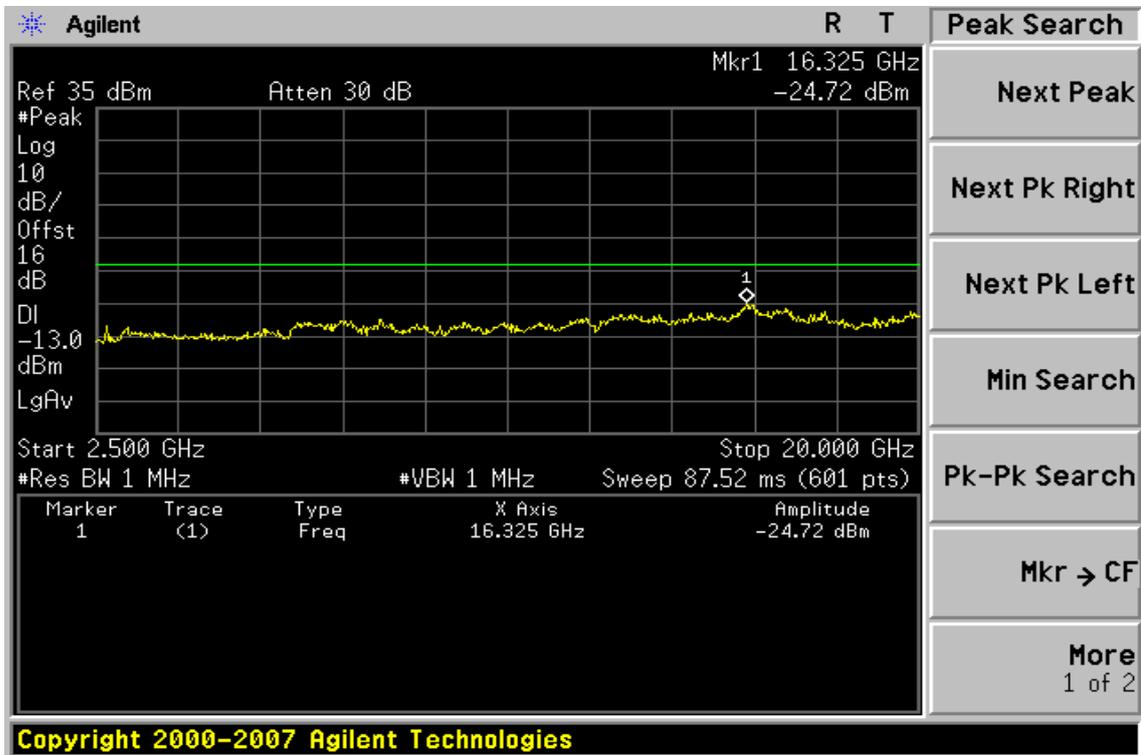
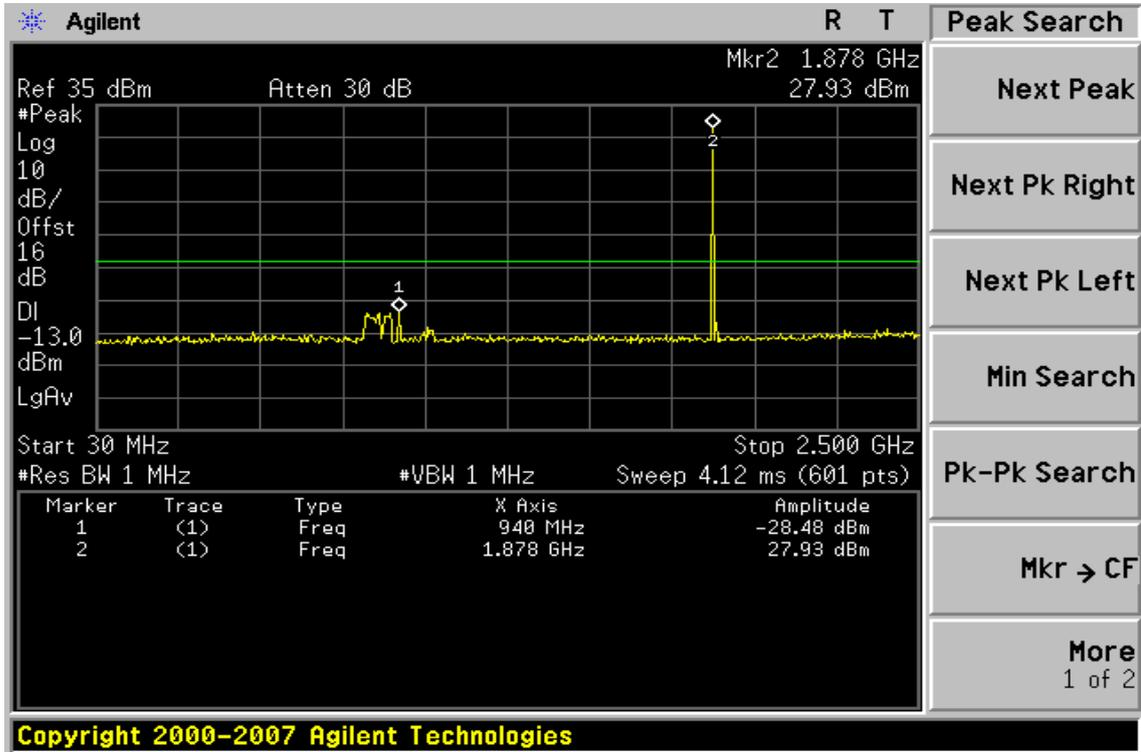

Unless otherwise stated the results shown in this test report refer only to the sample(s) tested and such sample(s) are retained for 90 days only.

除非另有說明，此報告結果僅對測試之樣品負責，同時此樣品僅保留90天。本報告未經本公司書面許可，不可部份複製。

This document is issued by the Company subject to its General Conditions of Service printed overleaf, available on request or accessible at www.sgs.com/terms_and_conditions.htm and, for electronic format documents, subject to Terms and Conditions for Electronic Documents at www.sgs.com/terms_e-document.htm. Attention is drawn to the limitation of liability, indemnification and jurisdiction issues defined therein. Any holder of this document is advised that information contained hereon reflects the Company's findings at the time of its intervention only and within the limits of Client's instructions, if any. The Company's sole responsibility is to its Client and this document does not exonerate parties to a transaction from exercising all their rights and obligations under the transaction documents. This document cannot be reproduced except in full, without prior written approval of the Company. Any unauthorized alteration, forgery or falsification of the content or appearance of this document is unlawful and offenders may be prosecuted to the fullest extent of the law.

Figure 8-8: Out of Band emission at antenna terminals–PCS 1900 Channel Highest

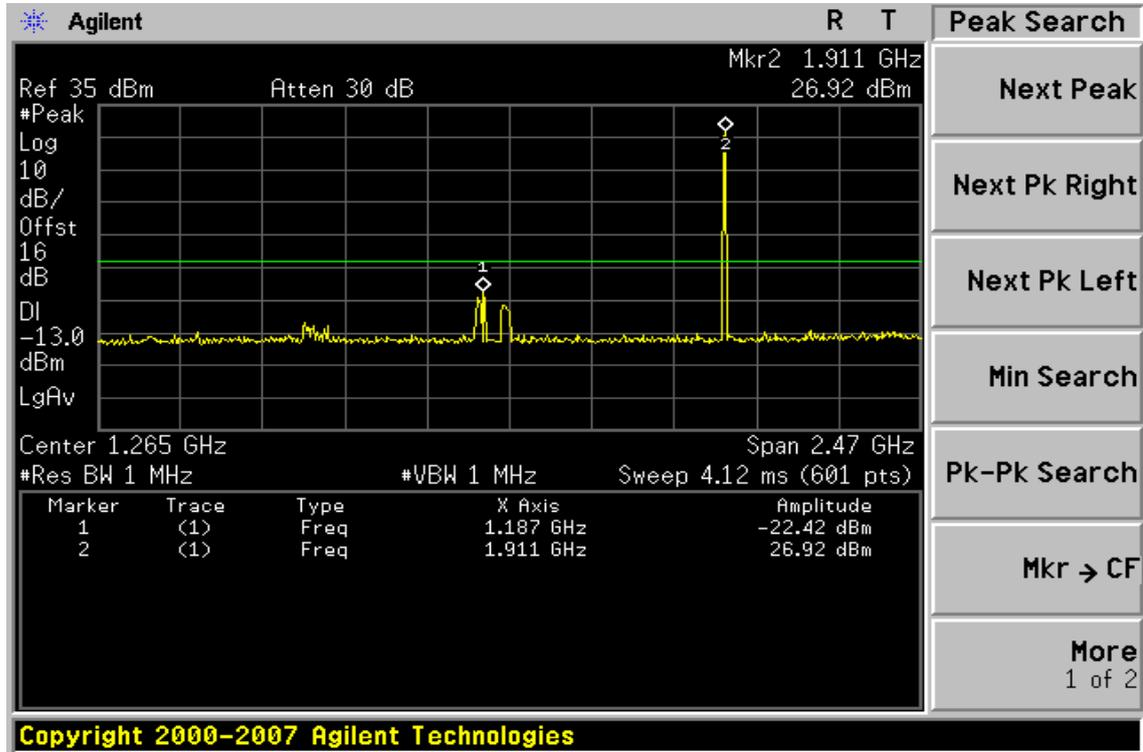

Unless otherwise stated the results shown in this test report refer only to the sample(s) tested and such sample(s) are retained for 90 days only.

除非另有說明，此報告結果僅對測試之樣品負責，同時此樣品僅保留90天。本報告未經本公司書面許可，不可部份複製。

This document is issued by the Company subject to its General Conditions of Service printed overleaf, available on request or accessible at www.sgs.com/terms_and_conditions.htm and, for electronic format documents, subject to Terms and Conditions for Electronic Documents at www.sgs.com/terms_e-document.htm. Attention is drawn to the limitation of liability, indemnification and jurisdiction issues defined therein. Any holder of this document is advised that information contained hereon reflects the Company's findings at the time of its intervention only and within the limits of Client's instructions, if any. The Company's sole responsibility is to its Client and this document does not exonerate parties to a transaction from exercising all their rights and obligations under the transaction documents. This document cannot be reproduced except in full, without prior written approval of the Company. Any unauthorized alteration, forgery or falsification of the content or appearance of this document is unlawful and offenders may be prosecuted to the fullest extent of the law.

Figure 8-9: Bad edge emission at antenna terminals – PCS 1900 Channel Lowest

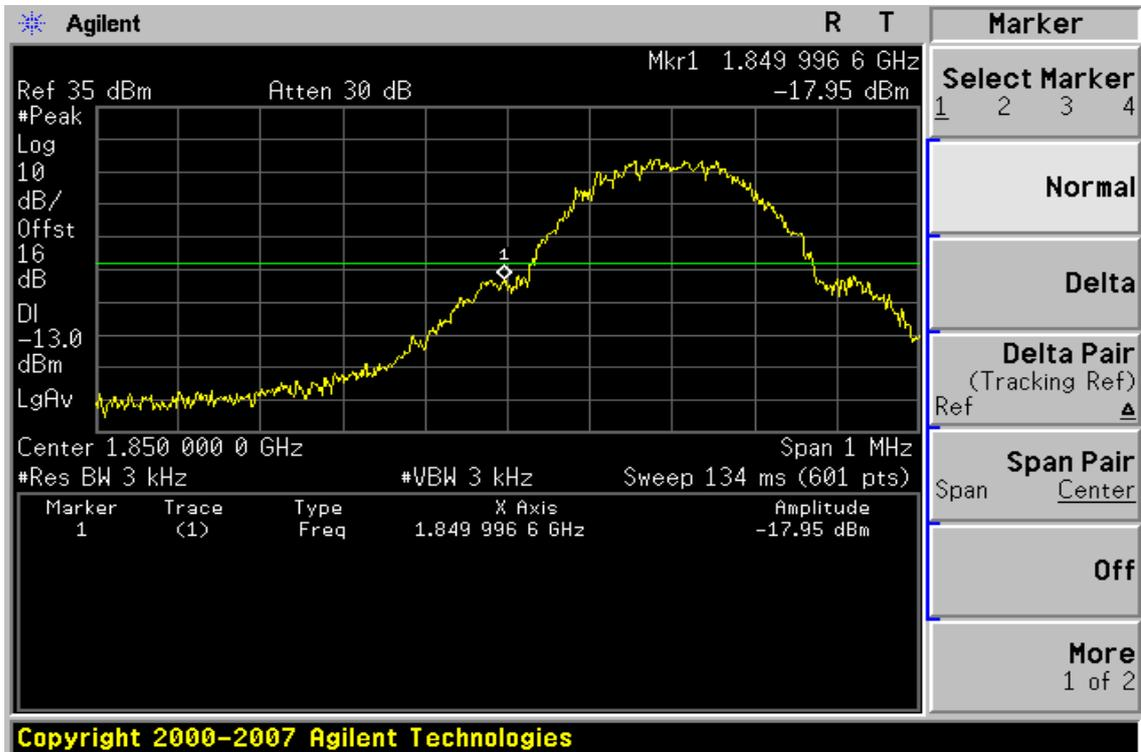
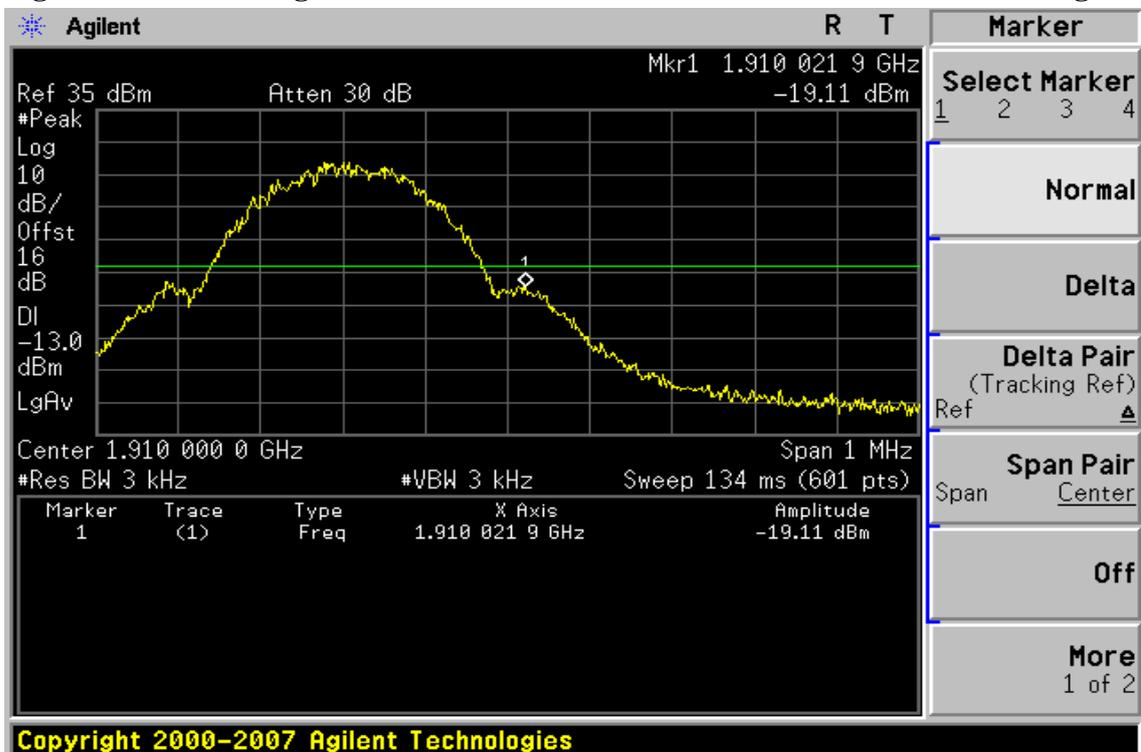

Figure 8-10: Band edge emission at antenna terminals – PCS 1900 Channel Highest



Unless otherwise stated the results shown in this test report refer only to the sample(s) tested and such sample(s) are retained for 90 days only.
 除非另有說明，此報告結果僅對測試之樣品負責，同時此樣品僅保留90天。本報告未經本公司書面許可，不可部份複製。
 This document is issued by the Company subject to its General Conditions of Service printed overleaf, available on request or accessible at www.sgs.com/terms_and_conditions.htm and, for electronic format documents, subject to Terms and Conditions for Electronic Documents at www.sgs.com/terms_e-document.htm. Attention is drawn to the limitation of liability, indemnification and jurisdiction issues defined therein. Any holder of this document is advised that information contained hereon reflects the Company's findings at the time of its intervention only and within the limits of Client's instructions, if any. The Company's sole responsibility is to its Client and this document does not exonerate parties to a transaction from exercising all their rights and obligations under the transaction documents. This document cannot be reproduced except in full, without prior written approval of the Company. Any unauthorized alteration, forgery or falsification of the content or appearance of this document is unlawful and offenders may be prosecuted to the fullest extent of the law.

9 FIELD STRENGTH OF SPURIOUS RADIATION MEASUREMENT

9.1 Standard Applicable

According to FCC §2.1053,

FCC §22.917(a), §24.238(a) the magnitude of each spurious and harmonic emission that can be detected when the equipment is operated under the conditions specified in the instruction manual and/or alignment procedure, shall not be less than $43 + 10 \log$ (mean output power in watts) dBc below the mean power output outside a license's frequency block (-13dBm)

9.2 EUT Setup (Block Diagram of Configuration)

(A) Radiated Emission Test Set-Up, Frequency Below 1000MHz

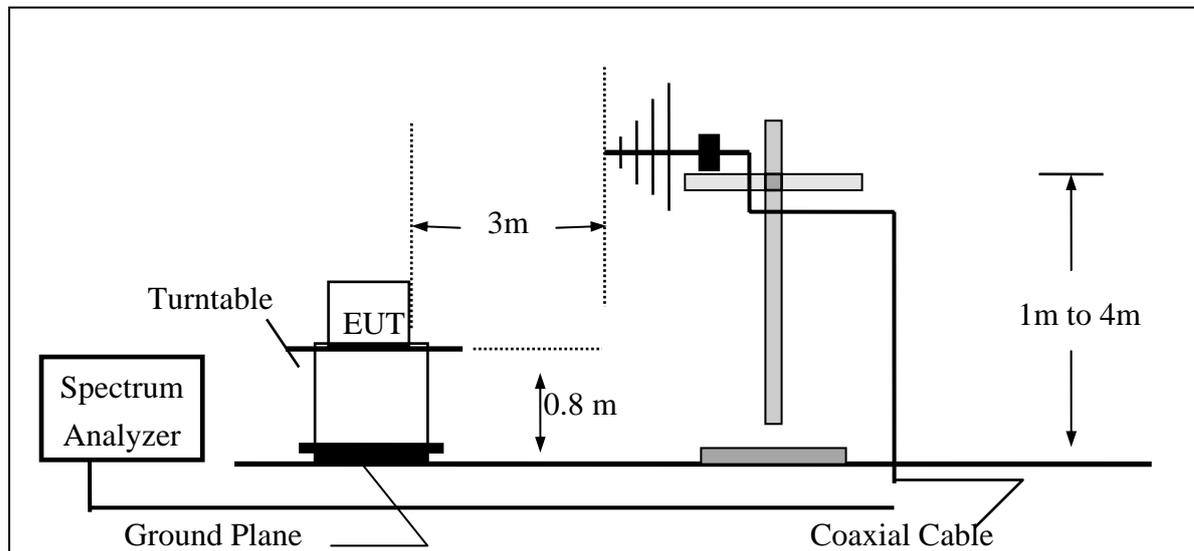

Unless otherwise stated the results shown in this test report refer only to the sample(s) tested and such sample(s) are retained for 90 days only.

除非另有說明，此報告結果僅對測試之樣品負責，同時此樣品僅保留90天。本報告未經本公司書面許可，不可部份複製。

This document is issued by the Company subject to its General Conditions of Service printed overleaf, available on request or accessible at www.sgs.com/terms_and_conditions.htm and, for electronic format documents, subject to Terms and Conditions for Electronic Documents at www.sgs.com/terms_e-document.htm. Attention is drawn to the limitation of liability, indemnification and jurisdiction issues defined therein. Any holder of this document is advised that information contained hereon reflects the Company's findings at the time of its intervention only and within the limits of Client's instructions, if any. The Company's sole responsibility is to its Client and this document does not exonerate parties to a transaction from exercising all their rights and obligations under the transaction documents. This document cannot be reproduced except in full, without prior written approval of the Company. Any unauthorized alteration, forgery or falsification of the content or appearance of this document is unlawful and offenders may be prosecuted to the fullest extent of the law.

(B) Radiated Emission Test Set-UP Frequency Over 1 GHz

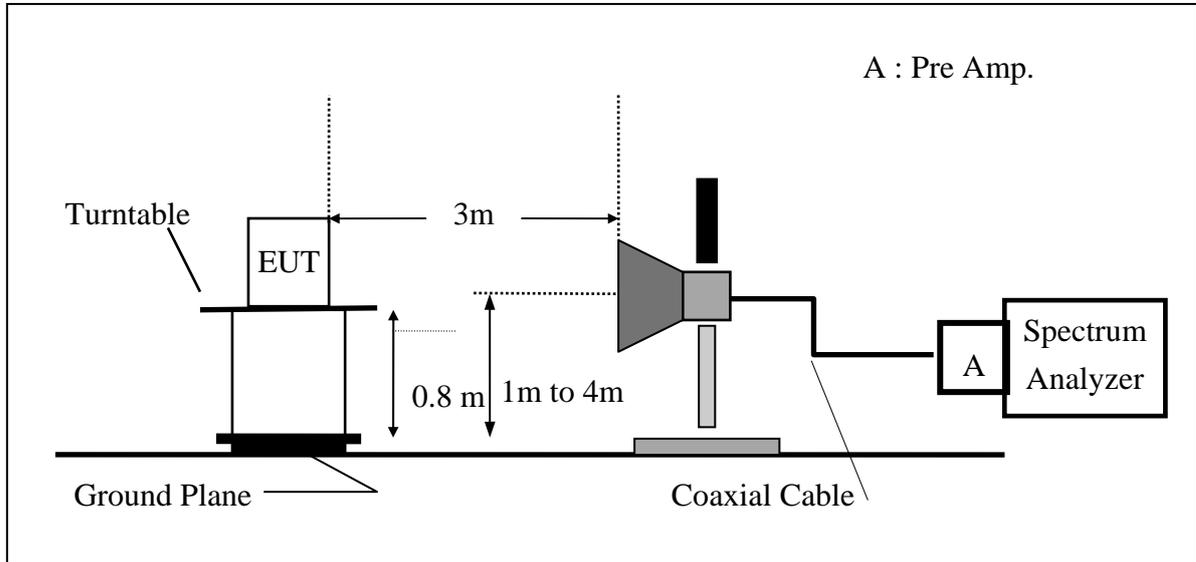

(C) Substituted Method Test Set-UP

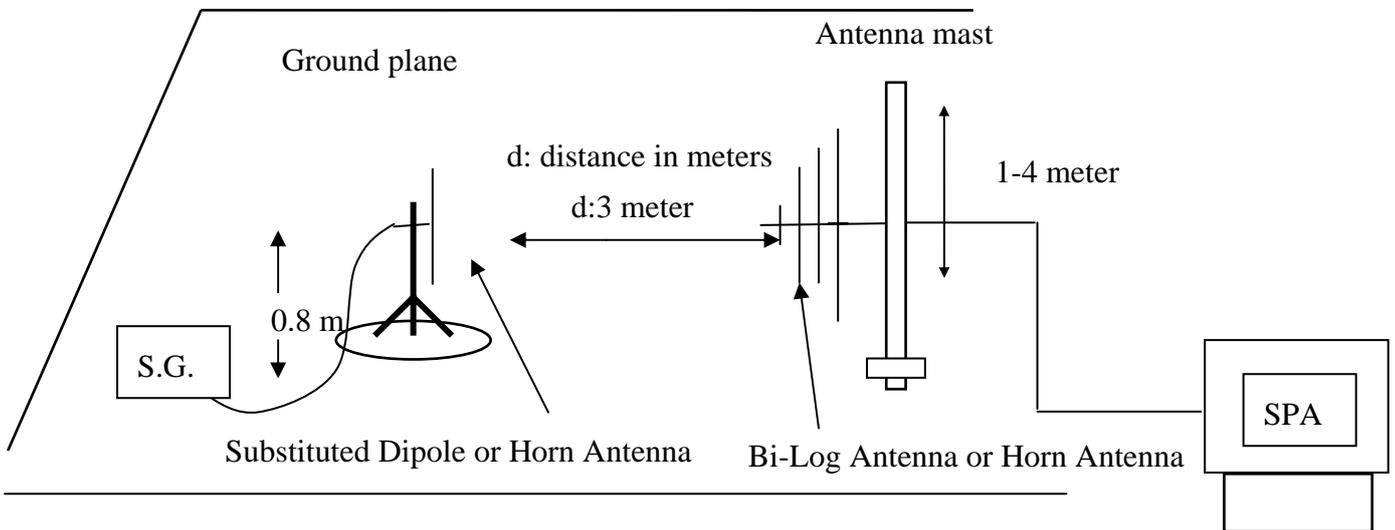

Unless otherwise stated the results shown in this test report refer only to the sample(s) tested and such sample(s) are retained for 90 days only.
 除非另有說明，此報告結果僅對測試之樣品負責，同時此樣品僅保留90天。本報告未經本公司書面許可，不可部份複製。
 This document is issued by the Company subject to its General Conditions of Service printed overleaf, available on request or accessible at www.sgs.com/terms_and_conditions.htm and, for electronic format documents, subject to Terms and Conditions for Electronic Documents at www.sgs.com/terms_e-document.htm. Attention is drawn to the limitation of liability, indemnification and jurisdiction issues defined therein. Any holder of this document is advised that information contained hereon reflects the Company's findings at the time of its intervention only and within the limits of Client's instructions, if any. The Company's sole responsibility is to its Client and this document does not exonerate parties to a transaction from exercising all their rights and obligations under the transaction documents. This document cannot be reproduced except in full, without prior written approval of the Company. Any unauthorized alteration, forgery or falsification of the content or appearance of this document is unlawful and offenders may be prosecuted to the fullest extent of the law.

9.3 Measurement Procedure

The EUT was placed on a non-conductive, The measurement antenna was placed at a distance of 3 meters from the EUT. During the tests, the antenna height and the EUT azimuth were varied in order to identify the maximum level of emissions from the EUT. This maximization process was repeated with the EUT positioned in each of its three orthogonal orientations.

The frequency range up to tenth harmonic was investigated for each of three fundamental frequency (low, middle and high channels). Once spurious emission were identified, the power of the emission was determined using the substitution method.

ERP in frequency band 824 –850 MHz were measured using a substitution method. The EUT was replaced by dipole antenna connected, the S.G. output was recorded and ERP was calculated as follows:

EIRP in frequency band 1850.2 –1909.8MHz were measured using a substitution method. The EUT was replaced by a horn antenna connected, the S.G. output was recorded and EIRP was calculated as follows:

The spurious emissions attenuation was calculated as the difference between radiated power at the fundamental frequency and the spurious emissions frequency.

$$\text{ERP} = \text{S.G. output (dBm)} + \text{Antenna Gain(dBd)} - \text{Cable Loss (dB)}$$

$$\text{EIRP} = \text{S.G. output (dBm)} + \text{Antenna Gain(dBi)} - \text{Cable Loss (dB)}$$

9.4 Measurement Equipment Used:

Refer to section 2.4 in this report

9.5 Measurement Result

Refer to attach tabular data sheets.

Unless otherwise stated the results shown in this test report refer only to the sample(s) tested and such sample(s) are retained for 90 days only.

除非另有說明，此報告結果僅對測試之樣品負責，同時此樣品僅保留90天。本報告未經本公司書面許可，不可部份複製。

This document is issued by the Company subject to its General Conditions of Service printed overleaf, available on request or accessible at www.sgs.com/terms_and_conditions.htm and, for electronic format documents, subject to Terms and Conditions for Electronic Documents at www.sgs.com/terms_e-document.htm. Attention is drawn to the limitation of liability, indemnification and jurisdiction issues defined therein. Any holder of this document is advised that information contained hereon reflects the Company's findings at the time of its intervention only and within the limits of Client's instructions, if any. The Company's sole responsibility is to its Client and this document does not exonerate parties to a transaction from exercising all their rights and obligations under the transaction documents. This document cannot be reproduced except in full, without prior written approval of the Company. Any unauthorized alteration, forgery or falsification of the content or appearance of this document is unlawful and offenders may be prosecuted to the fullest extent of the law.

Radiated Spurious Emission Measurement Result: GSM 850 Mode

Operation Mode	: TX CH Low Mode	Test Date:	Mar. 25, 2010
Fundamental Frequency	: 824.20 MHz	Test By:	Jason
Temperature	: 25°C	Pol:	Ver
Humidity	: 65%		

Freq. (MHz)	SPA Reading (dBuV)	Ant.Pol. H/V	S.G Output (dBm)	Antenna Gain (dB/dBi)	Cable Loss (dB)	ERP/EIRP (dBm)	Limit (dBm)	Safe Margin (dBm)
31.94	43.93	V	-60.21	-6.43	0.94	-67.58	-13.00	-54.58
56.19	39.72	V	-69.94	-0.51	1.09	-71.55	-13.00	-58.55
90.14	44.01	V	-59.17	-7.75	1.27	-68.19	-13.00	-55.19
140.58	34.40	V	-63.76	-7.79	1.55	-73.10	-13.00	-60.10
387.93	33.39	V	-62.62	-7.66	2.47	-72.75	-13.00	-59.75
606.18	33.81	V	-55.68	-7.79	3.05	-66.52	-13.00	-53.52
824.00	76.25	V	-10.14	-7.87	3.62	-21.64	-13.00	-8.64
1648.40	49.41	V	-55.17	9.29	5.23	-51.11	-13.00	-38.11
2472.60	42.16	V	-58.85	10.08	6.53	-55.30	-13.00	-42.30
3296.80	---	V		12.17	7.71		-13.00	
4121.00	---	V		12.61	8.86		-13.00	
4945.20	---	V		12.65	9.74		-13.00	
5769.40	---	V		13.55	10.54		-13.00	
6593.60	---	V		12.05	11.30		-13.00	
7417.80	---	V		11.49	12.10		-13.00	
8242.00	---	V		11.48	12.71		-13.00	

Measurement uncertainty	30MHz - 80MHz: 5.04dB
	80MHz -1000MHz: 3.76dB
	1GHz - 13GHz: 4.45dB

Remark:

- 1 The emission behaviors belong to narrowband spurious emission.
- 2 Remark"---" means that the emission level is too low to be measured
- 3 The result basic equation calculation is as follows:
- 4 $ERP/EIRP (dBm) = SG \text{ Setting}(dBm) + Antenna \text{ Gain} (dB/dBi) - Cable \text{ loss} (dB)$

Unless otherwise stated the results shown in this test report refer only to the sample(s) tested and such sample(s) are retained for 90 days only.

除非另有說明，此報告結果僅對測試之樣品負責，同時此樣品僅保留90天。本報告未經本公司書面許可，不可部份複製。

This document is issued by the Company subject to its General Conditions of Service printed overleaf, available on request or accessible at www.sgs.com/terms_and_conditions.htm and, for electronic format documents, subject to Terms and Conditions for Electronic Documents at www.sgs.com/terms_e-document.htm. Attention is drawn to the limitation of liability, indemnification and jurisdiction issues defined therein. Any holder of this document is advised that information contained hereon reflects the Company's findings at the time of its intervention only and within the limits of Client's instructions, if any. The Company's sole responsibility is to its Client and this document does not exonerate parties to a transaction from exercising all their rights and obligations under the transaction documents. This document cannot be reproduced except in full, without prior written approval of the Company. Any unauthorized alteration, forgery or falsification of the content or appearance of this document is unlawful and offenders may be prosecuted to the fullest extent of the law.

Radiated Spurious Emission Measurement Result: GSM 850 Mode

Operation Mode	: TX CH Low Mode	Test Date:	Mar. 25, 2010
Fundamental Frequency	: 824.20 MHz	Test By:	Jason
Temperature	: 25°C	Pol:	Hor
Humidity	: 65%		

Freq. (MHz)	SPA Reading (dBuV)	Ant.Pol. H/V	S.G Output (dBm)	Antenna Gain (dB/dBi)	Cable Loss (dB)	ERP/EIRP (dBm)	Limit (dBm)	Safe Margin (dBm)
56.19	39.67	H	-69.97	-0.51	1.09	-71.57	-13.00	-58.57
90.14	37.33	H	-66.40	-7.75	1.27	-75.42	-13.00	-62.42
177.44	36.58	H	-63.32	-7.82	1.66	-72.80	-13.00	-59.80
324.88	33.75	H	-63.68	-7.78	2.26	-73.73	-13.00	-60.73
480.08	34.13	H	-59.50	-7.71	2.74	-69.95	-13.00	-56.95
633.34	33.85	H	-56.20	-7.80	3.12	-67.12	-13.00	-54.12
824.00	77.47	H	-8.80	-7.87	3.62	-20.30	-13.00	-7.30
1648.40	55.09	H	-49.31	9.29	5.23	-45.25	-13.00	-32.25
2472.60	43.35	H	-57.56	10.08	6.53	-54.01	-13.00	-41.01
3296.80	---	H		12.17	7.71		-13.00	
4121.00	---	H		12.61	8.86		-13.00	
4945.20	---	H		12.65	9.74		-13.00	
5769.40	---	H		13.55	10.54		-13.00	
6593.60	---	H		12.05	11.30		-13.00	
7417.80	---	H		11.49	12.10		-13.00	
8242.00	---	H		11.48	12.71		-13.00	

Measurement uncertainty	30MHz - 80MHz: 5.04dB
	80MHz -1000MHz: 3.76dB
	1GHz - 13GHz: 4.45dB

Remark:

- 1 The emission behaviors belong to narrowband spurious emission.
- 2 Remark"---" means that the emission level is too low to be measured
- 3 The result basic equation calculation is as follows:
- 4 $ERP/EIRP (dBm) = SG \text{ Setting}(dBm) + Antenna \text{ Gain} (dB/dBi) - Cable \text{ loss} (dB)$

Unless otherwise stated the results shown in this test report refer only to the sample(s) tested and such sample(s) are retained for 90 days only.
 除非另有說明，此報告結果僅對測試之樣品負責，同時此樣品僅保留90天。本報告未經本公司書面許可，不可部份複製。
 This document is issued by the Company subject to its General Conditions of Service printed overleaf, available on request or accessible at www.sgs.com/terms_and_conditions.htm and, for electronic format documents, subject to Terms and Conditions for Electronic Documents at www.sgs.com/terms_e-document.htm. Attention is drawn to the limitation of liability, indemnification and jurisdiction issues defined therein. Any holder of this document is advised that information contained hereon reflects the Company's findings at the time of its intervention only and within the limits of Client's instructions, if any. The Company's sole responsibility is to its Client and this document does not exonerate parties to a transaction from exercising all their rights and obligations under the transaction documents. This document cannot be reproduced except in full, without prior written approval of the Company. Any unauthorized alteration, forgery or falsification of the content or appearance of this document is unlawful and offenders may be prosecuted to the fullest extent of the law.

Radiated Spurious Emission Measurement Result: GSM 850 Mode

Operation Mode	: TX CH Mid Mode	Test Date:	Mar. 25, 2010
Fundamental Frequency	: 836.60 MHz	Test By:	Jason
Temperature	: 25°C	Pol:	Ver
Humidity	: 65%		

Freq. (MHz)	SPA. Reading (dBuV)	Ant.Pol. H/V	S.G Out-put (dBm)	Antenna Gain (dB/dBi)	Cable Loss (dB)	ERP/EIRP (dBm)	Limit (dBm)	Safe Margin (dBm)
31.94	48.87	V	-55.27	-6.43	0.94	-62.64	-13.00	-49.64
56.19	40.21	V	-69.45	-0.51	1.09	-71.06	-13.00	-58.06
90.14	43.42	V	-59.76	-7.75	1.27	-68.78	-13.00	-55.78
106.63	39.95	V	-61.36	-7.77	1.39	-70.51	-13.00	-57.51
250.19	33.37	V	-66.51	-7.89	1.99	-76.39	-13.00	-63.39
596.48	34.28	V	-55.50	-7.79	3.03	-66.31	-13.00	-53.31
1673.20	52.97	V	-51.59	9.36	5.27	-47.49	-13.00	-34.49
2509.80	38.60	V	-62.18	10.09	6.58	-58.68	-13.00	-45.68
3346.40	---	V		12.28	7.79		-13.00	
4183.00	---	V		12.62	8.93		-13.00	
5019.60	---	V		12.67	9.81		-13.00	
5856.20	---	V		13.68	10.62		-13.00	
6692.80	---	V		11.95	11.39		-13.00	
7529.40	---	V		11.45	12.20		-13.00	
8366.00	---	V		11.59	12.81		-13.00	

Measurement uncertainty	30MHz - 80MHz: 5.04dB
	80MHz -1000MHz: 3.76dB
	1GHz - 13GHz: 4.45dB

Remark:

- 1 The emission behaviors belongs to narrowband spurious emission.
- 2 Remark"---" means that the emission level is too low to be measured
- 3 The result basic equation calculation is as follows:
- 4 $ERP/EIRP (dBm) = SG \text{ Setting}(dBm) + Antenna \text{ Gain} (dB/dBi) - Cable \text{ loss} (dB)$

Unless otherwise stated the results shown in this test report refer only to the sample(s) tested and such sample(s) are retained for 90 days only.
 除非另有說明，此報告結果僅對測試之樣品負責，同時此樣品僅保留90天。本報告未經本公司書面許可，不可部份複製。
 This document is issued by the Company subject to its General Conditions of Service printed overleaf, available on request or accessible at www.sgs.com/terms_and_conditions.htm and, for electronic format documents, subject to Terms and Conditions for Electronic Documents at www.sgs.com/terms_e-document.htm. Attention is drawn to the limitation of liability, indemnification and jurisdiction issues defined therein. Any holder of this document is advised that information contained hereon reflects the Company's findings at the time of its intervention only and within the limits of Client's instructions, if any. The Company's sole responsibility is to its Client and this document does not exonerate parties to a transaction from exercising all their rights and obligations under the transaction documents. This document cannot be reproduced except in full, without prior written approval of the Company. Any unauthorized alteration, forgery or falsification of the content or appearance of this document is unlawful and offenders may be prosecuted to the fullest extent of the law.

Radiated Spurious Emission Measurement Result: GSM 850 Mode

Operation Mode	: TX CH Mid Mode	Test Date:	Mar. 25, 2010
Fundamental Frequency	: 836.60 MHz	Test By:	Jason
Temperature	: 25°C	Pol:	Hor
Humidity	: 65%		

Freq. (MHz)	SPA. Reading (dBuV)	Ant.Pol. H/V	S.G Out-put (dBm)	Antenna Gain (dB/dBi)	Cable Loss (dB)	ERP/EIRP (dBm)	Limit (dBm)	Safe Margin (dBm)
38.73	37.96	H	-65.23	-3.25	0.90	-69.38	-13.00	-56.38
56.19	39.40	H	-70.24	-0.51	1.09	-71.84	-13.00	-58.84
90.14	37.80	H	-65.93	-7.75	1.27	-74.95	-13.00	-61.95
153.19	33.08	H	-64.94	-7.80	1.60	-74.34	-13.00	-61.34
397.63	33.47	H	-63.00	-7.66	2.50	-73.16	-13.00	-60.16
601.33	34.68	H	-55.99	-7.79	3.03	-66.82	-13.00	-53.82
1673.20	54.81	H	-49.57	9.36	5.27	-45.47	-13.00	-32.47
2509.80	---	H		10.09	6.58		-13.00	
3346.40	---	H		12.28	7.79		-13.00	
4183.00	---	H		12.62	8.93		-13.00	
5019.60	---	H		12.67	9.81		-13.00	
5856.20	---	H		13.68	10.62		-13.00	
6692.80	---	H		11.95	11.39		-13.00	
7529.40	---	H		11.45	12.20		-13.00	
8366.00	---	H		11.59	12.81		-13.00	

Measurement uncertainty	30MHz - 80MHz: 5.04dB
	80MHz -1000MHz: 3.76dB
	1GHz - 13GHz: 4.45dB

Remark:

- 1 The emission behaviors belong to narrowband spurious emission.
- 2 Remark"---" means that the emission level is too low to be measured
- 3 The result basic equation calculation is as follows:
- 4 $ERP/EIRP (dBm) = SG \text{ Setting}(dBm) + Antenna \text{ Gain} (dB/dBi) - Cable \text{ loss} (dB)$

Unless otherwise stated the results shown in this test report refer only to the sample(s) tested and such sample(s) are retained for 90 days only.
 除非另有說明，此報告結果僅對測試之樣品負責，同時此樣品僅保留90天。本報告未經本公司書面許可，不可部份複製。
 This document is issued by the Company subject to its General Conditions of Service printed overleaf, available on request or accessible at www.sgs.com/terms_and_conditions.htm and, for electronic format documents, subject to Terms and Conditions for Electronic Documents at www.sgs.com/terms_e-document.htm. Attention is drawn to the limitation of liability, indemnification and jurisdiction issues defined therein. Any holder of this document is advised that information contained hereon reflects the Company's findings at the time of its intervention only and within the limits of Client's instructions, if any. The Company's sole responsibility is to its Client and this document does not exonerate parties to a transaction from exercising all their rights and obligations under the transaction documents. This document cannot be reproduced except in full, without prior written approval of the Company. Any unauthorized alteration, forgery or falsification of the content or appearance of this document is unlawful and offenders may be prosecuted to the fullest extent of the law.

Radiated Spurious Emission Measurement Result: GSM 850 Mode

Operation Mode	: TX CH High Mode	Test Date:	Mar. 25, 2010
Fundamental Frequency	: 848.80 MHz	Test By:	Jason
Temperature	: 25°C	Pol:	Ver
Humidity	: 65%		

Freq. (MHz)	SPA Reading (dBuV)	Ant.Pol. H/V	S.G Out-put (dBm)	Antenna Gain (dB/dBi)	Cable Loss (dB)	ERP/EIRP (dBm)	Limit (dBm)	Safe Margin (dBm)
56.19	40.27	V	-69.39	-0.51	1.09	-71.00	-13.00	-58.00
90.14	43.30	V	-59.88	-7.75	1.27	-68.90	-13.00	-55.90
106.63	40.34	V	-60.97	-7.77	1.39	-70.12	-13.00	-57.12
140.58	34.59	V	-63.57	-7.79	1.55	-72.91	-13.00	-59.91
434.49	33.35	V	-61.07	-7.69	2.61	-71.37	-13.00	-58.37
572.23	34.34	V	-56.85	-7.77	2.99	-67.62	-13.00	-54.62
850.00	80.31	V	-5.80	-7.88	3.68	-17.36	-13.00	-4.36
1697.60	49.71	V	-54.83	9.44	5.31	-50.70	-13.00	-37.70
2546.40	38.94	V	-61.70	10.20	6.63	-58.14	-13.00	-45.14
3395.20	---	V		12.38	7.87		-13.00	
4244.00	---	V		12.63	9.00		-13.00	
5092.80	---	V		12.74	9.88		-13.00	
5941.60	---	V		13.81	10.70		-13.00	
6790.40	---	V		11.86	11.48		-13.00	
7639.20	43.28	V	-37.20	11.40	12.27	-38.07	-13.00	-25.07
8488.00	---	V		11.70	12.91		-13.00	

Measurement uncertainty	30MHz - 80MHz: 5.04dB
	80MHz -1000MHz: 3.76dB
	1GHz - 13GHz: 4.45dB

Remark:

- 1 The emission behaviors belong to narrowband spurious emission.
- 2 Remark"---" means that the emission level is too low to be measured
- 3 The result basic equation calculation is as follows:
- 4 $ERP/EIRP (dBm) = SG \text{ Setting}(dBm) + Antenna \text{ Gain} (dB/dBi) - Cable \text{ loss} (dB)$

Unless otherwise stated the results shown in this test report refer only to the sample(s) tested and such sample(s) are retained for 90 days only.
 除非另有說明，此報告結果僅對測試之樣品負責，同時此樣品僅保留90天。本報告未經本公司書面許可，不可部份複製。
 This document is issued by the Company subject to its General Conditions of Service printed overleaf, available on request or accessible at www.sgs.com/terms_and_conditions.htm and, for electronic format documents, subject to Terms and Conditions for Electronic Documents at www.sgs.com/terms_e-document.htm. Attention is drawn to the limitation of liability, indemnification and jurisdiction issues defined therein. Any holder of this document is advised that information contained hereon reflects the Company's findings at the time of its intervention only and within the limits of Client's instructions, if any. The Company's sole responsibility is to its Client and this document does not exonerate parties to a transaction from exercising all their rights and obligations under the transaction documents. This document cannot be reproduced except in full, without prior written approval of the Company. Any unauthorized alteration, forgery or falsification of the content or appearance of this document is unlawful and offenders may be prosecuted to the fullest extent of the law.

Radiated Spurious Emission Measurement Result: GSM 850 Mode

Operation Mode	: TX CH High Mode	Test Date:	Mar. 25, 2010
Fundamental Frequency	: 848.80 MHz	Test By:	Jason
Temperature	: 25°C	Pol:	Hor
Humidity	: 65%		

Freq. (MHz)	SPA Reading (dBuV)	Ant.Pol. H/V	S.G Out-put (dBm)	Antenna Gain (dB/dBi)	Cable Loss (dB)	ERP/EIRP (dBm)	Limit (dBm)	Safe Margin (dBm)
38.73	38.09	H	-65.10	-3.25	0.90	-69.25	-13.00	-56.25
56.19	38.71	H	-70.93	-0.51	1.09	-72.53	-13.00	-59.53
96.93	37.79	H	-65.44	-7.76	1.33	-74.53	-13.00	-61.53
179.38	35.09	H	-64.96	-7.82	1.66	-74.44	-13.00	-61.44
480.08	34.00	H	-59.63	-7.71	2.74	-70.08	-13.00	-57.08
643.04	33.51	H	-56.35	-7.81	3.14	-67.30	-13.00	-54.30
850.00	76.96	H	-9.23	-7.88	3.68	-20.79	-13.00	-7.79
1697.60	51.58	H	-52.77	9.44	5.31	-48.64	-13.00	-35.64
2546.40	44.73	H	-55.87	10.20	6.63	-52.31	-13.00	-39.31
3395.20	---	H		12.38	7.87		-13.00	
4244.00	---	H		12.63	9.00		-13.00	
5092.80	---	H		12.74	9.88		-13.00	
5941.60	---	H		13.81	10.70		-13.00	
6790.40	---	H		11.86	11.48		-13.00	
7639.20	41.07	H	-39.36	11.40	12.27	-40.23	-13.00	-27.23
8488.00	---	H		11.70	12.91		-13.00	

Measurement uncertainty	30MHz - 80MHz: 5.04dB
	80MHz -1000MHz: 3.76dB
	1GHz - 13GHz: 4.45dB

Remark:

- 1 The emission behaviors belong to narrowband spurious emission.
- 2 Remark"---" means that the emission level is too low to be measured
- 3 The result basic equation calculation is as follows:
- 4 $ERP/EIRP (dBm) = SG \text{ Setting}(dBm) + Antenna \text{ Gain} (dB/dBi) - Cable \text{ loss} (dB)$

Unless otherwise stated the results shown in this test report refer only to the sample(s) tested and such sample(s) are retained for 90 days only.
 除非另有說明，此報告結果僅對測試之樣品負責，同時此樣品僅保留90天。本報告未經本公司書面許可，不可部份複製。
 This document is issued by the Company subject to its General Conditions of Service printed overleaf, available on request or accessible at www.sgs.com/terms_and_conditions.htm and, for electronic format documents, subject to Terms and Conditions for Electronic Documents at www.sgs.com/terms_e-document.htm. Attention is drawn to the limitation of liability, indemnification and jurisdiction issues defined therein. Any holder of this document is advised that information contained hereon reflects the Company's findings at the time of its intervention only and within the limits of Client's instructions, if any. The Company's sole responsibility is to its Client and this document does not exonerate parties to a transaction from exercising all their rights and obligations under the transaction documents. This document cannot be reproduced except in full, without prior written approval of the Company. Any unauthorized alteration, forgery or falsification of the content or appearance of this document is unlawful and offenders may be prosecuted to the fullest extent of the law.

Radiated Spurious Emission Measurement Result: PCS 1900 Mode

Operation Mode	: TX CH Low Mode	Test Date:	Mar. 25, 2010
Fundamental Frequency	: 1850.20MHz	Test By:	Jason
Temperature	: 25°C	Pol:	Ver
Humidity	: 65%		

Freq. (MHz)	SPA. Reading (dBuV)	Ant.Pol. H/V	S.G Out-put (dBm)	Antenna Gain (dB/dBi)	Cable Loss (dB)	ERP/EIRP (dBm)	Limit (dBm)	Safe Margin (dBm)
31.94	43.08	V	-61.06	-6.43	0.94	-68.43	-13.00	-55.43
56.19	39.58	V	-70.08	-0.51	1.09	-71.69	-13.00	-58.69
75.59	40.56	V	-70.96	-1.85	1.19	-74.01	-13.00	-61.01
90.14	42.68	V	-60.50	-7.75	1.27	-69.52	-13.00	-56.52
402.48	33.41	V	-62.01	-7.66	2.52	-72.19	-13.00	-59.19
594.54	34.63	V	-55.26	-7.79	3.02	-66.07	-13.00	-53.07
1850.00	71.58	V	-32.81	9.90	5.56	-28.47	-13.00	-15.47
3700.40	41.62	V	-56.31	12.61	8.31	-52.01	-13.00	-39.01
5550.60	37.94	V	-52.90	13.23	10.33	-50.00	-13.00	-37.00
7400.80	---	V		11.50	12.08		-13.00	
9251.00	---	V		11.92	13.50		-13.00	
11101.20	---	V		11.66	15.11		-13.00	
12951.40	---	V		13.63	16.60		-13.00	
14801.60	---	V		12.76	17.95		-13.00	
16651.80	---	V		15.92	19.14		-13.00	
18502.00	---	V		18.75	10.40		-13.00	

Measurement uncertainty	30MHz - 80MHz: 5.04dB
	80MHz -1000MHz: 3.76dB
	1GHz - 13GHz: 4.45dB

Remark:

- 1 The emission behaviors belong to narrowband spurious emission.
- 2 Remark"---" means that the emission level is too low to be measured
- 3 The result basic equation calculation is as follows:
- 4 $ERP/EIRP (dBm) = SG \text{ Setting}(dBm) + Antenna \text{ Gain} (dB/dBi) - Cable \text{ loss} (dB)$

Unless otherwise stated the results shown in this test report refer only to the sample(s) tested and such sample(s) are retained for 90 days only.
 除非另有說明，此報告結果僅對測試之樣品負責，同時此樣品僅保留90天。本報告未經本公司書面許可，不可部份複製。
 This document is issued by the Company subject to its General Conditions of Service printed overleaf, available on request or accessible at www.sgs.com/terms_and_conditions.htm and, for electronic format documents, subject to Terms and Conditions for Electronic Documents at www.sgs.com/terms_e-document.htm. Attention is drawn to the limitation of liability, indemnification and jurisdiction issues defined therein. Any holder of this document is advised that information contained hereon reflects the Company's findings at the time of its intervention only and within the limits of Client's instructions, if any. The Company's sole responsibility is to its Client and this document does not exonerate parties to a transaction from exercising all their rights and obligations under the transaction documents. This document cannot be reproduced except in full, without prior written approval of the Company. Any unauthorized alteration, forgery or falsification of the content or appearance of this document is unlawful and offenders may be prosecuted to the fullest extent of the law.

Radiated Spurious Emission Measurement Result: PCS 1900 Mode

Operation Mode	: TX CH Low Mode	Test Date:	Mar. 25, 2010
Fundamental Frequency	: 1850.20MHz	Test By:	Jason
Temperature	: 25°C	Pol:	Hor
Humidity	: 65%		

Freq. (MHz)	SPA Reading (dBuV)	Ant.Pol. H/V	S.G Output (dBm)	Antenna Gain (dB/dBi)	Cable Loss (dB)	ERP/EIRP (dBm)	Limit (dBm)	Safe Margin (dBm)
38.73	38.23	H	-64.96	-3.25	0.90	-69.11	-13.00	-56.11
56.19	38.80	H	-70.84	-0.51	1.09	-72.44	-13.00	-59.44
96.93	37.10	H	-66.13	-7.76	1.33	-75.22	-13.00	-62.22
148.34	32.85	H	-65.09	-7.80	1.58	-74.47	-13.00	-61.47
378.23	33.46	H	-63.31	-7.65	2.44	-73.40	-13.00	-60.40
516.94	34.24	H	-58.62	-7.73	2.85	-69.21	-13.00	-56.21
1850.00	79.21	H	-24.97	9.90	5.56	-20.63	-13.00	-7.63
3700.40	42.77	H	-55.27	12.61	8.31	-50.97	-13.00	-37.97
5550.60	37.93	H	-53.12	13.23	10.33	-50.22	-13.00	-37.22
7400.80	36.70	H	-44.53	11.50	12.08	-45.11	-13.00	-32.11
9251.00	---	H		11.92	13.50		-13.00	
11101.20	---	H		11.66	15.11		-13.00	
12951.40	---	H		13.63	16.60		-13.00	
14801.60	---	H		12.76	17.95		-13.00	
16651.80	---	H		15.92	19.14		-13.00	
18502.00	---	H		18.75	10.40		-13.00	

Measurement uncertainty	30MHz - 80MHz: 5.04dB
	80MHz -1000MHz: 3.76dB
	1GHz - 13GHz: 4.45dB

Remark:

- 1 The emission behaviors belong to narrowband spurious emission.
- 2 Remark"---" means that the emission level is too low to be measured
- 3 The result basic equation calculation is as follows:
- 4 $ERP/EIRP (dBm) = SG \text{ Setting}(dBm) + Antenna \text{ Gain} (dB/dBi) - Cable \text{ loss} (dB)$

Unless otherwise stated the results shown in this test report refer only to the sample(s) tested and such sample(s) are retained for 90 days only.
 除非另有說明，此報告結果僅對測試之樣品負責，同時此樣品僅保留90天。本報告未經本公司書面許可，不可部份複製。
 This document is issued by the Company subject to its General Conditions of Service printed overleaf, available on request or accessible at www.sgs.com/terms_and_conditions.htm and, for electronic format documents, subject to Terms and Conditions for Electronic Documents at www.sgs.com/terms_e-document.htm. Attention is drawn to the limitation of liability, indemnification and jurisdiction issues defined therein. Any holder of this document is advised that information contained hereon reflects the Company's findings at the time of its intervention only and within the limits of Client's instructions, if any. The Company's sole responsibility is to its Client and this document does not exonerate parties to a transaction from exercising all their rights and obligations under the transaction documents. This document cannot be reproduced except in full, without prior written approval of the Company. Any unauthorized alteration, forgery or falsification of the content or appearance of this document is unlawful and offenders may be prosecuted to the fullest extent of the law.

Radiated Spurious Emission Measurement Result: PCS 1900 Mode

Operation Mode	: TX CH Mid Mode	Test Date:	Mar. 25, 2010
Fundamental Frequency	: 1880MHz	Test By:	Jason
Temperature	: 25°C	Pol:	Ver
Humidity	: 65%		

Freq. (MHz)	SPA. Reading (dBuV)	Ant.Pol. H/V	S.G Out-put (dBm)	Antenna Gain (dB/dBi)	Cable Loss (dB)	ERP/EIRP (dBm)	Limit (dBm)	Safe Margin (dBm)
38.73	38.59	V	-63.58	-3.25	0.90	-67.72	-13.00	-54.72
56.19	39.90	V	-69.76	-0.51	1.09	-71.37	-13.00	-58.37
90.14	42.18	V	-61.00	-7.75	1.27	-70.02	-13.00	-57.02
106.63	38.97	V	-62.34	-7.77	1.39	-71.49	-13.00	-58.49
455.83	34.21	V	-59.74	-7.70	2.68	-70.12	-13.00	-57.12
1028.00	47.79	V	-58.91	6.13	0.28	-53.06	-13.00	-40.06
2708.00	45.16	V	-54.87	10.67	6.85	-51.06	-13.00	-38.06
3760.00	42.17	V	-55.49	12.60	8.39	-51.27	-13.00	-38.27
5438.00	35.94	V	-55.20	13.09	10.22	-52.33	-13.00	-39.33
5640.00	---	V		13.36	10.41		-13.00	
7520.00	---	V		11.45	12.19		-13.00	
9400.00	---	V		11.93	13.61		-13.00	
11280.00	---	V		11.92	15.27		-13.00	
13160.00	---	V		13.33	16.71		-13.00	
15040.00	---	V		13.76	18.15		-13.00	
16920.00	---	V		15.27	19.32		-13.00	
18800.00	---	V		18.68	16.58		-13.00	

Measurement uncertainty	30MHz - 80MHz: 5.04dB
	80MHz -1000MHz: 3.76dB
	1GHz - 13GHz: 4.45dB

Remark:

- 1 The emission behaviors belong to narrowband spurious emission.
- 2 Remark"---" means that the emission level is too low to be measured
- 3 The result basic equation calculation is as follows:
- 4 $ERP/EIRP (dBm) = SG \text{ Setting}(dBm) + Antenna \text{ Gain} (dB/dBi) - Cable \text{ loss} (dB)$

Unless otherwise stated the results shown in this test report refer only to the sample(s) tested and such sample(s) are retained for 90 days only.
 除非另有說明，此報告結果僅對測試之樣品負責，同時此樣品僅保留90天。本報告未經本公司書面許可，不可部份複製。
 This document is issued by the Company subject to its General Conditions of Service printed overleaf, available on request or accessible at www.sgs.com/terms_and_conditions.htm and, for electronic format documents, subject to Terms and Conditions for Electronic Documents at www.sgs.com/terms_e-document.htm. Attention is drawn to the limitation of liability, indemnification and jurisdiction issues defined therein. Any holder of this document is advised that information contained hereon reflects the Company's findings at the time of its intervention only and within the limits of Client's instructions, if any. The Company's sole responsibility is to its Client and this document does not exonerate parties to a transaction from exercising all their rights and obligations under the transaction documents. This document cannot be reproduced except in full, without prior written approval of the Company. Any unauthorized alteration, forgery or falsification of the content or appearance of this document is unlawful and offenders may be prosecuted to the fullest extent of the law.

Radiated Spurious Emission Measurement Result: PCS 1900 Mode

Operation Mode	: TX CH Mid Mode	Test Date:	Mar. 25, 2010
Fundamental Frequency	: 1880MHz	Test By:	Jason
Temperature	: 25°C	Pol:	Hor
Humidity	: 65%		

Freq. (MHz)	SPA Reading (dBuV)	Ant.Pol. H/V	S.G Out-put (dBm)	Antenna Gain (dB/dBi)	Cable Loss (dB)	ERP/EIRP (dBm)	Limit (dBm)	Safe Margin (dBm)
38.73	38.09	H	-65.10	-3.25	0.90	-69.25	-13.00	-56.25
53.28	39.78	H	-68.66	-0.55	1.11	-70.33	-13.00	-57.33
96.93	37.27	H	-65.96	-7.76	1.33	-75.05	-13.00	-62.05
284.14	34.47	H	-63.68	-7.91	2.11	-73.71	-13.00	-60.71
429.64	33.76	H	-61.16	-7.68	2.60	-71.45	-13.00	-58.45
1049.00	52.22	H	-54.42	6.25	0.49	-48.65	-13.00	-35.65
2708.00	48.75	H	-51.39	10.67	6.85	-47.57	-13.00	-34.57
3760.00	41.21	H	-56.56	12.60	8.39	-52.35	-13.00	-39.35
5640.00	---	H		13.36	10.41		-13.00	
7520.00	---	H		11.45	12.19		-13.00	
9400.00	---	H		11.93	13.61		-13.00	
11280.00	---	H		11.92	15.27		-13.00	
13160.00	---	H		13.33	16.71		-13.00	
15040.00	---	H		13.76	18.15		-13.00	
16920.00	---	H		15.27	19.32		-13.00	
18800.00	---	H		18.68	16.58		-13.00	

Measurement uncertainty	30MHz - 80MHz: 5.04dB
	80MHz -1000MHz: 3.76dB
	1GHz - 13GHz: 4.45dB

Remark:

- 1 The emission behaviors belong to narrowband spurious emission.
- 2 Remark"---" means that the emission level is too low to be measured
- 3 The result basic equation calculation is as follows:
- 4 $ERP/EIRP (dBm) = SG \text{ Setting}(dBm) + Antenna \text{ Gain} (dB/dBi) - Cable \text{ loss} (dB)$

Unless otherwise stated the results shown in this test report refer only to the sample(s) tested and such sample(s) are retained for 90 days only.
 除非另有說明，此報告結果僅對測試之樣品負責，同時此樣品僅保留90天。本報告未經本公司書面許可，不可部份複製。
 This document is issued by the Company subject to its General Conditions of Service printed overleaf, available on request or accessible at www.sgs.com/terms_and_conditions.htm and, for electronic format documents, subject to Terms and Conditions for Electronic Documents at www.sgs.com/terms_e-document.htm. Attention is drawn to the limitation of liability, indemnification and jurisdiction issues defined therein. Any holder of this document is advised that information contained hereon reflects the Company's findings at the time of its intervention only and within the limits of Client's instructions, if any. The Company's sole responsibility is to its Client and this document does not exonerate parties to a transaction from exercising all their rights and obligations under the transaction documents. This document cannot be reproduced except in full, without prior written approval of the Company. Any unauthorized alteration, forgery or falsification of the content or appearance of this document is unlawful and offenders may be prosecuted to the fullest extent of the law.

Radiated Spurious Emission Measurement Result: PCS 1900 Mode

Operation Mode	: TX CH High Mode	Test Date:	Mar. 25, 2010
Fundamental Frequency	: 1909.8 MHz	Test By:	Jason
Temperature	: 25°C	Pol:	Ver
Humidity	: 65%		

Freq. (MHz)	SPA Reading (dBuV)	Ant.Pol. H/V	S.G Out-put (dBm)	Antenna Gain (dB/dBi)	Cable Loss (dB)	ERP/EIRP (dBm)	Limit (dBm)	Safe Margin (dBm)
31.94	43.60	V	-60.54	-6.43	0.94	-67.91	-13.00	-54.91
56.19	39.64	V	-70.02	-0.51	1.09	-71.63	-13.00	-58.63
90.14	43.63	V	-59.55	-7.75	1.27	-68.57	-13.00	-55.57
478.14	34.29	V	-59.76	-7.71	2.74	-70.21	-13.00	-57.21
693.48	34.44	V	-54.93	-7.85	3.27	-66.06	-13.00	-53.06
1224.00	55.69	V	-50.19	7.26	2.23	-45.17	-13.00	-32.17
1910.00	68.20	V	-36.13	10.08	5.66	-31.71	-13.00	-18.71
2589.00	42.07	V	-58.41	10.32	6.69	-54.78	-13.00	-41.78
3819.60	39.44	V	-57.95	12.60	8.47	-53.82	-13.00	-40.82
5729.40	---	V		13.49	10.50		-13.00	
7639.20	---	V		11.40	12.27		-13.00	
9549.00	---	V		11.95	13.74		-13.00	
11458.80	---	V		12.17	15.43		-13.00	
13368.60	---	V		12.97	16.82		-13.00	
15278.40	---	V		15.00	18.29		-13.00	
17188.20	---	V		14.47	19.52		-13.00	
19098.00	---	V		18.66	20.78		-13.00	

Measurement uncertainty	30MHz - 80MHz: 5.04dB
	80MHz - 1000MHz: 3.76dB
	1GHz - 13GHz: 4.45dB

Remark:

- 1 The emission behaviors belong to narrowband spurious emission.
- 2 Remark"---" means that the emission level is too low to be measured
- 3 The result basic equation calculation is as follows:
- 4 $ERP/EIRP (dBm) = SG \text{ Setting}(dBm) + Antenna \text{ Gain} (dB/dBi) - Cable \text{ loss} (dB)$

Unless otherwise stated the results shown in this test report refer only to the sample(s) tested and such sample(s) are retained for 90 days only.
 除非另有說明，此報告結果僅對測試之樣品負責，同時此樣品僅保留90天。本報告未經本公司書面許可，不可部份複製。
 This document is issued by the Company subject to its General Conditions of Service printed overleaf, available on request or accessible at www.sgs.com/terms_and_conditions.htm and, for electronic format documents, subject to Terms and Conditions for Electronic Documents at www.sgs.com/terms_e-document.htm. Attention is drawn to the limitation of liability, indemnification and jurisdiction issues defined therein. Any holder of this document is advised that information contained hereon reflects the Company's findings at the time of its intervention only and within the limits of Client's instructions, if any. The Company's sole responsibility is to its Client and this document does not exonerate parties to a transaction from exercising all their rights and obligations under the transaction documents. This document cannot be reproduced except in full, without prior written approval of the Company. Any unauthorized alteration, forgery or falsification of the content or appearance of this document is unlawful and offenders may be prosecuted to the fullest extent of the law.

Radiated Spurious Emission Measurement Result: PCS 1900 Mode

Operation Mode	: TX CH High Mode	Test Date:	Mar. 25, 2010
Fundamental Frequency	: 1909.8 MHz	Test By:	Jason
Temperature	: 25°C	Pol:	Hor
Humidity	: 65%		

Freq. (MHz)	SPA Reading (dBuV)	Ant.Pol. H/V	S.G Out-put (dBm)	Antenna Gain (dB/dBi)	Cable Loss (dB)	ERP/EIRP (dBm)	Limit (dBm)	Safe Margin (dBm)
38.73	37.65	H	-65.54	-3.25	0.90	-69.69	-13.00	-56.69
54.25	38.95	H	-69.89	-0.54	1.10	-71.54	-13.00	-58.54
424.79	33.47	H	-61.70	-7.68	2.58	-71.96	-13.00	-58.96
594.54	34.31	H	-56.50	-7.79	3.02	-67.31	-13.00	-54.31
1259.00	58.71	H	-46.96	7.46	2.58	-42.09	-13.00	-29.09
1910.00	77.15	H	-26.96	10.08	5.66	-22.54	-13.00	-9.54
2554.00	45.77	H	-54.81	10.22	6.64	-51.23	-13.00	-38.23
3819.60	39.27	H	-58.24	12.60	8.47	-54.10	-13.00	-41.10
5729.40	---	H		13.49	10.50		-13.00	
7639.20	---	H		11.40	12.27		-13.00	
9549.00	---	H		11.95	13.74		-13.00	
11458.80	---	H		12.17	15.43		-13.00	
13368.60	---	H		12.97	16.82		-13.00	
15278.40	---	H		15.00	18.29		-13.00	
17188.20	---	H		14.47	19.52		-13.00	
19098.00	---	H		18.66	20.78		-13.00	

Measurement uncertainty	30MHz - 80MHz: 5.04dB
	80MHz - 1000MHz: 3.76dB
	1GHz - 13GHz: 4.45dB

Remark:

- 1 The emission behaviors belong to narrowband spurious emission.
- 2 Remark"---" means that the emission level is too low to be measured
- 3 The result basic equation calculation is as follows:
- 4 $ERP/EIRP (dBm) = SG \text{ Setting}(dBm) + Antenna \text{ Gain} (dB/dBi) - Cable \text{ loss} (dB)$

Unless otherwise stated the results shown in this test report refer only to the sample(s) tested and such sample(s) are retained for 90 days only.
 除非另有說明，此報告結果僅對測試之樣品負責，同時此樣品僅保留90天。本報告未經本公司書面許可，不可部份複製。
 This document is issued by the Company subject to its General Conditions of Service printed overleaf, available on request or accessible at www.sgs.com/terms_and_conditions.htm and, for electronic format documents, subject to Terms and Conditions for Electronic Documents at www.sgs.com/terms_e-document.htm. Attention is drawn to the limitation of liability, indemnification and jurisdiction issues defined therein. Any holder of this document is advised that information contained hereon reflects the Company's findings at the time of its intervention only and within the limits of Client's instructions, if any. The Company's sole responsibility is to its Client and this document does not exonerate parties to a transaction from exercising all their rights and obligations under the transaction documents. This document cannot be reproduced except in full, without prior written approval of the Company. Any unauthorized alteration, forgery or falsification of the content or appearance of this document is unlawful and offenders may be prosecuted to the fullest extent of the law.

10 FREQUENCY STABILITY V.S. TEMPERATURE MEASUREMENT

10.1 Standard Applicable

According to FCC §2.1055(a)(1)

Frequency Tolerance: +/- 2.5 ppm

10.2 Test Set-up:

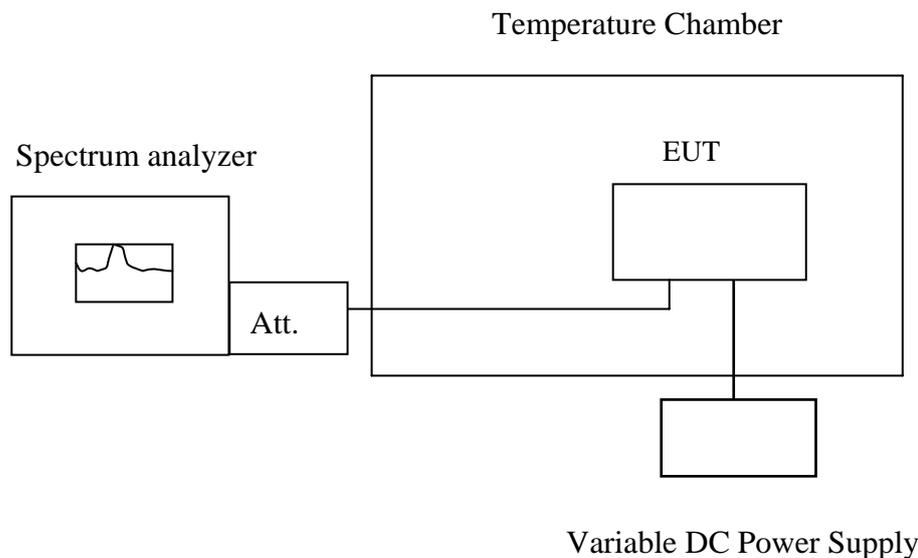

Note : Measurement setup for testing on Antenna connector

10.3 Measurement Procedure

The equipment under test was connected to an external AC or DC power supply and input rated voltage. RF output was connected to a frequency counter or spectrum analyzer via feed through attenuators. The EUT was placed inside the temperature chamber. Set the spectrum analyzer RBW low enough to obtain the desired frequency resolution and measure EUT 25°C operating frequency as reference frequency. Turn EUT off and set the chamber temperature to -30°C. After the temperature stabilized for approximately 30 minutes recorded the frequency. Repeat step measurement with 10°C increased per stage until the highest temperature of +50°C reached.

10.4 Measurement Equipment Used:

Refer to section 2.4 in this report

Unless otherwise stated the results shown in this test report refer only to the sample(s) tested and such sample(s) are retained for 90 days only.

除非另有說明，此報告結果僅對測試之樣品負責，同時此樣品僅保留90天。本報告未經本公司書面許可，不可部份複製。

This document is issued by the Company subject to its General Conditions of Service printed overleaf, available on request or accessible at www.sgs.com/terms_and_conditions.htm and, for electronic format documents, subject to Terms and Conditions for Electronic Documents at www.sgs.com/terms_e-document.htm. Attention is drawn to the limitation of liability, indemnification and jurisdiction issues defined therein. Any holder of this document is advised that information contained hereon reflects the Company's findings at the time of its intervention only and within the limits of Client's instructions, if any. The Company's sole responsibility is to its Client and this document does not exonerate parties to a transaction from exercising all their rights and obligations under the transaction documents. This document cannot be reproduced except in full, without prior written approval of the Company. Any unauthorized alteration, forgery or falsification of the content or appearance of this document is unlawful and offenders may be prosecuted to the fullest extent of the law.

10.5 Measurement Result

Reference Frequency: GSM Mid Channel 836.6 MHz ^{°C}				
Limit: +/- 2.5 ppm = 2091 Hz				
Power Supply	Environment	Frequency	Delta (Hz)	Limit (Hz)
Vdc	Temperature (°C)	(MHz)		
12	-30	836.600015	-32.00	2091
12	-20	836.600009	-26.00	2091
12	-10	836.600002	-19.00	2091
12	0	836.599998	-15.00	2091
12	10	836.599999	-16.00	2091
12	20	836.599983	0.00	2091
12	30	836.599991	-8.00	2091
12	40	836.599995	-12.00	2091
12	50	836.600003	-20.00	2091

Reference Frequency: PCS Mid Channel 1880 MHz				
Limit: +/- 2.5 ppm = 4700 Hz				
Power Supply	Environment	Frequency	Delta (Hz)	Limit (Hz)
Vdc	Temperature (°C)	(MHz)		
12	-30	1880.000028	-6.00	4700
12	-20	1880.000020	2.00	4700
12	-10	1880.000009	13.00	4700
12	0	1880.000015	7.00	4700
12	10	1880.000011	11.00	4700
12	20	1880.000022	0.00	4700
12	30	1880.000010	12.00	4700
12	40	1880.000019	3.00	4700
12	50	1880.000026	-4.00	4700

Unless otherwise stated the results shown in this test report refer only to the sample(s) tested and such sample(s) are retained for 90 days only.
 除非另有說明，此報告結果僅對測試之樣品負責，同時此樣品僅保留90天。本報告未經本公司書面許可，不可部份複製。
 This document is issued by the Company subject to its General Conditions of Service printed overleaf, available on request or accessible at www.sgs.com/terms_and_conditions.htm and, for electronic format documents, subject to Terms and Conditions for Electronic Documents at www.sgs.com/terms_e-document.htm. Attention is drawn to the limitation of liability, indemnification and jurisdiction issues defined therein. Any holder of this document is advised that information contained hereon reflects the Company's findings at the time of its intervention only and within the limits of Client's instructions, if any. The Company's sole responsibility is to its Client and this document does not exonerate parties to a transaction from exercising all their rights and obligations under the transaction documents. This document cannot be reproduced except in full, without prior written approval of the Company. Any unauthorized alteration, forgery or falsification of the content or appearance of this document is unlawful and offenders may be prosecuted to the fullest extent of the law.

11 FREQUENCY STABILITY V.S. VOLTAGE MEASUREMENT

11.1 Standard Applicable

According to FCC §2.1055(d)(2)

Frequency Tolerance: +/- 2.5 ppm

11.2 Test Set-up:

Refer to section 10.2 in this report

11.3 Measurement Procedure

Set chamber temperature to 25°C. Use a variable AC power supply / DC power source to power the EUT and set the voltage to rated voltage. Set the spectrum analyzer RBW low enough to obtain the desired frequency resolution and recorded the frequency.

Reduce the input voltage to specified extreme voltage variation (+/- 15%) and endpoint, record the maximum frequency change.

11.4 Measurement Equipment Used:

Refer to section 2.4 in this report

Unless otherwise stated the results shown in this test report refer only to the sample(s) tested and such sample(s) are retained for 90 days only.

除非另有說明，此報告結果僅對測試之樣品負責，同時此樣品僅保留90天。本報告未經本公司書面許可，不可部份複製。

This document is issued by the Company subject to its General Conditions of Service printed overleaf, available on request or accessible at www.sgs.com/terms_and_conditions.htm and, for electronic format documents, subject to Terms and Conditions for Electronic Documents at www.sgs.com/terms_e-document.htm. Attention is drawn to the limitation of liability, indemnification and jurisdiction issues defined therein. Any holder of this document is advised that information contained hereon reflects the Company's findings at the time of its intervention only and within the limits of Client's instructions, if any. The Company's sole responsibility is to its Client and this document does not exonerate parties to a transaction from exercising all their rights and obligations under the transaction documents. This document cannot be reproduced except in full, without prior written approval of the Company. Any unauthorized alteration, forgery or falsification of the content or appearance of this document is unlawful and offenders may be prosecuted to the fullest extent of the law.

11.5 Measurement Result

Reference Frequency: GSM Mid Channel 836.6 MHz				
Limit: +/- 2.5 ppm = 2091 Hz				
Power Supply	Environment	Frequency	Delta (Hz)	Limit (Hz)
Vdc	Temperature (°C)	(MHz)		
13.8	25.00	836.599995	-12.00	2091.00
12	25.00	836.599983	0.00	2091.00
10.2	25.00	836.600001	-18.00	2091.00
4.2 (End Point)	25.00	836.600098	-115.00	2091.00

Reference Frequency: PCS Mid Channel 1880 MHz				
Limit: +/- 2.5 ppm = 4700 Hz				
Power Supply	Environment	Frequency	Delta (Hz)	Limit (Hz)
Vdc	Temperature (°C)	(MHz)		
13.8	25	1880.000031	-9.00	4700
12	25	1880.000022	0.00	4700
10.2	25	1880.000012	10.00	4700
4.2 (End Point)	25	1880.000052	-30.00	4700

Unless otherwise stated the results shown in this test report refer only to the sample(s) tested and such sample(s) are retained for 90 days only.
 除非另有說明，此報告結果僅對測試之樣品負責，同時此樣品僅保留90天。本報告未經本公司書面許可，不可部份複製。
 This document is issued by the Company subject to its General Conditions of Service printed overleaf, available on request or accessible at www.sgs.com/terms_and_conditions.htm and, for electronic format documents, subject to Terms and Conditions for Electronic Documents at www.sgs.com/terms_e-document.htm. Attention is drawn to the limitation of liability, indemnification and jurisdiction issues defined therein. Any holder of this document is advised that information contained hereon reflects the Company's findings at the time of its intervention only and within the limits of Client's instructions, if any. The Company's sole responsibility is to its Client and this document does not exonerate parties to a transaction from exercising all their rights and obligations under the transaction documents. This document cannot be reproduced except in full, without prior written approval of the Company. Any unauthorized alteration, forgery or falsification of the content or appearance of this document is unlawful and offenders may be prosecuted to the fullest extent of the law.