

FCC Test Report

(PART 22)

Report No.: RF151027C13

FCC ID: YA7-ATVT-1544

Test Model: AL7

Received Date: Oct. 27, 2015

Test Date: Nov. 15, 2015 ~ Dec. 08, 2015

Issued Date: Dec. 08, 2015

Applicant: Atrack Technology Inc.

Address: 3F., No. 88, Sec. 1, Neihu Rd., Neihu Dist., Taipei City 11493 Taiwan
(R.O.C.)

Issued By: Bureau Veritas Consumer Products Services (H.K.) Ltd., Taoyuan Branch

Lab Address: No. 47-2, 14th Ling, Chia Pau Vil., Lin Kou Dist., New Taipei City, Taiwan
(R.O.C)

Test Location: No.19, Hwa Ya 2nd Rd., Wen Hwa Vil., Kwei Shan Dist., Taoyuan City
33383, Taiwan, R.O.C.



This report is for your exclusive use. Any copying or replication of this report to or for any other person or entity, or use of our name or trademark, is permitted only with our prior written permission. This report sets forth our findings solely with respect to the test samples identified herein. The results set forth in this report are not indicative or representative of the quality or characteristics of the lot from which a test sample was taken or any similar or identical product unless specifically and expressly noted. Our report includes all of the tests requested by you and the results thereof based upon the information that you provided to us. You have 60 days from date of issuance of this report to notify us of any material error or omission caused by our negligence, provided, however, that such notice shall be in writing and shall specifically address the issue you wish to raise. A failure to raise such issue within the prescribed time shall constitute your unqualified acceptance of the completeness of this report, the tests conducted and the correctness of the report contents. Unless specific mention, the uncertainty of measurement has been explicitly taken into account to declare the compliance or non-compliance to the specification. The report must not be used by the client to claim product certification, approval, or endorsement by TAF or any government agencies

Table of Contents

Release Control Record	3
1 Certificate of Conformity	4
2 Summary of Test Results.....	5
2.1 Measurement Uncertainty.....	5
2.2 Test Site and Instruments	6
3 General Information	7
3.1 General Description of EUT	7
3.2 Configuration of System under Test.....	8
3.2.1 Description of Support Units.....	8
3.3 Test Mode Applicability and Tested Channel Detail	9
3.4 EUT Operating Conditions	10
3.5 General Description of Applied Standards.....	10
4 Test Types and Results	11
4.1 Output Power Measurement.....	11
4.1.1 Limits of Output Power Measurement	11
4.1.2 Test Procedures.....	11
4.1.3 Test Setup.....	12
4.1.4 Test Results	13
4.2 Frequency Stability Measurement	14
4.2.1 Limits of Frequency Stability Measurement.....	14
4.2.2 Test Procedure	14
4.2.3 Test Setup.....	14
4.2.4 Test Results	15
4.3 Occupied Bandwidth Measurement.....	16
4.3.1 Test Procedure	16
4.3.2 Test Setup.....	16
4.3.3 Test Result	16
4.4 Band Edge Measurement	17
4.4.1 Limits of Band Edge Measurement	17
4.4.2 Test Setup.....	17
4.4.3 Test Procedures.....	17
4.4.4 Test Results	17
4.5 Peak to Average Ratio	18
4.5.1 Limits of Peak to Average Ratio Measurement	18
4.5.2 Test Setup.....	18
4.5.3 Test Procedures.....	18
4.5.4 Test Results	18
4.6 Conducted Spurious Emissions.....	19
4.6.1 Limits of Conducted Spurious Emissions Measurement.....	19
4.6.2 Test Setup.....	19
4.6.3 Test Procedure	19
4.6.4 Test Results	19
4.7 Radiated Emission Measurement.....	20
4.7.1 Limits of Radiated Emission Measurement	20
4.7.2 Test Procedure	20
4.7.3 Deviation from Test Standard	20
4.7.4 Test Setup.....	20
4.7.5 Test Results	21
5 Pictures of Test Arrangements.....	23
Appendix – Information on the Testing Laboratories	24



A D T

Release Control Record

Issue No.	Description	Date Issued
RF151027C13	Original Release	Dec. 08, 2015



1 Certificate of Conformity

Product: Tracker
Brand: ATrack Technology Inc.
Test Model: AL7
Sample Status: Identical Prototype
Applicant: Atrack Technology Inc.
Test Date: Nov. 15, 2015 ~ Dec. 08, 2015
Standards: FCC Part 22, Subpart H

The above equipment has been tested by **Bureau Veritas Consumer Products Services (H.K.) Ltd., Taoyuan Branch**, and found compliance with the requirement of the above standards. The test record, data evaluation & Equipment Under Test (EUT) configurations represented herein are true and accurate accounts of the measurements of the sample's EMC characteristics under the conditions specified in this report.

Prepared by : Rona Chen , **Date:** Dec. 08, 2015
Rona Chen / Specialist

Approved by : David Huang , **Date:** Dec. 08, 2015
David Huang / Project Engineer

2 Summary of Test Results

Applied Standard: FCC Part 22 & Part 2			
FCC Clause	Test Item	Result	Remarks
2.1046 22.913 (a)	Effective Radiated Power	Pass	Meet the requirement of limit.
---	Peak to Average Ratio	Pass	Meet the requirement of limit.
2.1055 22.355	Frequency Stability	Pass	Meet the requirement of limit.
2.1049	Occupied Bandwidth	Pass	Meet the requirement of limit.
22.917	Band Edge Measurements	Pass	Meet the requirement of limit.
2.1051 22.917	Conducted Spurious Emissions	Pass	Meet the requirement of limit.
2.1053 22.917	Radiated Spurious Emissions	Pass	Meet the requirement of limit. Minimum passing margin is -35.95 dB at 261.12 MHz.

2.1 Measurement Uncertainty

Where relevant, the following measurement uncertainty levels have been estimated for tests performed on the EUT as specified in CISPR 16-4-2:

Measurement	Frequency	Expanded Uncertainty (k=2) (±)
Conducted Emissions at mains ports	150 kHz ~ 30 MHz	2.44 dB
Radiated Emissions up to 1 GHz	30 MHz ~ 200 MHz	2.93 dB
	200 MHz ~1000 MHz	2.95 dB
Radiated Emissions above 1 GHz	1 GHz ~ 18 GHz	2.26 dB
	18 GHz ~ 40 GHz	1.94 dB



2.2 Test Site and Instruments

Description & Manufacturer	Model No.	Serial No.	Date of Calibration	Due Date of Calibration
Test Receiver Agilent	N9038A	MY51210203	Jan. 21, 2015	Jan. 21, 2016
Spectrum Analyzer Agilent	N9010A	MY52220314	Sep. 03, 2015	Sep. 02, 2016
Spectrum Analyzer ROHDE & SCHWARZ	FSU43	101261	Dec. 10, 2014	Dec. 09, 2015
BILOG Antenna SCHWARZBECK	VULB9168	9168-472	Feb. 04, 2015	Feb. 04, 2016
HORN Antenna SCHWARZBECK	BBHA 9120 D	9120D-969	Feb. 09, 2015	Feb. 09, 2016
HORN Antenna SCHWARZBECK	BBHA 9170	9170-480	Feb. 04, 2015	Feb. 04, 2016
Loop Antenna	EM-6879	269	Jul. 31, 2015	Jul. 30, 2016
Preamplifier EMCI	EMC 012645	980115	Dec. 12, 2014	Dec. 11, 2015
Preamplifier EMCI	EMC 184045	980116	Jan. 09, 2015	Jan. 08, 2016
Preamplifier EMCI	EMC 330H	980112	Dec. 27, 2014	Dec. 26, 2015
Power Meter Anritsu	ML2495A	1232002	Sep. 21, 2015	Sep. 20, 2016
Power Sensor Anritsu	MA2411B	1207325	Sep. 21, 2015	Sep. 20, 2016
RF signal cable HUBER+SUHNNER	SUCOFLEX 104	309219/4 2950114	Oct. 12, 2015	Oct. 11, 2016
RF signal cable HUBER+SUHNNER	SUCOFLEX 104	250130/4	Oct. 12, 2015	Oct. 11, 2016
RF Coaxial Cable Worken	8D-FB	Cable-Ch10-01	Oct. 12, 2015	Oct. 11, 2016
Software BV ADT	E3 6.120103	NA	NA	NA
Antenna Tower MF	MFA-440H	NA	NA	NA
Turn Table MF	MFT-201SS	NA	NA	NA
Antenna Tower & Turn Table Controller MF	MF-7802	NA	NA	NA
Radio Communication Analyzer	MT8820C	6201300640	Aug. 10, 2015	Aug. 09, 2017

Note: 1. The calibration interval of the above test instruments is 12 months and the calibrations are traceable to NML/ROC and NIST/USA.

2. The test was performed in HwaYa Chamber 10.

3. The horn antenna and preamplifier (model: EMC 184045) are used only for the measurement of emission frequency above 1 GHz if tested.

4. The FCC Site Registration No. is 690701.

5. The IC Site Registration No. is IC7450F-10.

3 General Information

3.1 General Description of EUT

Product	Tracker
Brand	ATrack Technology Inc.
Test Model	AL7
Status of EUT	Identical Prototype
Power Supply Rating	5.0Vdc (Host equipment) 3.7Vdc (Li-ion battery) 12 or 24Vdc (DC Power Supply)
Modulation Type	QPSK, OPQKS, HPSK
Frequency Range	824.7 ~ 848.31 MHz
Max. ERP Power	88.10 mW
Emission Designator	1M27F9W
Antenna Type	Fixed Internal Antenna
Accessory Device	Refer to Note as below
Data Cable Supplied	Refer to Note as below

Note:

1. The EUT contains following accessory devices.

Product	Brand	Model	Description
Battery	JOULES MILES CO., LTD.	AT-01	3.7Vdc, 920mAh
USB Cable	Kaen Technology Co., LTD.	N/A	1.2m non-shielded cable w/o core

2. The above EUT information is declared by manufacturer and for more detailed features description, please refer to the manufacturer's specifications or user's manual.

3.2 Configuration of System under Test

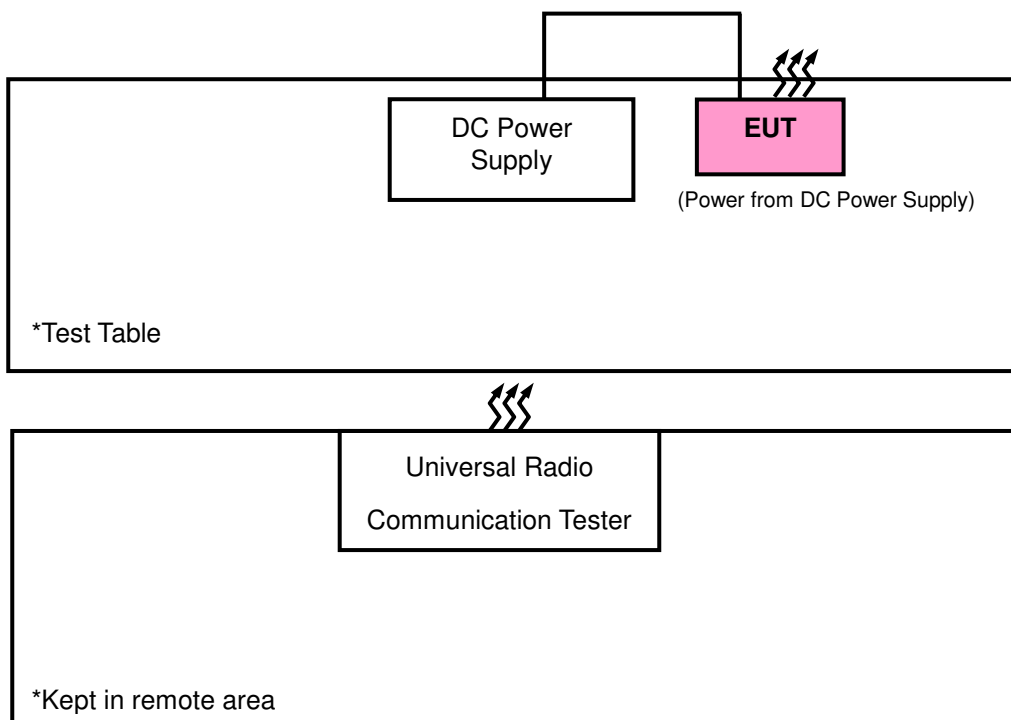

3.2.1 Description of Support Units

The EUT has been tested as an independent unit together with other necessary accessories or support units. The following support units or accessories were used to form a representative test configuration during the tests.

No.	Product	Brand	Model No.	Serial No.	FCC ID
1.	Communications Tester-Wireless	Agilent	E5515C	MY52102544	NA
2.	DC Power Supply	Topward	33010D	807748	N/A

No.	Signal Cable Description Of The Above Support Units
1.	N/A
2.	1.2m non-shielded cable w/o core

Note:

1. All power cords of the above support units are non-shielded (1.8m).
2. Items 1 acted as communication partners to transfer data.

3.3 Test Mode Applicability and Tested Channel Detail

Pre-Scan has been conducted to determine the worst-case mode from all possible combinations between available modulations, data rates, XYZ axis, and antenna ports.

The worst case was found when positioned as the table below. Following channel(s) was (were) selected for the final test as listed below:

Band	ERP	Radiated Emission
CDMA	X-plane	X-axis

CDMA

EUT Configure Mode	Test Item	Available Channel	Tested Channel	Mode
-	ERP	1013 to 777	1013, 384, 777	1xRTT
-	Frequency Stability	1013 to 777	384	1xRTT
-	Occupied Bandwidth	1013 to 777	1013, 384, 777	1xRTT
-	Band Edge	1013 to 777	1013, 777	1xRTT
-	Peak to Average Ratio	1013 to 777	1013, 384, 777	1xRTT
-	Conducuted Emission	1013 to 777	384	1xRTT
-	Radiated Emission	1013 to 777	384	1xRTT

Test Condition:

Test Item	Environmental Conditions	Input Power	Tested By
ERP	25 deg. C, 65 % RH	12 Vdc	Anson Lin
Frequency Stability	25 deg. C, 65 % RH	12 Vdc	Carlos Chen
Occupied Bandwidth	25 deg. C, 65 % RH	12 Vdc	Carlos Chen
Band Edge	25 deg. C, 65 % RH	12 Vdc	Carlos Chen
Peak to Average Ratio	25 deg. C, 65 % RH	12 Vdc	Carlos Chen
Conducuted Emission	25 deg. C, 65 % RH	12 Vdc	Carlos Chen
Radiated Emission	25 deg. C, 65 % RH	120 Vac, 60 Hz	Gavin Wu

3.4 EUT Operating Conditions

The EUT makes a call to the communication simulator. The communication simulator station system controlled a EUT to export maximum output power under transmission mode and specific channel frequency.

3.5 General Description of Applied Standards

The EUT is a RF Product. According to the specifications of the manufacturer, it must comply with the requirements of the following standards:

FCC 47 CFR Part 2

FCC 47 CFR Part 22

ANSI/TIA/EIA-603-C 2004

NOTE: All test items have been performed and recorded as per the above standards.

4 Test Types and Results

4.1 Output Power Measurement

4.1.1 Limits of Output Power Measurement

Mobile / Portable station are limited to 7 watts e.r.p.

4.1.2 Test Procedures

EIRP / ERP Measurement:

- a. All measurements were done at low, middle and high operational frequency range. RBW and VBW is 1 MHz for GSM, GPRS & EDGE, and 5 MHz for WCDMA and CDMA, and 10 MHz for LTE mode.
- b. Substitution method is used for E.I.R.P measurement. In the semi-anechoic chamber, EUT placed on the 0.8 m height of Turn Table, rotated the table around 360 degrees to search the maximum radiation power and receiver antenna shall be rotated vertical and horizontal polarization and moved height from 1 m to 4 m to find the maximum polar radiated power. The "Read Value" is the spectrum reading the maximum power value.
- c. The substitution horn antenna is substituted for EUT at the same position and signals generator export the CW signal to the substitution antenna via a tx cable. Rotated the Turn Table and moved receiving antenna to find the maximum radiation power. Adjust output power level of S.G to get a Value of spectrum reading equal to "Read Value" of step b. Record the power level of S.G.
- d. $EIRP = \text{Output power level of S.G} - \text{TX cable loss} + \text{Antenna gain of substitution horn}$. E.R.P power can be calculated form E.I.R.P power by subtracting the gain of dipole, $E.R.P \text{ power} = E.I.P.R \text{ power} - 2.15 \text{ dBi}$.

Conducted Power Measurement:

The EUT was set up for the maximum power with GSM, GPRS, EDGE, WCDMA, CDMA, and LTE link data modulation and link up with simulator. Set the EUT to transmit under low, middle and high channel and record the power level shown on simulator.

4.1.3 Test Setup

EIRP / ERP Measurement:

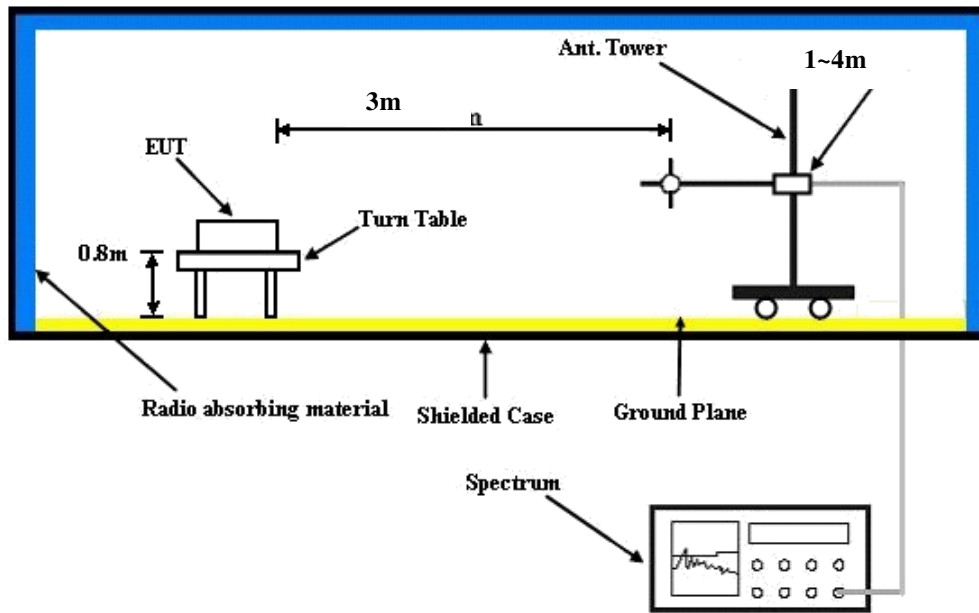

For the actual test configuration, please refer to the attached file (Test Setup Photo).

Conducted Power Measurement:

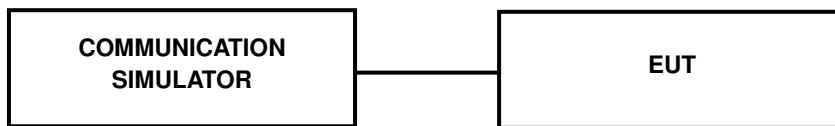

4.1.4 Test Results

Conducted Output Power (dBm)

Band	CDMA		
	1013	384	777
Channel	1013	384	777
Frequency (MHz)	824.70	836.52	848.31
RC1+SO55	23.84	23.85	23.71
RC3+SO55	23.91	23.91	23.79
RC3+SO32(+ F-SCH)	23.81	23.84	23.67
RC3+SO32(+SCH)	23.83	23.84	23.69
RC1+SO3, 1/8 Rate	23.79	23.81	23.66

ERP Power (dBm)

CDMA							
Plane	Channel	Frequency (MHz)	LVL (dBm)	Correction Factor (dB)	ERP (dBm)	ERP (mW)	Polarization (H/V)
X	1013	824.7	-11.02	32.62	19.45	88.10	H
	384	836.52	-11.32	32.52	19.05	80.35	
	777	848.31	-11.26	32.65	19.24	83.95	
	1013	824.7	-19.65	32.76	10.96	12.47	V
	384	836.52	-19.87	32.39	10.37	10.89	
	777	848.31	-19.77	32.54	10.62	11.53	

4.2 Frequency Stability Measurement

4.2.1 Limits of Frequency Stability Measurement

1.5 ppm is for base and fixed station. 2.5 ppm is for mobile station.

4.2.2 Test Procedure

- a. Device is placed at the oven room. The oven room could control the temperatures and humidity. Power warm up is at least 15 min and power applied should perform before recording frequency error.
- b. EUT is connected the external power supply to control the DC input power. The test voltage range is from minimum to maximum working voltage. Each step shall be record the frequency error rate.
- c. The temperature range step is 10 degrees in this test items. All temperature levels shall be hold the ± 0.5 °C during the measurement testing. The each temperature step shall be at least 0.5 hours, consider the EUT could be test under the stability condition.

NOTE: The frequency error was recorded frequency error from the communication simulator.

4.2.3 Test Setup

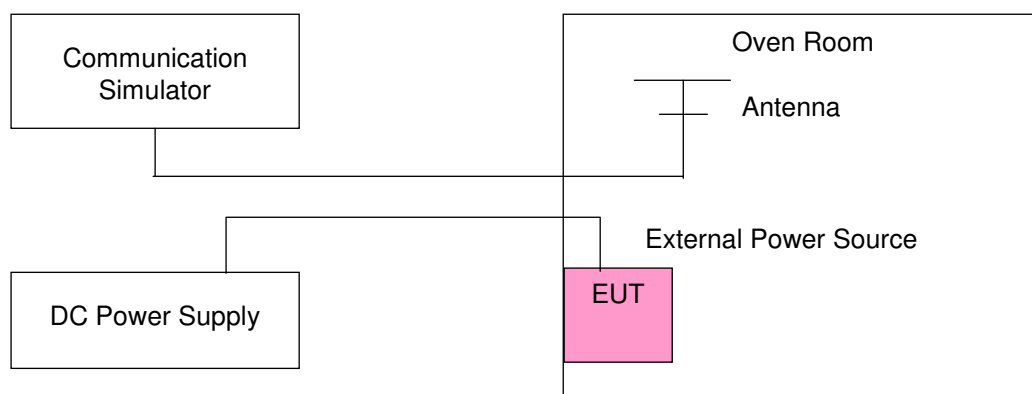

4.2.4 Test Results

Frequency Error vs. Voltage

Voltage (Volts)	Frequency Error (ppm)	Limit (ppm)
	CDMA	
12	0.003	2.5
6	0.001	2.5
30	0.000	2.5

NOTE: The applicant defined the normal working voltage of the battery is from 6 Vdc to 30 Vdc.

Frequency Error vs. Temperature

Temp. (°C)	Frequency Error (ppm)	Limit (ppm)
	CDMA	
-30	0.001	2.5
-20	0.003	2.5
-10	0.003	2.5
0	0.003	2.5
10	0.004	2.5
20	-0.003	2.5
30	-0.003	2.5
40	-0.003	2.5
50	-0.003	2.5
60	-0.002	2.5

Note:

1. The applicant declared that the normal operating temperature of the EUT is from -20°C to 60°C.
2. The EUT would shut down automatically as below -20°C.

4.3 Occupied Bandwidth Measurement

4.3.1 Test Procedure

The EUT makes a call to the communication simulator. All measurements were done at low, middle and high operational frequency range. The communication simulator station system controlled a EUT to export maximum output power under transmission mode and specific channel frequency. Use OBW measurement function of Spectrum analyzer to measure 99 % occupied bandwidth.

4.3.2 Test Setup

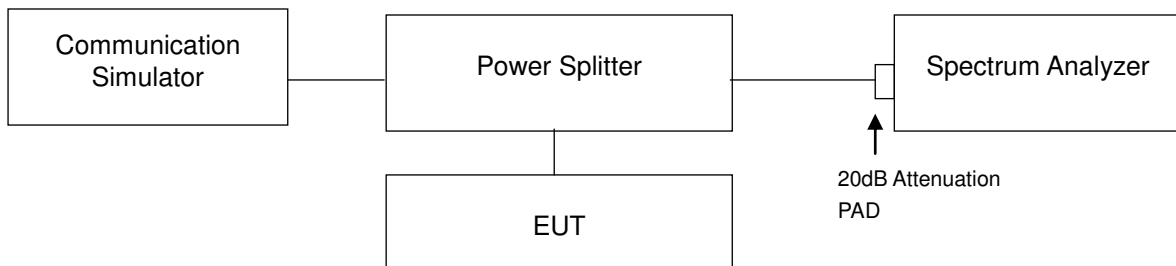

4.3.3 Test Result

Channel	Frequency (MHz)	99 % Occupied Bandwidth (kHz)
		CDMA
1013	824.70	1.2704
384	836.52	1.2710
777	848.31	1.2688

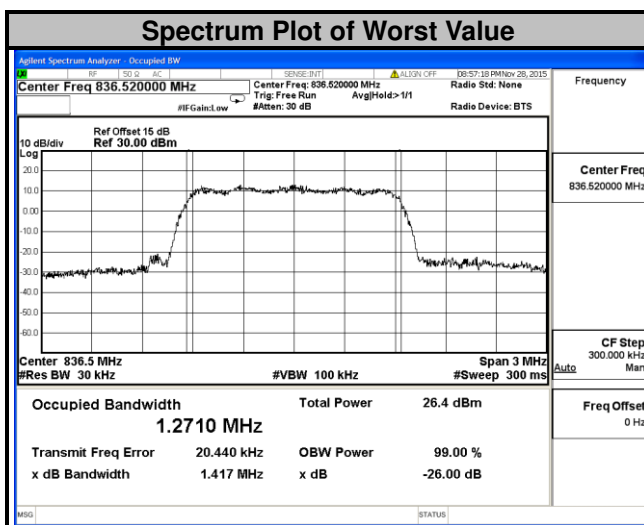

Band Edge Measurement

4.3.4 Limits of Band Edge Measurement

Power of any emission outside of the authorized operating frequency ranges must be attenuated below the transmitting power (P) by a factor of at least $43 + 10 \log(P)$ dB. In the 1 MHz bands immediately outside and adjacent to the frequency block a resolution bandwidth of at least one percent of the emission bandwidth of the fundamental emission of the transmitter may be employed.

4.3.5 Test Setup

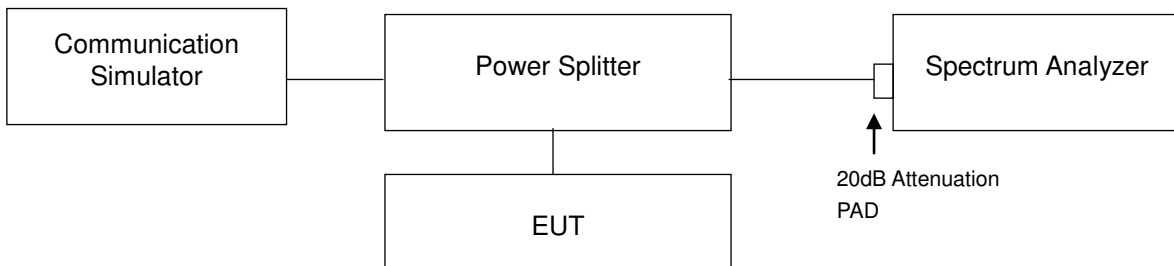

4.3.6 Test Procedures

- All measurements were done at low and high operational frequency range.
- The center frequency of spectrum is the band edge frequency and span is 1 MHz. RB of the spectrum is 13 kHz and VB of the spectrum is 51 kHz (CDMA).
- Record the max trace plot into the test report.

4.3.7 Test Results

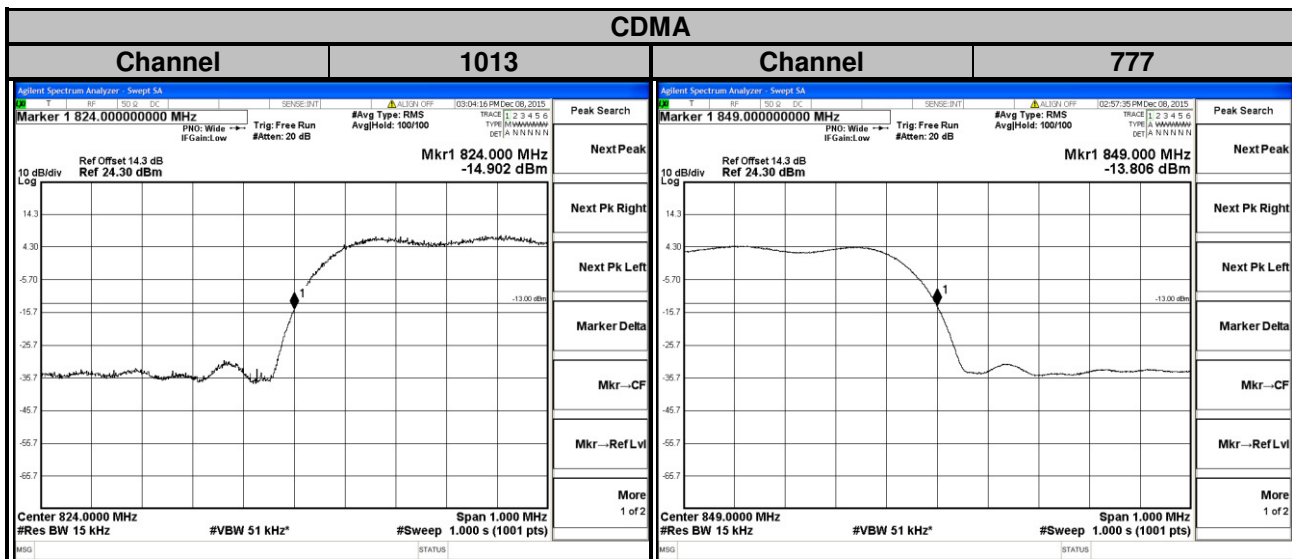

4.4 Peak to Average Ratio

4.4.1 Limits of Peak to Average Ratio Measurement

In measuring transmissions in this band using an average power technique, the peak to-average ratio (PAR) of the transmission may not exceed 13 dB.

4.4.2 Test Setup

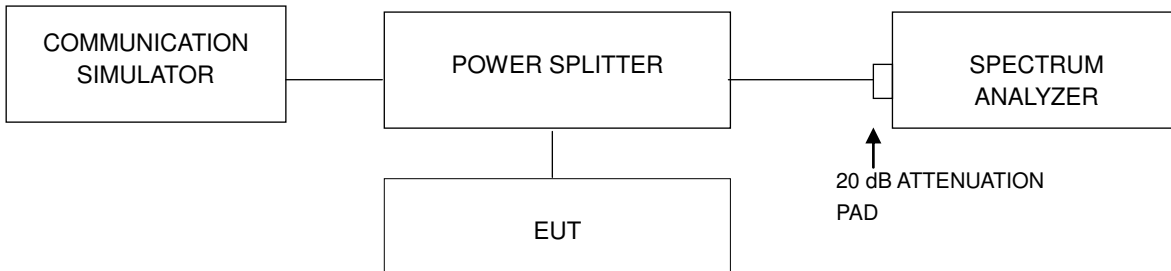

4.4.3 Test Procedures

1. Set resolution/measurement bandwidth \geq signal's occupied bandwidth;
2. Set the number of counts to a value that stabilizes the measured CCDF curve;
3. Record the maximum PAPR level associated with a probability of 0.1 %.

4.4.4 Test Results

Channel	Frequency (MHz)	Peak to Average Ratio (dB)
		CDMA
1013	824.70	4.00
384	836.52	4.17
777	848.31	3.96

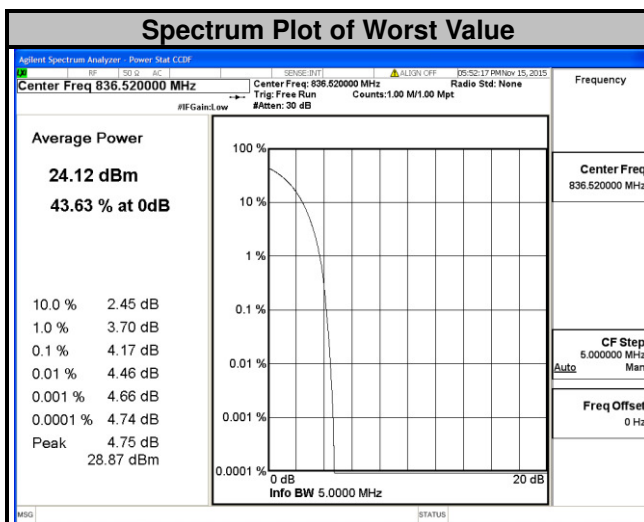

4.5 Conducted Spurious Emissions

4.5.1 Limits of Conducted Spurious Emissions Measurement

The power of any emission outside of the authorized operating frequency ranges must be attenuated below the transmitting power (P) by a factor of at least $43 + 10 \log(P)$ dB. The emission limit equal to -13 dBm.

4.5.2 Test Setup

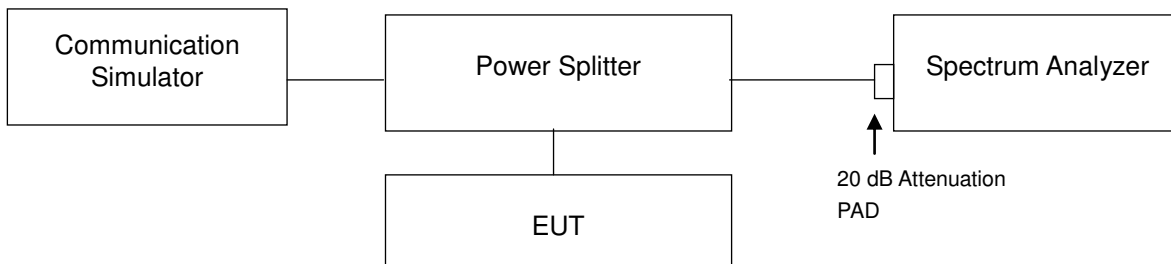

4.5.3 Test Procedure

- The EUT makes a phone call to the communication simulator. All measurements were done at low, middle and high operational frequency range.
- Measuring frequency range is from 9 kHz to 9 GHz. 20 dB attenuation pad is connected with spectrum. RBW=1 MHz and VBW=3 MHz is used for conducted emission measurement.

4.5.4 Test Results

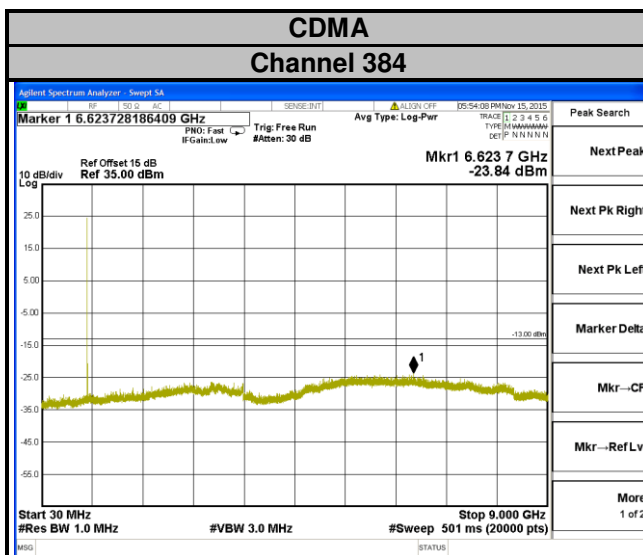

4.6 Radiated Emission Measurement

4.6.1 Limits of Radiated Emission Measurement

The power of any emission outside of the authorized operating frequency ranges must be attenuated below the transmitting power (P) by a factor of at least $43 + 10 \log(P)$ dB. The emission limit is equal to -13 dBm.

4.6.2 Test Procedure

- Substitution method is used for E.I.R.P measurement. In the semi-anechoic chamber, EUT placed on the 0.8 m height of Turn Table, rotated the table around 360 degrees to search the maximum radiation power and receiver antenna shall be rotated vertical and horizontal polarization and moved height from 1m to 4m to find the maximum polar radiated power. The “Read Value” is the spectrum reading the maximum power value.
- The substitution horn antenna is substituted for EUT at the same position and signals generator export the CW signal to the substitution antenna via a TX cable. Rotated the Turn Table and moved receiving antenna to find the maximum radiation power. Adjust output power level of S.G to get a Value of spectrum reading equal to “Read Value” of step a. Record the power level of S.G
- $EIRP = \text{Output power level of S.G} - \text{TX cable loss} + \text{Antenna gain of substitution horn.}$
- E.R.P power can be calculated form E.I.R.P power by subtracting the gain of dipole, $E.R.P \text{ power} = E.I.P.R \text{ power} - 2.15 \text{ dBi.}$

NOTE: The resolution bandwidth and video bandwidth of test receiver/spectrum analyzer is 1 MHz/3 MHz.

4.6.3 Deviation from Test Standard

No deviation.

4.6.4 Test Setup

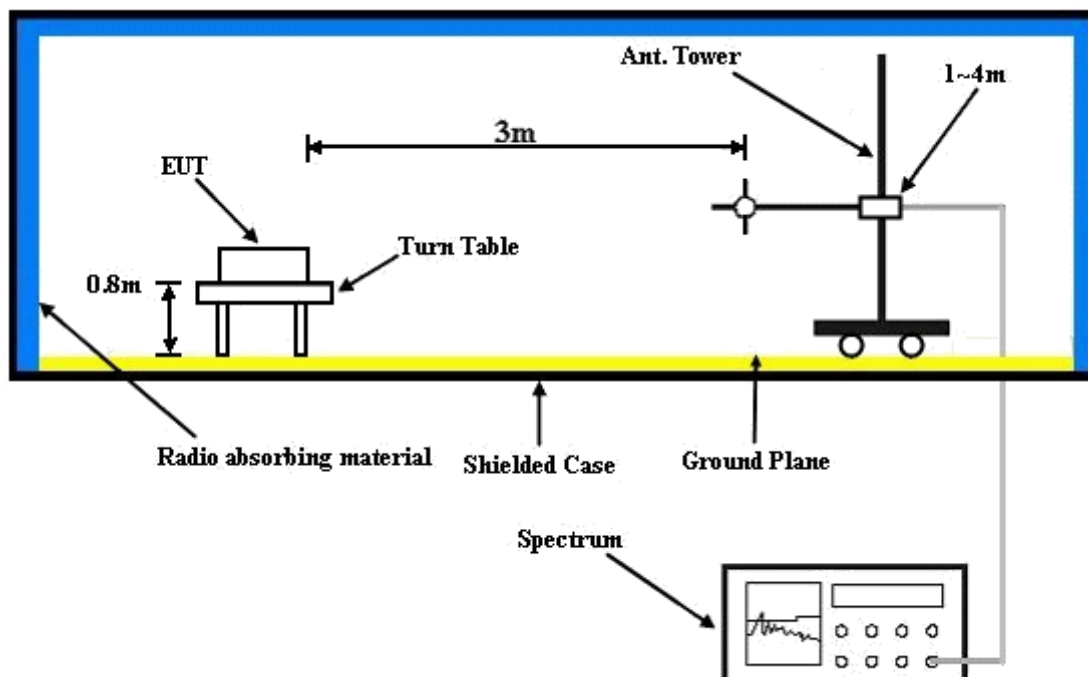

For the actual test configuration, please refer to the attached file (Test Setup Photo).

4.6.5 Test Results

CDMA:



Bureau Veritas Consumer Products Services Ltd., Taoyuan Branch

A D T

Data: 7

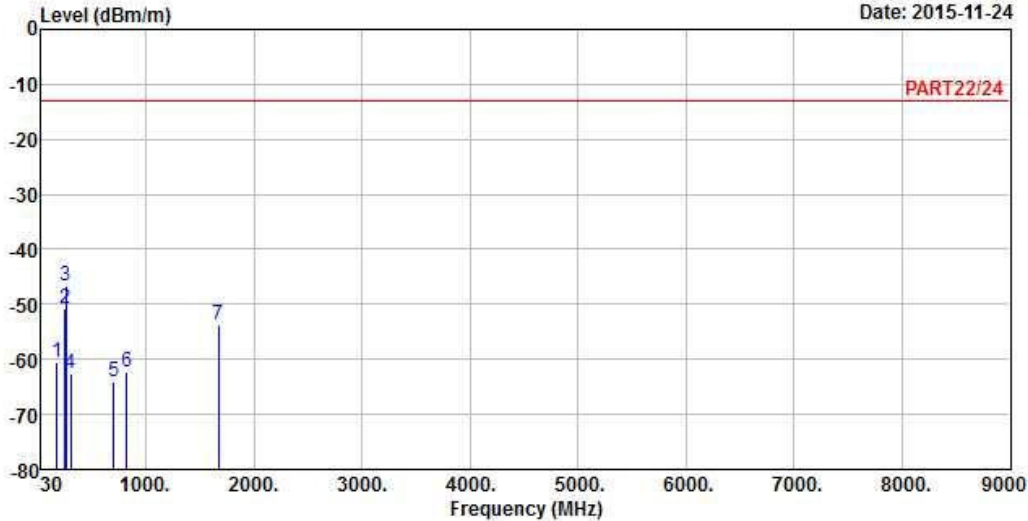

Site : 966 Chamber 5
 Condition: PART22/24 3m HORIZONTAL
 Remark : CDMA BC0
 Tested by: Gavin Wu
 Plane : X

	Freq	Level	Read Level	Limit Line	Over Limit	Factor	Remark
	MHz	dBm/m	dBm	dBm/m	dB	dB/m	
1	174.45	-60.43	-54.05	-13.00	-47.43	-6.38	Peak
2	247.62	-50.70	-44.59	-13.00	-37.70	-6.11	Peak
3 pp	258.69	-46.66	-40.49	-13.00	-33.66	-6.17	Peak
4	300.70	-62.54	-55.54	-13.00	-49.54	-7.00	Peak
5	704.60	-64.12	-64.10	-13.00	-51.12	-0.02	Peak
6	825.00	-62.33	-62.84	-13.00	-49.33	0.51	Peak
7	1673.04	-53.73	-39.05	-13.00	-40.73	-14.68	Peak



Bureau Veritas Consumer Products Services Ltd., Taoyuan Branch

A D T

Data: 8

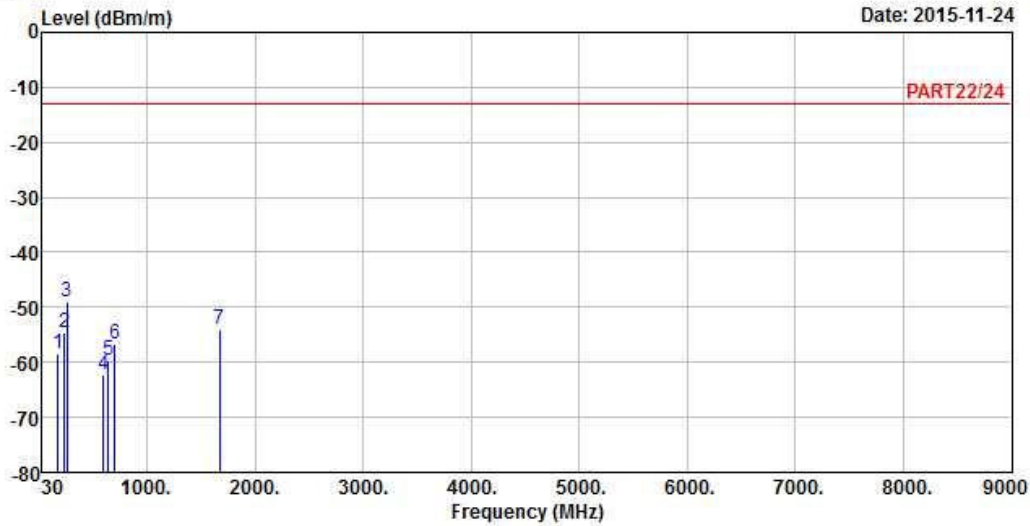

Site : 966 Chamber 5
 Condition: PART22/24 3m VERTICAL
 Remark : CDMA BC0
 Tested by: Gavin Wu
 Plane : X

	Freq	Level	Read Level	Limit Line	Over Limit	Factor	Remark
	MHz	dBm/m	dBm	dBm/m	dB	dB/m	
1	176.88	-58.48	-51.76	-13.00	-45.48	-6.72	Peak
2	232.77	-54.67	-47.97	-13.00	-41.67	-6.70	Peak
3 pp	261.12	-48.95	-42.74	-13.00	-35.95	-6.21	Peak
4	598.90	-62.32	-61.49	-13.00	-49.32	-0.83	Peak
5	643.00	-59.56	-58.69	-13.00	-46.56	-0.87	Peak
6	700.40	-56.82	-56.72	-13.00	-43.82	-0.10	Peak
7	1673.04	-54.00	-39.32	-13.00	-41.00	-14.68	Peak



5 Pictures of Test Arrangements

Please refer to the attached file (Test Setup Photo).



A D T

Appendix – Information on the Testing Laboratories

We, Bureau Veritas Consumer Products Services (H.K.) Ltd., Taoyuan Branch, were founded in 1988 to provide our best service in EMC, Radio, Telecom and Safety consultation. Our laboratories are accredited and approved according to ISO/IEC 17025.

If you have any comments, please feel free to contact us at the following:

Linko EMC/RF Lab

Tel: 886-2-26052180

Fax: 886-2-26051924

Hsin Chu EMC/RF Lab/Telecom Lab

Tel: 886-3-5935343

Fax: 886-3-5935342

Hwa Ya EMC/RF/Safety

Tel: 886-3-3183232

Fax: 886-3-3270892

Email: service.adt@tw.bureauveritas.com

Web Site: www.bureauveritas-adt.com

The address and road map of all our labs can be found in our web site also.

--- END ---