

**ELECTROMAGNETIC EMISSIONS  
COMPLIANCE REPORT**

**Applicant:** ATrack Technology Inc.  
8F., No. 13, Ln. 120, Sec. 1, Neihu Rd., Neihu Dist., Taipei City  
11493, Taiwan (R.O.C.)

**Manufacturer:** ATrack Technology Inc.  
8F., No. 13, Ln. 120, Sec. 1, Neihu Rd., Neihu Dist., Taipei City  
11493, Taiwan (R.O.C.)

**Product Name:** Solar-powered Asset Tracker

**Brand Name:** ATrack Technology Inc.

**Model No.:** AS700

**Model Difference:** N/A

**Report Number:** TERF2405001487E2

**FCC ID** YA7-AS700

**Date of EUT Received:** May 22, 2024

**Date of Test:** May 23, 2024~June 14, 2024

**Issue Date:** June 26, 2024

Approved By \_\_\_\_\_

Jay Lin

**We hereby certify that:**

The above equipment was tested by SGS Taiwan Ltd. Central RF Lab The test data, data evaluation, test procedures, and equipment configurations shown in this report were made in accordance with the procedures given in ANSI C63.10:2013 and the energy emitted by the sample EUT comply with FCC rule part §15.247.

The results of this report relate only to the sample identified in this report.

Unless otherwise stated the results shown in this test report refer only to the sample(s) tested and such sample(s) are retained for 90 days only.  
除非另有說明，此報告結果僅對測試之樣品負責，同時此樣品僅保留90天。本報告未經本公司書面許可，不可部份複製。

This document is issued by the Company subject to its General Conditions of Service printed overleaf, available on request or accessible at <http://www.sgs.com.tw/Terms-and-Conditions> and for electronic format documents, subject to Terms and Conditions for Electronic Documents at <http://www.sgs.com.tw/Terms-and-Conditions>. Attention is drawn to the limitation of liability, indemnification and jurisdiction issues defined therein. Any holder of this document is advised that information contained hereon reflects the Company's findings at the time of its intervention only and within the limits of Client's instructions, if any. The Company's sole responsibility is to its Client and this document does not exonerate parties to a transaction from exercising all their rights and obligations under the transaction documents. This document cannot be reproduced except in full, without prior written approval of the Company. Any unauthorized alteration, forgery or falsification of the content or appearance of this document is unlawful and offenders may be prosecuted to the fullest extent of the law.

## Revision History

| Report Number    | Revision | Description | Issue Date    | Revised By | Remark |
|------------------|----------|-------------|---------------|------------|--------|
| TERF2405001487E2 | 00       | Original.   | June 26, 2024 | Susan Lin  |        |
|                  |          |             |               |            |        |
|                  |          |             |               |            |        |
|                  |          |             |               |            |        |
|                  |          |             |               |            |        |
|                  |          |             |               |            |        |
|                  |          |             |               |            |        |

**Note:**

- The remark "\*" indicates modification of the report upon requests from certification body.

Unless otherwise stated the results shown in this test report refer only to the sample(s) tested and such sample(s) are retained for 90 days only.

除非另有說明，此報告結果僅對測試之樣品負責，同時此樣品僅保留90天。本報告未經本公司書面許可，不可部份複製。

This document is issued by the Company subject to its General Conditions of Service printed overleaf, available on request or accessible at <http://www.sgs.com.tw/Terms-and-Conditions> and for electronic format documents, subject to Terms and Conditions for Electronic Documents at <http://www.sgs.com.tw/Terms-and-Conditions>. Attention is drawn to the limitation of liability, indemnification and jurisdiction issues defined therein. Any holder of this document is advised that information contained hereon reflects the Company's findings at the time of its intervention only and within the limits of Client's instructions, if any. The Company's sole responsibility is to its Client and this document does not exonerate parties to a transaction from exercising all their rights and obligations under the transaction documents. This document cannot be reproduced except in full, without prior written approval of the Company. Any unauthorized alteration, forgery or falsification of the content or appearance of this document is unlawful and offenders may be prosecuted to the fullest extent of the law.

SGS Taiwan Ltd.

No.134,Wu Kung Road, New Taipei Industrial Park, Wuku District, New Taipei City, Taiwan/新北市五股區新北產業園區五工路 134 號

台灣檢驗科技股份有限公司

t (886-2) 2299-3279

f (886-2) 2298-0488

[www.sgs.com.tw](http://www.sgs.com.tw)

Member of SGS Group

## Table of Contents

|    |  |    |
|----|--|----|
| 1  | GENERAL INFORMATION .....                                    | 4  |
| 2  | SYSTEM TEST CONFIGURATION.....                               | 7  |
| 3  | SUMMARY OF TEST RESULTS.....                                 | 10 |
| 4  | DESCRIPTION OF TEST MODES.....                               | 11 |
| 5  | MEASUREMENT UNCERTAINTY .....                                | 12 |
| 6  | MEASUREMENT EQUIPMENT USED .....                             | 13 |
| 7  | CONDUCTED EMISSION TEST .....                                | 15 |
| 8  | PEAK OUTPUT POWER MEASUREMENT .....                          | 19 |
| 9  | EMISSION BANDWIDTH MEASUREMENT .....                         | 23 |
| 10 | CONDUCTED BAND EDGES AND SPURIOUS EMISSION MEASUREMENT ..... | 25 |
| 11 | RADIATED BANDEDGE AND SPURIOUS EMISSION MEASUREMENT.....     | 29 |
| 12 | POWER SPECTRAL DENSITY .....                                 | 45 |
| 13 | ANTENNA REQUIREMENT.....                                     | 47 |

Unless otherwise stated the results shown in this test report refer only to the sample(s) tested and such sample(s) are retained for 90 days only.

除非另有說明，此報告結果僅對測試之樣品負責，同時此樣品僅保留90天。本報告未經本公司書面許可，不可部份複製。

This document is issued by the Company subject to its General Conditions of Service printed overleaf, available on request or accessible at <http://www.sgs.com.tw/Terms-and-Conditions> and for electronic format documents, subject to Terms and Conditions for Electronic Documents at <http://www.sgs.com.tw/Terms-and-Conditions>. Attention is drawn to the limitation of liability, indemnification and jurisdiction issues defined therein. Any holder of this document is advised that information contained hereon reflects the Company's findings at the time of its intervention only and within the limits of Client's instructions, if any. The Company's sole responsibility is to its Client and this document does not exonerate parties to a transaction from exercising all their rights and obligations under the transaction documents. This document cannot be reproduced except in full, without prior written approval of the Company. Any unauthorized alteration, forgery or falsification of the content or appearance of this document is unlawful and offenders may be prosecuted to the fullest extent of the law.

SGS Taiwan Ltd.

No.134,Wu Kung Road, New Taipei Industrial Park, Wuku District, New Taipei City, Taiwan/新北市五股區新北產業園區五工路 134 號

台灣檢驗科技股份有限公司

t (886-2) 2299-3279

f (886-2) 2298-0488

[www.sgs.com.tw](http://www.sgs.com.tw)

Member of SGS Group

## 1 GENERAL INFORMATION

### 1.1 Product Description

|                               |   |
|-------------------------------|---|
| Product Name:                 | Solar-powered Asset Tracker             |
| Brand Name:                   | ATrack Technology Inc.                  |
| Model No.:                    | AS700                                   |
| Model Difference:             | N/A                                     |
| Hardware Version:             | N/A                                     |
| Firmware Version:             | N/A                                     |
| EUT Series No.:               | 397-0240400044                          |
| Power Supply:                 | 3.7Vdc from Rechargeable Li-ion Battery |
| Test Software (Name/Version): | EspRFTestTool V3.6                      |

### 1.2 RF Specification

|                   |                  |
|-------------------|------------------|
| Radio Technology: | BLE              |
| Frequency Range:  | 2402 – 2480MHz   |
| Channel number:   | 40 channels      |
| Modulation type:  | GFSK             |
| Transmit Power:   | BLE 1M: 8.74 dBm |

### 1.3 Antenna Designation

| Antenna Type | Freq. (MHz) | Peak Antenna Gain (dBi) |
|--------------|-------------|-------------------------|
| PCB          | 2402~2480   | 1.56                    |

**Note:** Antenna information is provided by the applicant.

Unless otherwise stated the results shown in this test report refer only to the sample(s) tested and such sample(s) are retained for 90 days only.  
 除非另有說明，此報告結果僅對測試之樣品負責，同時此樣品僅保留90天。本報告未經本公司書面許可，不可部份複製。

This document is issued by the Company subject to its General Conditions of Service printed overleaf, available on request or accessible at <http://www.sgs.com.tw/Terms-and-Conditions> and for electronic format documents, subject to Terms and Conditions for Electronic Documents at <http://www.sgs.com.tw/Terms-and-Conditions>. Attention is drawn to the limitation of liability, indemnification and jurisdiction issues defined therein. Any holder of this document is advised that information contained hereon reflects the Company's findings at the time of its intervention only and within the limits of Client's instructions, if any. The Company's sole responsibility is to its Client and this document does not exonerate parties to a transaction from exercising all their rights and obligations under the transaction documents. This document cannot be reproduced except in full, without prior written approval of the Company. Any unauthorized alteration, forgery or falsification of the content or appearance of this document is unlawful and offenders may be prosecuted to the fullest extent of the law.

### 1.4 Test Methodology of Applied Standards

FCC Part 15, Subpart C §15.247  
 FCC KDB 558074 D01 15.247 Meas Guidance v05r02  
 ANSI C63.10:2013

### 1.5 Test Facility

| Laboratory  | Test Site Address   | Test Site Name | FCC Designation number | IC CAB identifier |
|---|---|----------------|------------------------|-------------------|
| SGS Taiwan Ltd.<br>Central RF Lab.<br>(TAF code 3702) | No.134, Wu Kung Road, New Taipei Industrial Park, Wuku District, New Taipei City, Taiwan. | SAC 1          | TW0027                 | TW3702            |
|   |   | SAC 2          |                        |                   |
|   |   | SAC 3          |                        |                   |
|   |   | Conduction 1   |                        |                   |
|   |   | Conducted 1    |                        |                   |
|   |   | Conducted 2    |                        |                   |
|   |   | Conducted 3    |                        |                   |
|   |   | Conducted 4    |                        |                   |
|   |   | Conducted 5    |                        |                   |
|   |   | Conducted 6    |                        |                   |
|   | No.2, Keji 1st Rd., Guishan District, Taoyuan City, Taiwan 333                            | Conduction C   | TW0028                 |                   |
|   |   | SAC C          |                        |                   |
|   |   | SAC D          |                        |                   |
|   |   | SAC G          |                        |                   |
|   |   | Conducted A    |                        |                   |
|   |   | Conducted B    |                        |                   |
|   |   | Conducted C    |                        |                   |
|   |   | Conducted D    |                        |                   |
|   |   | Conducted E    |                        |                   |
| Conducted F   |   |                |                        |                   |
| Conducted G   |   |                |                        |                   |

**Note:** Test site name is remarked on the equipment list in each section of this report as an indication where measurements occurred in specific test site and address.

### 1.6 Special Accessories

There are no special accessories used while test was conducted.

Unless otherwise stated the results shown in this test report refer only to the sample(s) tested and such sample(s) are retained for 90 days only.  
 除非另有說明，此報告結果僅對測試之樣品負責，同時此樣品僅保留90天。本報告未經本公司書面許可，不可部份複製。

This document is issued by the Company subject to its General Conditions of Service printed overleaf, available on request or accessible at <http://www.sgs.com.tw/Terms-and-Conditions> and for electronic format documents, subject to Terms and Conditions for Electronic Documents at <http://www.sgs.com.tw/Terms-and-Conditions>. Attention is drawn to the limitation of liability, indemnification and jurisdiction issues defined therein. Any holder of this document is advised that information contained hereon reflects the Company's findings at the time of its intervention only and within the limits of Client's instructions, if any. The Company's sole responsibility is to its Client and this document does not exonerate parties to a transaction from exercising all their rights and obligations under the transaction documents. This document cannot be reproduced except in full, without prior written approval of the Company. Any unauthorized alteration, forgery or falsification of the content or appearance of this document is unlawful and offenders may be prosecuted to the fullest extent of the law.



## 1.7 Equipment Modifications

There was no modification incorporated into the EUT.

Unless otherwise stated the results shown in this test report refer only to the sample(s) tested and such sample(s) are retained for 90 days only.  
除非另有說明，此報告結果僅對測試之樣品負責，同時此樣品僅保留90天。本報告未經本公司書面許可，不可部份複製。

This document is issued by the Company subject to its General Conditions of Service printed overleaf, available on request or accessible at <http://www.sgs.com.tw/Terms-and-Conditions> and for electronic format documents, subject to Terms and Conditions for Electronic Documents at <http://www.sgs.com.tw/Terms-and-Conditions>. Attention is drawn to the limitation of liability, indemnification and jurisdiction issues defined therein. Any holder of this document is advised that information contained hereon reflects the Company's findings at the time of its intervention only and within the limits of Client's instructions, if any. The Company's sole responsibility is to its Client and this document does not exonerate parties to a transaction from exercising all their rights and obligations under the transaction documents. This document cannot be reproduced except in full, without prior written approval of the Company. Any unauthorized alteration, forgery or falsification of the content or appearance of this document is unlawful and offenders may be prosecuted to the fullest extent of the law.

## 2 SYSTEM TEST CONFIGURATION

### 2.1 EUT Configuration

The EUT configuration for testing is installed on RF field strength measurement to meet the Commissions requirement and operating in a manner which intends to maximize its emission characteristics in a continuous normal application.

### 2.2 EUT Exercise

An engineering test mode (software/firmware) that applicant provided was utilized to manipulate the EUT into transmit, selection of the test channel, and modulation scheme.

### 2.3 Test Procedure

#### 2.3.1 Conducted Emissions

The EUT is placed on a table which is 0.8 m above ground plane. Conducted emissions from the EUT measured in the frequency range between 0.15 MHz and 30MHz. The CISPR Quasi-Peak and Average detector mode is employed. The two LISNs provide 50uH/50 ohm of coupling impedance for the measuring instrument. Both lines of the power mains connected to the EUT were checked for maximum conducted interference.

#### 2.3.2 Conducted Test (RF)

The active antenna port of the unlicensed wireless device is connected to the spectrum analyzer with attenuator to protect the instrumentation. If a second antenna port is available, it is tested at one operating frequency, with other port(s) appropriately terminated, to verify it has similar output characteristics as the fully tested port.

#### 2.3.3 Radiated Emissions

The EUT is placed on a turn table. For emissions testing at or below 1 GHz, the table height shall be 0.8 m above the reference ground plane. For emission measurements above 1 GHz, the table height shall be 1.5 m. The turn table shall rotate 360 degrees to determine the position of maximum emission level. EUT is set 3m away from the receiving antenna which varied from 1m to 4m to find out the highest emission. And also, each emission was to be maximized by changing the polarization of receiving antenna both horizontal and vertical. In order to find out the max. emission, the relative positions of this transmitter (EUT) was rotated through three orthogonal axes and measurement procedures for electric field radiated emissions above 1 GHz the EUT measurement is to be made "while keeping the antenna in the 'cone of radiation' from that area and pointed at the area both in azimuth and elevation, with polarization oriented for maximum response." is still within the 3dB illumination BW of the measurement antenna.

Unless otherwise stated the results shown in this test report refer only to the sample(s) tested and such sample(s) are retained for 90 days only.  
除非另有說明，此報告結果僅對測試之樣品負責，同時此樣品僅保留90天。本報告未經本公司書面許可，不可部份複製。

This document is issued by the Company subject to its General Conditions of Service printed overleaf, available on request or accessible at <http://www.sgs.com.tw/Terms-and-Conditions> and for electronic format documents, subject to Terms and Conditions for Electronic Documents at <http://www.sgs.com.tw/Terms-and-Conditions>. Attention is drawn to the limitation of liability, indemnification and jurisdiction issues defined therein. Any holder of this document is advised that information contained hereon reflects the Company's findings at the time of its intervention only and within the limits of Client's instructions, if any. The Company's sole responsibility is to its Client and this document does not exonerate parties to a transaction from exercising all their rights and obligations under the transaction documents. This document cannot be reproduced except in full, without prior written approval of the Company. Any unauthorized alteration, forgery or falsification of the content or appearance of this document is unlawful and offenders may be prosecuted to the fullest extent of the law.

## 2.4 Measurement Results Explanation Example

### 2.4.1 Radiated Emission Test Sites For Measurements From 9 kHz To 30 MHz

Radiated emission below 30MHz is measured in a 9m\*6m\*6m semi-anechoic chamber, the measurements correspond to those obtained at an open-field test site.

There is a comparison data of both open-field test site and semi-Anechoic chamber, and the result came out very similar.

### 2.4.2 For all conducted test items:

The offset level is set in the spectrum analyzer to compensate the RF cable loss and attenuation factor between EUT conducted port and spectrum analyzer. With the offset compensation, the spectrum analyzer reading level is exactly EUT RF output level.

Unless otherwise stated the results shown in this test report refer only to the sample(s) tested and such sample(s) are retained for 90 days only.  
除非另有說明，此報告結果僅對測試之樣品負責，同時此樣品僅保留90天。本報告未經本公司書面許可，不可部份複製。

This document is issued by the Company subject to its General Conditions of Service printed overleaf, available on request or accessible at <http://www.sgs.com.tw/Terms-and-Conditions> and for electronic format documents, subject to Terms and Conditions for Electronic Documents at <http://www.sgs.com.tw/Terms-and-Conditions>. Attention is drawn to the limitation of liability, indemnification and jurisdiction issues defined therein. Any holder of this document is advised that information contained hereon reflects the Company's findings at the time of its intervention only and within the limits of Client's instructions, if any. The Company's sole responsibility is to its Client and this document does not exonerate parties to a transaction from exercising all their rights and obligations under the transaction documents. This document cannot be reproduced except in full, without prior written approval of the Company. Any unauthorized alteration, forgery or falsification of the content or appearance of this document is unlawful and offenders may be prosecuted to the fullest extent of the law.



## 2.5 Test Configuration

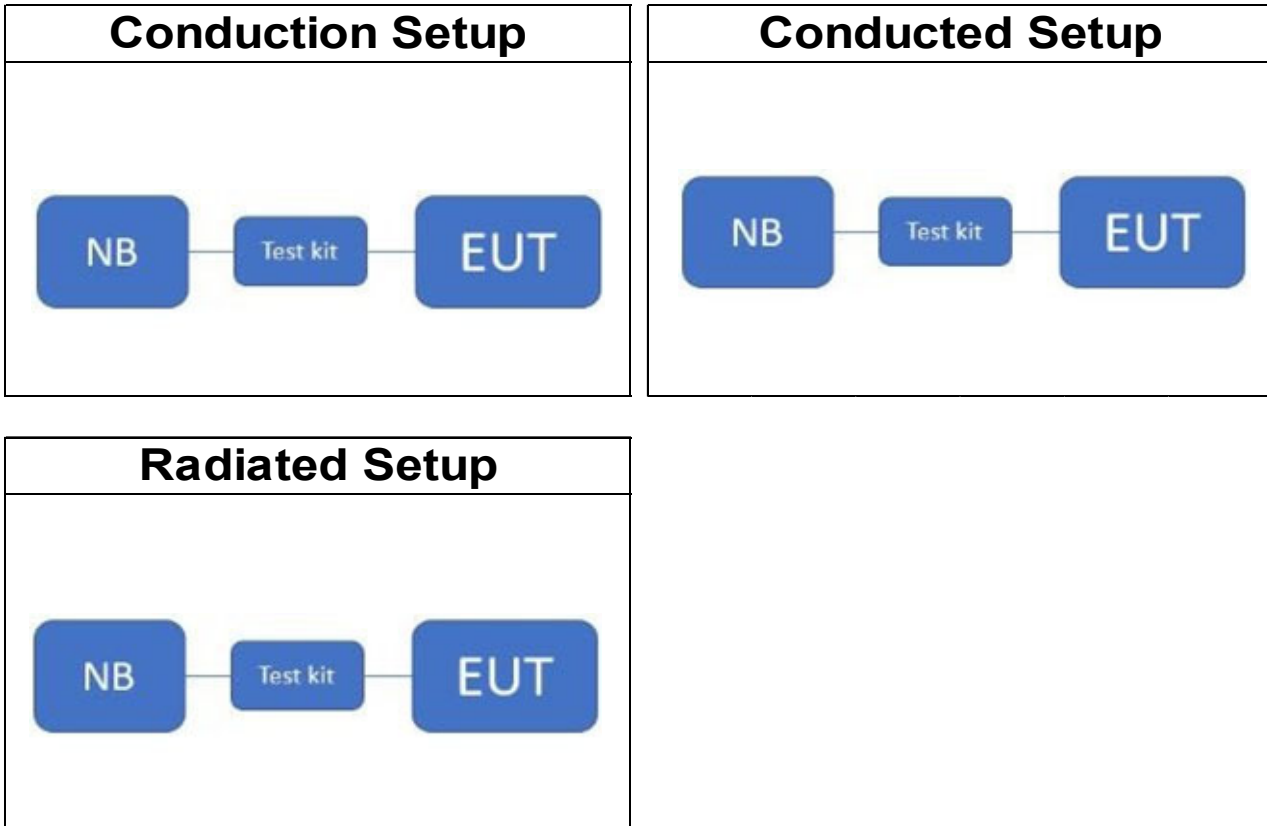

## 2.6 Control Unit(s)

| AC Power-Line Conducted Emission Test Site: Conduction C |        |              |               |           |          |
|--|--------|--------------|---------------|-----------|----------|
| EQUIPMENT TYPE   | MFR    | MODEL NUMBER | SERIAL NUMBER | LAST CAL. | CAL DUE. |
| Testkit  | FTDI   | FT232RL      | N/A           | N/A       | N/A      |
| Notebook   | Lenovo | L480         | P0002332      | N/A       | N/A      |

| Conducted Emission Test Site: Conducted C |        |              |               |           |          |
|---|--------|--------------|---------------|-----------|----------|
| EQUIPMENT TYPE                            | MFR    | MODEL NUMBER | SERIAL NUMBER | LAST CAL. | CAL DUE. |
| Test Kit                                  | FTDI   | FT232RL      | N/A           | N/A       | N/A      |
| Notebook                                  | Lenovo | T14          | P0003332      | N/A       | N/A      |

| Radiated Emission Test Site: SAC G |        |              |               |           |          |
|------------------------------------|--------|--------------|---------------|-----------|----------|
| EQUIPMENT TYPE                     | MFR    | MODEL NUMBER | SERIAL NUMBER | LAST CAL. | CAL DUE. |
| Testkit                            | FTDI   | FT232RL      | N/A           | N/A       | N/A      |
| Notebook                           | Lenovo | L480         | P0002332      | N/A       | N/A      |

Unless otherwise stated the results shown in this test report refer only to the sample(s) tested and such sample(s) are retained for 90 days only.

除非另有說明，此報告結果僅對測試之樣品負責，同時此樣品僅保留90天。本報告未經本公司書面許可，不可部份複製。  
This document is issued by the Company subject to its General Conditions of Service printed overleaf, available on request or accessible at <http://www.sgs.com.tw/Terms-and-Conditions> and for electronic format documents, subject to Terms and Conditions for Electronic Documents at <http://www.sgs.com.tw/Terms-and-Conditions>. Attention is drawn to the limitation of liability, indemnification and jurisdiction issues defined therein. Any holder of this document is advised that information contained herein reflects the Company's findings at the time of its intervention only and within the limits of Client's instructions, if any. The Company's sole responsibility is to its Client and this document does not exonerate parties to a transaction from exercising all their rights and obligations under the transaction documents. This document cannot be reproduced except in full, without prior written approval of the Company. Any unauthorized alteration, forgery or falsification of the content or appearance of this document is unlawful and offenders may be prosecuted to the fullest extent of the law.

### 3 SUMMARY OF TEST RESULTS

| FCC Rules             | Description Of Test                          | Result    |
|-----------------------|--|-----------|
| §15.207(a)            | AC Power Line Conducted Emission             | Compliant |
| §15.247(b) (3)        | Peak Output Power                            | Compliant |
| §15.247(a)(2)         | Emission Bandwidth                           | Compliant |
| §15.247(d)<br>§15.209 | Conducted Band Edge<br>and Spurious Emission | Compliant |
| §15.247(d)<br>§15.209 | Radiated Band Edge<br>and Spurious Emission  | Compliant |
| §15.205               | Restricted Bands                             | Compliant |
| §15.247(e)            | Peak Power Density                           | Compliant |
| §15.203               | Antenna Requirement                          | Compliant |

Unless otherwise stated the results shown in this test report refer only to the sample(s) tested and such sample(s) are retained for 90 days only.

除非另有說明，此報告結果僅對測試之樣品負責，同時此樣品僅保留90天。本報告未經本公司書面許可，不可部份複製。

This document is issued by the Company subject to its General Conditions of Service printed overleaf, available on request or accessible at <http://www.sgs.com.tw/Terms-and-Conditions> and for electronic format documents, subject to Terms and Conditions for Electronic Documents at <http://www.sgs.com.tw/Terms-and-Conditions>. Attention is drawn to the limitation of liability, indemnification and jurisdiction issues defined therein. Any holder of this document is advised that information contained hereon reflects the Company's findings at the time of its intervention only and within the limits of Client's instructions, if any. The Company's sole responsibility is to its Client and this document does not exonerate parties to a transaction from exercising all their rights and obligations under the transaction documents. This document cannot be reproduced except in full, without prior written approval of the Company. Any unauthorized alteration, forgery or falsification of the content or appearance of this document is unlawful and offenders may be prosecuted to the fullest extent of the law.

## 4 DESCRIPTION OF TEST MODES

### 4.1 Operating Frequencies

| 2400~2483.5 MHz |             |    |             |    |             |    |             |
|-----------------|-------------|----|-------------|----|-------------|----|-------------|
| CH              | Freq. (MHz) | CH | Freq. (MHz) | CH | Freq. (MHz) | CH | Freq. (MHz) |
| 0               | 2402        | 10 | 2422        | 20 | 2442        | 30 | 2462        |
| 1               | 2404        | 11 | 2424        | 21 | 2444        | 31 | 2464        |
| 2               | 2406        | 12 | 2426        | 22 | 2446        | 32 | 2466        |
| 3               | 2408        | 13 | 2428        | 23 | 2448        | 33 | 2468        |
| 4               | 2410        | 14 | 2430        | 24 | 2450        | 34 | 2470        |
| 5               | 2412        | 15 | 2432        | 25 | 2452        | 35 | 2472        |
| 6               | 2414        | 16 | 2434        | 26 | 2454        | 36 | 2474        |
| 7               | 2416        | 17 | 2436        | 27 | 2456        | 37 | 2476        |
| 8               | 2418        | 18 | 2438        | 28 | 2458        | 38 | 2478        |
| 9               | 2420        | 19 | 2440        | 29 | 2460        | 39 | 2480        |

### 4.2 The Worst Test Modes and Channel Details

1. The EUT has been tested under operating condition.
2. Test program used to control the EUT for staying in continuous transmitting and receiving mode is programmed.
3. The field strength of radiation emission was measured as the EUT positioned in different orthogonal planes (E1/E2/H) based on actual usage of the EUT to pre-scan the emissions for determining the worst case scenario.
4. Investigation has been done on all the possible configurations for searching the worst case.

| CONDUCTED TEST |                   |                |            |                  |
|----------------|-------------------|----------------|------------|------------------|
| MODE           | AVAILABLE CHANNEL | TESTED CHANNEL | MODULATION | DATA RATE (Mbps) |
| Bluetooth LE   | 0 to 39           | 0,20,39        | GFSK       | 1                |

| TRANSMIT RADIATED EMISSION TEST (BELOW 1 GHz) |                   |                |            |                  |
|---|-------------------|----------------|------------|------------------|
| MODE  | AVAILABLE CHANNEL | TESTED CHANNEL | MODULATION | DATA RATE (Mbps) |
| Bluetooth LE                                  | 0 to 39           | 20             | GFSK       | 1                |

| TRANSMIT RADIATED EMISSION TEST (ABOVE 1 GHz) |                   |                |            |                  |
|---|-------------------|----------------|------------|------------------|
| MODE  | AVAILABLE CHANNEL | TESTED CHANNEL | MODULATION | DATA RATE (Mbps) |
| Bluetooth LE                                  | 0 to 39           | 0,20,39        | GFSK       | 1                |

Unless otherwise stated the results shown in this test report refer only to the sample(s) tested and such sample(s) are retained for 90 days only.  
 除非另有說明，此報告結果僅對測試之樣品負責，同時此樣品僅保留90天。本報告未經本公司書面許可，不可部份複製。

This document is issued by the Company subject to its General Conditions of Service printed overleaf, available on request or accessible at <http://www.sgs.com.tw/Terms-and-Conditions>, and for electronic format documents, subject to Terms and Conditions for Electronic Documents at <http://www.sgs.com.tw/Terms-and-Conditions>. Attention is drawn to the limitation of liability, indemnification and jurisdiction issues defined therein. Any holder of this document is advised that information contained hereon reflects the Company's findings at the time of its intervention only and within the limits of Client's instructions, if any. The Company's sole responsibility is to its Client and this document does not exonerate parties to a transaction from exercising all their rights and obligations under the transaction documents. This document cannot be reproduced except in full, without prior written approval of the Company. Any unauthorized alteration, forgery or falsification of the content or appearance of this document is unlawful and offenders may be prosecuted to the fullest extent of the law.

## 5 MEASUREMENT UNCERTAINTY

| Test Items                       | Uncertainty |
|----------------------------------|-------------|
| AC Power Line Conducted Emission | +/- 1.54 dB |
| Output Power measurement         | +/- 0.97 dB |
| Emission Bandwidth               | +/- 1.38 Hz |
| Conducted emission measurement   | +/- 0.77 dB |
| Peak Power Density               | +/- 0.61 dB |
| Temperature                      | +/- 0.6 °C  |
| Humidity                         | +/- 3 %     |
| DC / AC Power Source             | +/- 1 %     |

| Radiated Spurious Emission Measurement Uncertainty |     |         |                 |
|--|-----|---------|-----------------|
| Polarization: Vertical                             | +/- | 1.89 dB | 9kHz~30MHz      |
|  | +/- | 4.15 dB | 30MHz - 1000MHz |
|  | +/- | 3.43 dB | 1GHz - 18GHz    |
|  | +/- | 3.86 dB | 18GHz - 40GHz   |
| Polarization: Horizontal                           | +/- | 1.89 dB | 9kHz~30MHz      |
|  | +/- | 4.02 dB | 30MHz - 1000MHz |
|  | +/- | 3.43 dB | 1GHz - 18GHz    |
|  | +/- | 3.86 dB | 18GHz - 40GHz   |
| Radiated Spurious Emission                         | +/- | 2 dB    | 33GHz-50GHz     |
|  | +/- | 1.59 dB | 50GHz-60GHz     |
|  | +/- | 1.7 dB  | 60GHz-90GHz     |
|  | +/- | 1.64 dB | 90GHz-140GHz    |
|  | +/- | 3.83 dB | 140GHz-220GHz   |

### Note:

1. This uncertainty represents an expanded uncertainty expressed at approximately the 95% confidence level using a coverage factor of k=2.
2. The conformity assessment statement in this report is based solely on the test results, measurement uncertainty is excluded.

Unless otherwise stated the results shown in this test report refer only to the sample(s) tested and such sample(s) are retained for 90 days only.  
 除非另有說明，此報告結果僅對測試之樣品負責，同時此樣品僅保留90天。本報告未經本公司書面許可，不可部份複製。

This document is issued by the Company subject to its General Conditions of Service printed overleaf, available on request or accessible at <http://www.sgs.com.tw/Terms-and-Conditions> and for electronic format documents, subject to Terms and Conditions for Electronic Documents at <http://www.sgs.com.tw/Terms-and-Conditions>. Attention is drawn to the limitation of liability, indemnification and jurisdiction issues defined therein. Any holder of this document is advised that information contained hereon reflects the Company's findings at the time of its intervention only and within the limits of Client's instructions, if any. The Company's sole responsibility is to its Client and this document does not exonerate parties to a transaction from exercising all their rights and obligations under the transaction documents. This document cannot be reproduced except in full, without prior written approval of the Company. Any unauthorized alteration, forgery or falsification of the content or appearance of this document is unlawful and offenders may be prosecuted to the fullest extent of the law.

## 6 MEASUREMENT EQUIPMENT USED

### 6.1 Emission from AC power line

| AC Power-Line Conducted Emission Test Site: Conduction C |                                |               |                           |            |            |
|--|--------------------------------|---------------|---------------------------|------------|------------|
| EQUIPMENT TYPE   | MFR                            | MODEL NUMBER  | SERIAL NUMBER             | LAST CAL.  | CAL DUE.   |
| Coaxial Cable  | EC Lab                         | RF-HY-CAB-250 | RF-HY-CAB-250-01          | 03/27/2024 | 03/26/2025 |
| EMI Test Receiver  | R&S                            | ESCI          | 101342                    | 04/29/2024 | 04/28/2025 |
| LISN   | SCHWARZBECK<br>Mess-Elektronik | NSLK8127      | 974                       | 06/19/2023 | 06/18/2024 |
| Pulse Limiter  | EC Lab                         | VTSD 9561F-N  | 485                       | 03/27/2024 | 03/26/2025 |
| Test Software  | audix                          | e3            | E3 20923 SGS Ver.9<br>(C) | N.C.R      | N.C.R      |

### 6.2 Conducted Measurement

| Conducted Emission Test Site: Conducted C |            |                        |               |            |            |
|---|------------|------------------------|---------------|------------|------------|
| EQUIPMENT TYPE                            | MFR        | MODEL NUMBER           | SERIAL NUMBER | LAST CAL.  | CAL DUE.   |
| Spectrum Analyzer                         | KEYSIGHT   | N9010B                 | MY59071573    | 05/24/2024 | 05/23/2025 |
| Power Meter                               | Anritsu    | ML2496A                | 2138005       | 09/25/2023 | 09/24/2024 |
| Power Sensor                              | Anritsu    | MA2411B                | 1911395       | 09/25/2023 | 09/24/2024 |
| Power Sensor                              | Anritsu    | MA2411B                | 1911396       | 09/25/2023 | 09/24/2024 |
| Test Software                             | SGS Taiwan | Radio Test<br>Software | Ver.21        | N.C.R      | N.C.R      |
| Attenuator                                | Woken      | WATT-218FS-10          | RF18          | 11/15/2023 | 11/14/2024 |
| Attenuator                                | Woken      | WATT-218FS-10          | RF19          | 11/15/2023 | 11/14/2024 |
| DC Block                                  | PASTERNAK  | PE8210                 | RF155         | 11/15/2023 | 11/14/2024 |

Unless otherwise stated the results shown in this test report refer only to the sample(s) tested and such sample(s) are retained for 90 days only.

除非另有說明，此報告結果僅對測試之樣品負責，同時此樣品僅保留90天。本報告未經本公司書面許可，不可部份複製。

This document is issued by the Company subject to its General Conditions of Service printed overleaf, available on request or accessible at <http://www.sgs.com.tw/Terms-and-Conditions> and for electronic format documents, subject to Terms and Conditions for Electronic Documents at <http://www.sgs.com.tw/Terms-and-Conditions>. Attention is drawn to the limitation of liability, indemnification and jurisdiction issues defined therein. Any holder of this document is advised that information contained hereon reflects the Company's findings at the time of its intervention only and within the limits of Client's instructions, if any. The Company's sole responsibility is to its Client and this document does not exonerate parties to a transaction from exercising all their rights and obligations under the transaction documents. This document cannot be reproduced except in full, without prior written approval of the Company. Any unauthorized alteration, forgery or falsification of the content or appearance of this document is unlawful and offenders may be prosecuted to the fullest extent of the law.

### 6.3 Radiated Measurement

| Radiated Emission Test Site: SAC G |                 |                                |                             |            |            |
|------------------------------------|-----------------|--------------------------------|-----------------------------|------------|------------|
| EQUIPMENT TYPE                     | MFR             | MODEL NUMBER                   | SERIAL NUMBER               | LAST CAL.  | CAL DUE.   |
| 3m Site NSA                        | SGS             | 966 chamber G                  | N/A                         | 03/30/2024 | 03/29/2025 |
| Active Loop Antenna                | COM-POWER       | AL-130R                        | 10160105                    | 12/04/2023 | 12/03/2024 |
| Broadband Antenna                  | SCHWARZBECK     | VULB 9168                      | 1208                        | 07/21/2023 | 07/20/2024 |
| Coaxial Cable                      | EMC Instruments | EMC104-SM-SM-8000-5000-5000    | 210219 、<br>210220 、 210221 | 03/13/2024 | 03/12/2025 |
| Coaxial Cable                      | EMC Instruments | EMCCFD400-NM-NM-8000-5000-2000 | 210216 、<br>210217 、 210218 | 03/13/2024 | 03/12/2025 |
| Horn Antenna                       | RF SPIN         | DRH18-E                        | 210105A18E                  | 04/12/2024 | 04/11/2025 |
| Horn Antenna                       | Schwarzbeck     | BBHA9170                       | 185                         | 08/21/2023 | 08/20/2024 |
| Pre-Amplifier                      | EMC Instruments | EMC118A45SE                    | 980815                      | 05/08/2024 | 05/07/2025 |
| Pre-Amplifier                      | EMC Instruments | EMC18405SEE                    | 980881                      | 11/15/2023 | 11/14/2024 |
| Pre-Amplifier                      | EMC Instruments | EMC330N                        | 980781                      | 03/13/2024 | 03/12/2025 |
| Spectrum Analyzer                  | KEYSIGHT        | N9010A                         | MY51440113                  | 07/17/2023 | 07/16/2024 |
| Test Software                      | audix           | e3                             | E3 20923 SGS Ver.9<br>( C ) | N.C.R      | N.C.R      |

**NOTE:** N.C.R refers to Not Calibrated Required.

Unless otherwise stated the results shown in this test report refer only to the sample(s) tested and such sample(s) are retained for 90 days only.

除非另有說明，此報告結果僅對測試之樣品負責，同時此樣品僅保留90天。本報告未經本公司書面許可，不可部份複製。  
This document is issued by the Company subject to its General Conditions of Service printed overleaf, available on request or accessible at <http://www.sgs.com.tw/Terms-and-Conditions> and for electronic format documents, subject to Terms and Conditions for Electronic Documents at <http://www.sgs.com.tw/Terms-and-Conditions>. Attention is drawn to the limitation of liability, indemnification and jurisdiction issues defined therein. Any holder of this document is advised that information contained hereon reflects the Company's findings at the time of its intervention only and within the limits of Client's instructions, if any. The Company's sole responsibility is to its Client and this document does not exonerate parties to a transaction from exercising all their rights and obligations under the transaction documents. This document cannot be reproduced except in full, without prior written approval of the Company. Any unauthorized alteration, forgery or falsification of the content or appearance of this document is unlawful and offenders may be prosecuted to the fullest extent of the law.

## 7 CONDUCTED EMISSION TEST

### 7.1 Standard Applicable:

Frequency range within 150kHz to 30MHz shall not exceed the Limit table as below.

| Frequency range<br>MHz | Limits<br>(dB $\mu$ V) |          |
|------------------------|------------------------|----------|
|                        | Quasi-peak             | Average  |
| 0.15 to 0.50           | 66 to 56               | 56 to 46 |
| 0.50 to 5              | 56                     | 46       |
| 5 to 30                | 60                     | 50       |

Note

1. The lower limit shall apply at the transition frequencies
2. The limit decreases linearly with the logarithm of the frequency in the range 0.15 MHz to 0.50 MHz.

### 7.2 EUT Setup:

1. The conducted emission tests were performed in the test site, using the setup in accordance with the ANSI C63.10:2013.
2. The AC/DC Power adaptor of EUT was plug-in LISN. The EUT was placed flushed with the rear of the table.
3. The LISN was connected with 120Vac/60Hz power source.

### 7.3 Test Setup

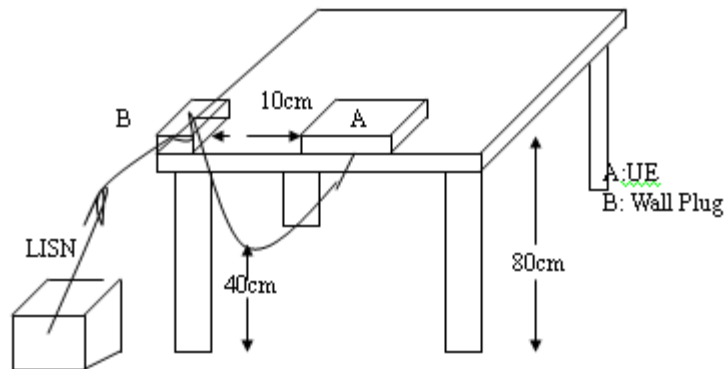

Unless otherwise stated the results shown in this test report refer only to the sample(s) tested and such sample(s) are retained for 90 days only.

除非另有說明，此報告結果僅對測試之樣品負責，同時此樣品僅保留90天。本報告未經本公司書面許可，不可部份複製。  
This document is issued by the Company subject to its General Conditions of Service printed overleaf, available on request or accessible at <http://www.sgs.com.tw/Terms-and-Conditions> and for electronic format documents, subject to Terms and Conditions for Electronic Documents at <http://www.sgs.com.tw/Terms-and-Conditions>. Attention is drawn to the limitation of liability, indemnification and jurisdiction issues defined therein. Any holder of this document is advised that information contained hereon reflects the Company's findings at the time of its intervention only and within the limits of Client's instructions, if any. The Company's sole responsibility is to its Client and this document does not exonerate parties to a transaction from exercising all their rights and obligations under the transaction documents. This document cannot be reproduced except in full, without prior written approval of the Company. Any unauthorized alteration, forgery or falsification of the content or appearance of this document is unlawful and offenders may be prosecuted to the fullest extent of the law.

#### 7.4 Measurement Procedure:

1. The EUT was placed on a table which is 0.8m above ground plane.
2. Maximum procedure was performed on the six highest emissions to ensure EUT compliance.
3. Repeat above procedures until all phases of power being supplied by given UE are completed

#### 7.5 Measurement Result:

Note: Refer to next page for measurement data and plots.

Note2: The \* reveals the worst-case results that closest to the limit.

Unless otherwise stated the results shown in this test report refer only to the sample(s) tested and such sample(s) are retained for 90 days only.  
除非另有說明，此報告結果僅對測試之樣品負責，同時此樣品僅保留90天。本報告未經本公司書面許可，不可部份複製。

This document is issued by the Company subject to its General Conditions of Service printed overleaf, available on request or accessible at <http://www.sgs.com.tw/Terms-and-Conditions> and for electronic format documents, subject to Terms and Conditions for Electronic Documents at <http://www.sgs.com.tw/Terms-and-Conditions>. Attention is drawn to the limitation of liability, indemnification and jurisdiction issues defined therein. Any holder of this document is advised that information contained hereon reflects the Company's findings at the time of its intervention only and within the limits of Client's instructions, if any. The Company's sole responsibility is to its Client and this document does not exonerate parties to a transaction from exercising all their rights and obligations under the transaction documents. This document cannot be reproduced except in full, without prior written approval of the Company. Any unauthorized alteration, forgery or falsification of the content or appearance of this document is unlawful and offenders may be prosecuted to the fullest extent of the law.



### AC POWER LINE CONDUCTED EMISSION TEST DATA

|               |                   |             |               |
|---------------|-------------------|-------------|---------------|
| Report Number | :TERF2405001487E2 | Test Site   | :Conduction C |
| Test Mode     | :BLE              | Test Date   | :2024-06-04   |
| Power         | :120V/60Hz        | Temp./Humi. | :21.6°C/60%   |
| Probe         | :L1               | Engineer    | :Jacky Chen   |

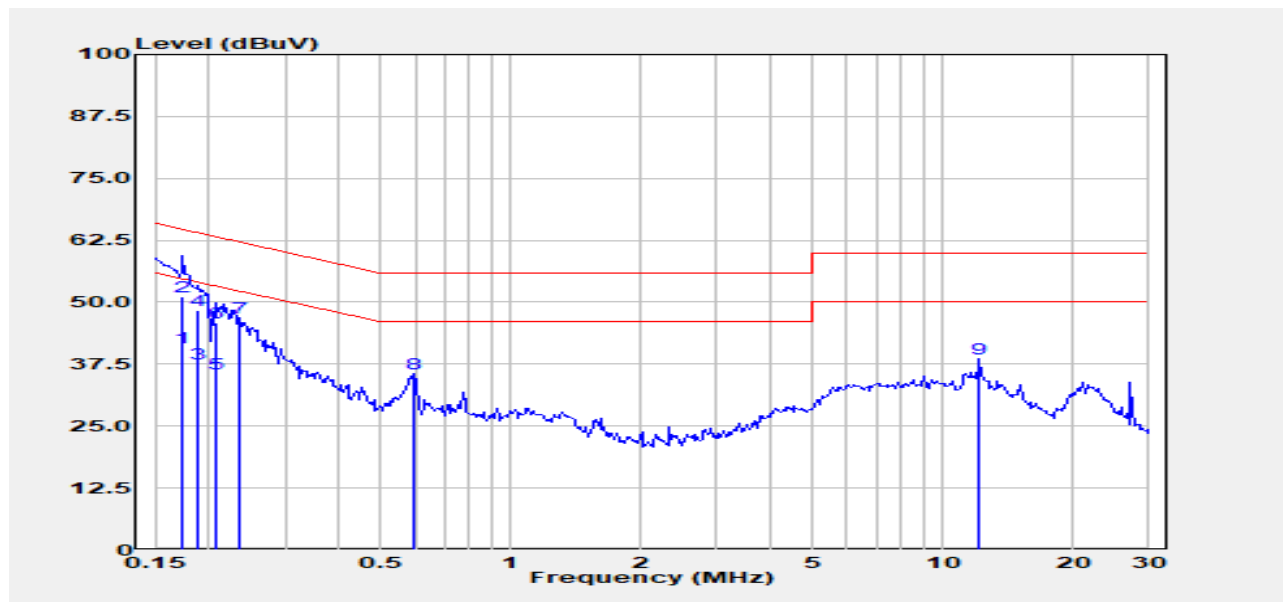

| Freq.<br>MHz | Detector<br>Mode<br>PK/QP/AV | Spectrum<br>Reading Level<br>dBuV | Factor<br>dB | Actual<br>FS<br>dBuV | Limit<br>dBuV | Margin<br>dB |
|--------------|------------------------------|-----------------------------------|--------------|----------------------|---------------|--------------|
| 0.174        | Average                      | 30.30                             | 10.65        | 40.95                | 54.77         | -13.82       |
| 0.174        | QP                           | 40.60                             | 10.65        | 51.25                | 64.77         | -13.52       |
| 0.189        | Average                      | 26.90                             | 10.65        | 37.55                | 54.06         | -16.51       |
| 0.189        | QP                           | 37.60                             | 10.65        | 48.25                | 64.06         | -15.81       |
| 0.208        | Average                      | 25.00                             | 10.65        | 35.65                | 53.27         | -17.62       |
| 0.208        | QP                           | 35.10                             | 10.65        | 45.75                | 63.27         | -17.52       |
| 0.237        | Peak                         | 36.16                             | 10.64        | 46.80                | 62.22         | -15.41       |
| 0.595        | Peak                         | 24.90                             | 10.63        | 35.54                | 56.00         | -20.46       |
| 12.188       | Peak                         | 27.56                             | 11.02        | 38.58                | 60.00         | -21.42       |

Unless otherwise stated the results shown in this test report refer only to the sample(s) tested and such sample(s) are retained for 90 days only.

除非另有說明，此報告結果僅對測試之樣品負責，同時此樣品僅保留90天。本報告未經本公司書面許可，不可部份複製。  
This document is issued by the Company subject to its General Conditions of Service printed overleaf, available on request or accessible at <http://www.sgs.com.tw/Terms-and-Conditions> and for electronic format documents, subject to Terms and Conditions for Electronic Documents at <http://www.sgs.com.tw/Terms-and-Conditions>. Attention is drawn to the limitation of liability, indemnification and jurisdiction issues defined therein. Any holder of this document is advised that information contained hereon reflects the Company's findings at the time of its intervention only and within the limits of Client's instructions, if any. The Company's sole responsibility is to its Client and this document does not exonerate parties to a transaction from exercising all their rights and obligations under the transaction documents. This document cannot be reproduced except in full, without prior written approval of the Company. Any unauthorized alteration, forgery or falsification of the content or appearance of this document is unlawful and offenders may be prosecuted to the fullest extent of the law.

|               |                   |             |               |
|---------------|-------------------|-------------|---------------|
| Report Number | :TERF2405001487E2 | Test Site   | :Conduction C |
| Test Mode     | :BLE              | Test Date   | :2024-06-04   |
| Power         | :120V/60Hz        | Temp./Humi. | :21.6°C/60%   |
| Probe         | :N                | Engineer    | :Jacky Chen   |

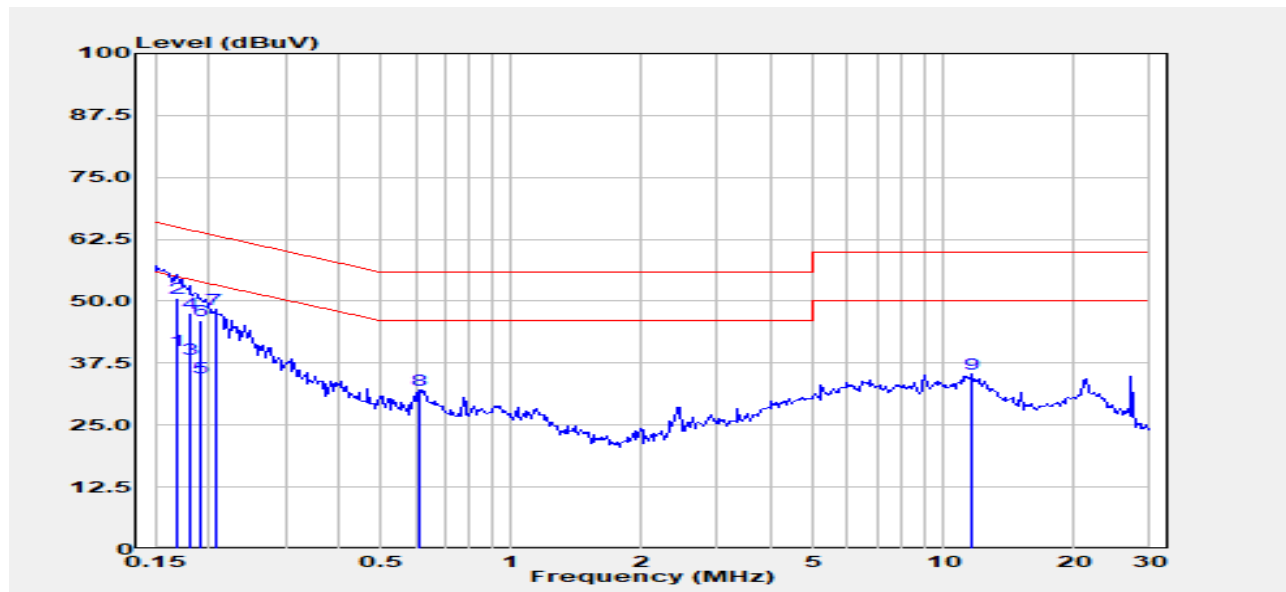

| Freq.<br>MHz | Detector<br>Mode | Spectrum<br>Reading Level<br>dBUV | Factor<br>dB | Actual<br>FS<br>dBUV | Limit<br>dBUV | Margin<br>dB |
|--------------|------------------|-----------------------------------|--------------|----------------------|---------------|--------------|
| 0.169        | Average          | 29.40                             | 10.67        | 40.07                | 55.03         | -14.96       |
| 0.169        | QP               | 40.00                             | 10.67        | 50.67                | 65.03         | -14.36       |
| 0.180        | Average          | 27.60                             | 10.67        | 38.27                | 54.50         | -16.23       |
| 0.180        | QP               | 36.90                             | 10.67        | 47.57                | 64.50         | -16.93       |
| 0.191        | Average          | 23.90                             | 10.67        | 34.57                | 53.98         | -19.41       |
| 0.191        | QP               | 35.50                             | 10.67        | 46.17                | 63.98         | -17.81       |
| 0.206        | Peak             | 37.62                             | 10.67        | 48.29                | 63.36         | -15.07       |
| 0.614        | Peak             | 21.37                             | 10.64        | 32.01                | 56.00         | -23.99       |
| 11.683       | Peak             | 24.31                             | 11.06        | 35.37                | 60.00         | -24.63       |

Unless otherwise stated the results shown in this test report refer only to the sample(s) tested and such sample(s) are retained for 90 days only.

除非另有說明，此報告結果僅對測試之樣品負責，同時此樣品僅保留90天。本報告未經本公司書面許可，不可部份複製。

This document is issued by the Company subject to its General Conditions of Service printed overleaf, available on request or accessible at <http://www.sgs.com.tw/Terms-and-Conditions> and for electronic format documents, subject to Terms and Conditions for Electronic Documents at <http://www.sgs.com.tw/Terms-and-Conditions>. Attention is drawn to the limitation of liability, indemnification and jurisdiction issues defined therein. Any holder of this document is advised that information contained hereon reflects the Company's findings at the time of its intervention only and within the limits of Client's instructions, if any. The Company's sole responsibility is to its Client and this document does not exonerate parties to a transaction from exercising all their rights and obligations under the transaction documents. This document cannot be reproduced except in full, without prior written approval of the Company. Any unauthorized alteration, forgery or falsification of the content or appearance of this document is unlawful and offenders may be prosecuted to the fullest extent of the law.

SGS Taiwan Ltd. No.134,Wu Kung Road, New Taipei Industrial Park, Wuku District, New Taipei City, Taiwan/新北市五股區新北產業園區五工路 134 號

## 8 PEAK OUTPUT POWER MEASUREMENT

### 8.1 Standard Applicable:

#### 8.1.1 Duty Cycle

Pre-analysis Check: While conducting average power measurement, duty cycle of each mode shall be checked to ensure its duty cycle in order to compensate for the loss due to insufficient ratio of duty cycle.

All duty cycle is pre-scanned, and result as obtained below shows only the most representative ones where duty cycle is conducted as the given transmission with given virtual operation that expresses the percentage.

#### 8.1.2 FCC

For systems using digital modulation in the 2400-2483.5 MHz bands, the limit for peak output power is 1Watt.

If the transmitting antenna of directional gain greater than 6dBi are used the peak output power from the intentional radiator shall be reduced below the above stated value by the amount in dB that the directional gain of the Antenna exceeds 6dBi.

In case of point-to-point operation, the limit has to be reduced by 1dB for every 3dB that the directional gain of Antenna exceeds 6dBi.

### 8.2 Test Setup

#### 8.2.1 Duty Cycle

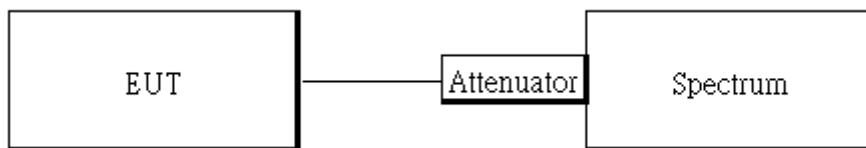

#### 8.2.2 Output Power

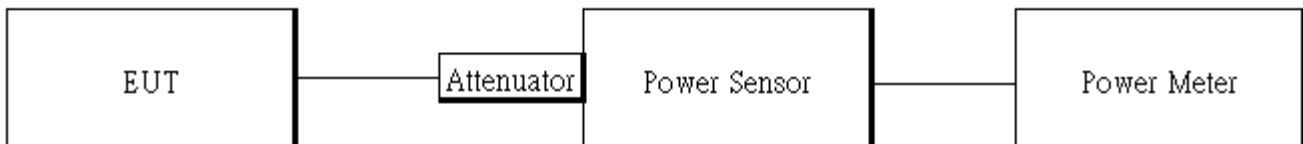

Unless otherwise stated the results shown in this test report refer only to the sample(s) tested and such sample(s) are retained for 90 days only.

除非另有說明，此報告結果僅對測試之樣品負責，同時此樣品僅保留90天。本報告未經本公司書面許可，不可部份複製。

This document is issued by the Company subject to its General Conditions of Service printed overleaf, available on request or accessible at <http://www.sgs.com.tw/Terms-and-Conditions> and for electronic format documents, subject to Terms and Conditions for Electronic Documents at <http://www.sgs.com.tw/Terms-and-Conditions>. Attention is drawn to the limitation of liability, indemnification and jurisdiction issues defined therein. Any holder of this document is advised that information contained hereon reflects the Company's findings at the time of its intervention only and within the limits of Client's instructions, if any. The Company's sole responsibility is to its Client and this document does not exonerate parties to a transaction from exercising all their rights and obligations under the transaction documents. This document cannot be reproduced except in full, without prior written approval of the Company. Any unauthorized alteration, forgery or falsification of the content or appearance of this document is unlawful and offenders may be prosecuted to the fullest extent of the law.

### 8.3 Measurement Procedure:

#### 8.3.1 Duty Cycle

1. Place the EUT on the table and set it in transmitting mode.
2. Set span = Zero
3. RBW = 8MHz, VBW = 8MHz,
4. Detector = Peak

#### 8.3.2 Output Power

1. Place the EUT on the table and set it in transmitting mode.
2. The testing follows the Measurement Procedure of FCC KDB 558074 D01 DTS Meas. Guidance.
3. Remove the antenna from the EUT and then connect a low loss RF cable from the antenna port to the power meter.
4. Record the max. Reading as observed from Power Meter.
5. Repeat above procedures until all test default channel measured was complete.

Unless otherwise stated the results shown in this test report refer only to the sample(s) tested and such sample(s) are retained for 90 days only.  
除非另有說明，此報告結果僅對測試之樣品負責，同時此樣品僅保留90天。本報告未經本公司書面許可，不可部份複製。

This document is issued by the Company subject to its General Conditions of Service printed overleaf, available on request or accessible at <http://www.sgs.com.tw/Terms-and-Conditions> and for electronic format documents, subject to Terms and Conditions for Electronic Documents at <http://www.sgs.com.tw/Terms-and-Conditions>. Attention is drawn to the limitation of liability, indemnification and jurisdiction issues defined therein. Any holder of this document is advised that information contained hereon reflects the Company's findings at the time of its intervention only and within the limits of Client's instructions, if any. The Company's sole responsibility is to its Client and this document does not exonerate parties to a transaction from exercising all their rights and obligations under the transaction documents. This document cannot be reproduced except in full, without prior written approval of the Company. Any unauthorized alteration, forgery or falsification of the content or appearance of this document is unlawful and offenders may be prosecuted to the fullest extent of the law.

8.4 Duty Factor:

|        | Duty Cycle (%)<br>= Ton / (Ton+Toff) | Duty Factor (dB)<br>=10*log ( 1/Duty Cycle ) | 1/T (kHz) | VBW setting (kHz) |
|--------|--------------------------------------|--|-----------|-------------------|
| BLE 1M | 84.00                                | 0.76   | 0.48      | 1.00              |

BLE\_1M\_LowCH00-2402

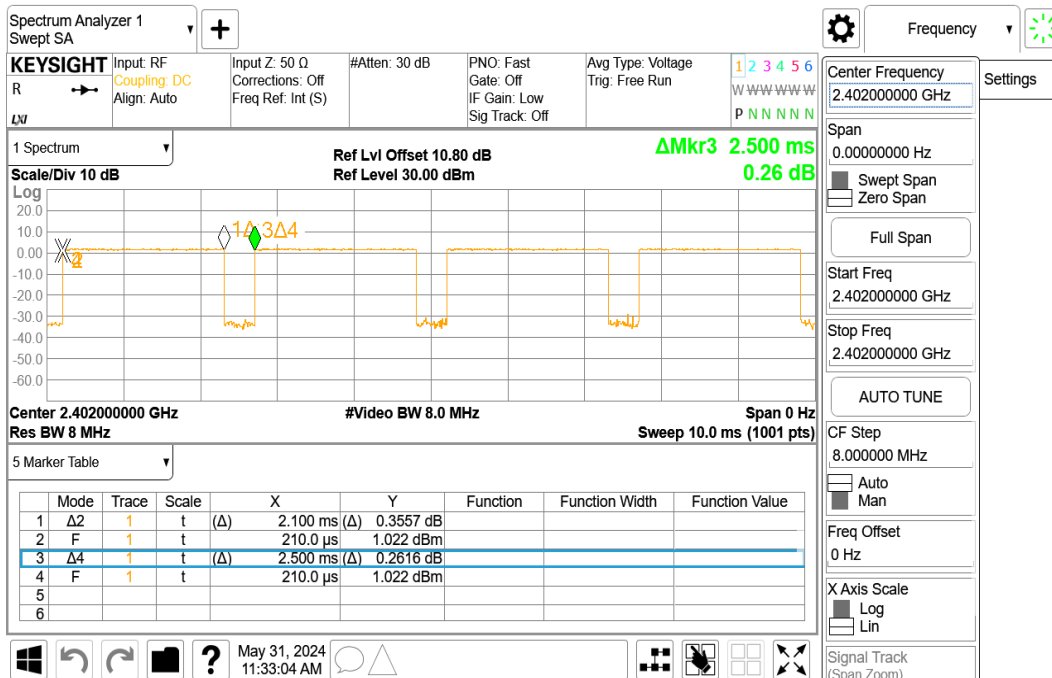

Unless otherwise stated the results shown in this test report refer only to the sample(s) tested and such sample(s) are retained for 90 days only.

除非另有說明，此報告結果僅對測試之樣品負責，同時此樣品僅保留90天。本報告未經本公司書面許可，不可部份複製。

This document is issued by the Company subject to its General Conditions of Service printed overleaf, available on request or accessible at <http://www.sgs.com.tw/Terms-and-Conditions> and for electronic format documents, subject to Terms and Conditions for Electronic Documents at <http://www.sgs.com.tw/Terms-and-Conditions>. Attention is drawn to the limitation of liability, indemnification and jurisdiction issues defined therein. Any holder of this document is advised that information contained hereon reflects the Company's findings at the time of its intervention only and within the limits of Client's instructions, if any. The Company's sole responsibility is to its Client and this document does not exonerate parties to a transaction from exercising all their rights and obligations under the transaction documents. This document cannot be reproduced except in full, without prior written approval of the Company. Any unauthorized alteration, forgery or falsification of the content or appearance of this document is unlawful and offenders may be prosecuted to the fullest extent of the law.

## 8.5 Output Power:

### 8.5.1 Peak & Avg

BLE 1M mode:

| CH   | Frequency (MHz) | Power Setting | Peak Output Power (dBm) | Required Limit (dBm) |
|------|-----------------|---------------|-------------------------|----------------------|
| Low  | 2402            | 11            | 8.74                    | 30                   |
| Mid  | 2442            | 11            | 8.65                    | 30                   |
| High | 2480            | 11            | 8.51                    | 30                   |
| CH   | Frequency (MHz) | Power Setting | Avg. Output Power (dBm) | Required Limit (dBm) |
| Low  | 2402            | 11            | 7.80                    | 30                   |
| Mid  | 2442            | 11            | 7.69                    | 30                   |
| High | 2480            | 11            | 7.54                    | 30                   |

**\*Note:**

**1. Measured by power meter, cable loss 10.8 dB + Duty cycle factor has been offsetted to the power meter for Avg. power and cable loss has been offsetted for Peak power measurement.**

Unless otherwise stated the results shown in this test report refer only to the sample(s) tested and such sample(s) are retained for 90 days only.  
 除非另有說明，此報告結果僅對測試之樣品負責，同時此樣品僅保留90天。本報告未經本公司書面許可，不可部份複製。

This document is issued by the Company subject to its General Conditions of Service printed overleaf, available on request or accessible at <http://www.sgs.com.tw/Terms-and-Conditions> and for electronic format documents, subject to Terms and Conditions for Electronic Documents at <http://www.sgs.com.tw/Terms-and-Conditions>. Attention is drawn to the limitation of liability, indemnification and jurisdiction issues defined therein. Any holder of this document is advised that information contained hereon reflects the Company's findings at the time of its intervention only and within the limits of Client's instructions, if any. The Company's sole responsibility is to its Client and this document does not exonerate parties to a transaction from exercising all their rights and obligations under the transaction documents. This document cannot be reproduced except in full, without prior written approval of the Company. Any unauthorized alteration, forgery or falsification of the content or appearance of this document is unlawful and offenders may be prosecuted to the fullest extent of the law.

## 9 EMISSION BANDWIDTH MEASUREMENT

### 9.1 Standard Applicable

The minimum 6 dB bandwidth shall be at least 500 kHz .

### 9.2 Test Setup

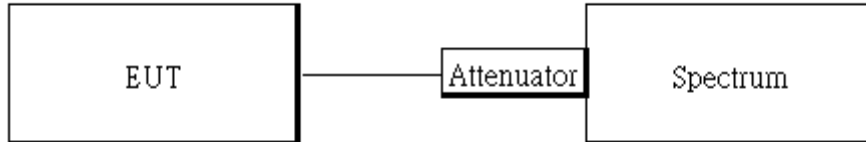

### 9.3 Measurement Procedure:

1. Place the EUT on the table and set it in transmitting mode.
2. Remove the antenna from the EUT and then connect a low loss RF cable from the antenna port to the spectrum analyzer.

#### 9.3.1 6dB BW measurements

1. The testing follows the Measurement Procedure of the KDB 558074 D01.
2. Set the spectrum analyzer as  
 RBW= 100 kHz ,  
 VBW = 3 X RBW,  
 Span= 2 to 5 times of the OBW,  
 Sweep=auto, Detector = Peak, and Max hold.
3. Mark the upper and lower frequencies of -6dB.
4. Repeat above procedures until all test default channel is completed.

### 9.4 Measurement Result:

#### 9.4.1 6dB BW measurements

##### BLE 1M mode

| Frequency (MHz) | 6dB BW (MHz) | Required BW (MHz) | Result |
|-----------------|--------------|-------------------|--------|
| 2402            | 0.6641       | ≥ 0.5             | PASS   |
| 2442            | 0.6651       | ≥ 0.5             | PASS   |
| 2480            | 0.671        | ≥ 0.5             | PASS   |

Unless otherwise stated the results shown in this test report refer only to the sample(s) tested and such sample(s) are retained for 90 days only.  
 除非另有說明，此報告結果僅對測試之樣品負責，同時此樣品僅保留90天。本報告未經本公司書面許可，不可部份複製。

This document is issued by the Company subject to its General Conditions of Service printed overleaf, available on request or accessible at <http://www.sgs.com.tw/Terms-and-Conditions> and for electronic format documents, subject to Terms and Conditions for Electronic Documents at <http://www.sgs.com.tw/Terms-and-Conditions>. Attention is drawn to the limitation of liability, indemnification and jurisdiction issues defined therein. Any holder of this document is advised that information contained hereon reflects the Company's findings at the time of its intervention only and within the limits of Client's instructions, if any. The Company's sole responsibility is to its Client and this document does not exonerate parties to a transaction from exercising all their rights and obligations under the transaction documents. This document cannot be reproduced except in full, without prior written approval of the Company. Any unauthorized alteration, forgery or falsification of the content or appearance of this document is unlawful and offenders may be prosecuted to the fullest extent of the law.

OBW\_BLE 1M\_LowCH00-2402MHz

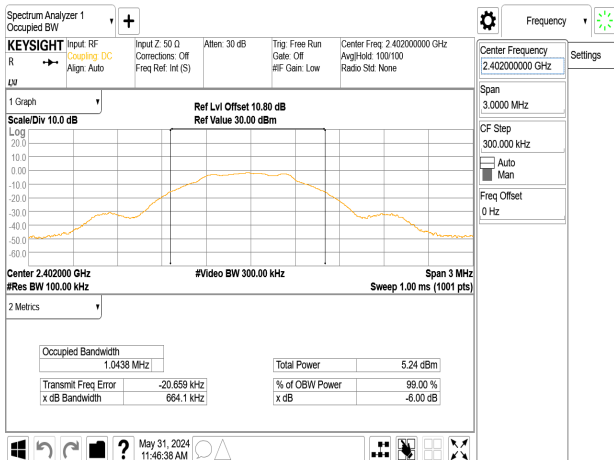

OBW\_BLE 1M\_MidCH20-2442MHz

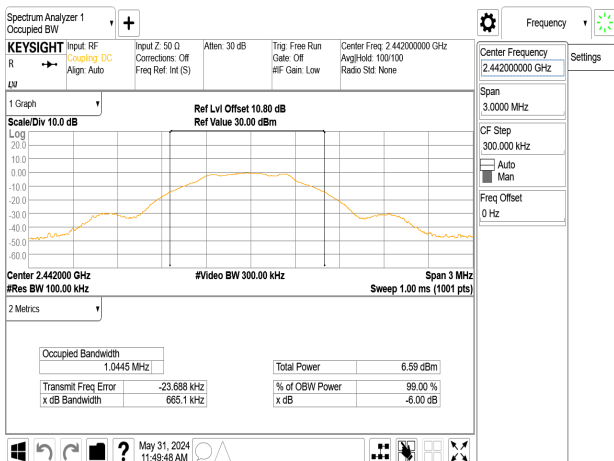

OBW\_BLE 1M\_HighCH39-2480MHz

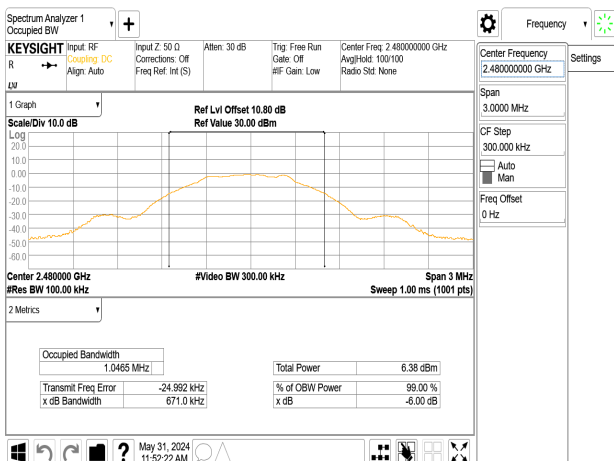

Unless otherwise stated the results shown in this test report refer only to the sample(s) tested and such sample(s) are retained for 90 days only.

除非另有說明，此報告結果僅對測試之樣品負責，同時此樣品僅保留90天。本報告未經本公司書面許可，不可部份複製。

This document is issued by the Company subject to its General Conditions of Service printed overleaf, available on request or accessible at <http://www.sgs.com.tw/Terms-and-Conditions> and for electronic format documents, subject to Terms and Conditions for Electronic Documents at <http://www.sgs.com.tw/Terms-and-Conditions>. Attention is drawn to the limitation of liability, indemnification and jurisdiction issues defined therein. Any holder of this document is advised that information contained hereon reflects the Company's findings at the time of its intervention only and within the limits of Client's instructions, if any. The Company's sole responsibility is to its Client and this document does not exonerate parties to a transaction from exercising all their rights and obligations under the transaction documents. This document cannot be reproduced except in full, without prior written approval of the Company. Any unauthorized alteration, forgery or falsification of the content or appearance of this document is unlawful and offenders may be prosecuted to the fullest extent of the law.



## 10 CONDUCTED BAND EDGES AND SPURIOUS EMISSION MEASUREMENT

### 10.1 Standard Applicable

In any 100 kHz bandwidth outside the frequency band in which the spread spectrum or digitally modulated intentional radiator is operating, the radio frequency power that is produced by the intentional radiator shall be at least 20 dB below that in the 100 kHz bandwidth within the band that contains the highest level of the desired power, based on either an RF conducted or a radiated measurement, provided the transmitter demonstrates compliance with the peak conducted power limits. In addition, radiated emissions which fall in the restricted bands, as defined in §15.205(a), must also comply with the radiated emission limits specified in §15.209(a).

### 10.2 Test Setup

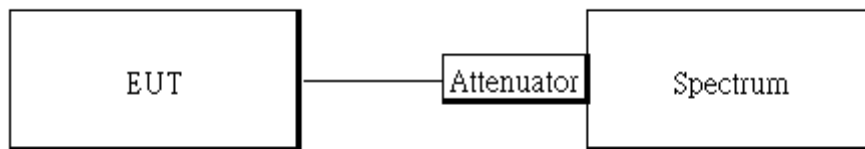

### 10.3 Measurement Procedure

#### 10.3.1 Reference Level of Emission Limit:

1. Set analyzer center frequency to DTS channel center frequency.
2. The testing follows the Measurement Procedure of FCC KDB 558074 D01 DTS Meas. Guidance.
3. Set the span to 1.5 times the DTS channel bandwidth.
4. Set the RBW = 100kHz & VBW = 300 kHz.
5. Detector = peak.
6. Sweep time = auto couple.
7. Trace mode = max hold.
8. Allow trace to fully stabilize.
9. Use the peak marker function to determine the maximum amplitude level.

#### 10.3.2 Conducted Band Edge:

1. To connect Antenna Port of EUT to Spectrum.
2. The testing follows the Measurement Procedure of FCC KDB 558074 D01 DTS Meas. Guidance.
3. Remove the antenna from the EUT and then connect a low loss RF cable from the antenna port to the spectrum analyzer.
4. Set start to edge frequency, and stop frequency of spectrum analyzer so as to encompass

Unless otherwise stated the results shown in this test report refer only to the sample(s) tested and such sample(s) are retained for 90 days only.  
除非另有說明，此報告結果僅對測試之樣品負責，同時此樣品僅保留90天。本報告未經本公司書面許可，不可部份複製。

This document is issued by the Company subject to its General Conditions of Service printed overleaf, available on request or accessible at <http://www.sgs.com.tw/Terms-and-Conditions> and for electronic format documents, subject to Terms and Conditions for Electronic Documents at <http://www.sgs.com.tw/Terms-and-Conditions>. Attention is drawn to the limitation of liability, indemnification and jurisdiction issues defined therein. Any holder of this document is advised that information contained hereon reflects the Company's findings at the time of its intervention only and within the limits of Client's instructions, if any. The Company's sole responsibility is to its Client and this document does not exonerate parties to a transaction from exercising all their rights and obligations under the transaction documents. This document cannot be reproduced except in full, without prior written approval of the Company. Any unauthorized alteration, forgery or falsification of the content or appearance of this document is unlawful and offenders may be prosecuted to the fullest extent of the law.

the spectrum to be examined.

5. Set the spectrum analyzer as RBW=100 kHz, VBW=300 kHz, Detector = Peak, Sweep = auto
6. Set DL as the limit = reading on marker of reference level measurement – 20dBm
7. Mark the highest readings of the emissions outside of 2400MHz~2483.5MHz.
8. Repeat above procedures until all default test channel (low and high) was complete.

### 10.3.3 Conducted Spurious Emission:

1. To connect Antenna Port of EUT to Spectrum.
2. The testing follows the Measurement Procedure of FCC KDB 558074 D01 DTS Meas. Guidance.
3. Set RBW = 100 kHz & VBW=300 kHz, Detector =Peak, Sweep = Auto
4. Allow trace to fully stabilize.
5. Use the peak marker function to determine the maximum power level in any 100 kHz band segment within the fundamental EBW.
6. Repeat above procedures until all default test channel measured were complete.

## 10.4 Measurement Result

BLE 1M\_Reference Level of Limit

| Frequency (MHz) | RF Power Density (dBm) | Reference Level of Limit = PSD - 20dB (dBm) |
|-----------------|------------------------|---|
| 2402            | 7.84                   | -12.16                                      |
| 2442            | 7.99                   | -12.01                                      |
| 2480            | 7.61                   | -12.39                                      |

**Note:**

- 1.cable loss as 10.8dB that offsets in the spectrum
- 2.Refer to next page for plots.

Unless otherwise stated the results shown in this test report refer only to the sample(s) tested and such sample(s) are retained for 90 days only.  
 除非另有說明，此報告結果僅對測試之樣品負責，同時此樣品僅保留90天。本報告未經本公司書面許可，不可部份複製。

This document is issued by the Company subject to its General Conditions of Service printed overleaf, available on request or accessible at <http://www.sgs.com.tw/Terms-and-Conditions> and for electronic format documents, subject to Terms and Conditions for Electronic Documents at <http://www.sgs.com.tw/Terms-and-Conditions>. Attention is drawn to the limitation of liability, indemnification and jurisdiction issues defined therein. Any holder of this document is advised that information contained hereon reflects the Company's findings at the time of its intervention only and within the limits of Client's instructions, if any. The Company's sole responsibility is to its Client and this document does not exonerate parties to a transaction from exercising all their rights and obligations under the transaction documents. This document cannot be reproduced except in full, without prior written approval of the Company. Any unauthorized alteration, forgery or falsification of the content or appearance of this document is unlawful and offenders may be prosecuted to the fullest extent of the law.

Reference Level\_BLE 1M\_LowCH00-2402MHz

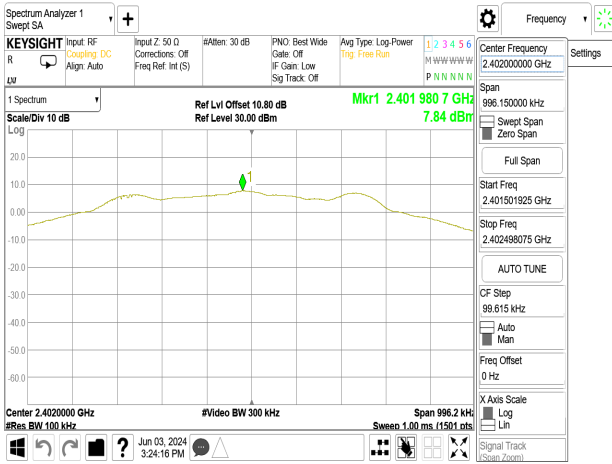

Band Edge\_BLE 1M\_LowCH00-2402MHz

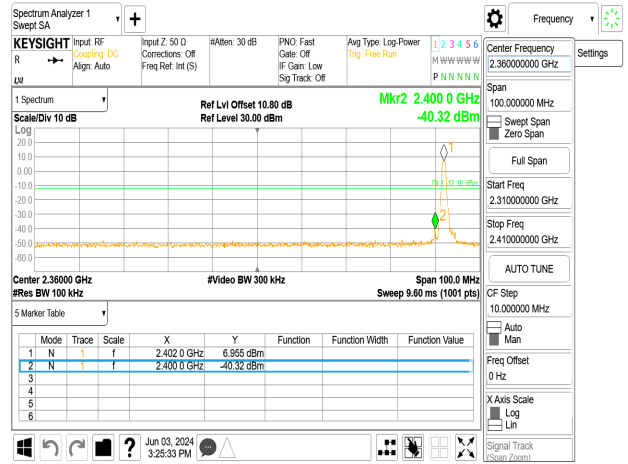

Reference Level\_BLE 1M\_MidCH20-2442MHz

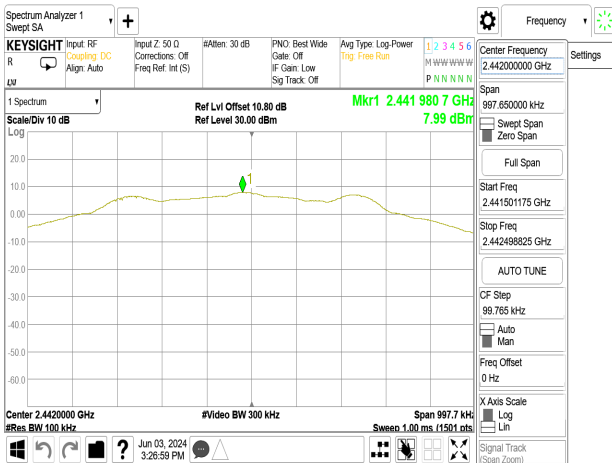

Band Edge\_BLE 1M\_HighCH39-2480MHz

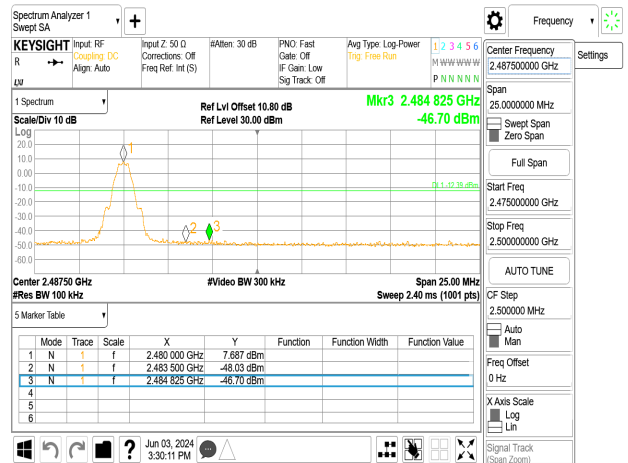

Reference Level\_BLE 1M\_HighCH39-2480MHz



Spurious Emission\_BLE 1M\_LowCH00-2402MHz

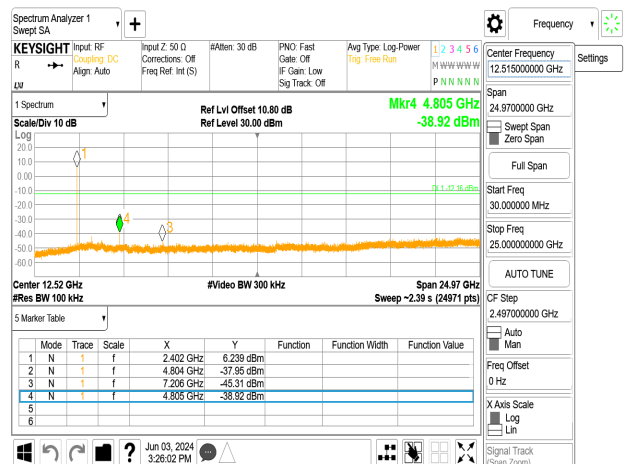

Unless otherwise stated the results shown in this test report refer only to the sample(s) tested and such sample(s) are retained for 90 days only.

除非另有說明，此報告結果僅對測試之樣品負責，同時此樣品僅保留90天。本報告未經本公司書面許可，不可部份複製。

This document is issued by the Company subject to its General Conditions of Service printed overleaf, available on request or accessible at <http://www.sgs.com.tw/Terms-and-Conditions> and for electronic format documents, subject to Terms and Conditions for Electronic Documents at <http://www.sgs.com.tw/Terms-and-Conditions>. Attention is drawn to the limitation of liability, indemnification and jurisdiction issues defined therein. Any holder of this document is advised that information contained hereon reflects the Company's findings at the time of its intervention only and within the limits of Client's instructions, if any. The Company's sole responsibility is to its Client and this document does not exonerate parties to a transaction from exercising all their rights and obligations under the transaction documents. This document cannot be reproduced except in full, without prior written approval of the Company. Any unauthorized alteration, forgery or falsification of the content or appearance of this document is unlawful and offenders may be prosecuted to the fullest extent of the law.

Spurious Emission\_BLE 1M\_MidCH20-2442MHz

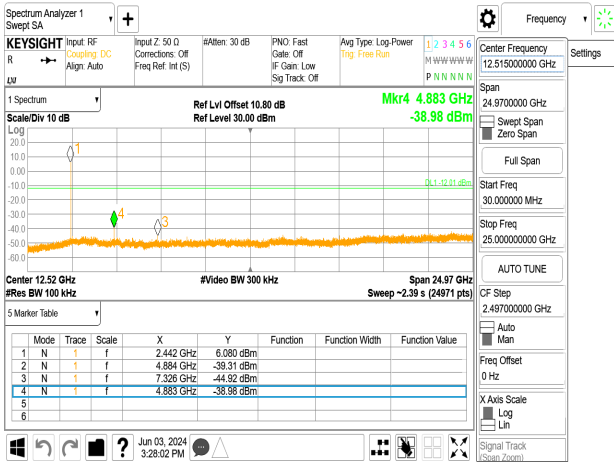

Spurious Emission\_BLE 1M\_HighCH39-2480MHz

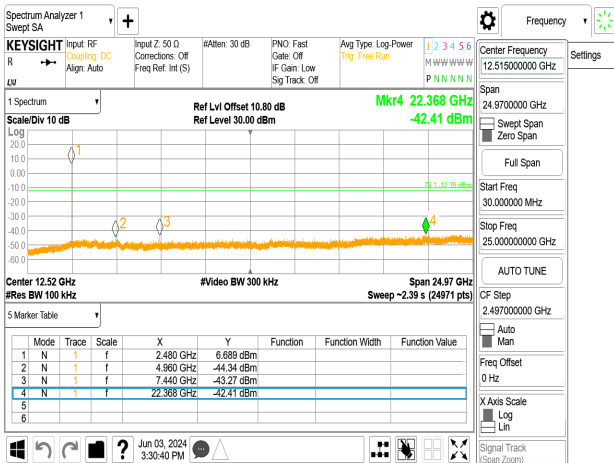

Unless otherwise stated the results shown in this test report refer only to the sample(s) tested and such sample(s) are retained for 90 days only.

除非另有說明，此報告結果僅對測試之樣品負責，同時此樣品僅保留90天。本報告未經本公司書面許可，不可部份複製。

This document is issued by the Company subject to its General Conditions of Service printed overleaf, available on request or accessible at <http://www.sgs.com.tw/Terms-and-Conditions> and for electronic format documents, subject to Terms and Conditions for Electronic Documents at <http://www.sgs.com.tw/Terms-and-Conditions>. Attention is drawn to the limitation of liability, indemnification and jurisdiction issues defined therein. Any holder of this document is advised that information contained hereon reflects the Company's findings at the time of its intervention only and within the limits of Client's instructions, if any. The Company's sole responsibility is to its Client and this document does not exonerate parties to a transaction from exercising all their rights and obligations under the transaction documents. This document cannot be reproduced except in full, without prior written approval of the Company. Any unauthorized alteration, forgery or falsification of the content or appearance of this document is unlawful and offenders may be prosecuted to the fullest extent of the law.

## 11 RADIATED BANDEDGE AND SPURIOUS EMISSION MEASUREMENT

### Spurious Emission

In any 100 kHz bandwidth outside the frequency band in which the spread spectrum or digitally modulated intentional radiator is operating, the radio frequency power that is produced by the intentional radiator shall be at least 20 dB below that in the 100 kHz bandwidth within the band that contains the highest level of the desired power, based on either an RF conducted or a radiated measurement, provided the transmitter demonstrates compliance with the peak conducted power limits. In addition, radiated emissions which fall in the restricted bands must also comply with the §15.209 limit as below.

And according to §15.33(a) (1) for an intentional radiator operates below 10GHz, the frequency range of measurements: to the tenth harmonic of the highest fundamental frequency or to 40GHz, whichever is lower.

| Frequency (MHz) | Field strength (microvolts/meter) | Distance (meters) |
|-----------------|-----------------------------------|-------------------|
| 0.009-0.490     | 2400/F(kHz)                       | 300               |
| 0.490-1.705     | 24000/F(kHz)                      | 30                |
| 1.705-30        | 30                                | 30                |
| 30-88           | 100                               | 3                 |
| 88-216          | 150                               | 3                 |
| 216-960         | 200                               | 3                 |
| Above 960       | 500                               | 3                 |

**Note:** The lower limit shall apply at the transition frequencies.

Unless otherwise stated the results shown in this test report refer only to the sample(s) tested and such sample(s) are retained for 90 days only.  
 除非另有說明，此報告結果僅對測試之樣品負責，同時此樣品僅保留90天。本報告未經本公司書面許可，不可部份複製。

This document is issued by the Company subject to its General Conditions of Service printed overleaf, available on request or accessible at <http://www.sgs.com.tw/Terms-and-Conditions> and for electronic format documents, subject to Terms and Conditions for Electronic Documents at <http://www.sgs.com.tw/Terms-and-Conditions>. Attention is drawn to the limitation of liability, indemnification and jurisdiction issues defined therein. Any holder of this document is advised that information contained hereon reflects the Company's findings at the time of its intervention only and within the limits of Client's instructions, if any. The Company's sole responsibility is to its Client and this document does not exonerate parties to a transaction from exercising all their rights and obligations under the transaction documents. This document cannot be reproduced except in full, without prior written approval of the Company. Any unauthorized alteration, forgery or falsification of the content or appearance of this document is unlawful and offenders may be prosecuted to the fullest extent of the law.

### 11.1 Test Setup

(A) Radiated Emission Test Set-Up, Frequency Below 30MHz.

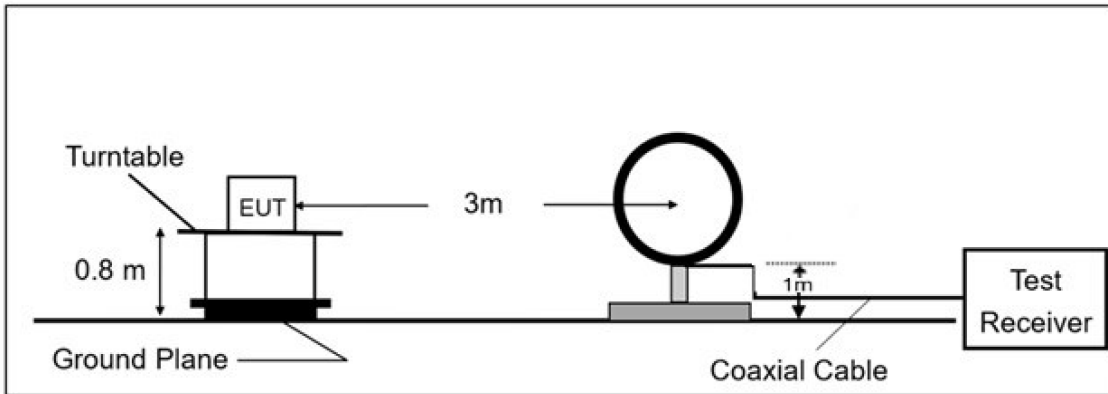

(B) Radiated Emission Test Set-Up, Frequency From 30MHz to 1000MHz.

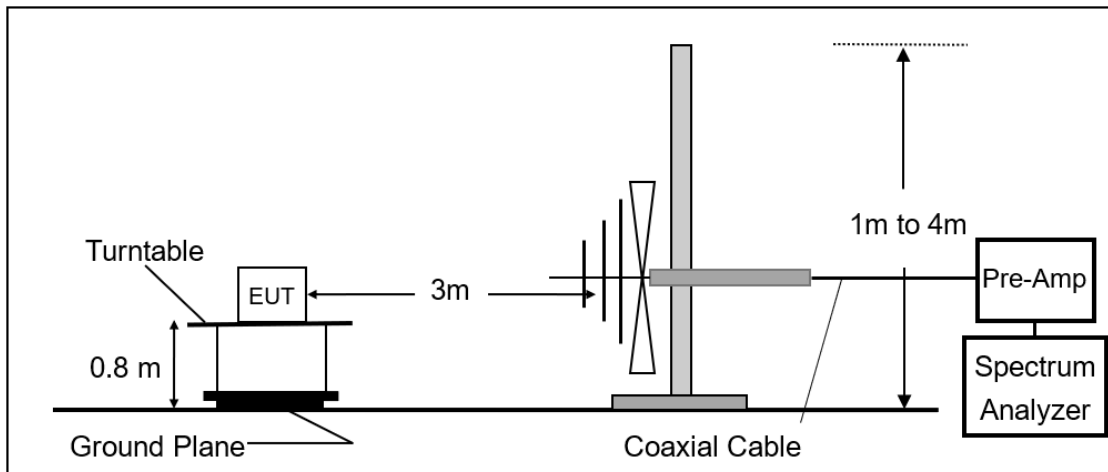

(C) Radiated Emission Test Set-Up, Frequency Above 1GHz.

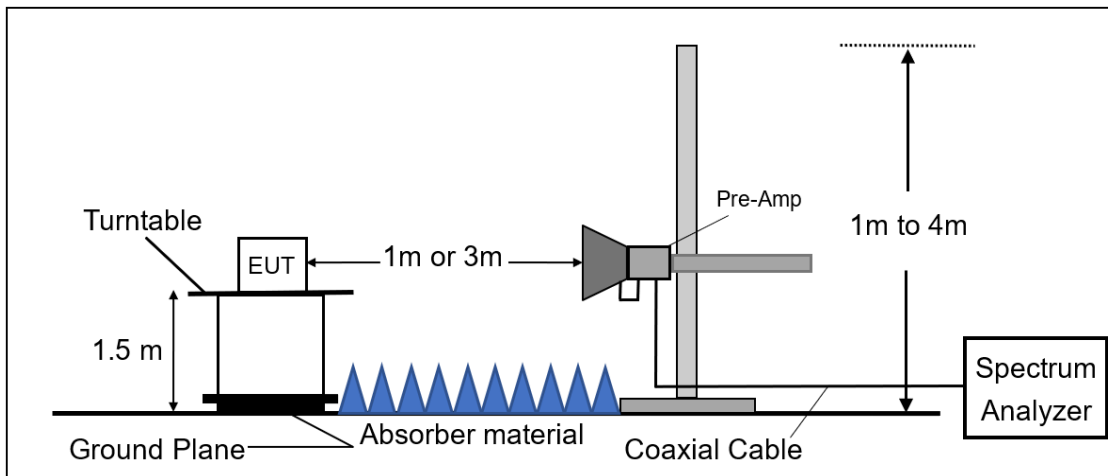

Unless otherwise stated the results shown in this test report refer only to the sample(s) tested and such sample(s) are retained for 90 days only.

除非另有說明，此報告結果僅對測試之樣品負責，同時此樣品僅保留90天。本報告未經本公司書面許可，不可部份複製。

This document is issued by the Company subject to its General Conditions of Service printed overleaf, available on request or accessible at <http://www.sgs.com.tw/Terms-and-Conditions> and for electronic format documents, subject to Terms and Conditions for Electronic Documents at <http://www.sgs.com.tw/Terms-and-Conditions>. Attention is drawn to the limitation of liability, indemnification and jurisdiction issues defined therein. Any holder of this document is advised that information contained hereon reflects the Company's findings at the time of its intervention only and within the limits of Client's instructions, if any. The Company's sole responsibility is to its Client and this document does not exonerate parties to a transaction from exercising all their rights and obligations under the transaction documents. This document cannot be reproduced except in full, without prior written approval of the Company. Any unauthorized alteration, forgery or falsification of the content or appearance of this document is unlawful and offenders may be prosecuted to the fullest extent of the law.

## 11.2 Measurement Procedure

1. The testing follows the Measurement Procedure of FCC KDB 558074 D01 DTS Meas. Guidance.
2. The EUT was placed on a turn table with 0.8m for frequency < 1GHz and 1.5m for frequency > 1GHz above ground plane.
3. The turn table shall rotate 360 degrees to determine the position of maximum emission level.
4. EUT is set 3m away from the receiving antenna which varied from 1m to 4m to find out the highest emissions.
5. Set the spectrum analyzer as RBW=100 kHz and VBW=300 kHz for Peak Detector (PK) at frequency between 30MHz and 1 GHz.
6. Use receiver mode as RBW=120 kHz for Quasi-peak (QP) at frequency between 30MHz and 1 GHz.
7. Set the spectrum analyzer as RBW=1 MHz, VBW=3 MHz for Maximum Emission Measurements at frequency above 1 GHz.
8. Set the spectrum analyzer as RBW=1 MHz, VBW=10 Hz (Duty cycle > 98%) or VBW ≥ 1/T (Duty cycle < 98%) for Average Emission Measurements at frequency above 1 GHz.
9. When measurement procedures for electric field radiated emissions above 1 GHz the EUT measurement is to be made “while keeping the antenna in the ‘cone of radiation’ from that area and pointed at the area both in azimuth and elevation, with polarization oriented for maximum response.” is still within the 3dB illumination BW of the measurement antenna.
10. Maximum procedure was performed on the six highest emissions to ensure EUT compliance.
11. And also, each emission was to be maximized by changing the polarization of receiving antenna both horizontal and vertical.
12. Repeat above procedures until all default test channel measured were complete.

## 11.3 Field Strength Calculation

The field strength is calculated by adding the Antenna Factor and Cable Factor and subtracting the Amplifier Gain and Duty Cycle Correction Factor (if any) from the measured reading. The basic equation with a sample calculation is as follows:

$$FS = RA + AF + CL - AG$$

**Where** *FS* = Field Strength  
*RA* = Reading Amplitude  
*AF* = Antenna Factor

*CL* = Cable Attenuation Factor (Cable Loss)  
*AG* = Amplifier Gain

Unless otherwise stated the results shown in this test report refer only to the sample(s) tested and such sample(s) are retained for 90 days only.  
 除非另有說明，此報告結果僅對測試之樣品負責，同時此樣品僅保留90天。本報告未經本公司書面許可，不可部份複製。

This document is issued by the Company subject to its General Conditions of Service printed overleaf, available on request or accessible at <http://www.sgs.com.tw/Terms-and-Conditions> and for electronic format documents, subject to Terms and Conditions for Electronic Documents at <http://www.sgs.com.tw/Terms-and-Conditions>. Attention is drawn to the limitation of liability, indemnification and jurisdiction issues defined therein. Any holder of this document is advised that information contained hereon reflects the Company's findings at the time of its intervention only and within the limits of Client's instructions, if any. The Company's sole responsibility is to its Client and this document does not exonerate parties to a transaction from exercising all their rights and obligations under the transaction documents. This document cannot be reproduced except in full, without prior written approval of the Company. Any unauthorized alteration, forgery or falsification of the content or appearance of this document is unlawful and offenders may be prosecuted to the fullest extent of the law.

The limit of the emission level is expressed in dBuV/m, which converts  $20 \cdot \log(uV/m)$

$Actual\ FS(dB\mu V/m) = SPA.\ Reading\ level(dB\mu V) + Factor(dB)$

$Factor(dB) = Antenna\ Factor(dB\mu V/m) + Cable\ Loss(dB) - Pre\_Amplifier\ Gain(dB)$

#### 11.4 Test Results of Radiated Spurious Emissions from 9 kHz to 30 MHz

The low frequency, which started from 9 kHz to 30MHz, was pre-scanned and the result which was 20dB lower than the limit per 15.31(o) was not reported.

Unless otherwise stated the results shown in this test report refer only to the sample(s) tested and such sample(s) are retained for 90 days only.

除非另有說明，此報告結果僅對測試之樣品負責，同時此樣品僅保留90天。本報告未經本公司書面許可，不可部份複製。

This document is issued by the Company subject to its General Conditions of Service printed overleaf, available on request or accessible at <http://www.sgs.com.tw/Terms-and-Conditions> and for electronic format documents, subject to Terms and Conditions for Electronic Documents at <http://www.sgs.com.tw/Terms-and-Conditions>. Attention is drawn to the limitation of liability, indemnification and jurisdiction issues defined therein. Any holder of this document is advised that information contained hereon reflects the Company's findings at the time of its intervention only and within the limits of Client's instructions, if any. The Company's sole responsibility is to its Client and this document does not exonerate parties to a transaction from exercising all their rights and obligations under the transaction documents. This document cannot be reproduced except in full, without prior written approval of the Company. Any unauthorized alteration, forgery or falsification of the content or appearance of this document is unlawful and offenders may be prosecuted to the fullest extent of the law.



### 11.4.1 Radiated Band Edge Measurement Result

|                |                   |              |                |
|----------------|-------------------|--------------|----------------|
| Report Number  | :TERF2405001487E2 | Test Site    | :SAC G Chamber |
| Operation Mode | :BLE 1M           | Test Date    | :2024-06-04    |
| Test Frequency | :2402 MHz         | Temp./Humi.  | :23.4°C/56%    |
| Test Mode      | :Bandedge         | Antenna Pol. | :Vertical      |
| EUT Pol        | :E2 Plane         | Engineer     | :Jacky Chen    |

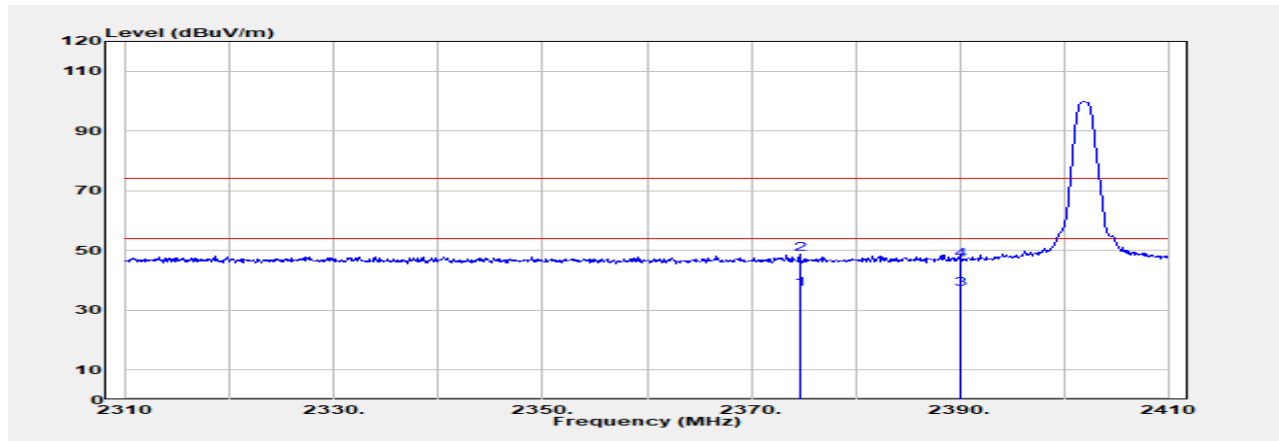

| Freq.<br>MHz | Detector<br>Mode<br>PK/QP/AVG | Spectrum<br>Reading Level<br>dBμV | Factor<br>dB | Actual<br>FS<br>dBμV/m | Limit<br>@3m<br>dBμV/m | Margin<br>dB |
|--------------|-------------------------------|-----------------------------------|--------------|------------------------|------------------------|--------------|
| 2374.700     | Average                       | 40.30                             | -3.25        | 37.05                  | 54.00                  | -16.95       |
| 2374.700     | Peak                          | 52.01                             | -3.25        | 48.76                  | 74.00                  | -25.24       |
| 2390.000     | Average                       | 40.46                             | -3.28        | 37.18                  | 54.00                  | -16.82       |
| 2390.000     | Peak                          | 50.12                             | -3.28        | 46.84                  | 74.00                  | -27.16       |

Unless otherwise stated the results shown in this test report refer only to the sample(s) tested and such sample(s) are retained for 90 days only.

除非另有說明，此報告結果僅對測試之樣品負責，同時此樣品僅保留90天。本報告未經本公司書面許可，不可部份複製。

This document is issued by the Company subject to its General Conditions of Service printed overleaf, available on request or accessible at <http://www.sgs.com.tw/Terms-and-Conditions> and for electronic format documents, subject to Terms and Conditions for Electronic Documents at <http://www.sgs.com.tw/Terms-and-Conditions>. Attention is drawn to the limitation of liability, indemnification and jurisdiction issues defined therein. Any holder of this document is advised that information contained hereon reflects the Company's findings at the time of its intervention only and within the limits of Client's instructions, if any. The Company's sole responsibility is to its Client and this document does not exonerate parties to a transaction from exercising all their rights and obligations under the transaction documents. This document cannot be reproduced except in full, without prior written approval of the Company. Any unauthorized alteration, forgery or falsification of the content or appearance of this document is unlawful and offenders may be prosecuted to the fullest extent of the law.

|                |                   |              |                |
|----------------|-------------------|--------------|----------------|
| Report Number  | :TERF2405001487E2 | Test Site    | :SAC G Chamber |
| Operation Mode | :BLE 1M           | Test Date    | :2024-06-04    |
| Test Frequency | :2402 MHz         | Temp./Humi.  | :23.4°C/56%    |
| Test Mode      | :Bandedge         | Antenna Pol. | :Horizontal    |
| EUT Pol        | :E2 Plane         | Engineer     | :Jacky Chen    |

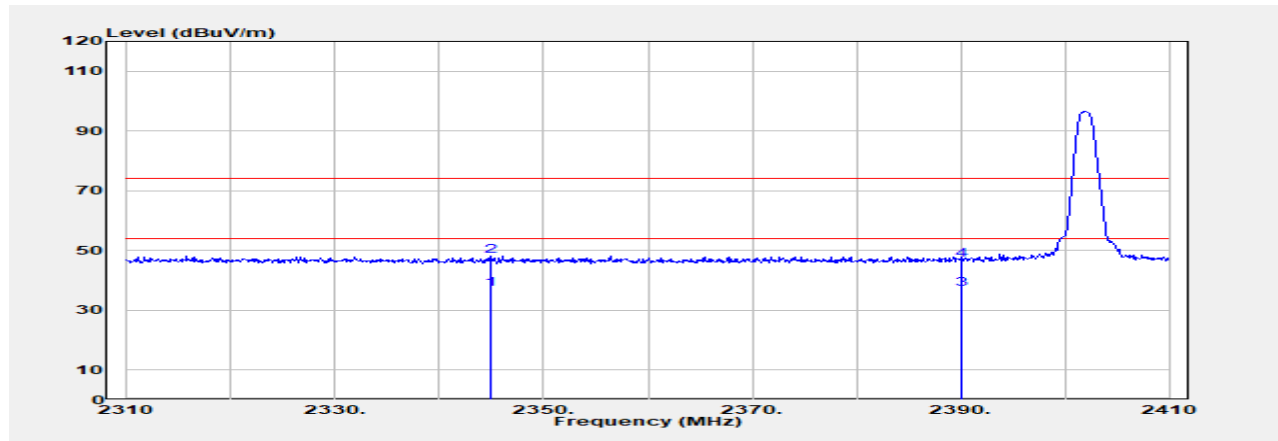

| Freq.<br>MHz | Detector<br>Mode<br>PK/QP/AVG | Spectrum<br>Reading Level<br>dBuV | Factor<br>dB | Actual<br>FS<br>dBuV/m | Limit<br>@3m<br>dBuV/m | Margin<br>dB |
|--------------|-------------------------------|-----------------------------------|--------------|------------------------|------------------------|--------------|
| 2345.000     | Average                       | 40.19                             | -3.21        | 36.99                  | 54.00                  | -17.01       |
| 2345.000     | Peak                          | 51.45                             | -3.21        | 48.24                  | 74.00                  | -25.76       |
| 2390.000     | Average                       | 40.49                             | -3.28        | 37.22                  | 54.00                  | -16.78       |
| 2390.000     | Peak                          | 49.96                             | -3.28        | 46.69                  | 74.00                  | -27.31       |

Unless otherwise stated the results shown in this test report refer only to the sample(s) tested and such sample(s) are retained for 90 days only.

除非另有說明，此報告結果僅對測試之樣品負責，同時此樣品僅保留90天。本報告未經本公司書面許可，不可部份複製。

This document is issued by the Company subject to its General Conditions of Service printed overleaf, available on request or accessible at <http://www.sgs.com.tw/Terms-and-Conditions> and for electronic format documents, subject to Terms and Conditions for Electronic Documents at <http://www.sgs.com.tw/Terms-and-Conditions>. Attention is drawn to the limitation of liability, indemnification and jurisdiction issues defined therein. Any holder of this document is advised that information contained hereon reflects the Company's findings at the time of its intervention only and within the limits of Client's instructions, if any. The Company's sole responsibility is to its Client and this document does not exonerate parties to a transaction from exercising all their rights and obligations under the transaction documents. This document cannot be reproduced except in full, without prior written approval of the Company. Any unauthorized alteration, forgery or falsification of the content or appearance of this document is unlawful and offenders may be prosecuted to the fullest extent of the law.

|                |                   |              |                |
|----------------|-------------------|--------------|----------------|
| Report Number  | :TERF2405001487E2 | Test Site    | :SAC G Chamber |
| Operation Mode | :BLE 1M           | Test Date    | :2024-06-04    |
| Test Frequency | :2480 MHz         | Temp./Humi.  | :23.4°C/56%    |
| Test Mode      | :Bandedge         | Antenna Pol. | :Vertical      |
| EUT Pol        | :E2 Plane         | Engineer     | :Jacky Chen    |

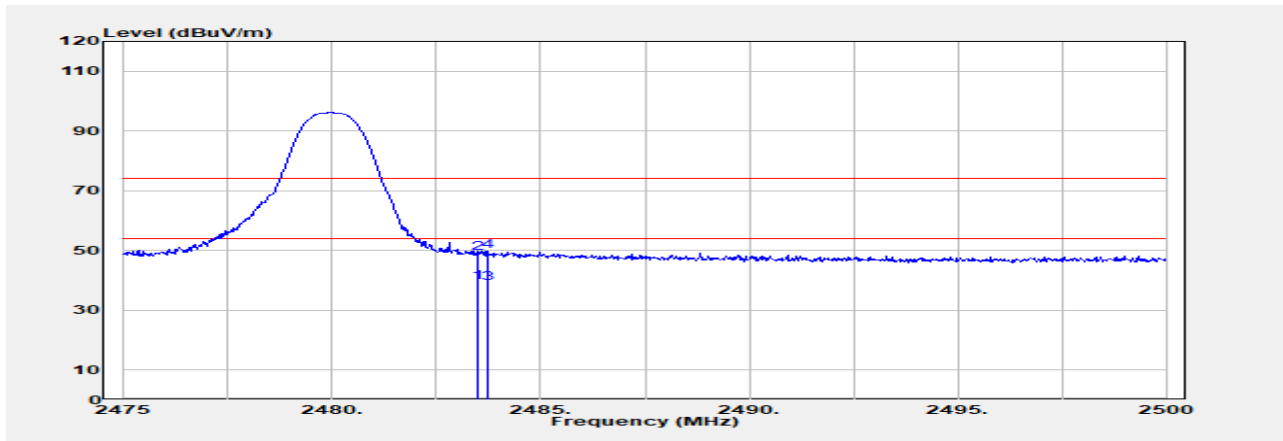

| Freq.<br>MHz | Detector<br>Mode<br>PK/QP/AVG | Spectrum<br>Reading Level<br>dBuV | Factor<br>dB | Actual<br>FS<br>dBuV/m | Limit<br>@3m<br>dBuV/m | Margin<br>dB |
|--------------|-------------------------------|-----------------------------------|--------------|------------------------|------------------------|--------------|
| 2483.500     | Average                       | 42.66                             | -3.31        | 39.35                  | 54.00                  | -14.65       |
| 2483.500     | Peak                          | 52.47                             | -3.31        | 49.16                  | 74.00                  | -24.84       |
| 2483.750     | Average                       | 42.37                             | -3.31        | 39.06                  | 54.00                  | -14.94       |
| 2483.750     | Peak                          | 53.22                             | -3.31        | 49.91                  | 74.00                  | -24.09       |

Unless otherwise stated the results shown in this test report refer only to the sample(s) tested and such sample(s) are retained for 90 days only.

除非另有說明，此報告結果僅對測試之樣品負責，同時此樣品僅保留90天。本報告未經本公司書面許可，不可部份複製。

This document is issued by the Company subject to its General Conditions of Service printed overleaf, available on request or accessible at <http://www.sgs.com.tw/Terms-and-Conditions> and for electronic format documents, subject to Terms and Conditions for Electronic Documents at <http://www.sgs.com.tw/Terms-and-Conditions>. Attention is drawn to the limitation of liability, indemnification and jurisdiction issues defined therein. Any holder of this document is advised that information contained hereon reflects the Company's findings at the time of its intervention only and within the limits of Client's instructions, if any. The Company's sole responsibility is to its Client and this document does not exonerate parties to a transaction from exercising all their rights and obligations under the transaction documents. This document cannot be reproduced except in full, without prior written approval of the Company. Any unauthorized alteration, forgery or falsification of the content or appearance of this document is unlawful and offenders may be prosecuted to the fullest extent of the law.

|                |                   |              |                |
|----------------|-------------------|--------------|----------------|
| Report Number  | :TERF2405001487E2 | Test Site    | :SAC G Chamber |
| Operation Mode | :BLE 1M           | Test Date    | :2024-06-04    |
| Test Frequency | :2480 MHz         | Temp./Humi.  | :23.4°C/56%    |
| Test Mode      | :Bandedge         | Antenna Pol. | :Horizontal    |
| EUT Pol        | :E2 Plane         | Engineer     | :Jacky Chen    |

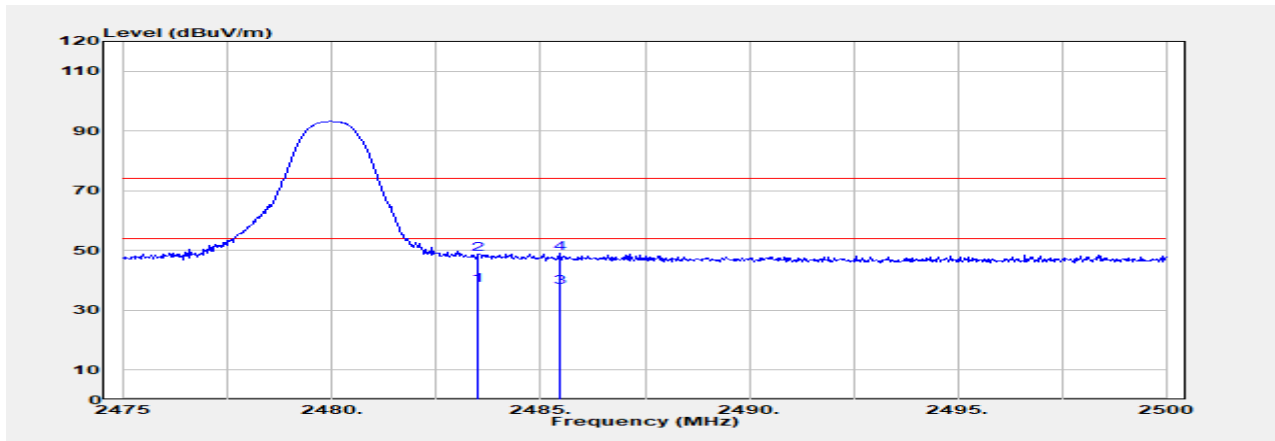

| Freq.<br>MHz | Detector<br>Mode<br>PK/QP/AVG | Spectrum<br>Reading Level<br>dBuV | Factor<br>dB | Actual<br>FS<br>dBuV/m | Limit<br>@3m<br>dBuV/m | Margin<br>dB |
|--------------|-------------------------------|-----------------------------------|--------------|------------------------|------------------------|--------------|
| 2483.500     | Average                       | 41.59                             | -3.31        | 38.27                  | 54.00                  | -15.73       |
| 2483.500     | Peak                          | 52.21                             | -3.31        | 48.89                  | 74.00                  | -25.11       |
| 2485.450     | Average                       | 41.05                             | -3.31        | 37.74                  | 54.00                  | -16.26       |
| 2485.450     | Peak                          | 52.29                             | -3.31        | 48.98                  | 74.00                  | -25.02       |

Unless otherwise stated the results shown in this test report refer only to the sample(s) tested and such sample(s) are retained for 90 days only.

除非另有說明，此報告結果僅對測試之樣品負責，同時此樣品僅保留90天。本報告未經本公司書面許可，不可部份複製。

This document is issued by the Company subject to its General Conditions of Service printed overleaf, available on request or accessible at <http://www.sgs.com.tw/Terms-and-Conditions> and for electronic format documents, subject to Terms and Conditions for Electronic Documents at <http://www.sgs.com.tw/Terms-and-Conditions>. Attention is drawn to the limitation of liability, indemnification and jurisdiction issues defined therein. Any holder of this document is advised that information contained hereon reflects the Company's findings at the time of its intervention only and within the limits of Client's instructions, if any. The Company's sole responsibility is to its Client and this document does not exonerate parties to a transaction from exercising all their rights and obligations under the transaction documents. This document cannot be reproduced except in full, without prior written approval of the Company. Any unauthorized alteration, forgery or falsification of the content or appearance of this document is unlawful and offenders may be prosecuted to the fullest extent of the law.

### 11.4.2 Radiated Spurious Emission

|                |                   |              |                |
|----------------|-------------------|--------------|----------------|
| Report Number  | :TERF2405001487E2 | Test Site    | :SAC G Chamber |
| Operation Mode | :BLE 1M           | Test Date    | :2024-06-14    |
| Test Frequency | :2442 MHz         | Temp./Humi.  | :21.1°C/64%    |
| Test Mode      | :Tx               | Antenna Pol. | :Vertical      |
| EUT Pol        | :E2 Plane         | Engineer     | :Jacky Chen    |

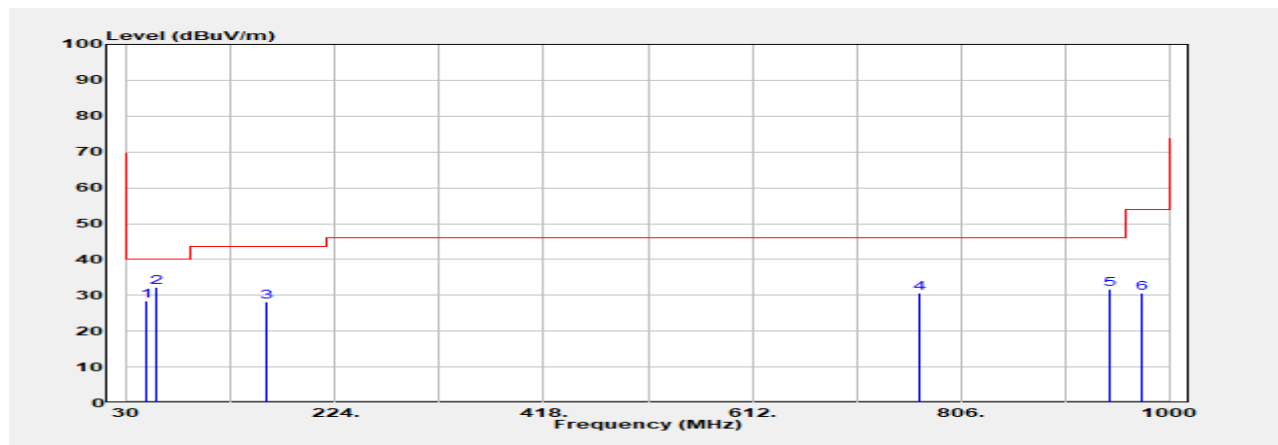

| Freq.<br>MHz | Detector<br>Mode<br>PK/QP/AVG | Spectrum<br>Reading Level<br>dBμV | Factor<br>dB | Actual<br>FS<br>dBμV/m | Limit<br>@3m<br>dBμV/m | Margin<br>dB |
|--------------|-------------------------------|-----------------------------------|--------------|------------------------|------------------------|--------------|
| 48.430       | Peak                          | 41.07                             | -12.67       | 28.40                  | 40.00                  | -11.60       |
| 58.130       | Peak                          | 45.18                             | -12.95       | 32.22                  | 40.00                  | -7.78        |
| 159.980      | Peak                          | 40.90                             | -12.78       | 28.13                  | 43.50                  | -15.37       |
| 768.170      | Peak                          | 32.32                             | -1.58        | 30.73                  | 46.00                  | -15.27       |
| 944.710      | Peak                          | 31.44                             | 0.13         | 31.58                  | 46.00                  | -14.42       |
| 974.780      | Peak                          | 29.66                             | 1.08         | 30.74                  | 54.00                  | -23.26       |

Unless otherwise stated the results shown in this test report refer only to the sample(s) tested and such sample(s) are retained for 90 days only.

除非另有說明，此報告結果僅對測試之樣品負責，同時此樣品僅保留90天。本報告未經本公司書面許可，不可部份複製。

This document is issued by the Company subject to its General Conditions of Service printed overleaf, available on request or accessible at <http://www.sgs.com.tw/Terms-and-Conditions> and for electronic format documents, subject to Terms and Conditions for Electronic Documents at <http://www.sgs.com.tw/Terms-and-Conditions>. Attention is drawn to the limitation of liability, indemnification and jurisdiction issues defined therein. Any holder of this document is advised that information contained hereon reflects the Company's findings at the time of its intervention only and within the limits of Client's instructions, if any. The Company's sole responsibility is to its Client and this document does not exonerate parties to a transaction from exercising all their rights and obligations under the transaction documents. This document cannot be reproduced except in full, without prior written approval of the Company. Any unauthorized alteration, forgery or falsification of the content or appearance of this document is unlawful and offenders may be prosecuted to the fullest extent of the law.

Report Number :TERF2405001487E2  
 Operation Mode :BLE 1M  
 Test Frequency :2442 MHz  
 Test Mode :Tx  
 EUT Pol :E2 Plane

Test Site :SAC G Chamber  
 Test Date :2024-06-14  
 Temp./Humi. :21.1°C/64%  
 Antenna Pol. :Horizontal  
 Engineer :Jacky Chen

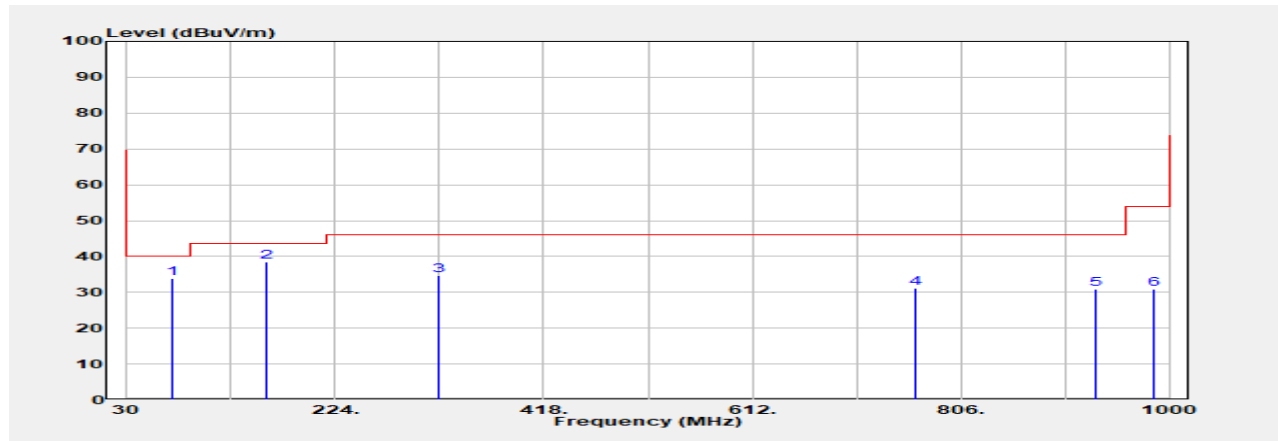

| Freq.<br>MHz | Detector<br>Mode<br>PK/QP/AVG | Spectrum<br>Reading Level<br>dBuV | Factor<br>dB | Actual<br>FS<br>dBuV/m | Limit<br>@3m<br>dBuV/m | Margin<br>dB |
|--------------|-------------------------------|-----------------------------------|--------------|------------------------|------------------------|--------------|
| 71.710       | Peak                          | 48.95                             | -15.08       | 33.86                  | 40.00                  | -6.14        |
| 159.980      | QP                            | 51.20                             | -12.78       | 38.42                  | 43.50                  | -5.08        |
| 320.030      | Peak                          | 45.94                             | -11.22       | 34.72                  | 46.00                  | -11.28       |
| 764.290      | Peak                          | 32.72                             | -1.62        | 31.10                  | 46.00                  | -14.90       |
| 932.100      | Peak                          | 31.26                             | -0.25        | 31.01                  | 46.00                  | -14.99       |
| 986.420      | Peak                          | 30.20                             | 0.82         | 31.02                  | 54.00                  | -22.98       |

Unless otherwise stated the results shown in this test report refer only to the sample(s) tested and such sample(s) are retained for 90 days only.  
 除非另有說明，此報告結果僅對測試之樣品負責，同時此樣品僅保留90天。本報告未經本公司書面許可，不可部份複製。

This document is issued by the Company subject to its General Conditions of Service printed overleaf, available on request or accessible at <http://www.sgs.com.tw/Terms-and-Conditions> and for electronic format documents, subject to Terms and Conditions for Electronic Documents at <http://www.sgs.com.tw/Terms-and-Conditions>. Attention is drawn to the limitation of liability, indemnification and jurisdiction issues defined therein. Any holder of this document is advised that information contained hereon reflects the Company's findings at the time of its intervention only and within the limits of Client's instructions, if any. The Company's sole responsibility is to its Client and this document does not exonerate parties to a transaction from exercising all their rights and obligations under the transaction documents. This document cannot be reproduced except in full, without prior written approval of the Company. Any unauthorized alteration, forgery or falsification of the content or appearance of this document is unlawful and offenders may be prosecuted to the fullest extent of the law.

|                |                   |              |                |
|----------------|-------------------|--------------|----------------|
| Report Number  | :TERF2405001487E2 | Test Site    | :SAC G Chamber |
| Operation Mode | :BLE 1M           | Test Date    | :2024-06-04    |
| Test Frequency | :2402 MHz         | Temp./Humi.  | :23.4°C/56%    |
| Test Mode      | :Tx               | Antenna Pol. | :Vertical      |
| EUT Pol        | :E2 Plane         | Engineer     | :Jacky Chen    |

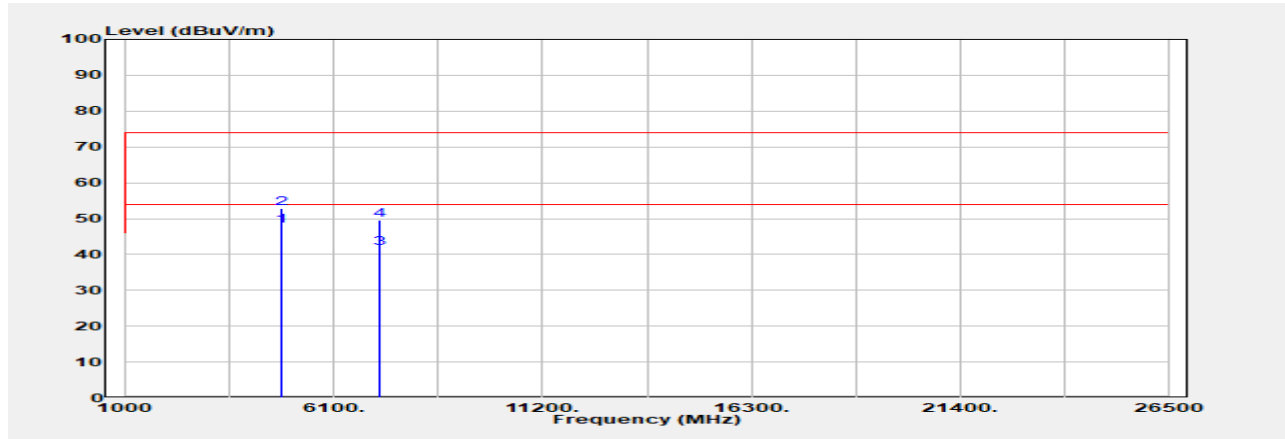

| Freq.<br>MHz | Detector<br>Mode<br>PK/QP/AVG | Spectrum<br>Reading Level<br>dBuV | Factor<br>dB | Actual<br>FS<br>dBuV/m | Limit<br>@3m<br>dBuV/m | Margin<br>dB |
|--------------|-------------------------------|-----------------------------------|--------------|------------------------|------------------------|--------------|
| 4804.000     | Average                       | 44.69                             | 3.33         | 48.02                  | 54.00                  | -5.98        |
| 4804.000     | Peak                          | 49.38                             | 3.33         | 52.72                  | 74.00                  | -21.28       |
| 7206.000     | Average                       | 32.55                             | 9.17         | 41.72                  | 54.00                  | -12.28       |
| 7206.000     | Peak                          | 40.53                             | 9.17         | 49.70                  | 74.00                  | -24.30       |

Unless otherwise stated the results shown in this test report refer only to the sample(s) tested and such sample(s) are retained for 90 days only.

除非另有說明，此報告結果僅對測試之樣品負責，同時此樣品僅保留90天。本報告未經本公司書面許可，不可部份複製。

This document is issued by the Company subject to its General Conditions of Service printed overleaf, available on request or accessible at <http://www.sgs.com.tw/Terms-and-Conditions> and for electronic format documents, subject to Terms and Conditions for Electronic Documents at <http://www.sgs.com.tw/Terms-and-Conditions>. Attention is drawn to the limitation of liability, indemnification and jurisdiction issues defined therein. Any holder of this document is advised that information contained hereon reflects the Company's findings at the time of its intervention only and within the limits of Client's instructions, if any. The Company's sole responsibility is to its Client and this document does not exonerate parties to a transaction from exercising all their rights and obligations under the transaction documents. This document cannot be reproduced except in full, without prior written approval of the Company. Any unauthorized alteration, forgery or falsification of the content or appearance of this document is unlawful and offenders may be prosecuted to the fullest extent of the law.

|                |                   |              |                |
|----------------|-------------------|--------------|----------------|
| Report Number  | :TERF2405001487E2 | Test Site    | :SAC G Chamber |
| Operation Mode | :BLE 1M           | Test Date    | :2024-06-04    |
| Test Frequency | :2402 MHz         | Temp./Humi.  | :23.4°C/56%    |
| Test Mode      | :Tx               | Antenna Pol. | :Horizontal    |
| EUT Pol        | :E2 Plane         | Engineer     | :Jacky Chen    |

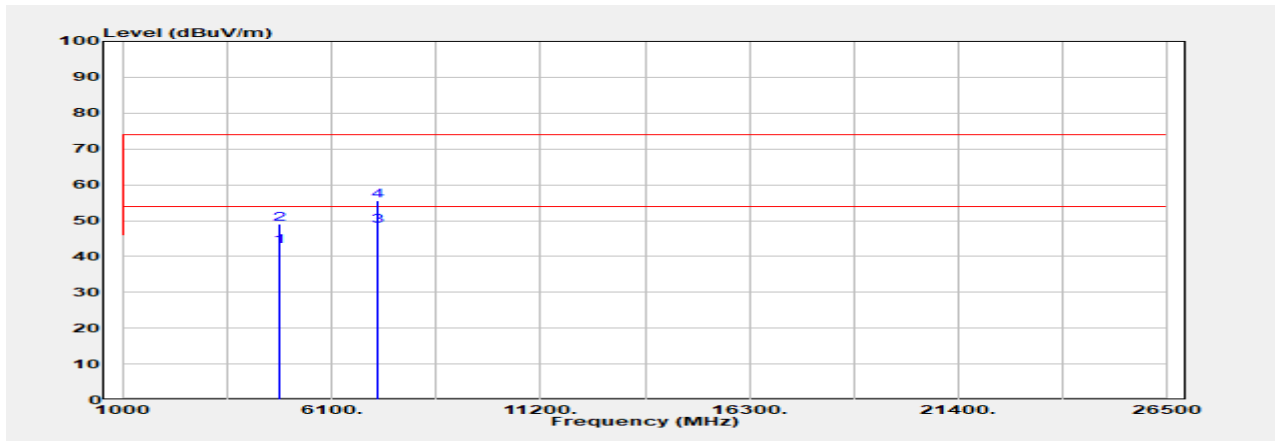

| Freq.<br>MHz | Detector<br>Mode<br>PK/QP/AVG | Spectrum<br>Reading Level<br>dBuV | Factor<br>dB | Actual<br>FS<br>dBuV/m | Limit<br>@3m<br>dBuV/m | Margin<br>dB |
|--------------|-------------------------------|-----------------------------------|--------------|------------------------|------------------------|--------------|
| 4804.000     | Average                       | 39.47                             | 3.33         | 42.80                  | 54.00                  | -11.20       |
| 4804.000     | Peak                          | 45.81                             | 3.33         | 49.15                  | 74.00                  | -24.85       |
| 7206.000     | Average                       | 39.31                             | 9.17         | 48.48                  | 54.00                  | -5.52        |
| 7206.000     | Peak                          | 46.40                             | 9.17         | 55.57                  | 74.00                  | -18.43       |

Unless otherwise stated the results shown in this test report refer only to the sample(s) tested and such sample(s) are retained for 90 days only.

除非另有說明，此報告結果僅對測試之樣品負責，同時此樣品僅保留90天。本報告未經本公司書面許可，不可部份複製。

This document is issued by the Company subject to its General Conditions of Service printed overleaf, available on request or accessible at <http://www.sgs.com.tw/Terms-and-Conditions> and for electronic format documents, subject to Terms and Conditions for Electronic Documents at <http://www.sgs.com.tw/Terms-and-Conditions>. Attention is drawn to the limitation of liability, indemnification and jurisdiction issues defined therein. Any holder of this document is advised that information contained hereon reflects the Company's findings at the time of its intervention only and within the limits of Client's instructions, if any. The Company's sole responsibility is to its Client and this document does not exonerate parties to a transaction from exercising all their rights and obligations under the transaction documents. This document cannot be reproduced except in full, without prior written approval of the Company. Any unauthorized alteration, forgery or falsification of the content or appearance of this document is unlawful and offenders may be prosecuted to the fullest extent of the law.



Report Number :TERF2405001487E2  
 Operation Mode :BLE 1M  
 Test Frequency :2442 MHz  
 Test Mode :Tx  
 EUT Pol :E2 Plane

Test Site :SAC G Chamber  
 Test Date :2024-06-04  
 Temp./Humi. :23.4°C/56%  
 Antenna Pol. :Vertical  
 Engineer :Jacky Chen

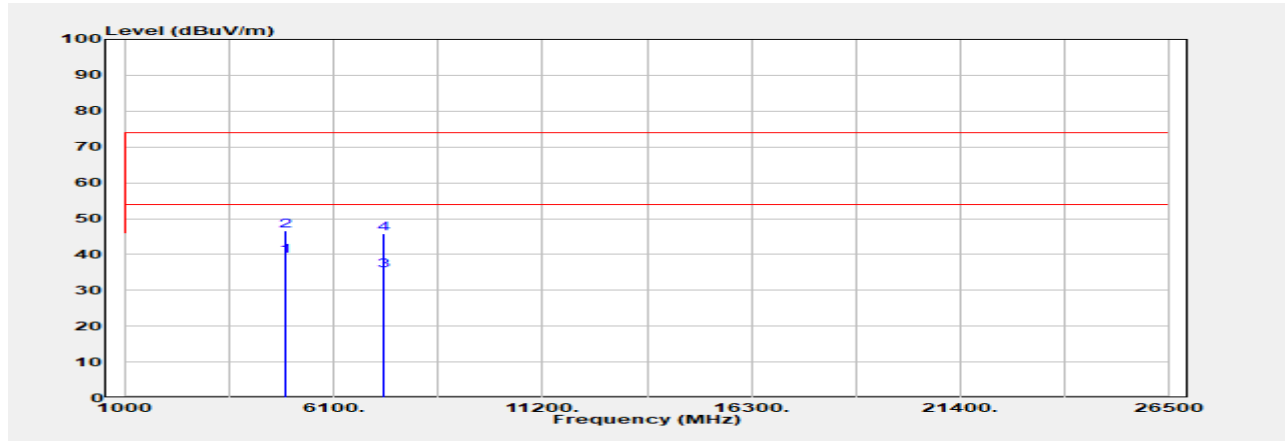

| Freq.<br>MHz | Detector<br>Mode<br>PK/QP/AVG | Spectrum<br>Reading Level<br>dBuV | Factor<br>dB | Actual<br>FS<br>dBuV/m | Limit<br>@3m<br>dBuV/m | Margin<br>dB |
|--------------|-------------------------------|-----------------------------------|--------------|------------------------|------------------------|--------------|
| 4884.000     | Average                       | 35.92                             | 3.53         | 39.45                  | 54.00                  | -14.55       |
| 4884.000     | Peak                          | 42.96                             | 3.53         | 46.49                  | 74.00                  | -27.51       |
| 7326.000     | Average                       | 25.62                             | 9.81         | 35.43                  | 54.00                  | -18.57       |
| 7326.000     | Peak                          | 35.87                             | 9.81         | 45.67                  | 74.00                  | -28.33       |

Unless otherwise stated the results shown in this test report refer only to the sample(s) tested and such sample(s) are retained for 90 days only.

除非另有說明，此報告結果僅對測試之樣品負責，同時此樣品僅保留90天。本報告未經本公司書面許可，不可部份複製。

This document is issued by the Company subject to its General Conditions of Service printed overleaf, available on request or accessible at <http://www.sgs.com.tw/Terms-and-Conditions> and for electronic format documents, subject to Terms and Conditions for Electronic Documents at <http://www.sgs.com.tw/Terms-and-Conditions>. Attention is drawn to the limitation of liability, indemnification and jurisdiction issues defined therein. Any holder of this document is advised that information contained hereon reflects the Company's findings at the time of its intervention only and within the limits of Client's instructions, if any. The Company's sole responsibility is to its Client and this document does not exonerate parties to a transaction from exercising all their rights and obligations under the transaction documents. This document cannot be reproduced except in full, without prior written approval of the Company. Any unauthorized alteration, forgery or falsification of the content or appearance of this document is unlawful and offenders may be prosecuted to the fullest extent of the law.

|                |                   |              |                |
|----------------|-------------------|--------------|----------------|
| Report Number  | :TERF2405001487E2 | Test Site    | :SAC G Chamber |
| Operation Mode | :BLE 1M           | Test Date    | :2024-06-04    |
| Test Frequency | :2442 MHz         | Temp./Humi.  | :23.4°C/56%    |
| Test Mode      | :Tx               | Antenna Pol. | :Horizontal    |
| EUT Pol        | :E2 Plane         | Engineer     | :Jacky Chen    |

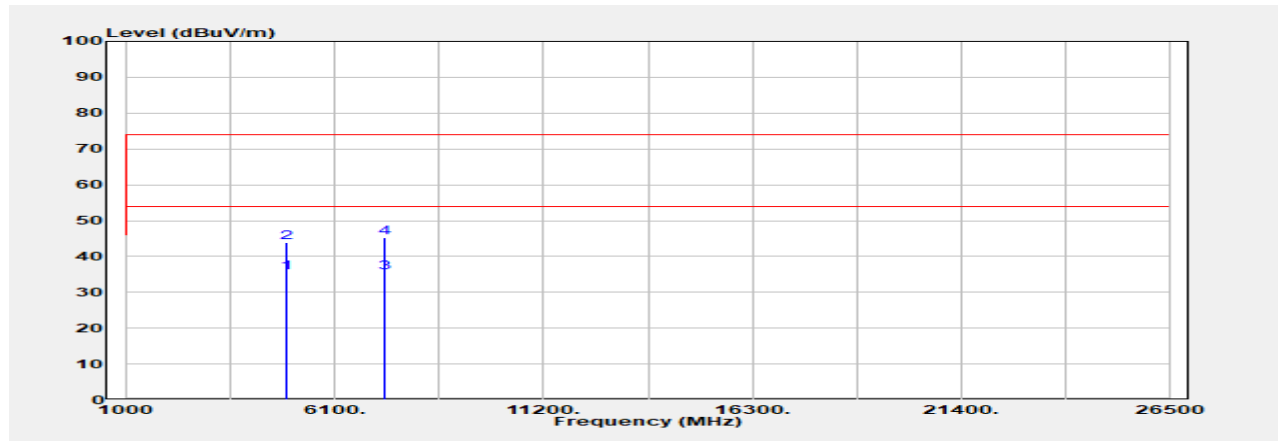

| Freq.<br>MHz | Detector<br>Mode<br>PK/QP/AVG | Spectrum<br>Reading Level<br>dBuV | Factor<br>dB | Actual<br>FS<br>dBuV/m | Limit<br>@3m<br>dBuV/m | Margin<br>dB |
|--------------|-------------------------------|-----------------------------------|--------------|------------------------|------------------------|--------------|
| 4884.000     | Average                       | 32.00                             | 3.53         | 35.53                  | 54.00                  | -18.47       |
| 4884.000     | Peak                          | 40.35                             | 3.53         | 43.89                  | 74.00                  | -30.11       |
| 7326.000     | Average                       | 25.78                             | 9.81         | 35.58                  | 54.00                  | -18.42       |
| 7326.000     | Peak                          | 35.52                             | 9.81         | 45.32                  | 74.00                  | -28.68       |

Unless otherwise stated the results shown in this test report refer only to the sample(s) tested and such sample(s) are retained for 90 days only.

除非另有說明，此報告結果僅對測試之樣品負責，同時此樣品僅保留90天。本報告未經本公司書面許可，不可部份複製。

This document is issued by the Company subject to its General Conditions of Service printed overleaf, available on request or accessible at <http://www.sgs.com.tw/Terms-and-Conditions> and for electronic format documents, subject to Terms and Conditions for Electronic Documents at <http://www.sgs.com.tw/Terms-and-Conditions>. Attention is drawn to the limitation of liability, indemnification and jurisdiction issues defined therein. Any holder of this document is advised that information contained hereon reflects the Company's findings at the time of its intervention only and within the limits of Client's instructions, if any. The Company's sole responsibility is to its Client and this document does not exonerate parties to a transaction from exercising all their rights and obligations under the transaction documents. This document cannot be reproduced except in full, without prior written approval of the Company. Any unauthorized alteration, forgery or falsification of the content or appearance of this document is unlawful and offenders may be prosecuted to the fullest extent of the law.

|                |                   |              |                |
|----------------|-------------------|--------------|----------------|
| Report Number  | :TERF2405001487E2 | Test Site    | :SAC G Chamber |
| Operation Mode | :BLE 1M           | Test Date    | :2024-06-04    |
| Test Frequency | :2480 MHz         | Temp./Humi.  | :23.4°C/56%    |
| Test Mode      | :Tx               | Antenna Pol. | :Vertical      |
| EUT Pol        | :E2 Plane         | Engineer     | :Jacky Chen    |

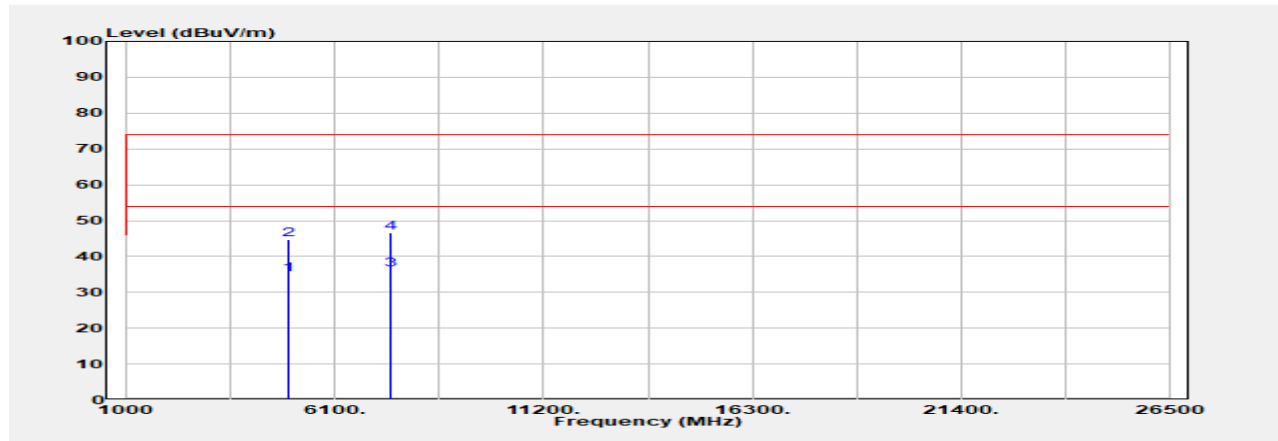

| Freq.<br>MHz | Detector<br>Mode<br>PK/QP/AVG | Spectrum<br>Reading Level<br>dBuV | Factor<br>dB | Actual<br>FS<br>dBuV/m | Limit<br>@3m<br>dBuV/m | Margin<br>dB |
|--------------|-------------------------------|-----------------------------------|--------------|------------------------|------------------------|--------------|
| 4960.000     | Average                       | 31.11                             | 3.86         | 34.96                  | 54.00                  | -19.04       |
| 4960.000     | Peak                          | 40.73                             | 3.86         | 44.59                  | 74.00                  | -29.41       |
| 7440.000     | Average                       | 26.22                             | 10.14        | 36.36                  | 54.00                  | -17.64       |
| 7440.000     | Peak                          | 36.52                             | 10.14        | 46.66                  | 74.00                  | -27.34       |

Unless otherwise stated the results shown in this test report refer only to the sample(s) tested and such sample(s) are retained for 90 days only.

除非另有說明，此報告結果僅對測試之樣品負責，同時此樣品僅保留90天。本報告未經本公司書面許可，不可部份複製。

This document is issued by the Company subject to its General Conditions of Service printed overleaf, available on request or accessible at <http://www.sgs.com.tw/Terms-and-Conditions> and for electronic format documents, subject to Terms and Conditions for Electronic Documents at <http://www.sgs.com.tw/Terms-and-Conditions>. Attention is drawn to the limitation of liability, indemnification and jurisdiction issues defined therein. Any holder of this document is advised that information contained hereon reflects the Company's findings at the time of its intervention only and within the limits of Client's instructions, if any. The Company's sole responsibility is to its Client and this document does not exonerate parties to a transaction from exercising all their rights and obligations under the transaction documents. This document cannot be reproduced except in full, without prior written approval of the Company. Any unauthorized alteration, forgery or falsification of the content or appearance of this document is unlawful and offenders may be prosecuted to the fullest extent of the law.

|                |                   |              |                |
|----------------|-------------------|--------------|----------------|
| Report Number  | :TERF2405001487E2 | Test Site    | :SAC G Chamber |
| Operation Mode | :BLE 1M           | Test Date    | :2024-06-04    |
| Test Frequency | :2480 MHz         | Temp./Humi.  | :23.4°C/56%    |
| Test Mode      | :Tx               | Antenna Pol. | :Horizontal    |
| EUT Pol        | :E2 Plane         | Engineer     | :Jacky Chen    |

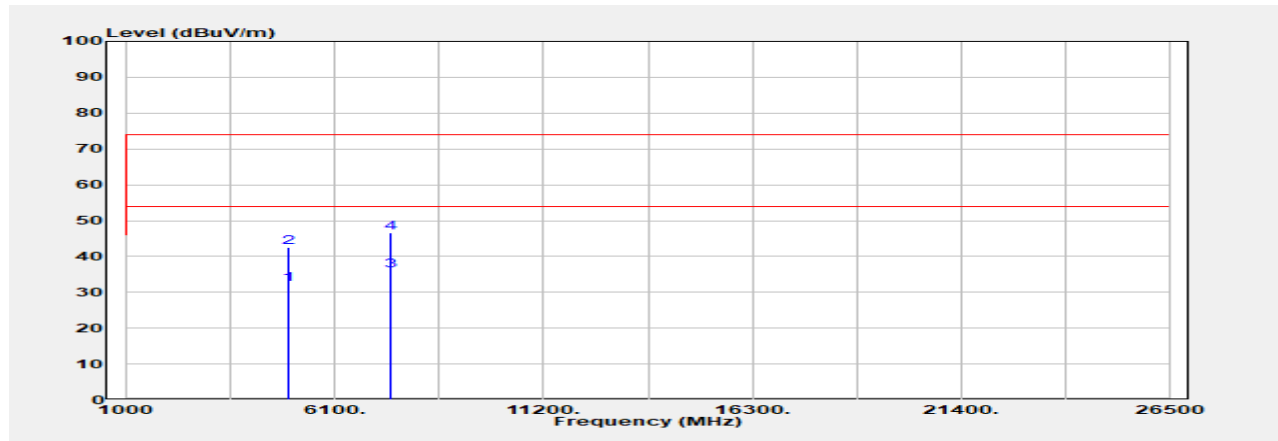

| Freq.<br>MHz | Detector<br>Mode<br>PK/QP/AVG | Spectrum<br>Reading Level<br>dBuV | Factor<br>dB | Actual<br>FS<br>dBuV/m | Limit<br>@3m<br>dBuV/m | Margin<br>dB |
|--------------|-------------------------------|-----------------------------------|--------------|------------------------|------------------------|--------------|
| 4960.000     | Average                       | 28.37                             | 3.86         | 32.23                  | 54.00                  | -21.77       |
| 4960.000     | Peak                          | 38.69                             | 3.86         | 42.55                  | 74.00                  | -31.45       |
| 7440.000     | Average                       | 26.02                             | 10.14        | 36.16                  | 54.00                  | -17.84       |
| 7440.000     | Peak                          | 36.42                             | 10.14        | 46.55                  | 74.00                  | -27.45       |

Unless otherwise stated the results shown in this test report refer only to the sample(s) tested and such sample(s) are retained for 90 days only.

除非另有說明，此報告結果僅對測試之樣品負責，同時此樣品僅保留90天。本報告未經本公司書面許可，不可部份複製。

This document is issued by the Company subject to its General Conditions of Service printed overleaf, available on request or accessible at <http://www.sgs.com.tw/Terms-and-Conditions> and for electronic format documents, subject to Terms and Conditions for Electronic Documents at <http://www.sgs.com.tw/Terms-and-Conditions>. Attention is drawn to the limitation of liability, indemnification and jurisdiction issues defined therein. Any holder of this document is advised that information contained hereon reflects the Company's findings at the time of its intervention only and within the limits of Client's instructions, if any. The Company's sole responsibility is to its Client and this document does not exonerate parties to a transaction from exercising all their rights and obligations under the transaction documents. This document cannot be reproduced except in full, without prior written approval of the Company. Any unauthorized alteration, forgery or falsification of the content or appearance of this document is unlawful and offenders may be prosecuted to the fullest extent of the law.

## 12 POWER SPECTRAL DENSITY

### 12.1 Standard Applicable:

Per Part 15.247 (e)

The power spectral density conducted from the intentional radiator to the antenna shall not be greater than 8dBm in any 3 kHz band during any time interval of continuous transmission.

### 12.2 Test Setup

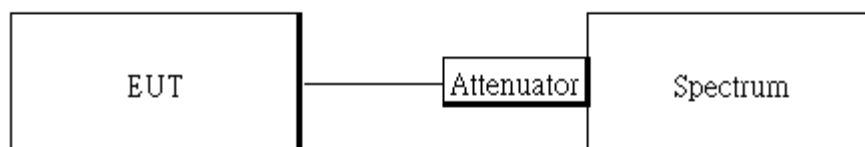

### 12.3 Measurement Procedure:

1. Set analyzer center frequency to DTS channel center frequency.
2. The testing follows the Measurement Procedure of FCC KDB 558074 D01 DTS Meas. Guidance.
3. Set the span to 1.5 times the DTS channel bandwidth.
4. Set the RBW = 3 kHz. & the VBW = 10 kHz
5. Detector = peak.
6. Sweep time = auto couple.
7. Trace mode = max hold.
8. Allow trace to fully stabilize.
9. Use the peak marker function to determine the maximum amplitude level.

### 12.4 Measurement Result:

#### BLE 1M mode

| Frequency (MHz) | RF Power Density (dBm/3kHz) | Maximum Limit (dBm/3kHz) | Result |
|-----------------|-----------------------------|--------------------------|--------|
| 2402            | -7.14                       | 8                        | PASS   |
| 2442            | -7.12                       | 8                        | PASS   |
| 2480            | -5.52                       | 8                        | PASS   |

**\*Note:**

**1.cable loss as 10.8dB that offsets in the spectrum**

Unless otherwise stated the results shown in this test report refer only to the sample(s) tested and such sample(s) are retained for 90 days only.  
 除非另有說明，此報告結果僅對測試之樣品負責，同時此樣品僅保留90天。本報告未經本公司書面許可，不可部份複製。

This document is issued by the Company subject to its General Conditions of Service printed overleaf, available on request or accessible at <http://www.sgs.com.tw/Terms-and-Conditions> and for electronic format documents, subject to Terms and Conditions for Electronic Documents at <http://www.sgs.com.tw/Terms-and-Conditions>. Attention is drawn to the limitation of liability, indemnification and jurisdiction issues defined therein. Any holder of this document is advised that information contained hereon reflects the Company's findings at the time of its intervention only and within the limits of Client's instructions, if any. The Company's sole responsibility is to its Client and this document does not exonerate parties to a transaction from exercising all their rights and obligations under the transaction documents. This document cannot be reproduced except in full, without prior written approval of the Company. Any unauthorized alteration, forgery or falsification of the content or appearance of this document is unlawful and offenders may be prosecuted to the fullest extent of the law.

PSD\_BLE 1M\_LowCH00-2402MHz

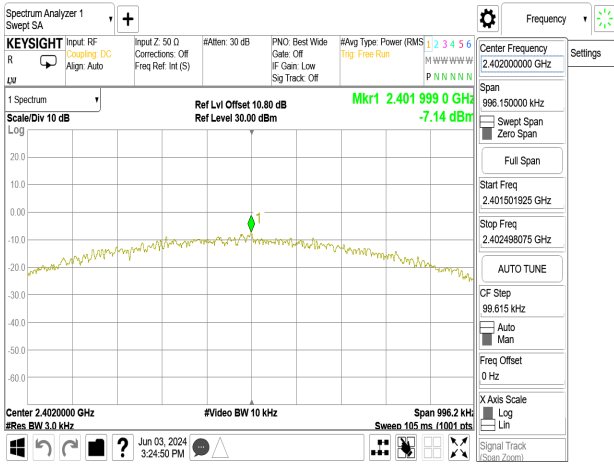

PSD\_BLE 1M\_MidCH20-2442MHz

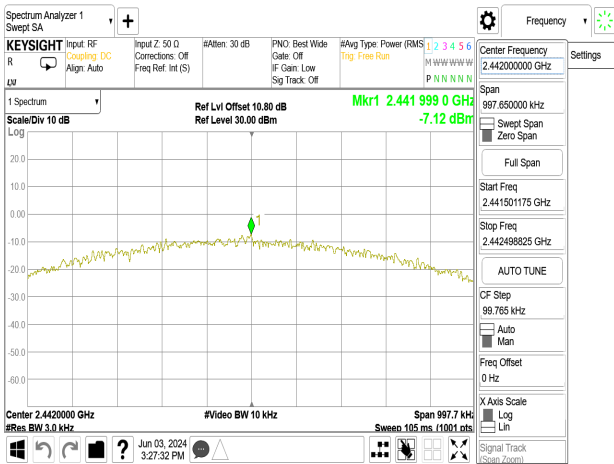

PSD\_BLE 1M\_HighCH39-2480MHz

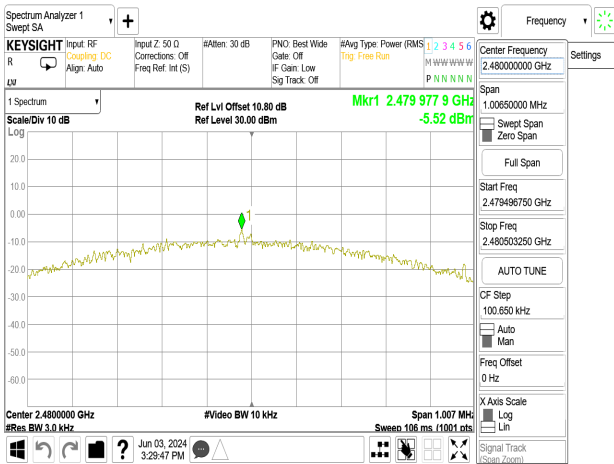

Unless otherwise stated the results shown in this test report refer only to the sample(s) tested and such sample(s) are retained for 90 days only.

除非另有說明，此報告結果僅對測試之樣品負責，同時此樣品僅保留90天。本報告未經本公司書面許可，不可部份複製。

This document is issued by the Company subject to its General Conditions of Service printed overleaf, available on request or accessible at <http://www.sgs.com.tw/Terms-and-Conditions> and for electronic format documents, subject to Terms and Conditions for Electronic Documents at <http://www.sgs.com.tw/Terms-and-Conditions>. Attention is drawn to the limitation of liability, indemnification and jurisdiction issues defined therein. Any holder of this document is advised that information contained hereon reflects the Company's findings at the time of its intervention only and within the limits of Client's instructions, if any. The Company's sole responsibility is to its Client and this document does not exonerate parties to a transaction from exercising all their rights and obligations under the transaction documents. This document cannot be reproduced except in full, without prior written approval of the Company. Any unauthorized alteration, forgery or falsification of the content or appearance of this document is unlawful and offenders may be prosecuted to the fullest extent of the law.

## 13 ANTENNA REQUIREMENT

### 13.1 Standard Applicable:

An intentional radiator shall be designed to ensure that no antenna other than that furnished by the responsible party shall be used with the device. The use of a permanently attached antenna or of an antenna that uses a unique coupling to the intentional radiator shall be considered sufficient to comply with the provisions of this section. The manufacturer may design the unit so that a broken antenna can be replaced by the user, but the use of a standard antenna jack or electrical connector is prohibited. This requirement does not apply to carrier current devices or to devices operated under the provisions of §§ 15.211, 15.213, 15.217, 15.219, 15.221, or § 15.236. Further, this requirement does not apply to intentional radiators that must be professionally installed, such as perimeter protection systems and some field disturbance sensors, or to other intentional radiators which, in accordance with § 15.31(d), must be measured at the installation site. However, the installer shall be responsible for ensuring that the proper antenna is employed so that the limits in this part are not exceeded.

### 13.2 Antenna Connected Construction:

The antenna complies with this requirement and no consideration of replacement. Please see EUT photo for details.

*~ End of Report ~*

Unless otherwise stated the results shown in this test report refer only to the sample(s) tested and such sample(s) are retained for 90 days only.  
除非另有說明，此報告結果僅對測試之樣品負責，同時此樣品僅保留90天。本報告未經本公司書面許可，不可部份複製。

This document is issued by the Company subject to its General Conditions of Service printed overleaf, available on request or accessible at <http://www.sgs.com.tw/Terms-and-Conditions> and for electronic format documents, subject to Terms and Conditions for Electronic Documents at <http://www.sgs.com.tw/Terms-and-Conditions>. Attention is drawn to the limitation of liability, indemnification and jurisdiction issues defined therein. Any holder of this document is advised that information contained hereon reflects the Company's findings at the time of its intervention only and within the limits of Client's instructions, if any. The Company's sole responsibility is to its Client and this document does not exonerate parties to a transaction from exercising all their rights and obligations under the transaction documents. This document cannot be reproduced except in full, without prior written approval of the Company. Any unauthorized alteration, forgery or falsification of the content or appearance of this document is unlawful and offenders may be prosecuted to the fullest extent of the law.