



# TEST REPORT

Report Reference No..... : TRE1611014201 R/C.....: 93883  
 FCC ID..... : Y9ZMT4D1050  
 Applicant's name..... : 3M Company  
 Address..... : Personal Safety Division, 3M Center, Building 235-2NW-70, St. Paul, Minnesota, United States  
 Manufacturer..... : 3M SVENSKA AB  
 Address..... : Malmstengatan 19, SE331 02 Varnamo, Sweden  
 Test item description ..... : 3M™ PELTOR™ WS™ LiteCom PRO III  
 Trade Mark ..... : 3M PELTOR  
 Model/Type reference..... : MT73H7A4D10EU  
 Listed Model(s) ..... : See annex  
 Standard ..... : FCC Part 90/FCC Part 15B/FCC Part 2  
 Date of receipt of test sample..... : Nov. 25, 2016  
 Date of testing..... : Nov. 28, 2016 - Jan. 16, 2017  
 Date of issue..... : Jan. 16, 2017  
 Result..... : PASS

Compiled by  
 ( position+printed name+signature)..: File administrators Shayne Zhu

Supervised by  
 ( position+printed name+signature)..: Project Engineer Cary Luo

Approved by  
 ( position+printed name+signature)..: RF Manager Hans Hu

Testing Laboratory Name ..... : Shenzhen Huatongwei International Inspection Co., Ltd.

Address..... : 1/F, Bldg 3, Hongfa Hi-tech Industrial Park, Genyu Road, Tianliao, Gongming, Shenzhen, China

**Shenzhen Huatongwei International Inspection Co., Ltd. All rights reserved.**

This publication may be reproduced in whole or in part for non-commercial purposes as long as the Shenzhen Huatongwei International Inspection Co., Ltd. is acknowledged as copyright owner and source of the material. Shenzhen Huatongwei International Inspection Co., Ltd. takes no responsibility for and will not assume liability for damages resulting from the reader's interpretation of the reproduced material due to its placement and context.

## Contents

|           |   |           |
|-----------|---|-----------|
| <b>1.</b> | <b><u>TEST STANDARDS AND REPORT VERSION</u></b>       | <b>3</b>  |
| 1.1.      | Test Standards  | 3         |
| 1.2.      | Report version  | 3         |
| <b>2.</b> | <b><u>TEST DESCRIPTION</u></b>                        | <b>4</b>  |
| <b>3.</b> | <b><u>SUMMARY</u></b>                                 | <b>5</b>  |
| 3.1.      | Client Information                                    | 5         |
| 3.2.      | Product Description                                   | 5         |
| 3.3.      | Test frequency list                                   | 7         |
| 3.4.      | EUT operation mode                                    | 7         |
| 3.5.      | EUT configuration                                     | 7         |
| <b>4.</b> | <b><u>TEST ENVIRONMENT</u></b>                        | <b>8</b>  |
| 4.1.      | Address of the test laboratory                        | 8         |
| 4.2.      | Test Facility   | 8         |
| 4.3.      | Environmental conditions                              | 9         |
| 4.4.      | Statement of the measurement uncertainty              | 9         |
| 4.5.      | Equipments Used during the Test                       | 10        |
| <b>5.</b> | <b><u>TEST CONDITIONS AND RESULTS</u></b>             | <b>12</b> |
| 5.1.      | Maximum Transmitter Power(Effective Radiated Power)   | 12        |
| 5.2.      | Occupied Bandwidth                                    | 15        |
| 5.3.      | Emission Mask   | 19        |
| 5.4.      | Modulation Limit                                      | 22        |
| 5.5.      | Audio Frequency Response                              | 24        |
| 5.6.      | Frequency Stability Test                              | 26        |
| 5.7.      | Transmitter Frequency Behaviour                       | 29        |
| 5.8.      | Spurious Emission on Antenna Port                     | 32        |
| 5.9.      | Transmitter Radiated Spurious Emission                | 33        |
| 5.10.     | Conducted Emissions                                   | 38        |
| 5.11.     | Radiated Emission                                     | 41        |
| <b>6.</b> | <b><u>TEST SETUP PHOTOS OF THE EUT</u></b>            | <b>45</b> |
| <b>7.</b> | <b><u>EXTERNAL AND INTERNAL PHOTOS OF THE EUT</u></b> | <b>46</b> |

## 1. TEST STANDARDS AND REPORT VERSION

### 1.1. Test Standards

The tests were performed according to following standards:

[FCC Rules Part 90: 2016](#) Private land mobile radio services.

[TIA/EIA 603 D: June 2010](#) Land Mobile FM or PM Communications Equipment Measurement and Performance Standards.

[FCC Part 15 Subpart B: 2016](#) Unintentional Radiators

[FCC Part 2: 2014](#) Frequency allocations and radio treaty matters, general rules and regulations.

[KDB579009 D03 v01](#): Applications Part 90 Refarming Bands.

[KDB971168 D01 v02r02](#): MEASUREMENT GUIDANCE FOR CERTIFICATION OF LICENSED DIGITAL TRANSMITTERS

### 1.2. Report version

| Version No. | Date of issue | Description |
|-------------|---------------|-------------|
| 00          | Jan. 16, 2017 | Original    |
|             |               |             |
|             |               |             |
|             |               |             |
|             |               |             |

Annex:

MT73H7P3E4D10EU,MT73H7B4D10EU,MT73H7F4D10EU-50,MT73H7P3E4D10EU-50,

MT73H7B4D10EU-50,MT73H7A4D10NA, MT73H7P3E4D10NA, MT73H7B4D10NA,

MT73H7F4D10NA-50, MT73H7P3E4D10NA-50,MT73H7B4D10NA-50

## 2. Test Description

| <b>Transmitter Requirement</b>         |   |                                     |                                     |
|--|---|-------------------------------------|-------------------------------------|
| Test item                              | Standards requirement                             | Result                              |                                     |
|  |   | Pass                                | N/A                                 |
| Maximum Transmitter Power              | FCC Part 90.205, FCC Part 2.1046                  | <input checked="" type="checkbox"/> |                                     |
| Modulation Characteristic              | FCC Part 90.207, FCC Part 2.1047                  | <input checked="" type="checkbox"/> |                                     |
| Occupied Bandwidth                     | FCC Part 90.209, FCC Part 90.210, FCC Part 2.1049 | <input checked="" type="checkbox"/> |                                     |
| Emission Mask                          | FCC Part 90.209, FCC Part 90.210, FCC Part 2.1049 | <input checked="" type="checkbox"/> |                                     |
| Frequency Stability                    | FCC Part 90.213, FCC Part 2.1055                  | <input checked="" type="checkbox"/> |                                     |
| Transmitter Frequency Behavior         | FCC Part 90.214                                   | <input checked="" type="checkbox"/> |                                     |
| Transmitter Radiated Spurious Emission | FCC Part 90.210, FCC Part 2.1053                  | <input checked="" type="checkbox"/> |                                     |
| Spurious Emission On Antenna Port      | FCC Part 90.210, FCC Part 2.1051                  |                                     | <input checked="" type="checkbox"/> |
| <b>Receiver Requirement</b>            |   |                                     |                                     |
| Test item                              | Standards requirement                             | Result                              |                                     |
|  |   | Pass                                | N/A                                 |
| Conducted Emission                     | FCC Part 15.107                                   | <input checked="" type="checkbox"/> |                                     |
| Radiated Emission                      | FCC Part 15.109                                   | <input checked="" type="checkbox"/> |                                     |

### 3. SUMMARY

#### 3.1. Client Information

|               |  |
|---------------|--|
| Applicant:    | 3M Company   |
| Address:      | Personal Safety Division, 3M Center, Building 235-2NW-70, St. Paul, Minnesota, United States |
| Manufacturer: | 3M SVENSKA AB  |
| Address:      | Malmstensgatan 19, SE331 02 Varnamo, Sweden  |

#### 3.2. Product Description

|                                     |   |   |
|-------------------------------------|---|---|
| Name of EUT:                        | 3M™ PELTOR™ WS™ LiteCom PRO III   |   |
| Trade mark:                         | 3M PELTOR   |   |
| Model/Type reference:               | MT73H7A4D10EU   |   |
| Listed mode(s):                     | See annex   |   |
| Power supply:                       | DC 3.7V   |   |
| Battery information (Type 1):       | Model:ACK08<br>3.7Vd.c.,1350mAh,5Wh                                       |   |
| Battery information (Type 2):       | Model:ACK082<br>3.7Vd.c.,1350mAh,5Wh                                      |   |
| Battery information (Type 3):       | Model:ACK081<br>3.7Vd.c.,1800mAh,6.7Wh                                    |   |
| Charger information:                | -   |   |
| Adapter information:                | Model:EMSA050100<br>Input:100-240Va.c.,50-60Hz,0.2A<br>Output:5Vd.c.,1.0A |   |
|                                     |   |   |
| Operation Frequency Range:          | From 406.1MHz to 470MHz   |   |
| Rated Output Power:                 | High Power: 200mW (23.00dBm)/Low Power: 10mW (10.00dBm)                   |   |
| Modulation Type:                    | Analog Voice:   | FM  |
|                                     | Digital Voice<br>/Digital Data:   | 4FSK  |
| Digital Type:                       | DMR   |   |
| Channel Separation:                 | Analog Voice:   | <input checked="" type="checkbox"/> 12.5kHz   |
|                                     | Digital Voice<br>/Digital Data:   | <input checked="" type="checkbox"/> 12.5kHz <input type="checkbox"/> 6.25kHz  |
| Emission Designator:                | Analog Voice:   | <input checked="" type="checkbox"/> 12.5kHz Channel Separation: 9K94F3E<br><input type="checkbox"/> 25kHz Channel Separation: ---   |
|                                     | Digital Voice& Data:  | <input checked="" type="checkbox"/> 12.5kHz Channel Separation: 7K71FXW<br><input type="checkbox"/> 6.25kHz Channel Separation: --- |
|                                     | Digital Data:   | <input checked="" type="checkbox"/> 12.5kHz Channel Separation: 7K71FXD<br><input type="checkbox"/> 6.25kHz Channel Separation: --- |
| Support data rate:                  | 9.6kbps   |   |
| Antenna Type:                       | Integral  |   |
| Maximum Transmitter Power<br>(ERP): | Digital   | 200mW for 12.5kHz Channel Separation  |
|                                     | Analog  | 200mW for 12.5kHz Channel Separation  |

## Note:

- 1)The product has the same digital working characters when operating in both two digitized voice/data mode. So only one set of test results for digital modulation modes are provided in this test report.
- 2)This equipment is capable of supporting a minimum data rate of 4800 bits per second per 6.25 kHz of channel bandwidth. DMR interphone's bandwidth is 12.5 kHz, and it has a double time slot, one is the speech time slot, one is the data time slot, just language sequence is satisfied with 4800 bps/6.25 kHz BW.

## Remark:

We tested all models, but recorded the worst case at Type 3.

The charging cable has two models: AL2AI and AL2AH. 3 batteries with 3 models: ACK081, ACK08 and ACK 082. The cable matched with 3 batteries as following when testing:

a. EUT+ACK081+AL2AI

b. EUT+ACK08/ ACK082+AL2AH

The only difference between ACK08 and ACK 082 is the model name, other data are the same.

We recorded the worst case at EUT+ACK08+AL2AH.

### 3.3. Test frequency list

| Mode    | Modulation | Operation Frequency Range | Test Frequency (MHz) |          |
|---------|------------|---------------------------|----------------------|----------|
| Analog  | FM         | 406.1MHz~420MHz           | CH <sub>L</sub>      | 406.1125 |
|         |            |                           | CH <sub>M</sub>      | 413.0500 |
|         |            |                           | CH <sub>H</sub>      | 419.9875 |
|         |            | 420MHz~470MHz             | CH <sub>L</sub>      | 421.0125 |
|         |            |                           | CH <sub>M</sub>      | 445.0000 |
|         |            |                           | CH <sub>H</sub>      | 469.9875 |
| Digital | 4FSK       | 406.1MHz~420MHz           | CH <sub>L</sub>      | 406.1125 |
|         |            |                           | CH <sub>M</sub>      | 413.0500 |
|         |            |                           | CH <sub>H</sub>      | 419.9875 |
|         |            | 420MHz~470MHz             | CH <sub>L</sub>      | 421.0125 |
|         |            |                           | CH <sub>M</sub>      | 445.0000 |
|         |            |                           | CH <sub>H</sub>      | 469.9875 |

**Note:**

In section KDB 634817 D01 Sections II(f)1) and 2):

- (1) Test only on the allowed frequencies.
- (2) Test at least one frequency in each band for each rule part applied under and ensure the device is capable of operating on the frequency under each rule part. This requirement may result in testing on multiple frequencies. Testing on one frequency may be acceptable if multiple listed bands for a rule part with a continuous frequency range are split to remove a conflict with other rules and the technical requirements in the split bands are the same. Additional requirements for RF exposure may apply.

### 3.4. EUT operation mode

| Test mode | Transmitting | Receiving | Power level |     | Digital | Analog  |
|-----------|--------------|-----------|-------------|-----|---------|---------|
|           |              |           | High        | Low | 12.5kHz | 12.5kHz |
| TX1       | √            |           | √           |     | √       |         |
| TX2       | √            |           |             | √   | √       |         |
| TX3       | √            |           | √           |     |         | √       |
| TX4       | √            |           |             | √   |         | √       |
| RX1       |              | √         |             |     | √       |         |
| RX2       |              | √         |             |     |         | √       |

√: is operation mode.

### 3.5. EUT configuration

The following peripheral devices and interface cables were connected during the measurement:

- - supplied by the manufacturer
- - supplied by the lab

|               |                |              |
|---------------|----------------|--------------|
| ● Power Cable | Length (m) :   | /            |
|               | Shield :       | Unshielded   |
|               | Detachable :   | Undetachable |
| ○ Multimeter  | Manufacturer : | /            |
|               | Model No. :    | /            |

## **4. TEST ENVIRONMENT**

### **4.1. Address of the test laboratory**

Laboratory: Shenzhen Huatongwei International Inspection Co., Ltd.

Address: 1/F, Bldg 3, Hongfa Hi-tech Industrial Park, Genyu Road, Tianliao, Gongming, Shenzhen, China

Phone: 86-755-26748019 Fax: 86-755-26748089

### **4.2. Test Facility**

The test facility is recognized, certified, or accredited by the following organizations:

#### **CNAS-Lab Code: L1225**

Shenzhen Huatongwei International Inspection Co., Ltd. has been assessed and proved to be in compliance with CNAS-CL01 Accreditation Criteria for Testing and Calibration Laboratories

(identical to ISO/IEC17025: 2005 General Requirements) for the Competence of Testing and Calibration Laboratories, Date of Registration: February 28, 2015. Valid time is until February 27, 2018.

#### **A2LA-Lab Cert. No. 3902.01**

Shenzhen Huatongwei International Inspection Co., Ltd. EMC Laboratory has been accredited by A2LA for technical competence in the field of electrical testing, and proved to be in compliance with ISO/IEC 17025: 2005 General Requirements for the Competence of Testing and Calibration Laboratories and any additional program requirements in the identified field of testing. Valid time is until December 31, 2016.

#### **FCC-Registration No.: 317478**

Shenzhen Huatongwei International Inspection Co., Ltd. EMC Laboratory has been registered and fully described in a report filed with the FCC (Federal Communications Commission). The acceptance letter from the FCC is maintained in our files. Registration 317478, Renewal date Jul. 18, 2014, valid time is until Jul. 18, 2017.

#### **IC-Registration No.: 5377A&5377B**

The 3m Alternate Test Site of Shenzhen Huatongwei International Inspection Co., Ltd. has been registered by Certification and Engineering Bureau of Industry Canada for the performance of radiated measurements with Registration No. 5377A on Dec. 31, 2013, valid time is until Dec. 31, 2016.

Two 3m Alternate Test Site of Shenzhen Huatongwei International Inspection Co., Ltd. has been registered by Certification and Engineering Bureau of Industry Canada for the performance of radiated measurements with Registration No. 5377B on Dec.03, 2014, valid time is until Dec.03, 2017.

#### **ACA**

Shenzhen Huatongwei International Inspection Co., Ltd. EMC Laboratory can also perform testing for the Australian C-Tick mark as a result of our A2LA accreditation.



### 4.3. Environmental conditions

| Normal Conditon    |                       |
|--------------------|-----------------------|
| Relative humidity: | 20 % to 75 %.         |
| Air Pressure:      | 950~1050mba           |
| Voltage:           | DC 3.7V, AC 120V/60Hz |

### 4.4. Statement of the measurement uncertainty

The data and results referenced in this document are true and accurate. The reader is cautioned that there may be errors within the calibration limits of the equipment and facilities. The measurement uncertainty was calculated for all measurements listed in this test report acc. to CISPR 16 - 4 „Specification for radio disturbance and immunity measuring apparatus and methods – Part 4: Uncertainty in EMC Measurements“ and is documented in the Shenzhen Huatongwei International Inspection Co., Ltd quality system acc. to DIN EN ISO/IEC 17025. Furthermore, component and process variability of devices similar to that tested may result in additional deviation. The manufacturer has the sole responsibility of continued compliance of the device.

Hereafter the best measurement capability for Shenzhen Huatongwei laboratory is reported:

| Test Items                              | Measurement Uncertainty | Notes |
|---|-------------------------|-------|
| Frequency stability                     | 25 Hz                   | (1)   |
| Transmitter power conducted             | 0.57 dB                 | (1)   |
| Transmitter power Radiated              | 2.20 dB                 | (1)   |
| Conducted spurious emission 9KHz-40 GHz | 1.60 dB                 | (1)   |
| Conducted Emission 9KHz-30MHz           | 3.39 dB                 | (1)   |
| Radiated Emission 30~1000MHz            | 4.65 dB                 | (1)   |
| Radiated Emission 1~18GHz               | 5.16 dB                 | (1)   |
| Radiated Emission 18-40GHz              | 5.54 dB                 | (1)   |
| Occupied Bandwidth                      | 35 Hz                   | (1)   |
| FM deviation                            | 25 Hz                   | (1)   |
| Audio level                             | 0.62 dB                 | (1)   |
| Low Pass Filter Response                | 0.76 dB                 | (1)   |
| Modulation Limiting                     | 0.42 %                  | (1)   |
| Transient Frequency Behavior            | 6.8 %                   | (1)   |

(1) This uncertainty represents an expanded uncertainty expressed at approximately the 95% confidence level using a coverage factor of k=1.96.

#### 4.5. Equipments Used during the Test

| Conducted Emission        |               |             |               |            |
|---------------------------|---------------|-------------|---------------|------------|
| Name of Equipment         | Manufacturer  | Model       | Serial Number | Last Cal.  |
| Artificial Mains          | Rohde&Schwarz | ESH2-Z5     | 100028        | 2016/11/13 |
| EMI Test Receiver         | Rohde&Schwarz | ESCS 30     | 100038        | 2016/11/13 |
| Pulse Limiter             | Rohde&Schwarz | ESHSZ2      | 100044        | 2016/11/13 |
| EMI Test Software         | Rohde&Schwarz | ES-K1 V1.71 | N/A           | N/A        |
| RF COMMUNICATION TEST SET | HP            | 8920A       | 3813A10206    | 2016/11/13 |
| Artificial Mains          | Rohde&Schwarz | ESH3-Z6     | 100210        | 2016/11/13 |
| Artificial Mains          | Rohde&Schwarz | ESH3-Z6     | 100211        | 2016/11/13 |
| Test cable                | ENVIROFLEX    | 3651        | 1101902       | 2016/11/13 |

| Modulation Characteristic |                     |       |               |            |
|---------------------------|---------------------|-------|---------------|------------|
| Name of Equipment         | Manufacturer        | Model | Serial Number | Last Cal.  |
| RF COMMUNICATION TEST SET | HP                  | 8920A | 3813A10206    | 2016/11/13 |
| RF Cable                  | Chengdu E-Microwave | ----  | ----          | 2016/11/13 |

| Frequency Stability       |                     |         |               |            |
|---------------------------|---------------------|---------|---------------|------------|
| Name of Equipment         | Manufacturer        | Model   | Serial Number | Last Cal.  |
| RF COMMUNICATION TEST SET | HP                  | 8920A   | 3813A10206    | 2016/11/13 |
| Signal Generator          | Rohde&Schwarz       | SMT03   | 100059        | 2016/11/13 |
| Climate Chamber           | ESPEC               | EL-10KA | 05107008      | 2016/11/13 |
| RF Cable                  | Chengdu E-Microwave | ----    | ----          | 2016/11/13 |

| Transmitter Radiated Spurious Emission |                   |             |               |            |
|--|-------------------|-------------|---------------|------------|
| Name of Equipment                      | Manufacturer      | Model       | Serial Number | Last Cal.  |
| Ultra-Broadband Antenna                | Rohde&Schwarz     | HL562       | 100015        | 2016/11/13 |
| EMI Test Receiver                      | Rohde&Schwarz     | ESI 26      | 100009        | 2016/11/13 |
| RF Test Panel                          | Rohde&Schwarz     | TS / RSP    | 335015/ 0017  | N/A        |
| HORN ANTENNA                           | Rohde&Schwarz     | HF906       | 100039        | 2016/11/13 |
| Turntable                              | ETS               | 2088        | 2149          | N/A        |
| Antenna Mast                           | ETS               | 2075        | 2346          | N/A        |
| EMI Test Software                      | Rohde&Schwarz     | ES-K1 V1.71 | N/A           | N/A        |
| RF COMMUNICATION TEST SET              | HP                | 8920A       | 3813A10206    | 2016/11/13 |
| Ultra-Broadband Antenna                | ShwarzBeck        | VULB9163    | 538           | 2016/11/13 |
| Ultra-Broadband Antenna                | ShwarzBeck        | VULB9163    | 539           | 2016/11/13 |
| HORN ANTENNA                           | ShwarzBeck        | 9120D       | 1012          | 2016/11/13 |
| HORN ANTENNA                           | ShwarzBeck        | 9120D       | 1011          | 2016/11/13 |
| TURNTABLE                              | MATURO            | TT2.0       | ----          | N/A        |
| ANTENNA MAST                           | MATURO            | TAM-4.0-P   | ----          | N/A        |
| Test cable                             | Siva Cables Italy | RG 58A/U    | W14.02        | 2016/11/13 |

| Maximum Transmitter Power & Spurious Emission On Antenna Port & Occupied Bandwidth & Emission Mask |                     |                     |               |            |
|--|---------------------|---------------------|---------------|------------|
| Name of Equipment  | Manufacturer        | Model               | Serial Number | Last Cal.  |
| Receiver   | Rohde&Schwarz       | ESI 26              | 100009        | 2016/11/13 |
| Attenuator   | R&S                 | ESH3-22             | 100449        | 2016/11/13 |
| RF COMMUNICATION TEST SET  | HP                  | 8920A               | 3813A10206    | 2016/11/13 |
| Digital Radio Test Set   | AEROFLEX            | 3920                | 299001967     | 2016/11/13 |
| High-Pass Filter   | Anritsu             | MP526B              | 6220875256    | 2016/11/13 |
| High-Pass Filter   | Anritsu             | MP526D              | 6220878392    | 2016/11/13 |
| Spectrum Analyzer  | Aglient             | E4407B              | MY44210775    | 2016/11/13 |
| Spectrum Analyzer  | Rohde&Schwarz       | FSP40               | 1164.4391.40  | 2016/11/13 |
| SPECTRUM ANALYZER  | Agilent             | E4407B              | MY44210775    | 2016/11/13 |
| Attenuator   | Chengdu E-Microwave | EMCAXX-10RNZ-3      | ----          | 2016/11/13 |
| RF Cable   | Chengdu E-Microwave | ----                | ----          | 2016/11/13 |
| Combiner   | Chengdu E-Microwave | EMPD-T-2-180-10-600 | ----          | 2016/11/13 |

| Transient Frequency Behavior |                     |          |               |            |
|------------------------------|---------------------|----------|---------------|------------|
| Name of Equipment            | Manufacturer        | Model    | Serial Number | Last Cal.  |
| Signal Generator             | Rohde&Schwarz       | SMT03    | 100059        | 2016/11/13 |
| Storage Oscilloscope         | Tektronix           | TDS3054B | B033027       | 2016/11/13 |
| RF COMMUNICATION TEST SET    | HP                  | 8920A    | 3813A10206    | 2016/11/13 |
| RF Cable                     | Chengdu E-Microwave | ----     | ----          | 2016/11/13 |

The calibration interval was one year.

## 5. TEST CONDITIONS AND RESULTS

### 5.1. Maximum Transmitter Power(Effective Radiated Power)

Applicants for licenses must request and use no more power than the actual power necessary for satisfactory operation.

#### LIMIT

##### **FCC Part 90.205, FCC Part 2.1046**

Maximum ERP is dependent upon the station's antenna HAAT and required service area.

The output power shall not exceed by more than 20 percent either the output power shown in the Radio Equipment List for transmitters included in this list or when not so listed, the manufacturer's rated output power for the particular transmitter specifically listed on the authorization.

#### TEST PROCEDURE

1. EUT was placed on a 0.8 meter high non-conductive stand at a 3 meter test distance from the receive antenna. A receiving antenna was placed on the antenna mast 3 meters from the EUT for emission measurements. The height of receiving antenna is 1.0 m. Detected emissions were maximized at each frequency by rotating the EUT through 360° and adjusting the receiving antenna polarization. The radiated emission measurements of all transmit frequencies in six channels were measured with peak detector.
2. A log-periodic antenna or double-ridged waveguide horn antenna shall be substituted in place of the EUT. The log-periodic antenna will be driven by a signal generator and the level will be adjusted till the same power value on the spectrum analyzer or receiver. The level of the spurious emissions can be calculated through the level of the signal generator, cable loss, the gain of the substitution antenna and the reading of the spectrum analyzer or receiver.
3. The EUT is then put into continuously transmitting mode at its maximum power level during the test. Set Test Receiver or Spectrum RBW=100kHz, VBW=300kHz for 30MHz to 1GHz, And the maximum value of the receiver should be recorded as (Pr).
4. The EUT shall be replaced by a substitution antenna. In the chamber, an substitution antenna for the frequency band of interest is placed at the reference point of the chamber. An RF Signal source for the frequency band of interest is connected to the substitution antenna with a cable that has been constructed to not interfere with the radiation pattern of the antenna. A power (PMea) is applied to the input of the substitution antenna, and adjust the level of the signal generator output until the value of the receiver reach the previously recorded (Pr). The power of signal source (PMea) is recorded. The test should be performed by rotating the test item and adjusting the receiving antenna polarization.
5. A amplifier should be connected to the Signal Source output port. And the cable should be connect between the Amplifier and the Substitution Antenna. The cable loss (Pcl), the Substitution Antenna Gain (Ga) and the Amplifier Gain (PAg) should be recorded after test.  
The measurement results are obtained as described below:  
Power(EIRP)=PMea- PAg - Pcl - Ga  
We used SMF100A microwave signal generator which signal level can up to 33dBm,so we not used power Amplifier for substitution test; The measurement results are amend as described below:  
Power(EIRP)=PMea- Pcl - Ga
6. This value is EIRP since the measurement is calibrated using an antenna of known gain (2.15 dBi) and known input power.
7. ERP can be calculated from EIRP by subtracting the gain of the dipole, ERP = EIRP-2.15dBi.

**TEST CONFIGURATION**

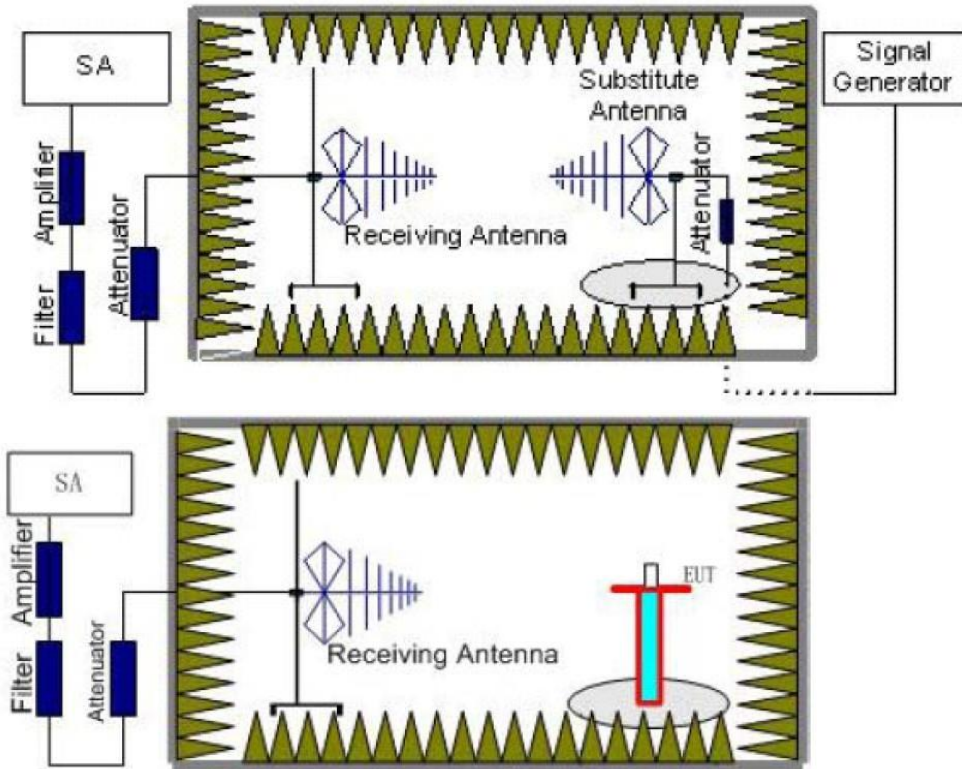

**TEST MODE:**

Please reference to the section 3.4

**TEST RESULTS**

Passed       Not Applicable

| DC 3.7V        |                      | ERP                |                  |             |        |
|----------------|----------------------|--------------------|------------------|-------------|--------|
| Operation Mode | Test Frequency (MHz) | Measured ERP (dBm) | Measured ERP (W) | Limit (W)   | Result |
| TX1            | 406.1125             | 22.84              | 0.19             | 0.16~0.24   | Pass   |
|                | 413.05               | 22.83              | 0.19             |             |        |
|                | 419.9875             | 22.87              | 0.19             |             |        |
|                | 421.0125             | 22.88              | 0.19             |             |        |
|                | 445                  | 22.95              | 0.20             |             |        |
|                | 469.9875             | 22.95              | 0.20             |             |        |
| TX2            | 406.1125             | 9.55               | 0.01             | 0.008~0.012 | Pass   |
|                | 413.05               | 9.40               | 0.01             |             |        |
|                | 419.9875             | 9.35               | 0.01             |             |        |
|                | 421.0125             | 9.36               | 0.01             |             |        |
|                | 445                  | 9.79               | 0.01             |             |        |
|                | 469.9875             | 9.39               | 0.01             |             |        |
| TX3            | 406.1125             | 22.93              | 0.20             | 0.16~0.24   | Pass   |
|                | 413.05               | 22.95              | 0.20             |             |        |
|                | 419.9875             | 22.89              | 0.19             |             |        |
|                | 421.0125             | 22.88              | 0.19             |             |        |
|                | 445                  | 22.94              | 0.20             |             |        |
|                | 469.9875             | 22.95              | 0.20             |             |        |
| TX4            | 406.1125             | 10.11              | 0.01             | 0.008~0.012 | Pass   |
|                | 413.05               | 10.14              | 0.01             |             |        |
|                | 419.9875             | 10.18              | 0.01             |             |        |
|                | 421.0125             | 10.19              | 0.01             |             |        |
|                | 445                  | 10.33              | 0.01             |             |        |
|                | 469.9875             | 10.15              | 0.01             |             |        |

## 5.2. Occupied Bandwidth

The occupied bandwidth, that is the frequency bandwidth such that, below its lower and above its upper frequency limits.

### LIMIT

#### FCC Part 90.209, FCC Part 90.210, FCC Part 2.1049

| Frequency band (MHz) | Channel spacing (kHz) | Authorized bandwidth (kHz) |
|----------------------|-----------------------|----------------------------|
| Below 252            |                       |                            |
| 25-50                | 20                    | 20                         |
| 72-76                | 20                    | 20                         |
| 150-174              | 17.5                  | 1 320/11.25/6              |
| 216-2205             | 6.25                  | 20/11.25/6                 |
| 220-222              | 5                     | 4                          |
| 406-5122             | 16.25                 | 1 320/11.25/6              |
| 806-809/851-854      | 12.5                  | 20                         |
| 809-824/854-869      | 25                    | 20                         |
| 896-901/935-940      | 12.5                  | 13.6                       |
| 902-9284             |                       |                            |
| 929-930              | 25                    | 20                         |
| 1427-14325           | 12.5                  | 12.5                       |
| 32450-2483.52        |                       |                            |
| Above 25002          |                       |                            |

### TEST CONFIGURATION

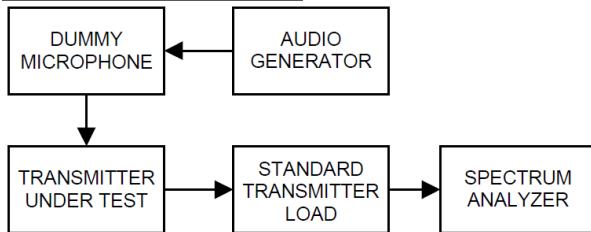

### TEST PROCEDURE

- 1 The EUT was modulated by 2.5kHz sine wave audio signal; the level of the audio signal employed is 16dB greater than that necessary to produce 50% of rated system deviation. Rated system deviation is 2.5 kHz for 12.5kHz channel spacing).
- 2 Spectrum set as follow:  
Centre frequency = fundamental frequency, span=50kHz for 12.5kHz channel spacing,  
RBW=100Hz, VBW=300Hz, Sweep = auto,  
Detector function = peak, Trace = max hold
- 3 Set 99% Occupied Bandwidth and 26dB Occupied Bandwidth
- 4 Measure and record the results in the test report.

### TEST MODE:

Please reference to the section 3.4

### TEST RESULTS

Passed       Not Applicable

Note: have pre-tested TX1 to TX4 mode, record the worst case mode TX1 and TX3 on the report.

| Operation Mode | Test Frequency (MHz) | Occupied Bandwidth (kHz) |       | Limit(kHz) | Result |
|----------------|----------------------|--------------------------|-------|------------|--------|
|                |                      | 99%                      | 26dB  |            |        |
| TX1            | 406.1125             | 7.71                     | 9.59  | ≤11.25     | Pass   |
|                | 413.05               | 7.67                     | 9.59  |            |        |
|                | 419.9875             | 7.67                     | 10.43 |            |        |
|                | 421.0125             | 7.63                     | 10.35 |            |        |
|                | 445                  | 7.47                     | 9.52  |            |        |
|                | 469.9875             | 7.51                     | 9.56  |            |        |
| TX3            | 406.1125             | 5.19                     | 10.13 | ≤11.25     | Pass   |
|                | 413.05               | 5.24                     | 10.10 |            |        |
|                | 419.9875             | 5.19                     | 10.16 |            |        |
|                | 421.0125             | 5.24                     | 10.14 |            |        |
|                | 445                  | 5.19                     | 10.16 |            |        |
|                | 469.9875             | 5.19                     | 10.14 |            |        |



Test plot as follows:

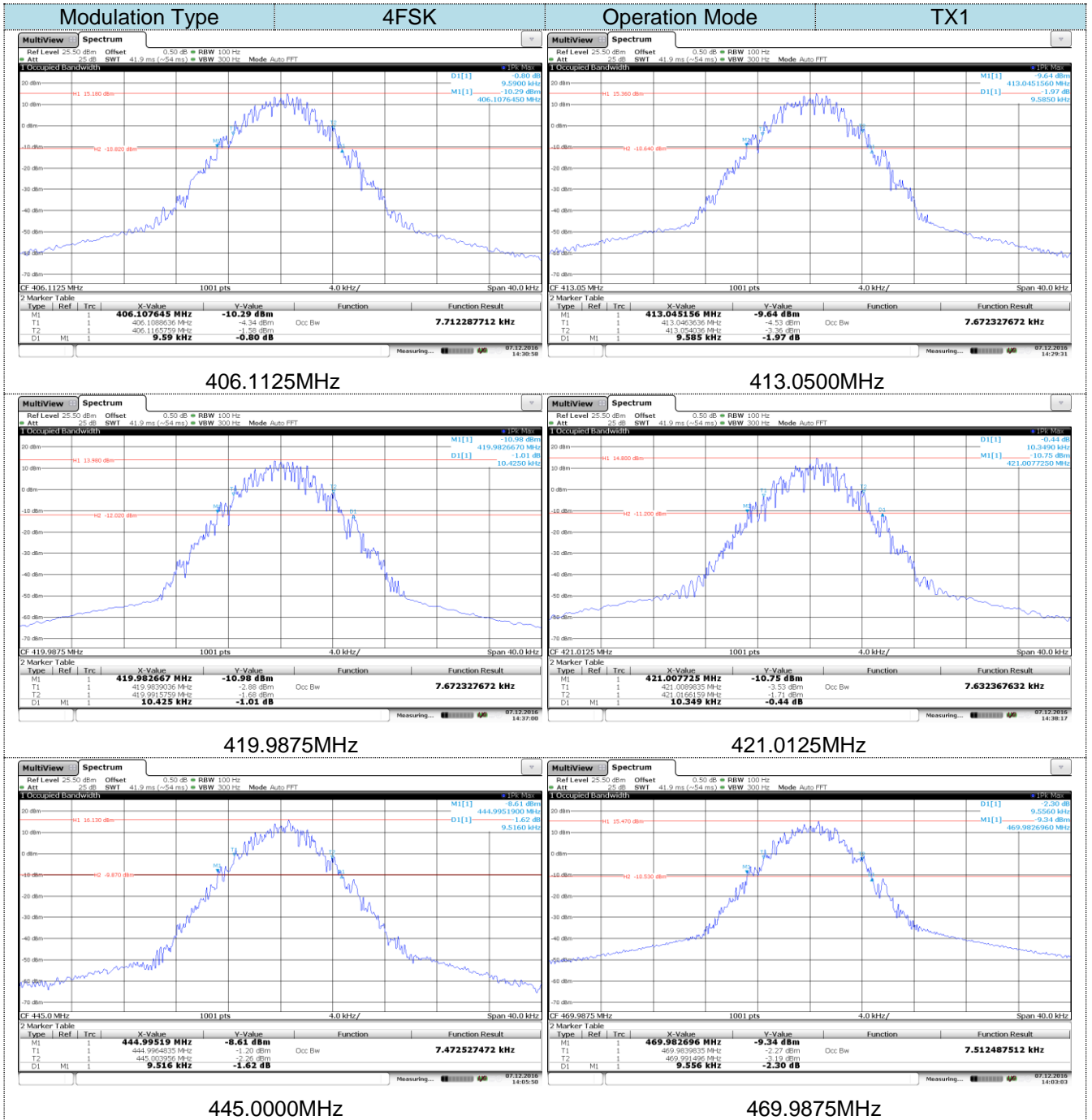

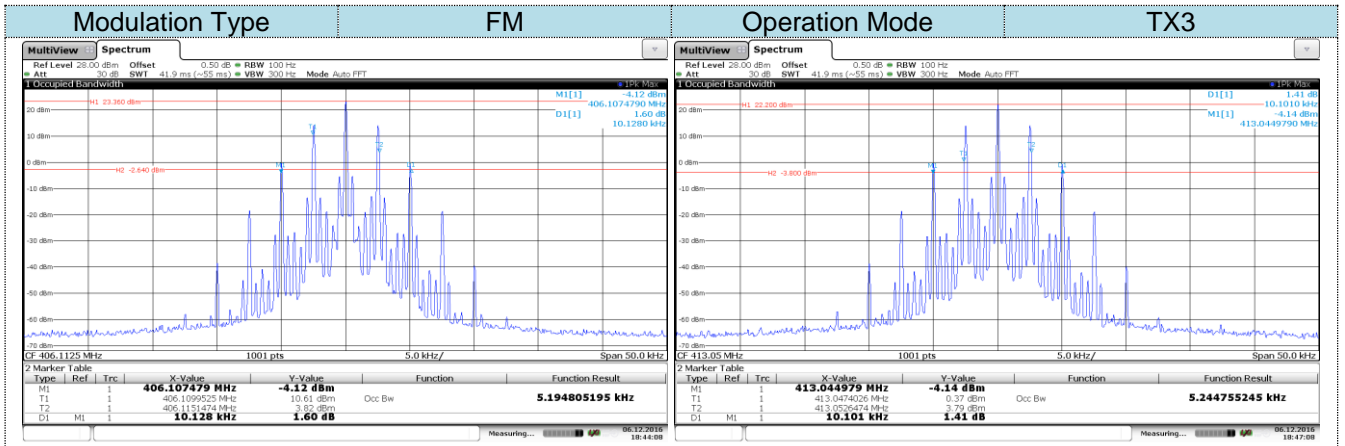

406.1125MHz

413.0500MHz

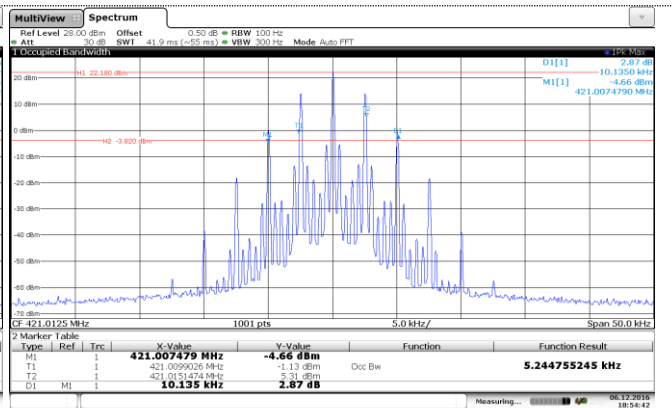
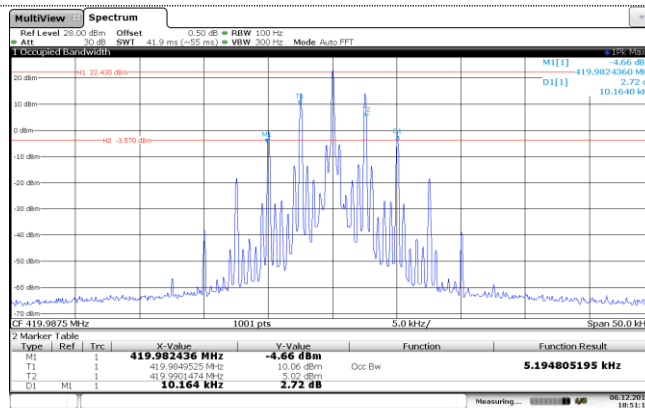

419.9875MHz

421.0125MHz

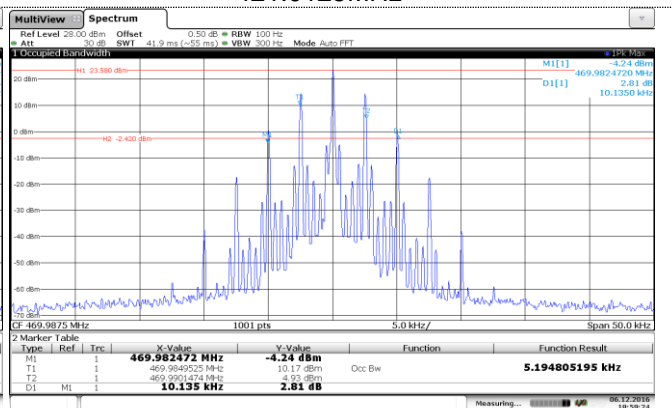
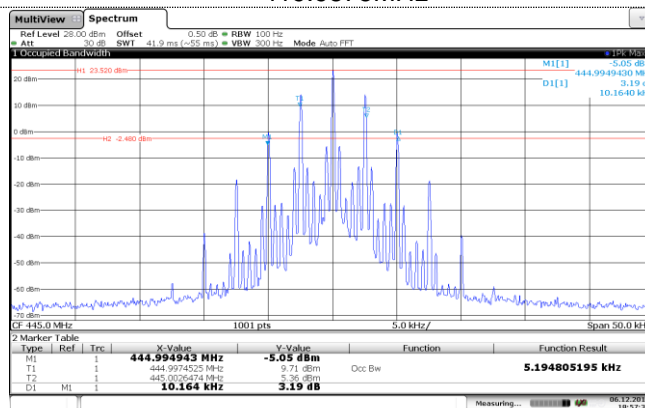

445.0000MHz

469.9875MHz

### 5.3. Emission Mask

Transmitters used in the radio services governed by this part must comply with the emission masks outlined in this section.

#### LIMIT

FCC Part 90.209, FCC Part 90.210, FCC Part 2.1049

| Frequency band (MHz) | Mask for equipment with audio low pass filter | Mask for equipment without audio low pass filter |
|----------------------|---|--|
| Below 251            | A or B  | A or C   |
| 25-50                | B   | C  |
| 72-76                | B   | C  |
| 150-1742             | B, D, or E                                    | C, D or E  |
| 150 paging only      | B   | C  |
| 220-222              | F   | F  |
| 421-5122.5           | B, D, or E                                    | C, D, or E                                       |
| 450 paging only      | B   | G  |
| 806-809/851-854      | B   | H  |
| 809-824/854-8693.5   | B   | G  |
| 896-901/935-940      | I   | J  |
| 902-928              | K   | K  |
| 929-930              | B   | G  |
| 4940-4990 MHz        | L or M  | L or M   |
| 5850-5925.4          |   |  |
| All other bands      | B   | C  |

(d) Emission Mask D—12.5 kHz channel bandwidth equipment.

For transmitters designed to operate with a 12.5 kHz channel bandwidth, any emission must be attenuated below the power (P) of the highest emission contained within the authorized bandwidth as follows:

- 1) On any frequency from the centre of the authorized bandwidth  $f_0$  to 5.625 kHz removed from  $f_0$ : 0dB
- 2) On any frequency removed from the centre of the authorized bandwidth by a displacement frequency ( $f_d$  in kHz) of more than 5.625 kHz but no more than 12.5 kHz: At least  $7.27(f_d - 2.88 \text{ kHz})$  dB.
- 3) On any frequency removed from the centre of the authorized bandwidth by a displacement frequency ( $f_d$  in kHz) of more than 12.5 kHz: At least  $50 + 10 \log(P)$  dB or 70 dB, whichever is the lesser attenuation.

#### TEST CONFIGURATION

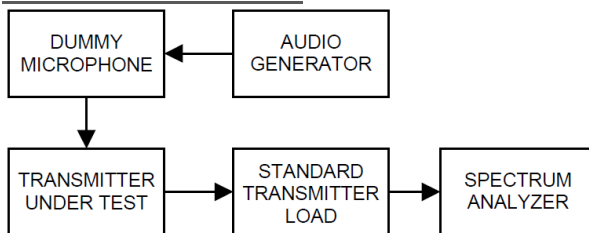

#### TEST PROCEDURE

- 1 Connect the equipment as illustrated.
- 2 Spectrum set as follow:  
Centre frequency = fundamental frequency, span=120kHz for 12.5kHz channel spacing,  
RBW=100Hz, VBW=1000Hz, Sweep = auto,  
Detector function = peak, Trace = max hold
- 3 Key the transmitter, and set the level of the unmodulated carrier to a full scale reference line. This is the 0dB reference for the measurement.
- 4 Modulate the transmitter with a 2500 Hz sine wave at an input level 16 dB greater than that necessary to produce 50% of rated system deviation(Rated system deviation is 2.5 kHz for 12.5kHz channel spacing). The input level shall be established at the frequency of maximum response of the audio modulating circuit. Transmitters employing digital modulation techniques that bypass the limiter and the audio low-pass filter shall be modulated as specified by the manufacturer
- 5 Measure and record the results in the test report.

#### TEST MODE:

Please reference to the section 3.4

#### TEST RESULTS

Passed       Not Applicable

Note: have pre-tested TX1 to TX4 mode, record the worst case mode TX1 and TX3 on the report.

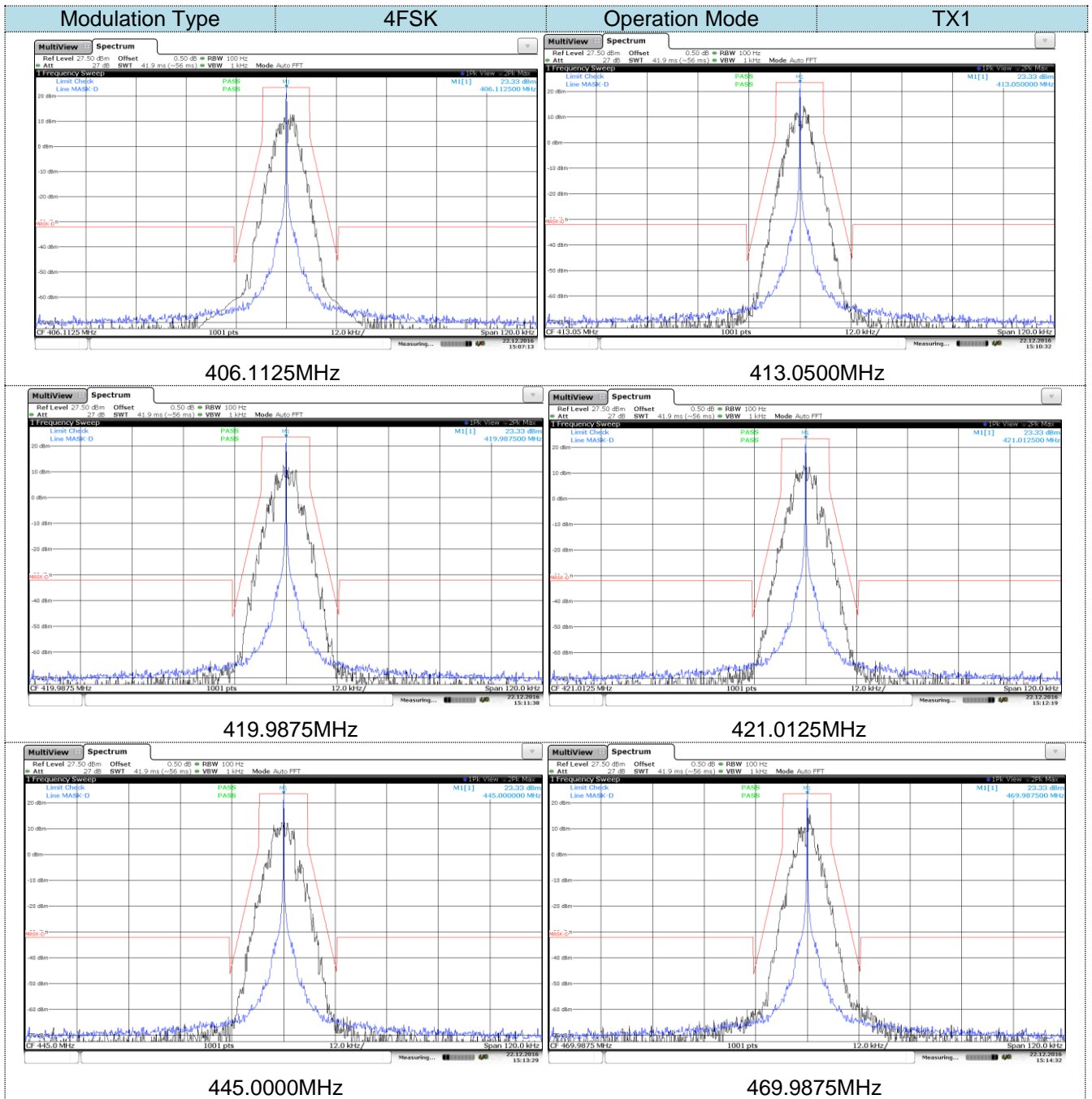

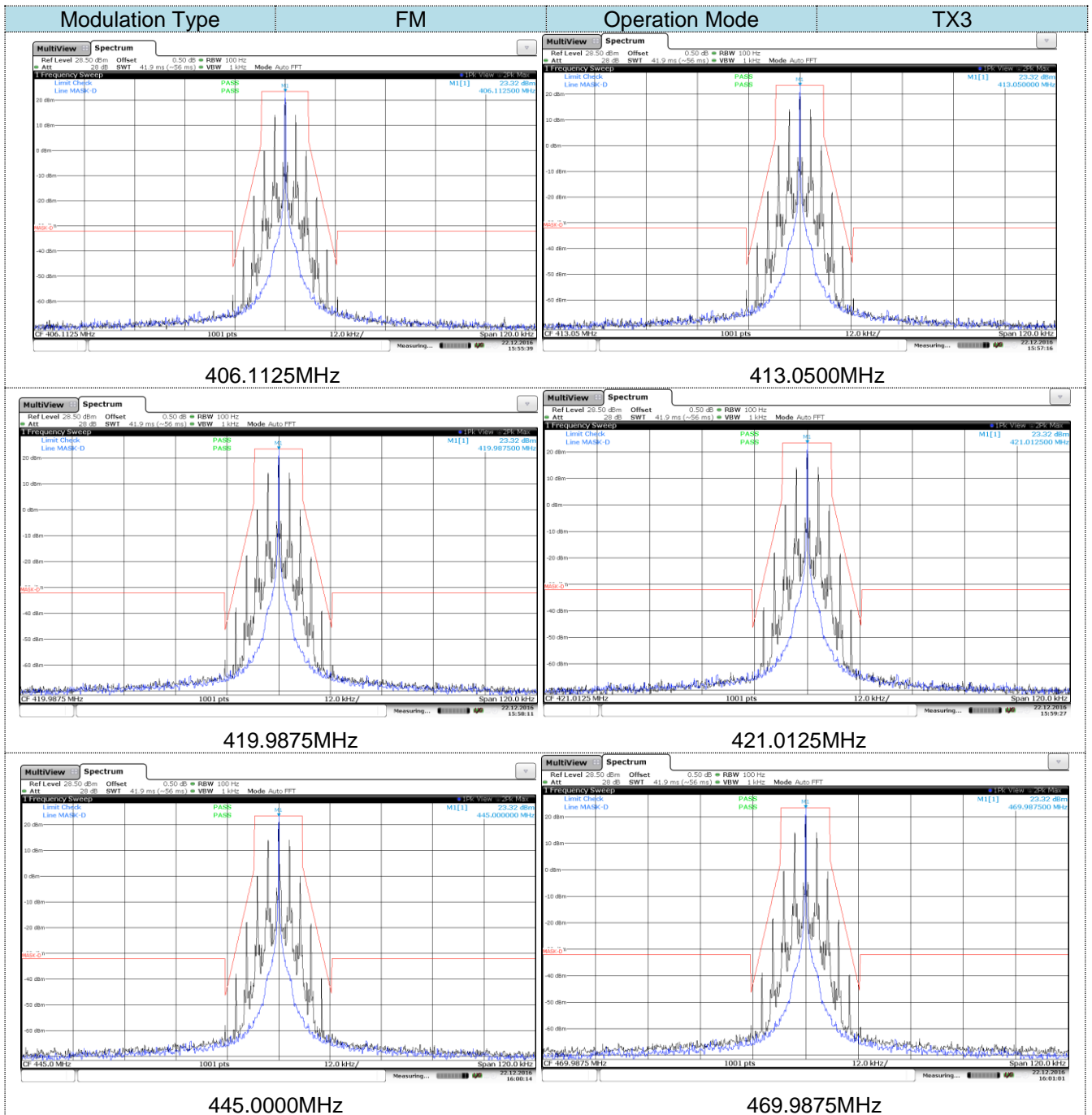

## 5.4. Modulation Limit

Modulation limiting is the transmitter circuit's ability to limit the transmitter from producing deviations in excess of a rated system deviation.

### LIMIT

FCC Part 2.1047(b)

2.5 KHz for 12.5 KHz Channel Spacing System

### TEST CONFIGURATION

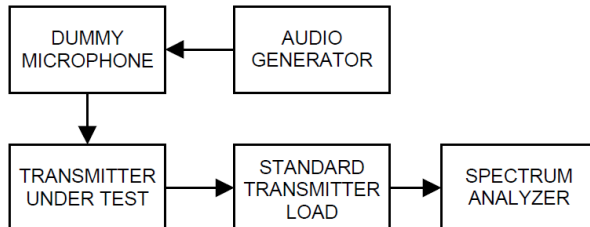

### TEST PROCEDURE

- 1) Connect the equipment as illustrated.
- 2) Adjust the transmitter per the manufacturer's procedure for full rated system deviation.
- 3) Set the test receiver to measure peak positive deviation. Set the audio bandwidth for  $\leq 0.25$  Hz to  $\geq 15,000$  Hz. Turn the de-emphasis function off.
- 4) Apply a 1000 Hz modulating signal to the transmitter from the audio frequency generator, and adjust the level to obtain 60% of full rated system deviation, this level is as a reference (0dB) and vary the input level from -20 to +20dB.
- 5) Measure both the instantaneous and steady-state deviation at and after the time of increasing the audio input level
- 6) Repeat step 4-5 with input frequency changing to 300Hz, 1004Hz, 1500Hz and 2500Hz in sequence.

### TEST MODE:

Please reference to the section 3.4

### TEST RESULTS

Passed       Not Applicable

*Note: have pre-tested TX3 to TX4 mode, record the worst case mode TX3 on the report.*

| TX3: 445MHz           |                                |        |        |         |             |        |
|-----------------------|--------------------------------|--------|--------|---------|-------------|--------|
| Modulation Level (dB) | Peak frequency deviation (kHz) |        |        |         | Limit (kHz) | Result |
|                       | 300Hz                          | 1004Hz | 1500Hz | 2500 Hz |             |        |
| -20                   | 0.159                          | 0.196  | 0.195  | 0.169   | 2.5         | Pass   |
| -15                   | 0.235                          | 0.292  | 0.298  | 0.248   |             |        |
| -10                   | 0.357                          | 0.485  | 0.485  | 0.397   |             |        |
| -5                    | 0.609                          | 0.868  | 0.863  | 0.683   |             |        |
| 0                     | 1.074                          | 1.505  | 1.507  | 1.203   |             |        |
| 5                     | 1.796                          | 1.773  | 1.989  | 1.734   |             |        |
| 10                    | 2.105                          | 1.834  | 2.087  | 1.864   |             |        |
| 15                    | 2.151                          | 1.88   | 2.119  | 1.894   |             |        |
| 20                    | 2.313                          | 1.893  | 2.112  | 1.983   |             |        |

Test plot as follows:



### 5.5. Audio Frequency Response

The audio frequency response is the degree of closeness to which the frequency deviation of the transmitter follows a prescribed characteristic.

**LIMIT**

2.1047(a): Voice modulated communication equipment. A curve or equivalent data showing the frequency response of the audio modulating circuit over a range of 100 to 5000 Hz shall be submitted. For equipment required to have an audio low-pass filter, a curve showing the frequency response of the filter or of all circuitry installed between the modulation limiter and the modulated stage shall be submitted.

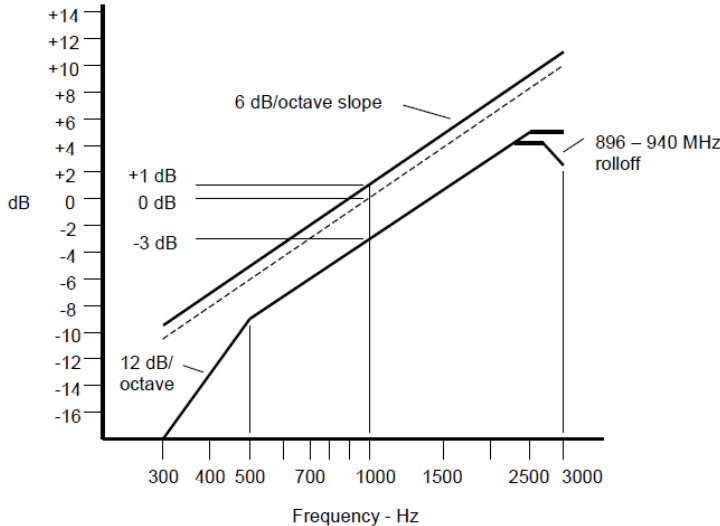

An additional 6 dB per octave attenuation is allowed from 2500 Hz to 3000 Hz in equipment operating in the 25 MHz to 869 MHz range.

**TEST CONFIGURATION**

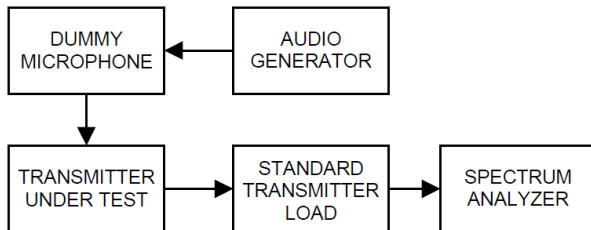

**TEST PROCEDURE**

- 1) Configure the EUT as shown in figure .
- 2) Adjust the audio input for 20% of rated system deviation at 1kHz using this level as a reference.
- 3) Vary the Audio frequency from 300Hz to 3 kHz and record the frequency deviation.
- 4) Audio Frequency Response =  $20\log_{10} (V_{FREQ}/V_{REF})$ .

**TEST MODE:**

Please reference to the section 3.4

**TEST RESULTS**

Passed       Not Applicable

Note: have pre-tested TX3 to TX4 mode, record the worst case mode TX3 on the report.



| TX3: 445MHz    |                               |                |                               |
|----------------|-------------------------------|----------------|-------------------------------|
| Frequency (Hz) | Audio Frequency Response (dB) | Frequency (Hz) | Audio Frequency Response (dB) |
| 300            | -18.05                        | 2000           | 6.06                          |
| 400            | -15.03                        | 2100           | 6.48                          |
| 500            | -10.72                        | 2200           | 6.62                          |
| 600            | -7.94                         | 2300           | 6.70                          |
| 700            | -5.84                         | 2400           | 6.67                          |
| 800            | -4.12                         | 2500           | 6.55                          |
| 900            | -2.85                         | 2600           | 6.27                          |
| 1000           | -1.76                         | 2700           | 5.90                          |
| 1200           | -0.88                         | 2800           | 5.23                          |
| 1400           | 0.00                          | 2900           | 4.37                          |
| 1600           | 1.60                          | 3000           | 3.61                          |
| 1800           | 2.95                          |                |                               |

Test plot as follows:

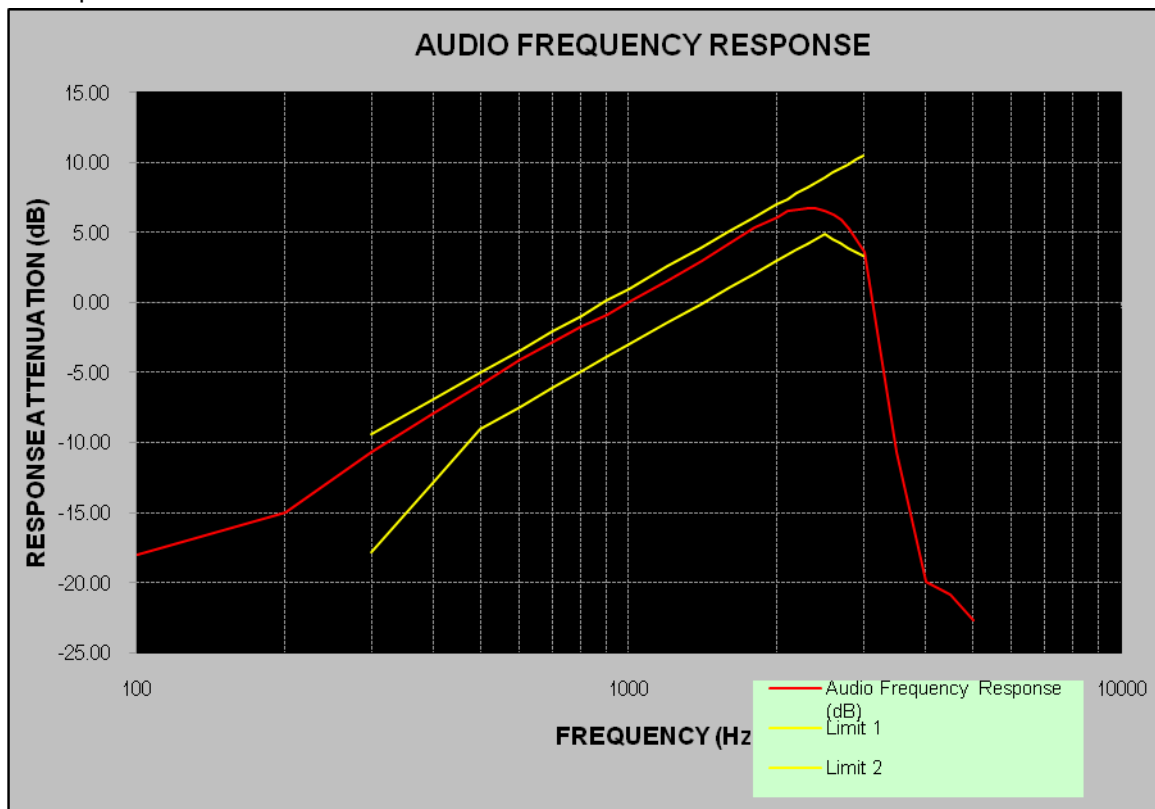

### 5.6. Frequency Stability Test

The carrier frequency stability is the ability of the transmitter to maintain an assigned carrier frequency.

**LIMIT**

**FCC Part 90.213, FCC Part 2.1055**

| Frequency range (MHz) | Fixed and base stations | Mobile stations           |                              |
|-----------------------|-------------------------|---------------------------|------------------------------|
|                       |                         | Over 2 watts output power | 2 watts or less output power |
| Below 25              | 1 2 3 100               | 100                       | 200                          |
| 25-50                 | 20                      | 20                        | 50                           |
| 72-76                 | 5                       |                           | 50                           |
| 150-174               | 5 115                   | 65                        | 4 650                        |
| 216-220               | 1.0                     |                           | 1.0                          |
| 220-222.12            | 0.1                     | 1.5                       | 1.5                          |
| 421-512               | 7 11 142.5              | 85                        | 85                           |
| 806-809               | 141.0                   | 1.5                       | 1.5                          |
| 809-824               | 141.5                   | 2.5                       | 2.5                          |
| 851-854               | 1.0                     | 1.5                       | 1.5                          |
| 854-869               | 1.5                     | 2.5                       | 2.5                          |
| 896-901               | 140.1                   | 1.5                       | 1.5                          |
| 902-928               | 2.5                     | 2.5                       | 2.5                          |
| 902-928.13            | 2.5                     | 2.5                       | 2.5                          |
| 929-930               | 1.5                     |                           |                              |
| 935-940               | 0.1                     | 1.5                       | 1.5                          |
| 1427-1435             | 9300                    | 300                       | 300                          |
| Above 2450.10         |                         |                           |                              |

<sup>5</sup>In the 150-174 MHz band, fixed and base stations with a 12.5 kHz channel bandwidth must have a frequency stability of 2.5 ppm. Fixed and base stations with a 6.25 kHz channel bandwidth must have a frequency stability of 1.0 ppm.

<sup>7</sup>In the 421-512 MHz band, fixed and base stations with a 12.5 kHz channel bandwidth must have a frequency stability of 1.5 ppm. Fixed and base stations with a 6.25 kHz channel bandwidth must have a frequency stability of 0.5 ppm.

<sup>11</sup>Paging transmitters operating on paging-only frequencies must operate with frequency stability of 5 ppm in the 150-174 MHz band and 2.5 ppm in the 421-512 MHz band.

<sup>14</sup>Control stations may operate with the frequency tolerance specified for associated mobile frequencies.

**TEST CONFIGURATION**

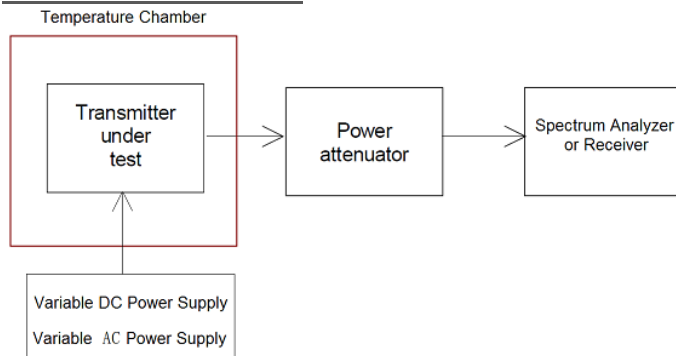

**TEST PROCEDURE**

1. According to FCC Part 2 Section 2.1055 (a)(1), the frequency stability shall be measured with variation of ambient temperature from -30°C to +50°C.
2. According to FCC Part 2 Section 2.1055 (d) (2), for battery powered equipment, the frequency stability shall be measured with reducing primary supply voltage to the battery operating end point, which is specified by the manufacture.
3. Vary primary supply voltage from 3.6V to 4.2V.
4. The EUT was set in the climate chamber and connected to an external DC power supply. The RF output was directly connected to Spectrum Analyzer, The coupling loss of the additional cables was recorded and taken in account for all the measurements. After temperature stabilization (approx. 20 min for each stage), the frequency for the lower, the middle and the highest frequency range was recorded. For Frequency stability Vs. Voltage the EUT was connected to a DC power supply and the voltage was adjusted in the required ranges. The result was recorded.

**TEST MODE:**

Please reference to the section 3.4

**TEST RESULTS**

**Passed**       **Not Applicable**

*Note: have pre-tested TX1 to TX4 mode, record the worst case mode TX1 and TX3 on the report.*

| TX1             |           |                       |            |              |              |            |              |             |        |
|-----------------|-----------|-----------------------|------------|--------------|--------------|------------|--------------|-------------|--------|
| Test conditions |           | Frequency error (ppm) |            |              |              |            |              | Limit (ppm) | Result |
| Voltage (V)     | Temp (°C) | 406.1125 MHz          | 413.05 MHz | 419.9875 MHz | 421.0125 MHz | 445.00 MHz | 469.9875 MHz |             |        |
| 3.7             | -30       | 0.06                  | 0.09       | 0.09         | 0.09         | 0.10       | 0.12         | ±2.5        | Pass   |
|                 | -20       | 0.09                  | 0.09       | 0.09         | 0.09         | 0.09       | 0.10         |             |        |
|                 | -10       | 0.08                  | 0.09       | 0.09         | 0.09         | 0.09       | 0.10         |             |        |
|                 | 0         | 0.08                  | 0.09       | 0.09         | 0.09         | 0.10       | 0.10         |             |        |
|                 | 10        | 0.09                  | 0.09       | 0.09         | 0.09         | 0.09       | 0.10         |             |        |
|                 | 20        | 0.09                  | 0.09       | 0.09         | 0.09         | 0.10       | 0.10         |             |        |
|                 | 30        | 0.10                  | 0.09       | 0.10         | 0.10         | 0.10       | 0.11         |             |        |
|                 | 40        | 0.10                  | 0.09       | 0.10         | 0.10         | 0.11       | 0.11         |             |        |
|                 | 50        | 0.11                  | 0.09       | 0.10         | 0.11         | 0.11       | 0.11         |             |        |
| 3.6             | 20        | 0.08                  | 0.09       | 0.09         | 0.08         | 0.09       | 0.10         |             |        |
| 4.2             | 20        | 0.10                  | 0.10       | 0.10         | 0.09         | 0.11       | 0.12         |             |        |

| TX3             |           |                       |            |              |              |            |              |             |        |
|-----------------|-----------|-----------------------|------------|--------------|--------------|------------|--------------|-------------|--------|
| Test conditions |           | Frequency error (ppm) |            |              |              |            |              | Limit (ppm) | Result |
| Voltage(V)      | Temp (°C) | 406.1125 MHz          | 413.05 MHz | 419.9875 MHz | 421.0125 MHz | 445.00 MHz | 469.9875 MHz |             |        |
| 3.7             | -30       | 0.08                  | 0.05       | 0.05         | 0.05         | 0.05       | 0.09         | ±2.5        | Pass   |
|                 | -20       | 0.05                  | 0.04       | 0.05         | 0.05         | 0.05       | 0.04         |             |        |
|                 | -10       | 0.04                  | 0.05       | 0.04         | 0.06         | 0.05       | 0.05         |             |        |
|                 | 0         | 0.05                  | 0.05       | 0.04         | 0.05         | 0.05       | 0.05         |             |        |
|                 | 10        | 0.04                  | 0.05       | 0.05         | 0.05         | 0.05       | 0.04         |             |        |
|                 | 20        | 0.05                  | 0.05       | 0.05         | 0.06         | 0.05       | 0.05         |             |        |
|                 | 30        | 0.05                  | 0.05       | 0.05         | 0.06         | 0.05       | 0.04         |             |        |
|                 | 40        | 0.05                  | 0.05       | 0.05         | 0.06         | 0.05       | 0.06         |             |        |
|                 | 50        | 0.04                  | 0.04       | 0.04         | 0.06         | 0.05       | 0.05         |             |        |
| 3.6             | 20        | 0.07                  | 0.05       | 0.05         | 0.06         | 0.05       | 0.08         |             |        |
| 4.2             | 20        | 0.08                  | 0.05       | 0.05         | 0.05         | 0.05       | 0.09         |             |        |

### 5.7. Transmitter Frequency Behaviour

**LIMIT**

**FCC part 90.214**

Transmitters designed to operate in the 150-174 MHz and 421-512 MHz frequency bands must maintain transient frequencies within the maximum frequency difference limits during the time intervals indicated:

| Time intervals <sup>1 2</sup>   | Maximum frequency difference <sup>3</sup> | All equipment  |                |
|---|---|----------------|----------------|
|   |   | 150 to 174 MHz | 421 to 512 MHz |
| Transient Frequency Behavior for Equipment Designed to Operate on 25 kHz Channels   |   |                |                |
| t <sub>1</sub> <sup>4</sup>   | ±25.0 kHz                                 | 5.0 ms         | 10.0 ms        |
| t <sub>2</sub>  | ±12.5 kHz                                 | 20.0 ms        | 25.0 ms        |
| t <sub>3</sub> <sup>4</sup>   | ±25.0 kHz                                 | 5.0 ms         | 10.0 ms        |
| Transient Frequency Behavior for Equipment Designed to Operate on 12.5 kHz Channels |   |                |                |
| t <sub>1</sub> <sup>4</sup>   | ±12.5 kHz                                 | 5.0 ms         | 10.0 ms        |
| t <sub>2</sub>  | ±6.25 kHz                                 | 20.0 ms        | 25.0 ms        |
| t <sub>3</sub> <sup>4</sup>   | ±12.5 kHz                                 | 5.0 ms         | 10.0 ms        |
| Transient Frequency Behavior for Equipment Designed to Operate on 6.25 kHz Channels |   |                |                |
| t <sub>1</sub> <sup>4</sup>   | ±6.25 kHz                                 | 5.0 ms         | 10.0 ms        |
| t <sub>2</sub>  | ±3.125 kHz                                | 20.0 ms        | 25.0 ms        |
| t <sub>3</sub> <sup>4</sup>   | ±6.25 kHz                                 | 5.0 ms         | 10.0 ms        |

Note:

- On is the instant when a 1 kHz test signal is completely suppressed, including any capture time due to phasing.
  - t<sub>1</sub> is the time period immediately following ton.
  - t<sub>2</sub> is the time period immediately following t<sub>1</sub>.
  - t<sub>3</sub> is the time period from the instant when the transmitter is turned off until toff.
  - t<sub>off</sub> is the instant when the 1 kHz test signal starts to rise.
- During the time from the end of t<sub>2</sub> to the beginning of t<sub>3</sub>, the frequency difference must not exceed the limits specified in § 90.213.
- Difference between the actual transmitter frequency and the assigned transmitter frequency.
- If the transmitter carrier output power rating is 6 watts or less, the frequency difference during this time period may exceed the maximum frequency difference for this time period.

**TEST CONFIGURATION**

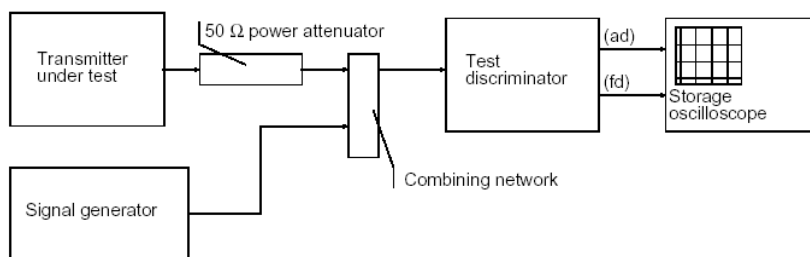

**TEST PROCEDURE**

According to TIA/EIA-603 2.2.19 requirement, as for the product different from PTT, we use test steps as follows:

1. Connect DUT into Test discriminator and Storage Oscilloscope and keep DUT stats ON;
2. Input 1kHz signal into DUT;
3. Set the modulation domain analyzer to trigger on the rising edge of the waveform in order to capture a single-shot turn-on of the transmitter signals;
4. Keep DUT in OFF state and Key the PTT;
5. Observe the stored oscilloscope of modulation domain analyzer. The signal trace shall be maintained within the allowable limits during the periods  $t_1$  and  $t_2$ , and shall also remain within limits following  $t_2$ ;
6. Adjust the modulation domain analyzer to trigger on the falling edge of the transmitter waveform in order to capture a single-shot turn-off transmitter of the transmitter signal.
7. Keep the digital portable radio in ON state and unkey the PTT;
8. Observe the stored oscilloscope of modulation domain analyzer, The signal trace shall be maintained within the allowable limits during the period  $t_3$ .
9. Set the signal generator to the assigned transmitter frequency and modulate it with a 1 kHz tone at  $\pm 12.5$  kHz deviation and set its output level to -100dBm.
10. Turn on the transmitter.
11. Supply sufficient attenuation via the RF attenuator to provide an input level to the stored oscilloscope
12. that is 40 dB below the maximum allowed input power when the transmitter is operating at its rated power level. Note this power level on the stored oscilloscope as  $P_0$ .
13. Turn off the transmitter.
14. Adjust the RF level of the signal generator to provide RF power equal to  $P_0$ . This signal generator RF level shall be maintained throughout the rest of the measurement.
15. Remove the attenuation, so the input power to the stored oscilloscope is increased by 30 dB when the transmitter is turned on.
16. Adjust the vertical amplitude control of the stored oscilloscope to display the 1000 Hz at  $\pm 4$  divisions vertically centered on the display. Set trigger mode of the Spectrum Analyzer to "Video", and tune the "trigger level" on suitable level. Then set the "trigger offset" to -10ms for turn on and -15ms for turn off.
17. Turn on the transmitter and the transient wave will be captured on the screen of Spectrum Analyzer. Observe the stored display. The instant when the 1 kHz test signal is completely suppressed is considered to be ton. The trace should be maintained within the allowed divisions during the period  $t_1$  and  $t_2$ .
18. Then turn off the transmitter, and another transient wave will be captured on the screen of Spectrum
19. Analyzer. The trace should be maintained within the allowed divisions during the period  $t_3$ .

**TEST MODE:**

Please reference to the section 3.4

**TEST RESULTS**

**Passed**       **Not Applicable**

*Note: have pre-tested TX3 to TX4 mode, record the worst case mode TX3 on the report.*

Modulation Type: FM(TX3)  
Transmitter Frequency Behaviour @ 12.5kHz Channel Separation-----Off – On

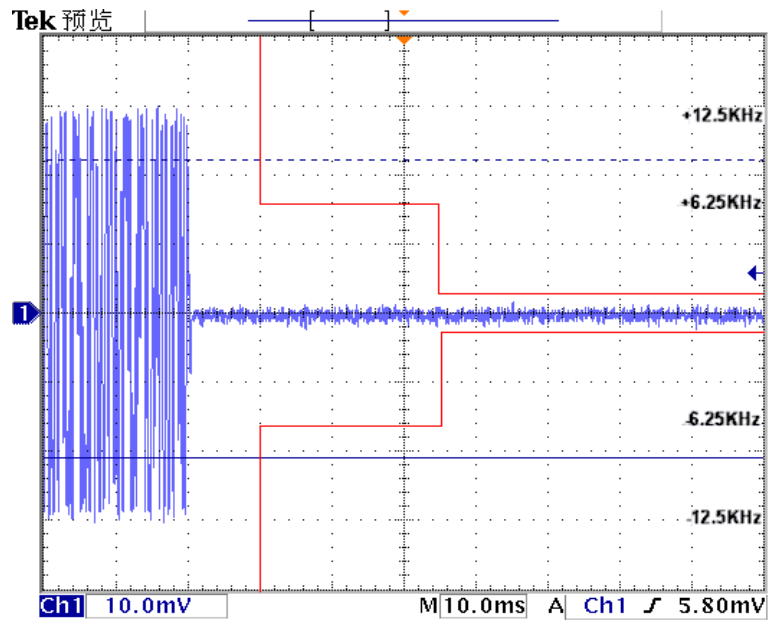

Transmitter Frequency Behaviour @ 12.5kHz Channel Separation-----On – Off

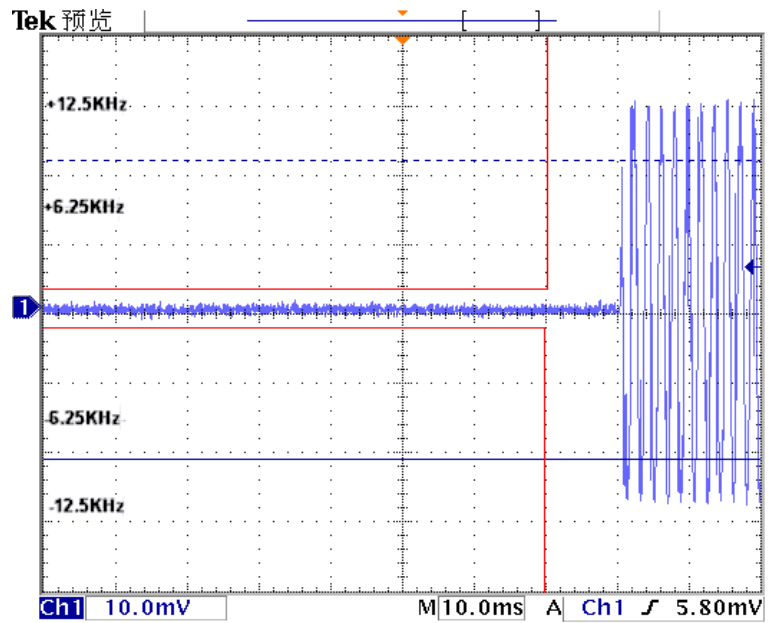

## 5.8. Spurious Emission on Antenna Port

Conducted spurious emissions are emissions at the antenna terminals on a frequency or frequencies that are outside a band sufficient to ensure transmission of information of required quality for the class of communication desired

### LIMIT

FCC Part 90.210, FCC Part 2.1051 (12.5 kHz Bandwidth only):

On any frequency removed from the center of the authorized bandwidth by a displacement frequency ( $f_d$  in kHz) of more than 12.5 kHz at least:

$$50 + 10 \log (P_{\text{watts}})$$

Note: In general, the worse case attenuation requirement shown above was applied.

Calculation: Limit (dBm) = EL - 50 - 10 log<sub>10</sub> (TP)

EL is the emission level of the Output Power expressed in dBm,

In this application, the EL is P (dBm)

$$\text{Limit (dBm)} = P(\text{dBm}) - 50 - 10 \log (P_{\text{watts}}) = -20\text{dBm}$$

### TEST CONFIGURATION

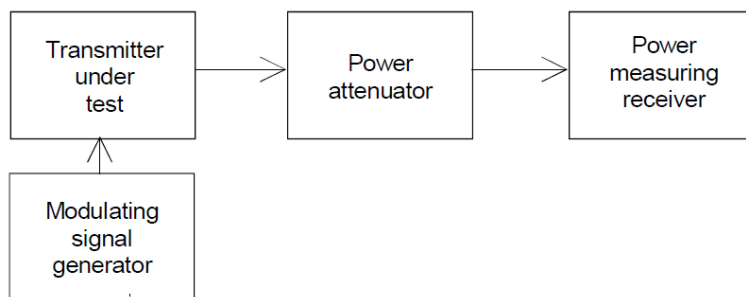

### TEST PROCEDURE

1. The RF output of the EUT was connected to a spectrum analyzer through appropriate attenuation.
2. The resolution bandwidth of the spectrum analyzer was set to 100 kHz. Sufficient scans were taken to show any out of band emission up to 10<sup>th</sup>. Harmonic for the lower and the highest frequency range.
3. Set RBW 100 kHz, VBW 300 kHz in the frequency band 30MHz to 1GHz, while set RBW=1MHz. VBW=3MHz from the 1GHz to 10<sup>th</sup> Harmonic.
4. The audio input was set the unmodulated carrier, the resulting picture is print out for each channel separation.

### TEST MODE:

Please reference to the section 3.4

### TEST RESULTS

Passed       Not Applicable

This equipment is integral antenna.



### 5.9. Transmitter Radiated Spurious Emission

Radiated spurious emissions are emissions from the equipment when transmitting into a nonradiating load on a frequency or frequencies that are outside an occupied band sufficient to ensure transmission of information of required quality for the class of communications desired.

**LIMIT**

FCC Part 90.210, FCC Part 2.1053 (12.5 kHz Bandwidth only):

On any frequency removed from the center of the authorized bandwidth by a displacement frequency ( $f_d$  in kHz) of more than 12.5 kHz at least:

$$50 + 10 \log (P_{\text{watts}})$$

Note: In general, the worse case attenuation requirement shown above was applied.

Calculation: Limit (dBm) = EL - 50 - 10 log<sub>10</sub> (TP)

EL is the emission level of the Output Power expressed in dBm,

In this application, the EL is P (dBm)

Limit (dBm) = P (dBm) - 50 - 10 log (Pwatts) = -20dBm

**TEST CONFIGURATION**

Below 1GHz:

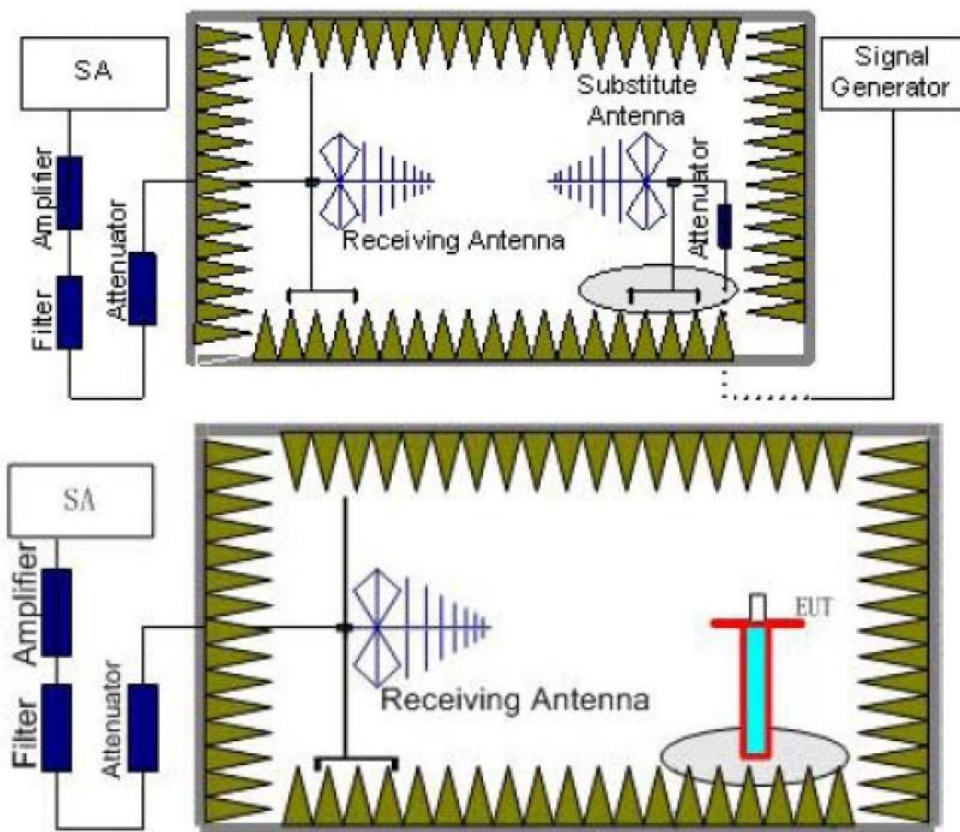

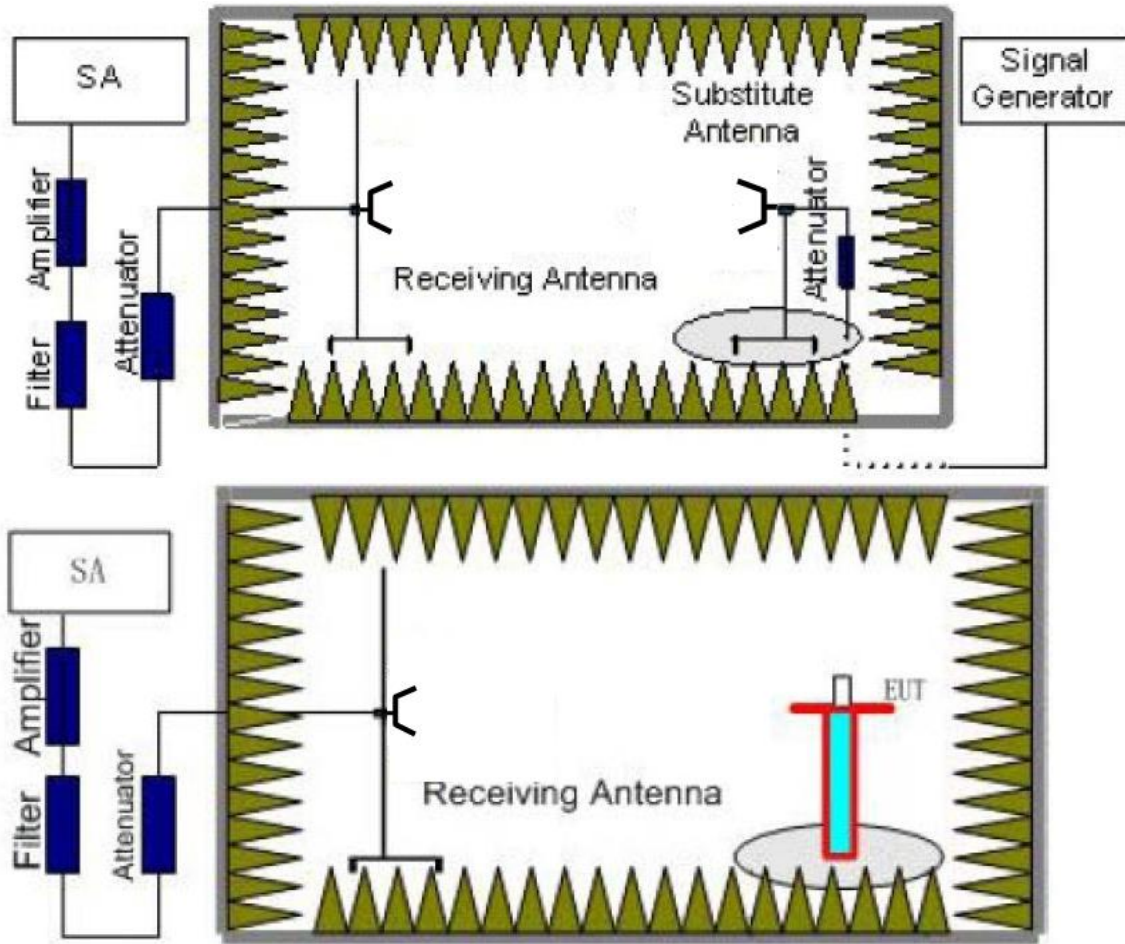
**Above 1GHz:****TEST PROCEDURE**

8. Standard Transmitter Load with a  $50\ \Omega$  input impedance and an output impedance matched to the test equipment.
9. EUT was placed on a 0.8 meter high non-conductive stand at a 3 meter test distance from the receive antenna. A receiving antenna was placed on the antenna mast 3 meters from the EUT for emission measurements. The height of receiving antenna is 1.0 m. Detected emissions were maximized at each frequency by rotating the EUT through  $360^\circ$  and adjusting the receiving antenna polarization. The radiated emission measurements of all transmit frequencies in six channels were measured with peak detector.
10. A log-periodic antenna or double-ridged waveguide horn antenna shall be substituted in place of the EUT. The log-periodic antenna will be driven by a signal generator and the level will be adjusted till the same power value on the spectrum analyzer or receiver. The level of the spurious emissions can be calculated through the level of the signal generator, cable loss, the gain of the substitution antenna and the reading of the spectrum analyzer or receiver.
11. The EUT is then put into continuously transmitting mode at its maximum power level during the test. Set Test Receiver or Spectrum RBW=1MHz, VBW=3MHz for above 1GHz and RBW=100kHz, VBW=300kHz for 30MHz to 1GHz, And the maximum value of the receiver should be recorded as (Pr).
12. The EUT shall be replaced by a substitution antenna. In the chamber, an substitution antenna for the frequency band of interest is placed at the reference point of the chamber. An RF Signal source for the frequency band of interest is connected to the substitution antenna with a cable that has been constructed to not interfere with the radiation pattern of the antenna. A power (PMea) is applied to the input of the substitution antenna, and adjust the level of the signal generator output until the value of the receiver reach the previously recorded (Pr). The power of signal source (PMea) is recorded. The test should be performed by rotating the test item and adjusting the receiving antenna polarization.
13. A amplifier should be connected to the Signal Source output port. And the cable should be connect between the Amplifier and the Substitution Antenna. The cable loss (Pcl), the Substitution Antenna Gain (Ga) and the Amplifier Gain (PAG) should be recorded after test.

The measurement results are obtained as described below:

$$\text{Power(EIRP)} = \text{PMea} - \text{PAG} - \text{Pcl} - \text{Ga}$$

We used SMF100A microwave signal generator which signal level can up to 33dBm, so we not used power Amplifier for substitution test; The measurement results are amend as described below:

$$\text{Power(EIRP)} = \text{PMea} - \text{Pcl} - \text{Ga}$$

14. This value is EIRP since the measurement is calibrated using an antenna of known gain (2.15 dBi) and known input power.
15. ERP can be calculated from EIRP by subtracting the gain of the dipole,  $ERP = EIRP - 2.15\text{dBi}$ .

**TEST MODE:**

Please reference to the section 3.4

**TEST RESULTS**

**Passed**       **Not Applicable**

Note:

1. In general, the worse case attenuation requirement shown above was applied.
2. The measurement frequency range from 30 MHz to 5 GHz.
3. Absolute Level=SG Level-Cable loss+Antenna Gain, Margin=Limit-Absolute Level
4. We tested TX1 to TX3 recorded worst case TX1 and TX3.

| Frequency (MHz)  | Polar (H/V) | Receiver Reading (dBμV) | Substituted Method |                        |                 | Absolute Level (dBm) | Limit (dBm) | Margin (dB) |
|------------------|-------------|-------------------------|--------------------|------------------------|-----------------|----------------------|-------------|-------------|
|                  |             |                         | S.G.Level (dBm)    | Antenna Gain (dBd/dBi) | Cable Loss (dB) |                      |             |             |
| TX1:406.1125 MHz |             |                         |                    |                        |                 |                      |             |             |
| 812.225          | H           | 65.42                   | -32.24             | 0                      | 3.34            | -35.58               | -20         | 15.58       |
| 812.225          | V           | 66.14                   | -30.73             | 0                      | 3.34            | -34.07               | -20         | 14.07       |
| 1218.3375        | H           | 57.51                   | -40.86             | 9.1                    | 4.16            | -35.92               | -20         | 15.92       |
| 1218.3375        | V           | 54.35                   | -45.39             | 9.1                    | 4.16            | -40.45               | -20         | 20.45       |
| 1624.45          | H           | 50.42                   | -51.20             | 11.8                   | 5.51            | -44.91               | -20         | 24.91       |
| 1624.45          | V           | 48.61                   | -53.53             | 11.8                   | 5.51            | -47.24               | -20         | 27.24       |
| TX1:413.05 MHz   |             |                         |                    |                        |                 |                      |             |             |
| 826.1            | H           | 65.36                   | -31.05             | 0                      | 3.66            | -34.71               | -20         | 14.71       |
| 826.1            | V           | 66.27                   | -31.55             | 0                      | 3.66            | -35.21               | -20         | 15.21       |
| 1239.15          | H           | 57.49                   | -43.13             | 8.65                   | 4.21            | -38.69               | -20         | 18.69       |
| 1239.15          | V           | 54.79                   | -46.87             | 8.65                   | 4.21            | -42.43               | -20         | 22.43       |
| 1652.2           | H           | 50.26                   | -51.21             | 11.12                  | 5.68            | -45.77               | -20         | 25.77       |
| 1652.2           | V           | 48.52                   | -53.47             | 11.12                  | 5.68            | -48.03               | -20         | 28.03       |
| TX1:419.9875 MHz |             |                         |                    |                        |                 |                      |             |             |
| 839.975          | H           | 65.15                   | -31.70             | 0                      | 3.44            | -35.14               | -20         | 15.14       |
| 839.975          | V           | 66.33                   | -32.19             | 0                      | 3.44            | -35.63               | -20         | 15.63       |
| 1259.9625        | H           | 57.15                   | -44.21             | 8.46                   | 5.43            | -41.18               | -20         | 21.18       |
| 1259.9625        | V           | 54.26                   | -46.60             | 8.46                   | 5.43            | -43.57               | -20         | 23.57       |
| 1679.95          | H           | 50.42                   | -51.27             | 11.23                  | 5.72            | -45.76               | -20         | 25.76       |
| 1679.95          | V           | 48.41                   | -54.28             | 11.23                  | 5.72            | -48.77               | -20         | 28.77       |
| TX1:421.0125 MHz |             |                         |                    |                        |                 |                      |             |             |
| 842.025          | H           | 65.32                   | -32.19             | 0                      | 3.44            | -35.63               | -20         | 15.63       |
| 842.025          | V           | 66.64                   | -30.17             | 0                      | 3.44            | -33.61               | -20         | 13.61       |
| 1263.0375        | H           | 57.47                   | -42.42             | 8.47                   | 5.57            | -39.52               | -20         | 19.52       |
| 1263.0375        | V           | 54.39                   | -46.24             | 8.47                   | 5.57            | -43.34               | -20         | 23.34       |
| 1684.05          | H           | 50.29                   | -51.36             | 11.32                  | 5.74            | -45.78               | -20         | 25.78       |
| 1684.05          | V           | 48.34                   | -53.50             | 11.32                  | 5.74            | -47.92               | -20         | 27.92       |
| TX1:445 MHz      |             |                         |                    |                        |                 |                      |             |             |
| 890              | H           | 65.29                   | -32.53             | 0                      | 3.62            | -36.15               | -20         | 16.15       |
| 890              | V           | 66.27                   | -30.84             | 0                      | 3.66            | -34.5                | -20         | 14.5        |
| 2350.46          | H           | 57.29                   | -42.74             | 8.56                   | 5.67            | -39.85               | -20         | 19.85       |
| 2350.46          | V           | 54.29                   | -47.29             | 8.56                   | 5.67            | -44.4                | -20         | 24.4        |
| 3186.09          | H           | 50.34                   | -50.35             | 11.36                  | 5.78            | -44.77               | -20         | 24.77       |
| 3186.09          | V           | 48.71                   | -53.50             | 11.36                  | 5.78            | -47.92               | -20         | 27.92       |
| TX1:469.9875MHz  |             |                         |                    |                        |                 |                      |             |             |
| 939.975          | H           | 65.29                   | -32.73             | 0                      | 3.02            | -35.75               | -20         | 15.75       |
| 939.975          | V           | 66.42                   | -32.20             | 0                      | 3.02            | -35.22               | -20         | 15.22       |
| 2350.46          | H           | 57.29                   | -42.63             | 8.62                   | 6.32            | -40.33               | -20         | 20.33       |
| 2350.46          | V           | 54.33                   | -46.03             | 8.62                   | 6.32            | -43.73               | -20         | 23.73       |
| 3290.32          | H           | 50.51                   | -50.44             | 11.52                  | 7.13            | -46.05               | -20         | 26.05       |
| 3290.32          | V           | 48.36                   | -53.51             | 11.52                  | 7.13            | -49.12               | -20         | 29.12       |

| Frequency (MHz)  | Polar (H/V) | Receiver Reading (dBμV) | Substituted Method |                        |                 | Absolute Level (dBm) | Limit (dBm) | Margin (dB) |
|------------------|-------------|-------------------------|--------------------|------------------------|-----------------|----------------------|-------------|-------------|
|                  |             |                         | S.G.Level (dBm)    | Antenna Gain (dBd/dBi) | Cable Loss (dB) |                      |             |             |
| TX3:406.1125 MHz |             |                         |                    |                        |                 |                      |             |             |
| 812.225          | H           | 65.63                   | -32.03             | 0                      | 3.34            | -35.37               | -20         | 15.37       |
| 812.225          | V           | 66.42                   | -30.45             | 0                      | 3.34            | -33.79               | -20         | 13.79       |
| 1218.3375        | H           | 57.32                   | -41.05             | 9.1                    | 4.16            | -36.11               | -20         | 16.11       |
| 1218.3375        | V           | 54.74                   | -45.00             | 9.1                    | 4.16            | -40.06               | -20         | 20.06       |
| 1624.45          | H           | 50.19                   | -51.43             | 11.8                   | 5.51            | -45.14               | -20         | 25.14       |
| 1624.45          | V           | 48.41                   | -53.73             | 11.8                   | 5.51            | -47.44               | -20         | 27.44       |
| TX3:413.05 MHz   |             |                         |                    |                        |                 |                      |             |             |
| 826.1            | H           | 65.15                   | -31.26             | 0                      | 3.66            | -34.92               | -20         | 14.92       |
| 826.1            | V           | 66.3                    | -31.52             | 0                      | 3.66            | -35.18               | -20         | 15.18       |
| 1239.15          | H           | 57.49                   | -43.13             | 8.65                   | 4.21            | -38.69               | -20         | 18.69       |
| 1239.15          | V           | 54.16                   | -47.50             | 8.65                   | 4.21            | -43.06               | -20         | 23.06       |
| 1652.2           | H           | 50.49                   | -50.98             | 11.12                  | 5.68            | -45.54               | -20         | 25.54       |
| 1652.2           | V           | 48.39                   | -53.60             | 11.12                  | 5.68            | -48.16               | -20         | 28.16       |
| TX3:419.9875 MHz |             |                         |                    |                        |                 |                      |             |             |
| 839.975          | H           | 65.42                   | -31.43             | 0                      | 3.44            | -34.87               | -20         | 14.87       |
| 839.975          | V           | 66.16                   | -32.36             | 0                      | 3.44            | -35.8                | -20         | 15.8        |
| 1259.9625        | H           | 57.27                   | -44.09             | 8.46                   | 5.43            | -41.06               | -20         | 21.06       |
| 1259.9625        | V           | 54.32                   | -46.54             | 8.46                   | 5.43            | -43.51               | -20         | 23.51       |
| 1679.95          | H           | 50.49                   | -51.20             | 11.23                  | 5.72            | -45.69               | -20         | 25.69       |
| 1679.95          | V           | 48.39                   | -54.30             | 11.23                  | 5.72            | -48.79               | -20         | 28.79       |
| TX3:421.0125 MHz |             |                         |                    |                        |                 |                      |             |             |
| 842.025          | H           | 65.16                   | -32.35             | 0                      | 3.44            | -35.79               | -20         | 15.79       |
| 842.025          | V           | 66.33                   | -30.48             | 0                      | 3.44            | -33.92               | -20         | 13.92       |
| 1263.0375        | H           | 57.46                   | -42.43             | 8.47                   | 5.57            | -39.53               | -20         | 19.53       |
| 1263.0375        | V           | 54.56                   | -46.07             | 8.47                   | 5.57            | -43.17               | -20         | 23.17       |
| 1684.05          | H           | 50.57                   | -51.08             | 11.32                  | 5.74            | -45.5                | -20         | 25.5        |
| 1684.05          | V           | 48.26                   | -53.58             | 11.32                  | 5.74            | -48                  | -20         | 28          |
| TX3:445 MHz      |             |                         |                    |                        |                 |                      |             |             |
| 890              | H           | 65.46                   | -32.36             | 0                      | 3.62            | -35.98               | -20         | 15.98       |
| 890              | V           | 66.79                   | -30.32             | 0                      | 3.66            | -33.98               | -20         | 13.98       |
| 2350.46          | H           | 57.47                   | -42.56             | 8.56                   | 5.67            | -39.67               | -20         | 19.67       |
| 2350.46          | V           | 54.62                   | -46.96             | 8.56                   | 5.67            | -44.07               | -20         | 24.07       |
| 3186.09          | H           | 50.63                   | -50.06             | 11.36                  | 5.78            | -44.48               | -20         | 24.48       |
| 3186.09          | V           | 48.47                   | -53.74             | 11.36                  | 5.78            | -48.16               | -20         | 28.16       |
| TX3:469.9875MHz  |             |                         |                    |                        |                 |                      |             |             |
| 939.975          | H           | 65.56                   | -32.46             | 0                      | 3.02            | -35.48               | -20         | 15.48       |
| 939.975          | V           | 66.41                   | -32.21             | 0                      | 3.02            | -35.23               | -20         | 15.23       |
| 2350.46          | H           | 57.59                   | -42.33             | 8.62                   | 6.32            | -40.03               | -20         | 20.03       |
| 2350.46          | V           | 54.39                   | -45.97             | 8.62                   | 6.32            | -43.67               | -20         | 23.67       |
| 3290.32          | H           | 50.23                   | -50.72             | 11.52                  | 7.13            | -46.33               | -20         | 26.33       |
| 3290.32          | V           | 48.79                   | -53.08             | 11.52                  | 7.13            | -48.69               | -20         | 28.69       |

**5.10. Conducted Emissions**

The frequency spectrum from 0.15 MHz to 30 MHz was investigated. The LISN used was 50 ohm / 50 u Henry as specified by section 5.1 of ANSI C63.4-2014. Cables and peripherals were moved to find the maximum emission levels for each frequency.

**Limit**

**FCC part 15.107(a)**

| Frequency of Emission (MHz) | Conducted Limit (dBµV) |            |
|-----------------------------|------------------------|------------|
|                             | Quasi-peak             | Average    |
| 0.15-0.5                    | 66 to 56 *             | 56 to 46 * |
| 0.5-5                       | 56                     | 46         |
| 5-30                        | 60                     | 50         |

**TEST CONFIGURATION**

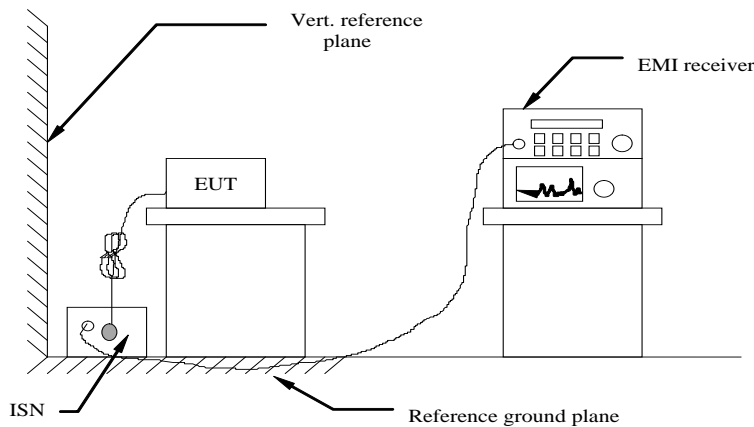

**TEST PROCEDURE**

- 1 The equipment was set up as per the test configuration to simulate typical actual usage per the user’s manual. The EUT is a tabletop system; a wooden table with a height of 0.8 meters is used and is placed on the ground plane as per ANSI C63.4-2014.
- 2 Support equipment, if needed, was placed as per ANSI C63.4-2014.
- 3 All I/O cables were positioned to simulate typical actual usage as per ANSI C63.4-2014.
- 4 If a EUT received AC120V/60Hz power through a Line Impedance Stabilization Network (LISN) which supplied power source and was grounded to the ground plane.
- 5 All support equipments received AC power from a second LISN, if any
- 6 The EUT test program was started. Emissions were measured on each current carrying line of the EUT using a spectrum Analyzer / Receiver connected to the LISN powering the EUT. The LISN has two monitoring points: Line 1 (Hot Side) and Line 2 (Neutral Side). Two scans were taken: one with Line 1 connected to Analyzer / Receiver and Line 2 connected to a 50 ohm load; the second scan had Line 1 connected to a 50 ohm load and Line 2 connected to the Analyzer / Receiver.
- 7 Analyzer / Receiver scanned from 150 kHz to 30MHz for emissions in each of the test modes.
- 8 During the above scans, the emissions were maximized by cable manipulation.

**TEST MODE:**

Please reference to the section 3.4

**TEST RESULTS**

**Passed**       **Not Applicable**

Note:

Have pre-tested RX1 to RX2 mode, record the worst case mode RX1 on the report.

|            |     |              |    |
|------------|-----|--------------|----|
| Test mode: | RX1 | Polarization | L1 |
|------------|-----|--------------|----|

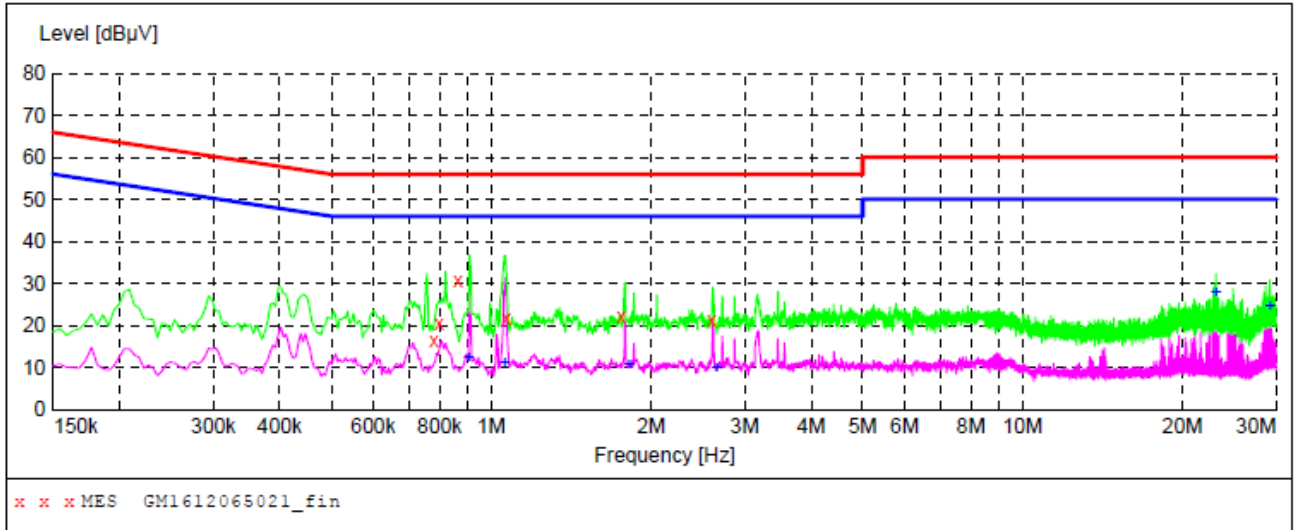

| Frequency<br>MHz | Level<br>dBµV | Transd<br>dB | Limit<br>dBµV | Margin<br>dB | Detector | Line | PE  |
|------------------|---------------|--------------|---------------|--------------|----------|------|-----|
| 0.780000         | 16.40         | 10.2         | 56            | 39.6         | QP       | L1   | GND |
| 0.798000         | 20.50         | 10.2         | 56            | 35.5         | QP       | L1   | GND |
| 0.865500         | 30.50         | 10.1         | 56            | 25.5         | QP       | L1   | GND |
| 1.068000         | 21.80         | 10.2         | 56            | 34.2         | QP       | L1   | GND |
| 1.761000         | 22.10         | 10.2         | 56            | 33.9         | QP       | L1   | GND |
| 2.602500         | 21.20         | 10.2         | 56            | 34.8         | QP       | L1   | GND |
| Frequency<br>MHz | Level<br>dBµV | Transd<br>dB | Limit<br>dBµV | Margin<br>dB | Detector | Line | PE  |
| 0.906000         | 12.30         | 10.1         | 46            | 33.7         | AV       | L1   | GND |
| 1.059000         | 10.90         | 10.2         | 46            | 35.1         | AV       | L1   | GND |
| 1.819500         | 10.60         | 10.2         | 46            | 35.4         | AV       | L1   | GND |
| 2.652000         | 10.00         | 10.2         | 46            | 36.0         | AV       | L1   | GND |
| 23.131500        | 27.90         | 10.7         | 50            | 22.1         | AV       | L1   | GND |
| 29.238000        | 24.70         | 10.8         | 50            | 25.3         | AV       | L1   | GND |

|            |     |              |   |
|------------|-----|--------------|---|
| Test mode: | RX1 | Polarization | N |
|------------|-----|--------------|---|

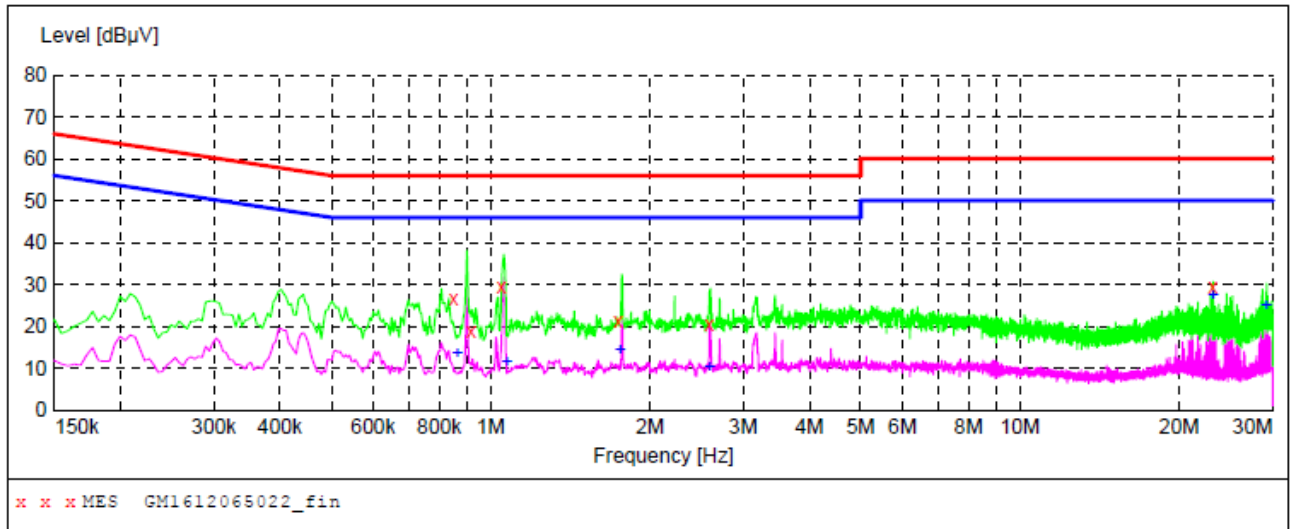

| Frequency<br>MHz | Level<br>dBµV | Transd<br>dB | Limit<br>dBµV | Margin<br>dB | Detector | Line | PE  |
|------------------|---------------|--------------|---------------|--------------|----------|------|-----|
| 0.852000         | 26.80         | 10.1         | 56            | 29.2         | QP       | N    | GND |
| 0.919500         | 18.90         | 10.2         | 56            | 37.1         | QP       | N    | GND |
| 1.050000         | 29.60         | 10.2         | 56            | 26.4         | QP       | N    | GND |
| 1.743000         | 21.40         | 10.2         | 56            | 34.6         | QP       | N    | GND |
| 2.589000         | 20.60         | 10.2         | 56            | 35.4         | QP       | N    | GND |
| 23.131500        | 29.60         | 10.7         | 60            | 30.4         | QP       | N    | GND |
| Frequency<br>MHz | Level<br>dBµV | Transd<br>dB | Limit<br>dBµV | Margin<br>dB | Detector | Line | PE  |
| 0.865500         | 13.40         | 10.1         | 46            | 32.6         | AV       | N    | GND |
| 1.072500         | 11.30         | 10.2         | 46            | 34.7         | AV       | N    | GND |
| 1.756500         | 14.50         | 10.2         | 46            | 31.5         | AV       | N    | GND |
| 2.593500         | 10.30         | 10.2         | 46            | 35.7         | AV       | N    | GND |
| 23.131500        | 27.60         | 10.7         | 50            | 22.4         | AV       | N    | GND |
| 29.238000        | 25.00         | 10.8         | 50            | 25.0         | AV       | N    | GND |



### 5.11. Radiated Emission

#### LIMIT

For unintentional device, according to § 15.109(a) except for Class A digital devices, the field strength of radiated emissions from unintentional radiators at a distance of 3 meters shall not exceed the following values:

| Frequency (MHz) | Distance (Meters) | Radiated (dBµV/m) | Radiated (µV/m) |
|-----------------|-------------------|-------------------|-----------------|
| 30-88           | 3                 | 40.0              | 100             |
| 88-216          | 3                 | 43.5              | 150             |
| 216-960         | 3                 | 46.0              | 200             |
| Above 960       | 3                 | 54.0              | 500             |

For intentional device, according to § 15.209(a), the general requirement of field strength of radiated emissions from intentional radiators at a distance of 3 meters shall not exceed the above table.

#### TEST CONFIGURATION

(A) Radiated Emission Test Set-Up, Frequency below 1000MHz

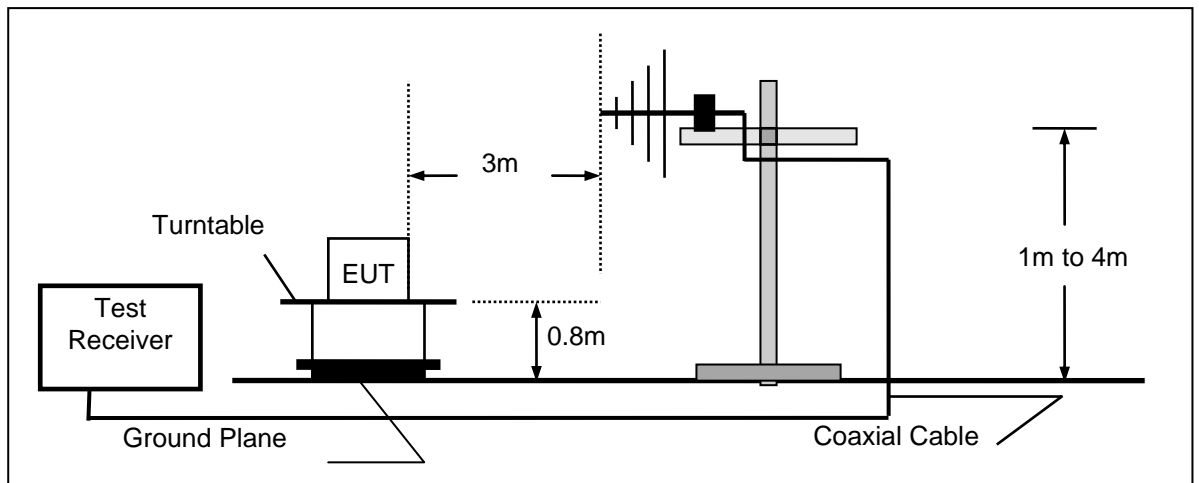

(B) Radiated Emission Test Set-Up, Frequency above 1000MHz

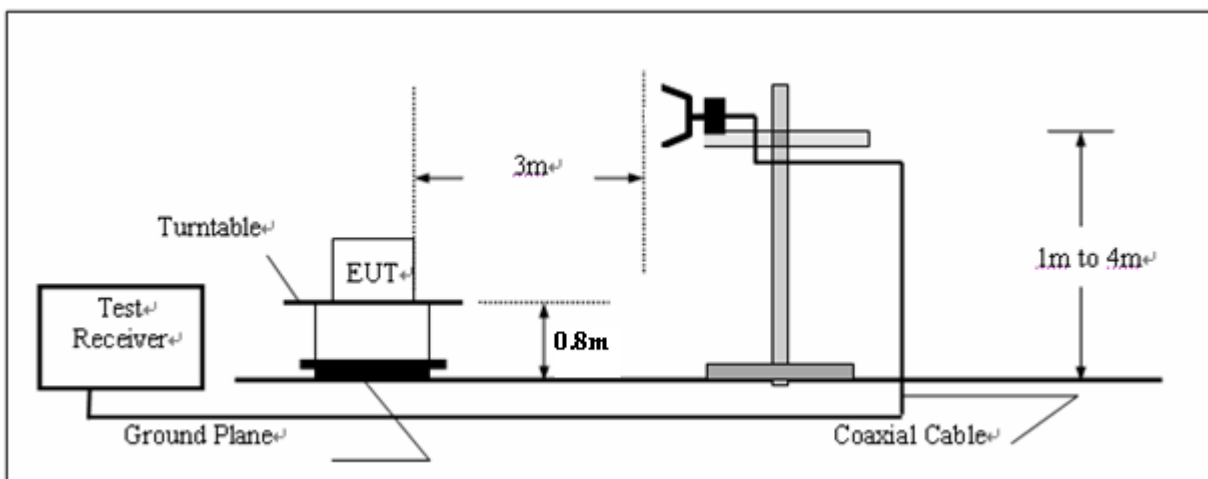

**TEST PROCEDURE**

- 1 The EUT was placed on a turn table which is 0.8m above ground plane.
- 2 Maximum procedure was performed by raising the receiving antenna from 1m to 4m and rotating the turn table from 0° to 360° to acquire the highest emissions from EUT
- 3 And also, each emission was to be maximized by changing the polarization of receiving antenna both horizontal and vertical.
- 4 Repeat above procedures until all frequency measurements have been completed.

**TEST MODE:**

Please reference to the section 3.4

**TEST RESULTS**

**Passed**       **Not Applicable**

**Note:**

1. The EUT shall be scanned from 30 MHz to the 5th harmonic of the highest oscillator frequency in the digital devices or 1 GHz whichever is higher.
2. Have pre-tested RX1 to RX2 mode, record the worst case mode RX1 on the report.

|            |     |           |            |
|------------|-----|-----------|------------|
| Test Mode: | RX1 | Polarity: | Horizontal |
|------------|-----|-----------|------------|

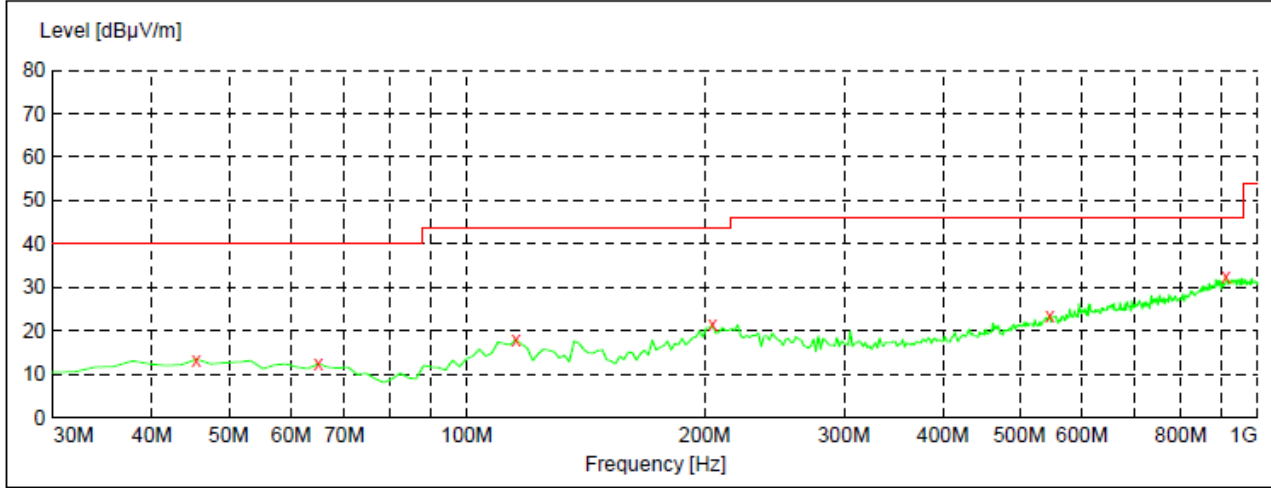

x x x MES GM1612066079\_red

| Frequency MHz | Level dBµV/m | Transd dB | Limit dBµV/m | Margin dB | Det. | Height cm | Azimuth deg | Polarization |
|---------------|--------------|-----------|--------------|-----------|------|-----------|-------------|--------------|
| 45.520000     | 13.40        | -16.5     | 40.0         | 26.6      | QP   | 100.0     | 86.00       | HORIZONTAL   |
| 64.920000     | 12.30        | -18.1     | 40.0         | 27.7      | QP   | 300.0     | 262.00      | HORIZONTAL   |
| 115.360000    | 18.00        | -18.1     | 43.5         | 25.5      | QP   | 300.0     | 18.00       | HORIZONTAL   |
| 204.600000    | 21.30        | -15.8     | 43.5         | 22.2      | QP   | 300.0     | 354.00      | HORIZONTAL   |
| 546.040000    | 23.50        | -6.3      | 46.0         | 22.5      | QP   | 300.0     | 312.00      | HORIZONTAL   |
| 912.700000    | 32.30        | 1.3       | 46.0         | 13.7      | QP   | 100.0     | 229.00      | HORIZONTAL   |

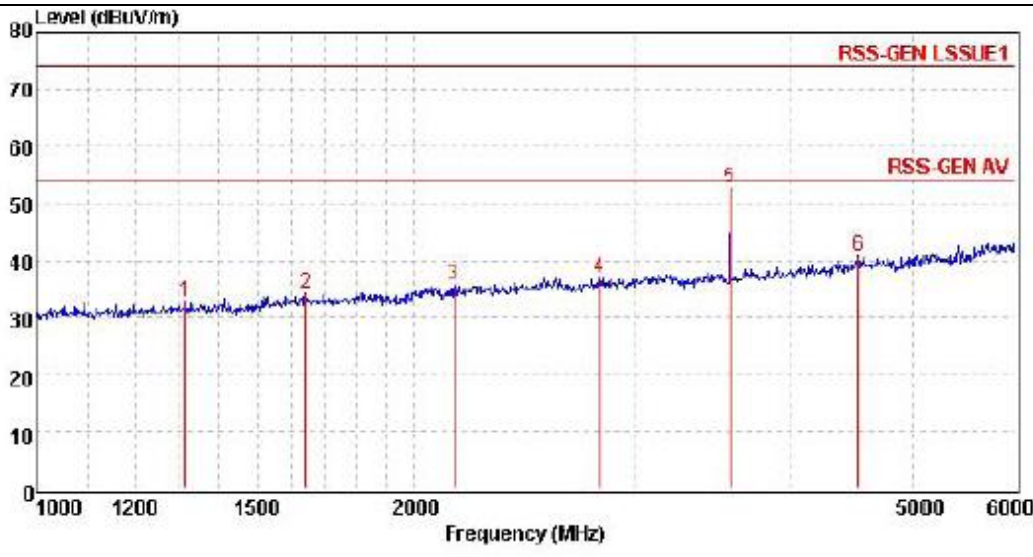

| Mark | Frequency MHz | Reading dBµV/m | Antenna dB | Cable dB | Preamp dB | Level dBµV/m | Limit dBµV/m | Over limit | Remark |
|------|---------------|----------------|------------|----------|-----------|--------------|--------------|------------|--------|
| 1    | 1315.40       | 39.87          | 24.54      | 4.86     | 36.51     | 32.76        | 74.00        | -41.24     | Peak   |
| 2    | 1639.72       | 40.15          | 25.13      | 5.65     | 36.80     | 34.13        | 74.00        | -39.87     | Peak   |
| 3    | 2153.02       | 40.03          | 25.68      | 6.40     | 37.33     | 35.78        | 74.00        | -38.22     | Peak   |
| 4    | 2811.86       | 39.67          | 28.29      | 7.38     | 38.35     | 36.99        | 74.00        | -37.01     | Peak   |
| 5    | 3568.51       | 54.02          | 28.82      | 8.22     | 38.31     | 52.75        | 74.00        | -21.25     | Peak   |
| 6    | 4512.58       | 38.03          | 30.91      | 9.32     | 37.37     | 40.89        | 74.00        | -33.11     | Peak   |

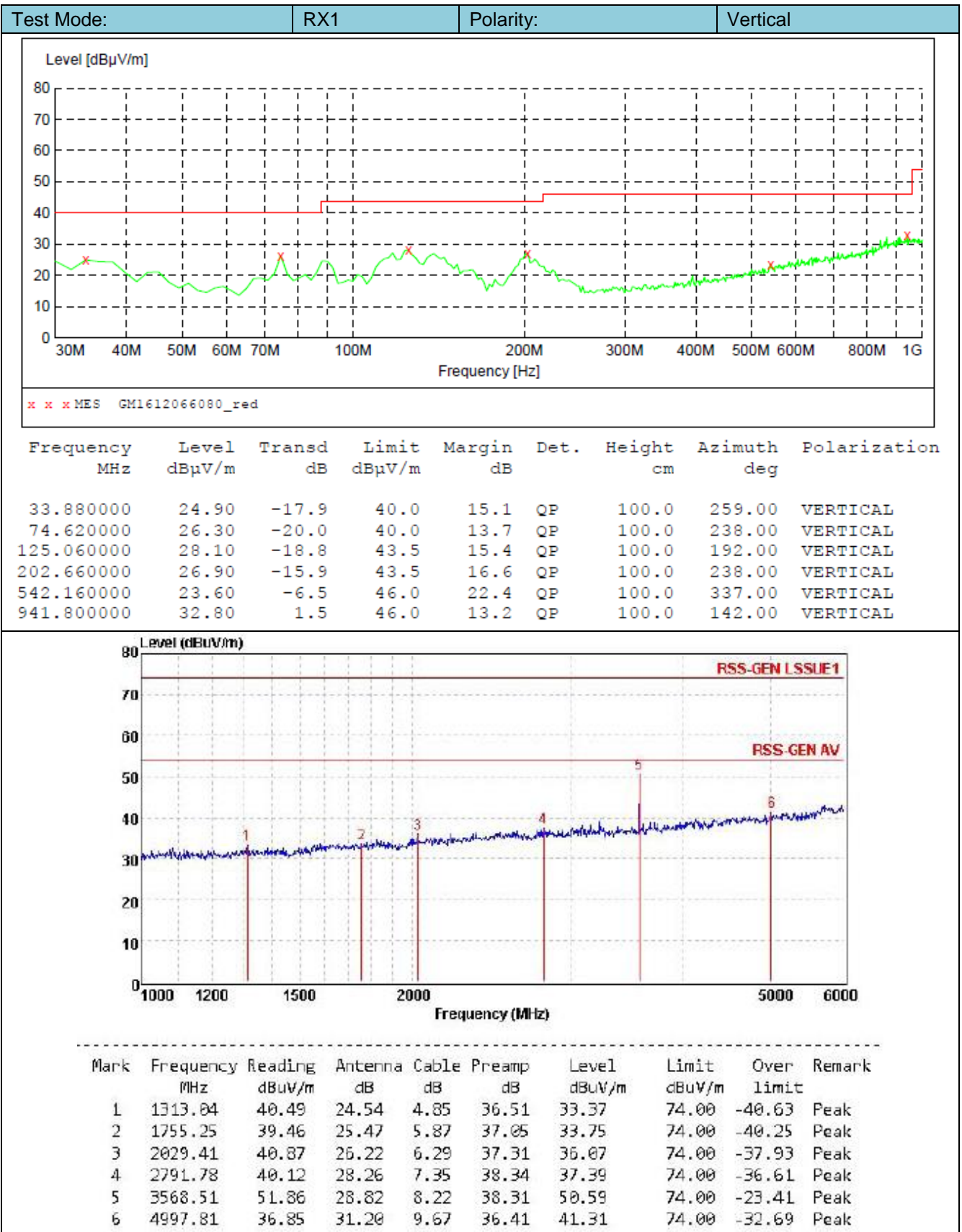

## 6. Test Setup Photos of the EUT

Transmitter Radiated Spurious Emission:



Radiated Emission:



Conducted Emission:



## 7. External and Internal Photos of the EUT External photos





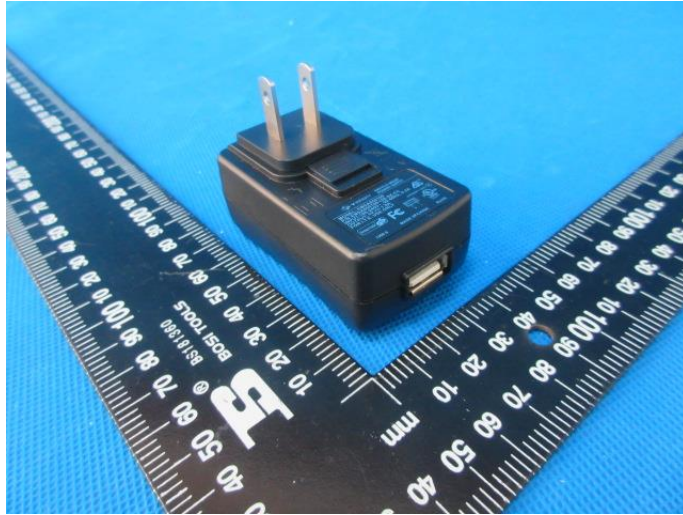

AL2AH:



AL2A:





ACK08:



ACK081:





### Internal photos

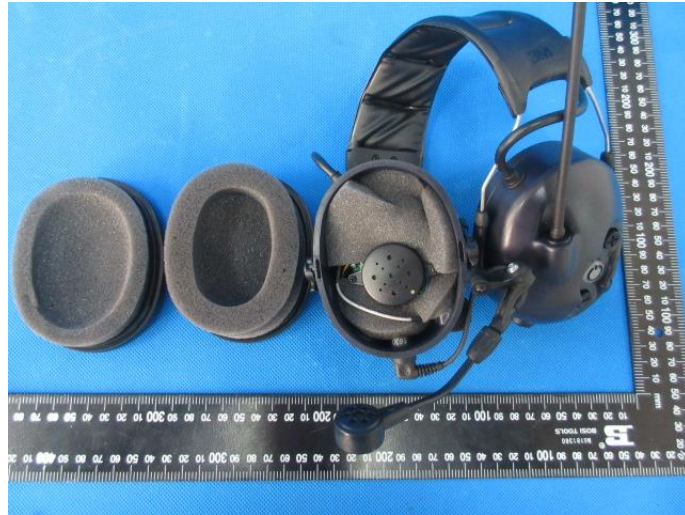



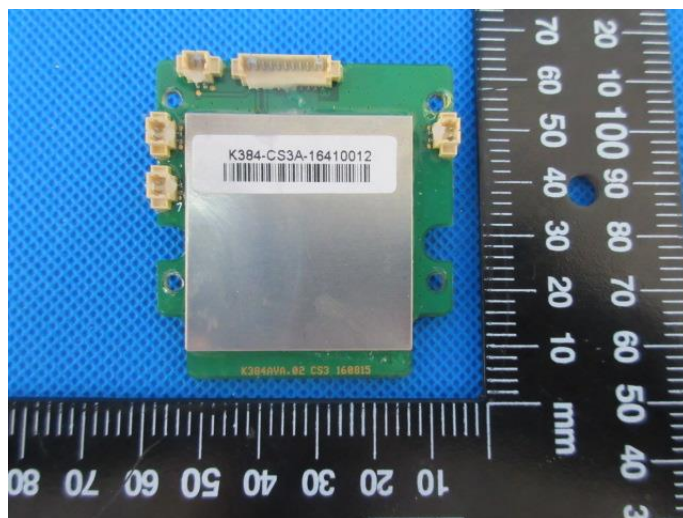
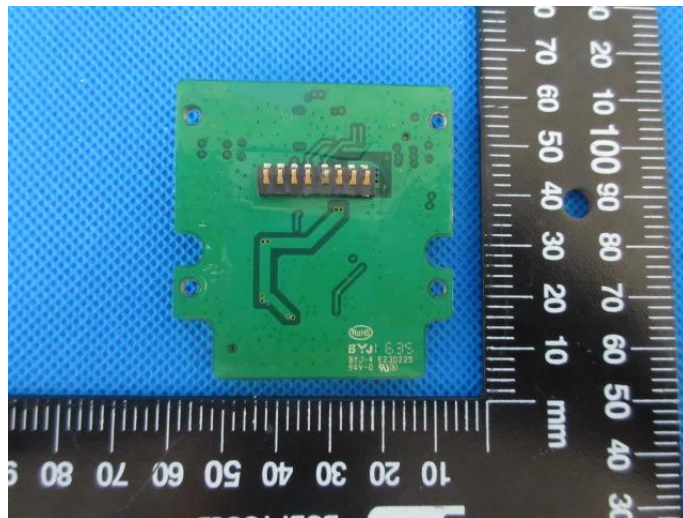

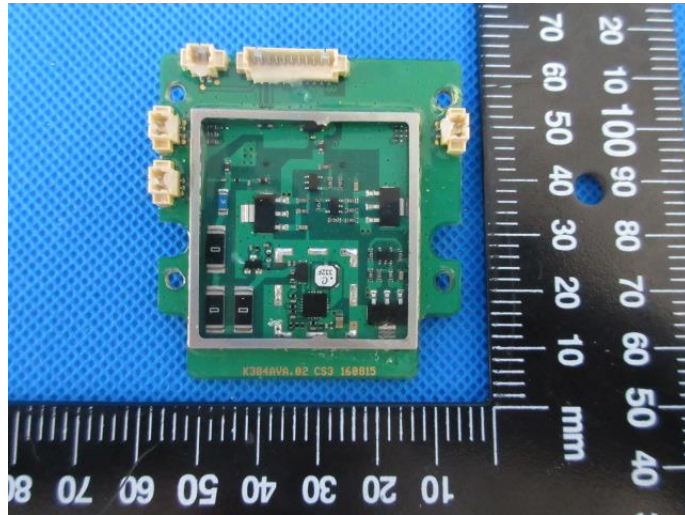

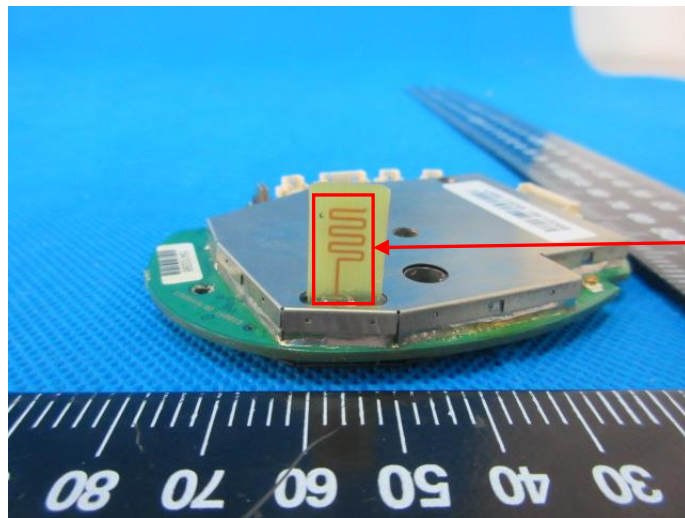
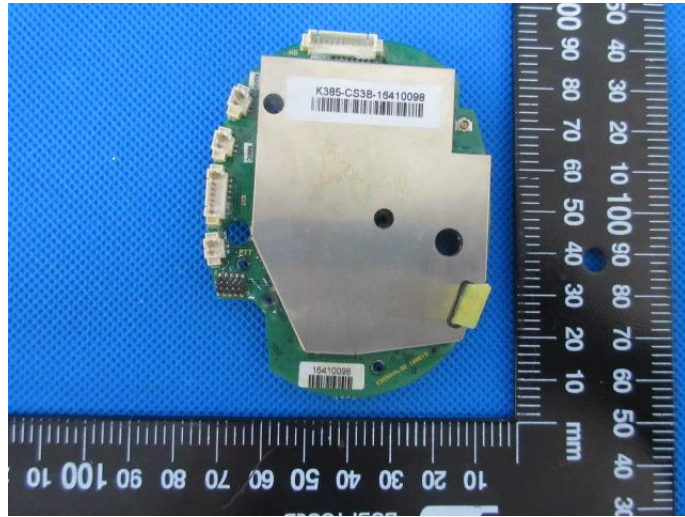

BT ANT

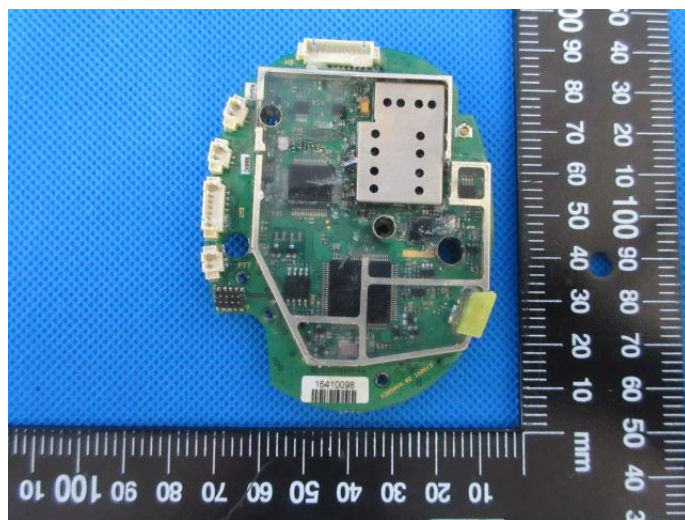

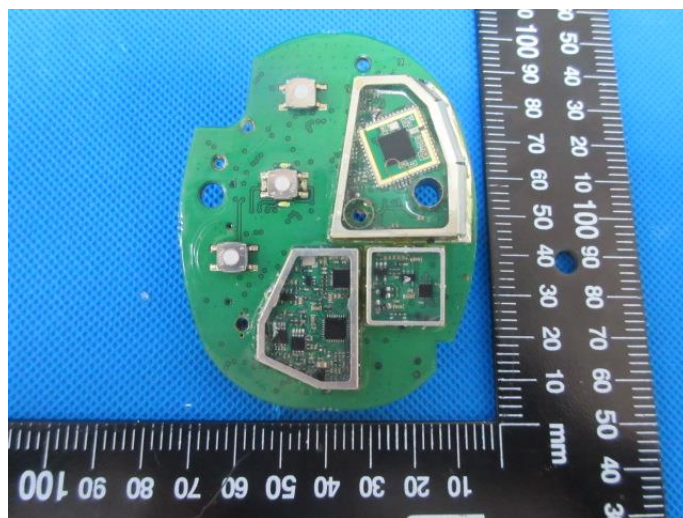
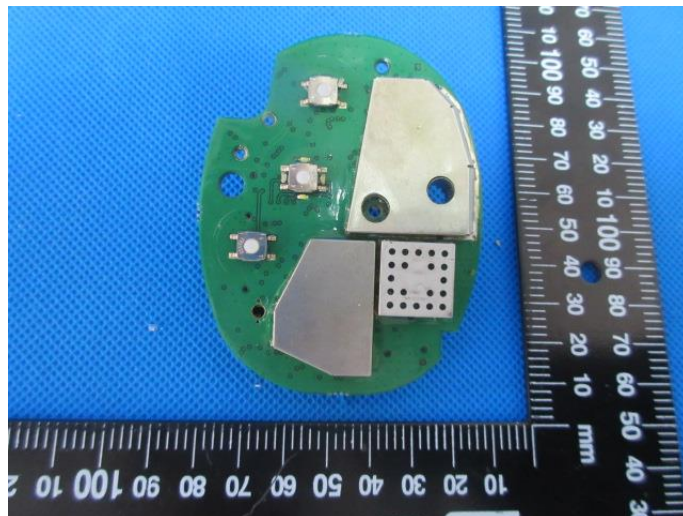
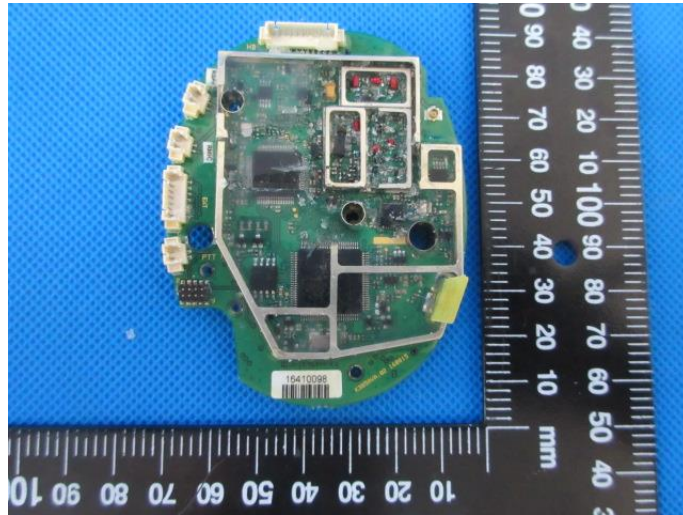

.....End of Report.....