



FCC Radio Test Report

FCC ID: Y9E-IAD18005

Original Grant

Report No. : TB-FCC164519
Applicant : IAdea Corporation
Equipment Under Test (EUT)
EUT Name : Smart Signboard
Model No. : XDS-1588
Serial Model No. : XDS-1588-A,XDS-1588-H,XDS-158X-Y(Note: X is "0~9", and Y is "A~Z", represents the appearance color or customer models)
Brand Name : IAdea
Receipt Date : 2019-03-01
Test Date : 2019-03-01 to 2019-04-30
Issue Date : 2019-05-06
Standards : FCC Part 15: 2018, Subpart C(15.247)
Test Method : ANSI C63.10: 2013
Conclusions : **PASS**

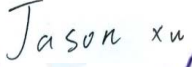
In the configuration tested, the EUT complied with the standards specified above,

Test/Witness Engineer :  Jason Xu
Engineer Supervisor :  Ivan Su
Engineer Manager :  Ray Lai



This report details the results of the testing carried out on one sample. The results contained in this test report do not relate to other samples of the same product. The manufacturer should ensure that all products in series production are in conformity with the product sample detailed in the report.

Contents

CONTENTS	2
1. GENERAL INFORMATION ABOUT EUT	5
1.1 Client Information.....	5
1.2 General Description of EUT (Equipment Under Test)	5
1.3 Block Diagram Showing the Configuration of System Tested.....	6
1.4 Description of Support Units	7
1.6 Description of Test Software Setting	8
1.7 Measurement Uncertainty	8
1.8 Test Facility.....	9
2. TEST SUMMARY	10
3. TEST EQUIPMENT	11
4. CONDUCTED EMISSION TEST	12
4.1 Test Standard and Limit.....	12
4.2 Test Setup.....	12
4.3 Test Procedure.....	12
4.4 EUT Operating Mode	13
4.5 Test Da5ta.....	13
5. RADIATED EMISSION TEST	14
5.1 Test Standard and Limit.....	14
5.2 Test Setup.....	15
5.3 Test Procedure.....	16
5.4 EUT Operating Condition	17
5.5 Test Data.....	17
6. RESTRICTED BANDS REQUIREMENT	18
6.1 Test Standard and Limit.....	18
6.2 Test Setup.....	18
6.3 Test Procedure.....	18
6.4 EUT Operating Condition	19
6.5 Test Data.....	19
7. BANDWIDTH TEST	20
7.1 Test Standard and Limit.....	20
7.2 Test Setup.....	20
7.3 Test Procedure.....	20
7.4 EUT Operating Condition	20
7.5 Test Data.....	20
8. PEAK OUTPUT POWER TEST	21
8.1 Test Standard and Limit.....	21
8.2 Test Setup.....	21
8.3 Test Procedure.....	21

8.4 EUT Operating Condition	21
8.5 Test Data.....	21
9. POWER SPECTRAL DENSITY TEST	22
9.1 Test Standard and Limit.....	22
9.2 Test Setup.....	22
9.3 Test Procedure.....	22
9.4 EUT Operating Condition	22
9.5 Test Data.....	22
10. ANTENNA REQUIREMENT.....	23
10.1 Standard Requirement.....	23
10.2 Antenna Connected Construction.....	23
10.3 Result.....	23
ATTACHMENT A-- CONDUCTED EMISSION TEST DATA	24
ATTACHMENT B-- RADIATED EMISSION TEST DATA	26
ATTACHMENT C-- RESTRICTED BANDS REQUIREMENT AND BAND-EDGE TEST DATA	35
ATTACHMENT D-- BANDWIDTH TEST DATA.....	40
ATTACHMENT E-- PEAK OUTPUT POWER TEST DATA.....	42
ATTACHMENT F-- POWER SPECTRAL DENSITY TEST DATA.....	44

1. General Information about EUT

1.1 Client Information

Applicant	:	IAdea Corporation
Address	:	3F, No. 21 Lane 168, Xingshan Road, Neihu Dist., Taipei, Taiwan
Manufacturer	:	IAdea Corporation
Address	:	3F, No. 21 Lane 168, Xingshan Road, Neihu Dist., Taipei, Taiwan

1.2 General Description of EUT (Equipment Under Test)

EUT Name	:	Smart Signboard
Models No.	:	XDS-1588, XDS-1588-A, XDS-1588-H, XDS-158X-Y(Note: X is "0~9", and Y is "A~Z", represents the appearance color or customer models)
Model Difference	:	All these models are the same PCB, layout and electrical circuit, the only different is appearance color or customer models.
Product Description	Operation Frequency:	Bluetooth 4.0(BLE): 2402MHz~2480MHz
	Number of Channel:	Bluetooth 4.0(BLE): 40 channels see note(3)
	RF Output Power:	BLE:8.155 dBm
	Antenna Gain:	1.14dBi FPC Antenna
	Modulation Type:	GFSK
	Bit Rate of Transmitter:	1Mbps(GFSK)
Power Supply	:	AC Adapter(FJ-SW1202000N): Input: AC 100-240V, 50/60Hz, 0.6A Output: DC 12V, 2.0A
Software Version	:	N/A
Hardware Version	:	R35
Connecting I/O Port(S)	:	Please refer to the User's Manual

Note:

This Test Report is FCC Part 15.247 for Bluetooth BLE, the test procedure follows the FCC KDB 558074 D01 DTS Means Guidance v05.

- (1) For a more detailed features description, please refer to the manufacturer's specifications or the User's Manual.
- (2) Antenna information provided by the applicant.

(3) Channel List:

Channel	Frequency (MHz)	Channel	Frequency (MHz)	Channel	Frequency (MHz)
00	2402	14	2430	28	2458
01	2404	15	2432	29	2460
02	2406	16	2434	30	2462
03	2408	17	2436	31	2464
04	2410	18	2438	32	2466
05	2412	19	2440	33	2468
06	2414	20	2442	34	2470
07	2416	21	2444	35	2472
08	2418	22	2446	36	2474
09	2420	23	2448	37	2476
10	2422	24	2450	38	2478
11	2424	25	2452	39	2480
12	2426	26	2454		
13	2428	27	2456		

1.3 Block Diagram Showing the Configuration of System Tested

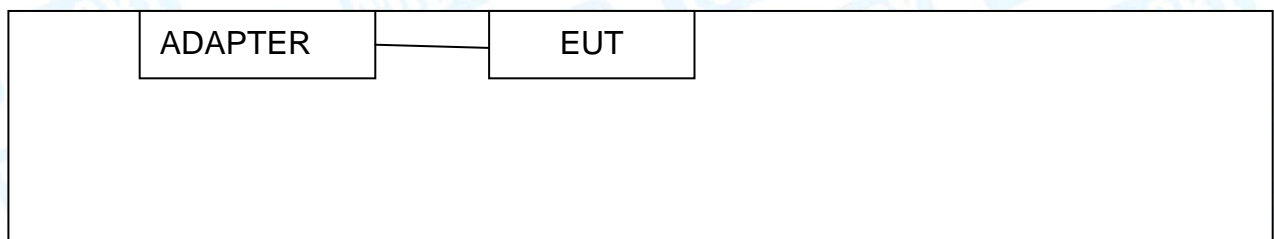

1.4 Description of Support Units

Equipment Information				
Name	Model	FCC ID/VOC	Manufacturer	Used “√”
ADAPTER	FJ-SW1202000N	----	/	√

1.5 Description of Test Mode

To investigate the maximum EMI emission characteristics generates from EUT, the test system was pre-scanning tested base on the consideration of following EUT operation mode or test configuration mode which possible have effect on EMI emission level. Each of these EUT operation mode(s) or test configuration mode(s) mentioned follow was evaluated respectively.

For Conducted Test	
Final Test Mode	Description
Mode 1	Normal Working+ TX Mode (Channel 20)

For Radiated Test	
Final Test Mode	Description
Mode 1	Normal Working+ TX Mode (Channel 20)
Mode 2	Normal Working+ TX Mode (Channel 00/20/39)

Note:

- (1) For all test, we have verified the construction and function in typical operation. And all the test modes were carried out with the EUT in transmitting operation in maximum power with all kinds of data rate.

According to ANSI C63.10 standards, the measurements are performed at the highest, middle, lowest available channels, and the worst case data rate as follows:

BLE Mode: GFSK Modulation Transmitting mode.

- (2) During the testing procedure, the continuously transmitting with the maximum power mode was programmed by the customer.
- (3) The EUT is considered a portable unit; in normal use it was positioned on X-plane. The worst case was found positioned on X-plane. Therefore only the test data of this X-plane was used for radiated emission measurement test.

1.6 Description of Test Software Setting

During testing channel & Power controlling software provided by the customer was used to control the operating channel as well as the output power level. The RF output power selection is for the setting of RF output power expected by the customer and is going to be fixed on the firmware of the final end product power parameters of RF setting.

Test Software Version	RFTestTool.exe		
Frequency	2402 MHz	2442MHz	2480 MHz
BLE GFSK	DEF	DEF	DEF

1.7 Measurement Uncertainty

The reported uncertainty of measurement $y \pm U$, where expanded uncertainty U is based on a standard uncertainty multiplied by a coverage factor of $k=2$, providing a level of confidence of approximately 95 %.

Test Item	Parameters	Expanded Uncertainty (U_{Lab})
Conducted Emission	Level Accuracy: 9kHz~150kHz	± 3.42 dB
	150kHz to 30MHz	± 3.42 dB
Radiated Emission	Level Accuracy: 9kHz to 30 MHz	± 4.60 dB
Radiated Emission	Level Accuracy: 30MHz to 1000 MHz	± 4.40 dB
Radiated Emission	Level Accuracy: Above 1000MHz	± 4.20 dB

1.8 Test Facility

The testing was performed by the Shenzhen Toby Technology Co., Ltd., in their facilities located at:1A/F., Bldg.6, Yusheng Industrial Zone, The National Road No.107 Xixiang Section 467, Xixiang, Bao'an, Shenzhen, Guangdong, China.

At the time of testing, the following bodies accredited the Laboratory:

CNAS (L5813)

The Laboratory has been accredited by CNAS to ISO/IEC 17025: 2005 General Requirements for the Competence of Testing and Calibration Laboratories for the competence in the field of testing. And the Registration No.: CNAS L5813.

A2LA Certificate No.: 4750.01

The laboratory has been accredited by American Association for Laboratory Accreditation(A2LA) to ISO/IEC 17025: 2005 General Requirements for the Competence of Testing and Calibration Laboratories for the technical competence in the field of Electrical Testing. And the A2LA Certificate No.: 4750.01. FCC Accredited Test Site Number: 854351.

IC Registration No.: (11950A-1)

The Laboratory has been registered by Certification and Engineering Bureau of Industry Canada for radio equipment testing. The site registration: Site# 11950A-1.

2. Test Summary

FCC Part 15 Subpart C(15.247)/RSS 247 Issue 2				
Standard Section		Test Item	Judgment	Remark
FCC	IC			
15.203		Antenna Requirement	PASS	N/A
15.207(a)	RSS-GEN 7.2.4	Conducted Emission	PASS	N/A
15.205&15.247(d)	RSS-GEN 7.2.2	Band-Edge & Unwanted Emissions into Restricted Frequency	PASS	N/A
15.247(a)(2)	RSS 247 5.2 (1)	6dB Bandwidth	PASS	N/A
15.247(b)(3)	RSS 247 5.4 (4)	Conducted Max Output Power	PASS	N/A
15.247(e)	RSS 247 5.2 (2)	Power Spectral Density	PASS	N/A
15.205, 15.209&15.247(d)	RSS 247 5.5	Transmitter Radiated Spurious & Unwanted Emissions into Restricted Frequency	PASS	N/A

Note: N/A is an abbreviation for Not Applicable.

3. Test Equipment

Conducted Emission Test					
Equipment	Manufacturer	Model No.	Serial No.	Last Cal.	Cal. Due Date
EMI Test Receiver	Rohde & Schwarz	ESCI	100321	Jul. 18, 2018	Jul. 17, 2019
RF Switching Unit	Compliance Direction Systems Inc	RSU-A4	34403	Jul. 18, 2018	Jul. 17, 2019
AMN	SCHWARZBECK	NNBL 8226-2	8226-2/164	Jul. 18, 2018	Jul. 17, 2019
LISN	Rohde & Schwarz	ENV216	101131	Jul. 18, 2018	Jul. 17, 2019
Radiation Emission Test					
Equipment	Manufacturer	Model No.	Serial No.	Last Cal.	Cal. Due Date
Spectrum Analyzer	Agilent	E4407B	MY45106456	Jul. 18, 2018	Jul. 17, 2019
EMI Test Receiver	Rohde & Schwarz	ESPI	100010/007	Jul. 18, 2018	Jul. 17, 2019
Bilog Antenna	ETS-LINDGREN	3142E	00117537	Jan. 27, 2019	Jan. 26, 2020
Bilog Antenna	ETS-LINDGREN	3142E	00117542	Jan. 27, 2019	Jan. 26, 2020
Horn Antenna	ETS-LINDGREN	3117	00143207	Mar.03, 2019	Mar. 02, 2020
Horn Antenna	ETS-LINDGREN	3117	00143209	Mar.03, 2019	Mar. 02, 2020
Loop Antenna	SCHWARZBECK	FMZB 1519 B	1519B-059	Jan. 27, 2019	Jan. 26, 2020
Pre-amplifier	Sonoma	310N	185903	Mar.04, 2019	Mar. 03, 2020
Pre-amplifier	HP	8449B	3008A00849	Mar.03, 2019	Mar. 02, 2020
Cable	HUBER+SUHNER	100	SUCOFLEX	Mar.03, 2019	Mar. 02, 2020
Positioning Controller	ETS-LINDGREN	2090	N/A	N/A	N/A
Antenna Conducted Emission					
Equipment	Manufacturer	Model No.	Serial No.	Last Cal.	Cal. Due Date
Spectrum Analyzer	Agilent	E4407B	MY45106456	Jul. 18, 2018	Jul. 17, 2019
Spectrum Analyzer	Rohde & Schwarz	ESCI	100010/007	Jul. 18, 2018	Jul. 17, 2019
MXA Signal Analyzer	Agilent	N9020A	MY49100060	Sep. 15, 2018	Sep. 14, 2019
Vector Signal Generator	Agilent	N5182A	MY50141294	Sep. 15, 2018	Sep. 14, 2019
Analog Signal Generator	Agilent	N5181A	MY50141953	Sep. 15, 2018	Sep. 14, 2019
RF Power Sensor	DARE!! Instruments	RadiPowerRPR3006W	17I00015SNO26	Sep. 15, 2018	Sep. 14, 2019
	DARE!! Instruments	RadiPowerRPR3006W	17I00015SNO29	Sep. 15, 2018	Sep. 14, 2019
	DARE!! Instruments	RadiPowerRPR3006W	17I00015SNO31	Sep. 15, 2018	Sep. 14, 2019
	DARE!! Instruments	RadiPowerRPR3006W	17I00015SNO33	Sep. 15, 2018	Sep. 14, 2019

4. Conducted Emission Test

4.1 Test Standard and Limit

4.1.1 Test Standard

FCC Part 15.207

4.1.2 Test Limit

Conducted Emission Test Limit

Frequency	Maximum RF Line Voltage (dB μ V)	
	Quasi-peak Level	Average Level
150kHz~500kHz	66 ~ 56 *	56 ~ 46 *
500kHz~5MHz	56	46
5MHz~30MHz	60	50

Notes:

(1) *Decreasing linearly with logarithm of the frequency.

(2) The lower limit shall apply at the transition frequencies.

(3) The limit decrease in line with the logarithm of the frequency in the range of 0.15 to 0.50MHz.

4.2 Test Setup

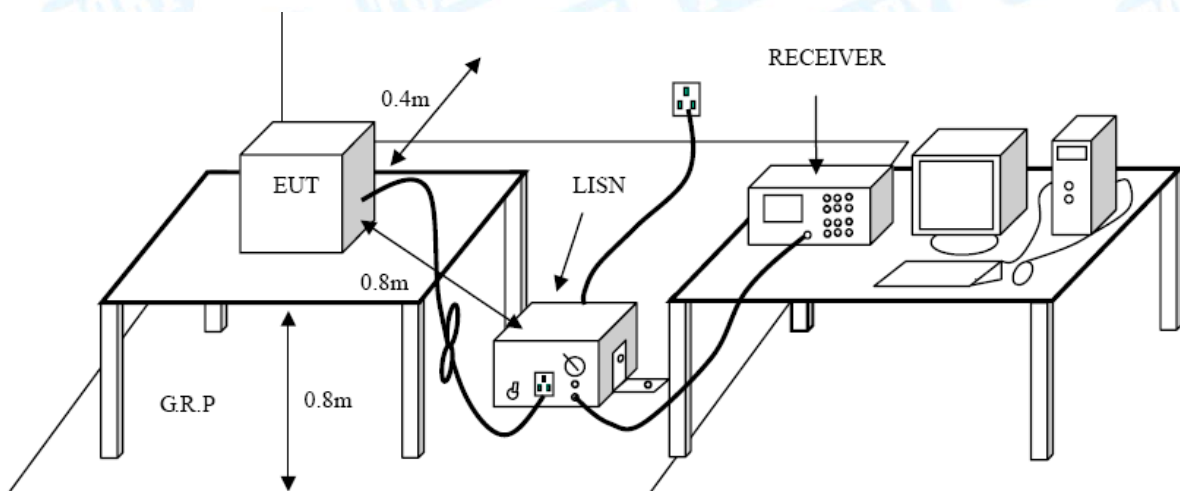

4.3 Test Procedure

The EUT was placed 0.8 meters from the horizontal ground plane with EUT being connected to the power mains through a line impedance stabilization network (LISN). All other support equipments powered from additional LISN(s). The LISN provide 50 Ohm/ 50uH of coupling impedance for the measuring instrument.

Interconnecting cables that hang closer than 40 cm to the ground plane shall be folded back and forth in the center forming a bundle 30 to 40 cm long.

I/O cables that are not connected to a peripheral shall be bundled in the center. The end of the cable may be terminated, if required, using the correct terminating impedance. The overall length shall not exceed 1 m.

LISN at least 80 cm from nearest part of EUT chassis.

The bandwidth of EMI test receiver is set at 9 kHz, and the test frequency band is from 0.15MHz to 30MHz.

4.4 EUT Operating Mode

Please refer to the description of test mode.

4.5 Test Da5ta

Please refer to the Attachment A.

5. Radiated Emission Test

5.1 Test Standard and Limit

5.1.1 Test Standard

FCC Part 15.247(d)

5.1.2 Test Limit

Radiated Emission Limits (9kHz~1000MHz)

Frequency (MHz)	Field Strength (microvolt/meter)	Measurement Distance (meters)
0.009~0.490	2400/F(KHz)	300
0.490~1.705	24000/F(KHz)	30
1.705~30.0	30	30
30~88	100	3
88~216	150	3
216~960	200	3
Above 960	500	3

Radiated Emission Limit (Above 1000MHz)

Frequency (MHz)	Distance Meters(at 3m)	
	Peak (dBuV/m)	Average (dBuV/m)
Above 1000	74	54

Note:

- (1) The tighter limit applies at the band edges.
- (2) Emission Level (dBuV/m)=20log Emission Level (uV/m)

5.2 Test Setup

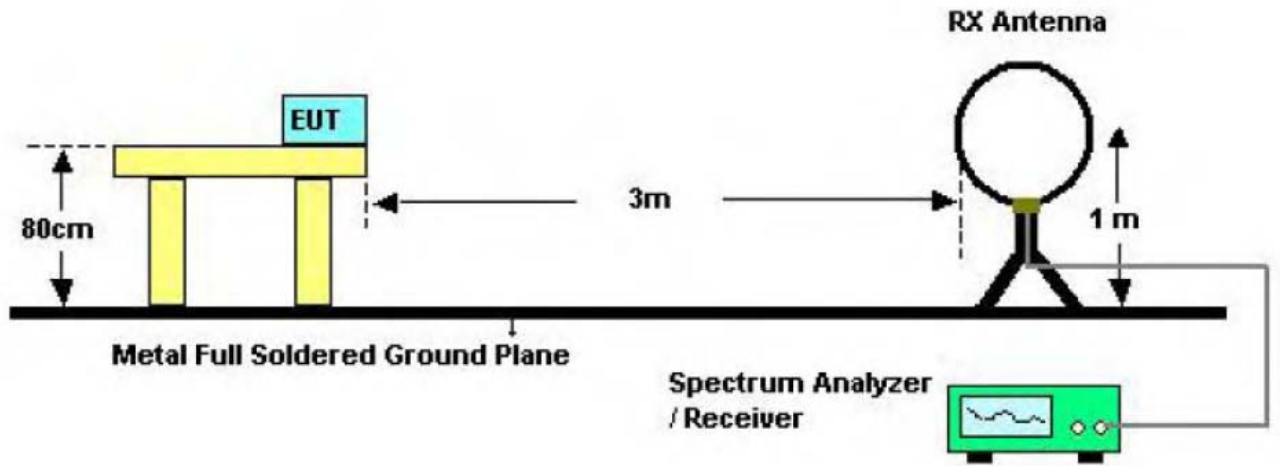

Below 30MHz Test Setup

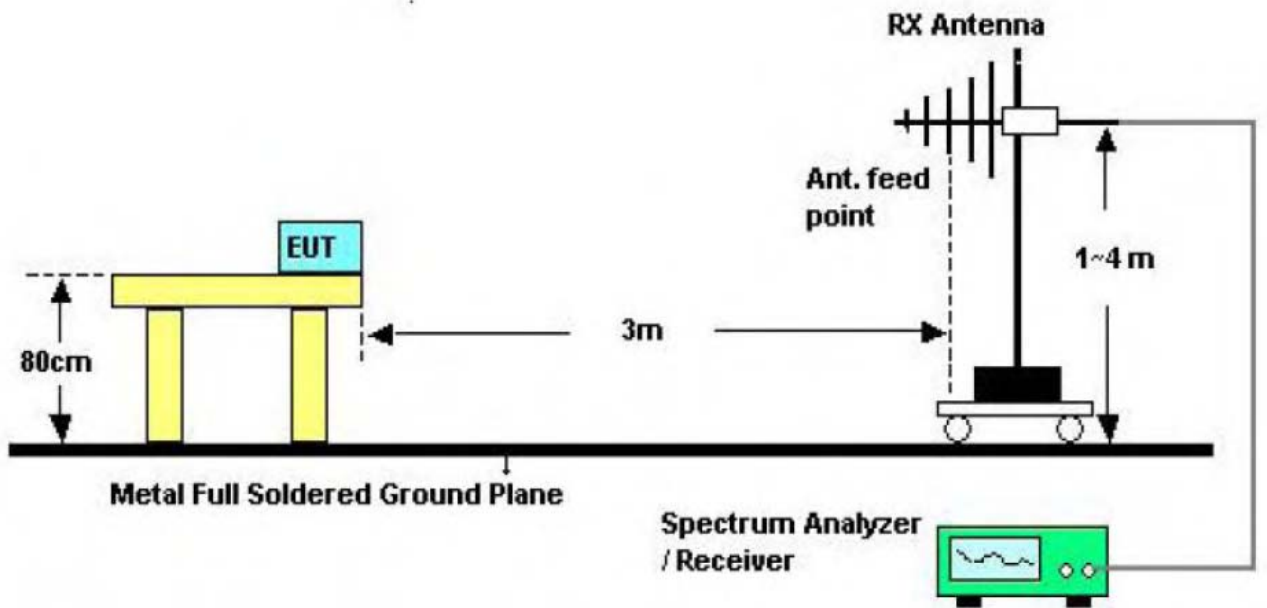

Below 1000MHz Test Setup



Above 1GHz Test Setup

5.3 Test Procedure

- (1) The measuring distance of 3m shall be used for measurements at frequency up to 1GHz and above 1 GHz. The EUT was placed on a rotating 0.8m high above ground, the table was rotated 360 degrees to determine the position of the highest radiation.
- (2) Measurements at frequency above 1GHz. The EUT was placed on a rotating 1.5m high above the ground. RF absorbers covered the ground plane with a minimum area of 3.0m by 3.0m between the EUT and measurement receiver antenna. The RF absorber shall not exceed 30cm in high above the conducting floor. The table was rotated 360 degrees to determine the position of the highest radiation.
- (3) The Test antenna shall vary between 1m and 4m, Both Horizontal and Vertical antenna are set to make measurement.
- (4) The initial step in collecting conducted emission data is a spectrum analyzer peak detector mode pre-scanning the measurement frequency range. Significant peaks are then marked and then Quasi Peak detector mode re-measured.
- (5) If the Peak Mode measured value compliance with and lower than Quasi Peak Mode Limit Bellow 1 GHz, the EUT shall be deemed to meet QP Limits and then no additional QP Mode measurement performed. But the Peak Value and average value both need to comply with applicable limit above 1 GHz.
- (6) Testing frequency range below 1GHz the measuring instrument use VBW=120 kHz with Quasi-peak detection.
- (7) Testing frequency range above 1GHz the measuring instrument use RBW=1 MHz and VBW=3 MHz with Peak Detector for Peak Values, and use RBW=1 MHz and VBW=10 Hz with Peak Detector for Average Values.
- (8) For the actual test configuration, please see the test setup photo.

5.4 EUT Operating Condition

The Equipment Under Test was set to Continual Transmitting in maximum power.

5.5 Test Data

Remark: During testing above 1GHz the measuring instrument use RBW=1 MHz and VBW=3 MHz with Peak Detector for Peak Values, and use RBW=1 MHz and VBW=10 Hz with Peak Detector for Average Values.

Please refer to the Attachment B.

6. Restricted Bands Requirement

6.1 Test Standard and Limit

6.1.1 Test Standard

FCC Part 15.247(d) FCC Part 15.205

6.1.2 Test Limit

Restricted Frequency Band (MHz)	Distance Meters(at 3m)	
	Peak (dBuV/m)	Average (dBuV/m)
2310 ~2390	74	54
2483.5 ~2500	74	54

6.2 Test Setup

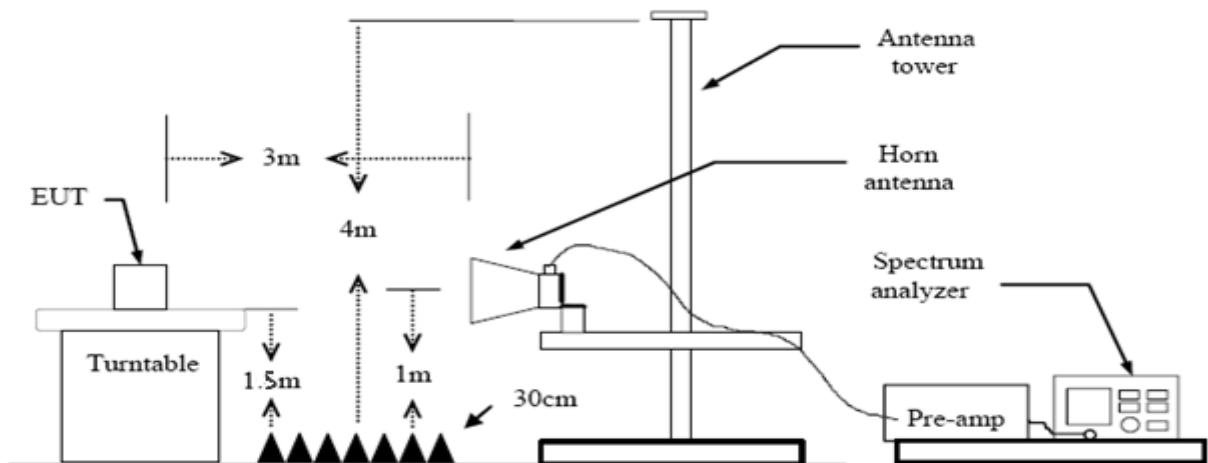

6.3 Test Procedure

- (1) The measuring distance of 3m shall be used for measurements at frequency up to 1GHz and above 1 GHz. The EUT was placed on a rotating 0.8m high above ground, the table was rotated 360 degrees to determine the position of the highest radiation.
- (2) Measurements at frequency above 1GHz. The EUT was placed on a rotating 1.5m high above the ground. RF absorbers covered the ground plane with a minimum area of 3.0m by 3.0m between the EUT and measurement receiver antenna. The RF absorber shall not exceed 30cm in high above the conducting floor. The table was rotated 360 degrees to determine the position of the highest radiation.
- (3) The Test antenna shall vary between 1m and 4m, Both Horizontal and Vertical antenna are set to make measurement.
- (4) The initial step in collecting conducted emission data is a spectrum analyzer peak detector

mode pre-scanning the measurement frequency range. Significant peaks are then marked and then Quasi Peak detector mode re-measured.

- (5) If the Peak Mode measured value compliance with and lower than Quasi Peak Mode Limit Bellow 1 GHz, the EUT shall be deemed to meet QP Limits and then no additional QP Mode measurement performed. But the Peak Value and average value both need to comply with applicable limit above 1 GHz.
- (6) Testing frequency range below 1GHz the measuring instrument use VBW=120 kHz with Quasi-peak detection.
- (7) Testing frequency range above 1GHz the measuring instrument use RBW=1 MHz and VBW=3 MHz with Peak Detector for Peak Values, and use RBW=1 MHz and VBW=10 Hz with Peak Detector for Average Values.
- (8) For the actual test configuration, please see the test setup photo.

6.4 EUT Operating Condition

The Equipment Under Test was set to Continual Transmitting in maximum power.

6.5 Test Data

Remark: During testing above 1GHz the measuring instrument use RBW=1 MHz and VBW=3 MHz with Peak Detector for Peak Values, and use RBW=1 MHz and VBW=10 Hz with Peak Detector for Average Values.

Please refer to the Attachment C.

7. Bandwidth Test

7.1 Test Standard and Limit

7.1.1 Test Standard

FCC Part 15.247 (a)(2)

7.1.2 Test Limit

FCC Part 15 Subpart C(15.247)/RSS-247		
Test Item	Limit	Frequency Range(MHz)
Bandwidth	≥ 500 KHz (6dB bandwidth)	2400~2483.5

7.2 Test Setup

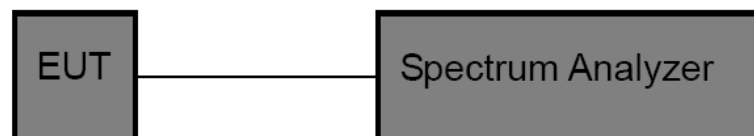

7.3 Test Procedure

- (1) The EUT was directly connected to the spectrum analyzer and antenna output port as show in the block diagram above.
- (2) The bandwidth is measured at an amplitude level reduced 6dB from the reference level. The reference level is the level of the highest amplitude signal observed from the transmitter at the fundamental frequency. Once the reference level is established, the equipment is conditioned with typical modulating signal to produce the worst -case (i.e the widest) bandwidth.
- (3) Measure the channel separation the spectrum analyzer was set to Resolution Bandwidth:100 kHz, and Video Bandwidth:300 kHz, Detector: Peak, Sweep Time set auto.

7.4 EUT Operating Condition

The EUT was set to continuously transmitting in each mode and low, middle and high channel for the test.

7.5 Test Data

Please refer to the Attachment D.

8. Peak Output Power Test

8.1 Test Standard and Limit

8.1.1 Test Standard

FCC Part 15.247 (b)(3)

8.1.2 Test Limit

FCC Part 15 Subpart C(15.247)/RSS-247		
Test Item	Limit	Frequency Range(MHz)
Peak Output Power	1 Watt or 30 dBm	2400~2483.5

8.2 Test Setup

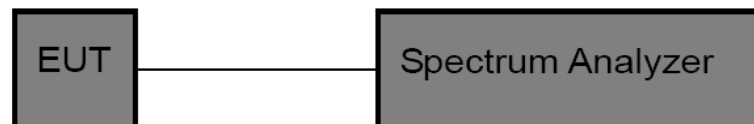

8.3 Test Procedure

The EUT was directly connected to the Spectrum Analyzer and antenna output port as show in the block diagram above. The measurement is according to section 9.1.1 of KDB 558074 D01 DTS Meas Guidance v05.

- (1) Set the $RBW \geq DTS$ Bandwidth
- (2) Set $VBW \geq 3 * RBW$
- (3) Set $Span \geq 3 * RBW$
- (4) Sweep time=auto
- (5) Detector= peak
- (6) Trace mode= maxhold.
- (7) Allow trace to fully stabilize, and then use peak marker function to determine the peak amplitude level.

8.4 EUT Operating Condition

The EUT was set to continuously transmitting in the max power during the test.

8.5 Test Data

Please refer to the Attachment E.

9. Power Spectral Density Test

9.1 Test Standard and Limit

- 9.1.1 Test Standard
FCC Part 15.247 (e)
- 9.1.2 Test Limit

FCC Part 15 Subpart C(15.247)		
Test Item	Limit	Frequency Range(MHz)
Power Spectral Density	8dBm(in any 3 kHz)	2400~2483.5

9.2 Test Setup

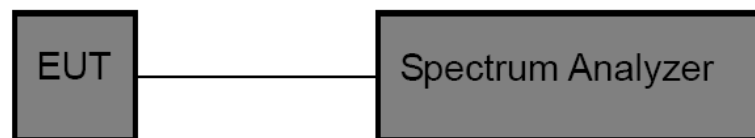

9.3 Test Procedure

The EUT was directly connected to the Spectrum Analyzer and antenna output port as show in the block diagram above. The measurement according to section 10.2 of KDB 558074 D01 DTS Meas Guidance v05.

- (1) The EUT was directly connected to the spectrum analyzer and antenna output port as show in the block diagram above.
- (2) Set analyser center frequency to DTS channel center frequency.
- (3) Set the span to 1.5 times the DTS bandwidth.
- (4) Set the RBW to: 3 kHz
- (5) Set the VBW to: 10 kHz
- (6) Detector: peak
- (7) Sweep time: auto
- (8) Allow trace to fully stabilize. Then use the peak marker function to determine the maximum amplitude level.

9.4 EUT Operating Condition

The EUT was set to continuously transmitting in each mode and low, Middle and high channel for the test.

9.5 Test Data

Please refer to the Attachment F.

10. Antenna Requirement

10.1 Standard Requirement

10.1.1 Standard

FCC Part 15.203

10.1.2 Requirement

An intentional radiator shall be designed to ensure that no antenna other than that furnished by the responsible party shall be used with the device. The use of a permanently attached antenna or of an antenna that uses a unique coupling to the intentional radiator shall be considered sufficient to comply with the provisions of this Section. The manufacturer may design the unit so that a broken antenna can be replaced by the user, but the use of a standard antenna jack or electrical connector is prohibited.

10.2 Antenna Connected Construction

The gains of the antenna used for transmitting is 1.14dBi, and the antenna de-signed with permanent attachment and no consideration of replacement. Please see the EUT photo for details.

10.3 Result

The EUT antenna is a FPC Antenna. It complies with the standard requirement.

Antenna Type
<input type="checkbox"/> Permanent attached antenna
<input checked="" type="checkbox"/> Unique connector antenna
<input type="checkbox"/> Professional installation antenna

Attachment A-- Conducted Emission Test Data

Temperature:	25°C	Relative Humidity:	55%
Test Voltage:	AC 120V 60Hz		
Terminal:	Line		
Test Mode:	Mode 1		
Remark:	Only worse case is reported		

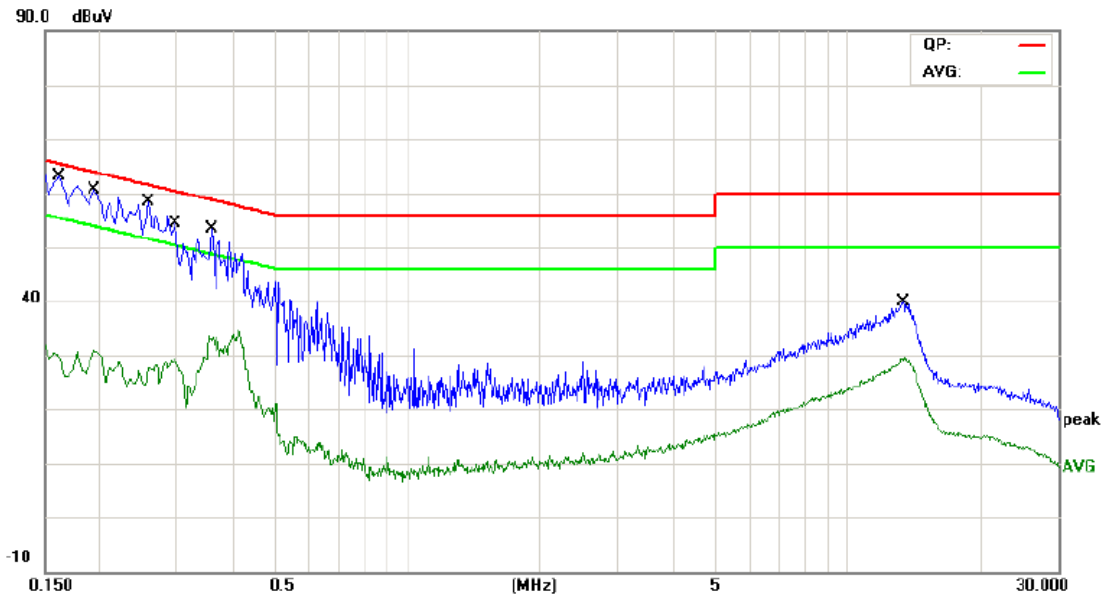

No.	Mk.	Freq. MHz	Reading Level dBuV	Correct Factor dB	Measure- ment dBuV	Limit dBuV	Over dB	Detector
1	*	0.1620	44.93	9.58	54.51	65.36	-10.85	QP
2		0.1620	17.12	9.58	26.70	55.36	-28.66	AVG
3		0.1940	41.28	9.58	50.86	63.86	-13.00	QP
4		0.1940	17.71	9.58	27.29	53.86	-26.57	AVG
5		0.2580	35.74	9.59	45.33	61.49	-16.16	QP
6		0.2580	14.84	9.59	24.43	51.49	-27.06	AVG
7		0.2980	33.40	9.59	42.99	60.30	-17.31	QP
8		0.2980	17.60	9.59	27.19	50.30	-23.11	AVG
9		0.3580	31.53	9.60	41.13	58.77	-17.64	QP
10		0.3580	21.40	9.60	31.00	48.77	-17.77	AVG
11		13.3860	23.84	10.33	34.17	60.00	-25.83	QP
12		13.3860	18.54	10.33	28.87	50.00	-21.13	AVG

Emission Level= Read Level+ Correct Factor

Temperature:	25°C	Relative Humidity:	55%
Test Voltage:	AC 120V 60Hz		
Terminal:	Neutral		
Test Mode:	Mode 1		
Remark:	Only worse case is reported		

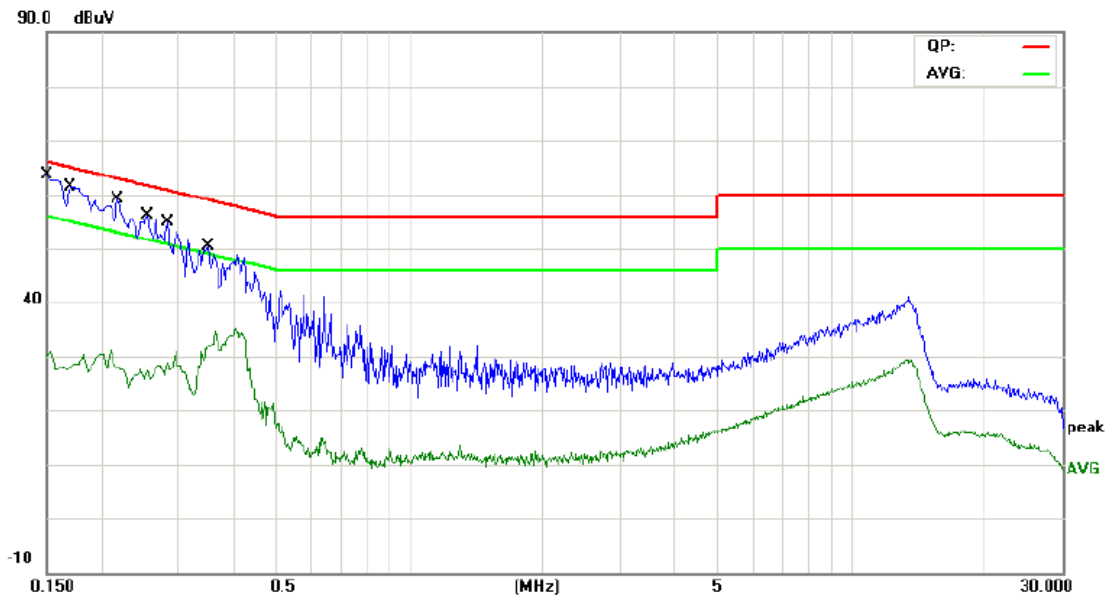

No.	Mk.	Freq. MHz	Reading Level dBuV	Correct Factor dB	Measure- ment dBuV	Limit dBuV	Over dB	Detector
1	*	0.1500	46.07	9.58	55.65	65.99	-10.34	QP
2		0.1500	18.80	9.58	28.38	55.99	-27.61	AVG
3		0.1712	43.79	9.58	53.37	64.90	-11.53	QP
4		0.1712	17.27	9.58	26.85	54.90	-28.05	AVG
5		0.2180	39.29	9.58	48.87	62.89	-14.02	QP
6		0.2180	18.29	9.58	27.87	52.89	-25.02	AVG
7		0.2540	35.21	9.59	44.80	61.62	-16.82	QP
8		0.2540	15.16	9.59	24.75	51.62	-26.87	AVG
9		0.2819	33.45	9.59	43.04	60.76	-17.72	QP
10		0.2819	17.81	9.59	27.40	50.76	-23.36	AVG
11		0.3500	30.64	9.59	40.23	58.96	-18.73	QP
12		0.3500	20.76	9.59	30.35	48.96	-18.61	AVG

Emission Level= Read Level+ Correct Factor

Attachment B-- Radiated Emission Test Data

9 KHz~30 MHz

From 9 KHz to 30 MHz: Conclusion: PASS

Note: The amplitude of spurious emissions which are attenuated by more than 20dB
Below the permissible value has no need to be reported.

30MHz~1GHz

Temperature:	25°C	Relative Humidity:	55%
Test Voltage:	AC 120V 60Hz		
Ant. Pol.	Horizontal		
Test Mode:	Mode 1		
Remark:	Only worse case is reported		

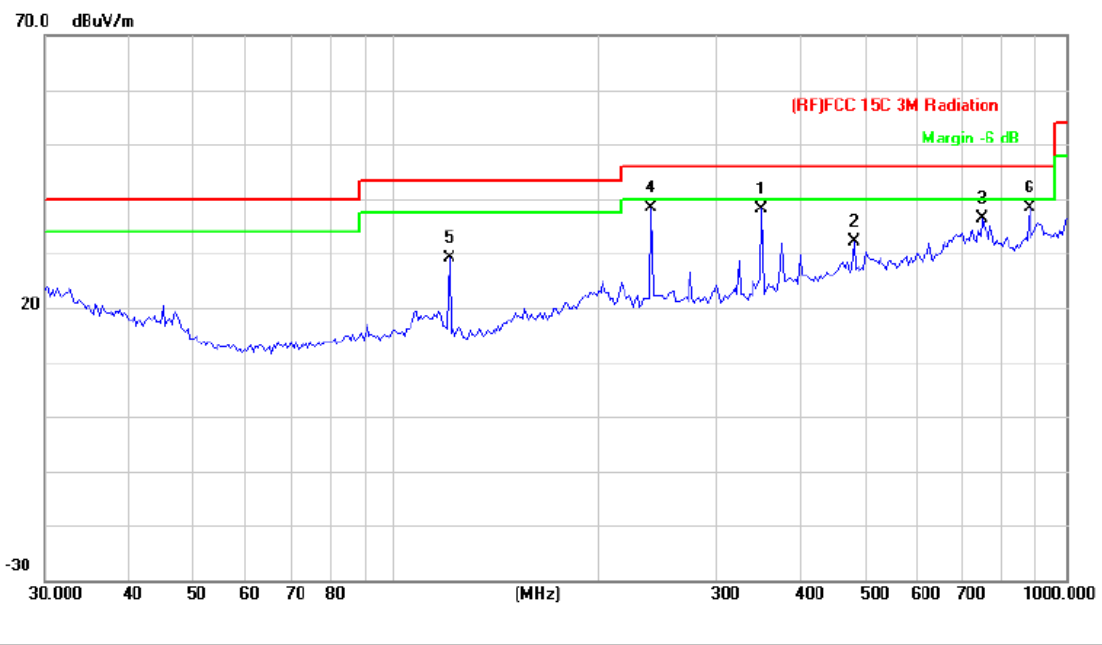

No.	Mk.	Freq. MHz	Reading Level dBuV	Correct Factor dB/m	Measurement dBuV/m	Limit dBuV/m	Over dB	Detector
1		351.7079	21.09	17.16	38.25	46.00	-7.75	QP
2		482.2156	11.50	20.54	32.04	46.00	-13.96	QP
3		750.1083	11.53	24.73	36.26	46.00	-9.74	QP
4	*	240.8301	24.42	14.02	38.44	46.00	-7.56	QP
5		120.2766	19.58	9.45	29.03	43.50	-14.47	QP
6		881.4067	11.81	26.49	38.30	46.00	-7.70	QP

*:Maximum data x:Over limit !:over margin

Emission Level= Read Level+ Correct Factor

Temperature:	25°C	Relative Humidity:	55%
Test Voltage:	AC 120V 60Hz		
Ant. Pol.	Vertical		
Test Mode:	Mode 1		
Remark:	Only worse case is reported		

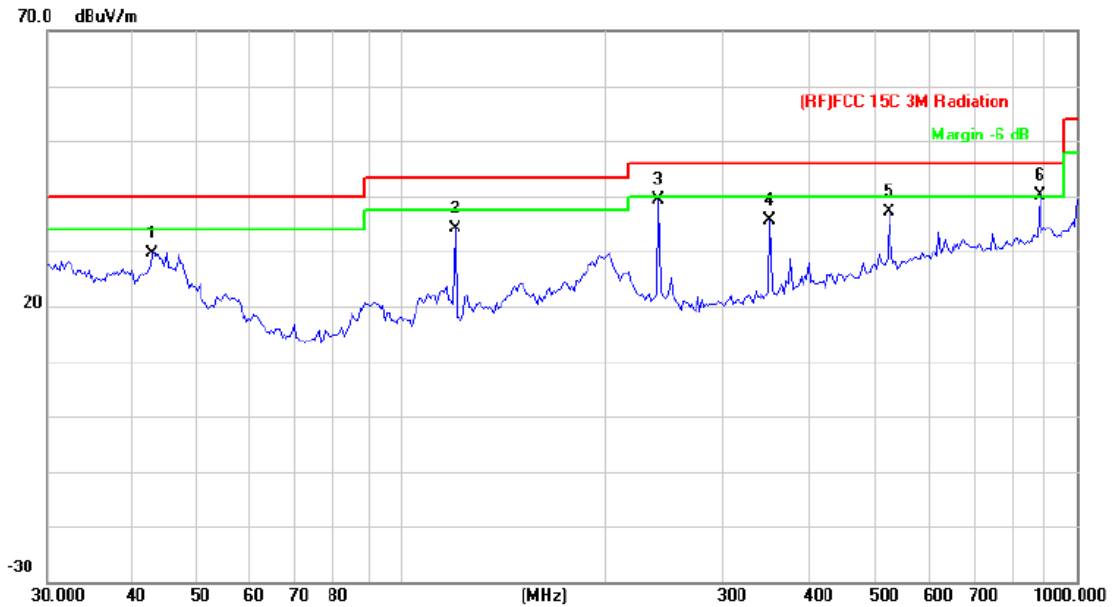

No.	Mk.	Freq. MHz	Reading Level dBuV	Correct Factor dB/m	Measure- ment dBuV/m	Limit dBuV/m	Over dB	Detector
1		42.8997	18.46	11.25	29.71	40.00	-10.29	QP
2		120.2766	24.71	9.45	34.16	43.50	-9.34	QP
3		240.8304	25.47	14.02	39.49	46.00	-6.51	QP
4		351.7079	18.36	17.16	35.52	46.00	-10.48	QP
5		528.2458	15.22	21.88	37.10	46.00	-8.90	QP
6	*	881.4067	13.53	26.49	40.02	46.00	-5.98	QP

*:Maximum data x:Over limit !:over margin

Emission Level= Read Level+ Correct Factor

Above 1GHz

Temperature:	25°C	Relative Humidity:	55%				
Test Voltage:	AC 120V 60HZ						
Ant. Pol.	Horizontal						
Test Mode:	BLE Mode TX 2402 MHz						
Remark:	No report for the emission which more than 10 dB below the prescribed limit.						
No. Mk.	Freq.	Reading Level	Correct Factor	Measurement	Limit	Over	Detector
	MHz	dBuV	dB/m	dBuV/m	dBuV/m	dB	
1	4804.048	41.87	14.43	56.30	74.00	-17.70	peak
2	* 4804.048	28.44	14.43	42.87	54.00	-11.13	AVG
Emission Level= Read Level+ Correct Factor							

Temperature:	25°C	Relative Humidity:	55%																																				
Test Voltage:	AC 120V 60HZ																																						
Ant. Pol.	Vertical																																						
Test Mode:	BLE Mode TX 2402 MHz																																						
Remark:	No report for the emission which more than 10 dB below the prescribed limit.																																						
<table border="1"> <thead> <tr> <th>No.</th> <th>Mk.</th> <th>Freq.</th> <th>Reading Level</th> <th>Correct Factor</th> <th>Measurement</th> <th>Limit</th> <th>Over</th> <th></th> </tr> <tr> <th></th> <th></th> <th>MHz</th> <th>dBuV</th> <th>dB/m</th> <th>dBuV/m</th> <th>dBuV/m</th> <th>dB</th> <th>Detector</th> </tr> </thead> <tbody> <tr> <td>1</td> <td></td> <td>4804.048</td> <td>40.69</td> <td>14.43</td> <td>55.12</td> <td>74.00</td> <td>-18.88</td> <td>peak</td> </tr> <tr> <td>2</td> <td>*</td> <td>4804.048</td> <td>26.59</td> <td>14.43</td> <td>41.02</td> <td>54.00</td> <td>-12.98</td> <td>AVG</td> </tr> </tbody> </table>				No.	Mk.	Freq.	Reading Level	Correct Factor	Measurement	Limit	Over				MHz	dBuV	dB/m	dBuV/m	dBuV/m	dB	Detector	1		4804.048	40.69	14.43	55.12	74.00	-18.88	peak	2	*	4804.048	26.59	14.43	41.02	54.00	-12.98	AVG
No.	Mk.	Freq.	Reading Level	Correct Factor	Measurement	Limit	Over																																
		MHz	dBuV	dB/m	dBuV/m	dBuV/m	dB	Detector																															
1		4804.048	40.69	14.43	55.12	74.00	-18.88	peak																															
2	*	4804.048	26.59	14.43	41.02	54.00	-12.98	AVG																															
Emission Level= Read Level+ Correct Factor																																							

Temperature:	25°C	Relative Humidity:	55%																																				
Test Voltage:	AC 120V 60HZ																																						
Ant. Pol.	Horizontal																																						
Test Mode:	BLE Mode TX 2442 MHz																																						
Remark:	No report for the emission which more than 10 dB below the prescribed limit.																																						
<table border="1"> <thead> <tr> <th>No.</th> <th>Mk.</th> <th>Freq.</th> <th>Reading Level</th> <th>Correct Factor</th> <th>Measurement</th> <th>Limit</th> <th>Over</th> <th></th> </tr> <tr> <th></th> <th></th> <th>MHz</th> <th>dBuV</th> <th>dB/m</th> <th>dBuV/m</th> <th>dBuV/m</th> <th>dB</th> <th>Detector</th> </tr> </thead> <tbody> <tr> <td>1</td> <td>*</td> <td>4883.736</td> <td>28.43</td> <td>14.91</td> <td>43.34</td> <td>54.00</td> <td>-10.66</td> <td>AVG</td> </tr> <tr> <td>2</td> <td></td> <td>4884.978</td> <td>41.17</td> <td>14.93</td> <td>56.10</td> <td>74.00</td> <td>-17.90</td> <td>peak</td> </tr> </tbody> </table>				No.	Mk.	Freq.	Reading Level	Correct Factor	Measurement	Limit	Over				MHz	dBuV	dB/m	dBuV/m	dBuV/m	dB	Detector	1	*	4883.736	28.43	14.91	43.34	54.00	-10.66	AVG	2		4884.978	41.17	14.93	56.10	74.00	-17.90	peak
No.	Mk.	Freq.	Reading Level	Correct Factor	Measurement	Limit	Over																																
		MHz	dBuV	dB/m	dBuV/m	dBuV/m	dB	Detector																															
1	*	4883.736	28.43	14.91	43.34	54.00	-10.66	AVG																															
2		4884.978	41.17	14.93	56.10	74.00	-17.90	peak																															
Emission Level= Read Level+ Correct Factor																																							

Temperature:	25°C	Relative Humidity:	55%																																								
Test Voltage:	AC 120V 60HZ																																										
Ant. Pol.	Vertical																																										
Test Mode:	BLE Mode TX 2442 MHz																																										
Remark:	No report for the emission which more than 10 dB below the prescribed limit.																																										
<table border="1"> <thead> <tr> <th>No.</th> <th>Mk.</th> <th>Freq.</th> <th>Reading Level</th> <th>Correct Factor</th> <th>Measurement</th> <th>Limit</th> <th>Over</th> <th></th> </tr> <tr> <th></th> <th></th> <th>MHz</th> <th>dBuV</th> <th>dB/m</th> <th>dBuV/m</th> <th>dBuV/m</th> <th>dB</th> <th>Detector</th> </tr> </thead> <tbody> <tr> <td>1</td> <td></td> <td>4883.424</td> <td>41.15</td> <td>14.91</td> <td>56.06</td> <td>74.00</td> <td>-17.94</td> <td>peak</td> </tr> <tr> <td>2</td> <td>*</td> <td>4883.424</td> <td>28.24</td> <td>14.91</td> <td>43.15</td> <td>54.00</td> <td>-10.85</td> <td>AVG</td> </tr> </tbody> </table>								No.	Mk.	Freq.	Reading Level	Correct Factor	Measurement	Limit	Over				MHz	dBuV	dB/m	dBuV/m	dBuV/m	dB	Detector	1		4883.424	41.15	14.91	56.06	74.00	-17.94	peak	2	*	4883.424	28.24	14.91	43.15	54.00	-10.85	AVG
No.	Mk.	Freq.	Reading Level	Correct Factor	Measurement	Limit	Over																																				
		MHz	dBuV	dB/m	dBuV/m	dBuV/m	dB	Detector																																			
1		4883.424	41.15	14.91	56.06	74.00	-17.94	peak																																			
2	*	4883.424	28.24	14.91	43.15	54.00	-10.85	AVG																																			
Emission Level= Read Level+ Correct Factor																																											

Temperature:	25°C	Relative Humidity:	55%
Test Voltage:	AC 120V 60HZ		
Ant. Pol.	Horizontal		
Test Mode:	BLE Mode TX 2480 MHz		
Remark:	No report for the emission which more than 10 dB below the prescribed limit.		

No.	Mk.	Freq.	Reading Level	Correct Factor	Measurement	Limit	Over	Detector
		MHz	dBuV	dB/m	dBuV/m	dBuV/m	dB	
1		4960.024	42.70	15.39	58.09	74.00	-15.91	peak
2	*	4960.066	29.54	15.39	44.93	54.00	-9.07	AVG

Emission Level= Read Level+ Correct Factor

Temperature:	25°C	Relative Humidity:	55%					
Test Voltage:	AC 120V 60HZ							
Ant. Pol.	Vertical							
Test Mode:	BLE Mode TX 2480 MHz							
Remark:	No report for the emission which more than 10 dB below the prescribed limit.							
No.	Mk.	Freq.	Reading Level	Correct Factor	Measurement	Limit	Over	Detector
		MHz	dBuV	dB/m	dBuV/m	dBuV/m	dB	
1		4960.024	41.86	15.39	57.25	74.00	-16.75	peak
2	*	4960.066	27.95	15.39	43.34	54.00	-10.66	AVG
Emission Level= Read Level+ Correct Factor								

Conducted Emission Test Data

BLE(Only worst case is reported)

2402 MHz

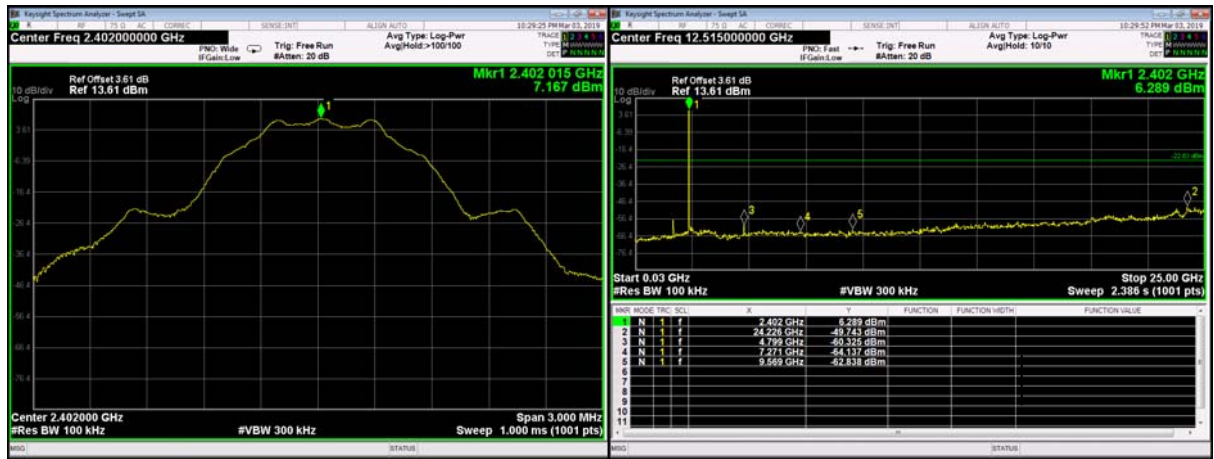

BLE Mode

2442 MHz



BLE Mode

2480 MHz

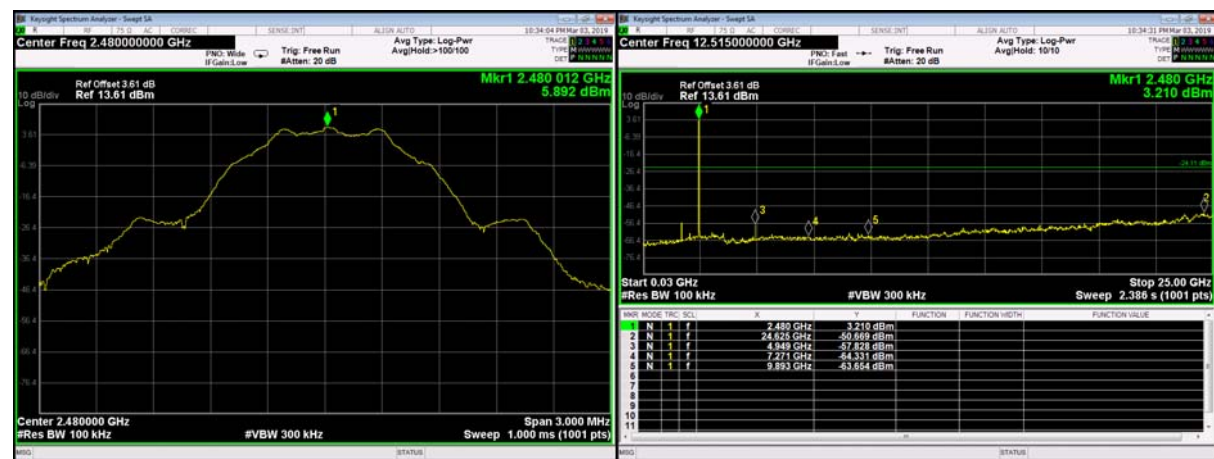

Attachment C-- Restricted Bands Requirement and Band-edge Test Data

(1) Radiation Test

Temperature:	25°C	Relative Humidity:	55%
Test Voltage:	AC 120V 60HZ		
Ant. Pol.	Horizontal		
Test Mode:	BLE Mode TX 2402 MHz		
Remark:	N/A		

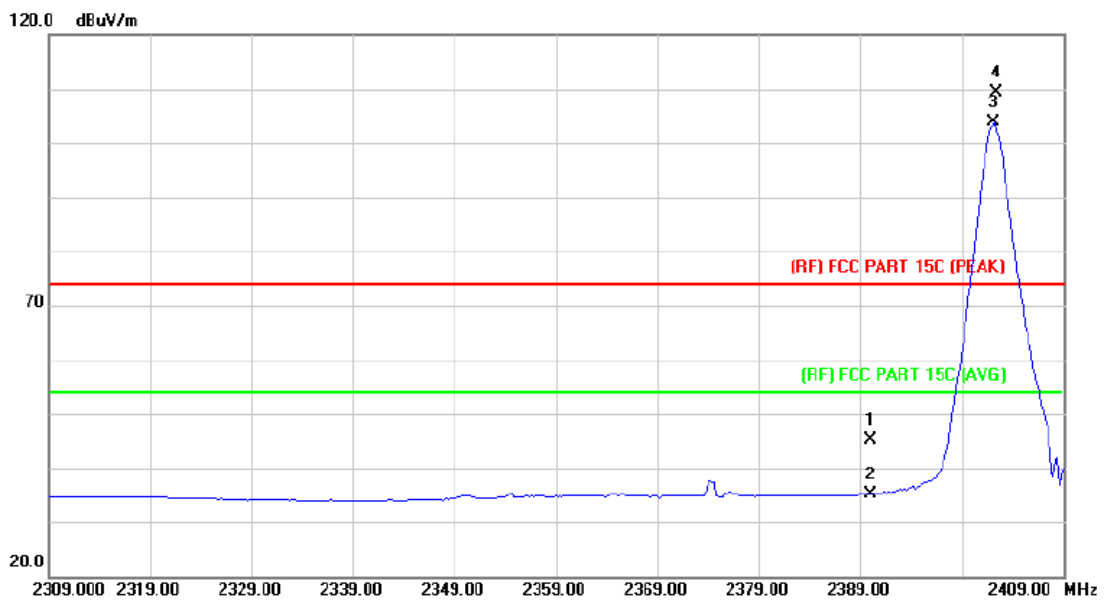

No.	Mk.	Freq. MHz	Reading Level dBuV	Correct Factor dB/m	Measure- ment dBuV/m	Limit dBuV/m	Over dB	Detector
1		2390.000	43.67	1.51	45.18	74.00	-28.82	peak
2		2390.000	33.68	1.51	35.19	54.00	-18.81	AVG
3	*	2402.200	102.20	1.56	103.76	Fundamental Frequency		AVG
4	X	2402.400	107.88	1.56	109.44	Fundamental Frequency		peak

Emission Level= Read Level+ Correct Factor

Temperature:	25°C	Relative Humidity:	55%
Test Voltage:	AC 120V 60HZ		
Ant. Pol.	Vertical		
Test Mode:	BLE Mode TX 2402 MHz		
Remark:	N/A		

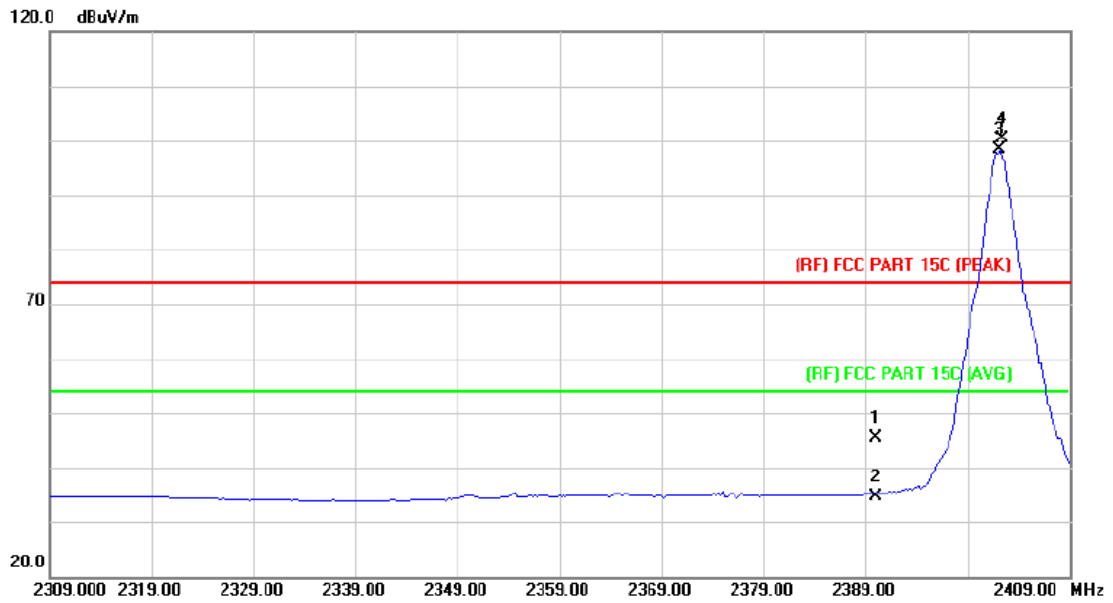

No.	Mk.	Freq. MHz	Reading Level dBuV	Correct Factor dB/m	Measure- ment dBuV/m	Limit dBuV/m	Over dB	Detector
1		2390.000	43.84	1.51	45.35	74.00	-28.65	peak
2		2390.000	33.06	1.51	34.57	54.00	-19.43	AVG
3	*	2402.200	96.70	1.56	98.26	Fundamental Frequency		AVG
4	X	2402.400	98.89	1.56	100.45	Fundamental Frequency		peak

Emission Level= Read Level+ Correct Factor

Temperature:	25°C	Relative Humidity:	55%
Test Voltage:	AC 120V 60HZ		
Ant. Pol.	Horizontal		
Test Mode:	BLE Mode TX 2480 MHz		
Remark:	N/A		

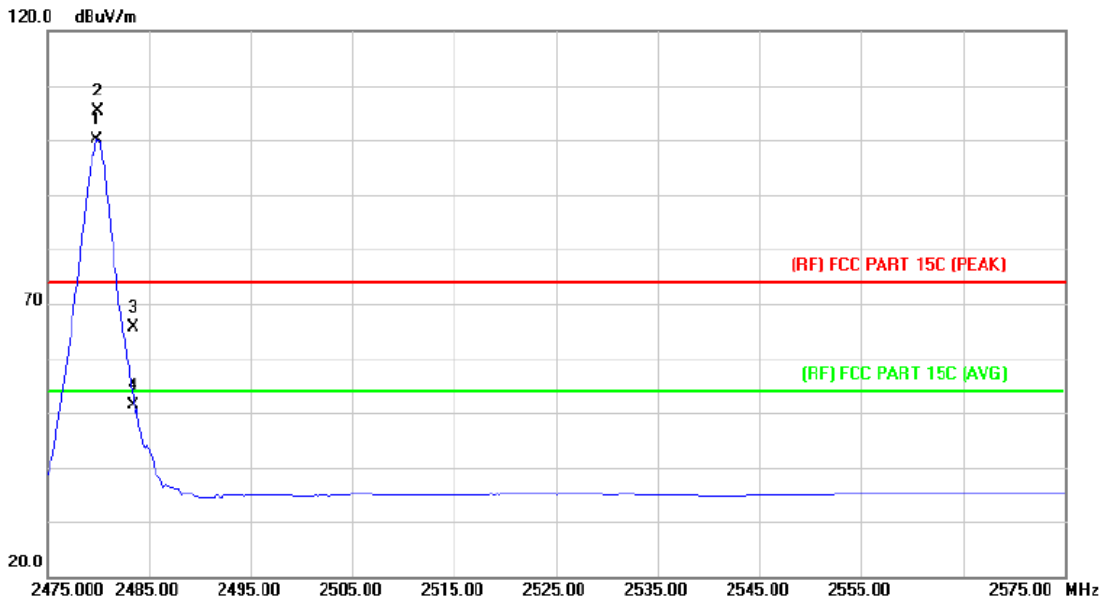

No.	Mk.	Freq. MHz	Reading Level dBuV	Correct Factor dB/m	Measure- ment dBuV/m	Limit dBuV/m	Over dB	Detector
1	*	2479.800	97.94	2.07	100.01	Fundamental Frequency		AVG
2	X	2480.000	103.35	2.07	105.42	Fundamental Frequency		peak
3		2483.500	63.55	2.10	65.65	74.00	-8.35	peak
4		2483.500	49.20	2.10	51.30	54.00	-2.70	AVG

Emission Level= Read Level+ Correct Factor

Temperature:	25°C	Relative Humidity:	55%
Test Voltage:	AC 120V 60HZ		
Ant. Pol.	Vertical		
Test Mode:	BLE Mode TX 2480 MHz		
Remark:	N/A		

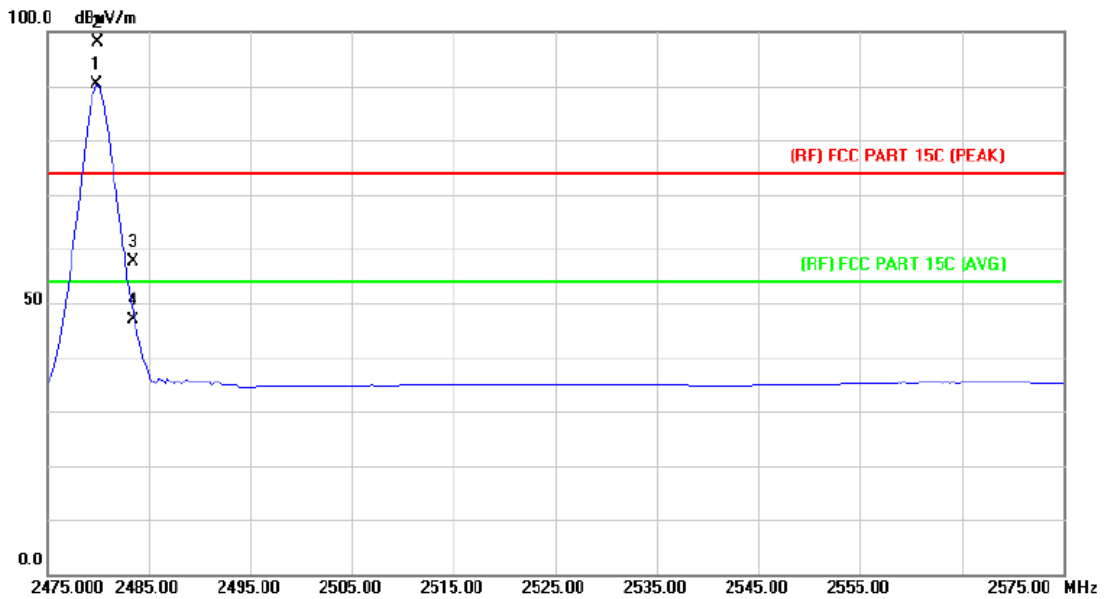

No.	Mk.	Freq. MHz	Reading Level dBuV	Correct Factor dB/m	Measure- ment dBuV/m	Limit dBuV/m	Over dB	Detector
1	*	2479.800	88.34	2.07	90.41	Fundamental Frequency		AVG
2	X	2480.000	96.05	2.07	98.12	Fundamental Frequency		peak
3		2483.500	55.41	2.10	57.51	74.00	-16.49	peak
4		2483.500	44.74	2.10	46.84	54.00	-7.16	AVG

Emission Level= Read Level+ Correct Factor

(2) Conducted Test

Temperature:	25°C	Relative Humidity:	55%
Test Voltage:	AC 120V 60HZ		
Test Mode:	BLE Mode TX 2402MHz / BLE Mode TX 2480MHz		
Remark:	The EUT is programed in continuously transmitting mode		

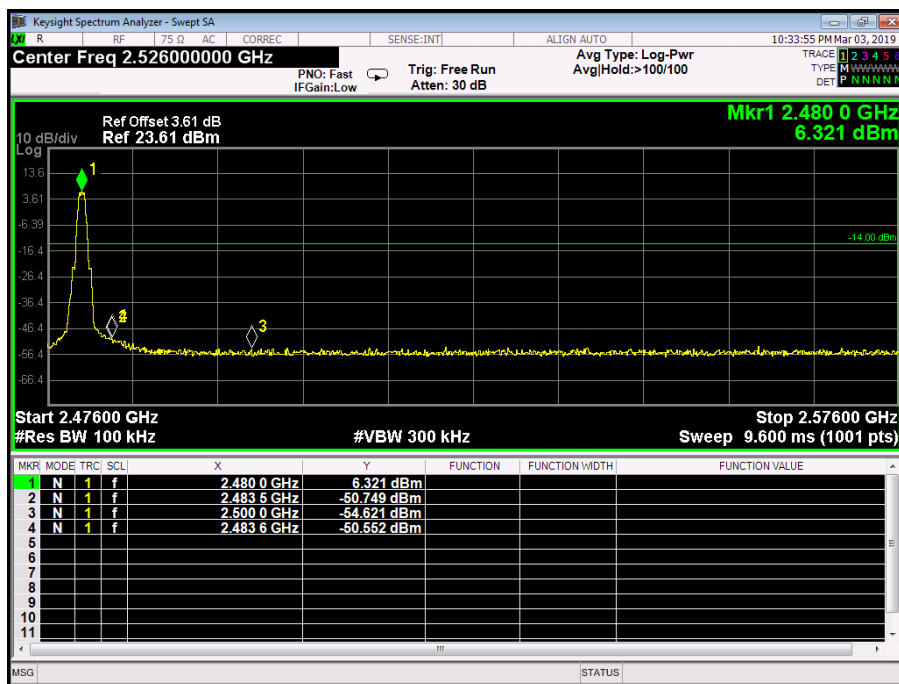
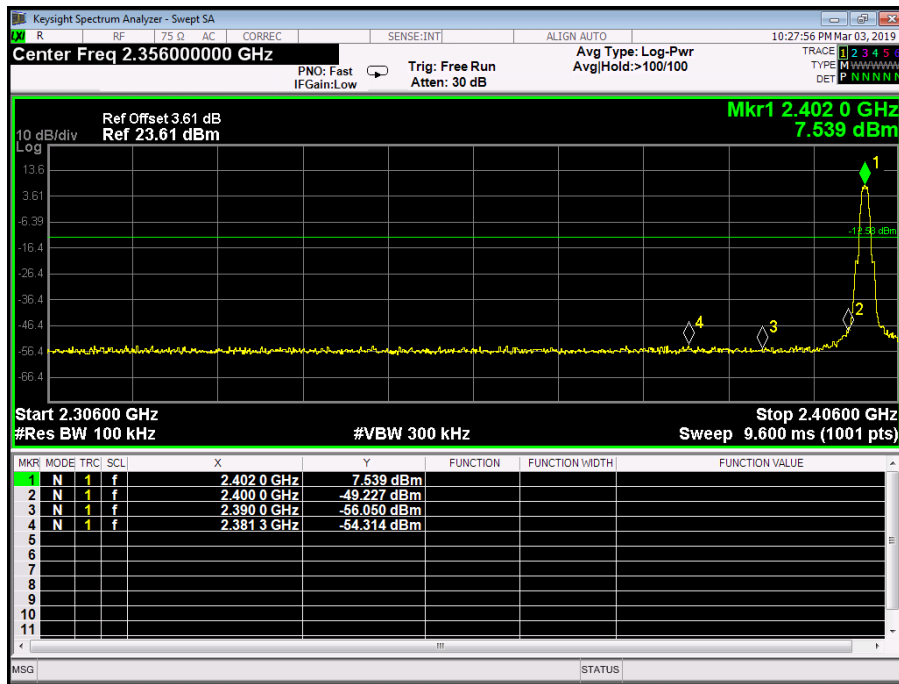

Attachment D-- Bandwidth Test Data

Temperature:	25°C	Relative Humidity:	55%
Test Voltage:	AC 120V 60HZ		
Test Mode:	BLE TX Mode		
Channel frequency (MHz)	6dB Bandwidth (kHz)	99% Bandwidth (kHz)	Limit (kHz)
2402	671.5	1081.5	>=500
2442	672.3	1082.6	
2480	694.6	1082.3	

BLE Mode
2402 MHz

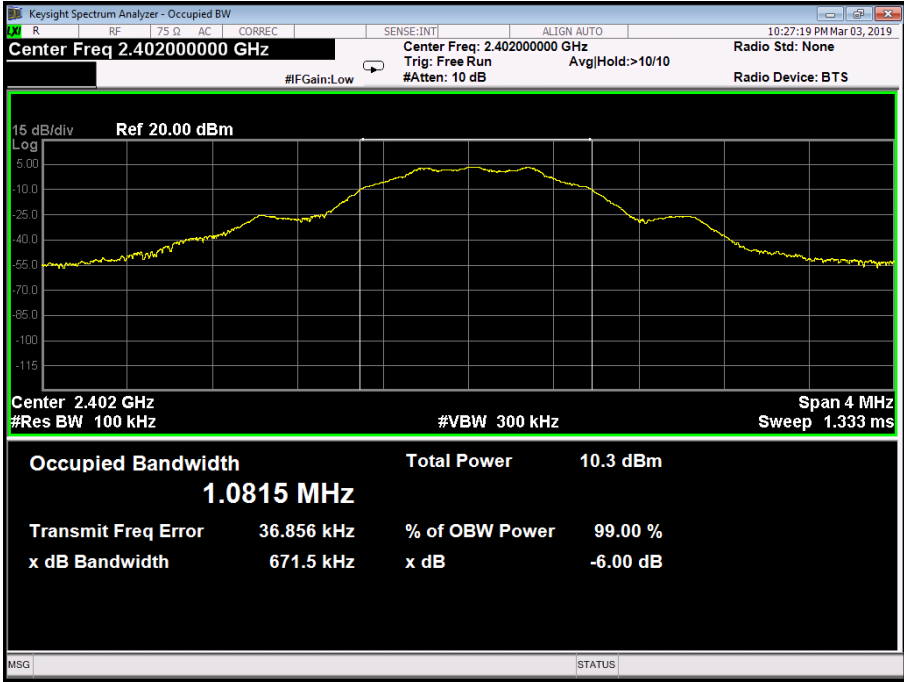

BLE Mode
2442 MHz

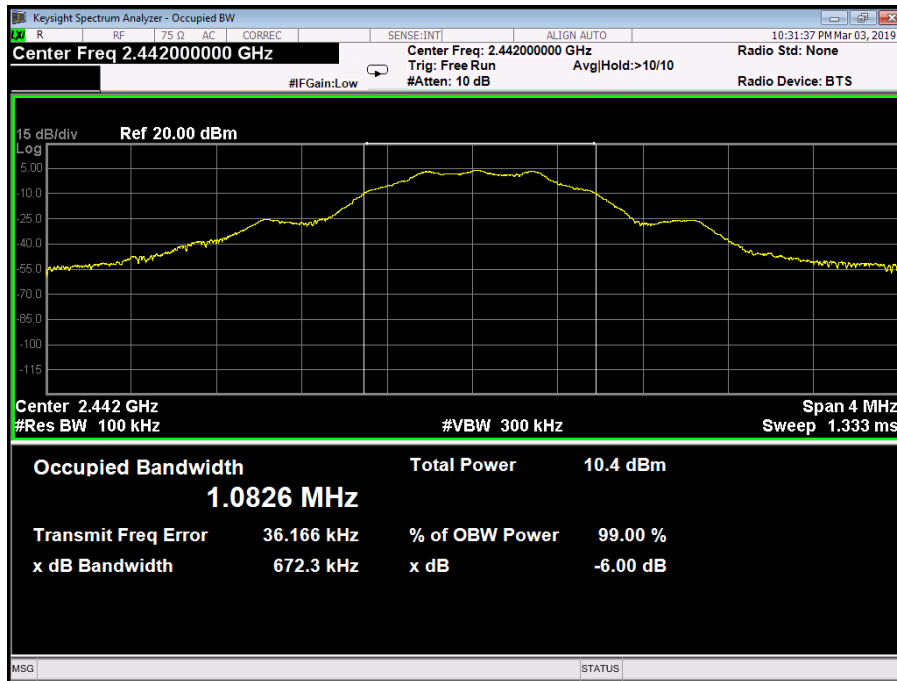

BLE Mode
2480 MHz

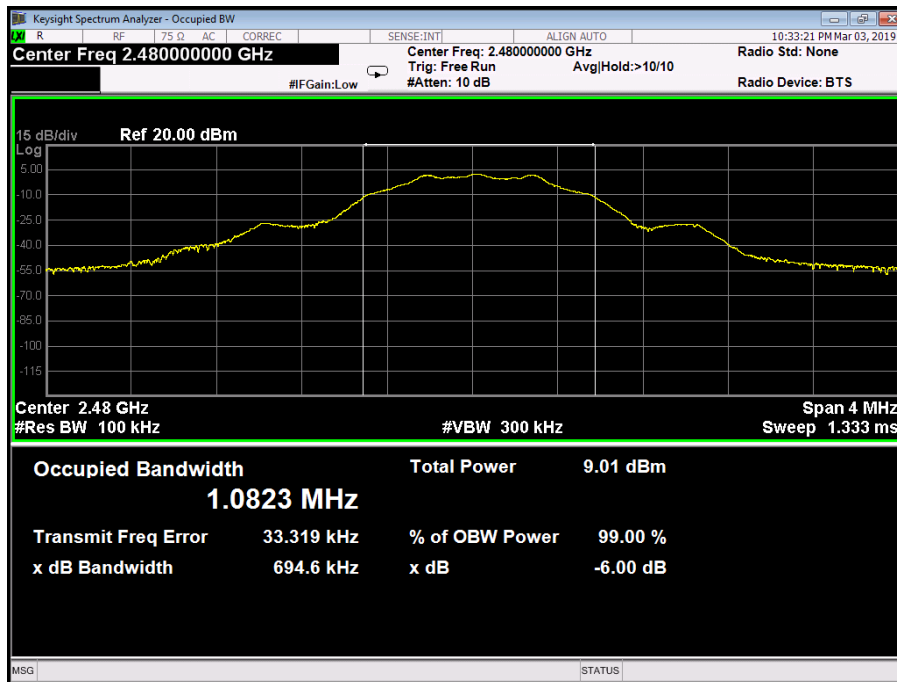

Attachment E-- Peak Output Power Test Data

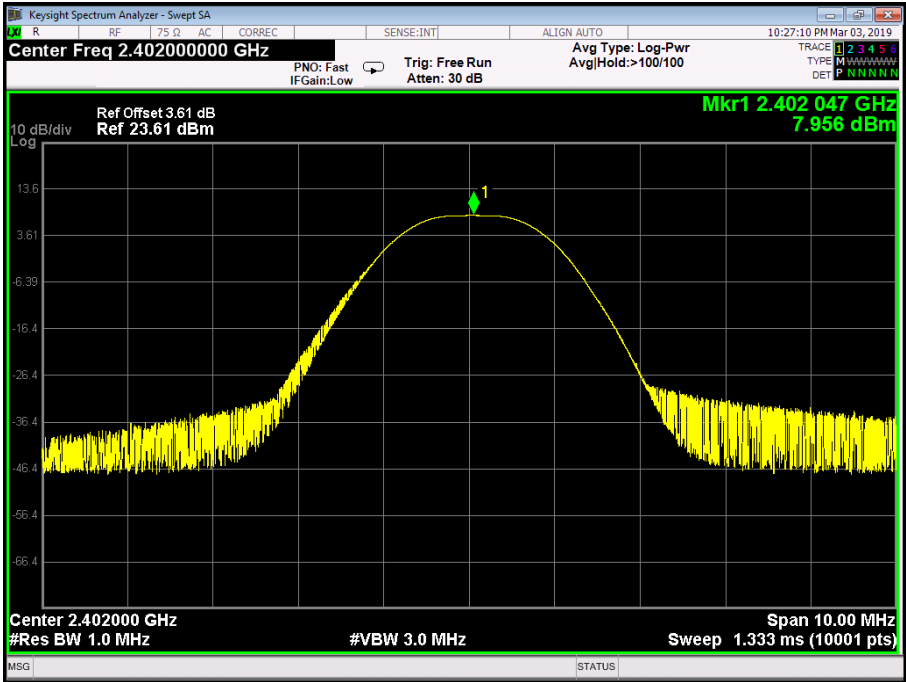
Temperature:	25°C	Relative Humidity:	55%
Test Voltage:	AC 120V 60HZ		
Test Mode:	BLE TX Mode		
Channel frequency (MHz)	Test Result (dBm)	Limit (dBm)	
2402	7.956	30	
2442	8.155		
2480	6.809		
BLE Mode			
2402 MHz			
			

BLE Mode

2442 MHz

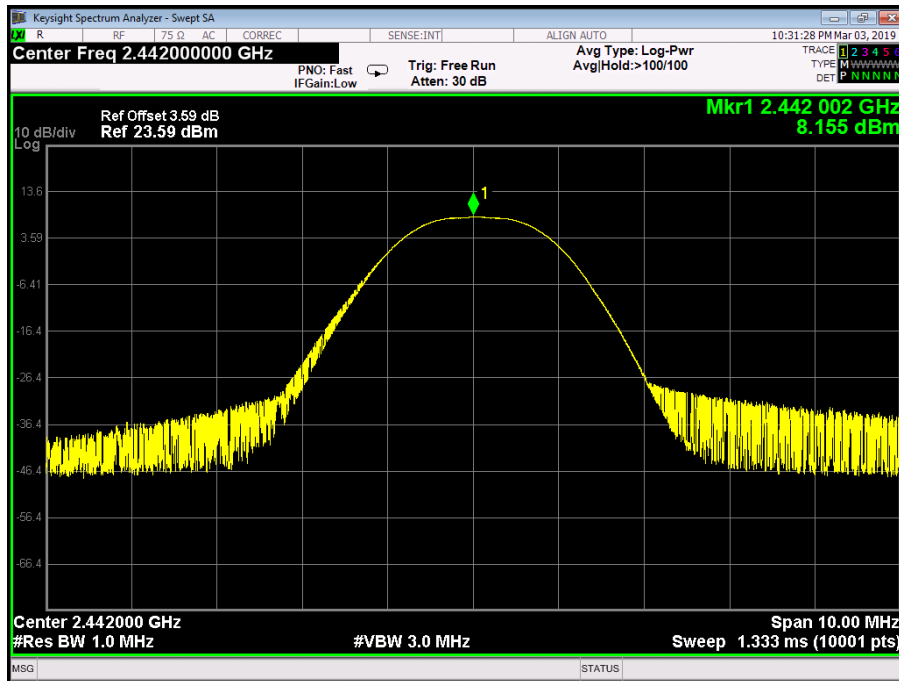

BLE Mode

2480 MHz

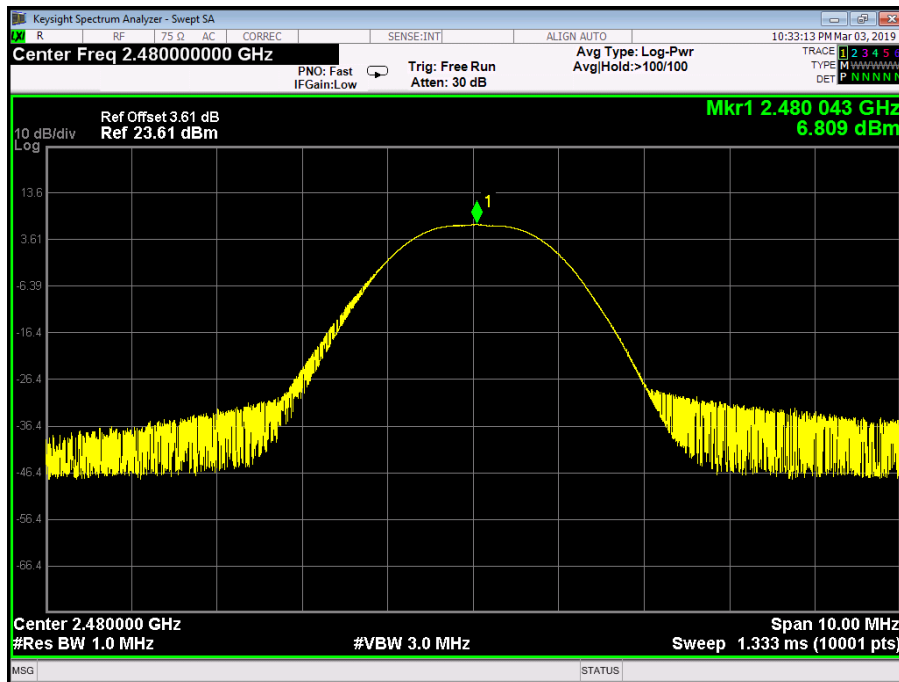

Attachment F-- Power Spectral Density Test Data

Temperature:	25°C	Relative Humidity:	55%
Test Voltage:	AC 120V 60HZ		
Test Mode:	BLE TX Mode		
Channel Frequency (MHz)	Power Density (dBm/3kHz)	Limit (dBm/3kHz)	Result
2402	-6.065	8	PASS
2442	-5.917		
2480	-7.296		
BLE Mode			
2402 MHz			

The screenshot displays the following parameters:

- Center Freq: 2.40200000 GHz
- Ref Offset: 3.61 dB
- Ref: 23.61 dBm
- Mkr1: 2.40201007 GHz
- Mkr1 Power: -6.065 dBm
- Center: 2.4020000 GHz
- #Res BW: 3.0 kHz
- #VBW: 10 kHz
- Span: 1.343 MHz
- Sweep: 142.0 ms (10001 pts)

BLE Mode

2442 MHz

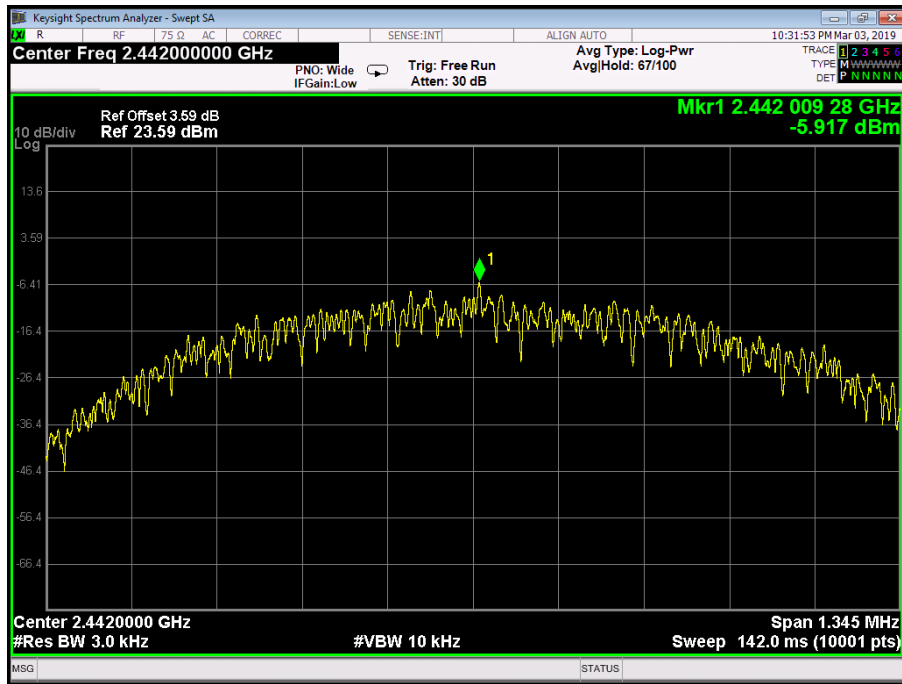

BLE Mode

2480 MHz

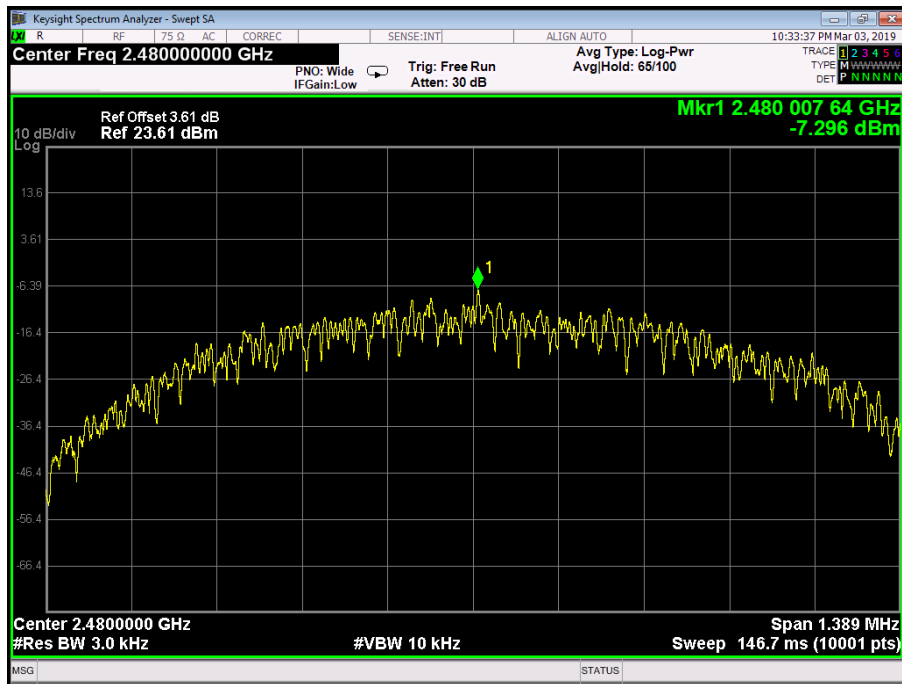

-----END OF REPORT-----