

## CAUTION



Risk of explosion if the battery is replaced by an incorrect type.  
Wait one-half hour after switching off before handling parts.

- Replacement of a battery with an incorrect type that can defeat a safeguard;
- Disposal of a battery into fire or a hot oven, or mechanically crushing or cutting of a battery, that can result in an explosion;
- Leaving a battery in an extremely high temperature surrounding environment that can result in an explosion or the leakage of flammable liquid or gas;
- A battery subjected to extremely low air pressure that may result in an explosion or the leakage of flammable liquid or gas.

This device complies with Industry Canada licence-exempt RSS standard(s). Operation is subject to the following two conditions: (1) this device may not cause interference, and (2) this device must accept any interference, including interference that may cause undesired operation of the device.

Le présent appareil est conforme aux CNR d'Industrie Canada applicables aux appareils radio exempts de licence. L'exploitation est autorisée aux deux conditions suivantes : (1) l'appareil ne doit pas produire de brouillage, et (2) l'utilisateur de l'appareil doit accepter tout brouillage radioélectrique subi, même si le brouillage est susceptible d'en compromettre le fonctionnement.

### FCC Radiation Exposure Statement:

This equipment complies with FCC RF radiation exposure and Industry Canada RSS-102 RF exposure limits set forth for an uncontrolled environment. This device and its antenna must not be co-located or operating in conjunction with any other antenna or transmitter. To comply with FCC RF exposure and Industry Canada RSS-102 RF exposure compliance requirements, this grant is applicable to only Mobile Configurations. The antennas used for this transmitter must be installed to provide a separation distance of at least 20 cm from all persons and must not be co-located or operating in conjunction with any other antenna or transmitter.

Cet équipement est conforme aux limites d'exposition aux rayonnements énoncées pour un environnement non contrôlé et respecte les règles d'exposition aux fréquences radioélectriques (RF) CNR-102 de l'IC. Cet équipement doit être installé et utilisé en gardant une distance de 20 cm ou plus entre le radiateur et le corps humain (à l'exception des extrémités : mains, poignets, pieds et chevilles).

This device is restricted to indoor use due to its operation in the 5.15 to 5.25GHz frequency range.

Les dispositifs fonctionnant dans la bande 5.15-5.25GHz sont réservés uniquement pour une utilisation à l'intérieur afin de réduire les risques de brouillage préjudiciable aux systèmes de satellites mobiles utilisant les mêmes canaux.

Company Name: IAdea Corporation

Address: 3F, No. 21, Lane 168, Xingshan Road, Neihu Dist. Taipei, 114 Taiwan

Tel: 886-2-2791-1110



Q41G78SP05901A

# WRP-1000 (V2) Series

## Quick Start Guide

This is a quick walkthrough of the set up process. For complete documentations and quick start guides, please visit <http://support.IAdea.com>.

## Box Content

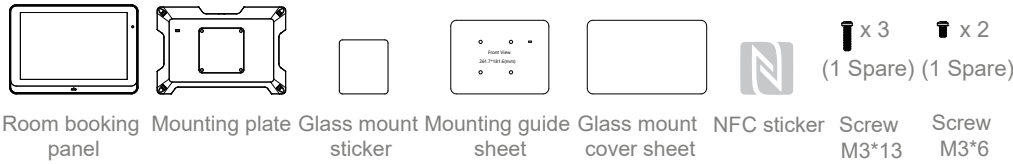

## Port Connections

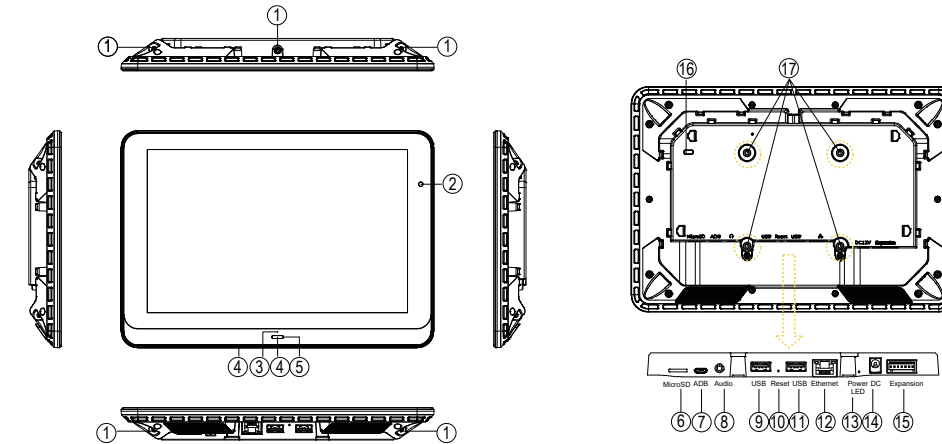

- |                   |                     |                       |                        |
|-------------------|---------------------|-----------------------|------------------------|
| ① Screw Hole      | ⑥ MicroSD card slot | ⑩ Reset               | ⑭ 12V DC power         |
| ② Camera*         | ⑦ ADB               | ⑪ USB port            | ⑮ Expansion*           |
| ③ Microphone*     | ⑧ 3.5mm audio       | ⑫ Ethernet RJ45(PoE+) | ⑯ Kensington Lock      |
| ④ LED             | ⑨ USB port          | ⑬ Power LED           | ⑰ VESA mount (MIS-D75) |
| ⑤ NFC/RFID reader |                     |                       | Screw spec: M4         |

\* The functions marked with "\*" only appear on certain models.

## Mounting and Installation

### Option 1: Flush Wall Mount

- Step 1**  
  
Paste the mount sheet on the wall
- Step 2**  
  
Drill the four mounting holes
- Step 3**  
  
Install the mounting plate using the four screws
- Step 4**  
  
Plug in the required cables to the room panel
- Step 5**  
  
Attach the room panel to the mounting plate
- Step 6**  
  
Lock the room panel to the mounting plate using a screw at each corner
- Step 7**  
  
The room panel is ready to be brought online

### Option 2: Mounting on Glass

- Step 1**  
  
Paste sticker on the back of the mounting plate  
Ensure the glass surface is clean and dry
- Step 2**  
  
The mount sheet can be temporary fixed on the other side of the glass to locate the area for the cover sheet.
- Step 3**  
  
1. Affix the cover sheet to the glass surface.  
2. Align the mounting plate to the cover sheet with the kensington lock hole.
- Step 4**  
  
Affix the mounting plate to the glass surface
- Step 5**  
  
Plug in the required cables to the room panel
- Step 6**  
  
Attach the room panel to the mounting plate
- Step 7**  
  
Lock the room panel to the mounting plate using a screw at each corner
- Step 8**  
  
The room panel is ready to be brought online

### Option 3: Mounting close to a window frame

- Step 1**  
  
Align the mounting sheet guide parallel to the window frame
- Step 2**  
  
Drill the four mounting holes
- Step 3**  
  
Install the mounting plate using the four screws
- Step 4**  
  
Plug in the required cables to the room panel
- Step 5**  
  
Attach the room panel to the mounting plate
- Step 6**  
  
Lock the room panel using a screw at the top, and two screws at the outside corners
- Step 7**  
  
The room panel is ready to be brought online

## System Setup

### 1 Boot up

Plug in the AC adapter and Ethernet cable to the room panel and it will power on automatically. Once the user has exited the boot up screen, users can go through system configurations in both landscape and portrait orientations.

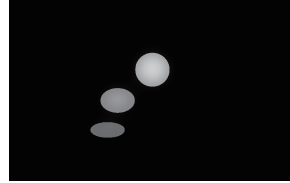

### 2 Autoplay content

When boot up is complete, if the system detects preloaded content, the loading circle will appear. Once the loading circle completes, content will be played. To stop autoplay and enter "Basic settings," users need to select the pause button in the center of the loading circle.

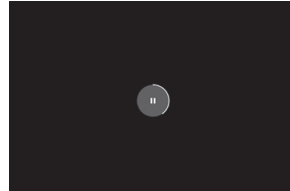

### 3 Basic settings

When boot up is complete and there is no preloaded contents, the user will see the "Basic settings" which allows the user to make configurations or autoplay pre-loaded content.

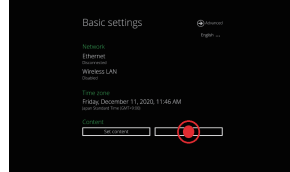

### 4 Make configurations

To change room panel system language, select "(Current Language) ...." For system configurations, select "Advanced."

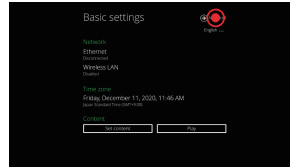

Important recommended configurations:

- 1 Set correct time, date, and time zone for properly scheduled playback.
- 2 Set password to prevent unauthorized access during setup menu.
- 3 Set network for establishing network connection.

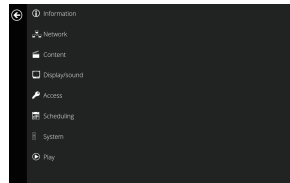

### 5 Set content

Users can set content by clicking "Set Content" to enter the URL or use the desired content management system to upload the contents onto the room panel.

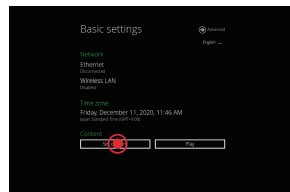

## Content Management

Please consult the software documentation for information specific to your content management solution.

### Troubleshooting

#### How do I interrupt playback and enter setup menu?

Use USB mouse to click and hold one corner of the screen for 10 seconds to exit playback and enter setup menu.

#### How do I provide a DEBUG log for a misbehaving room panel to the support team?

Please follow the instructions below to collect the room panel's DEBUG log:

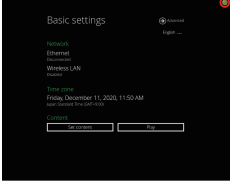
- 1 Prepare a blank USB stick in FAT-32 format.
- 2 Create a folder named "DEBUG" (case insensitive) in the root of USB stick.
- 3 Make sure the room panel is operating (see welcome screen or playing content).
- 4 Insert the USB stick into room panel and wait for yellow dot on upper right corner to stop blinking.
- 5 Within the "DEBUG" folder, is a folder with a string of number as its name. If the string of numbers are all zero's, the debug log has not been collected properly. Repeat step 1-4 again and make sure to wait until stop blinking.
- 6 Zip the "DEBUG" folder and send to IAdea Support Team.

### Resetting room panel to factory default

Factory resetting the room panel will result in the removal of all saved contents, passwords, and configurations in settings. Please refer to the steps below to complete the room panel factory resetting process:

- 1 Use a pen to press and hold the reset button - do not release until Step 4.
- 2 Insert the power cord.
- 3 Wait 30 seconds for the system reboot indicating your data is erased.
- 4 Release the reset button and your room panel will initialize in factory default state.

## CARE AND WARNING

WARNING: Changes or modifications to this unit not expressly approved by the party responsible for compliance could void the user's authority to operate the equipment.

NOTE: This equipment has been tested and found to comply with the limits for a Class A digital device, pursuant to part 15 of the FCC Rules. These limits are designed to provide reasonable protection against harmful interference when the equipment is operated in a commercial environment. This equipment generates, uses, and can radiate radio frequency energy and, if not installed and used in accordance with the instruction manual, may cause harmful interference to radio communications. Operation of this equipment in a residential area is likely to cause harmful interference in which case the user will be required to correct the interference at his own expense.

This device complies with Part 15 of the FCC Rules. Operation is subject to the following two conditions: (1) This device may not cause harmful interference, and (2) this device must accept any interference received, including interference that may cause undesired operation.

### Europe – EU Declaration of Conformity

This device complies with the essential requirements of the Radio Equipment Directive (2014/53/EU). The following test methods have been applied in order to prove presumption of conformity with the essential requirements of the Radio Equipment Directive This equipment is compliant with Class A of EN55032. In a residential environment this equipment may cause radio interference.



Correct Disposal of this product. This marking indicates that this product should not be disposed with other household wastes throughout the EU. To prevent possible harm to the environment or human health from uncontrolled waste disposal, recycle it responsibly to promote the sustainable reuse of material resources. To return your used device, please use the return and collection systems or contact the retailer where the product was purchased. They can take this product for environmental safe recycling.

"FCC & CE RF Radiation Exposure Statement Caution: To maintain compliance with the FCC & CE's RF exposure guidelines, place the product at least 20cm from nearby persons."

The suitable temperature for the Room Booking Panel and Accessory is 0°C-40°C. Adapter with ferrite must be used with this equipment to ensure compliance with the Class A FCC limits.

Power adapter information:  
Model No.: WB-24J12R  
INPUT: 100-240V~50/60Hz  
OUTPUT: 12V === 2.0A  
Installation height :<2M