

RF Exposure Lab

802 N. Twin Oaks Valley Road, Suite 105 • San Marcos, CA 92069 • U.S.A.
TEL (760) 471-2100 • FAX (760) 471-2121
<http://www.rfexposurelab.com>

CERTIFICATE OF COMPLIANCE SAR EVALUATION

Dejero Labs Inc.
412 Albert St., Suite 100
Waterloo, ON N2L 3V3
Canada

Dates of Test: May 18-25, 2015
Test Report Number: SAR.20150508
Revision A

FCC ID:	Y99MC7354
IC Certificate:	12762A-MC7354
Model(s):	LIVE+ EnGo
Part Number:	10-110-XX
Contains Module:	Sierra Wireless Model MC7354
Test Sample:	Engineering Unit Same as Production
Serial Number:	Eng 1
Equipment Type:	Wireless Video Transceiver
Classification:	Portable Transmitter Next to Body
TX Frequency Range:	704 – 716 MHz, 777 – 787 MHz, 806 – 849 MHz, 1710 – 1755 MHz, 1850 – 1910 MHz
Frequency Tolerance:	± 2.5 ppm
Maximum RF Output:	850 MHz (CDMA) – 24.49 dBm, 1900 MHz (CDMA) – 24.41 dBm, 850 MHz (UMTS) – 23.91 dBm, 1750 MHz (UMTS) – 23.95 dBm, 1900 MHz (UMTS) – 23.86 dBm; 700 MHz (LTE) – 24.00 dBm, 782 MHz (LTE) – 23.48 dBm, 1750 MHz (LTE) – 24.00 dBm, 850 MHz (LTE) – 24.00 dBm, 1900 MHz (LTE) – 24.00 dBm Conducted
Signal Modulation:	CDMA, WCDMA, QPSK, 16QAM
Antenna Type:	Internal
Application Type:	Certification
FCC Rule Parts:	Part 2, 22, 24
KDB Test Methodology:	KDB 447498 D01 v05r02, KDB 941225 D01 v02, KDB 941225 D05 v02r01
Industry Canada:	RSS-102 Issue 5, Safety Code 6
Maximum SAR Value:	0.61 W/kg Reported
Max. Simultaneous:	0.02 Separation Ratio
Separation Distance:	0 mm

This wireless mobile and/or portable device has been shown to be compliant for localized specific absorption rate (SAR) for uncontrolled environment/general exposure limits specified in ANSI/IEEE Std. C95.1-1992 and had been tested in accordance with the measurement procedures specified in IEEE 1528-2013 and IEC 62209-2:2010 (See test report).

I attest to the accuracy of the data. All measurements were performed by myself or were made under my supervision and are correct to the best of my knowledge and belief. I assume full responsibility for the completeness of these measurements and vouch for the qualifications of all persons taking them.

RF Exposure Lab, LLC certifies that no party to this application is subject to a denial of Federal benefits that includes FCC benefits pursuant to Section 5301 of the Anti-Drug Abuse Act of 1988, 21 U.S.C. 853(a).

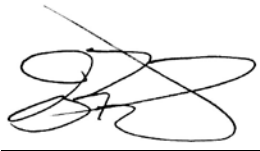

Jay M. Moulton
Vice President



Certificate # 2387.01

Table of Contents

1.	Introduction	3
	SAR Definition [5].....	4
2.	SAR Measurement Setup.....	5
	Robotic System.....	5
	System Hardware.....	5
	System Electronics.....	6
	Probe Measurement System.....	6
3.	Probe and Dipole Calibration.....	14
4.	Phantom & Simulating Tissue Specifications.....	15
	Head & Body Simulating Mixture Characterization	15
5.	ANSI/IEEE C95.1 – 1992 RF Exposure Limits [2].....	16
	Uncontrolled Environment.....	16
	Controlled Environment.....	16
6.	Measurement Uncertainty	17
7.	System Validation.....	18
	Tissue Verification.....	18
	Test System Verification.....	18
8.	SAR Test Data Summary	19
	Procedures Used To Establish Test Signal	19
	Device Test Condition	19
9.	LTE Document Checklist.....	20
10.	FCC 3G Measurement Procedures	24
	10.1 Procedures Used to Establish RF Signal for SAR.....	24
	10.2 SAR Measurement Conditions for WCDMA/HSDPA/HSUPA.....	24
	10.3 SAR Measurement Conditions for CDMA2000, 1xEV-DO	25
	11.4 SAR Measurement Conditions for LTE Bands	29
	SAR Data Summary –LTE Band 17	43
	SAR Data Summary –LTE Band 13	44
	SAR Data Summary – 835 MHz Body – CDMA BC0.....	45
	SAR Data Summary – 850 MHz Body – UMTS Band 5.....	46
	SAR Data Summary –LTE Band 5	47
	SAR Data Summary –LTE Band 4	48
	SAR Data Summary – 1750 MHz Body – UMTS Band 4.....	49
	SAR Data Summary – 1900 MHz Body – CDMA BC1.....	50
	SAR Data Summary – 1900 MHz Body – UMTS Band 2.....	51
	SAR Data Summary –LTE Band 25	52
	SAR Data Summary – Simultaneous Evaluation	53
12.	Test Equipment List.....	54
13.	Conclusion	55
14.	References.....	56
	Appendix A – System Validation Plots and Data	57
	Appendix B – SAR Test Data Plots	67
	Appendix C – SAR Test Setup Photos	78
	Appendix D – Probe Calibration Data Sheets.....	92
	Appendix E – Dipole Calibration Data Sheets	104
	Appendix F – Phantom Calibration Data Sheets	137

1. Introduction

This measurement report shows compliance of the Dejero Labs Inc. Model LIVE+ EnGo FCC ID: Y99MC7354 with FCC Part 2, 1093, ET Docket 93-62 Rules for mobile and portable devices and IC Certificate: 12762A-MC7354 with RSS102 Issue 5 & Safety Code 6. The FCC have adopted the guidelines for evaluating the environmental effects of radio frequency radiation in ET Docket 93-62 on August 6, 1996 to protect the public and workers from the potential hazards of RF emissions due to FCC regulated portable devices. [1], [6]

The test results recorded herein are based on a single type test of Dejero Labs Inc. Model LIVE+ EnGo and therefore apply only to the tested sample.

The test procedures, as described in ANSI C95.1 – 1999 Standard for Safety Levels with Respect to Human Exposure to Radio Frequency Electromagnetic Fields, 3 kHz to 300 GHz [2], ANSI C95.3 – 2002 Recommended Practice for the Measurement of Potentially Hazardous Electromagnetic Fields [3], IEEE Std.1528 – 2003 Recommended Practice [4], and Industry Canada Safety Code 6 Limits of Human Exposure to Radiofrequency Electromagnetic Fields in the Frequency Range from 3kHz to 300 GHz were employed.

The following table indicates all the wireless technologies operating in the LIVE+ EnGo Wireless Video Transceiver. The table also shows the tolerance for the power level for each mode (if applicable). The client requested only some of the technologies to be tested. All technologies marked as “not tested” must be turned off with firmware.

Band	Technology	Class	3GPP Nominal Power dBm	Tolerance dBm	Lower Tolerance dBm	Upper Tolerance dBm
Band 25 – 1900 MHz	LTE – FDD	3	23	+1.0/-1.5	21.5	24.0
Band 2 – 1900 MHz	LTE – FDD	3	23	+1.0/-1.5	21.5	24.0
Band 17 – 700 MHz	LTE – FDD	3	23	+1.0/-1.5	21.5	24.0
Band 13 – 782 MHz	LTE – FDD	3	23	+1.0/-1.5	21.5	24.0
Band 5 – 850 MHz	LTE – FDD	3	23	+1.0/-1.5	21.5	24.0
Band 4 – 1750 MHz	LTE – FDD	3	23	+1.0/-1.5	21.5	24.0
Band 5 – 850 MHz	GPRS	4	33	Not Tested		
Band 5 – 850 MHz	EDGE	E2	27			
Band 2 – 1900 MHz	GPRS	1	30			
Band 2 – 1900 MHz	EDGE	E2	26			
BC0 – 835 MHz	CDMA	3	24	+1.0/-1.5	22.5	25.0
BC1 – 1900 MHz	CDMA	3	24	+1.0/-1.5	22.5	25.0
BC10 – 835 MHz	CDMA	3	24	+1.0/-1.5	22.5	25.0
Band 5 – 850 MHz	UMTS	3	23	+1.0/-1.5	21.5	24.0
Band 4 – 1750 MHz	UMTS	3	23	+1.0/-1.5	21.5	24.0
Band 2 – 1900 MHz	UMTS	3	23	+1.0/-1.5	21.5	24.0

SAR Definition [5]

Specific Absorption Rate is defined as the time derivative (rate) of the incremental energy (dW) absorbed by (dissipated in) an incremental mass (dm) contained in a volume element (dV) of a given density (ρ).

$$SAR = \frac{d}{dt} \left(\frac{dW}{dm} \right) = \frac{d}{dt} \left(\frac{dW}{\rho dV} \right)$$

SAR is expressed in units of watts per kilogram (W/kg). SAR can be related to the electric field at a point by

$$SAR = \frac{\sigma |E|^2}{\rho}$$

where:

σ = conductivity of the tissue (S/m)

ρ = mass density of the tissue (kg/m³)

E = rms electric field strength (V/m)

2. SAR Measurement Setup

Robotic System

These measurements are performed using the DASY52 automated dosimetric assessment system. The DASY52 is made by Schmid & Partner Engineering AG (SPEAG) in Zurich, Switzerland and consists of high precision robotics system (Staubli), robot controller, Intel Core2 computer, near-field probe, probe alignment sensor, and the generic twin phantom containing the brain equivalent material. The robot is a six-axis industrial robot performing precise movements to position the probe to the location (points) of maximum electromagnetic field (EMF) (see Fig. 2.1).

System Hardware

A cell controller system contains the power supply, robot controller teach pendant (Joystick), and a remote control used to drive the robot motors. The PC consists of the HP Intel Core2 computer with Windows XP system and SAR Measurement Software DASY52, A/D interface card, monitor, mouse, and keyboard. The Staubli Robot is connected to the cell controller to allow software manipulation of the robot. A data acquisition electronic (DAE) circuit that performs the signal amplification, signal multiplexing, AD-conversion, offset measurements, mechanical surface detection, collision detection, etc. is connected to the Electro-optical coupler (EOC). The EOC performs the conversion from the optical into digital electric signal of the DAE and transfers data to the PC plug-in card.



Figure 2.1 SAR Measurement System Setup

System Electronics

The DAE4 consists of a highly sensitive electrometer-grade preamplifier with auto-zeroing, a channel and gain-switching multiplexer, a fast 16 bit AD-converter and a command decoder and control logic unit. Transmission to the PC-card is accomplished through an optical downlink for data and status information and an optical uplink for commands and clock lines. The mechanical probe mounting device includes two different sensor systems for frontal and sidewise probe contacts. They are also used for mechanical surface detection and probe collision detection. The robot uses its own controller with a built in VME-bus computer. The system is described in detail in.

Probe Measurement System

The SAR measurements were conducted with the dosimetric probe EX3DV4, designed in the classical triangular configuration (see Fig. 2.2) and optimized for dosimetric evaluation. The probe is constructed using the thick film technique; with printed resistive lines on ceramic substrates. The probe is equipped with an optical multi fiber line ending at the front of the probe tip. (see Fig. 2.3) It is connected to the EOC box on the robot arm and provides an automatic detection of the phantom surface. Half of the fibers are connected to a pulsed infrared transmitter, the other half to a synchronized receiver. As the probe approaches the surface, the reflection from the surface produces a coupling from the transmitting to the receiving fibers. This reflection increases first during the approach, reaches maximum and then decreases. If the probe is flatly touching the surface, the coupling is zero. The distance of the coupling maximum to the surface is independent of the surface reflectivity and largely independent of the surface to probe angle. The DASY52 software reads the reflection during a software approach and looks for the maximum using a 2nd order fitting. The approach is stopped at reaching the maximum.



DAE System

Probe Specifications

Calibration: In air from 10 MHz to 6.0 GHz
In brain and muscle simulating tissue at Frequencies of 450 MHz, 835 MHz, 1750 MHz, 1900 MHz, 2450 MHz, 2600 MHz, 3500 MHz, 5200 MHz, 5300 MHz, 5600 MHz, 5800 MHz

Frequency: 10 MHz to 6 GHz

Linearity: ± 0.2 dB (30 MHz to 6 GHz)

Dynamic: 10 mW/kg to 100 W/kg

Range: Linearity: ± 0.2 dB

Dimensions: Overall length: 330 mm

Tip length: 20 mm

Body diameter: 12 mm

Tip diameter: 2.5 mm

Distance from probe tip to sensor center: 1 mm

Application: SAR Dosimetry Testing
Compliance tests of wireless device



Figure 2.2 Triangular Probe Configurations



Figure 2.3 Probe Thick-Film Technique

Probe Calibration Process

Dosimetric Assessment Procedure

Each probe is calibrated according to a dosimetric assessment procedure described in with accuracy better than +/- 10%. The spherical isotropy was evaluated with the procedure described in and found to be better than +/-0.25dB. The sensitivity parameters (Norm X, Norm Y, Norm Z), the diode compression parameter (DCP) and the conversion factor (Conv F) of the probe is tested.

Free Space Assessment

The free space E-field from amplified probe outputs is determined in a test chamber. This is performed in a TEM cell for frequencies below 1 GHz, and in a waveguide above 1GHz for free space. For the free space calibration, the probe is placed in the volumetric center of the cavity at the proper orientation with the field. The probe is then rotated 360 degrees until the three channels show the maximum reading. The power density readings equates to 1 mW/cm².

Temperature Assessment *

E-field temperature correlation calibration is performed in a flat phantom filled with the appropriate simulated brain tissue. The measured free space E-field in the medium, correlates to temperature rise in a dielectric medium. For temperature correlation calibration a RF transparent thermistor based temperature probe is used in conjunction with the E-field probe

$$SAR = C \frac{\Delta T}{\Delta t}$$

$$SAR = \frac{|E|^2 \cdot \sigma}{\rho}$$

where:

where:

Δt = exposure time (30 seconds),

σ = simulated tissue conductivity,

C = heat capacity of tissue (brain or muscle),

ρ = Tissue density (1.25 g/cm³ for brain tissue)

ΔT = temperature increase due to RF exposure.

SAR is proportional to $\Delta T / \Delta t$, the initial rate of tissue heating, before thermal diffusion takes place.

Now it's possible to quantify the electric field in the simulated tissue by equating the thermally derived SAR to the E- field;



Figure 2.4 E-Field and Temperature Measurements at 900MHz



Figure 2.5 E-Field and Temperature Measurements at 1800MHz

Data Extrapolation

The DASY52 software automatically executes the following procedures to calculate the field units from the microvolt readings at the probe connector. The first step of the evaluation is a linearization of the filtered input signal to account for the compression characteristics of the detector diode. The compensation depends on the input signal, the diode type and the DC-transmission factor from the diode to the evaluation electronics. If the exciting field is pulsed, the crest factor of the signal must be known to correctly compensate for peak power. The formula for each channel can be given like below;

$$V_i = U_i + U_i^2 \cdot \frac{cf}{dcp_i}$$

with V_i = compensated signal of channel i (i=x,y,z)
 U_i = input signal of channel i (i=x,y,z)
 cf = crest factor of exciting field (DASY parameter)
 dcp_i = diode compression point (DASY parameter)

From the compensated input signals the primary field data for each channel can be evaluated:

E-field probes:

$$E_i = \sqrt{\frac{V_i}{Norm_i \cdot ConvF}}$$

with V_i = compensated signal of channel i (i = x,y,z)
 $Norm_i$ = sensor sensitivity of channel i (i = x,y,z)
 $\mu V/(V/m)^2$ for E-field probes
 $ConvF$ = sensitivity of enhancement in solution
 E_i = electric field strength of channel i in V/m

The RSS value of the field components gives the total field strength (Hermetian magnitude):

$$E_{tot} = \sqrt{E_x^2 + E_y^2 + E_z^2}$$

The primary field data are used to calculate the derived field units.

$$SAR = E_{tot}^2 \cdot \frac{\sigma}{\rho \cdot 1000}$$

with SAR = local specific absorption rate in W/g
 E_{tot} = total field strength in V/m
 σ = conductivity in [mho/m] or [Siemens/m]
 ρ = equivalent tissue density in g/cm³

The power flow density is calculated assuming the excitation field to be a free space field.

$$P_{free} = \frac{E_{tot}^2}{3770}$$

with P_{pwe} = equivalent power density of a plane wave in W/cm²
 E_{tot} = total electric field strength in V/m

Scanning procedure

- The DASY installation includes predefined files with recommended procedures for measurements and system check. They are read-only document files and destined as fully defined but unmeasured masks. All test positions (head or body-worn) are tested with the same configuration of test steps differing only in the grid definition for the different test positions.
- The „reference“ and „drift“ measurements are located at the beginning and end of the batch process. They measure the field drift at one single point in the liquid over the complete procedure. The indicated drift is mainly the variation of the DUT's output power and should vary max. +/- 5 %.
- The highest integrated SAR value is the main concern in compliance test applications. These values can mostly be found at the inner surface of the phantom and cannot be measured directly due to the sensor offset in the probe. To extrapolate the surface values, the measurement distances to the surface must be known accurately. A distance error of 0.5mm could produce SAR errors of 6% at 1800 MHz. Using predefined locations for measurements is not accurate enough. Any shift of the phantom (e.g., slight deformations after filling it with liquid) would produce high uncertainties. For an automatic and accurate detection of the phantom surface, the DASY5 system uses the mechanical surface detection. The detection is always at touch, but the probe will move backward from the surface the indicated distance before starting the measurement.
- The „area scan“ measures the SAR above the DUT or verification dipole on a parallel plane to the surface. It is used to locate the approximate location of the peak SAR with 2D spline interpolation. The robot performs a stepped movement along one grid axis while the local electrical field strength is measured by the probe. The probe is touching the surface of the SAM during acquisition of measurement values. The scan uses different grid spacings for different frequency measurements. Standard grid spacing for head measurements in frequency ranges ≤ 2 GHz is 15 mm in x - and y- dimension. For higher frequencies a finer resolution is needed, thus for the grid spacing is reduced according the following table:

Area scan grid spacing for different frequency ranges	
Frequency range	Grid spacing
≤ 2 GHz	≤ 15 mm
2 – 4 GHz	≤ 12 mm
4 – 6 GHz	≤ 10 mm

Grid spacing and orientation have no influence on the SAR result. For special applications where the standard scan method does not find the peak SAR within the grid, e.g. mobile phones with flip cover, the grid can be adapted in orientation. Results of this coarse scan are shown in annex B.

- A „zoom scan” measures the field in a volume around the 2D peak SAR value acquired in the previous „coarse” scan. It uses a fine meshed grid where the robot moves the probe in steps along all the 3 axis (x,y and z-axis) starting at the bottom of the Phantom. The grid spacing for the cube measurement is varied according to the measured frequency range, the dimensions are given in the following table:

Zoom scan grid spacing and volume for different frequency ranges			
Frequency range	Grid spacing for x, y axis	Grid spacing for z axis	Minimum zoom scan volume
≤ 2 GHz	≤ 8 mm	≤ 5 mm	≥ 30 mm
2 – 3 GHz	≤ 5 mm	≤ 5 mm	≥ 28 mm
3 – 4 GHz	≤ 5 mm	≤ 4 mm	≥ 28 mm
4 – 5 GHz	≤ 4 mm	≤ 3 mm	≥ 25 mm
5 – 6 GHz	≤ 4 mm	≤ 2 mm	≥ 22 mm

DASY is also able to perform repeated zoom scans if more than 1 peak is found during area scan. In this document, the evaluated peak 1g and 10g averaged SAR values are shown in the 2D-graphics in annex B. Test results relevant for the specified standard (see section 3) are shown in table form in section 7.

Spatial Peak SAR Evaluation

The spatial peak SAR - value for 1 and 10 g is evaluated after the Cube measurements have been done. The basis of the evaluation are the SAR values measured at the points of the fine cube grid consisting of all points in the three directions x, y and z. The algorithm that finds the maximal averaged volume is separated into three different stages.

- The data between the dipole center of the probe and the surface of the phantom are extrapolated. This data cannot be measured since the center of the dipole is 1 to 2.7 mm away from the tip of the probe and the distance between the surface and the lowest measuring point is about 1 mm (see probe calibration sheet). The extrapolated data from a cube measurement can be visualized by selecting 'Graph Evaluated'.
- The maximum interpolated value is searched with a straight-forward algorithm. Around this maximum the SAR - values averaged over the spatial volumes (1g or 10 g) are computed using the 3d-spline interpolation algorithm. If the volume cannot be evaluated (i.e., if a part of the grid was cut off by the boundary of the measurement area) the evaluation will be started on the corners of the bottom plane of the cube.
- All neighbouring volumes are evaluated until no neighbouring volume with a higher average value is found.

Extrapolation

The extrapolation is based on a least square algorithm [W. Gander, Computermathematik, p.168-180]. Through the points in the first 3 cm along the z-axis, polynomials of order four are calculated. These polynomials are then used to evaluate the points between the surface and the probe tip. The points, calculated from the surface, have a distance of 1 mm from each other.

Interpolation

The interpolation of the points is done with a 3d-Spline. The 3d-Spline is composed of three one-dimensional splines with the "Not a knot"-condition [W. Gander, Computermathematik, p.141-150] (x, y and z -direction) [Numerical Recipes in C, Second Edition, p.123ff].

Volume Averaging

At First the size of the cube is calculated. Then the volume is integrated with the trapezoidal algorithm. 8000 points (20x20x20) are interpolated to calculate the average.

Advanced Extrapolation

DASY uses the advanced extrapolation option which is able to compensate boundary effects on E-field probes.

SAM PHANTOM

The SAM Twin Phantom V4.0 is constructed of a fiberglass shell integrated in a wooden table. The shape of the shell is based on data from an anatomical study designed to determine the maximum exposure in at least 90% of all users. It enables the dosimetric evaluation of left and right hand phone usage as well as body mounted usage at the flat phantom region. A cover prevents the evaporation of the liquid. Reference markings on the Phantom allow the complete setup of all predefined phantom positions and measurement grids by manually teaching three points in the robot. (see Fig. 2.6)

Phantom Specification

Phantom: SAM Twin Phantom (V4.0)
Shell Material: Vivac Composite
Thickness: 2.0 ± 0.2 mm



Figure 2.6 SAM Twin Phantom

Device Holder for Transmitters

In combination with the SAM Twin Phantom V4.0 the Mounting Device (see Fig. 2.7), enables the rotation of the mounted transmitter in spherical coordinates whereby the rotation point is the ear opening. The devices can be easily, accurately, and repeatedly positioned according to the FCC, CENELEC, IEC and IEEE specifications. The device holder can be locked at different phantom locations (left head, right head, flat phantom).



Figure 2.7 Mounting Device

Note: A simulating human hand is not used due to the complex anatomical and geometrical structure of the hand that may produce infinite number of configurations. To produce the worst-case condition (the hand absorbs antenna output power), the hand is omitted during the tests.

3. Probe and Dipole Calibration

See Appendix D and E.

4. Phantom & Simulating Tissue Specifications

Head & Body Simulating Mixture Characterization

The head and body mixtures consist of the material based on the table listed below. The mixture is calibrated to obtain proper dielectric constant (permittivity) and conductivity of the desired tissue. Body tissue parameters that have not been specified in P1528 are derived from the issue dielectric parameters computed from the 4-Cole-Cole equations.

Table 4.1 Typical Composition of Ingredients for Tissue

Ingredients		Simulating Tissue			
		750 MHz Body	835 MHz Body	1750 MHz Body	1900 MHz Body
Mixing Percentage					
Water		Proprietary Purchased from Speag	52.50	Proprietary Purchased from Speag	69.91
Sugar			45.00		0.00
Salt			1.40		0.13
HEC			1.00		0.00
Bactericide			0.10		0.00
DGBE			0.00		29.96
Dielectric Constant	Target	55.5	55.20	53.4	53.30
Conductivity (S/m)	Target	0.96	0.97	1.49	1.52

5. ANSI/IEEE C95.1 – 1992 RF Exposure Limits [2]

Uncontrolled Environment

Uncontrolled Environments are defined as locations where there is the exposure of individuals who have no knowledge or control of their exposure. The general population/uncontrolled exposure limits are applicable to situations in which the general public may be exposed or in which persons who are exposed as a consequence of their employment may not be made fully aware of the potential for exposure or cannot exercise control over their exposure. Members of the general public would come under this category when exposure is not employment-related; for example, in the case of a wireless transmitter that exposes persons in its vicinity.

Controlled Environment

Controlled Environments are defined as locations where there is exposure that may be incurred by persons who are aware of the potential for exposure, (i.e. as a result of employment or occupation). In general, occupational/controlled exposure limits are applicable to situations in which persons are exposed as a consequence of their employment, who have been made fully aware of the potential for exposure and can exercise control over their exposure. This exposure category is also applicable when the exposure is of a transient nature due to incidental passage through a location where the exposure levels may be higher than the general population/uncontrolled limits, but the exposed person is fully aware of the potential for exposure and can exercise control over his or her exposure by leaving the area or by some other appropriate means.

Table 5.1 Human Exposure Limits

	UNCONTROLLED ENVIRONMENT General Population (W/kg) or (mW/g)	CONTROLLED ENVIROMENT Professional Population (W/kg) or (mW/g)
SPATIAL PEAK SAR ¹ Head	1.60	8.00
SPATIAL AVERAGE SAR ² Whole Body	0.08	0.40
SPATIAL PEAK SAR ³ Hands, Feet, Ankles, Wrists	4.00	20.00

¹ The Spatial Peak value of the SAR averaged over any 1 gram of tissue (defined as a tissue volume in the shape of a cube) and over the appropriate averaging time.

² The Spatial Average value of the SAR averaged over the whole body.

³ The Spatial Peak value of the SAR averaged over any 10 grams of tissue (defined as a tissue volume in the shape of a cube) and over the appropriate averaging time.

6. Measurement Uncertainty

Measurement uncertainty table is not required per KDB 865664 D01 v01 section 2.8.2 page 12. SAR measurement uncertainty analysis is required in the SAR report only when the highest measured SAR in a frequency band is ≥ 1.5 W/kg for 1-g SAR. The equivalent ratio (1.5/1.6) should be applied to extremity and occupational exposure conditions. The highest reported value is less than 1.5 W/kg. Therefore, the measurement uncertainty table is not required.

7. System Validation

Tissue Verification

Table 7.1 Measured Tissue Parameters

		750 MHz Body		835 MHz Body		1750 MHz Body	
Date(s)		May 22, 2015		May 21, 2015		May 23, 2015	
Liquid Temperature (°C)	20.0	Target	Measured	Target	Measured	Target	Measured
Dielectric Constant: ϵ		55.53	54.69	55.20	54.37	53.43	52.68
Conductivity: σ		0.96	0.94	0.97	0.98	4.49	1.56
		1900 MHz Body					
Date(s)		May 18, 2015					
Liquid Temperature (°C)	20.0	Target	Measured				
Dielectric Constant: ϵ		53.30	53.17				
Conductivity: σ		1.52	1.54				

See Appendix A for data printout.

Test System Verification

Prior to assessment, the system is verified to the $\pm 10\%$ of the specifications at the test frequency by using the system kit. Power is normalized to 1 watt. (Graphic Plots Attached)

Table 7.2 System Dipole Validation Target & Measured

	Test Frequency	Targeted SAR _{1g} (W/kg)	Measure SAR _{1g} (W/kg)	Tissue Used for Verification	Deviation Target and Fast SAR to SAR (%)	Plot Number
22-May-2015	750 MHz	8.74	8.65	Body	- 1.03	1
21-May-2015	835 MHz	9.51	9.43	Body	- 0.84	2
23-May-2015	1750 MHz	37.30	38.50	Body	+ 3.22	3
18-May-2015	1900 MHz	40.20	40.20	Body	+ 0.00	4

See Appendix A for data plots.

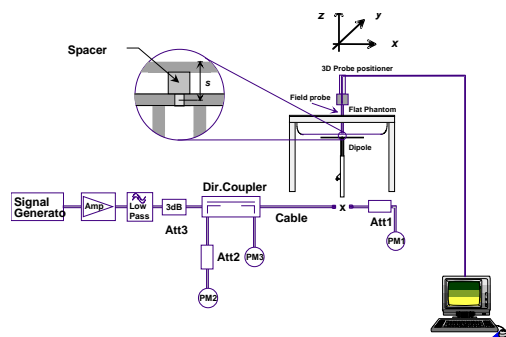

Figure 7.1 Dipole Validation Test Setup

8. SAR Test Data Summary

See Measurement Result Data Pages

See Appendix B for SAR Test Data Plots.
See Appendix C for SAR Test Setup Photos.

Procedures Used To Establish Test Signal

The device was either placed into simulated transmit mode using the manufacturer's test codes or the actual transmission is activated through a base station simulator or similar equipment. See data pages for actual procedure used in measurement.

Device Test Condition

In order to verify that the device was tested at full power, conducted output power measurements were performed before and after each SAR measurement to confirm the output power unless otherwise noted. If a conducted power deviation of more than 5% occurred, the test was repeated. The power drift of each test is measured at the start of the test and again at the end of the test. The drift percentage is calculated by the formula $((\text{end}/\text{start})-1)*100$ and rounded to three decimal places. The drift percentage is calculated into the resultant SAR value on the data sheet for each test.

The EUT was tested on the end of the device where the antennas are located and on each side next to the antenna. All measurements for the device were conducted with the side of the device 10 mm from the phantom. The 10 mm gap was to simulate the closest distance the side can get to the user when installed in the carrying bag which is the normal use for the device. The carrying bag is made of all nylon and Styrofoam.

The device was on a minimum of 10 cm of Styrofoam during each test.

The 1xRTT testing was conducted in RC3 with the device configured using TDSO/SO32 with FCH transmitting at full rate. The power control was set to "All Bits Up." 1xRTT did not require SAR testing due to the measured power being less than ¼ dB higher than Rev. 0.

The Rev. 0 testing was conducted with the Reverse Data Channel rate of 153.6 kbps. The Forward Traffic Channel data rate is set to the 2-slot version of 307.2 kbps with the ACK Channel transmitting in all slots. The power control was set to "All Bits Up." Other rates were not tested due to the conducted power measured was less than ¼ dB higher than 153.6 kbps.

The Rev. A Subtype 2 testing was conducted with the Reverse Data Channel payload size of 4096 bits and Termination Target of 16 slots. The Forward Traffic Channel data rate is set to the 2-slot version of 307.2 kbps with the ACK Channel transmitting in all slots. The power control was set to "All Bits Up." Rev. A did not require SAR testing due to the measured power being less than ¼ dB higher than Rev. 0.

The WCDMA testing was conducted using 12.2 kbps RMC configured in Test Loop Mode 1. The HSPA testing was conducted with HS-DPCCH, E-DPCCH and E-DPDCH all enabled and a 12.2 kbps RMC. FRC was configured according to HS-DPCCH Sub-Test 1 using H-set 1 and QPSK.

9. LTE Document Checklist

- 1) Identify the operating frequency range of each LTE transmission band used by the device

LTE Operating Band	Uplink (transmit)	Downlink (Receive)	Duplex mode (FDD/TDD)
	Low - high	Low - high	
4	1710-1755	2110-2155	FDD
5	824-849	869-894	FDD
13	777-787	746-756	FDD
17	704-716	734-746	FDD
2 & 25	1850-1915	1930-1995	FDD

- 2) Identify the channel bandwidths used in each frequency band; 1.4, 3, 5, 10, 15, 20 MHz etc

LTE Band Class	Bandwidth (MHz)	Frequency or Freq. Band (MHz)
4	1.4, 3, 5, 10, 15, 20	1710-1755
5	5, 10	824-849
13	5, 10	777-787
17	5, 10	704-716
2 & 25	1.4, 3, 5, 10, 15, 20	1850-1915

- 3) Identify the high, middle and low (H, M, L) channel numbers and frequencies in each LTE frequency band

LTE Band Class	Bandwidth (MHz)	Frequency (MHz)/Channel #					
		Low		Mid		High	
4	1.4	1710.7	19957	1732.5	20175	1754.3	20393
4	3	1711.5	19965	1732.5	20175	1753.5	20385
4	5	1712.5	19975	1732.5	20175	1752.5	20375
4	10	1715.0	20000	1732.5	20175	1750.0	20350
4	15	1717.5	20025	1732.5	20175	1747.5	20325
4	20	1720.0	20050	1732.5	20175	1745.0	20300
5	5	826.5	20425	836.5	20525	846.5	20625
5	10	829.0	20450	836.5	20525	844.0	20600
13	5	779.5	23205	782.0	23230	784.5	23255
13	10	-----	-----	782.0	23230	-----	-----
17	5	706.5	23755	710.0	23790	713.5	23825
17	10	709.0	23780	710.0	23790	711.0	23800
2 & 25	1.4	1850.7	18607	1882.5	26365	1914.3	26715
2 & 25	3	1851.5	18615	1882.5	26365	1913.5	26690
2 & 25	5	1852.5	18625	1882.5	26365	1912.5	26665
2 & 25	10	1855.0	18650	1882.5	26365	1910.0	26640
2 & 25	15	1857.5	18675	1882.5	26365	1907.5	26615
2 & 25	20	1860.0	18700	1882.5	26365	1905.0	26590

- 4) Specify the UE category and uplink modulations used:
 - UE Category: 3
 - Uplink modulations: QPSK and 16QAM
- 5) Include descriptions of the LTE transmitter and antenna implementation; and also identify whether it is a standalone transmitter operating independently of other wireless transmitters in the device or sharing hardware components and/or antenna(s) with other transmitters etc

The device has 8 antennas:

- WWAN Main (6-Transmit and 8-Receive) Antenna

- 6) Identify the LTE voice/data requirements in each operating mode and exposure condition with respect to head and body test configurations, antenna locations, handset flip-cover or slide positions, antenna diversity conditions etc

The device is a data only device. Data mode was tested in each operating mode and exposure condition in the body configuration. See test setup photos to see all configurations tested.

- 7) Identify if Maximum Power Reduction (MPR) is optional or mandatory, i.e. built-in by design:
 - a) Only mandatory MPR may be considered during SAR testing, when the maximum output power is permanently limited by the MPR implemented within the UE; and only for the applicable RB (resource block) configurations specified in LTE standards

MPR is mandatory, built-in by design on all production units. It was enabled during testing.

Modulation	Channel Bandwidth/transmission Bandwidth Configuration (RB)						MPR (dB)
	1.4 MHz	3.0 MHz	5 MHz	10 MHz	15 MHz	20 MHz	
QPSK	> 5	> 4	> 8	> 12	> 16	> 18	≤ 1
16QAM	≤ 5	≤ 4	≤ 8	≤ 12	≤ 16	≤ 18	≤ 1
16QAM	> 5	> 4	> 8	> 12	> 16	> 18	≤ 2

- b) A-MPR (additional MPR) must be disabled

A-MPR was disabled during testing.

- 8) Include the maximum average conducted output power on the required test channels for each channel bandwidth and UL modulation used in each frequency band:

The maximum average conducted output power for the testing is listed on pages 26-35 of this report. The below table shows the factory set point with the allowable tolerance.

LTE Band	Power Class	Modulation	Factory Conducted Power (dBm)	
			Set point	Tolerance (+/-)
4	3	QPSK	23.0	+1.0/-1.5
4	3	16QAM	22.0	+1.0/-1.5
5	3	QPSK	23.0	+1.0/-1.5
5	3	16QAM	22.0	+1.0/-1.5
13	3	QPSK	23.0	+1.0/-1.5
13	3	16QAM	22.0	+1.0/-1.5
17	3	QPSK	23.0	+1.0/-1.5
17	3	16QAM	22.0	+1.0/-1.5
2 & 25	3	QPSK	23.0	+1.0/-1.5
2 & 25	3	16QAM	22.0	+1.0/-1.5

- 9) Identify all other U.S. wireless operating modes (3G, Wi-Fi, WiMax, Bluetooth etc), device/exposure configurations (head and body, antenna and handset flip-cover or slide positions, antenna diversity conditions etc.) and frequency bands used for these modes

Other wireless modes:

Technology	Frequency (MHz)	Band Name	Transmitter Range	Receiver Range	Factory Conducted Power (dBm)	
					Set point	Tolerance (+/-)
CDMA	EvDo Rev 0	850 MHz – BC0, BC10	806-849, 896-901	851-894, 935-940	24.0	+1.0/-1.5
		1900 MHz – BC1	1850-1910	1903-1990	24.0	+1.0/-1.5
WCDMA/HSPA	R7 HSDPA Cat 10 R6 HSUPA Cat 6	Band II – 1900MHz	1850-1900	1930-1990	23.0	+1.0/-1.5
		Band V – 850MHz	826-850	970-890	23.0	+1.0/-1.5

- 10) Include the maximum average conducted output power measured for the other wireless modes and frequency bands.

The maximum average conducted output power measured for the testing is listed on pages 22-23 of this report. The table in item 9 shows the factory set point with the allowable tolerance.

- 11) When power reduction is applied to certain wireless modes to satisfy SAR compliance for

simultaneous transmission conditions, other equipment certification or operating requirements, include the maximum average conducted output power measured in each power reduction mode applicable to the simultaneous voice/data transmission configurations for such wireless configurations and frequency bands; and also include details of the power reduction implementation and measurement setup

Power reduction is not required to satisfy SAR compliance.

- 12) Include descriptions of the test equipment, test software, built-in test firmware etc. required to support testing the device when power reduction is applied to one or more transmitters/antennas for simultaneous voice/data transmission

Power reduction is not required to satisfy SAR compliance.

- 13) When appropriate, include a SAR test plan proposal with respect to the above

Power reduction is not required to satisfy SAR compliance.

- 14) If applicable, include preliminary SAR test data and/or supporting information in laboratory testing inquiries to address specific issues and concerns or for requesting further test reduction considerations appropriate for the device; for example, simultaneous transmission configurations.

Not applicable.

10. FCC 3G Measurement Procedures

Power measurements were performed using a base station simulator under average power.

10.1 Procedures Used to Establish RF Signal for SAR

The device was placed into a simulated call using a base station simulator in a screen room. Such test signals offer a consistent means for testing SAR and recommended for evaluating SAR. The SAR measurement software calculates a reference point at the start and end of the test to check for power drifts. If conducted power deviations of more than 5% occurred, the tests were repeated.

10.2 SAR Measurement Conditions for WCDMA/HSDPA/HSUPA

Configure the call box 8960 to support all WCDMA tests in respect to the 3GPP 34.121 (listed in Table below). Measure the power at Ch4132, 4182 and 4233 for US cell; Ch9262, 9400 and 9538 for US PCS band.

For Rel99

- Set a Test Mode 1 loop back with a 12.2kbps Reference Measurement Channel (RMC).
- Set and send continuously Up power control commands to the device
- Measure the power at the device antenna connector using the power meter with average detector.

For HSDPA Rel 6

- Establish a Test Mode 1 loop back with both 1 12.2kbps RMC channel and a H-Set1 Fixed Reference Channel (FRC). With the 8960 this is accomplished by setting the signal Channel Coding to “Fixed Reference Channel” and configuring for HSET-1 QKSP.
- Set beta values and HSDPA settings for HSDPA Subtest1 according to Table below.
- Send continuously Up power control commands to the device
- Measure the power at the device antenna connector using the power meter with modulated average detector.
- Repeat the measurement for the HSDPA Subtest2, 3 and 4 as given in Table below.

For HSUPA Rel 6

- Use UL RMC 12.2kbps and FRC H-Set1 QPSK, Test Mode 1 loop back. With the 8960 this is accomplished by setting the signal Channel Coding to “E-DCH Test Channel” and configuring the equipment category to Cat5_10ms.
- Set the Absolute Grant for HSUPA Subtest1 according to Table below.
- Set the device power to be at least 5dB lower than the Maximum output power
- Send power control bits to give one TPC_cmd = +1 command to the device. If device doesn't send any E-DPCH data with decreased E-TFCl within 500ms, then repeat this process until the decreased E-TFCl is reported.
- Confirm that the E-TFCl transmitted by the device is equal to the target E-TFCl in Table below. If the E-TFCl transmitted by the device is not equal to the target E-TFCl, then send power control bits to give one TPC_cmd = -1 command to the UE. If UE sends any E-DPCH data with decreased E-TFCl within 500 ms, send new power control bits to give one TPC_cmd = -1 command to the UE. Then confirm that the E-TFCl transmitted by the UE is equal to the target E-TFCl in Table below.
- Measure the power using the power meter with modulated average detector.
- Repeat the measurement for the HSUPA Subtest2, 3, 4 and 5 as given in Table below.

10.3 SAR Measurement Conditions for CDMA2000, 1xEV-DO

10.3.1 Output Power Verification 1xRTT

Use CDMA2000 Rev 6 protocol in the call box.

- 1) Test for RC 3 Reverse FCH, RC3 Reverse SCH0 and demodulation of RC 3, 4 and 5.
 - a. Set up a call using Supplemental Channel Test Mode 3 (RC 3, SO 32) with 9600 bps Fundamental Channel and 9600 bps SCH0 data rate.
 - b. As per C.S0011 or TIA/EIA-98-F Table 4.4.5.2-2, set the test parameters.
 - c. Send alternating '0' and '1' power control bit to the device
 - d. Determine the active channel configuration. If the desired channel configuration is not the active channel configuration, increase \hat{I}_{or} by 1 dB and repeat the verification. Repeat this step until the desired channel configuration becomes active.
 - e. Measure the output power at the device antenna connector.
 - f. Decrease \hat{I}_{or} by 0.5 dB.
 - g. Determine the active channel configuration. If the active channel configuration is the desired channel configuration, measure the output power at the device antenna connector.
 - h. Repeat step f and g until the output power no longer increases or the desired channel configuration is no longer active. Record the highest output power achieved with the desired channel configuration active.
 - i. Repeat step a through h ten times and average the result.

10.3.2 Output Power Verification 1xEvDo

- 1) Use 1xEV-DO Rel 0 protocol in the call box 8960.
 - a. FTAP
 - Select Test Application Protocol to FTAP
 - Set FTAP Rate to 307.2 kbps (2 Slot, QPSK)
 - Generator Info -> Termination Parameters -> Max Forward Packet Duration -> 16 Slots
 - Set \hat{I}_{or} to -60 dBm/1.23 MHz
 - Send continuously '0' power control bits
 - Measure the power at device antenna connector
 - b. RTAP
 - Select Test Application Protocol to RTAP
 - Set RTAP Rate to 9.6 kbps
 - Generator Info -> Termination Parameters -> Max Forward Packet Duration -> 16 Slots
 - Set \hat{I}_{or} to -60 dBm/1.23 MHz
 - Send continuously '0' power control bits
 - Measure the power at device antenna connector
 - Repeat above steps for RTAP Rate = 19.2 kbps, 38.4 kbps, 76.8 kbps and 153.6 kbps respectively
- 2) Use 1xEV-DO Rev A protocol in the call box 8960
 - a. FETAP
 - Select Test Application Protocol to FETAP
 - Set FETAP Rate to 307.2 kbps (2 Slot, QPSK)
 - Generator Info -> Termination Parameters -> Max Forward Packet Duration -> 16 Slots
 - Set \hat{I}_{or} to -60 dBm/1.23 MHz

- Send continuously '0' power control bits
- Measure the power at device antenna connector
- b. RETAP
 - Select Test Application Protocol to RETAP
 - F-Traffic Format -> 4 (1024, 2, 128) Canonical (307.2k, QPSK) • Set R-Data Pkt Size to 128
 - Protocol Subtype Config -> Release A Physical Layer Subtype -> Subtype 2 -> PL Subtype 2 Access Channel MAC Subtype -> Default (Subtype 0)
 - Generator Info -> Termination Parameters -> Max Forward Packet Duration -> 16 Slots ->ACK R-Data After -> Subpacket 0 (All ACK)
 - Set Ior to -60 dBm/1.23 MHz
 - Send continuously '0' power control bits
 - Measure the power at device antenna connector
 - Repeat above steps for R-Data Pkt Size = 256, 512, 768, 1024, 1536, 2048, 3072, 4096, 6144, 8192, 12288 respectively.

3GPP Release Version	Mode	Cellular Band [dBm]			Sub-Test (See Table Below)	MPR
		4132	4183	4233		
99	WCDMA	23.89	23.91	23.87	-	-
6	HSDPA	23.86	23.87	23.79	1	0
6		23.82	23.89	23.85	2	0
6		23.39	23.42	23.37	3	0.5
6		23.94	23.49	23.40	4	0.5
6	HSUPA	23.80	23.90	23.83	1	0
6		21.95	21.99	21.96	2	2
6		22.97	23.08	22.99	3	1
6		22.06	22.01	22.04	4	2
6		23.82	23.84	23.87	5	0

3GPP Release Version	Mode	PCS Band [dBm]			Sub-Test (See Table Below)	MPR
		9262	9400	9538		
99	WCDMA	23.83	23.86	23.81	-	-
6	HSDPA	23.79	23.82	23.76	1	0
6		23.81	23.75	23.79	2	0
6		23.36	23.34	23.36	3	0.5
6		23.41	23.31	23.39	4	0.5
6	HSUPA	23.84	23.82	23.75	1	0
6		21.97	22.01	21.89	2	2
6		22.94	23.05	22.94	3	1
6		21.99	21.95	22.03	4	2
6		23.82	23.80	23.71	5	0

3GPP Release Version	Mode	AWS Band [dBm]			Sub-Test (See Table Below)	MPR
		1312	1413	1513		
99	WCDMA	23.88	23.95	23.90	-	-
6	HSDPA	23.82	23.86	23.74	1	0
6		23.74	23.72	23.76	2	0
6		23.45	23.39	23.38	3	0.5
6		23.43	23.34	23.35	4	0.5
6	HSUPA	23.80	23.80	23.77	1	0
6		21.98	22.06	21.84	2	2
6		22.92	23.01	22.98	3	1
6		21.97	21.92	22.05	4	2
6		23.85	23.87	23.68	5	0

Sub-Test Setup for Release 6 HSDPA

Sub-Test	β_c	β_d	B_c/β_d	β_{hs}
1	2/15	15/15	2/15	4/15
2	12/15	15/15	15/15	24/15
3	15/15	8/15	15/8	30/15
4	15/15	4/15	15/4	30/15

$\Delta_{ack}, \Delta_{nack}$ and $\Delta_{cqi} = 8$

Sub-Test Setup for Release 6 HSUPA

Sub-Test	β_c	β_d	B_c/β_d	β_{hs}	B_{ec}	B_{ed}	MPR	AG Index	E-TFCI
1	11/15	15/15	11/15	22/15	209/225	1039/225	0.0	20	75
2	6/15	15/15	6/15	12/15	12/15	94/75	2.0	12	67
3	15/15	9/15	15/9	30/15	30/15	47/15	1.0	15	92
4	2/15	15/15	2/15	4/15	2/15	56/15	2.0	17	71
5	15/15	15/15	15/15	30/15	24/15	134/15	0.0	21	81

$\Delta_{ack}, \Delta_{nack}$ and $\Delta_{cqi} = 8$

		IS-2000	1Xev-Do Rev. 0	1Xev-Do Rev. A Subtype 0/1
	Channel	TDSO SO32 RC3	RTAP/153.6 kbps [dBm]	RETAP/4096 kbps [dBm]
Cellular	50	24.32	24.36	24.31
	670	24.29	24.34	24.29
	1013	24.30	24.31	24.31
	384	24.36	24.49	24.44
	777	24.15	24.46	24.40
	870	24.19	24.22	24.18
PCS	25	24.28	24.32	24.25
	600	24.39	24.41	24.37
	1175	24.28	24.30	24.21

Figure 10.1 Test Reduction Table – CDMA

Band/ Frequency (MHz)	Technology	Required Channel	Tested/ Reduced
BC0 & BC10 824-849 MHz	CDMA ²	50	Reduced ¹
		670	Reduced ¹
		1013	Reduced ¹
		384	Tested
		777	Reduced ¹
		870	Reduced ¹
Band 2 1850-1910 MHz		25	Reduced ¹
		600	Tested
		1175	Reduced ¹

Figure 10.1 Test Reduction Table – WCDMA

Band/ Frequency (MHz)	Technology	Required Channel	Tested/ Reduced
Band 2 1850-1910 MHz	WCDMA ²	9262	Reduced ¹
		9400	Tested
		9538	Reduced ¹
Band 5 824-849 MHz		4132	Reduced ¹
		4183	Tested
		4233	Reduced ¹

Reduced¹ – When the mid channel is 3 dB below the limit, the remaining channels are not required per KDB 447498 D01 v05r02 section 4.3.3 page 14.

Reduced² – All reductions were the same for each side where the antenna was close enough to require testing. For all other sides, the testing was reduced per KDB447498 D01 v05r02 section 4.3.1 1) page 11.

11.4 SAR Measurement Conditions for LTE Bands

11.4.1 LTE Functionality

The follow table identifies all the channel bandwidths in each frequency band supported by this device.

LTE Band Class	Bandwidth (MHz)	Frequency or Freq. Band (MHz)
4	1.4, 3, 5, 10, 15, 20	1710-1755
5	5, 10	824-849
13	5, 10	777-787
17	5, 10	704-716
2 & 25	1.4, 3, 5, 10, 15, 20	1850-1915

11.4.2 Test Conditions

All SAR measurements for LTE were performed using the Anritsu MT8820C. A closed loop power control setting allowed the UE to transmit at the maximum output power during the SAR measurements. The Figure 11.1 table indicates all the test reduction utilized for this report.

MPR was enabled for this device. A-MPR was disabled for all SAR test measurements.

Band	Modulation	Bandwidth	RB Size	RB Offset	Channel	Frequency	Power
4	QPSK	1.4 MHz	6	0	19957	1710.7	23.2
					20175	1732.5	23.1
					20393	1754.3	23.2
			3	1	19957	1710.7	24.0
					20175	1732.5	24.0
					20393	1754.3	24.0
			1	0	19957	1710.7	24.0
					20175	1732.5	23.9
					20393	1754.3	23.9
		1	5	19957	1710.7	24.0	
				20175	1732.5	24.0	
				20393	1754.3	23.9	
		3 MHz	15	0	19965	1711.5	23.3
					20175	1732.5	23.4
					20385	1753.5	23.2
			8	3	19965	1711.5	23.1
					20175	1732.5	23.1
					20385	1753.5	23.2
			1	0	19965	1711.5	24.0
					20175	1732.5	24.0
					20385	1753.5	23.9
		1	14	19965	1711.5	24.0	
				20175	1732.5	24.0	
				20385	1753.5	24.0	
		5 MHz	25	0	19975	1712.5	23.3
					20175	1732.5	23.3
					20375	1752.5	23.2
			12	6	19975	1712.5	23.1
					20175	1732.5	23.3
					20375	1752.5	23.2
1	0		19975	1712.5	24.0		
			20175	1732.5	24.0		
			20375	1752.5	24.0		
1	24	19975	1712.5	24.0			
		20175	1732.5	24.0			
		20375	1752.5	23.9			

Band	Modulation	Bandwidth	RB Size	RB Offset	Channel	Frequency	Power
4	QPSK	10 MHz	50	0	20000	1715	23.1
					20175	1732.5	23.2
					20350	1750	23.3
			25	12	20000	1715	23.2
					20175	1732.5	23.3
					20350	1750	23.4
			1	0	20000	1715	24.0
					20175	1732.5	24.0
					20350	1750	24.0
			1	24	20000	1715	24.0
					20175	1732.5	24.0
					20350	1750	24.0
		15 MHz	75	0	20025	1717.5	23.1
					20175	1732.5	23.2
					20325	1747.5	23.2
			36	19	20025	1717.5	23.2
					20175	1732.5	23.2
					20325	1747.5	23.2
			1	0	20025	1717.5	24.0
					20175	1732.5	24.0
					20325	1747.5	24.0
			1	74	20025	1717.5	24.0
					20175	1732.5	24.0
					20325	1747.5	24.0
		20 MHz	100	0	20050	1720	23.2
					20175	1732.5	23.2
					20300	1745	23.3
			50	25	20050	1720	23.1
					20175	1732.5	23.1
					20300	1745	23.3
			1	0	20050	1720	24.0
					20175	1732.5	24.0
					20300	1745	24.0
			1	99	20050	1720	24.0
					20175	1732.5	24.0
					20300	1745	24.0

Band	Modulation	Bandwidth	RB Size	RB Offset	Channel	Frequency	Power
4	16QAM	1.4 MHz	6	0	19957	1710.7	22.0
					20175	1732.5	22.0
					20393	1754.3	22.2
			3	1	19957	1710.7	23.1
					20175	1732.5	23.1
					20393	1754.3	23.2
			1	0	19957	1710.7	23.0
					20175	1732.5	23.0
					20393	1754.3	23.1
			1	5	19957	1710.7	23.1
					20175	1732.5	23.0
					20393	1754.3	23.1
		3 MHz	15	0	19965	1711.5	22.2
					20175	1732.5	22.3
					20385	1753.5	22.4
			8	3	19965	1711.5	22.1
					20175	1732.5	22.3
					20385	1753.5	22.2
			1	0	19965	1711.5	23.1
					20175	1732.5	23.0
					20385	1753.5	23.1
			1	14	19965	1711.5	23.3
					20175	1732.5	23.2
					20385	1753.5	23.4
		5 MHz	25	0	19975	1712.5	22.3
					20175	1732.5	22.2
					20375	1752.5	22.1
			12	6	19975	1712.5	22.3
					20175	1732.5	22.2
					20375	1752.5	22.4
			1	0	19975	1712.5	23.0
					20175	1732.5	23.0
					20375	1752.5	23.1
			1	24	19975	1712.5	23.0
					20175	1732.5	23.0
					20375	1752.5	23.1

Band	Modulation	Bandwidth	RB Size	RB Offset	Channel	Frequency	Power
4	16QAM	10 MHz	50	0	20000	1715	22.2
					20175	1732.5	22.1
					20350	1750	22.3
			25	12	20000	1715	22.3
					20175	1732.5	22.2
					20350	1750	22.4
			1	0	20000	1715	23.3
					20175	1732.5	23.2
					20350	1750	23.2
			1	24	20000	1715	23.3
					20175	1732.5	23.1
					20350	1750	23.2
		15 MHz	75	0	20025	1717.5	22.1
					20175	1732.5	22.0
					20325	1747.5	22.1
			36	19	20025	1717.5	22.3
					20175	1732.5	22.3
					20325	1747.5	22.2
			1	0	20025	1717.5	23.2
					20175	1732.5	23.3
					20325	1747.5	23.3
			1	74	20025	1717.5	23.1
					20175	1732.5	23.0
					20325	1747.5	23.2
		20 MHz	100	0	20050	1720	22.2
					20175	1732.5	22.1
					20300	1745	22.3
			50	25	20050	1720	22.1
					20175	1732.5	22.0
					20300	1745	22.2
			1	0	20050	1720	23.3
					20175	1732.5	23.4
					20300	1745	23.2
			1	99	20050	1720	23.1
					20175	1732.5	23.2
					20300	1745	23.2

Band	Modulation	Bandwidth	RB Size	RB Offset	Channel	Frequency	Power
5	QPSK	1.4 MHz	6	0	20407	824.7	23.0
					20525	836.5	23.0
					20643	848.3	23.1
			3	1	20407	824.7	24.0
					20525	836.5	23.9
					20643	848.3	24.0
			1	0	20407	824.7	23.9
					20525	836.5	24.0
					20643	848.3	24.0
			1	5	20407	824.7	24.0
					20525	836.5	23.9
					20643	848.3	24.0
		3 MHz	15	0	20415	825.5	23.0
					20525	836.5	22.9
					20635	847.5	23.1
			8	3	20415	825.5	23.0
					20525	836.5	23.1
					20635	847.5	23.1
			1	0	20415	825.5	23.9
					20525	836.5	24.0
					20635	847.5	24.0
			1	14	20415	825.5	24.0
					20525	836.5	24.0
					20635	847.5	24.0
		5 MHz	25	0	20425	826.5	23.1
					20525	836.5	22.9
					20625	846.5	23.1
			12	6	20425	826.5	23.0
					20525	836.5	23.1
					20625	846.5	23.1
1	0		20425	826.5	23.8		
			20525	836.5	24.0		
			20625	846.5	24.0		
1	24		20425	826.5	24.0		
			20525	836.5	24.0		
			20625	846.5	24.0		

Band	Modulation	Bandwidth	RB Size	RB Offset	Channel	Frequency	Power	
5	QPSK	10 MHz	50	0	20450	829	22.9	
					20525	836.5	22.8	
					20600	844	22.8	
			25	12	20450	829	23.0	
					20525	836.5	22.9	
					20600	844	23.0	
			1	0	20450	829	24.0	
					20525	836.5	24.0	
					20600	844	23.9	
			1	24	20450	829	23.9	
					20525	836.5	24.0	
					20600	844	24.0	
	16QAM	1.4 MHz	6	0	20407	824.7	22.1	
					20525	836.5	22.2	
					20643	848.3	22.2	
			3	1	20407	824.7	22.9	
					20525	836.5	23.0	
					20643	848.3	23.1	
			1	0	20407	824.7	23.1	
					20525	836.5	23.2	
					20643	848.3	23.2	
			1	5	20407	824.7	23.2	
					20525	836.5	23.2	
					20643	848.3	23.4	
			3 MHz	15	0	20415	825.5	22.0
						20525	836.5	22.1
						20635	847.5	22.1
				8	3	20415	825.5	21.9
						20525	836.5	22.1
						20635	847.5	22.0
1	0	20415		825.5	23.0			
		20525		836.5	23.1			
		20635		847.5	23.1			
1	14	20415		825.5	23.4			
		20525		836.5	23.3			
		20635		847.5	23.4			

Band	Modulation	Bandwidth	RB Size	RB Offset	Channel	Frequency	Power
5	16QAM	5 MHz	25	0	20425	826.5	21.9
					20525	836.5	21.9
					20625	846.5	21.9
			12	6	20425	826.5	22.1
					20525	836.5	22.1
					20625	846.5	22.3
			1	0	20425	826.5	23.0
					20525	836.5	23.2
					20625	846.5	23.2
			1	24	20425	826.5	23.3
					20525	836.5	23.3
					20625	846.5	23.4
		10 MHz	50	0	20450	829	21.8
					20525	836.5	21.8
					20600	844	21.9
			25	12	20450	829	21.9
					20525	836.5	21.9
					20600	844	21.9
			1	0	20450	829	23.1
					20525	836.5	23.4
					20600	844	23.2
			1	24	20450	829	23.1
					20525	836.5	23.3
					20600	844	23.3

Band	Modulation	Bandwidth	RB Size	RB Offset	Channel	Frequency	Power		
13	QPSK	5 MHz	25	0	23205	779.5	23.35		
					23255	784.5	23.35		
			12	6	23205	779.5	23.46		
					23255	784.5	23.47		
			1	0	23205	779.5	23.45		
					23255	784.5	23.40		
		1	24	23205	779.5	23.49			
				23255	784.5	23.44			
		10 MHz	50	0	23230	782.0	23.26		
					25	13	23230	782.0	23.51
							23230	782.0	23.48
					1	49	23230	782.0	23.48
	16QAM	5 MHz	25	0	23205	779.5	22.33		
					23255	784.5	22.32		
			12	6	23205	779.5	22.58		
					23255	784.5	22.66		
			1	0	23205	779.5	23.48		
					23255	784.5	23.55		
		1	24	23205	779.5	23.64			
				23255	784.5	23.57			
		10 MHz	50	0	23230	782.0	22.20		
					25	13	23230	782.0	22.48
							23230	782.0	23.38
					1	49	23230	782.0	23.30

Band	Modulation	Bandwidth	RB Size	RB Offset	Channel	Frequency	Power
17	QPSK	5 MHz	25	0	23755	706.5	23.1
					23790	710	23.2
					23825	713.5	23.0
			12	6	23755	706.5	23.0
					23790	710	23.2
					23825	713.5	23.1
			1	0	23755	706.5	23.9
					23790	710	23.9
					23825	713.5	24.0
			1	24	23755	706.5	24.0
					23790	710	24.0
					23825	713.5	23.8
		10 MHz	50	0	23780	709	22.9
					23790	710	22.9
					23800	711	23.1
			25	12	23780	709	23.0
					23790	710	23.0
					23800	711	23.0
			1	0	23780	709	23.9
					23790	710	23.9
					23800	711	24.0
			1	24	23780	709	24.0
					23790	710	23.8
					23800	711	24.0

Band	Modulation	Bandwidth	RB Size	RB Offset	Channel	Frequency	Power
25	QPSK	1.4 MHz	6	0	26047	1850.7	23.2
					26365	1882.5	23.1
					26683	1914.3	23.0
			3	1	26047	1850.7	24.0
					26365	1882.5	24.0
					26683	1914.3	23.8
			1	0	26047	1850.7	24.0
					26365	1882.5	24.0
					26683	1914.3	23.9
			1	5	26047	1850.7	24.0
					26365	1882.5	24.0
					26683	1914.3	23.8
		3 MHz	15	0	26055	1851.5	23.1
					26365	1882.5	23.1
					26675	1913.5	22.9
			8	3	26055	1851.5	23.4
					26365	1882.5	23.3
					26675	1913.5	23.2
			1	0	26055	1851.5	24.0
					26365	1882.5	24.0
					26675	1913.5	23.9
			1	14	26055	1851.5	24.0
					26365	1882.5	24.0
					26675	1913.5	23.9
		5 MHz	25	0	26065	1852.5	23.1
					26365	1882.5	23.0
					26665	1912.5	22.9
			12	6	26065	1852.5	23.2
					26365	1882.5	23.0
					26665	1907.5	23.1
			1	0	26065	1852.5	24.0
					26365	1882.5	24.0
					26665	1907.5	24.0
			1	24	26065	1852.5	24.0
					26365	1882.5	24.0
					26665	1907.5	23.8

Band	Modulation	Bandwidth	RB Size	RB Offset	Channel	Frequency	Power
25	QPSK	10 MHz	50	0	26090	1855	23.2
					26365	1882.5	23.0
					26640	1910	23.0
			25	12	26090	1855	23.2
					26365	1882.5	23.0
					26640	1910	23.1
			1	0	26090	1855	24.0
					26365	1882.5	24.0
					26640	1910	24.0
			1	24	26090	1855	24.0
					26365	1882.5	24.0
					26640	1910	23.9
		15 MHz	75	0	26115	1857.5	23.2
					26365	1882.5	23.0
					26615	1907.5	23.1
			36	19	26115	1857.5	23.2
					26365	1882.5	23.0
					26615	1907.5	23.0
			1	0	26115	1857.5	24.0
					26365	1882.5	24.0
					26615	1907.5	24.0
			1	74	26115	1857.5	24.0
					26365	1882.5	24.0
					26615	1907.5	23.8
		20 MHz	100	0	26140	1860	23.0
					26365	1882.5	23.0
					26590	1905	23.2
			50	25	26140	1860	22.9
					26365	1882.5	23.0
					26590	1905	23.1
			1	0	26140	1860	24.0
					26365	1882.5	24.0
					26590	1905	24.0
			1	99	26140	1860	24.0
					26365	1882.5	24.0
					26590	1905	23.9

Band	Modulation	Bandwidth	RB Size	RB Offset	Channel	Frequency	Power
25	16QAM	1.4 MHz	6	0	26047	1850.7	22.1
					26365	1882.5	21.9
					26683	1914.3	22.0
			3	1	26047	1850.7	23.0
					26365	1882.5	22.9
					26683	1914.3	23.0
			1	0	26047	1850.7	23.2
					26365	1882.5	23.3
					26683	1914.3	23.1
			1	5	26047	1850.7	23.0
					26365	1882.5	22.9
					26683	1914.3	23.0
		3 MHz	15	0	26055	1851.5	22.2
					26365	1882.5	22.0
					26675	1913.5	22.2
			8	3	26055	1851.5	22.2
					26365	1882.5	21.9
					26675	1913.5	22.1
			1	0	26055	1851.5	23.2
					26365	1882.5	23.3
					26675	1913.5	23.1
			1	14	26055	1851.5	23.0
					26365	1882.5	23.2
					26675	1913.5	23.1
		5 MHz	25	0	26065	1852.5	22.3
					26365	1882.5	22.2
					26665	1912.5	22.2
			12	6	26065	1852.5	22.0
					26365	1882.5	22.0
					26665	1907.5	22.2
			1	0	26065	1852.5	23.1
					26365	1882.5	23.0
					26665	1907.5	23.0
			1	24	26065	1852.5	22.9
					26365	1882.5	23.1
					26665	1907.5	23.0

Band	Modulation	Bandwidth	RB Size	RB Offset	Channel	Frequency	Power
25	16QAM	10 MHz	50	0	26090	1855	22.2
					26365	1882.5	22.3
					26640	1910	22.1
			25	12	26090	1855	22.3
					26365	1882.5	22.2
					26640	1910	22.1
			1	0	26090	1855	23.1
					26365	1882.5	23.3
					26640	1910	23.2
		1	24	26090	1855	23.2	
				26365	1882.5	23.0	
				26640	1910	23.0	
		15 MHz	75	0	26115	1857.5	22.0
					26365	1882.5	22.1
					26615	1907.5	21.9
			36	19	26115	1857.5	22.1
					26365	1882.5	22.1
					26615	1907.5	21.9
			1	0	26115	1857.5	23.2
					26365	1882.5	23.3
					26615	1907.5	23.3
		1	74	26115	1857.5	23.1	
				26365	1882.5	23.2	
				26615	1907.5	23.0	
		20 MHz	100	0	26140	1860	22.1
					26365	1882.5	22.0
					26590	1905	21.9
			50	25	26140	1860	22.1
					26365	1882.5	22.2
					26590	1905	22.1
			1	0	26140	1860	23.3
					26365	1882.5	23.3
					26590	1905	23.2
1	99	26140	1860	23.1			
		26365	1882.5	23.2			
		26590	1905	23.0			

SAR Data Summary –LTE Band 17

MEASUREMENT RESULTS

Gap	Plot	Position/ Antenna	Frequency		BW/ Modulation	RB Size	RB Offset	MPR Target	End Power (dBm)	Measured SAR (W/kg)	Reported SAR (W/kg)
			MHz	Ch.							
10 mm	-----	End/T1	710	23790	10 MHz/QPSK	1	24	0	24.0	0.102	0.10
	-----	End/T1	710	23790	10 MHz/QPSK	25	12	1	23.0	0.0987	0.10
	-----	End/T2	710	23790	10 MHz/QPSK	1	24	0	24.0	0.106	0.11
	-----	End/T2	710	23790	10 MHz/QPSK	25	12	1	23.0	0.0893	0.09
	-----	End/T3	710	23790	10 MHz/QPSK	1	24	0	24.0	0.103	0.10
	-----	End/T3	710	23790	10 MHz/QPSK	25	12	1	23.0	0.0863	0.09
	-----	End/T4	710	23790	10 MHz/QPSK	1	24	0	24.0	0.102	0.10
	-----	End/T4	710	23790	10 MHz/QPSK	25	12	1	23.0	0.0915	0.09
	-----	End/B1	710	23790	10 MHz/QPSK	1	24	0	24.0	0.108	0.11
	-----	End/B1	710	23790	10 MHz/QPSK	25	12	1	23.0	0.0856	0.09
	-----	End/B2	710	23790	10 MHz/QPSK	1	24	0	24.0	0.107	0.11
	-----	End/B2	710	23790	10 MHz/QPSK	25	12	1	23.0	0.0936	0.09
	-----	End/B3	710	23790	10 MHz/QPSK	1	24	0	24.0	0.105	0.11
	-----	End/B3	710	23790	10 MHz/QPSK	25	12	1	23.0	0.0865	0.09
	-----	End/B4	710	23790	10 MHz/QPSK	1	24	0	24.0	0.104	0.10
	-----	End/B4	710	23790	10 MHz/QPSK	25	12	1	23.0	0.0769	0.08
	-----	Short/T1	710	23790	10 MHz/QPSK	1	24	0	24.0	0.113	0.11
	-----	Short/T1	710	23790	10 MHz/QPSK	25	12	1	23.0	0.0924	0.09
	-----	Short/T2	710	23790	10 MHz/QPSK	1	24	0	24.0	0.111	0.11
	-----	Short/T2	710	23790	10 MHz/QPSK	25	12	1	23.0	0.0987	0.10
	-----	Short/T3	710	23790	10 MHz/QPSK	1	24	0	24.0	0.116	0.12
	-----	Short/T3	710	23790	10 MHz/QPSK	25	12	1	23.0	0.0859	0.09
	-----	Short/T4	710	23790	10 MHz/QPSK	1	24	0	24.0	0.109	0.11
	-----	Short/T4	710	23790	10 MHz/QPSK	25	12	1	23.0	0.0778	0.08
	-----	Short/B1	710	23790	10 MHz/QPSK	1	24	0	24.0	0.112	0.11
	-----	Short/B1	710	23790	10 MHz/QPSK	25	12	1	23.0	0.0839	0.08
	-----	Short/B2	710	23790	10 MHz/QPSK	1	24	0	24.0	0.114	0.11
	-----	Short/B2	710	23790	10 MHz/QPSK	25	12	1	23.0	0.0942	0.09
	-----	Short/B3	710	23790	10 MHz/QPSK	1	24	0	24.0	0.118	0.12
	-----	Short/B3	710	23790	10 MHz/QPSK	25	12	1	23.0	0.0856	0.09
	-----	Short/B4	710	23790	10 MHz/QPSK	1	24	0	24.0	0.116	0.12
	-----	Short/B4	710	23790	10 MHz/QPSK	25	12	1	23.0	0.0921	0.09
	1	Long/T1	710	23790	10 MHz/QPSK	1	24	0	24.0	0.152	0.15
	-----	Long/T1	710	23790	10 MHz/QPSK	25	12	1	23.0	0.120	0.12
	-----	Long/T2	710	23790	10 MHz/QPSK	1	24	0	24.0	0.143	0.14
	-----	Long/T2	710	23790	10 MHz/QPSK	25	12	1	23.0	0.116	0.12
	-----	Long/T3	710	23790	10 MHz/QPSK	1	24	0	24.0	0.146	0.15
	-----	Long/T3	710	23790	10 MHz/QPSK	25	12	1	23.0	0.118	0.12
	-----	Long/T4	710	23790	10 MHz/QPSK	1	24	0	24.0	0.145	0.15
	-----	Long/T4	710	23790	10 MHz/QPSK	25	12	1	23.0	0.121	0.12
-----	Long/B1	710	23790	10 MHz/QPSK	1	24	0	24.0	0.139	0.14	
-----	Long/B1	710	23790	10 MHz/QPSK	25	12	1	23.0	0.113	0.11	
-----	Long/B2	710	23790	10 MHz/QPSK	1	24	0	24.0	0.147	0.15	
-----	Long/B2	710	23790	10 MHz/QPSK	25	12	1	23.0	0.119	0.12	
-----	Long/B3	710	23790	10 MHz/QPSK	1	24	0	24.0	0.138	0.14	
-----	Long/B3	710	23790	10 MHz/QPSK	25	12	1	23.0	0.108	0.11	
-----	Long/B4	710	23790	10 MHz/QPSK	1	24	0	24.0	0.148	0.15	
-----	Long/B4	710	23790	10 MHz/QPSK	25	12	1	23.0	0.120	0.12	

Body
1.6 W/kg (mW/g)
averaged over 1 gram

- | | | | |
|-------------------------------------|---|--|---|
| 1. SAR Measurement | <input type="checkbox"/> Left Head | <input checked="" type="checkbox"/> Eli4 | <input type="checkbox"/> Right Head |
| Phantom Configuration | <input type="checkbox"/> Head | <input checked="" type="checkbox"/> Body | |
| SAR Configuration | <input type="checkbox"/> Test Code | <input checked="" type="checkbox"/> Base Station Simulator | |
| 2. Test Signal Call Mode | <input type="checkbox"/> With Belt Clip | <input type="checkbox"/> Without Belt Clip | <input checked="" type="checkbox"/> N/A |
| 3. Test Configuration | | | |
| 4. Tissue Depth is at least 15.0 cm | | | |



Jay M. Moulton
Vice President

SAR Data Summary –LTE Band 13

MEASUREMENT RESULTS

Gap	Plot	Position/ Antenna	Frequency		BW/ Modulation	RB Size	RB Offset	MPR Target	End Power (dBm)	Measured SAR (W/kg)	Reported SAR (W/kg)
			MHz	Ch.							
10 mm	-----	End/T1	782	23230	10 MHz/QPSK	1	24	0	24.0	0.132	0.13
	-----	End/T1	782	23230	10 MHz/QPSK	25	12	1	23.0	0.104	0.10
	-----	End/T2	782	23230	10 MHz/QPSK	1	24	0	24.0	0.132	0.13
	-----	End/T2	782	23230	10 MHz/QPSK	25	12	1	23.0	0.104	0.10
	-----	End/T3	782	23230	10 MHz/QPSK	1	24	0	24.0	0.132	0.13
	-----	End/T3	782	23230	10 MHz/QPSK	25	12	1	23.0	0.103	0.10
	-----	End/T4	782	23230	10 MHz/QPSK	1	24	0	24.0	0.132	0.13
	-----	End/T4	782	23230	10 MHz/QPSK	25	12	1	23.0	0.104	0.10
	-----	End/B1	782	23230	10 MHz/QPSK	1	24	0	24.0	0.132	0.13
	-----	End/B1	782	23230	10 MHz/QPSK	25	12	1	23.0	0.103	0.10
	-----	End/B2	782	23230	10 MHz/QPSK	1	24	0	24.0	0.131	0.13
	-----	End/B2	782	23230	10 MHz/QPSK	25	12	1	23.0	0.104	0.10
	-----	End/B3	782	23230	10 MHz/QPSK	1	24	0	24.0	0.132	0.13
	-----	End/B3	782	23230	10 MHz/QPSK	25	12	1	23.0	0.104	0.10
	-----	End/B4	782	23230	10 MHz/QPSK	1	24	0	24.0	0.132	0.13
	-----	End/B4	782	23230	10 MHz/QPSK	25	12	1	23.0	0.104	0.10
	-----	Short/T1	782	23230	10 MHz/QPSK	1	24	0	24.0	0.280	0.28
	-----	Short/T1	782	23230	10 MHz/QPSK	25	12	1	23.0	0.232	0.23
	-----	Short/T2	782	23230	10 MHz/QPSK	1	24	0	24.0	0.280	0.28
	-----	Short/T2	782	23230	10 MHz/QPSK	25	12	1	23.0	0.231	0.23
	-----	Short/T3	782	23230	10 MHz/QPSK	1	24	0	24.0	0.279	0.28
	-----	Short/T3	782	23230	10 MHz/QPSK	25	12	1	23.0	0.231	0.23
	-----	Short/T4	782	23230	10 MHz/QPSK	1	24	0	24.0	0.281	0.28
	-----	Short/T4	782	23230	10 MHz/QPSK	25	12	1	23.0	0.230	0.23
	-----	Short/B1	782	23230	10 MHz/QPSK	1	24	0	24.0	0.276	0.28
	-----	Short/B1	782	23230	10 MHz/QPSK	25	12	1	23.0	0.229	0.23
	-----	Short/B2	782	23230	10 MHz/QPSK	1	24	0	24.0	0.280	0.28
	-----	Short/B2	782	23230	10 MHz/QPSK	25	12	1	23.0	0.231	0.23
	-----	Short/B3	782	23230	10 MHz/QPSK	1	24	0	24.0	0.279	0.28
	-----	Short/B3	782	23230	10 MHz/QPSK	25	12	1	23.0	0.229	0.23
	-----	Short/B4	782	23230	10 MHz/QPSK	1	24	0	24.0	0.281	0.28
	-----	Short/B4	782	23230	10 MHz/QPSK	25	12	1	23.0	0.232	0.23
	2	Long/T1	782	23230	10 MHz/QPSK	1	24	0	24.0	0.249	0.25
	-----	Long/T1	782	23230	10 MHz/QPSK	25	12	1	23.0	0.197	0.20
	-----	Long/T2	782	23230	10 MHz/QPSK	1	24	0	24.0	0.245	0.25
	-----	Long/T2	782	23230	10 MHz/QPSK	25	12	1	23.0	0.198	0.20
	-----	Long/T3	782	23230	10 MHz/QPSK	1	24	0	24.0	0.248	0.25
	-----	Long/T3	782	23230	10 MHz/QPSK	25	12	1	23.0	0.196	0.20
	-----	Long/T4	782	23230	10 MHz/QPSK	1	24	0	24.0	0.246	0.25
	-----	Long/T4	782	23230	10 MHz/QPSK	25	12	1	23.0	0.191	0.19
-----	Long/B1	782	23230	10 MHz/QPSK	1	24	0	24.0	0.247	0.25	
-----	Long/B1	782	23230	10 MHz/QPSK	25	12	1	23.0	0.193	0.19	
-----	Long/B2	782	23230	10 MHz/QPSK	1	24	0	24.0	0.245	0.25	
-----	Long/B2	782	23230	10 MHz/QPSK	25	12	1	23.0	0.194	0.19	
-----	Long/B3	782	23230	10 MHz/QPSK	1	24	0	24.0	0.247	0.25	
-----	Long/B3	782	23230	10 MHz/QPSK	25	12	1	23.0	0.193	0.19	
-----	Long/B4	782	23230	10 MHz/QPSK	1	24	0	24.0	0.242	0.24	
-----	Long/B4	782	23230	10 MHz/QPSK	25	12	1	23.0	0.192	0.19	

Body
1.6 W/kg (mW/g)
averaged over 1 gram

- 1. SAR Measurement
 - Phantom Configuration
 - SAR Configuration
 - 2. Test Signal Call Mode
 - Test Code
 - 3. Test Configuration
 - With Belt Clip
 - 4. Tissue Depth is at least 15.0 cm
- Left Head
 - Head
 - Eli4
 - Body
 - Right Head
 - Base Station Simulator
 - Without Belt Clip
 - N/A



Jay M. Moulton
Vice President

SAR Data Summary – 835 MHz Body – CDMA BC0

MEASUREMENT RESULTS

Gap	Plot	Frequency		Modulation	Position/ Antenna	End Power (dBm)	Reverse Channel	Forward Channel	Measured SAR (W/kg)	Reported SAR (W/kg)	
		MHz	Ch.								
10 mm	----	836.52	384	CDMA	End/T1	24.49	153.6 kbps	2 Slot 307.2 kbps	0.174	0.17	
	----	836.52	384		End/T2	24.49	153.6 kbps	2 Slot 307.2 kbps	0.175	0.18	
	----	836.52	384		End/T3	24.49	153.6 kbps	2 Slot 307.2 kbps	0.174	0.17	
	----	836.52	384		End/T4	24.49	153.6 kbps	2 Slot 307.2 kbps	0.174	0.17	
	----	836.52	384		End/B1	24.49	153.6 kbps	2 Slot 307.2 kbps	0.175	0.18	
	----	836.52	384		End/B2	24.49	153.6 kbps	2 Slot 307.2 kbps	0.174	0.17	
	----	836.52	384		End/B3	24.49	153.6 kbps	2 Slot 307.2 kbps	0.175	0.18	
	----	836.52	384		End/B4	24.49	153.6 kbps	2 Slot 307.2 kbps	0.175	0.18	
	----	836.52	384		Short/T1	24.49	153.6 kbps	2 Slot 307.2 kbps	0.411	0.41	
	----	836.52	384		Short/T2	24.49	153.6 kbps	2 Slot 307.2 kbps	0.412	0.41	
	----	836.52	384		Short/T3	24.49	153.6 kbps	2 Slot 307.2 kbps	0.410	0.41	
	----	836.52	384		Short/T4	24.49	153.6 kbps	2 Slot 307.2 kbps	0.409	0.41	
	----	836.52	384		Short/B1	24.49	153.6 kbps	2 Slot 307.2 kbps	0.410	0.41	
	----	836.52	384		Short/B2	24.49	153.6 kbps	2 Slot 307.2 kbps	0.409	0.41	
	----	836.52	384		Short/B3	24.49	153.6 kbps	2 Slot 307.2 kbps	0.409	0.41	
	----	836.52	384		Short/B4	24.49	153.6 kbps	2 Slot 307.2 kbps	0.410	0.41	
	3	----	836.52		384	Long/T1	24.49	153.6 kbps	2 Slot 307.2 kbps	0.430	0.43
	----	836.52	384		Long/T2	24.49	153.6 kbps	2 Slot 307.2 kbps	0.427	0.43	
	----	836.52	384		Long/T3	24.49	153.6 kbps	2 Slot 307.2 kbps	0.427	0.43	
	----	836.52	384		Long/T4	24.49	153.6 kbps	2 Slot 307.2 kbps	0.428	0.43	
----	836.52	384	Long/B1	24.49	153.6 kbps	2 Slot 307.2 kbps	0.426	0.43			
----	836.52	384	Long/B2	24.49	153.6 kbps	2 Slot 307.2 kbps	0.425	0.43			
----	836.52	384	Long/B3	24.49	153.6 kbps	2 Slot 307.2 kbps	0.425	0.43			
----	836.52	384	Long/B4	24.49	153.6 kbps	2 Slot 307.2 kbps	0.425	0.43			

Body
1.6 W/kg (mW/g)
averaged over 1 gram

1. SAR Measurement
 Phantom Configuration Left Head Eli4 Right Head
 Head Body
2. Test Signal Call Mode Test Code Base Station Simulator
3. Test Configuration With Belt Clip Without Belt Clip N/A
4. Tissue Depth is at least 15.0 cm

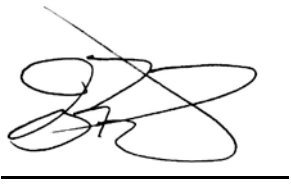

Jay M. Moulton
Vice President

SAR Data Summary – 850 MHz Body – UMTS Band 5

MEASUREMENT RESULTS

Gap	Plot	Frequency		Modulation	Position/ Antenna	End Power (dBm)	RMC	Test Set Up	Measured SAR (W/kg)	Reported SAR (W/kg)
		MHz	Ch.							
10 mm	----	836.6	4183	WCDMA	End/T1	23.91	12.2 kbps	Test Loop 1	0.137	0.14
	----	836.6	4183		End/T2	23.91	12.2 kbps	Test Loop 1	0.139	0.14
	----	836.6	4183		End/T3	23.91	12.2 kbps	Test Loop 1	0.140	0.14
	----	836.6	4183		End/T4	23.91	12.2 kbps	Test Loop 1	0.139	0.14
	----	836.6	4183		End/B1	23.91	12.2 kbps	Test Loop 1	0.139	0.14
	----	836.6	4183		End/B2	23.91	12.2 kbps	Test Loop 1	0.139	0.14
	----	836.6	4183		End/B3	23.91	12.2 kbps	Test Loop 1	0.139	0.14
	----	836.6	4183		End/B4	23.91	12.2 kbps	Test Loop 1	0.139	0.14
	----	836.6	4183		Short/T1	23.91	12.2 kbps	Test Loop 1	0.347	0.35
	----	836.6	4183		Short/T2	23.91	12.2 kbps	Test Loop 1	0.348	0.36
	----	836.6	4183		Short/T3	23.91	12.2 kbps	Test Loop 1	0.348	0.36
	----	836.6	4183		Short/T4	23.91	12.2 kbps	Test Loop 1	0.348	0.36
	----	836.6	4183		Short/B1	23.91	12.2 kbps	Test Loop 1	0.347	0.35
	----	836.6	4183		Short/B2	23.91	12.2 kbps	Test Loop 1	0.346	0.35
	----	836.6	4183		Short/B3	23.91	12.2 kbps	Test Loop 1	0.346	0.35
	----	836.6	4183		Short/B4	23.91	12.2 kbps	Test Loop 1	0.346	0.35
	----	836.6	4183		Long/T1	23.91	12.2 kbps	Test Loop 1	0.403	0.41
	----	836.6	4183		Long/T2	23.91	12.2 kbps	Test Loop 1	0.404	0.41
	----	836.6	4183		Long/T3	23.91	12.2 kbps	Test Loop 1	0.406	0.42
	4	----	836.6		4183	Long/T4	23.91	12.2 kbps	Test Loop 1	0.415
----	836.6	4183	Long/B1	23.91	12.2 kbps	Test Loop 1	0.412	0.42		
----	836.6	4183	Long/B2	23.91	12.2 kbps	Test Loop 1	0.409	0.42		
----	836.6	4183	Long/B3	23.91	12.2 kbps	Test Loop 1	0.411	0.42		
----	836.6	4183	Long/B4	23.91	12.2 kbps	Test Loop 1	0.411	0.42		

Body
1.6 W/kg (mW/g)
 averaged over 1 gram

1. SAR Measurement

Phantom Configuration

SAR Configuration

2. Test Signal Call Mode

3. Test Configuration

4. Tissue Depth is at least 15.0 cm

Left Head

Head

Test Code

With Belt Clip

Eli4

Body

Base Station Simulator

Without Belt Clip N/A

Right Head



Jay M. Moulton
 Vice President

SAR Data Summary –LTE Band 5

MEASUREMENT RESULTS

Gap	Plot	Position/ Antenna	Frequency		BW/ Modulation	RB Size	RB Offset	MPR Target	End Power (dBm)	Measured SAR (W/kg)	Reported SAR (W/kg)
			MHz	Ch.							
10 mm	-----	End/T1	836.5	20525	10 MHz/QPSK	1	24	0	24.0	0.111	0.11
	-----	End/T1	836.5	20525	10 MHz/QPSK	25	12	1	23.0	0.0841	0.08
	-----	End/T2	836.5	20525	10 MHz/QPSK	1	24	0	24.0	0.111	0.11
	-----	End/T2	836.5	20525	10 MHz/QPSK	25	12	1	23.0	0.0842	0.08
	-----	End/T3	836.5	20525	10 MHz/QPSK	1	24	0	24.0	0.111	0.11
	-----	End/T3	836.5	20525	10 MHz/QPSK	25	12	1	23.0	0.0851	0.09
	-----	End/T4	836.5	20525	10 MHz/QPSK	1	24	0	24.0	0.111	0.11
	-----	End/T4	836.5	20525	10 MHz/QPSK	25	12	1	23.0	0.0849	0.08
	-----	End/B1	836.5	20525	10 MHz/QPSK	1	24	0	24.0	0.110	0.11
	-----	End/B1	836.5	20525	10 MHz/QPSK	25	12	1	23.0	0.0849	0.08
	-----	End/B2	836.5	20525	10 MHz/QPSK	1	24	0	24.0	0.111	0.11
	-----	End/B2	836.5	20525	10 MHz/QPSK	25	12	1	23.0	0.0884	0.09
	-----	End/B3	836.5	20525	10 MHz/QPSK	1	24	0	24.0	0.110	0.11
	-----	End/B3	836.5	20525	10 MHz/QPSK	25	12	1	23.0	0.085	0.09
	-----	End/B4	836.5	20525	10 MHz/QPSK	1	24	0	24.0	0.110	0.11
	-----	End/B4	836.5	20525	10 MHz/QPSK	25	12	1	23.0	0.0849	0.08
	-----	Short/T1	836.5	20525	10 MHz/QPSK	1	24	0	24.0	0.330	0.33
	-----	Short/T1	836.5	20525	10 MHz/QPSK	25	12	1	23.0	0.253	0.25
	-----	Short/T2	836.5	20525	10 MHz/QPSK	1	24	0	24.0	0.330	0.33
	-----	Short/T2	836.5	20525	10 MHz/QPSK	25	12	1	23.0	0.253	0.25
	-----	Short/T3	836.5	20525	10 MHz/QPSK	1	24	0	24.0	0.330	0.33
	-----	Short/T3	836.5	20525	10 MHz/QPSK	25	12	1	23.0	0.253	0.25
	-----	Short/T4	836.5	20525	10 MHz/QPSK	1	24	0	24.0	0.330	0.33
	-----	Short/T4	836.5	20525	10 MHz/QPSK	25	12	1	23.0	0.253	0.25
	-----	Short/B1	836.5	20525	10 MHz/QPSK	1	24	0	24.0	0.329	0.33
	-----	Short/B1	836.5	20525	10 MHz/QPSK	25	12	1	23.0	0.252	0.25
	-----	Short/B2	836.5	20525	10 MHz/QPSK	1	24	0	24.0	0.328	0.33
	-----	Short/B2	836.5	20525	10 MHz/QPSK	25	12	1	23.0	0.253	0.25
	-----	Short/B3	836.5	20525	10 MHz/QPSK	1	24	0	24.0	0.328	0.33
	-----	Short/B3	836.5	20525	10 MHz/QPSK	25	12	1	23.0	0.252	0.25
	-----	Short/B4	836.5	20525	10 MHz/QPSK	1	24	0	24.0	0.328	0.33
	-----	Short/B4	836.5	20525	10 MHz/QPSK	25	12	1	23.0	0.251	0.25
	-----	Long/T1	836.5	20525	10 MHz/QPSK	1	24	0	24.0	0.316	0.32
	-----	Long/T1	836.5	20525	10 MHz/QPSK	25	12	1	23.0	0.257	0.26
	-----	Long/T2	836.5	20525	10 MHz/QPSK	1	24	0	24.0	0.317	0.32
	-----	Long/T2	836.5	20525	10 MHz/QPSK	25	12	1	23.0	0.256	0.26
	-----	Long/T3	836.5	20525	10 MHz/QPSK	1	24	0	24.0	0.315	0.32
	-----	Long/T3	836.5	20525	10 MHz/QPSK	25	12	1	23.0	0.257	0.25
	-----	Long/T4	836.5	20525	10 MHz/QPSK	1	24	0	24.0	0.328	0.33
	-----	Long/T4	836.5	20525	10 MHz/QPSK	25	12	1	23.0	0.256	0.26
-----	Long/B1	836.5	20525	10 MHz/QPSK	1	24	0	24.0	0.319	0.32	
-----	Long/B1	836.5	20525	10 MHz/QPSK	25	12	1	23.0	0.255	0.26	
-----	Long/B2	836.5	20525	10 MHz/QPSK	1	24	0	24.0	0.320	0.32	
-----	Long/B2	836.5	20525	10 MHz/QPSK	25	12	1	23.0	0.256	0.26	
-----	Long/B3	836.5	20525	10 MHz/QPSK	1	24	0	24.0	0.320	0.32	
-----	Long/B3	836.5	20525	10 MHz/QPSK	25	12	1	23.0	0.256	0.26	
5	-----	Long/B4	836.5	20525	10 MHz/QPSK	1	24	0	24.0	0.330	0.33
-----	-----	Long/B4	836.5	20525	10 MHz/QPSK	25	12	1	23.0	0.256	0.26

Body
1.6 W/kg (mW/g)
averaged over 1 gram

- 1. SAR Measurement Phantom Configuration Left Head Eli4 Right Head
- SAR Configuration Head Body
- 2. Test Signal Call Mode Test Code Base Station Simulator
- 3. Test Configuration With Belt Clip Without Belt Clip N/A
- 4. Tissue Depth is at least 15.0 cm



Jay M. Moulton
Vice President

SAR Data Summary –LTE Band 4

MEASUREMENT RESULTS

Gap	Plot	Position/ Antenna	Frequency		BW/ Modulation	RB Size	RB Offset	MPR Target	End Power (dBm)	Measured SAR (W/kg)	Reported SAR (W/kg)
			MHz	Ch.							
10 mm	-----	End/T1	1732.5	20175	20 MHz/QPSK	1	49	0	24.0	0.194	0.19
	-----	End/T1	1732.5	20175	20 MHz/QPSK	50	24	1	23.0	0.144	0.14
	-----	End/T2	1732.5	20175	20 MHz/QPSK	1	49	0	24.0	0.192	0.19
	-----	End/T2	1732.5	20175	20 MHz/QPSK	50	24	1	23.0	0.140	0.14
	-----	End/T3	1732.5	20175	20 MHz/QPSK	1	49	0	24.0	0.189	0.19
	-----	End/T3	1732.5	20175	20 MHz/QPSK	50	24	1	23.0	0.142	0.14
	-----	End/T4	1732.5	20175	20 MHz/QPSK	1	49	0	24.0	0.193	0.19
	-----	End/T4	1732.5	20175	20 MHz/QPSK	50	24	1	23.0	0.144	0.14
	-----	End/B1	1732.5	20175	20 MHz/QPSK	1	49	0	24.0	0.187	0.19
	-----	End/B1	1732.5	20175	20 MHz/QPSK	50	24	1	23.0	0.139	0.14
	-----	End/B2	1732.5	20175	20 MHz/QPSK	1	49	0	24.0	0.188	0.19
	-----	End/B2	1732.5	20175	20 MHz/QPSK	50	24	1	23.0	0.142	0.14
	-----	End/B3	1732.5	20175	20 MHz/QPSK	1	49	0	24.0	0.192	0.19
	-----	End/B3	1732.5	20175	20 MHz/QPSK	50	24	1	23.0	0.144	0.14
	-----	End/B4	1732.5	20175	20 MHz/QPSK	1	49	0	24.0	0.191	0.19
	-----	End/B4	1732.5	20175	20 MHz/QPSK	50	24	1	23.0	0.140	0.14
	-----	Short/T1	1732.5	20175	20 MHz/QPSK	1	49	0	24.0	0.221	0.22
	-----	Short/T1	1732.5	20175	20 MHz/QPSK	50	24	1	23.0	0.164	0.16
	-----	Short/T2	1732.5	20175	20 MHz/QPSK	1	49	0	24.0	0.219	0.22
	-----	Short/T2	1732.5	20175	20 MHz/QPSK	50	24	1	23.0	0.165	0.17
	-----	Short/T3	1732.5	20175	20 MHz/QPSK	1	49	0	24.0	0.220	0.22
	-----	Short/T3	1732.5	20175	20 MHz/QPSK	50	24	1	23.0	0.163	0.16
	-----	Short/T4	1732.5	20175	20 MHz/QPSK	1	49	0	24.0	0.217	0.22
	-----	Short/T4	1732.5	20175	20 MHz/QPSK	50	24	1	23.0	0.168	0.17
	-----	Short/B1	1732.5	20175	20 MHz/QPSK	1	49	0	24.0	0.211	0.21
	-----	Short/B1	1732.5	20175	20 MHz/QPSK	50	24	1	23.0	0.159	0.16
	-----	Short/B2	1732.5	20175	20 MHz/QPSK	1	49	0	24.0	0.215	0.22
	-----	Short/B2	1732.5	20175	20 MHz/QPSK	50	24	1	23.0	0.162	0.16
	-----	Short/B3	1732.5	20175	20 MHz/QPSK	1	49	0	24.0	0.220	0.22
	-----	Short/B3	1732.5	20175	20 MHz/QPSK	50	24	1	23.0	0.165	0.17
	-----	Short/B4	1732.5	20175	20 MHz/QPSK	1	49	0	24.0	0.217	0.22
	-----	Short/B4	1732.5	20175	20 MHz/QPSK	50	24	1	23.0	0.166	0.17
	6	Long/T1	1732.5	20175	20 MHz/QPSK	1	49	0	24.0	0.485	0.49
	-----	Long/T1	1732.5	20175	20 MHz/QPSK	50	24	1	23.0	0.357	0.36
	-----	Long/T2	1732.5	20175	20 MHz/QPSK	1	49	0	24.0	0.479	0.48
	-----	Long/T2	1732.5	20175	20 MHz/QPSK	50	24	1	23.0	0.352	0.35
	-----	Long/T3	1732.5	20175	20 MHz/QPSK	1	49	0	24.0	0.481	0.48
	-----	Long/T3	1732.5	20175	20 MHz/QPSK	50	24	1	23.0	0.355	0.36
	-----	Long/T4	1732.5	20175	20 MHz/QPSK	1	49	0	24.0	0.483	0.48
	-----	Long/T4	1732.5	20175	20 MHz/QPSK	50	24	1	23.0	0.352	0.35
	-----	Long/B1	1732.5	20175	20 MHz/QPSK	1	49	0	24.0	0.478	0.48
	-----	Long/B1	1732.5	20175	20 MHz/QPSK	50	24	1	23.0	0.350	0.35
	-----	Long/B2	1732.5	20175	20 MHz/QPSK	1	49	0	24.0	0.480	0.48
	-----	Long/B2	1732.5	20175	20 MHz/QPSK	50	24	1	23.0	0.352	0.35
	-----	Long/B3	1732.5	20175	20 MHz/QPSK	1	49	0	24.0	0.476	0.48
	-----	Long/B3	1732.5	20175	20 MHz/QPSK	50	24	1	23.0	0.349	0.35
	-----	Long/B4	1732.5	20175	20 MHz/QPSK	1	49	0	24.0	0.482	0.48
	-----	Long/B4	1732.5	20175	20 MHz/QPSK	50	24	1	23.0	0.350	0.35

Body
1.6 W/kg (mW/g)
averaged over 1 gram

- 1. SAR Measurement
 - Phantom Configuration
 - SAR Configuration
 - 2. Test Signal Call Mode
 - Test Code
 - 3. Test Configuration
 - With Belt Clip
 - 4. Tissue Depth is at least 15.0 cm
- Left Head
 - Head
 - Eli4
 - Body
 - Right Head
 - Base Station Simulator
 - Without Belt Clip
 - N/A



Jay M. Moulton
Vice President

SAR Data Summary – 1750 MHz Body – UMTS Band 4

MEASUREMENT RESULTS

Gap	Plot	Frequency		Modulation	Position/ Antenna	End Power (dBm)	RMC	Test Set Up	Measured SAR (W/kg)	Reported SAR (W/kg)
		MHz	Ch.							
10 mm	----	1732.6	1413	WCDMA	End/T1	23.91	12.2 kbps	Test Loop 1	0.141	0.14
	----	1732.6	1413		End/T2	23.91	12.2 kbps	Test Loop 1	0.134	0.14
	----	1732.6	1413		End/T3	23.91	12.2 kbps	Test Loop 1	0.145	0.14
	----	1732.6	1413		End/T4	23.91	12.2 kbps	Test Loop 1	0.148	0.14
	----	1732.6	1413		End/B1	23.91	12.2 kbps	Test Loop 1	0.146	0.14
	----	1732.6	1413		End/B2	23.91	12.2 kbps	Test Loop 1	0.144	0.14
	----	1732.6	1413		End/B3	23.91	12.2 kbps	Test Loop 1	0.142	0.14
	----	1732.6	1413		End/B4	23.91	12.2 kbps	Test Loop 1	0.148	0.14
	----	1732.6	1413		Short/T1	23.91	12.2 kbps	Test Loop 1	0.352	0.35
	----	1732.6	1413		Short/T2	23.91	12.2 kbps	Test Loop 1	0.356	0.36
	----	1732.6	1413		Short/T3	23.91	12.2 kbps	Test Loop 1	0.355	0.36
	----	1732.6	1413		Short/T4	23.91	12.2 kbps	Test Loop 1	0.359	0.36
	----	1732.6	1413		Short/B1	23.91	12.2 kbps	Test Loop 1	0.352	0.35
	----	1732.6	1413		Short/B2	23.91	12.2 kbps	Test Loop 1	0.356	0.35
	----	1732.6	1413		Short/B3	23.91	12.2 kbps	Test Loop 1	0.352	0.35
	----	1732.6	1413		Short/B4	23.91	12.2 kbps	Test Loop 1	0.358	0.35
	----	1732.6	1413		Long/T1	23.91	12.2 kbps	Test Loop 1	0.405	0.41
	----	1732.6	1413		Long/T2	23.91	12.2 kbps	Test Loop 1	0.409	0.41
	----	1732.6	1413		Long/T3	23.91	12.2 kbps	Test Loop 1	0.411	0.42
	7	----	1732.6		1413	Long/T4	23.91	12.2 kbps	Test Loop 1	0.418
----	----	1732.6	1413	Long/B1	23.91	12.2 kbps	Test Loop 1	0.416	0.42	
----	----	1732.6	1413	Long/B2	23.91	12.2 kbps	Test Loop 1	0.410	0.42	
----	----	1732.6	1413	Long/B3	23.91	12.2 kbps	Test Loop 1	0.415	0.42	
----	----	1732.6	1413	Long/B4	23.91	12.2 kbps	Test Loop 1	0.414	0.42	

Body
1.6 W/kg (mW/g)
 averaged over 1 gram

- 1. SAR Measurement
 - Phantom Configuration Left Head Eli4 Right Head
 - SAR Configuration Head Body
- 2. Test Signal Call Mode Test Code Base Station Simulator
- 3. Test Configuration With Belt Clip Without Belt Clip N/A
- 4. Tissue Depth is at least 15.0 cm



Jay M. Moulton
 Vice President

SAR Data Summary – 1900 MHz Body – CDMA BC1

MEASUREMENT RESULTS

Gap	Plot	Frequency		Modulation	Position/ Antenna	End Power (dBm)	Reverse Channel	Forward Channel	Measured SAR (W/kg)	Reported SAR (W/kg)
		MHz	Ch.							
10 mm	----	1880.0	600	CDMA	End/T1	24.41	153.6 kbps	2 Slot 307.2 kbps	0.125	0.14
	----	1880.0	600		End/T2	24.41	153.6 kbps	2 Slot 307.2 kbps	0.188	0.22
	----	1880.0	600		End/T3	24.41	153.6 kbps	2 Slot 307.2 kbps	0.178	0.20
	----	1880.0	600		End/T4	24.41	153.6 kbps	2 Slot 307.2 kbps	0.109	0.13
	----	1880.0	600		End/B1	24.41	153.6 kbps	2 Slot 307.2 kbps	0.128	0.15
	----	1880.0	600		End/B2	24.41	153.6 kbps	2 Slot 307.2 kbps	0.263	0.30
	----	1880.0	600		End/B3	24.41	153.6 kbps	2 Slot 307.2 kbps	0.192	0.22
	----	1880.0	600		End/B4	24.41	153.6 kbps	2 Slot 307.2 kbps	0.158	0.18
	----	1880.0	600		Short/T1	24.41	153.6 kbps	2 Slot 307.2 kbps	0.262	0.30
	----	1880.0	600		Short/T2	24.41	153.6 kbps	2 Slot 307.2 kbps	0.145	0.17
	----	1880.0	600		Short/T3	24.41	153.6 kbps	2 Slot 307.2 kbps	0.117	0.13
	----	1880.0	600		Short/T4	24.41	153.6 kbps	2 Slot 307.2 kbps	0.100	0.12
	----	1880.0	600		Short/B1	24.41	153.6 kbps	2 Slot 307.2 kbps	0.161	0.18
	----	1880.0	600		Short/B2	24.41	153.6 kbps	2 Slot 307.2 kbps	0.164	0.19
	----	1880.0	600		Short/B3	24.41	153.6 kbps	2 Slot 307.2 kbps	0.249	0.29
	----	1880.0	600		Short/B4	24.41	153.6 kbps	2 Slot 307.2 kbps	0.149	0.17
	----	1880.0	600		Long/T1	24.41	153.6 kbps	2 Slot 307.2 kbps	0.479	0.55
	----	1880.0	600		Long/T2	24.41	153.6 kbps	2 Slot 307.2 kbps	0.477	0.55
	----	1880.0	600		Long/T3	24.41	153.6 kbps	2 Slot 307.2 kbps	0.423	0.49
	----	1880.0	600		Long/T4	24.41	153.6 kbps	2 Slot 307.2 kbps	0.406	0.47
----	1880.0	600	Long/B1	24.41	153.6 kbps	2 Slot 307.2 kbps	0.410	0.47		
----	1880.0	600	Long/B2	24.41	153.6 kbps	2 Slot 307.2 kbps	0.395	0.45		
8	1880.0	600	Long/B3	24.41	153.6 kbps	2 Slot 307.2 kbps	0.530	0.61		
----	1880.0	600	Long/B4	24.41	153.6 kbps	2 Slot 307.2 kbps	0.381	0.44		

Body
1.6 W/kg (mW/g)
 averaged over 1 gram

- 1. SAR Measurement
 - Phantom Configuration Left Head Eli4 Right Head
 - SAR Configuration Head Body
- 2. Test Signal Call Mode Test Code Base Station Simulator
- 3. Test Configuration With Belt Clip Without Belt Clip N/A
- 4. Tissue Depth is at least 15.0 cm



Jay M. Moulton
 Vice President

SAR Data Summary – 1900 MHz Body – UMTS Band 2

MEASUREMENT RESULTS

Gap	Plot	Frequency		Modulation	Position/ Antenna	End Power (dBm)	RMC	Test Set Up	Measured SAR (W/kg)	Reported SAR (W/kg)
		MHz	Ch.							
10 mm	----	1880.0	9400	WCDMA	End/T1	23.86	12.2 kbps	Test Loop 1	0.258	0.27
	----	1880.0	9400		End/T2	23.86	12.2 kbps	Test Loop 1	0.210	0.22
	----	1880.0	9400		End/T3	23.86	12.2 kbps	Test Loop 1	0.221	0.23
	----	1880.0	9400		End/T4	23.86	12.2 kbps	Test Loop 1	0.221	0.23
	----	1880.0	9400		End/B1	23.86	12.2 kbps	Test Loop 1	0.220	0.23
	----	1880.0	9400		End/B2	23.86	12.2 kbps	Test Loop 1	0.221	0.23
	----	1880.0	9400		End/B3	23.86	12.2 kbps	Test Loop 1	0.222	0.23
	----	1880.0	9400		End/B4	23.86	12.2 kbps	Test Loop 1	0.222	0.23
	----	1880.0	9400		Short/T1	23.86	12.2 kbps	Test Loop 1	0.356	0.37
	----	1880.0	9400		Short/T2	23.86	12.2 kbps	Test Loop 1	0.236	0.24
	----	1880.0	9400		Short/T3	23.86	12.2 kbps	Test Loop 1	0.203	0.21
	----	1880.0	9400		Short/T4	23.86	12.2 kbps	Test Loop 1	0.205	0.21
	----	1880.0	9400		Short/B1	23.86	12.2 kbps	Test Loop 1	0.205	0.21
	----	1880.0	9400		Short/B2	23.81	12.2 kbps	Test Loop 1	0.206	0.21
	----	1880.0	9400		Short/B3	23.86	12.2 kbps	Test Loop 1	0.205	0.21
	----	1880.0	9400		Short/B4	23.86	12.2 kbps	Test Loop 1	0.207	0.21
	----	1880.0	9400		Long/T1	23.86	12.2 kbps	Test Loop 1	0.380	0.39
	----	1880.0	9400		Long/T2	23.86	12.2 kbps	Test Loop 1	0.294	0.30
	----	1880.0	9400		Long/T3	23.86	12.2 kbps	Test Loop 1	0.413	0.43
	----	1880.0	9400		Long/T4	23.86	12.2 kbps	Test Loop 1	0.416	0.43
9	----	1880.0	9400	Long/B1	23.86	12.2 kbps	Test Loop 1	0.418	0.43	
----	1880.0	9400	Long/B2	23.86	12.2 kbps	Test Loop 1	0.409	0.42		
----	1880.0	9400	Long/B3	23.86	12.2 kbps	Test Loop 1	0.401	0.41		
----	1880.0	9400	Long/B4	23.86	12.2 kbps	Test Loop 1	0.404	0.42		

Body
1.6 W/kg (mW/g)
 averaged over 1 gram

- SAR Measurement
 Phantom Configuration Left Head Eli4 Right Head
 SAR Configuration Head Body
- Test Signal Call Mode Test Code Base Station Simulator
- Test Configuration With Belt Clip Without Belt Clip N/A
- Tissue Depth is at least 15.0 cm



Jay M. Moulton
 Vice President

SAR Data Summary –LTE Band 25

MEASUREMENT RESULTS

Gap	Plot	Position/ Antenna	Frequency		BW/ Modulation	RB Size	RB Offset	MPR Target	End Power (dBm)	Measured SAR (W/kg)	Reported SAR (W/kg)
			MHz	Ch.							
10 mm	-----	End/T1	1882.5	26365	20 MHz/QPSK	1	49	0	24.0	0.182	0.18
	-----	End/T1	1882.5	26365	20 MHz/QPSK	50	24	1	23.0	0.135	0.14
	-----	End/T2	1882.5	26365	20 MHz/QPSK	1	49	0	24.0	0.178	0.18
	-----	End/T2	1882.5	26365	20 MHz/QPSK	50	24	1	23.0	0.135	0.14
	-----	End/T3	1882.5	26365	20 MHz/QPSK	1	49	0	24.0	0.176	0.18
	-----	End/T3	1882.5	26365	20 MHz/QPSK	50	24	1	23.0	0.135	0.14
	-----	End/T4	1882.5	26365	20 MHz/QPSK	1	49	0	24.0	0.177	0.18
	-----	End/T4	1882.5	26365	20 MHz/QPSK	50	24	1	23.0	0.134	0.13
	-----	End/B1	1882.5	26365	20 MHz/QPSK	1	49	0	24.0	0.177	0.18
	-----	End/B1	1882.5	26365	20 MHz/QPSK	50	24	1	23.0	0.136	0.14
	-----	End/B2	1882.5	26365	20 MHz/QPSK	1	49	0	24.0	0.177	0.18
	-----	End/B2	1882.5	26365	20 MHz/QPSK	50	24	1	23.0	0.135	0.14
	-----	End/B3	1882.5	26365	20 MHz/QPSK	1	49	0	24.0	0.179	0.18
	-----	End/B3	1882.5	26365	20 MHz/QPSK	50	24	1	23.0	0.139	0.14
	-----	End/B4	1882.5	26365	20 MHz/QPSK	1	49	0	24.0	0.181	0.18
	-----	End/B4	1882.5	26365	20 MHz/QPSK	50	24	1	23.0	0.138	0.14
	-----	Short/T1	1882.5	26365	20 MHz/QPSK	1	49	0	24.0	0.170	0.17
	-----	Short/T1	1882.5	26365	20 MHz/QPSK	50	24	1	23.0	0.139	0.14
	-----	Short/T2	1882.5	26365	20 MHz/QPSK	1	49	0	24.0	0.168	0.17
	-----	Short/T2	1882.5	26365	20 MHz/QPSK	50	24	1	23.0	0.139	0.14
	-----	Short/T3	1882.5	26365	20 MHz/QPSK	1	49	0	24.0	0.167	0.17
	-----	Short/T3	1882.5	26365	20 MHz/QPSK	50	24	1	23.0	0.136	0.14
	-----	Short/T4	1882.5	26365	20 MHz/QPSK	1	49	0	24.0	0.168	0.17
	-----	Short/T4	1882.5	26365	20 MHz/QPSK	50	24	1	23.0	0.140	0.14
	-----	Short/B1	1882.5	26365	20 MHz/QPSK	1	49	0	24.0	0.168	0.17
	-----	Short/B1	1882.5	26365	20 MHz/QPSK	50	24	1	23.0	0.141	0.14
	-----	Short/B2	1882.5	26365	20 MHz/QPSK	1	49	0	24.0	0.169	0.17
	-----	Short/B2	1882.5	26365	20 MHz/QPSK	50	24	1	23.0	0.140	0.14
	-----	Short/B3	1882.5	26365	20 MHz/QPSK	1	49	0	24.0	0.168	0.17
	-----	Short/B3	1882.5	26365	20 MHz/QPSK	50	24	1	23.0	0.139	0.14
	-----	Short/B4	1882.5	26365	20 MHz/QPSK	1	49	0	24.0	0.169	0.17
	-----	Short/B4	1882.5	26365	20 MHz/QPSK	50	24	1	23.0	0.139	0.14
	-----	Long/T1	1882.5	26365	20 MHz/QPSK	1	49	0	24.0	0.330	0.33
	-----	Long/T1	1882.5	26365	20 MHz/QPSK	50	24	1	23.0	0.332	0.33
	-----	Long/T2	1882.5	26365	20 MHz/QPSK	1	49	0	24.0	0.326	0.33
	-----	Long/T2	1882.5	26365	20 MHz/QPSK	50	24	1	23.0	0.332	0.33
	-----	Long/T3	1882.5	26365	20 MHz/QPSK	1	49	0	24.0	0.325	0.33
	-----	Long/T3	1882.5	26365	20 MHz/QPSK	50	24	1	23.0	0.330	0.33
	-----	Long/T4	1882.5	26365	20 MHz/QPSK	1	49	0	24.0	0.318	0.32
	-----	Long/T4	1882.5	26365	20 MHz/QPSK	50	24	1	23.0	0.323	0.32
-----	Long/B1	1882.5	26365	20 MHz/QPSK	1	49	0	24.0	0.326	0.33	
-----	Long/B1	1882.5	26365	20 MHz/QPSK	50	24	1	23.0	0.329	0.33	
-----	Long/B2	1882.5	26365	20 MHz/QPSK	1	49	0	24.0	0.324	0.32	
-----	Long/B2	1882.5	26365	20 MHz/QPSK	50	24	1	23.0	0.329	0.33	
-----	Long/B3	1882.5	26365	20 MHz/QPSK	1	49	0	24.0	0.323	0.32	
-----	Long/B3	1882.5	26365	20 MHz/QPSK	50	24	1	23.0	0.328	0.33	
-----	10	Long/B4	1882.5	26365	20 MHz/QPSK	1	49	0	24.0	0.347	0.35
-----	-----	Long/B4	1882.5	26365	20 MHz/QPSK	50	24	1	23.0	0.293	0.29

Body
1.6 W/kg (mW/g)
averaged over 1 gram

- | | | | |
|-------------------------------------|---|--|---|
| 1. SAR Measurement | <input type="checkbox"/> Left Head | <input checked="" type="checkbox"/> Eli4 | <input type="checkbox"/> Right Head |
| Phantom Configuration | <input type="checkbox"/> Head | <input checked="" type="checkbox"/> Body | |
| 2. Test Signal Call Mode | <input type="checkbox"/> Test Code | <input checked="" type="checkbox"/> Base Station Simulator | |
| 3. Test Configuration | <input type="checkbox"/> With Belt Clip | <input type="checkbox"/> Without Belt Clip | <input checked="" type="checkbox"/> N/A |
| 4. Tissue Depth is at least 15.0 cm | | | |



Jay M. Moulton
Vice President

SAR Data Summary – Simultaneous Evaluation

The cellular antennas can transmit simultaneously with each other. The highest SAR value measured for each side was used to determine the separation ratio for each side. The closest distance for the end is 35 mm, for the short side is 35 mm and for the long side is 60 mm. Using the highest reported SAR to calculate the simultaneous Tx using peak separation ratio, the highest ratio would be 0.02 which meets the requirements of KDB 447498 section 4.3.2 3) on page 13. The calculation is shown below.

Simultaneous Separation Ratio Calculation

$(SAR_1 + SAR_2)^{1.5}/R_i \leq 0.04$ rounded to two digits

$(0.27 + 0.27)^{1.5}/35 = 0.01$, for the End

$(0.41 + 0.41)^{1.5}/35 = 0.02$, for the Short Side

$(0.61 + 0.61)^{1.5}/60 = 0.02$, for the Long Side

$(0.41 + 0.80)^{1.5}/64 = 0.02$, for the Short Side Cellular to WiFi

12. Test Equipment List

Table 12.1 Equipment Specifications

Type	Calibration Due Date	Calibration Done Date	Serial Number
Staubli Robot TX60L	N/A	N/A	F07/55M6A1/A/01
Measurement Controller CS8c	N/A	N/A	1012
ELI4 Flat Phantom	N/A	N/A	1251
Device Holder	N/A	N/A	N/A
Data Acquisition Electronics 4	08/12/2015	08/12/2014	759
SPEAG E-Field Probe EX3DV4	01/23/2016	01/23/2015	3833
Speag Validation Dipole D750V2	12/03/2015	12/03/2012	1016
Speag Validation Dipole D835V2	12/03/2015	12/03/2012	4d089
Speag Validation Dipole D1750V2	12/05/2015	12/05/2012	1018
Speag Validation Dipole D1900V2	12/06/2015	12/06/2012	5d116
Agilent N1911A Power Meter	03/24/2016	03/24/2015	GB45100254
Agilent N1922A Power Sensor	06/25/2015	06/25/2014	MY45240464
Advantest R3261A Spectrum Analyzer	03/26/2017	03/26/2015	31720068
Agilent (HP) 8350B Signal Generator	03/26/2017	03/26/2015	2749A10226
Agilent (HP) 83525A RF Plug-In	03/26/2017	03/26/2015	2647A01172
Agilent (HP) 8753C Vector Network Analyzer	03/26/2017	03/26/2015	3135A01724
Agilent (HP) 85047A S-Parameter Test Set	03/26/2017	03/26/2015	2904A00595
Agilent (HP) 8960 Base Station Sim.	03/31/2017	03/31/2015	MY48360364
Anritsu MT8820C	07/29/2015	07/29/2014	6201176199
Agilent 778D Dual Directional Coupler	N/A	N/A	MY48220184
MiniCircuits BW-N20W5+ Fixed 20 dB Attenuator	N/A	N/A	N/A
MiniCircuits SPL-10.7+ Low Pass Filter	N/A	N/A	R8979513746
Apriel Dielectric Probe Assembly	N/A	N/A	0011
Body Equivalent Matter (750 MHz)	N/A	N/A	N/A
Body Equivalent Matter (835/900 MHz)	N/A	N/A	N/A
Body Equivalent Matter (1750 MHz)	N/A	N/A	N/A
Body Equivalent Matter (1900 MHz)	N/A	N/A	N/A

13. Conclusion

The SAR measurement indicates that the EUT complies with the RF radiation exposure limits of the FCC/IC. These measurements are taken to simulate the RF effects exposure under worst-case conditions. Precise laboratory measures were taken to assure repeatability of the tests. The tested device complies with the requirements in respect to all parameters subject to the test. The test results and statements relate only to the item(s) tested.

Please note that the absorption and distribution of electromagnetic energy in the body is a very complex phenomena that depends on the mass, shape, and size of the body; the orientation of the body with respect to the field vectors; and, the electrical properties of both the body and the environment. Other variables that may play a substantial role in possible biological effects are those that characterize the environment (e.g. ambient temperature, air velocity, relative humidity, and body insulation) and those that characterize the individual (e.g. age, gender, activity level, debilitation, or disease). Because innumerable factors may interact to determine the specific biological outcome of an exposure to electromagnetic fields, any protection guide shall consider maximal amplification of biological effects as a result of field-body interactions, environmental conditions, and physiological variables.

14. References

- [1] Federal Communications Commission, ET Docket 93-62, Guidelines for Evaluating the Environmental Effects of Radio Frequency Radiation, August 1996
- [2] ANSI/IEEE C95.1 – 1992, American National Standard Safety Levels with respect to Human Exposure to Radio Frequency Electromagnetic Fields, 300kHz to 100GHz, New York: IEEE, 1992.
- [3] ANSI/IEEE C95.3 – 1992, IEEE Recommended Practice for the Measurement of Potentially Hazardous Electromagnetic Fields – RF and Microwave, New York: IEEE, 1992.
- [4] International Electrotechnical Commission, IEC 62209-2 (Edition 1.0), Human Exposure to radio frequency fields from hand-held and body mounted wireless communication devices – Human models, instrumentation, and procedures – Part 2: Procedure to determine the specific absorption rate (SAR) for wireless communication devices used in close proximity to the human body (frequency range of 30 MHz to 6 GHz), March 2010.
- [5] IEEE Standard 1528 – 2013, IEEE Recommended Practice for Determining the Peak-Spatial Average Specific Absorption Rate (SAR) in the Human Head from Wireless Communication Devices: Measurement Techniques, June 2013.
- [6] Industry Canada, RSS – 102 Issue 5, Radio Frequency Exposure Compliance of Radiocommunication Apparatus (All Frequency Bands), March 2015.
- [7] Health Canada, Safety Code 6, Limits of Human Exposure to Radiofrequency Electromagnetic Fields in the Frequency Range from 3kHz to 300 GHz, 2009.

Appendix A – System Validation Plots and Data

```
*****
Test Result for UIM Dielectric Parameter
Fri 22/May/2015
Freq  Frequency(GHz)
FCC_eH Limits for Head Epsilon
FCC_sH Limits for Head Sigma
FCC_eB Limits for Body Epsilon
FCC_sB Limits for Body Sigma
Test_e Epsilon of UIM
Test_s Sigma of UIM
*****
Freq      FCC_eB FCC_sB Test_e Test_s
0.7000    55.73  0.96   54.98  0.89
0.7100    55.69  0.96   54.92  0.90
0.7200    55.65  0.96   54.87  0.91
0.7300    55.61  0.96   54.81  0.92
0.7400    55.57  0.96   54.77  0.93
0.7500    55.53  0.96   54.69  0.94
0.7600    55.49  0.96   54.62  0.95
0.7700    55.45  0.96   54.58  0.96
0.7800    55.41  0.97   54.57  0.97
0.7820    55.404 0.97   54.556 0.972*
0.7900    55.38  0.97   54.50  0.98
0.8000    55.34  0.97   54.45  0.98
```

* value interpolated

```
*****
Test Result for UIM Dielectric Parameter
Thu 25/May/2015
Freq  Frequency(GHz)
FCC_eH Limits for Head Epsilon
FCC_sH Limits for Head Sigma
FCC_eB Limits for Body Epsilon
FCC_sB Limits for Body Sigma
Test_e Epsilon of UIM
Test_s Sigma of UIM
*****
Freq      FCC_eB FCC_sB Test_e Test_s
0.8050    55.32  0.97   54.24  0.94
0.8150    55.28  0.97   54.28  0.95
0.8250    55.24  0.97   54.33  0.96
0.8350    55.20  0.97   54.37  0.98
0.83652   55.196 0.972  54.375 0.982*
0.8366    55.195 0.972  54.375 0.982*
0.8450    55.17  0.98   54.40  0.99
0.8550    55.14  0.99   54.44  1.02
0.8650    55.11  1.01   54.48  1.04
```

* value interpolated

Test Result for UIM Dielectric Parameter

Sat 23/May/2015

Freq Frequency(GHz)

FCC_eH Limits for Head Epsilon

FCC_sH Limits for Head Sigma

FCC_eB Limits for Body Epsilon

FCC_sB Limits for Body Sigma

Test_e Epsilon of UIM

Test_s Sigma of UIM

Freq	FCC_eB	FCC_sB	Test_e	Test_s
1.6900	53.59	1.45	52.89	1.51
1.7000	53.56	1.46	52.85	1.52
1.7100	53.54	1.46	52.81	1.53
1.7200	53.51	1.47	52.78	1.54
1.7300	53.48	1.48	52.74	1.55
1.7325	53.475	1.48	52.73	1.55*
1.7400	53.46	1.48	52.70	1.55
1.7500	53.43	1.49	52.68	1.56
1.7600	53.41	1.49	52.66	1.56
1.7700	53.38	1.50	52.65	1.57
1.7800	53.35	1.51	52.61	1.58
1.7900	53.33	1.51	52.58	1.59

* value interpolated

Test Result for UIM Dielectric Parameter

Mon 18/May/2015

Freq Frequency(GHz)

FCC_eH Limits for Head Epsilon

FCC_sH Limits for Head Sigma

FCC_eB Limits for Body Epsilon

FCC_sB Limits for Body Sigma

Test_e Epsilon of UIM

Test_s Sigma of UIM

Freq	FCC_eB	FCC_sB	Test_e	Test_s
1.8500	53.30	1.52	53.27	1.49
1.8600	53.30	1.52	53.25	1.50
1.8700	53.30	1.52	53.23	1.51
1.8800	53.30	1.52	53.21	1.52
1.8825	53.30	1.52	53.205	1.523*
1.8900	53.30	1.52	53.19	1.53
1.9000	53.30	1.52	53.17	1.54
1.9100	53.30	1.52	53.15	1.55
1.9200	53.30	1.52	53.14	1.57
1.9300	53.30	1.52	53.12	1.58

* value interpolated

RF Exposure Lab

Plot 1

DUT: Dipole 750 MHz D750V3; Type: D750V3; Serial: D750V3 - SN:1016

Communication System: CW; Frequency: 750 MHz; Duty Cycle: 1:1
Medium: MSL750; Medium parameters used: $f = 750$ MHz; $\sigma = 0.94$ S/m; $\epsilon_r = 54.69$; $\rho = 1000$ kg/m³
Phantom section: Flat Section

Test Date: Date: 5/22/2015; Ambient Temp: 23 °C; Tissue Temp: 21 °C

Probe: EX3DV4 - SN3833; ConvF(8.75, 8.75, 8.75); Calibrated: 1/23/2015;
Sensor-Surface: 2mm (Mechanical Surface Detection)
Electronics: DAE4 Sn759; Calibrated: 8/12/2014
Phantom: ELI v4.0; Type: QDOVA001BB; Serial: 1251
Measurement SW: DASY52, Version 52.8 (7); SEMCAD X Version 14.6.10 (7164)

Procedure Notes:

750 MHz/Verification/Area Scan (5x11x1): Measurement grid: dx=15mm, dy=15mm
Maximum value of SAR (measured) = 1.08 W/kg

750 MHz/Verification/Zoom Scan (5x5x7)/Cube 0: Measurement grid: dx=8mm, dy=8mm, dz=5mm
Reference Value = 31.227 V/m; Power Drift = 0.02 dB
Peak SAR (extrapolated) = 1.30 W/kg
SAR(1 g) = 0.865 W/kg; SAR(10 g) = 0.569 W/kg
Maximum value of SAR (measured) = 1.10 W/kg

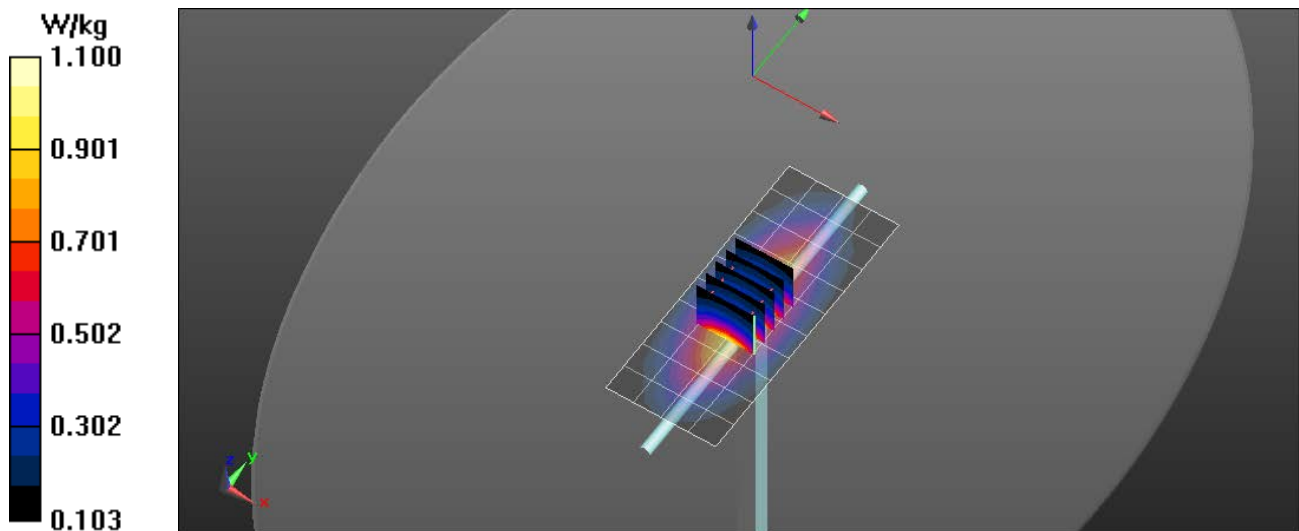

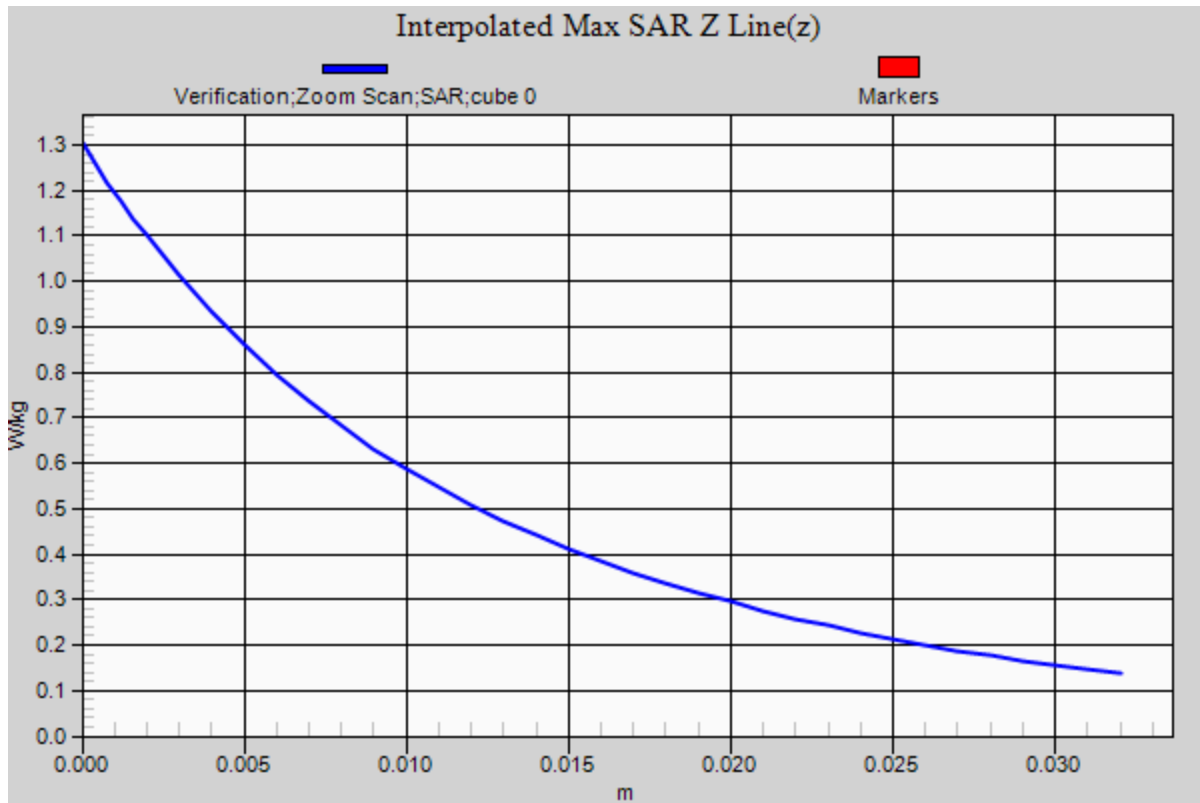

RF Exposure Lab

Plot 2

DUT: Dipole 835 MHz D835V2; Type: D835V2; Serial: D835V2 - SN:4d089

Communication System: CW; Frequency: 835 MHz; Duty Cycle: 1:1
Medium: MSL835; Medium parameters used: $f = 835 \text{ MHz}$; $\sigma = 0.98 \text{ S/m}$; $\epsilon_r = 54.37$; $\rho = 1000 \text{ kg/m}^3$
Phantom section: Flat Section

Test Date: Date: 5/21/2015; Ambient Temp: 23 °C; Tissue Temp: 21 °C

Probe: EX3DV4 - SN3833; ConvF(8.51, 8.51, 8.51); Calibrated: 1/23/2015;
Sensor-Surface: 2mm (Mechanical Surface Detection)
Electronics: DAE4 Sn759; Calibrated: 8/12/2014
Phantom: ELI v4.0; Type: QDOVA001BB; Serial: 1251
Measurement SW: DASY52, Version 52.8 (7); SEMCAD X Version 14.6.10 (7164)

Procedure Notes:

835 MHz/Verification/Area Scan (5x11x1): Measurement grid: $dx=15\text{mm}$, $dy=15\text{mm}$
Maximum value of SAR (measured) = 1.18 W/kg

835 MHz/Verification/Zoom Scan (5x5x7)/Cube 0: Measurement grid: $dx=8\text{mm}$, $dy=8\text{mm}$, $dz=5\text{mm}$
Reference Value = 31.227 V/m; Power Drift = -0.01 dB
Peak SAR (extrapolated) = 1.47 W/kg
SAR(1 g) = 0.943 W/kg; SAR(10 g) = 0.619 W/kg

Info: [Interpolated medium parameters used for SAR evaluation.](#)
Maximum value of SAR (measured) = 1.19 W/kg

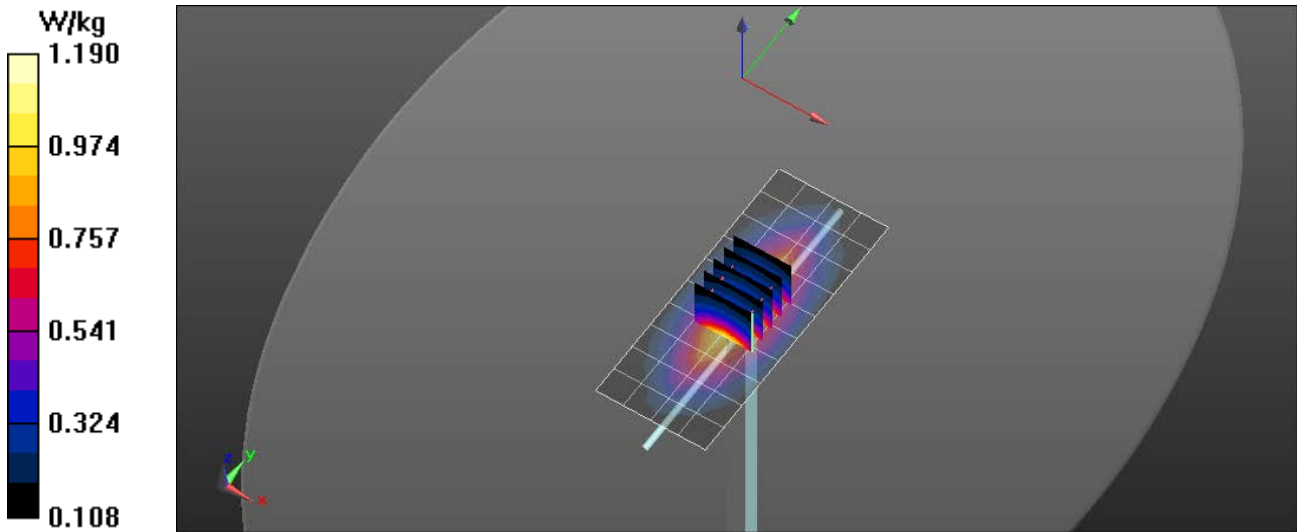

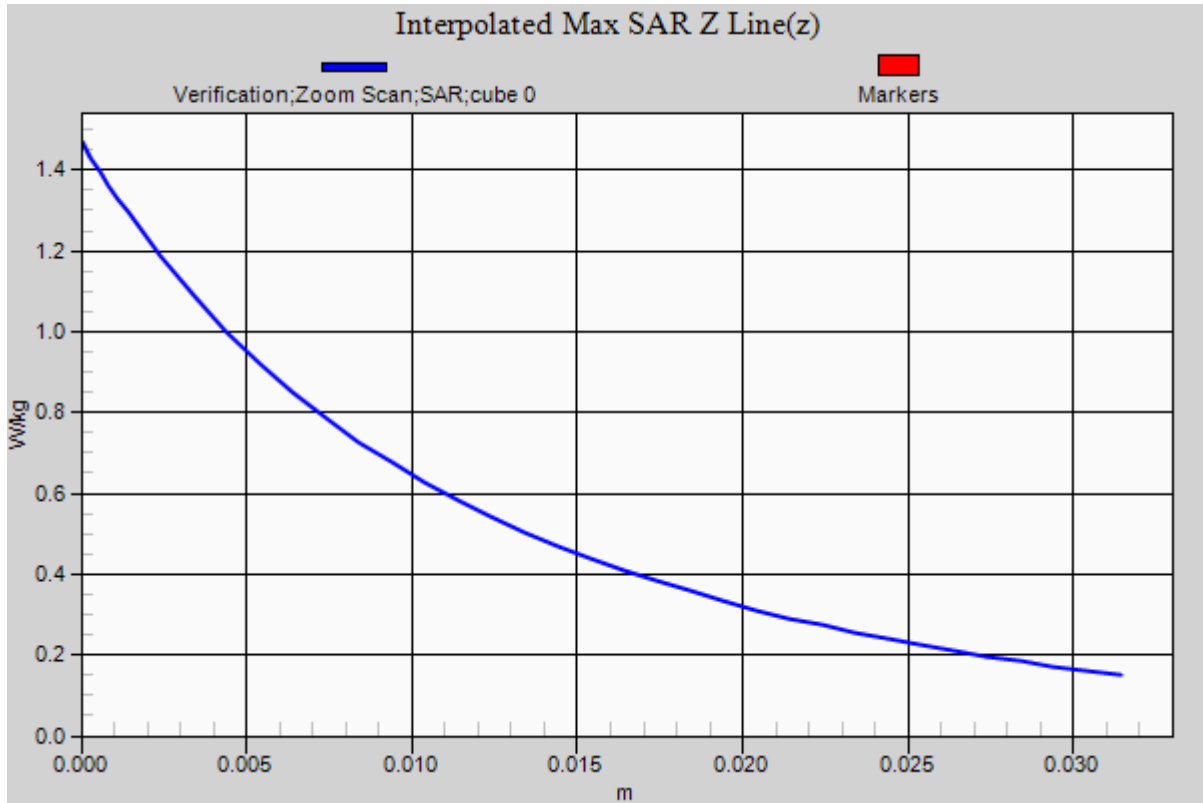

RF Exposure Lab

Plot 3

DUT: Dipole 1750 MHz D1750V2; Type: D1750V2; Serial: D1750V2 - SN:1018

Communication System: CW; Frequency: 1750 MHz; Duty Cycle: 1:1
Medium: MSL1750; Medium parameters used: $f = 1750$ MHz; $\sigma = 1.56$ S/m; $\epsilon_r = 52.68$; $\rho = 1000$ kg/m³
Phantom section: Flat Section

Test Date: Date: 5/23/2015; Ambient Temp: 23 °C; Tissue Temp: 21 °C

Probe: EX3DV4 - SN3833; ConvF(7.18, 7.18, 7.18); Calibrated: 1/23/2015;
Sensor-Surface: 2mm (Mechanical Surface Detection)
Electronics: DAE4 Sn759; Calibrated: 8/12/2014
Phantom: ELI v4.0; Type: QDOVA001BB; Serial: 1251
Measurement SW: DASY52, Version 52.8 (7); SEMCAD X Version 14.6.10 (7164)

Procedure Notes:

1750 MHz/Verification/Area Scan (5x7x1): Measurement grid: dx=15mm, dy=15mm
Maximum value of SAR (measured) = 5.33 W/kg

1750 MHz/Verification/Zoom Scan (5x5x7)/Cube 0: Measurement grid: dx=8mm, dy=8mm, dz=5mm
Reference Value = 31.227 V/m; Power Drift = -0.01 dB
Peak SAR (extrapolated) = 6.89 W/kg
SAR(1 g) = 3.85 W/kg; SAR(10 g) = 2.03 W/kg
Maximum value of SAR (measured) = 5.49 W/kg

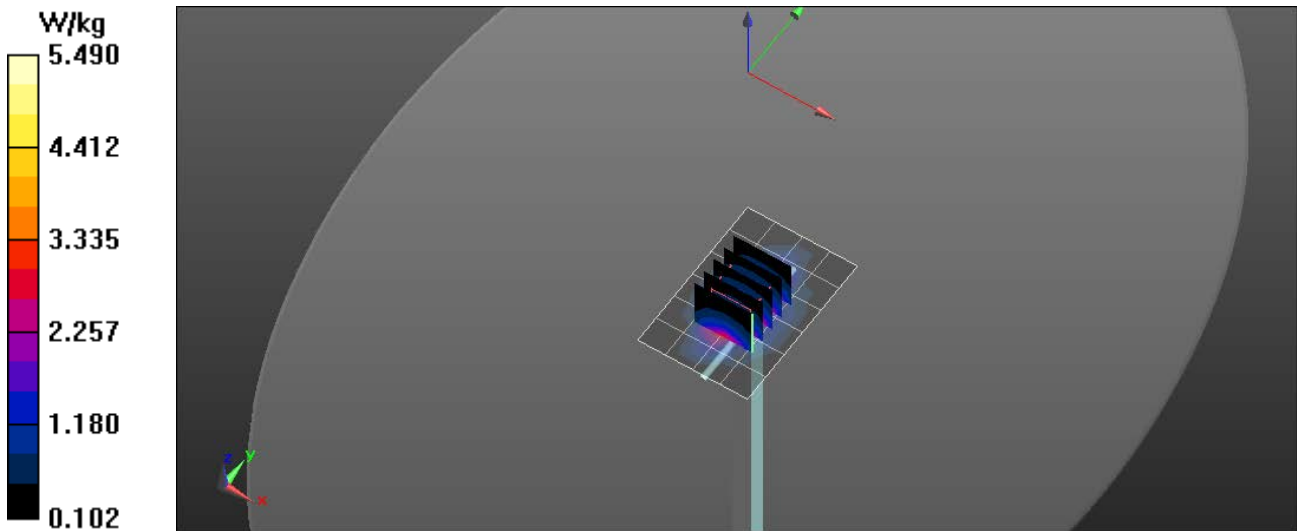

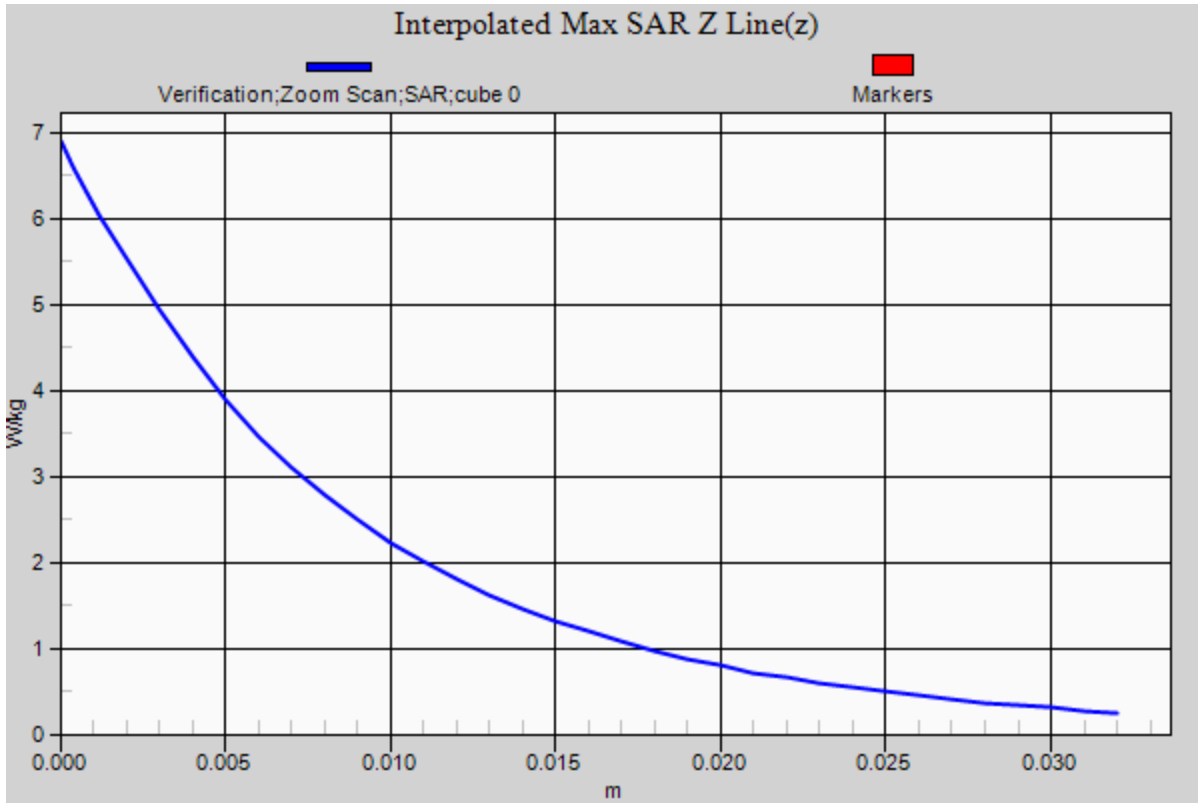

RF Exposure Lab

Plot 4

DUT: Dipole 1900 MHz D1900V2; Type: D1900V2; Serial: D1900V2 - SN:5d116

Communication System: CW; Frequency: 1900 MHz; Duty Cycle: 1:1
Medium: MSL1900; Medium parameters used: $f = 1900$ MHz; $\sigma = 1.54$ S/m; $\epsilon_r = 53.17$; $\rho = 1000$ kg/m³
Phantom section: Flat Section

Test Date: Date: 5/18/2015; Ambient Temp: 23 °C; Tissue Temp: 21 °C

Probe: EX3DV4 - SN3833; ConvF(7.04, 7.04, 7.04); Calibrated: 1/23/2015;
Sensor-Surface: 2mm (Mechanical Surface Detection)
Electronics: DAE4 Sn759; Calibrated: 8/12/2014
Phantom: ELI v4.0; Type: QDOVA001BB; Serial: 1251
Measurement SW: DASY52, Version 52.8 (7); SEMCAD X Version 14.6.10 (7164)

Procedure Notes:

1900 MHz/Verification/Area Scan (5x7x1): Measurement grid: dx=15mm, dy=15mm
Maximum value of SAR (measured) = 5.44 W/kg

1900 MHz/Verification/Zoom Scan (5x5x7)/Cube 0: Measurement grid: dx=8mm, dy=8mm, dz=5mm
Reference Value = 31.227 V/m; Power Drift = -0.01 dB
Peak SAR (extrapolated) = 7.22 W/kg
SAR(1 g) = 4.02 W/kg; SAR(10 g) = 2.1 W/kg
Maximum value of SAR (measured) = 5.77 W/kg

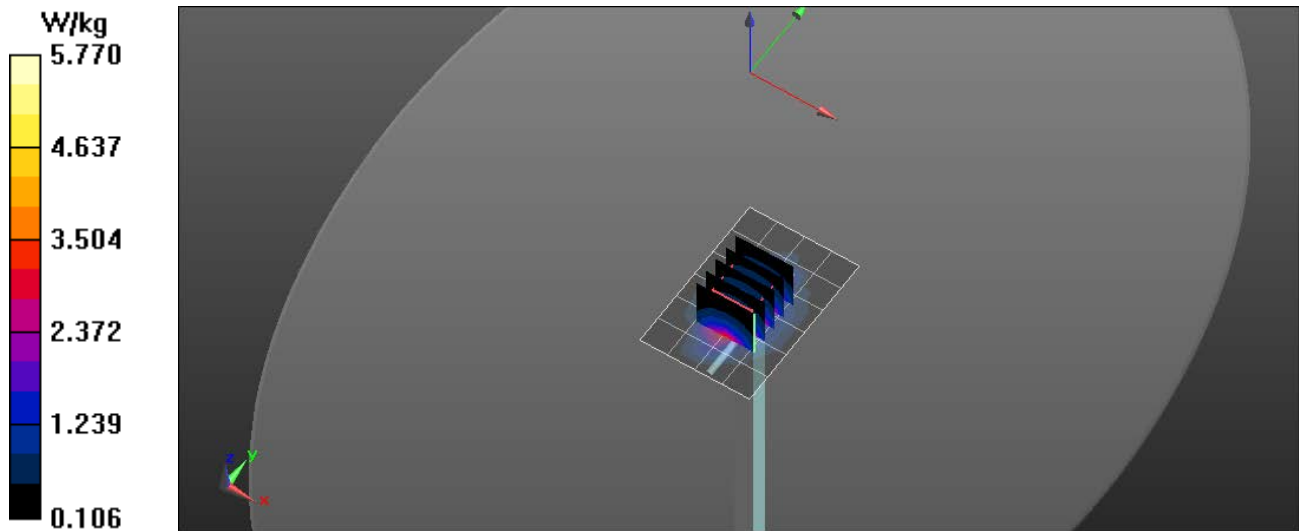

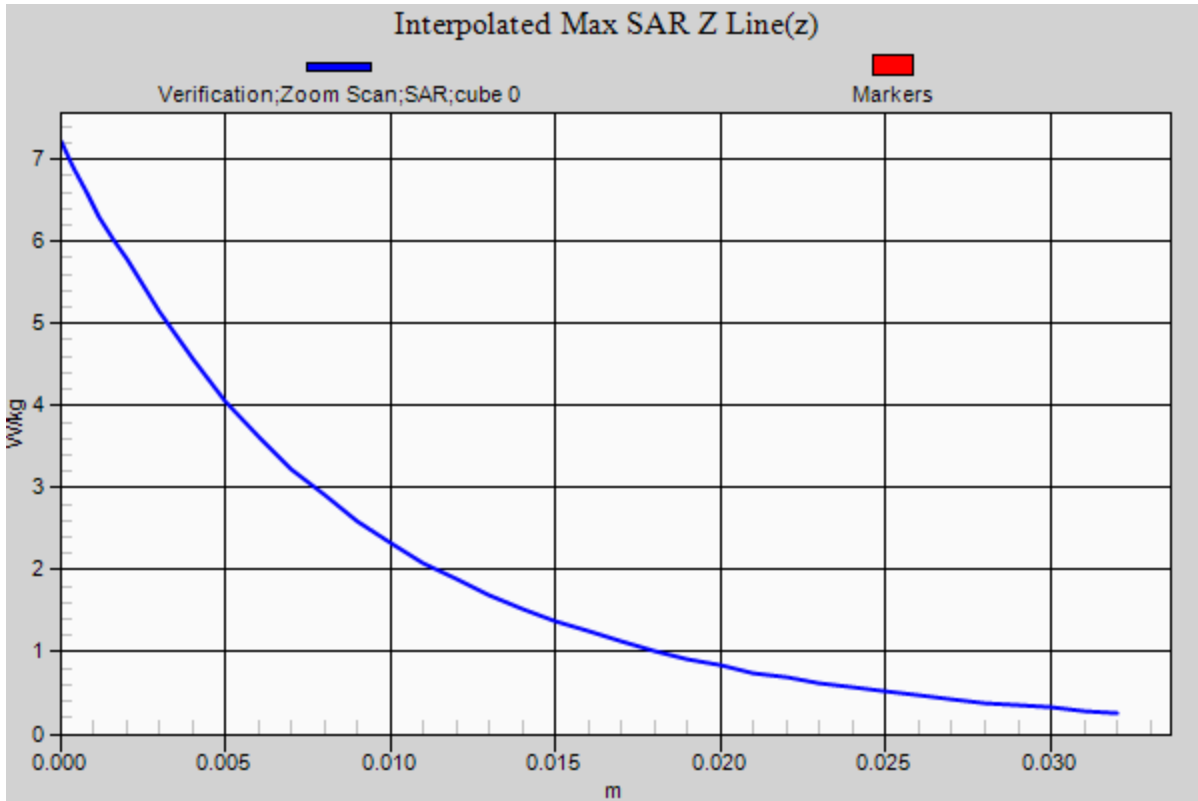

Appendix B – SAR Test Data Plots

RF Exposure Lab

Plot 1

DUT: LIVE+ EnGo; Type: Wireless TV Video Case; Serial: Eng 1

Communication System: LTE (SC-FDMA, 1 RB, 10 MHz, QPSK); Frequency: 710 MHz; Duty Cycle: 1:1
Medium: MSL750; Medium parameters used: $f = 710 \text{ MHz}$; $\sigma = 0.9 \text{ S/m}$; $\epsilon_r = 54.92$; $\rho = 1000 \text{ kg/m}^3$
Phantom section: Flat Section

Test Date: Date: 5/23/2015; Ambient Temp: 23 °C; Tissue Temp: 21 °C

Probe: EX3DV4 - SN3833; ConvF(8.98, 8.98, 8.98); Calibrated: 1/23/2015;
Sensor-Surface: 2mm (Mechanical Surface Detection)
Electronics: DAE4 Sn759; Calibrated: 8/12/2014
Phantom: ELI v4.0; Type: QDOVA001BB; Serial: 1251
Measurement SW: DASY52, Version 52.8 (8); SEMCAD X Version 14.6.10 (7331)

Procedure Notes:

750 MHz B17 LTE Long Edge/Ant T1 Mid 1RB 24 Offset/Area Scan (9x7x1): Measurement grid: $dx=15\text{mm}$, $dy=15\text{mm}$
Maximum value of SAR (measured) = 0.177 W/kg

750 MHz B17 LTE Long Edge/Ant T1 Mid 1RB 24 Offset/Zoom Scan (5x5x7)/Cube 0: Measurement grid: $dx=8\text{mm}$, $dy=8\text{mm}$, $dz=5\text{mm}$
Reference Value = 12.23 V/m; Power Drift = -0.02 dB
Peak SAR (extrapolated) = 0.208 W/kg
SAR(1 g) = 0.152 W/kg; SAR(10 g) = 0.108 W/kg
Maximum value of SAR (measured) = 0.183 W/kg

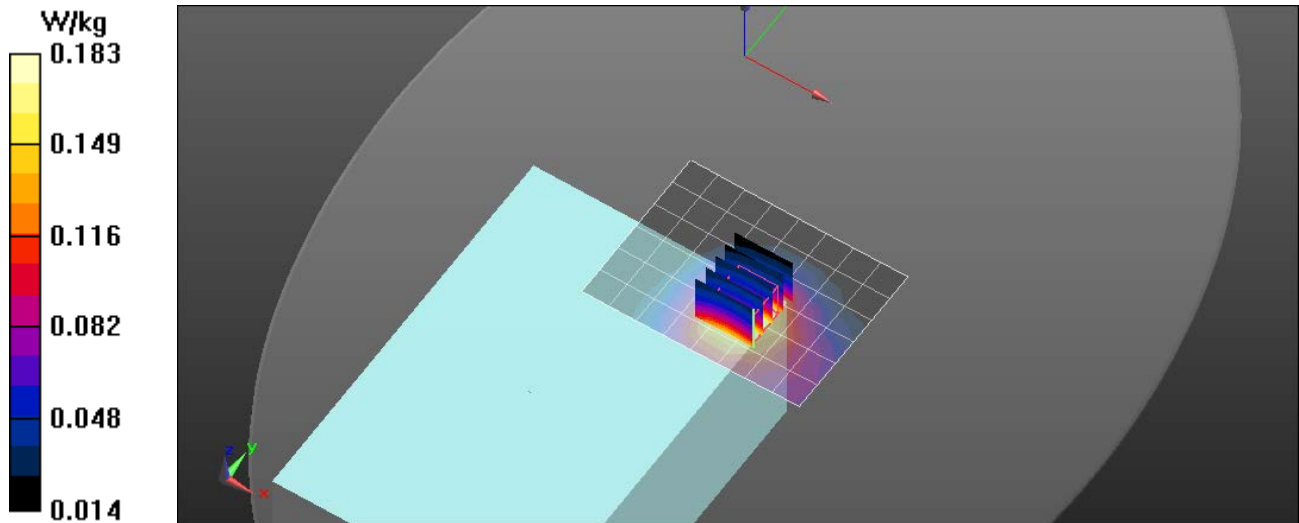

RF Exposure Lab

Plot 2

DUT: LIVE+ EnGo; Type: Wireless TV Video Case; Serial: Eng 1

Communication System: LTE (SC-FDMA, 1 RB, 10 MHz, QPSK); Frequency: 782 MHz; Duty Cycle: 1:1
Medium: MSL750; Medium parameters used (interpolated): $f = 782 \text{ MHz}$; $\sigma = 0.972 \text{ S/m}$; $\epsilon_r = 54.556$; $\rho = 1000 \text{ kg/m}^3$
Phantom section: Flat Section

Test Date: Date: 5/23/2015; Ambient Temp: 23 °C; Tissue Temp: 21 °C

Probe: EX3DV4 - SN3833; ConvF(8.98, 8.98, 8.98); Calibrated: 1/23/2015;
Sensor-Surface: 2mm (Mechanical Surface Detection)
Electronics: DAE4 Sn759; Calibrated: 8/12/2014
Phantom: ELI v4.0; Type: QDOVA001BB; Serial: 1251
Measurement SW: DASY52, Version 52.8 (8); SEMCAD X Version 14.6.10 (7331)

Procedure Notes:

750 MHz B13 LTE Long Edge/Ant T1 Mid 1RB 24 Offset/Area Scan (9x7x1): Measurement grid: dx=15mm, dy=15mm

[Info: Interpolated medium parameters used for SAR evaluation.](#)

Maximum value of SAR (measured) = 0.286 W/kg

750 MHz B13 LTE Long Edge/Ant T1 Mid 1RB 24 Offset/Zoom Scan (5x5x7)/Cube 0: Measurement grid: dx=8mm, dy=8mm, dz=5mm

Reference Value = 14.43 V/m; Power Drift = 0.03 dB

Peak SAR (extrapolated) = 0.339 W/kg

SAR(1 g) = 0.249 W/kg; SAR(10 g) = 0.177 W/kg

[Info: Interpolated medium parameters used for SAR evaluation.](#)

Maximum value of SAR (measured) = 0.300 W/kg

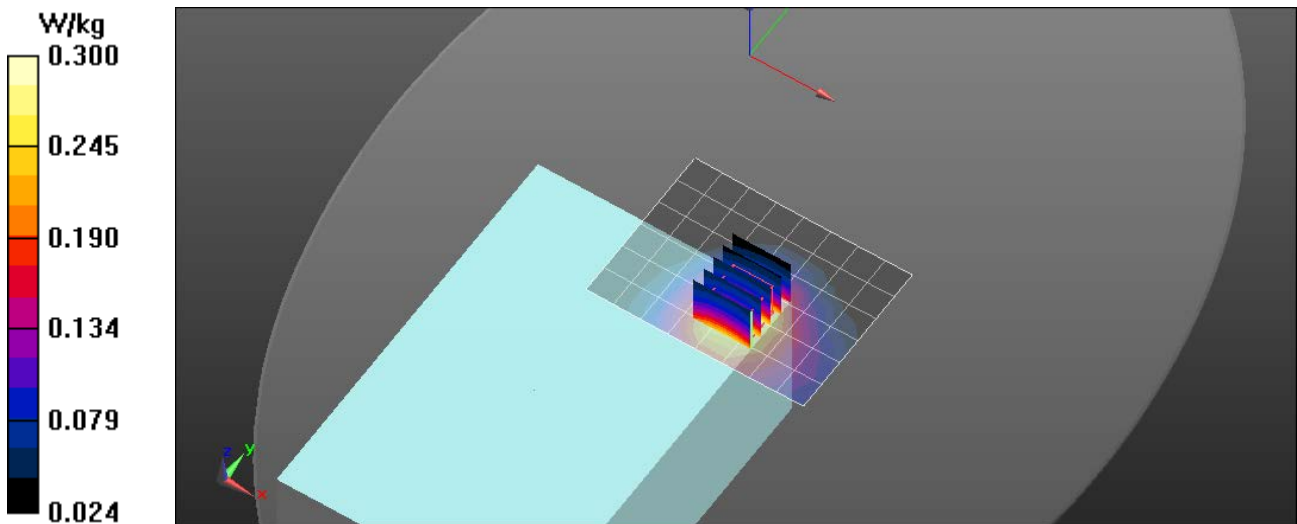

RF Exposure Lab

Plot 3

DUT: LIVE+ EnGo; Type: Wireless TV Video Case; Serial: Eng 1

Communication System: CDMA2000 (1xEV-DO); Frequency: 836.52 MHz; Duty Cycle: 1:1
Medium: MSL835; Medium parameters used (interpolated): $f = 836.52$ MHz; $\sigma = 0.982$ S/m; $\epsilon_r = 54.375$; $\rho = 1000$ kg/m³
Phantom section: Flat Section

Test Date: Date: 5/22/2015; Ambient Temp: 23 °C; Tissue Temp: 21 °C

Probe: EX3DV4 - SN3833; ConvF(8.51, 8.51, 8.51); Calibrated: 1/23/2015;
Sensor-Surface: 2mm (Mechanical Surface Detection)
Electronics: DAE4 Sn759; Calibrated: 8/12/2014
Phantom: ELI v4.0; Type: QDOVA001BB; Serial: 1251
Measurement SW: DASY52, Version 52.8 (8); SEMCAD X Version 14.6.10 (7331)

Procedure Notes:

835 MHz EvDo Long Edge/Ant T1 Mid/Area Scan (9x7x1): Measurement grid: dx=15mm, dy=15mm

[Info: Interpolated medium parameters used for SAR evaluation.](#)

Maximum value of SAR (measured) = 0.512 W/kg

835 MHz EvDo Long Edge/Ant T1 Mid/Zoom Scan (5x5x7)/Cube 0: Measurement grid: dx=8mm, dy=8mm, dz=5mm

Reference Value = 17.73 V/m; Power Drift = -0.01 dB

Peak SAR (extrapolated) = 0.598 W/kg

SAR(1 g) = 0.430 W/kg; SAR(10 g) = 0.301 W/kg

[Info: Interpolated medium parameters used for SAR evaluation.](#)

Maximum value of SAR (measured) = 0.521 W/kg

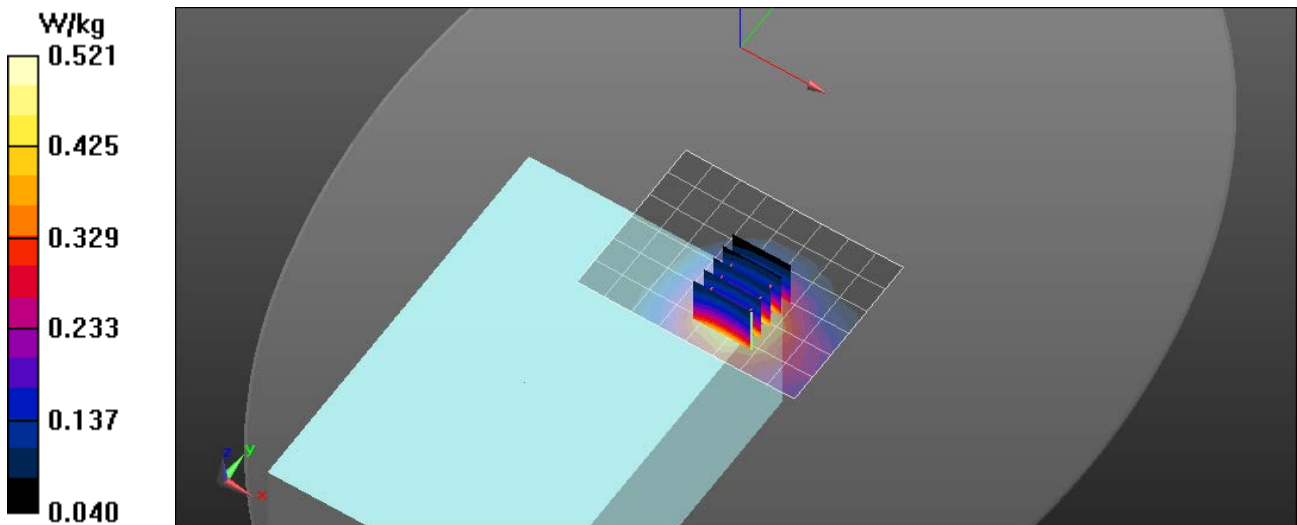

RF Exposure Lab

Plot 4

DUT: LIVE+ EnGo; Type: Wireless TV Video Case; Serial: Eng 1

Communication System: UMTS (WCDMA); Frequency: 836.6 MHz; Duty Cycle: 1:1
Medium: MSL835; Medium parameters used (interpolated): $f = 836.6$ MHz; $\sigma = 0.982$ S/m; $\epsilon_r = 54.375$; $\rho = 1000$ kg/m³
Phantom section: Flat Section

Test Date: Date: 5/21/2015; Ambient Temp: 23 °C; Tissue Temp: 21 °C

Probe: EX3DV4 - SN3833; ConvF(8.51, 8.51, 8.51); Calibrated: 1/23/2015;
Sensor-Surface: 2mm (Mechanical Surface Detection)
Electronics: DAE4 Sn759; Calibrated: 8/12/2014
Phantom: ELI v4.0; Type: QDOVA001BB; Serial: 1251
Measurement SW: DASY52, Version 52.8 (8); SEMCAD X Version 14.6.10 (7331)

Procedure Notes:

835 MHz WCDMA Long Edge/Ant T4 Mid/Area Scan (9x7x1): Measurement grid: dx=15mm, dy=15mm

[Info: Interpolated medium parameters used for SAR evaluation.](#)

Maximum value of SAR (measured) = 0.483 W/kg

835 MHz WCDMA Long Edge/Ant T4 Mid/Zoom Scan (5x5x7)/Cube 0: Measurement grid: dx=8mm, dy=8mm, dz=5mm

Reference Value = 18.42 V/m; Power Drift = 0.00 dB

Peak SAR (extrapolated) = 0.581 W/kg

SAR(1 g) = 0.415 W/kg; SAR(10 g) = 0.287 W/kg

[Info: Interpolated medium parameters used for SAR evaluation.](#)

Maximum value of SAR (measured) = 0.508 W/kg

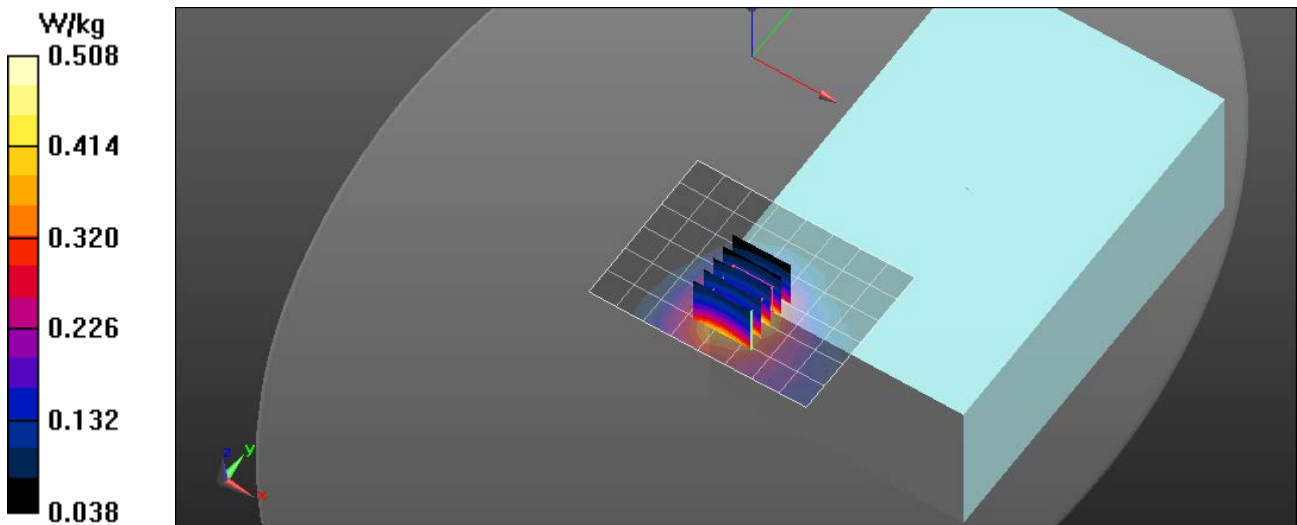

RF Exposure Lab

Plot 5

DUT: LIVE+ EnGo; Type: Wireless TV Video Case; Serial: Eng 1

Communication System: LTE (SC-FDMA, 1 RB, 10 MHz, QPSK); Frequency: 836.5 MHz; Duty Cycle: 1:1
Medium: MSL835; Medium parameters used (interpolated): $f = 836.5$ MHz; $\sigma = 0.982$ S/m; $\epsilon_r = 54.375$; $\rho = 1000$ kg/m³
Phantom section: Flat Section

Test Date: Date: 5/22/2015; Ambient Temp: 23 °C; Tissue Temp: 21 °C

Probe: EX3DV4 - SN3833; ConvF(8.51, 8.51, 8.51); Calibrated: 1/23/2015;
Sensor-Surface: 2mm (Mechanical Surface Detection)
Electronics: DAE4 Sn759; Calibrated: 8/12/2014
Phantom: ELI v4.0; Type: QDOVA001BB; Serial: 1251
Measurement SW: DASY52, Version 52.8 (8); SEMCAD X Version 14.6.10 (7331)

Procedure Notes:

835 MHz LTE Long Edge/Ant B4 Mid 1RB 24 Offset/Area Scan (9x7x1): Measurement grid: dx=15mm, dy=15mm

[Info: Interpolated medium parameters used for SAR evaluation.](#)

Maximum value of SAR (measured) = 0.387 W/kg

835 MHz LTE Long Edge/Ant B4 Mid 1RB 24 Offset/Zoom Scan (5x5x7)/Cube 0: Measurement grid: dx=8mm, dy=8mm, dz=5mm

Reference Value = 15.74 V/m; Power Drift = -0.02 dB

Peak SAR (extrapolated) = 0.462 W/kg

SAR(1 g) = 0.330 W/kg; SAR(10 g) = 0.227 W/kg

[Info: Interpolated medium parameters used for SAR evaluation.](#)

Maximum value of SAR (measured) = 0.404 W/kg

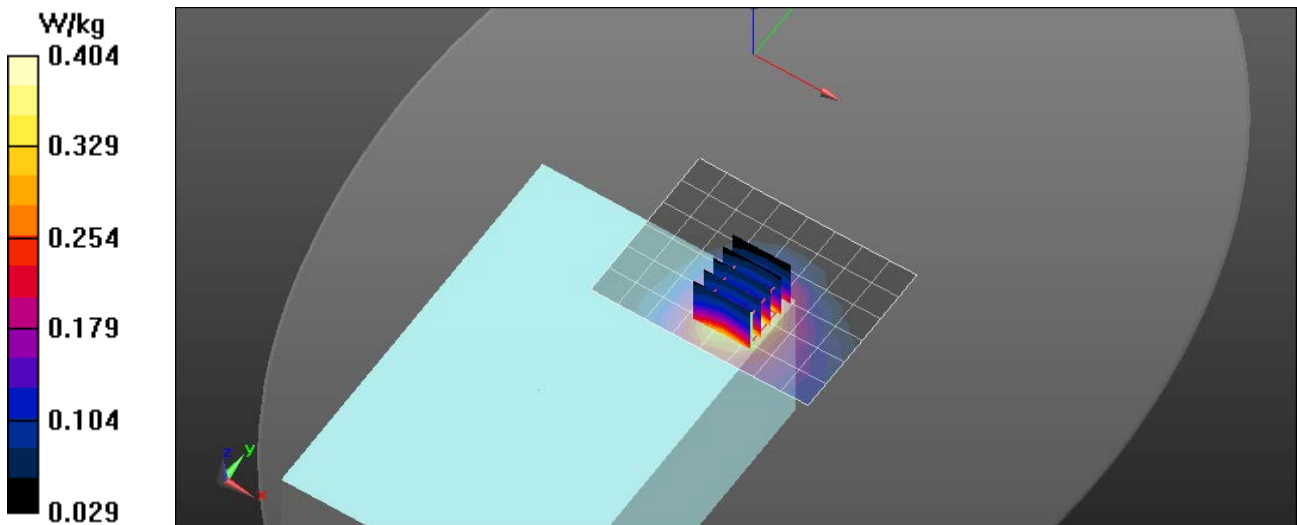

RF Exposure Lab

Plot 6

DUT: LIVE+ EnGo; Type: Wireless TV Video Case; Serial: Eng 1

Communication System: LTE (SC-FDMA, 1 RB, 20 MHz, QPSK); Frequency: 1732.5 MHz; Duty Cycle: 1:1
Medium: MSL1750; Medium parameters used (interpolated): $f = 1732.5$ MHz; $\sigma = 1.55$ S/m; $\epsilon_r = 52.73$; $\rho = 1000$ kg/m³
Phantom section: Flat Section

Test Date: Date: 5/23/2015; Ambient Temp: 23 °C; Tissue Temp: 21 °C

Probe: EX3DV4 - SN3833; ConvF(7.18, 7.18, 7.18); Calibrated: 1/23/2015;
Sensor-Surface: 2mm (Mechanical Surface Detection)
Electronics: DAE4 Sn759; Calibrated: 8/12/2014
Phantom: ELI v4.0; Type: QDOVA001BB; Serial: 1251
Measurement SW: DASY52, Version 52.8 (8); SEMCAD X Version 14.6.10 (7331)

Procedure Notes:

1750 MHz LTE Long Edge/Ant T1 Mid 1RB 49 Offset/Area Scan (9x7x1): Measurement grid: dx=15mm, dy=15mm

[Info: Interpolated medium parameters used for SAR evaluation.](#)

Maximum value of SAR (measured) = 0.625 W/kg

1750 MHz LTE Long Edge/Ant T1 Mid 1RB 49 Offset/Zoom Scan (5x5x7)/Cube 0: Measurement grid: dx=8mm, dy=8mm, dz=5mm

Reference Value = 16.40 V/m; Power Drift = -0.02 dB

Peak SAR (extrapolated) = 0.753 W/kg

SAR(1 g) = 0.485 W/kg; SAR(10 g) = 0.302 W/kg

[Info: Interpolated medium parameters used for SAR evaluation.](#)

Maximum value of SAR (measured) = 0.622 W/kg

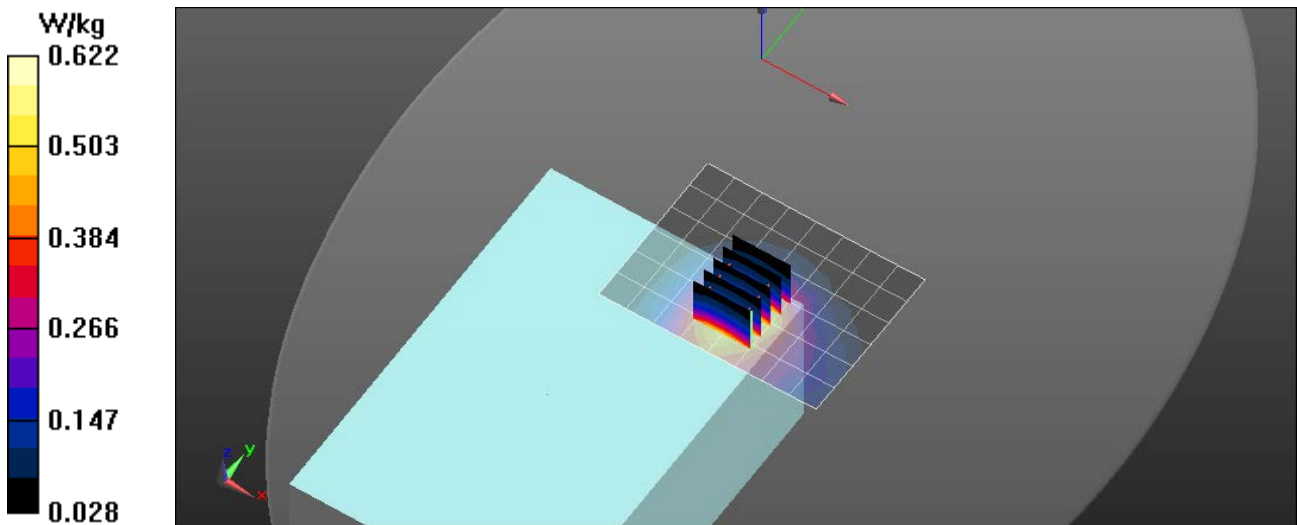

RF Exposure Lab

Plot 7

DUT: LIVE+ EnGo; Type: Wireless TV Video Case; Serial: Eng 1

Communication System: UMTS (WCDMA); Frequency: 1732.5 MHz; Duty Cycle: 1:1
Medium: MSL1750; Medium parameters used (interpolated): $f = 1732.5$ MHz; $\sigma = 1.55$ S/m; $\epsilon_r = 52.73$; $\rho = 1000$ kg/m³
Phantom section: Flat Section

Test Date: Date: 5/24/2015; Ambient Temp: 23 °C; Tissue Temp: 21 °C

Probe: EX3DV4 - SN3833; ConvF(7.18, 7.18, 7.18); Calibrated: 1/23/2015;
Sensor-Surface: 2mm (Mechanical Surface Detection)
Electronics: DAE4 Sn759; Calibrated: 8/12/2014
Phantom: ELI v4.0; Type: QDOVA001BB; Serial: 1251
Measurement SW: DASY52, Version 52.8 (8); SEMCAD X Version 14.6.10 (7331)

Procedure Notes:

1750 MHz WCDMA Long Edge/Ant T4 Mid/Area Scan (9x7x1): Measurement grid: dx=15mm, dy=15mm

[Info: Interpolated medium parameters used for SAR evaluation.](#)

Maximum value of SAR (measured) = 0.496 W/kg

1750 MHz WCDMA Long Edge/Ant T4 Mid/Zoom Scan (5x5x7)/Cube 0: Measurement grid: dx=8mm, dy=8mm, dz=5mm

Reference Value = 18.63 V/m; Power Drift = 0.02 dB

Peak SAR (extrapolated) = 0.593 W/kg

SAR(1 g) = 0.418 W/kg; SAR(10 g) = 0.282 W/kg

[Info: Interpolated medium parameters used for SAR evaluation.](#)

Maximum value of SAR (measured) = 0.506 W/kg

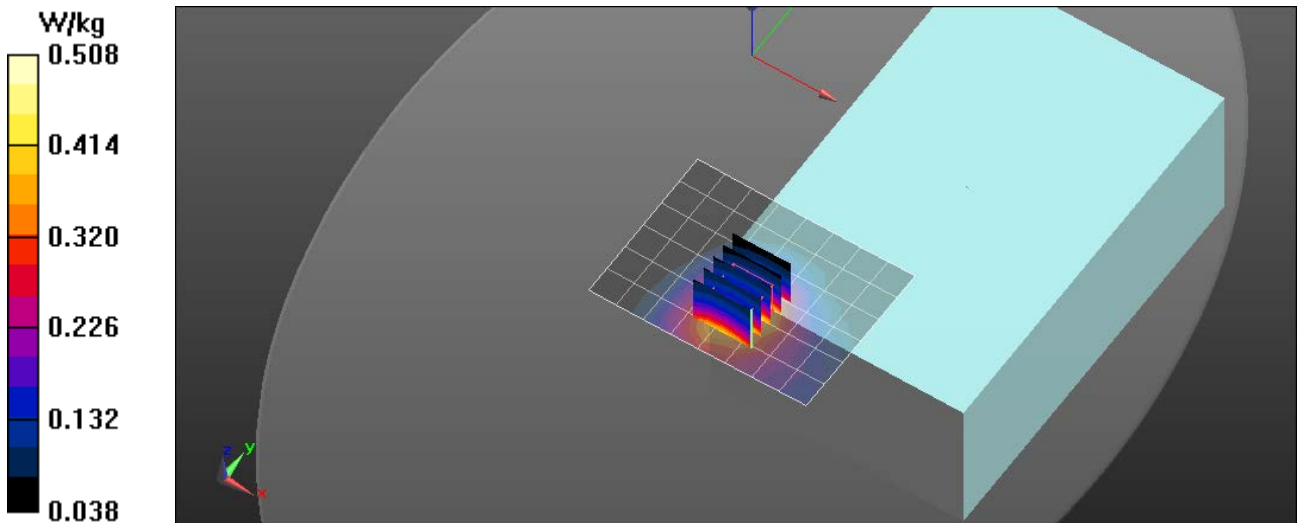

RF Exposure Lab

Plot 8

DUT: LIVE+ EnGo; Type: Wireless TV Video Case; Serial: Eng 1

Communication System: CDMA2000 (1xEV-DO); Frequency: 1880 MHz; Duty Cycle: 1:1
Medium: MSL1900; Medium parameters used: $f = 1880$ MHz; $\sigma = 1.52$ S/m; $\epsilon_r = 53.21$; $\rho = 1000$ kg/m³
Phantom section: Flat Section

Test Date: Date: 5/19/2015; Ambient Temp: 23 °C; Tissue Temp: 21 °C

Probe: EX3DV4 - SN3833; ConvF(7.04, 7.04, 7.04); Calibrated: 1/23/2015;
Sensor-Surface: 2mm (Mechanical Surface Detection)
Electronics: DAE4 Sn759; Calibrated: 8/12/2014
Phantom: ELI v4.0; Type: QDOVA001BB; Serial: 1251
Measurement SW: DASY52, Version 52.8 (8); SEMCAD X Version 14.6.10 (7331)

Procedure Notes:

1900 MHz EvDo Long Edge/Ant B3 Mid/Area Scan (9x7x1): Measurement grid: dx=15mm, dy=15mm
Maximum value of SAR (measured) = 0.661 W/kg

1900 MHz EvDo Long Edge/Ant B3 Mid/Zoom Scan (5x5x7)/Cube 0: Measurement grid: dx=8mm, dy=8mm, dz=5mm
Reference Value = 22.45 V/m; Power Drift = -0.01 dB
Peak SAR (extrapolated) = 0.823 W/kg
SAR(1 g) = 0.530 W/kg; SAR(10 g) = 0.330 W/kg
Maximum value of SAR (measured) = 0.687 W/kg

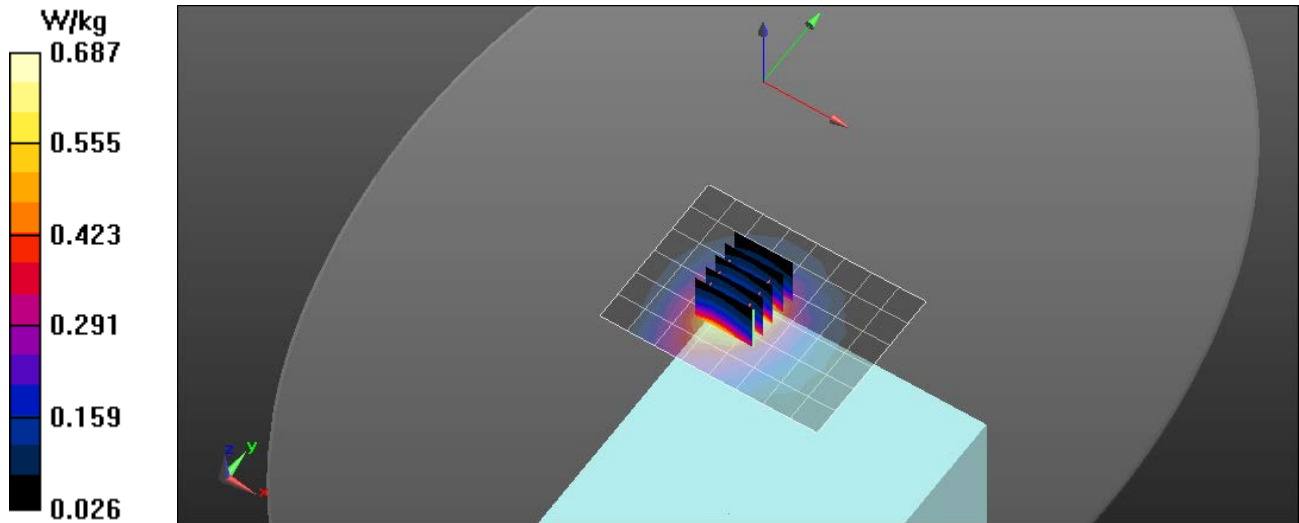

RF Exposure Lab

Plot 9

DUT: LIVE+ EnGo; Type: Wireless TV Video Case; Serial: Eng 1

Communication System: UMTS (WCDMA); Frequency: 1880 MHz; Duty Cycle: 1:1
Medium: MSL1900; Medium parameters used: $f = 1880$ MHz; $\sigma = 1.52$ S/m; $\epsilon_r = 53.21$; $\rho = 1000$ kg/m³
Phantom section: Flat Section

Test Date: Date: 5/20/2015; Ambient Temp: 23 °C; Tissue Temp: 21 °C

Probe: EX3DV4 - SN3833; ConvF(7.04, 7.04, 7.04); Calibrated: 1/23/2015;
Sensor-Surface: 2mm (Mechanical Surface Detection)
Electronics: DAE4 Sn759; Calibrated: 8/12/2014
Phantom: ELI v4.0; Type: QDOVA001BB; Serial: 1251
Measurement SW: DASY52, Version 52.8 (8); SEMCAD X Version 14.6.10 (7331)

Procedure Notes:

1900 MHz WCDMA Long Edge/Ant B1 Mid/Area Scan (9x7x1): Measurement grid: dx=15mm, dy=15mm
Maximum value of SAR (measured) = 0.502 W/kg

1900 MHz WCDMA Long Edge/Ant B1 Mid/Zoom Scan (5x5x7)/Cube 0: Measurement grid: dx=8mm, dy=8mm, dz=5mm
Reference Value = 16.01 V/m; Power Drift = 0.02 dB
Peak SAR (extrapolated) = 0.649 W/kg
SAR(1 g) = 0.418 W/kg; SAR(10 g) = 0.259 W/kg
Maximum value of SAR (measured) = 0.541 W/kg

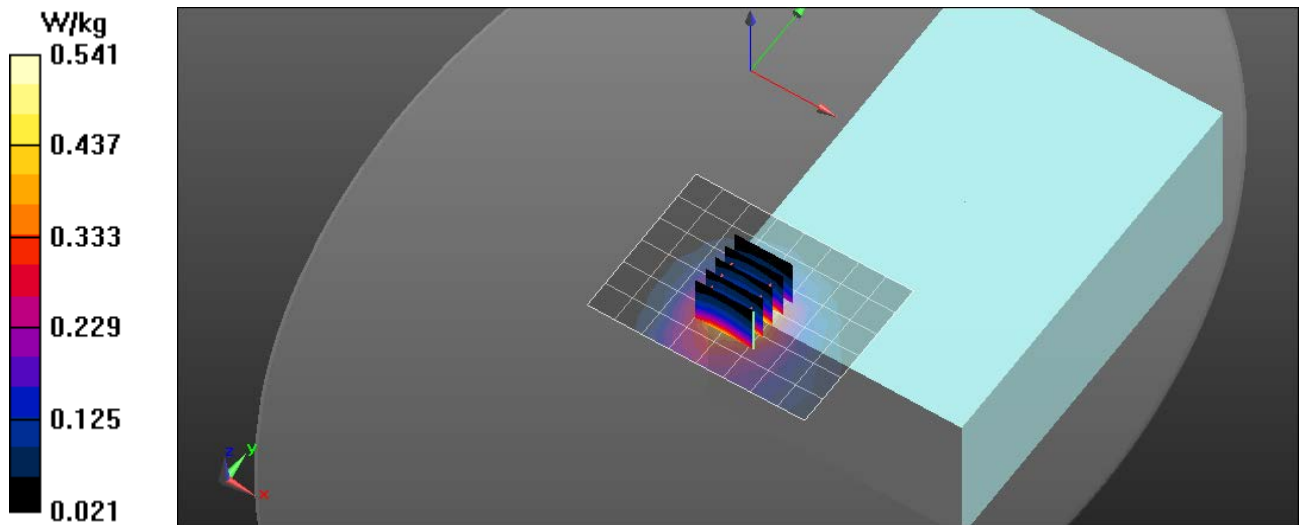

RF Exposure Lab

Plot 10

DUT: LIVE+ EnGo; Type: Wireless TV Video Case; Serial: Eng 1

Communication System: LTE (SC-FDMA, 1 RB, 20 MHz, QPSK); Frequency: 1882.5 MHz; Duty Cycle: 1:1
Medium: MSL1900; Medium parameters used (interpolated): $f = 1882.5$ MHz; $\sigma = 1.523$ S/m; $\epsilon_r = 53.205$; $\rho = 1000$ kg/m³
Phantom section: Flat Section

Test Date: Date: 5/20/2015; Ambient Temp: 23 °C; Tissue Temp: 21 °C

Probe: EX3DV4 - SN3833; ConvF(7.04, 7.04, 7.04); Calibrated: 1/23/2015;
Sensor-Surface: 2mm (Mechanical Surface Detection)
Electronics: DAE4 Sn759; Calibrated: 8/12/2014
Phantom: ELI v4.0; Type: QDOVA001BB; Serial: 1251
Measurement SW: DASY52, Version 52.8 (8); SEMCAD X Version 14.6.10 (7331)

Procedure Notes:

1900 MHz LTE Long Edge/Ant B4 Mid 1RB 49 Offset/Area Scan (9x7x1): Measurement grid: dx=15mm, dy=15mm

[Info: Interpolated medium parameters used for SAR evaluation.](#)

Maximum value of SAR (measured) = 0.447 W/kg

1900 MHz LTE Long Edge/Ant B4 Mid 1RB 49 Offset/Zoom Scan (5x5x7)/Cube 0: Measurement grid: dx=8mm, dy=8mm, dz=5mm

Reference Value = 15.12 V/m; Power Drift = -0.01 dB

Peak SAR (extrapolated) = 0.536 W/kg

SAR(1 g) = 0.347 W/kg; SAR(10 g) = 0.217 W/kg

[Info: Interpolated medium parameters used for SAR evaluation.](#)

Maximum value of SAR (measured) = 0.446 W/kg

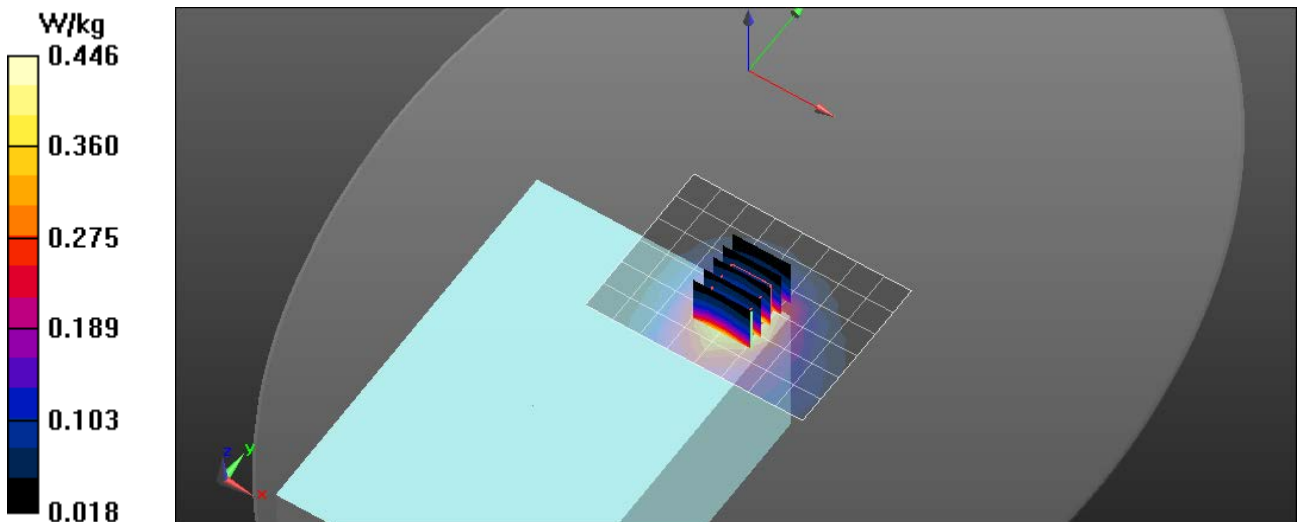

Appendix C – SAR Test Setup Photos



Test Configuration End 10 mm Gap



Test Configuration Short Side 10 mm Gap



Test Configuration Long Side 10 mm Gap



Front of Device



Back of Device

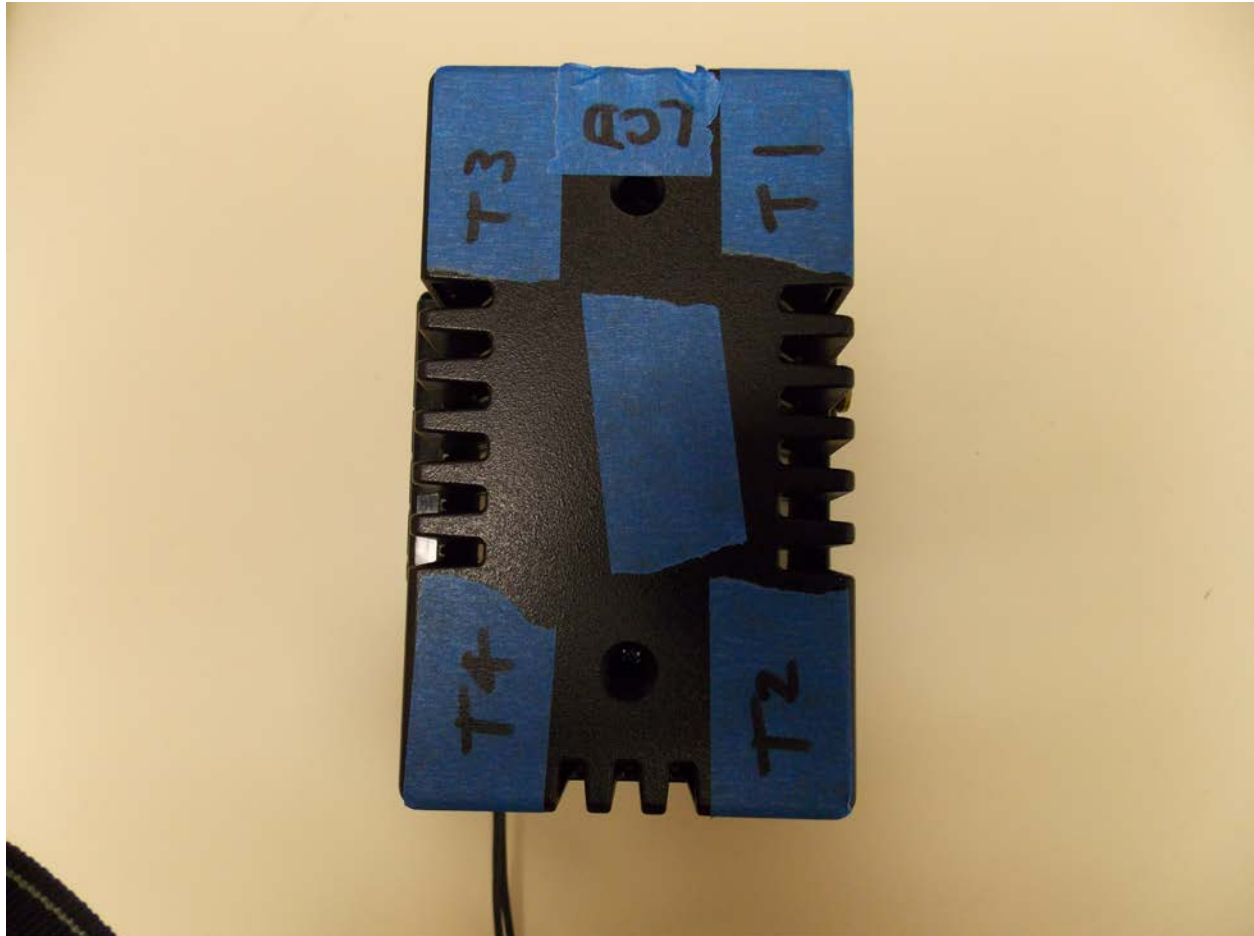

Top of Device

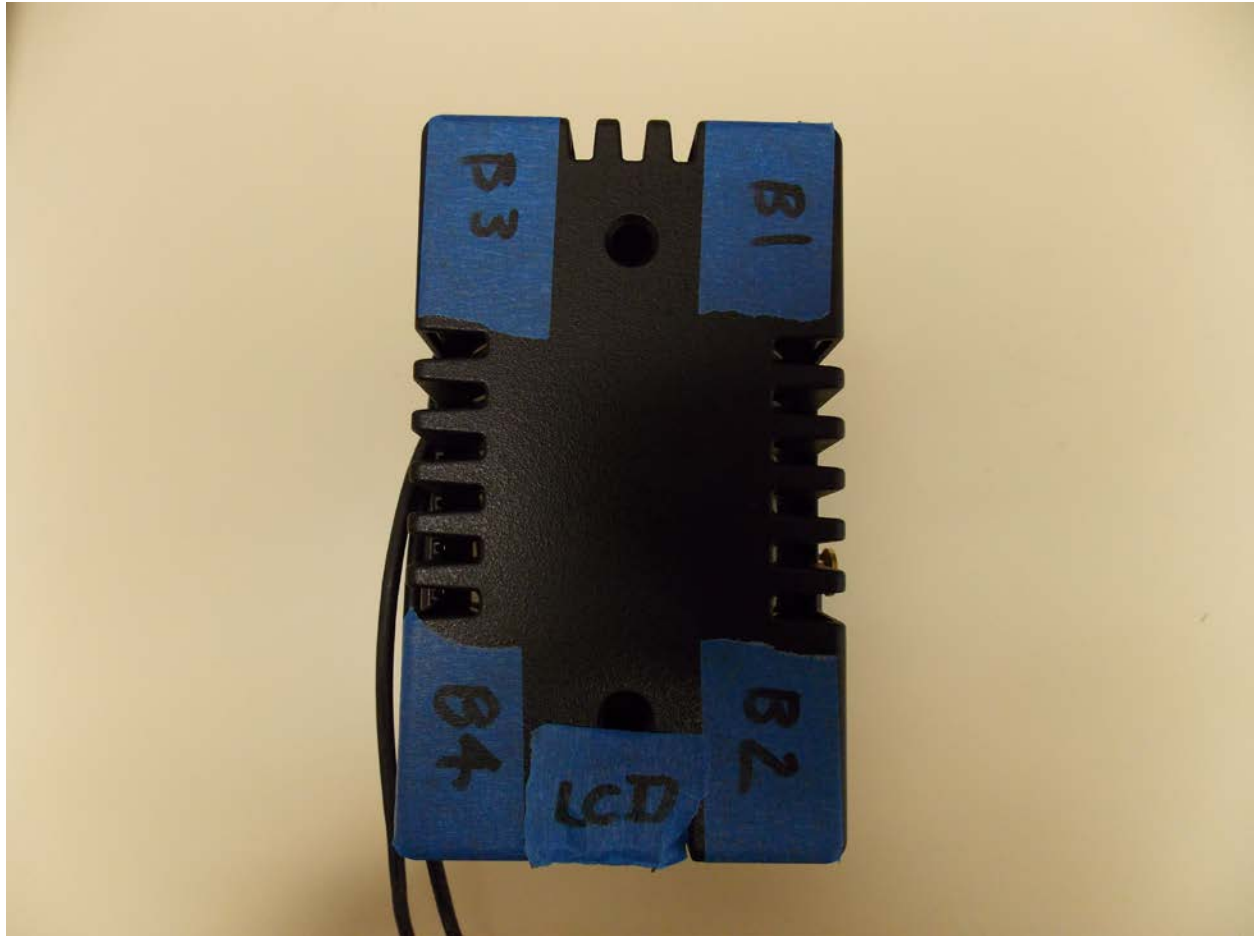

Bottom of Device



Left Side of Device



Right Side of Device



Top of Device in Carrying Case Opened



Bottom of Device in Carrying Case Opened



Right Side of Device in Carrying Case Opened



Front of Device in Carrying Case Opened



Front of Device in Carrying Case Closed

Appendix D – Probe Calibration Data Sheets



Accredited by the Swiss Accreditation Service (SAS)
The Swiss Accreditation Service is one of the signatories to the EA
Multilateral Agreement for the recognition of calibration certificates

Accreditation No.: **SCS 0108**

Client **RF Exposure Lab**

Certificate No: **EX3-3833_Jan15**

CALIBRATION CERTIFICATE

Object **EX3DV4 - SN:3833**

Calibration procedure(s) **QA CAL-01.v9, QA CAL-12.v9, QA CAL-14.v4, QA CAL-23.v5,
QA CAL-25.v6
Calibration procedure for dosimetric E-field probes**

Calibration date: **January 23, 2015**

This calibration certificate documents the traceability to national standards, which realize the physical units of measurements (SI).
The measurements and the uncertainties with confidence probability are given on the following pages and are part of the certificate.

All calibrations have been conducted in the closed laboratory facility: environment temperature (22 ± 3)°C and humidity < 70%.

Calibration Equipment used (M&TE critical for calibration)

Primary Standards	ID	Cal Date (Certificate No.)	Scheduled Calibration
Power meter E4419B	GB41293874	03-Apr-14 (No. 217-01911)	Apr-15
Power sensor E4412A	MY41498087	03-Apr-14 (No. 217-01911)	Apr-15
Reference 3 dB Attenuator	SN: S5054 (3c)	03-Apr-14 (No. 217-01915)	Apr-15
Reference 20 dB Attenuator	SN: S5277 (20x)	03-Apr-14 (No. 217-01919)	Apr-15
Reference 30 dB Attenuator	SN: S5129 (30b)	03-Apr-14 (No. 217-01920)	Apr-15
Reference Probe ES3DV2	SN: 3013	30-Dec-14 (No. ES3-3013_Dec14)	Dec-15
DAE4	SN: 660	14-Jan-15 (No. DAE4-660_Jan15)	Jan-16
Secondary Standards	ID	Check Date (in house)	Scheduled Check
RF generator HP 8648C	US3642U01700	4-Aug-99 (in house check Apr-13)	In house check: Apr-16
Network Analyzer HP 8753E	US37390585	18-Oct-01 (in house check Oct-14)	In house check: Oct-15

Calibrated by:	Name Cluadio Leubler	Function Laboratory Technician	Signature
Approved by:	Name Katja Pokovic	Function Technical Manager	Signature

Issued: January 26, 2015

This calibration certificate shall not be reproduced except in full without written approval of the laboratory.



Accredited by the Swiss Accreditation Service (SAS)

Accreditation No.: **SCS 0108**

The Swiss Accreditation Service is one of the signatories to the EA Multilateral Agreement for the recognition of calibration certificates

Glossary:

TSL	tissue simulating liquid
NORM _{x,y,z}	sensitivity in free space
ConvF	sensitivity in TSL / NORM _{x,y,z}
DCP	diode compression point
CF	crest factor (1/duty_cycle) of the RF signal
A, B, C, D	modulation dependent linearization parameters
Polarization φ	φ rotation around probe axis
Polarization ϑ	ϑ rotation around an axis that is in the plane normal to probe axis (at measurement center), i.e., $\vartheta = 0$ is normal to probe axis
Connector Angle	information used in DASY system to align probe sensor X to the robot coordinate system

Calibration is Performed According to the Following Standards:

- IEEE Std 1528-2013, "IEEE Recommended Practice for Determining the Peak Spatial-Averaged Specific Absorption Rate (SAR) in the Human Head from Wireless Communications Devices: Measurement Techniques", June 2013
- IEC 62209-1, "Procedure to measure the Specific Absorption Rate (SAR) for hand-held devices used in close proximity to the ear (frequency range of 300 MHz to 3 GHz)", February 2005

Methods Applied and Interpretation of Parameters:

- NORM_{x,y,z}**: Assessed for E-field polarization $\vartheta = 0$ ($f \leq 900$ MHz in TEM-cell; $f > 1800$ MHz: R22 waveguide). NORM_{x,y,z} are only intermediate values, i.e., the uncertainties of NORM_{x,y,z} does not affect the E^2 -field uncertainty inside TSL (see below *ConvF*).
- NORM(f)_{x,y,z}** = NORM_{x,y,z} * *frequency_response* (see Frequency Response Chart). This linearization is implemented in DASY4 software versions later than 4.2. The uncertainty of the frequency response is included in the stated uncertainty of *ConvF*.
- DCP_{x,y,z}**: DCP are numerical linearization parameters assessed based on the data of power sweep with CW signal (no uncertainty required). DCP does not depend on frequency nor media.
- PAR**: PAR is the Peak to Average Ratio that is not calibrated but determined based on the signal characteristics
- A_{x,y,z}; B_{x,y,z}; C_{x,y,z}; D_{x,y,z}; VR_{x,y,z}; A, B, C, D** are numerical linearization parameters assessed based on the data of power sweep for specific modulation signal. The parameters do not depend on frequency nor media. VR is the maximum calibration range expressed in RMS voltage across the diode.
- ConvF and Boundary Effect Parameters**: Assessed in flat phantom using E-field (or Temperature Transfer Standard for $f \leq 800$ MHz) and inside waveguide using analytical field distributions based on power measurements for $f > 800$ MHz. The same setups are used for assessment of the parameters applied for boundary compensation (alpha, depth) of which typical uncertainty values are given. These parameters are used in DASY4 software to improve probe accuracy close to the boundary. The sensitivity in TSL corresponds to NORM_{x,y,z} * *ConvF* whereby the uncertainty corresponds to that given for *ConvF*. A frequency dependent *ConvF* is used in DASY version 4.4 and higher which allows extending the validity from ± 50 MHz to ± 100 MHz.
- Spherical isotropy (3D deviation from isotropy)**: in a field of low gradients realized using a flat phantom exposed by a patch antenna.
- Sensor Offset**: The sensor offset corresponds to the offset of virtual measurement center from the probe tip (on probe axis). No tolerance required.
- Connector Angle**: The angle is assessed using the information gained by determining the NORM_x (no uncertainty required).

Probe EX3DV4

SN:3833

Manufactured: November 7, 2011
Calibrated: January 23, 2015

Calibrated for DASY/EASY Systems
(Note: non-compatible with DASY2 system!)

DASY/EASY - Parameters of Probe: EX3DV4 - SN:3833

Basic Calibration Parameters

	Sensor X	Sensor Y	Sensor Z	Unc (k=2)
Norm ($\mu\text{V}/(\text{V}/\text{m})^2$) ^A	0.47	0.49	0.35	$\pm 10.1\%$
DCP (mV) ^B	101.8	100.3	103.5	

Modulation Calibration Parameters

UID	Communication System Name		A dB	B dB $\sqrt{\mu\text{V}}$	C	D dB	VR mV	Unc ^E (k=2)
0	CW	X	0.0	0.0	1.0	0.00	131.5	$\pm 3.5\%$
		Y	0.0	0.0	1.0		133.2	
		Z	0.0	0.0	1.0		131.7	

The reported uncertainty of measurement is stated as the standard uncertainty of measurement multiplied by the coverage factor k=2, which for a normal distribution corresponds to a coverage probability of approximately 95%.

^A The uncertainties of NormX,Y,Z do not affect the E²-field uncertainty inside TSL (see Pages 5 and 6).

^B Numerical linearization parameter: uncertainty not required.

^E Uncertainty is determined using the max. deviation from linear response applying rectangular distribution and is expressed for the square of the field value.

DASY/EASY - Parameters of Probe: EX3DV4 - SN:3833

Calibration Parameter Determined in Head Tissue Simulating Media

f (MHz) ^C	Relative Permittivity ^F	Conductivity (S/m) ^F	ConvF X	ConvF Y	ConvF Z	Alpha ^G	Depth ^G (mm)	Unct. (k=2)
150	52.3	0.76	11.02	11.02	11.02	0.00	1.00	± 13.3 %
220	49.0	0.81	10.50	10.50	10.50	0.00	1.00	± 13.3 %
300	45.3	0.87	10.41	10.41	10.41	0.10	1.25	± 13.3 %
450	43.5	0.87	9.34	9.34	9.34	0.16	1.40	± 13.3 %
600	42.7	0.88	9.41	9.41	9.41	0.10	1.10	± 13.3 %
750	41.9	0.89	8.98	8.98	8.98	0.35	0.98	± 12.0 %
900	41.5	0.97	8.51	8.51	8.51	0.34	0.99	± 12.0 %
1640	40.3	1.29	7.50	7.50	7.50	0.23	1.08	± 12.0 %
1750	40.1	1.37	7.42	7.42	7.42	0.49	0.70	± 12.0 %
1900	40.0	1.40	7.29	7.29	7.29	0.57	0.62	± 12.0 %
2450	39.2	1.80	6.58	6.58	6.58	0.41	0.76	± 12.0 %
5200	36.0	4.66	4.62	4.62	4.62	0.35	1.80	± 13.1 %
5300	35.9	4.76	4.44	4.44	4.44	0.35	1.80	± 13.1 %
5500	35.6	4.96	4.18	4.18	4.18	0.40	1.80	± 13.1 %
5600	35.5	5.07	4.03	4.03	4.03	0.40	1.80	± 13.1 %
5800	35.3	5.27	4.12	4.12	4.12	0.40	1.80	± 13.1 %

^C Frequency validity above 300 MHz of ± 100 MHz only applies for DASY v4.4 and higher (see Page 2), else it is restricted to ± 50 MHz. The uncertainty is the RSS of the ConvF uncertainty at calibration frequency and the uncertainty for the indicated frequency band. Frequency validity below 300 MHz is ± 10, 25, 40, 50 and 70 MHz for ConvF assessments at 30, 64, 128, 150 and 220 MHz respectively. Above 5 GHz frequency validity can be extended to ± 110 MHz.

^F At frequencies below 3 GHz, the validity of tissue parameters (ϵ and σ) can be relaxed to ± 10% if liquid compensation formula is applied to measured SAR values. At frequencies above 3 GHz, the validity of tissue parameters (ϵ and σ) is restricted to ± 5%. The uncertainty is the RSS of the ConvF uncertainty for indicated target tissue parameters.

^G Alpha/Depth are determined during calibration. SPEAG warrants that the remaining deviation due to the boundary effect after compensation is always less than ± 1% for frequencies below 3 GHz and below ± 2% for frequencies between 3-6 GHz at any distance larger than half the probe tip diameter from the boundary.

DASY/EASY - Parameters of Probe: EX3DV4 - SN:3833

Calibration Parameter Determined in Body Tissue Simulating Media

f (MHz) ^C	Relative Permittivity ^F	Conductivity (S/m) ^F	ConvF X	ConvF Y	ConvF Z	Alpha ^G	Depth ^G (mm)	Unct. (k=2)
150	61.9	0.80	11.21	11.21	11.21	0.00	1.00	± 13.3 %
220	60.2	0.86	10.20	10.20	10.20	0.00	1.00	± 13.3 %
300	58.2	0.92	10.29	10.29	10.29	0.06	1.15	± 13.3 %
450	56.7	0.94	10.02	10.02	10.02	0.08	1.12	± 13.3 %
600	56.1	0.95	9.37	9.37	9.37	0.10	1.10	± 13.3 %
750	55.5	0.96	8.75	8.75	8.75	0.24	1.32	± 12.0 %
900	55.0	1.05	8.51	8.51	8.51	0.41	0.88	± 12.0 %
1640	53.8	1.40	7.64	7.64	7.64	0.31	0.95	± 12.0 %
1750	53.4	1.49	7.18	7.18	7.18	0.34	0.93	± 12.0 %
1900	53.3	1.52	7.04	7.04	7.04	0.60	0.67	± 12.0 %
2450	52.7	1.95	6.69	6.69	6.69	0.80	0.57	± 12.0 %
5200	49.0	5.30	3.92	3.92	3.92	0.45	1.90	± 13.1 %
5300	48.9	5.42	3.81	3.81	3.81	0.45	1.90	± 13.1 %
5500	48.6	5.65	3.52	3.52	3.52	0.50	1.90	± 13.1 %
5600	48.5	5.77	3.47	3.47	3.47	0.50	1.90	± 13.1 %
5800	48.2	6.00	3.57	3.57	3.57	0.50	1.90	± 13.1 %

^C Frequency validity above 300 MHz of ± 100 MHz only applies for DASY v4.4 and higher (see Page 2), else it is restricted to ± 50 MHz. The uncertainty is the RSS of the ConvF uncertainty at calibration frequency and the uncertainty for the indicated frequency band. Frequency validity below 300 MHz is ± 10, 25, 40, 50 and 70 MHz for ConvF assessments at 30, 64, 128, 150 and 220 MHz respectively. Above 5 GHz frequency validity can be extended to ± 110 MHz.

^F At frequencies below 3 GHz, the validity of tissue parameters (ϵ and σ) can be relaxed to ± 10% if liquid compensation formula is applied to measured SAR values. At frequencies above 3 GHz, the validity of tissue parameters (ϵ and σ) is restricted to ± 5%. The uncertainty is the RSS of the ConvF uncertainty for indicated target tissue parameters.

^G Alpha/Depth are determined during calibration. SPEAG warrants that the remaining deviation due to the boundary effect after compensation is always less than ± 1% for frequencies below 3 GHz and below ± 2% for frequencies between 3-6 GHz at any distance larger than half the probe tip diameter from the boundary.

Frequency Response of E-Field

(TEM-Cell:ifi110 EXX, Waveguide: R22)

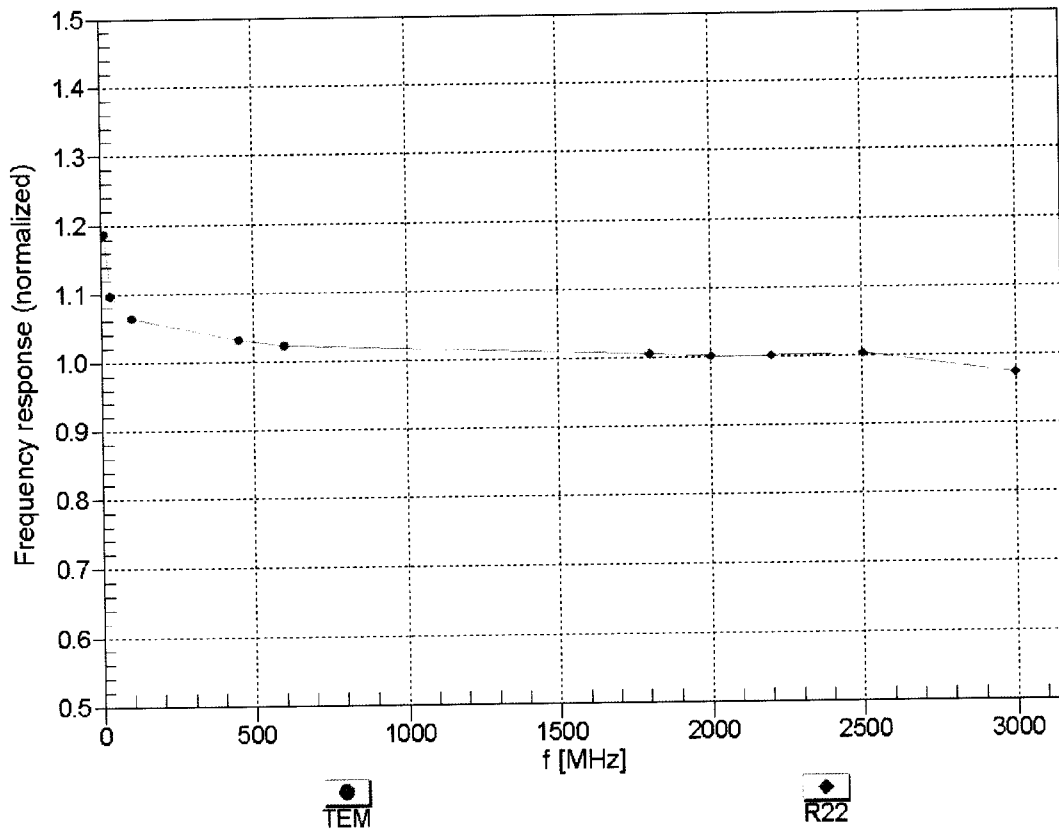

Uncertainty of Frequency Response of E-field: $\pm 6.3\%$ (k=2)

Receiving Pattern (ϕ), $\vartheta = 0^\circ$

f=600 MHz, TEM

f=1800 MHz, R22

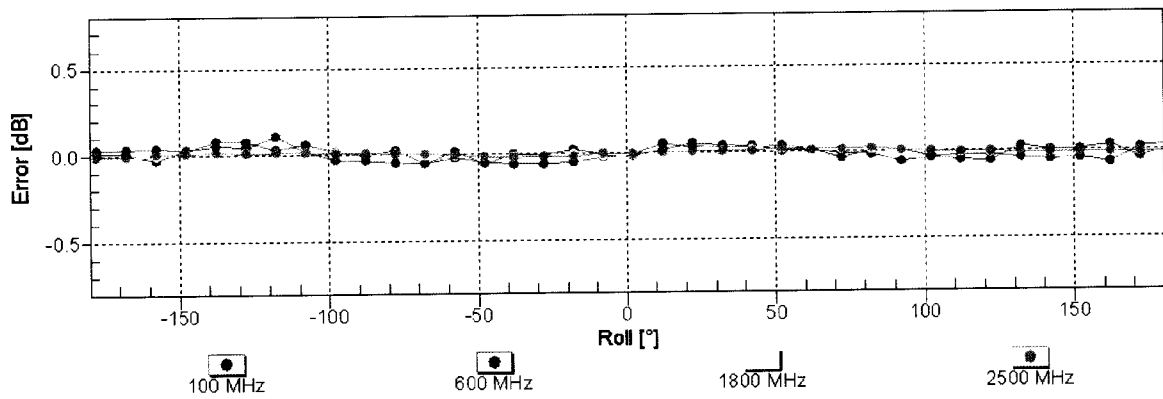
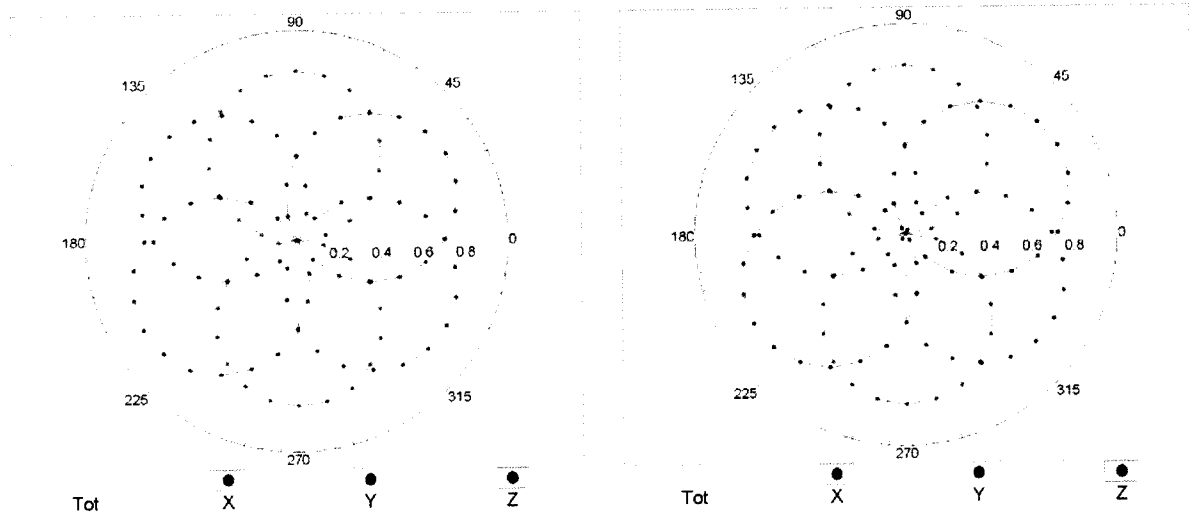

Uncertainty of Axial Isotropy Assessment: $\pm 0.5\%$ (k=2)

Dynamic Range f(SAR_{head}) (TEM cell , f_{eval}= 1900 MHz)

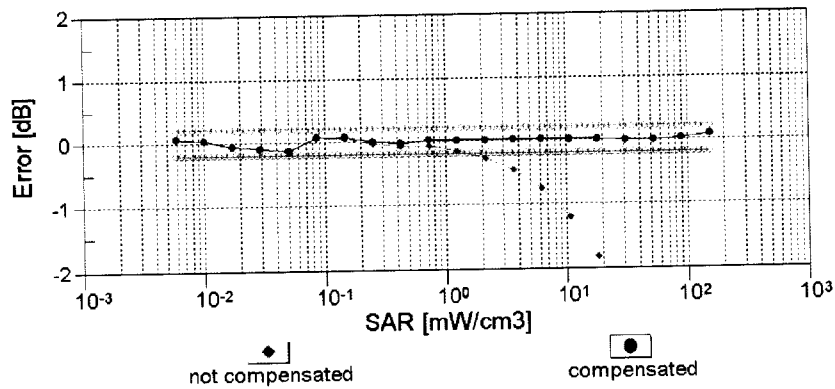
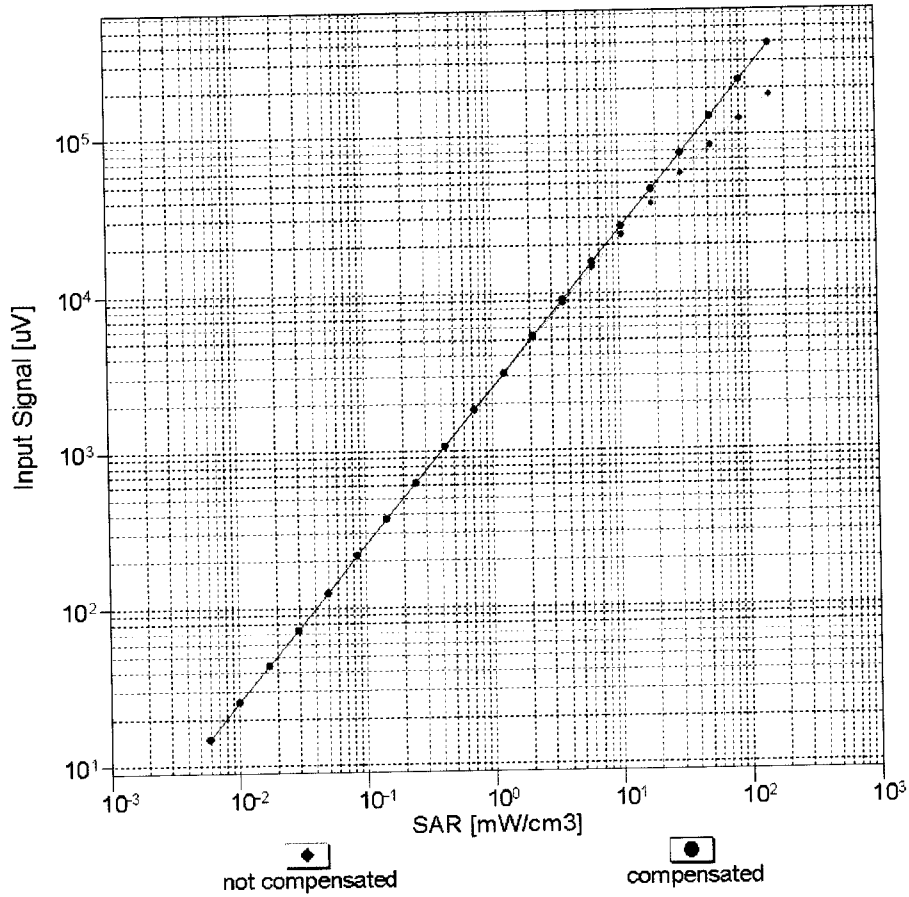

Uncertainty of Linearity Assessment: ± 0.6% (k=2)

Conversion Factor Assessment

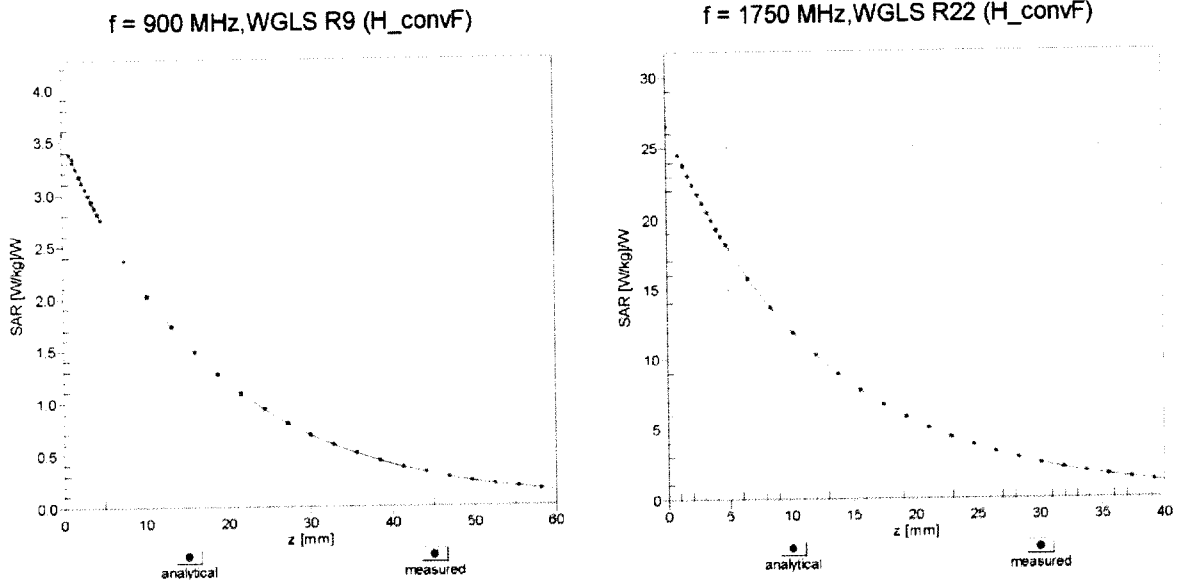

Deviation from Isotropy in Liquid Error (ϕ, ϑ), f = 900 MHz

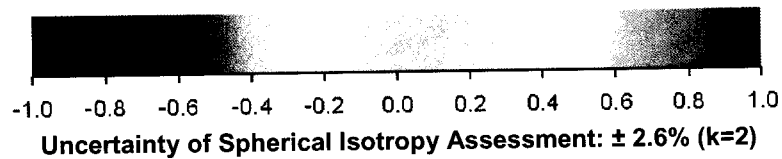
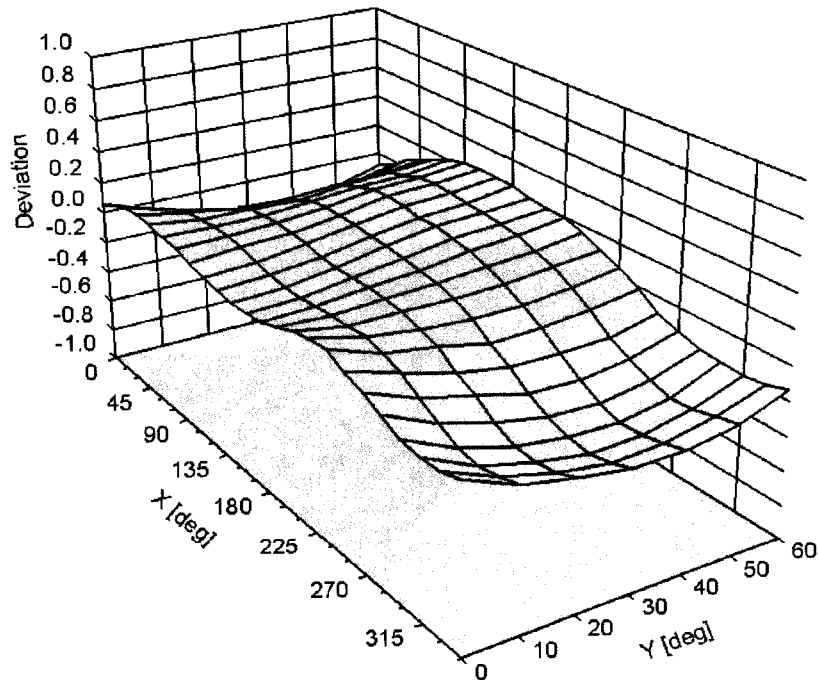

DASY/EASY - Parameters of Probe: EX3DV4 - SN:3833

Other Probe Parameters

Sensor Arrangement	Triangular
Connector Angle (°)	12.2
Mechanical Surface Detection Mode	enabled
Optical Surface Detection Mode	disabled
Probe Overall Length	337 mm
Probe Body Diameter	10 mm
Tip Length	9 mm
Tip Diameter	2.5 mm
Probe Tip to Sensor X Calibration Point	1 mm
Probe Tip to Sensor Y Calibration Point	1 mm
Probe Tip to Sensor Z Calibration Point	1 mm
Recommended Measurement Distance from Surface	1.4 mm

Appendix E – Dipole Calibration Data Sheets



Accredited by the Swiss Accreditation Service (SAS)
The Swiss Accreditation Service is one of the signatories to the EA
Multilateral Agreement for the recognition of calibration certificates

Accreditation No.: **SCS 108**

Client **RF Exposure Lab**

Certificate No: **D750V3-1016_Dec12**

CALIBRATION CERTIFICATE

Object **D750V3 - SN: 1016**

Calibration procedure(s) **QA CAL-05.v8
Calibration procedure for dipole validation kits above 700 MHz**

Calibration date: **December 03, 2012**

This calibration certificate documents the traceability to national standards, which realize the physical units of measurements (SI).
The measurements and the uncertainties with confidence probability are given on the following pages and are part of the certificate.

All calibrations have been conducted in the closed laboratory facility: environment temperature (22 ± 3)°C and humidity < 70%.

Calibration Equipment used (M&TE critical for calibration)

Primary Standards	ID #	Cal Date (Certificate No.)	Scheduled Calibration
Power meter EPM-442A	GB37480704	01-Nov-12 (No. 217-01640)	Oct-13
Power sensor HP 8481A	US37292783	01-Nov-12 (No. 217-01640)	Oct-13
Reference 20 dB Attenuator	SN: 5058 (20k)	27-Mar-12 (No. 217-01530)	Apr-13
Type-N mismatch combination	SN: 5047.3 / 06327	27-Mar-12 (No. 217-01533)	Apr-13
Reference Probe ES3DV3	SN: 3205	30-Dec-11 (No. ES3-3205_Dec11)	Dec-12
DAE4	SN: 601	27-Jun-12 (No. DAE4-601_Jun12)	Jun-13
Secondary Standards	ID #	Check Date (in house)	Scheduled Check
Power sensor HP 8481A	MY41092317	18-Oct-02 (in house check Oct-11)	In house check: Oct-13
RF generator R&S SMT-06	100005	04-Aug-99 (in house check Oct-11)	In house check: Oct-13
Network Analyzer HP 8753E	US37390585 S4206	18-Oct-01 (in house check Oct-12)	In house check: Oct-13

Calibrated by: **Israe El-Naouq** Name: **Israe El-Naouq** Function: **Laboratory Technician**

Approved by: **Katja Pokovic** Name: **Katja Pokovic** Function: **Technical Manager**

Signature
Israe El-Naouq
Katja Pokovic

Issued: December 3, 2012

This calibration certificate shall not be reproduced except in full without written approval of the laboratory.



Accredited by the Swiss Accreditation Service (SAS)
The Swiss Accreditation Service is one of the signatories to the EA
Multilateral Agreement for the recognition of calibration certificates

Accreditation No.: **SCS 108**

Glossary:

TSL	tissue simulating liquid
ConvF	sensitivity in TSL / NORM x,y,z
N/A	not applicable or not measured

Calibration is Performed According to the Following Standards:

- IEEE Std 1528-2003, "IEEE Recommended Practice for Determining the Peak Spatial-Averaged Specific Absorption Rate (SAR) in the Human Head from Wireless Communications Devices: Measurement Techniques", December 2003
- IEC 62209-1, "Procedure to measure the Specific Absorption Rate (SAR) for hand-held devices used in close proximity to the ear (frequency range of 300 MHz to 3 GHz)", February 2005
- Federal Communications Commission Office of Engineering & Technology (FCC OET), "Evaluating Compliance with FCC Guidelines for Human Exposure to Radiofrequency Electromagnetic Fields; Additional Information for Evaluating Compliance of Mobile and Portable Devices with FCC Limits for Human Exposure to Radiofrequency Emissions", Supplement C (Edition 01-01) to Bulletin 65

Additional Documentation:

- DASY4/5 System Handbook

Methods Applied and Interpretation of Parameters:

- Measurement Conditions:** Further details are available from the Validation Report at the end of the certificate. All figures stated in the certificate are valid at the frequency indicated.
- Antenna Parameters with TSL:** The dipole is mounted with the spacer to position its feed point exactly below the center marking of the flat phantom section, with the arms oriented parallel to the body axis.
- Feed Point Impedance and Return Loss:** These parameters are measured with the dipole positioned under the liquid filled phantom. The impedance stated is transformed from the measurement at the SMA connector to the feed point. The Return Loss ensures low reflected power. No uncertainty required.
- Electrical Delay:** One-way delay between the SMA connector and the antenna feed point. No uncertainty required.
- SAR measured:** SAR measured at the stated antenna input power.
- SAR normalized:** SAR as measured, normalized to an input power of 1 W at the antenna connector.
- SAR for nominal TSL parameters:** The measured TSL parameters are used to calculate the nominal SAR result.

The reported uncertainty of measurement is stated as the standard uncertainty of measurement multiplied by the coverage factor $k=2$, which for a normal distribution corresponds to a coverage probability of approximately 95%.

Measurement Conditions

DASY system configuration, as far as not given on page 1.

DASY Version	DASY5	V52.8.3
Extrapolation	Advanced Extrapolation	
Phantom	Modular Flat Phantom	
Distance Dipole Center - TSL	15 mm	with Spacer
Zoom Scan Resolution	dx, dy, dz = 5 mm	
Frequency	750 MHz \pm 1 MHz	

Head TSL parameters

The following parameters and calculations were applied.

	Temperature	Permittivity	Conductivity
Nominal Head TSL parameters	22.0 °C	41.9	0.89 mho/m
Measured Head TSL parameters	(22.0 \pm 0.2) °C	41.6 \pm 6 %	0.89 mho/m \pm 6 %
Head TSL temperature change during test	< 0.5 °C	----	----

SAR result with Head TSL

SAR averaged over 1 cm³ (1 g) of Head TSL	Condition	
SAR measured	250 mW input power	2.10 W/kg
SAR for nominal Head TSL parameters	normalized to 1W	8.39 W/kg \pm 17.0 % (k=2)

SAR averaged over 10 cm³ (10 g) of Head TSL	condition	
SAR measured	250 mW input power	1.37 W/kg
SAR for nominal Head TSL parameters	normalized to 1W	5.47 W/kg \pm 16.5 % (k=2)

Body TSL parameters

The following parameters and calculations were applied.

	Temperature	Permittivity	Conductivity
Nominal Body TSL parameters	22.0 °C	55.5	0.96 mho/m
Measured Body TSL parameters	(22.0 \pm 0.2) °C	54.6 \pm 6 %	0.97 mho/m \pm 6 %
Body TSL temperature change during test	< 0.5 °C	----	----

SAR result with Body TSL

SAR averaged over 1 cm³ (1 g) of Body TSL	Condition	
SAR measured	250 mW input power	2.21 W/kg
SAR for nominal Body TSL parameters	normalized to 1W	8.74 W/kg \pm 17.0 % (k=2)

SAR averaged over 10 cm³ (10 g) of Body TSL	condition	
SAR measured	250 mW input power	1.46 W/kg
SAR for nominal Body TSL parameters	normalized to 1W	5.79 W/kg \pm 16.5 % (k=2)

Appendix

Antenna Parameters with Head TSL

Impedance, transformed to feed point	54.2 Ω + 0.3 j Ω
Return Loss	- 27.9 dB

Antenna Parameters with Body TSL

Impedance, transformed to feed point	50.0 Ω - 1.2 j Ω
Return Loss	- 38.1 dB

General Antenna Parameters and Design

Electrical Delay (one direction)	1.037 ns
----------------------------------	----------

After long term use with 100W radiated power, only a slight warming of the dipole near the feedpoint can be measured.

The dipole is made of standard semirigid coaxial cable. The center conductor of the feeding line is directly connected to the second arm of the dipole. The antenna is therefore short-circuited for DC-signals. On some of the dipoles, small end caps are added to the dipole arms in order to improve matching when loaded according to the position as explained in the "Measurement Conditions" paragraph. The SAR data are not affected by this change. The overall dipole length is still according to the Standard.

No excessive force must be applied to the dipole arms, because they might bend or the soldered connections near the feedpoint may be damaged.

Additional EUT Data

Manufactured by	SPEAG
Manufactured on	March 22, 2010

DASY5 Validation Report for Head TSL

Date: 03.12.2012

Test Laboratory: SPEAG, Zurich, Switzerland

DUT: Dipole 750 MHz; Type: D750V3; Serial: D750V3 - SN: 1016

Communication System: CW; Frequency: 750 MHz

Medium parameters used: $f = 750$ MHz; $\sigma = 0.89$ mho/m; $\epsilon_r = 41.6$; $\rho = 1000$ kg/m³

Phantom section: Flat Section

Measurement Standard: DASY5 (IEEE/IEC/ANSI C63.19-2007)

DASY52 Configuration:

- Probe: ES3DV3 - SN3205; ConvF(6.33, 6.33, 6.33); Calibrated: 30.12.2011;
- Sensor-Surface: 3mm (Mechanical Surface Detection)
- Electronics: DAE4 Sn601; Calibrated: 27.06.2012
- Phantom: Flat Phantom 4.9L; Type: QD000P49AA; Serial: 1001
- DASY52 52.8.3(988); SEMCAD X 14.6.7(6848)

Dipole Calibration for Head Tissue/Pin=250 mW, d=15mm/Zoom Scan (7x7x7)/Cube 0:

Measurement grid: dx=5mm, dy=5mm, dz=5mm

Reference Value = 52.855 V/m; Power Drift = -0.00 dB

Peak SAR (extrapolated) = 3.19 W/kg

SAR(1 g) = 2.1 W/kg; SAR(10 g) = 1.37 W/kg

Maximum value of SAR (measured) = 2.44 W/kg

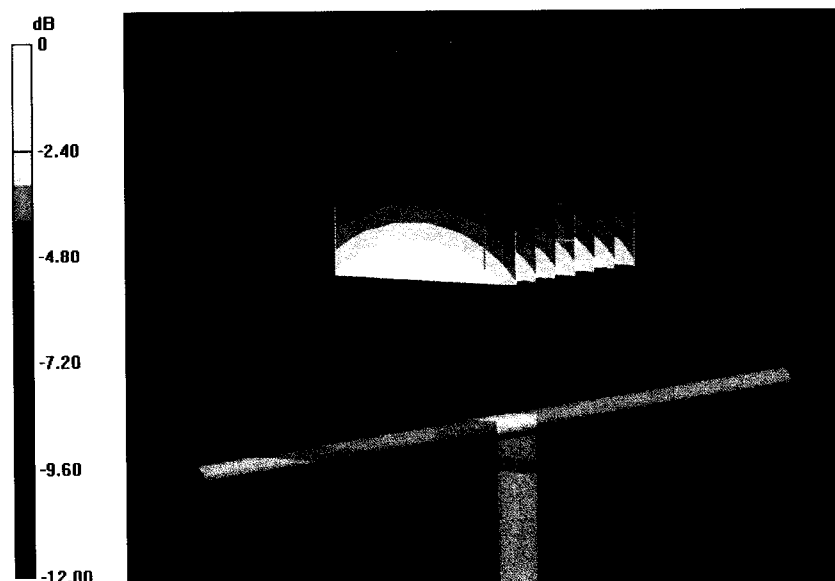

0 dB = 2.44 W/kg = 3.87 dBW/kg

Impedance Measurement Plot for Head TSL

3 Dec 2012 14:21:23
[CH1] S11 1 U FS 1: 54.178 Ω 0.2598 Ω 55.124 μ H 750.000 000 MHz

*
De1
Cor
Avg
16
H1d

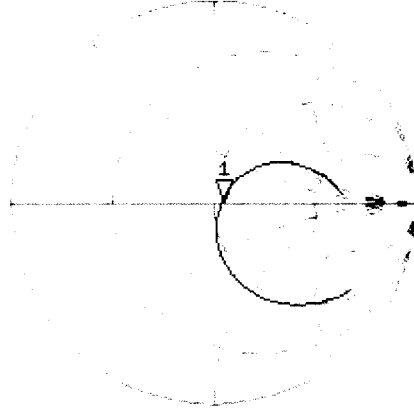

CH2 S11 LOG 5 dB/REF -20 dB 1: -27.912 dB 750.000 000 MHz

Cor
Avg
16
H1d

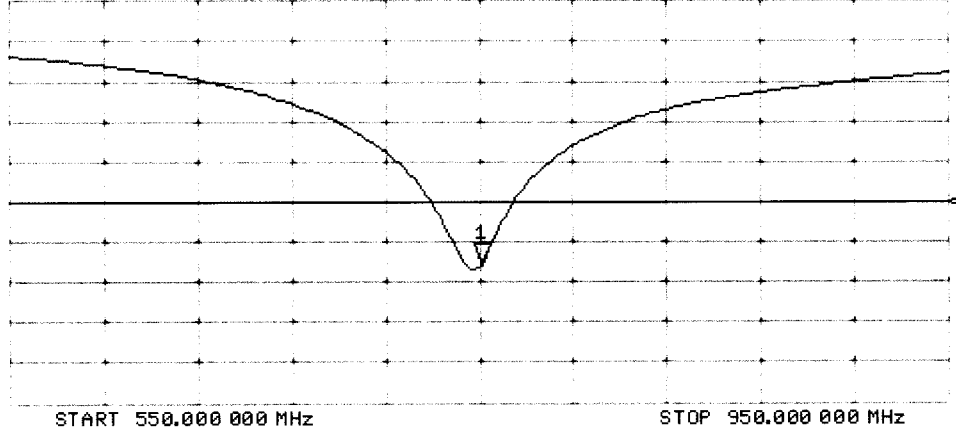

DASY5 Validation Report for Body TSL

Date: 03.12.2012

Test Laboratory: SPEAG, Zurich, Switzerland

DUT: Dipole 750 MHz; Type: D750V3; Serial: D750V3 - SN: 1016

Communication System: CW; Frequency: 750 MHz

Medium parameters used: $f = 750$ MHz; $\sigma = 0.97$ mho/m; $\epsilon_r = 54.6$; $\rho = 1000$ kg/m³

Phantom section: Flat Section

Measurement Standard: DASY5 (IEEE/IEC/ANSI C63.19-2007)

DASY52 Configuration:

- Probe: ES3DV3 - SN3205; ConvF(6.12, 6.12, 6.12); Calibrated: 30.12.2011;
- Sensor-Surface: 3mm (Mechanical Surface Detection)
- Electronics: DAE4 Sn601; Calibrated: 27.06.2012
- Phantom: Flat Phantom 4.9L; Type: QD000P49AA; Serial: 1001
- DASY52 52.8.3(988); SEMCAD X 14.6.7(6848)

Dipole Calibration for Body Tissue/Pin=250 mW, d=15mm/Zoom Scan (7x7x7)/Cube 0:

Measurement grid: dx=5mm, dy=5mm, dz=5mm

Reference Value = 52.855 V/m; Power Drift = -0.00 dB

Peak SAR (extrapolated) = 3.31 W/kg

SAR(1 g) = 2.21 W/kg; SAR(10 g) = 1.46 W/kg

Maximum value of SAR (measured) = 2.56 W/kg

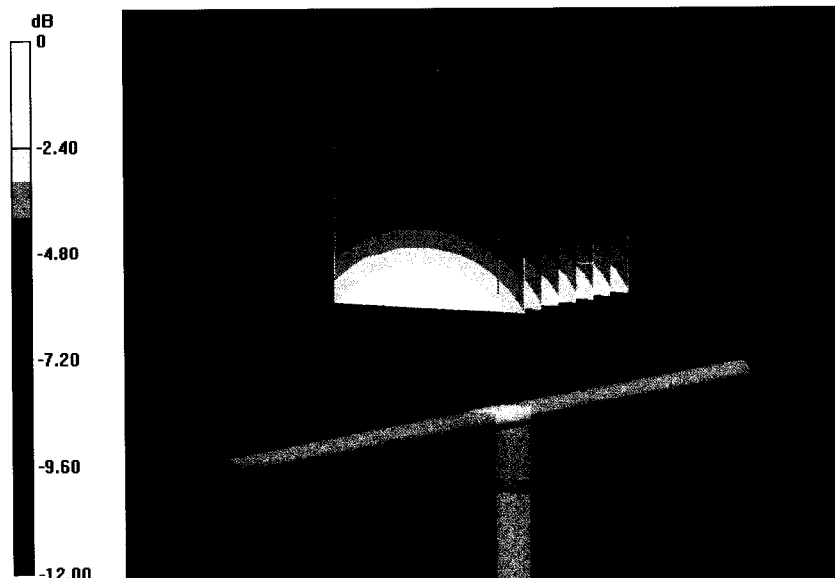

0 dB = 2.56 W/kg = 4.08 dBW/kg

Impedance Measurement Plot for Body TSL

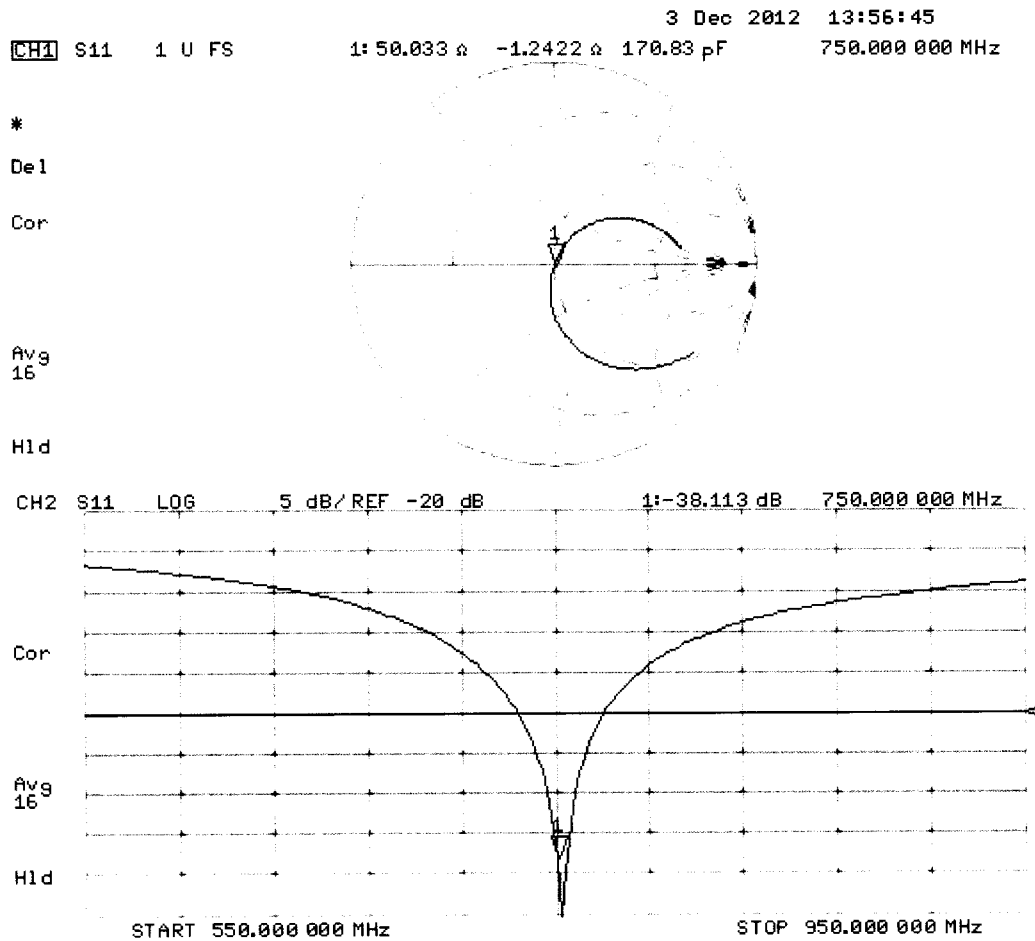

Extended Calibration

Usage of SAR dipoles calibrated less than 2 years ago but more than 1 year ago were confirmed in maintaining return loss (< -20 dB, within 20% of prior calibration) and impedance (within 5 ohm from prior calibration) requirements per extended calibrations in KDB Publication 865664 D01 v01r03.

D750V3 SN: 1016 - Head						
Date of Measurement	Return Loss (dB)	$\Delta\%$	Impedance (Ω)	$\Delta\Omega$	Impedance Imaginary ($j\Omega$)	$\Delta\Omega$
12/3/2012	-27.9		54.2		0.3	
12/4/2013	-28.9	3.6	53.9	-0.3	0.1	-0.2
12/4/2014	-26.5	-5.0	55.6	1.4	0.4	0.1

D750V3 SN: 1016 - Body						
Date of Measurement	Return Loss (dB)	$\Delta\%$	Impedance (Ω)	$\Delta\Omega$	Impedance Imaginary ($j\Omega$)	$\Delta\Omega$
12/3/2012	-38.1		50.0		-1.2	
12/4/2013	-36.7	-3.7	48.7	-1.3	-0.6	0.6
12/4/2014	-37.5	-1.6	49.8	-0.2	-0.9	0.3



Accredited by the Swiss Accreditation Service (SAS)
The Swiss Accreditation Service is one of the signatories to the EA
Multilateral Agreement for the recognition of calibration certificates

Accreditation No.: **SCS 108**

Client **RF Exposure Lab**

Certificate No: **D835V2-4d089_Dec12**

CALIBRATION CERTIFICATE

Object **D835V2 - SN: 4d089**

Calibration procedure(s) **QA CAL-05.v8
Calibration procedure for dipole validation kits above 700 MHz**

Calibration date: **December 03, 2012**

This calibration certificate documents the traceability to national standards, which realize the physical units of measurements (SI).
The measurements and the uncertainties with confidence probability are given on the following pages and are part of the certificate.

All calibrations have been conducted in the closed laboratory facility: environment temperature (22 ± 3)°C and humidity < 70%.

Calibration Equipment used (M&TE critical for calibration)

Primary Standards	ID #	Cal Date (Certificate No.)	Scheduled Calibration
Power meter EPM-442A	GB37480704	01-Nov-12 (No. 217-01640)	Oct-13
Power sensor HP 8481A	US37292783	01-Nov-12 (No. 217-01640)	Oct-13
Reference 20 dB Attenuator	SN: 5058 (20k)	27-Mar-12 (No. 217-01530)	Apr-13
Type-N mismatch combination	SN: 5047.3 / 06327	27-Mar-12 (No. 217-01533)	Apr-13
Reference Probe ES3DV3	SN: 3205	30-Dec-11 (No. ES3-3205_Dec11)	Dec-12
DAE4	SN: 601	27-Jun-12 (No. DAE4-601_Jun12)	Jun-13
Secondary Standards	ID #	Check Date (in house)	Scheduled Check
Power sensor HP 8481A	MY41092317	18-Oct-02 (in house check Oct-11)	In house check: Oct-13
RF generator R&S SMT-06	100005	04-Aug-99 (in house check Oct-11)	In house check: Oct-13
Network Analyzer HP 8753E	US37390585 S4206	18-Oct-01 (in house check Oct-12)	In house check: Oct-13

Calibrated by: **Israe El-Naouq** Name: **Israe El-Naouq** Function: **Laboratory Technician**

Approved by: **Katja Pokovic** Name: **Katja Pokovic** Function: **Technical Manager**

Signature
Israe El-Naouq
Katja Pokovic

Issued: December 3, 2012

This calibration certificate shall not be reproduced except in full without written approval of the laboratory.



Accredited by the Swiss Accreditation Service (SAS)

Accreditation No.: **SCS 108**

The Swiss Accreditation Service is one of the signatories to the EA Multilateral Agreement for the recognition of calibration certificates

Glossary:

TSL	tissue simulating liquid
ConvF	sensitivity in TSL / NORM x,y,z
N/A	not applicable or not measured

Calibration is Performed According to the Following Standards:

- IEEE Std 1528-2003, "IEEE Recommended Practice for Determining the Peak Spatial-Averaged Specific Absorption Rate (SAR) in the Human Head from Wireless Communications Devices: Measurement Techniques", December 2003
- IEC 62209-1, "Procedure to measure the Specific Absorption Rate (SAR) for hand-held devices used in close proximity to the ear (frequency range of 300 MHz to 3 GHz)", February 2005
- Federal Communications Commission Office of Engineering & Technology (FCC OET), "Evaluating Compliance with FCC Guidelines for Human Exposure to Radiofrequency Electromagnetic Fields; Additional Information for Evaluating Compliance of Mobile and Portable Devices with FCC Limits for Human Exposure to Radiofrequency Emissions", Supplement C (Edition 01-01) to Bulletin 65

Additional Documentation:

- DASY4/5 System Handbook

Methods Applied and Interpretation of Parameters:

- Measurement Conditions:** Further details are available from the Validation Report at the end of the certificate. All figures stated in the certificate are valid at the frequency indicated.
- Antenna Parameters with TSL:** The dipole is mounted with the spacer to position its feed point exactly below the center marking of the flat phantom section, with the arms oriented parallel to the body axis.
- Feed Point Impedance and Return Loss:** These parameters are measured with the dipole positioned under the liquid filled phantom. The impedance stated is transformed from the measurement at the SMA connector to the feed point. The Return Loss ensures low reflected power. No uncertainty required.
- Electrical Delay:** One-way delay between the SMA connector and the antenna feed point. No uncertainty required.
- SAR measured:** SAR measured at the stated antenna input power.
- SAR normalized:** SAR as measured, normalized to an input power of 1 W at the antenna connector.
- SAR for nominal TSL parameters:** The measured TSL parameters are used to calculate the nominal SAR result.

The reported uncertainty of measurement is stated as the standard uncertainty of measurement multiplied by the coverage factor $k=2$, which for a normal distribution corresponds to a coverage probability of approximately 95%.

Measurement Conditions

DASY system configuration, as far as not given on page 1.

DASY Version	DASY5	V52.8.3
Extrapolation	Advanced Extrapolation	
Phantom	Modular Flat Phantom	
Distance Dipole Center - TSL	15 mm	with Spacer
Zoom Scan Resolution	dx, dy, dz = 5 mm	
Frequency	835 MHz \pm 1 MHz	

Head TSL parameters

The following parameters and calculations were applied.

	Temperature	Permittivity	Conductivity
Nominal Head TSL parameters	22.0 °C	41.5	0.90 mho/m
Measured Head TSL parameters	(22.0 \pm 0.2) °C	41.4 \pm 6 %	0.92 mho/m \pm 6 %
Head TSL temperature change during test	< 0.5 °C	----	----

SAR result with Head TSL

SAR averaged over 1 cm³ (1 g) of Head TSL	Condition	
SAR measured	250 mW input power	2.38 W/kg
SAR for nominal Head TSL parameters	normalized to 1W	9.36 W/kg \pm 17.0 % (k=2)

SAR averaged over 10 cm³ (10 g) of Head TSL	condition	
SAR measured	250 mW input power	1.55 W/kg
SAR for nominal Head TSL parameters	normalized to 1W	6.12 W/kg \pm 16.5 % (k=2)

Body TSL parameters

The following parameters and calculations were applied.

	Temperature	Permittivity	Conductivity
Nominal Body TSL parameters	22.0 °C	55.2	0.97 mho/m
Measured Body TSL parameters	(22.0 \pm 0.2) °C	54.5 \pm 6 %	0.99 mho/m \pm 6 %
Body TSL temperature change during test	< 0.5 °C	----	----

SAR result with Body TSL

SAR averaged over 1 cm³ (1 g) of Body TSL	Condition	
SAR measured	250 mW input power	2.42 W/kg
SAR for nominal Body TSL parameters	normalized to 1W	9.51 W/kg \pm 17.0 % (k=2)

SAR averaged over 10 cm³ (10 g) of Body TSL	condition	
SAR measured	250 mW input power	1.59 W/kg
SAR for nominal Body TSL parameters	normalized to 1W	6.27 W/kg \pm 16.5 % (k=2)

Appendix

Antenna Parameters with Head TSL

Impedance, transformed to feed point	51.7 Ω - 2.5 j Ω
Return Loss	- 30.5 dB

Antenna Parameters with Body TSL

Impedance, transformed to feed point	47.4 Ω - 4.8 j Ω
Return Loss	- 25.0 dB

General Antenna Parameters and Design

Electrical Delay (one direction)	1.391 ns
----------------------------------	----------

After long term use with 100W radiated power, only a slight warming of the dipole near the feedpoint can be measured.

The dipole is made of standard semirigid coaxial cable. The center conductor of the feeding line is directly connected to the second arm of the dipole. The antenna is therefore short-circuited for DC-signals. On some of the dipoles, small end caps are added to the dipole arms in order to improve matching when loaded according to the position as explained in the "Measurement Conditions" paragraph. The SAR data are not affected by this change. The overall dipole length is still according to the Standard.

No excessive force must be applied to the dipole arms, because they might bend or the soldered connections near the feedpoint may be damaged.

Additional EUT Data

Manufactured by	SPEAG
Manufactured on	October 17, 2008

DASY5 Validation Report for Head TSL

Date: 03.12.2012

Test Laboratory: SPEAG, Zurich, Switzerland

DUT: Dipole 835 MHz; Type: D835V2; Serial: D835V2 - SN: 4d089

Communication System: CW; Frequency: 835 MHz

Medium parameters used: $f = 835$ MHz; $\sigma = 0.92$ mho/m; $\epsilon_r = 41.4$; $\rho = 1000$ kg/m³

Phantom section: Flat Section

Measurement Standard: DASY5 (IEEE/IEC/ANSI C63.19-2007)

DASY52 Configuration:

- Probe: ES3DV3 - SN3205; ConvF(6.07, 6.07, 6.07); Calibrated: 30.12.2011;
- Sensor-Surface: 3mm (Mechanical Surface Detection)
- Electronics: DAE4 Sn601; Calibrated: 27.06.2012
- Phantom: Flat Phantom 4.9L; Type: QD000P49AA; Serial: 1001
- DASY52 52.8.3(988); SEMCAD X 14.6.7(6848)

Dipole Calibration for Head Tissue/Pin=250 mW, d=15mm/Zoom Scan (7x7x7)/Cube 0:

Measurement grid: dx=5mm, dy=5mm, dz=5mm

Reference Value = 56.782 V/m; Power Drift = -0.01 dB

Peak SAR (extrapolated) = 3.58 W/kg

SAR(1 g) = 2.38 W/kg; SAR(10 g) = 1.55 W/kg

Maximum value of SAR (measured) = 2.79 W/kg

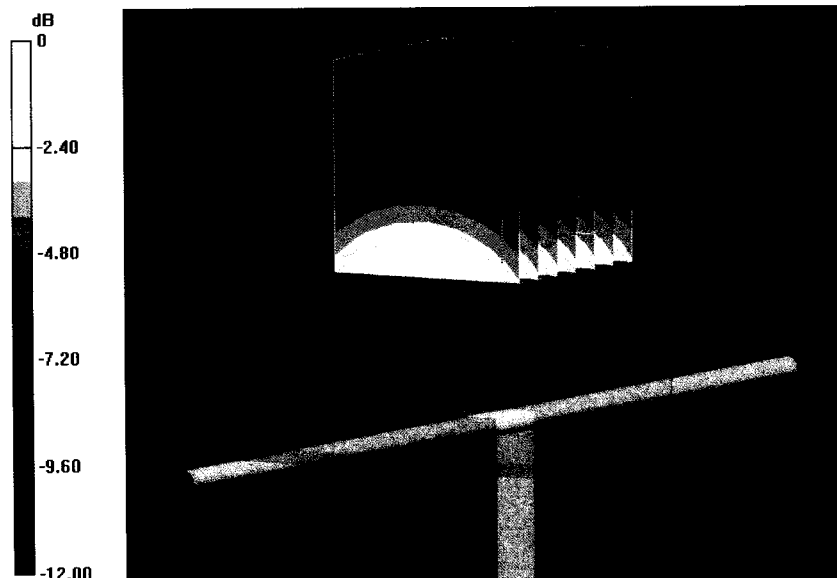

0 dB = 2.79 W/kg = 4.46 dBW/kg

Impedance Measurement Plot for Head TSL

3 Dec 2012 14:31:39

CH1 S11 1 U FS 1: 51.703 Ω -2.4961 Ω 76.361 pF 835.000 000 MHz

*
De1
Cor

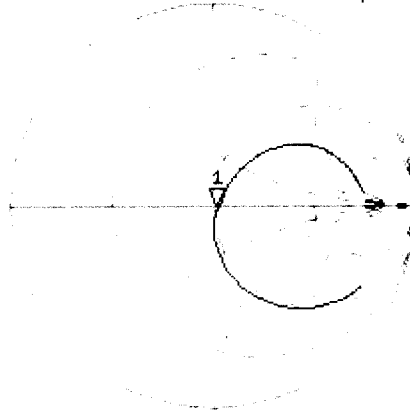

Avg
16

H1d

CH2 S11 LOG 5 dB/REF -20 dB 1: -30.528 dB 835.000 000 MHz

Cor

Avg
16

H1d

START 635.000 000 MHz

STOP 1 100.000 000 MHz

DASY5 Validation Report for Body TSL

Date: 03.12.2012

Test Laboratory: SPEAG, Zurich, Switzerland

DUT: Dipole 835 MHz; Type: D835V2; Serial: D835V2 - SN: 4d089

Communication System: CW; Frequency: 835 MHz

Medium parameters used: $f = 835$ MHz; $\sigma = 0.99$ mho/m; $\epsilon_r = 54.5$; $\rho = 1000$ kg/m³

Phantom section: Flat Section

Measurement Standard: DASY5 (IEEE/IEC/ANSI C63.19-2007)

DASY52 Configuration:

- Probe: ES3DV3 - SN3205; ConvF(6.02, 6.02, 6.02); Calibrated: 30.12.2011;
- Sensor-Surface: 3mm (Mechanical Surface Detection)
- Electronics: DAE4 Sn601; Calibrated: 27.06.2012
- Phantom: Flat Phantom 4.9L; Type: QD000P49AA; Serial: 1001
- DASY52 52.8.3(988); SEMCAD X 14.6.7(6848)

Dipole Calibration for Body Tissue/Pin=250 mW, d=15mm/Zoom Scan (7x7x7)/Cube 0:

Measurement grid: dx=5mm, dy=5mm, dz=5mm

Reference Value = 55.384 V/m; Power Drift = -0.01 dB

Peak SAR (extrapolated) = 3.54 W/kg

SAR(1 g) = 2.42 W/kg; SAR(10 g) = 1.59 W/kg

Maximum value of SAR (measured) = 2.82 W/kg

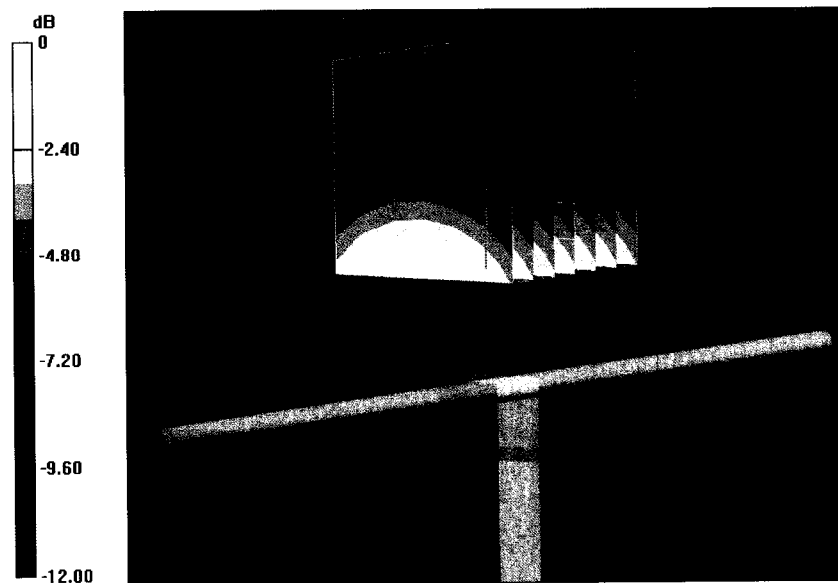

0 dB = 2.82 W/kg = 4.50 dBW/kg

Impedance Measurement Plot for Body TSL

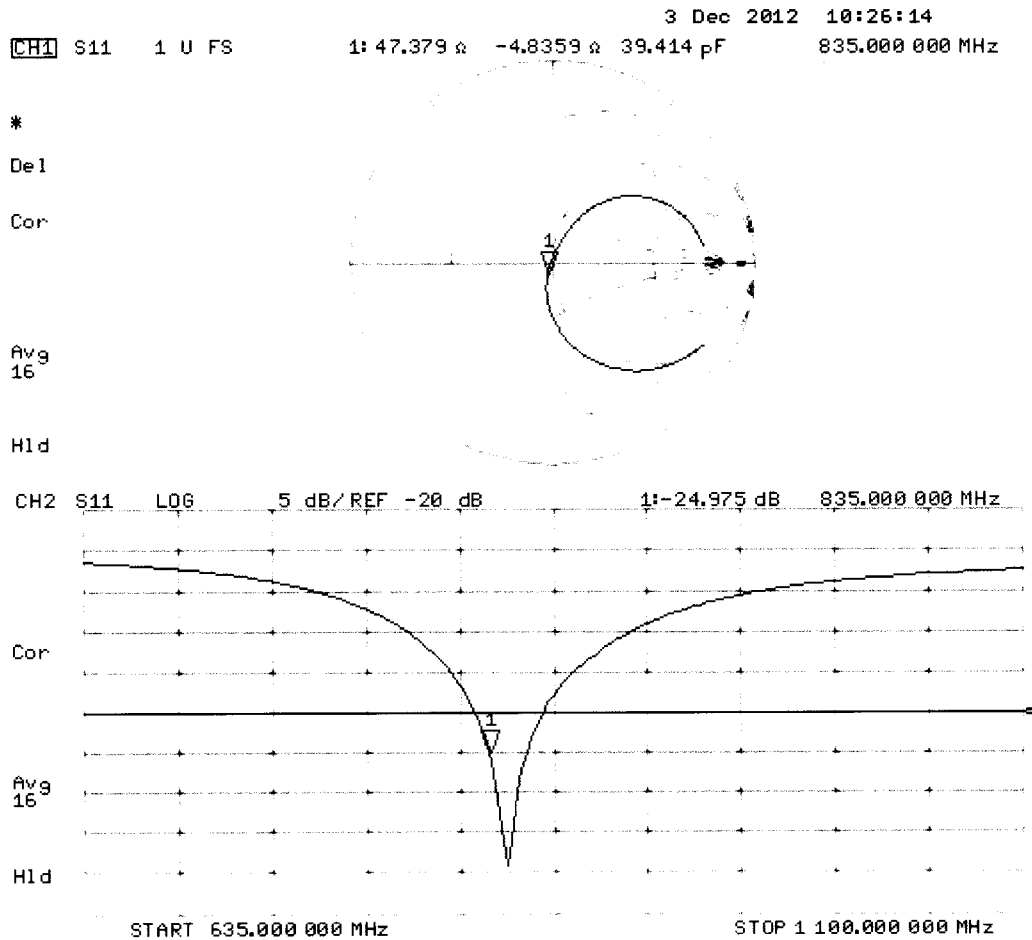

Extended Calibration

Usage of SAR dipoles calibrated less than 2 years ago but more than 1 year ago were confirmed in maintaining return loss (< -20 dB, within 20% of prior calibration) and impedance (within 5 ohm from prior calibration) requirements per extended calibrations in KDB Publication 865664 D01 v01r03.

D835V2 SN: 4d089 - Head						
Date of Measurement	Return Loss (dB)	$\Delta\%$	Impedance (Ω)	$\Delta\Omega$	Impedance Imaginary ($j\Omega$)	$\Delta\Omega$
12/3/2012	-30.5		51.7		-2.5	
12/4/2013	-28.7	-5.9	52.4	0.7	-1.5	1.0
12/4/2014	-29.2	-4.3	50.7	-1.0	-1.2	1.3

D835V2 SN: 4d089 - Body						
Date of Measurement	Return Loss (dB)	$\Delta\%$	Impedance (Ω)	$\Delta\Omega$	Impedance Imaginary ($j\Omega$)	$\Delta\Omega$
12/3/2012	-25.0		47.4		-4.8	
12/4/2013	-24.6	-1.6	48.2	0.8	-5.2	-0.4
12/4/2014	-26.7	6.8	46.3	-1.1	-3.7	1.1



Accredited by the Swiss Accreditation Service (SAS)
The Swiss Accreditation Service is one of the signatories to the EA
Multilateral Agreement for the recognition of calibration certificates

Accreditation No.: **SCS 108**

Client **RF Exposure Lab**

Certificate No: **D1750V2-1018_Dec12**

CALIBRATION CERTIFICATE

Object **D1750V2 - SN: 1018**

Calibration procedure(s) **QA CAL-05.v8**
Calibration procedure for dipole validation kits above 700 MHz

Calibration date: **December 05, 2012**

This calibration certificate documents the traceability to national standards, which realize the physical units of measurements (SI).
The measurements and the uncertainties with confidence probability are given on the following pages and are part of the certificate.

All calibrations have been conducted in the closed laboratory facility: environment temperature (22 ± 3)°C and humidity < 70%.

Calibration Equipment used (M&TE critical for calibration)

Primary Standards	ID #	Cal Date (Certificate No.)	Scheduled Calibration
Power meter EPM-442A	GB37480704	01-Nov-12 (No. 217-01640)	Oct-13
Power sensor HP 8481A	US37292783	01-Nov-12 (No. 217-01640)	Oct-13
Reference 20 dB Attenuator	SN: 5058 (20k)	27-Mar-12 (No. 217-01530)	Apr-13
Type-N mismatch combination	SN: 5047.3 / 06327	27-Mar-12 (No. 217-01533)	Apr-13
Reference Probe ES3DV3	SN: 3205	30-Dec-11 (No. ES3-3205_Dec11)	Dec-12
DAE4	SN: 601	27-Jun-12 (No. DAE4-601_Jun12)	Jun-13
Secondary Standards	ID #	Check Date (in house)	Scheduled Check
Power sensor HP 8481A	MY41092317	18-Oct-02 (in house check Oct-11)	In house check: Oct-13
RF generator R&S SMT-06	100005	04-Aug-99 (in house check Oct-11)	In house check: Oct-13
Network Analyzer HP 8753E	US37390585 S4206	18-Oct-01 (in house check Oct-12)	In house check: Oct-13

	Name	Function	Signature
Calibrated by:	Israe El-Naouq	Laboratory Technician	
Approved by:	Katja Pokovic	Technical Manager	

Issued: December 5, 2012

This calibration certificate shall not be reproduced except in full without written approval of the laboratory.



Accredited by the Swiss Accreditation Service (SAS)

Accreditation No.: **SCS 108**

The Swiss Accreditation Service is one of the signatories to the EA Multilateral Agreement for the recognition of calibration certificates

Glossary:

TSL	tissue simulating liquid
ConvF	sensitivity in TSL / NORM x,y,z
N/A	not applicable or not measured

Calibration is Performed According to the Following Standards:

- IEEE Std 1528-2003, "IEEE Recommended Practice for Determining the Peak Spatial-Averaged Specific Absorption Rate (SAR) in the Human Head from Wireless Communications Devices: Measurement Techniques", December 2003
- IEC 62209-1, "Procedure to measure the Specific Absorption Rate (SAR) for hand-held devices used in close proximity to the ear (frequency range of 300 MHz to 3 GHz)", February 2005
- Federal Communications Commission Office of Engineering & Technology (FCC OET), "Evaluating Compliance with FCC Guidelines for Human Exposure to Radiofrequency Electromagnetic Fields; Additional Information for Evaluating Compliance of Mobile and Portable Devices with FCC Limits for Human Exposure to Radiofrequency Emissions", Supplement C (Edition 01-01) to Bulletin 65

Additional Documentation:

- DASY4/5 System Handbook

Methods Applied and Interpretation of Parameters:

- Measurement Conditions:** Further details are available from the Validation Report at the end of the certificate. All figures stated in the certificate are valid at the frequency indicated.
- Antenna Parameters with TSL:** The dipole is mounted with the spacer to position its feed point exactly below the center marking of the flat phantom section, with the arms oriented parallel to the body axis.
- Feed Point Impedance and Return Loss:** These parameters are measured with the dipole positioned under the liquid filled phantom. The impedance stated is transformed from the measurement at the SMA connector to the feed point. The Return Loss ensures low reflected power. No uncertainty required.
- Electrical Delay:** One-way delay between the SMA connector and the antenna feed point. No uncertainty required.
- SAR measured:** SAR measured at the stated antenna input power.
- SAR normalized:** SAR as measured, normalized to an input power of 1 W at the antenna connector.
- SAR for nominal TSL parameters:** The measured TSL parameters are used to calculate the nominal SAR result.

The reported uncertainty of measurement is stated as the standard uncertainty of measurement multiplied by the coverage factor $k=2$, which for a normal distribution corresponds to a coverage probability of approximately 95%.

Measurement Conditions

DASY system configuration, as far as not given on page 1.

DASY Version	DASY5	V52.8.3
Extrapolation	Advanced Extrapolation	
Phantom	Modular Flat Phantom	
Distance Dipole Center - TSL	10 mm	with Spacer
Zoom Scan Resolution	dx, dy, dz = 5 mm	
Frequency	1750 MHz ± 1 MHz	

Head TSL parameters

The following parameters and calculations were applied.

	Temperature	Permittivity	Conductivity
Nominal Head TSL parameters	22.0 °C	40.1	1.37 mho/m
Measured Head TSL parameters	(22.0 ± 0.2) °C	39.3 ± 6 %	1.34 mho/m ± 6 %
Head TSL temperature change during test	< 0.5 °C	----	----

SAR result with Head TSL

SAR averaged over 1 cm ³ (1 g) of Head TSL	Condition	
SAR measured	250 mW input power	9.02 W/kg
SAR for nominal Head TSL parameters	normalized to 1W	36.4 W/kg ± 17.0 % (k=2)

SAR averaged over 10 cm ³ (10 g) of Head TSL	condition	
SAR measured	250 mW input power	4.82 W/kg
SAR for nominal Head TSL parameters	normalized to 1W	19.4 W/kg ± 16.5 % (k=2)

Body TSL parameters

The following parameters and calculations were applied.

	Temperature	Permittivity	Conductivity
Nominal Body TSL parameters	22.0 °C	53.4	1.49 mho/m
Measured Body TSL parameters	(22.0 ± 0.2) °C	51.8 ± 6 %	1.47 mho/m ± 6 %
Body TSL temperature change during test	< 0.5 °C	----	----

SAR result with Body TSL

SAR averaged over 1 cm ³ (1 g) of Body TSL	Condition	
SAR measured	250 mW input power	9.30 W/kg
SAR for nominal Body TSL parameters	normalized to 1W	37.3 W/kg ± 17.0 % (k=2)

SAR averaged over 10 cm ³ (10 g) of Body TSL	condition	
SAR measured	250 mW input power	4.99 W/kg
SAR for nominal Body TSL parameters	normalized to 1W	20.0 W/kg ± 16.5 % (k=2)

Appendix

Antenna Parameters with Head TSL

Impedance, transformed to feed point	50.2 Ω + 0.8 j Ω
Return Loss	- 42.2 dB

Antenna Parameters with Body TSL

Impedance, transformed to feed point	46.2 Ω + 0.7 j Ω
Return Loss	- 27.9 dB

General Antenna Parameters and Design

Electrical Delay (one direction)	1.221 ns
----------------------------------	----------

After long term use with 100W radiated power, only a slight warming of the dipole near the feedpoint can be measured.

The dipole is made of standard semirigid coaxial cable. The center conductor of the feeding line is directly connected to the second arm of the dipole. The antenna is therefore short-circuited for DC-signals. On some of the dipoles, small end caps are added to the dipole arms in order to improve matching when loaded according to the position as explained in the "Measurement Conditions" paragraph. The SAR data are not affected by this change. The overall dipole length is still according to the Standard.

No excessive force must be applied to the dipole arms, because they might bend or the soldered connections near the feedpoint may be damaged.

Additional EUT Data

Manufactured by	SPEAG
Manufactured on	February 11, 2009

DASY5 Validation Report for Head TSL

Date: 05.12.2012

Test Laboratory: SPEAG, Zurich, Switzerland

DUT: Dipole 1750 MHz; Type: D1750V2; Serial: D1750V2 - SN: 1018

Communication System: CW; Frequency: 1750 MHz

Medium parameters used: $f = 1750$ MHz; $\sigma = 1.34$ mho/m; $\epsilon_r = 39.3$; $\rho = 1000$ kg/m³

Phantom section: Flat Section

Measurement Standard: DASY5 (IEEE/IEC/ANSI C63.19-2007)

DASY52 Configuration:

- Probe: ES3DV3 - SN3205; ConvF(5.22, 5.22, 5.22); Calibrated: 30.12.2011;
- Sensor-Surface: 3mm (Mechanical Surface Detection)
- Electronics: DAE4 Sn601; Calibrated: 27.06.2012
- Phantom: Flat Phantom 5.0 (front); Type: QD000P50AA; Serial: 1001
- DASY52 52.8.3(988); SEMCAD X 14.6.7(6848)

Dipole Calibration for Head Tissue/Pin=250 mW, d=10mm/Zoom Scan (7x7x7)/Cube 0:

Measurement grid: dx=5mm, dy=5mm, dz=5mm

Reference Value = 92.822 V/m; Power Drift = 0.03 dB

Peak SAR (extrapolated) = 16.0 W/kg

SAR(1 g) = 9.02 W/kg; SAR(10 g) = 4.82 W/kg

Maximum value of SAR (measured) = 11.0 W/kg

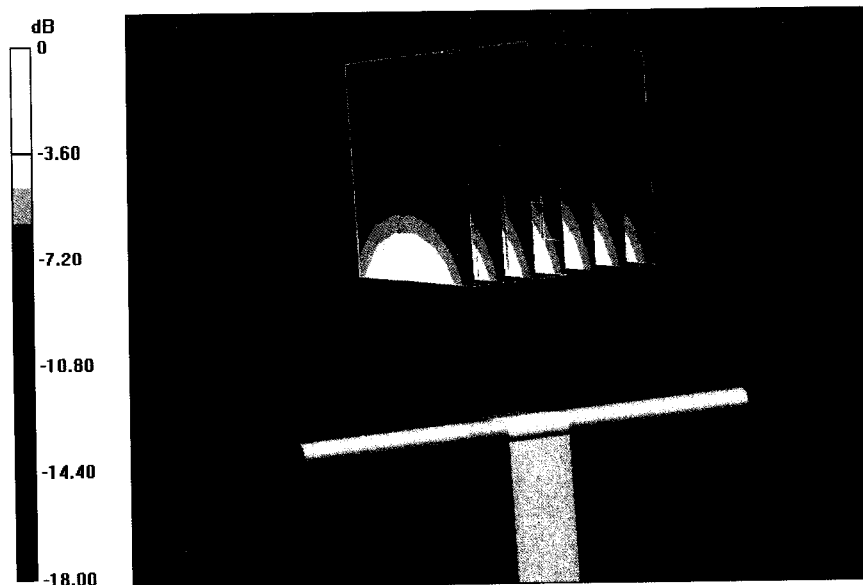

0 dB = 11.0 W/kg = 10.41 dBW/kg

Impedance Measurement Plot for Head TSL

5 Dec 2012 10:32:25

[CH1] S11 1 U FS 1: 50.221 Ω 0.7695 Ω 69.985 μH 1 750.000 000 MHz

*
De1
Cor



Avg
16

H1d

CH2 S11 LOG 5 dB/REF -20 dB 1:-42.240 dB 1 750.000 000 MHz

Cor

Avg
16

H1d

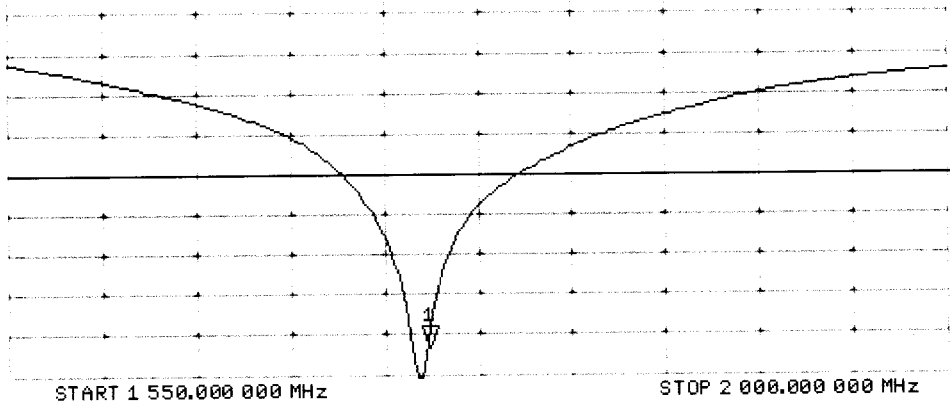

DASY5 Validation Report for Body TSL

Date: 05.12.2012

Test Laboratory: SPEAG, Zurich, Switzerland

DUT: Dipole 1750 MHz; Type: D1750V2; Serial: D1750V2 - SN: 1018

Communication System: CW; Frequency: 1750 MHz

Medium parameters used: $f = 1750$ MHz; $\sigma = 1.47$ mho/m; $\epsilon_r = 51.8$; $\rho = 1000$ kg/m³

Phantom section: Flat Section

Measurement Standard: DASY5 (IEEE/IEC/ANSI C63.19-2007)

DASY52 Configuration:

- Probe: ES3DV3 - SN3205; ConvF(4.85, 4.85, 4.85); Calibrated: 30.12.2011;
- Sensor-Surface: 3mm (Mechanical Surface Detection)
- Electronics: DAE4 Sn601; Calibrated: 27.06.2012
- Phantom: Flat Phantom 5.0 (back); Type: QD000P50AA; Serial: 1002
- DASY52 52.8.3(988); SEMCAD X 14.6.7(6848)

Dipole Calibration for Body Tissue/Pin=250 mW, d=10mm/Zoom Scan (7x7x7)/Cube 0:

Measurement grid: dx=5mm, dy=5mm, dz=5mm

Reference Value = 92.822 V/m; Power Drift = 0.03 dB

Peak SAR (extrapolated) = 16.0 W/kg

SAR(1 g) = 9.3 W/kg; SAR(10 g) = 4.99 W/kg

Maximum value of SAR (measured) = 11.7 W/kg

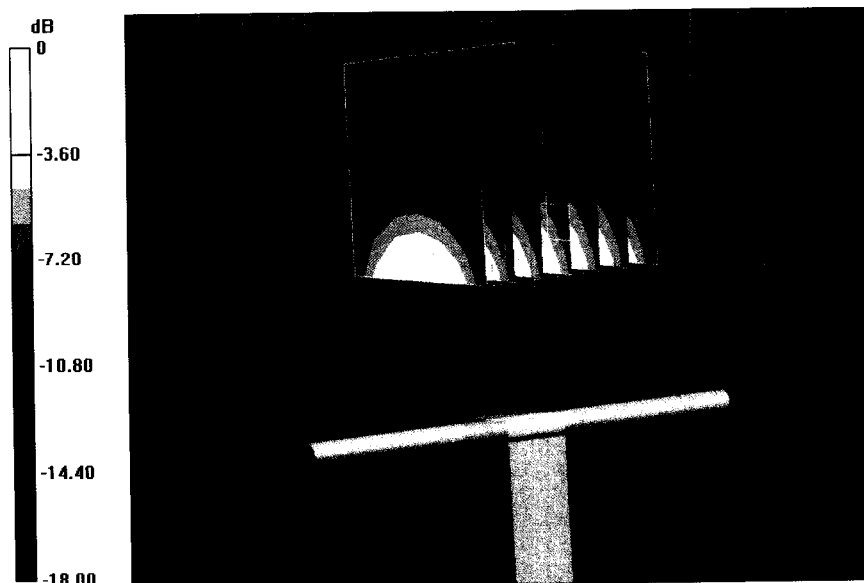

0 dB = 11.7 W/kg = 10.68 dBW/kg

Impedance Measurement Plot for Body TSL

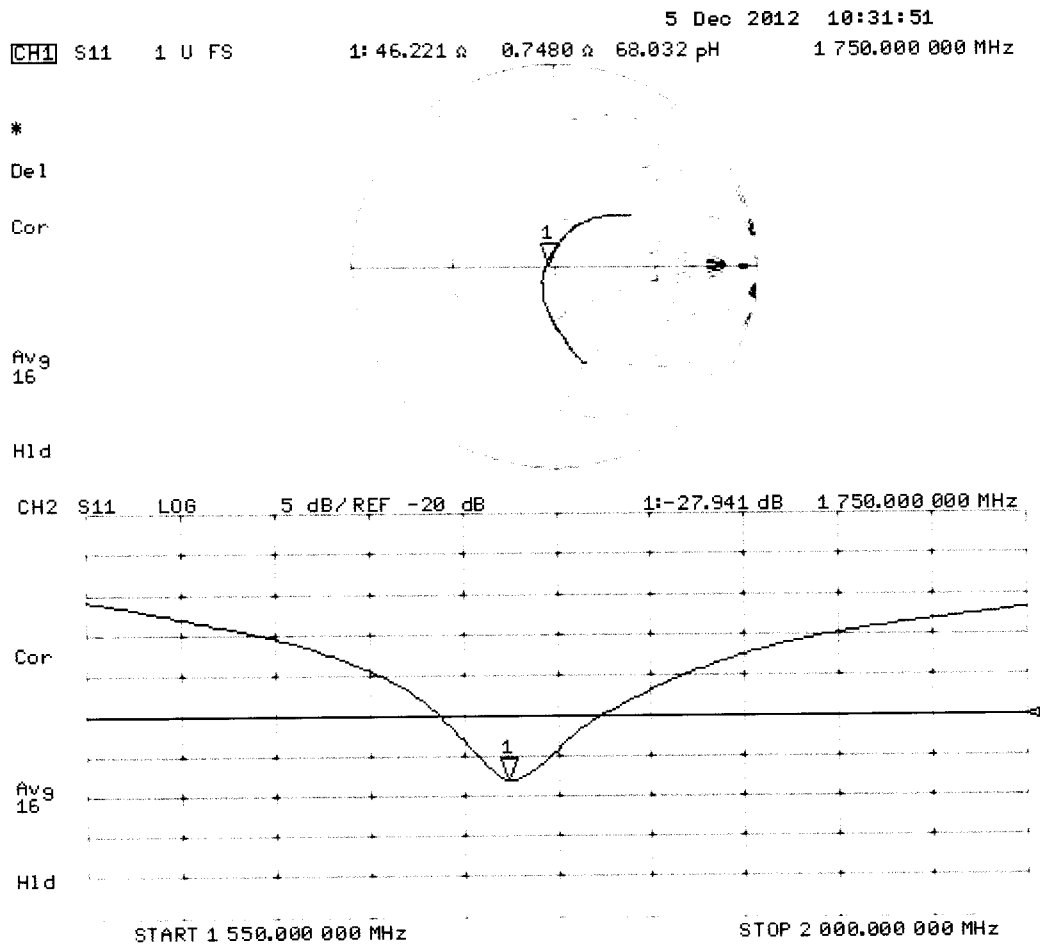

Extended Calibration

Usage of SAR dipoles calibrated less than 2 years ago but more than 1 year ago were confirmed in maintaining return loss (< -20 dB, within 20% of prior calibration) and impedance (within 5 ohm from prior calibration) requirements per extended calibrations in KDB Publication 865664 D01 v01r03.

D1750V2 SN: 1018 - Head						
Date of Measurement	Return Loss (dB)	$\Delta\%$	Impedance (Ω)	$\Delta\Omega$	Impedance Imaginary ($j\Omega$)	$\Delta\Omega$
12/5/2012	-42.2		50.2		0.8	
12/5/2013	-41.8	-0.9	52.1	1.9	0.6	-0.2
12/5/2014	-40.5	-4.0	51.6	1.4	0.2	-0.6

D1750V2 SN: 1018 - Body						
Date of Measurement	Return Loss (dB)	$\Delta\%$	Impedance (Ω)	$\Delta\Omega$	Impedance Imaginary ($j\Omega$)	$\Delta\Omega$
12/5/2012	-27.9		46.2		0.7	
12/5/2013	-28.2	1.1	45.9	-0.3	0.4	-0.3
12/5/2015	-26.2	-6.1	44.8	-1.4	0.9	0.2



Accredited by the Swiss Accreditation Service (SAS)
The Swiss Accreditation Service is one of the signatories to the EA
Multilateral Agreement for the recognition of calibration certificates

Accreditation No.: **SCS 108**

Client **RF Exposure Lab**

Certificate No: **D1900V2-5d116_Dec12**

CALIBRATION CERTIFICATE

Object **D1900V2 - SN: 5d116**

Calibration procedure(s) **QA CAL-05.v8**
Calibration procedure for dipole validation kits above 700 MHz

Calibration date: **December 06, 2012**

This calibration certificate documents the traceability to national standards, which realize the physical units of measurements (SI).
The measurements and the uncertainties with confidence probability are given on the following pages and are part of the certificate.

All calibrations have been conducted in the closed laboratory facility: environment temperature $(22 \pm 3)^\circ\text{C}$ and humidity $< 70\%$.

Calibration Equipment used (M&TE critical for calibration)

Primary Standards	ID #	Cal Date (Certificate No.)	Scheduled Calibration
Power meter EPM-442A	GB37480704	01-Nov-12 (No. 217-01640)	Oct-13
Power sensor HP 8481A	US37292783	01-Nov-12 (No. 217-01640)	Oct-13
Reference 20 dB Attenuator	SN: 5058 (20k)	27-Mar-12 (No. 217-01530)	Apr-13
Type-N mismatch combination	SN: 5047.3 / 06327	27-Mar-12 (No. 217-01533)	Apr-13
Reference Probe ES3DV3	SN: 3205	30-Dec-11 (No. ES3-3205_Dec11)	Dec-12
DAE4	SN: 601	27-Jun-12 (No. DAE4-601_Jun12)	Jun-13
Secondary Standards	ID #	Check Date (in house)	Scheduled Check
Power sensor HP 8481A	MY41092317	18-Oct-02 (in house check Oct-11)	In house check: Oct-13
RF generator R&S SMT-06	100005	04-Aug-99 (in house check Oct-11)	In house check: Oct-13
Network Analyzer HP 8753E	US37390585 S4206	18-Oct-01 (in house check Oct-12)	In house check: Oct-13

	Name	Function	Signature
Calibrated by:	Israe El-Naouq	Laboratory Technician	
Approved by:	Katja Pokovic	Technical Manager	

Issued: December 6, 2012

This calibration certificate shall not be reproduced except in full without written approval of the laboratory.



Accredited by the Swiss Accreditation Service (SAS)

Accreditation No.: **SCS 108**

The Swiss Accreditation Service is one of the signatories to the EA
Multilateral Agreement for the recognition of calibration certificates

Glossary:

TSL	tissue simulating liquid
ConvF	sensitivity in TSL / NORM x,y,z
N/A	not applicable or not measured

Calibration is Performed According to the Following Standards:

- IEEE Std 1528-2003, "IEEE Recommended Practice for Determining the Peak Spatial-Averaged Specific Absorption Rate (SAR) in the Human Head from Wireless Communications Devices: Measurement Techniques", December 2003
- IEC 62209-1, "Procedure to measure the Specific Absorption Rate (SAR) for hand-held devices used in close proximity to the ear (frequency range of 300 MHz to 3 GHz)", February 2005
- Federal Communications Commission Office of Engineering & Technology (FCC OET), "Evaluating Compliance with FCC Guidelines for Human Exposure to Radiofrequency Electromagnetic Fields; Additional Information for Evaluating Compliance of Mobile and Portable Devices with FCC Limits for Human Exposure to Radiofrequency Emissions", Supplement C (Edition 01-01) to Bulletin 65

Additional Documentation:

- DASY4/5 System Handbook

Methods Applied and Interpretation of Parameters:

- Measurement Conditions:** Further details are available from the Validation Report at the end of the certificate. All figures stated in the certificate are valid at the frequency indicated.
- Antenna Parameters with TSL:** The dipole is mounted with the spacer to position its feed point exactly below the center marking of the flat phantom section, with the arms oriented parallel to the body axis.
- Feed Point Impedance and Return Loss:** These parameters are measured with the dipole positioned under the liquid filled phantom. The impedance stated is transformed from the measurement at the SMA connector to the feed point. The Return Loss ensures low reflected power. No uncertainty required.
- Electrical Delay:** One-way delay between the SMA connector and the antenna feed point. No uncertainty required.
- SAR measured:** SAR measured at the stated antenna input power.
- SAR normalized:** SAR as measured, normalized to an input power of 1 W at the antenna connector.
- SAR for nominal TSL parameters:** The measured TSL parameters are used to calculate the nominal SAR result.

The reported uncertainty of measurement is stated as the standard uncertainty of measurement multiplied by the coverage factor $k=2$, which for a normal distribution corresponds to a coverage probability of approximately 95%.

Measurement Conditions

DASY system configuration, as far as not given on page 1.

DASY Version	DASY5	V52.8.3
Extrapolation	Advanced Extrapolation	
Phantom	Modular Flat Phantom	
Distance Dipole Center - TSL	10 mm	with Spacer
Zoom Scan Resolution	dx, dy, dz = 5 mm	
Frequency	1900 MHz ± 1 MHz	

Head TSL parameters

The following parameters and calculations were applied.

	Temperature	Permittivity	Conductivity
Nominal Head TSL parameters	22.0 °C	40.0	1.40 mho/m
Measured Head TSL parameters	(22.0 ± 0.2) °C	39.5 ± 6 %	1.38 mho/m ± 6 %
Head TSL temperature change during test	< 0.5 °C	----	----

SAR result with Head TSL

SAR averaged over 1 cm³ (1 g) of Head TSL	Condition	
SAR measured	250 mW input power	9.97 W/kg
SAR for nominal Head TSL parameters	normalized to 1W	40.1 W/kg ± 17.0 % (k=2)

SAR averaged over 10 cm³ (10 g) of Head TSL	condition	
SAR measured	250 mW input power	5.24 W/kg
SAR for nominal Head TSL parameters	normalized to 1W	21.0 W/kg ± 16.5 % (k=2)

Body TSL parameters

The following parameters and calculations were applied.

	Temperature	Permittivity	Conductivity
Nominal Body TSL parameters	22.0 °C	53.3	1.52 mho/m
Measured Body TSL parameters	(22.0 ± 0.2) °C	52.2 ± 6 %	1.52 mho/m ± 6 %
Body TSL temperature change during test	< 0.5 °C	----	----

SAR result with Body TSL

SAR averaged over 1 cm³ (1 g) of Body TSL	Condition	
SAR measured	250 mW input power	10.1 W/kg
SAR for nominal Body TSL parameters	normalized to 1W	40.2 W/kg ± 17.0 % (k=2)

SAR averaged over 10 cm³ (10 g) of Body TSL	condition	
SAR measured	250 mW input power	5.31 W/kg
SAR for nominal Body TSL parameters	normalized to 1W	21.2 W/kg ± 16.5 % (k=2)

Appendix

Antenna Parameters with Head TSL

Impedance, transformed to feed point	51.4 Ω + 6.6 j Ω
Return Loss	- 23.5 dB

Antenna Parameters with Body TSL

Impedance, transformed to feed point	47.4 Ω + 6.7 j Ω
Return Loss	- 22.7 dB

General Antenna Parameters and Design

Electrical Delay (one direction)	1.202 ns
----------------------------------	----------

After long term use with 100W radiated power, only a slight warming of the dipole near the feedpoint can be measured.

The dipole is made of standard semirigid coaxial cable. The center conductor of the feeding line is directly connected to the second arm of the dipole. The antenna is therefore short-circuited for DC-signals. On some of the dipoles, small end caps are added to the dipole arms in order to improve matching when loaded according to the position as explained in the "Measurement Conditions" paragraph. The SAR data are not affected by this change. The overall dipole length is still according to the Standard.

No excessive force must be applied to the dipole arms, because they might bend or the soldered connections near the feedpoint may be damaged.

Additional EUT Data

Manufactured by	SPEAG
Manufactured on	August 21, 2009

DASY5 Validation Report for Head TSL

Date: 06.12.2012

Test Laboratory: SPEAG, Zurich, Switzerland

DUT: Dipole 1900 MHz; Type: D1900V2; Serial: D1900V2 - SN: 5d116

Communication System: CW; Frequency: 1900 MHz

Medium parameters used: $f = 1900$ MHz; $\sigma = 1.38$ mho/m; $\epsilon_r = 39.5$; $\rho = 1000$ kg/m³

Phantom section: Flat Section

Measurement Standard: DASY5 (IEEE/IEC/ANSI C63.19-2007)

DASY52 Configuration:

- Probe: ES3DV3 - SN3205; ConvF(5.01, 5.01, 5.01); Calibrated: 30.12.2011;
- Sensor-Surface: 3mm (Mechanical Surface Detection)
- Electronics: DAE4 Sn601; Calibrated: 27.06.2012
- Phantom: Flat Phantom 5.0 (front); Type: QD000P50AA; Serial: 1001
- DASY52 52.8.3(988); SEMCAD X 14.6.7(6848)

Dipole Calibration for Head Tissue/Pin=250 mW, d=10mm/Zoom Scan (7x7x7)/Cube 0:

Measurement grid: dx=5mm, dy=5mm, dz=5mm

Reference Value = 97.363 V/m; Power Drift = 0.07 dB

Peak SAR (extrapolated) = 17.9 W/kg

SAR(1 g) = 9.97 W/kg; SAR(10 g) = 5.24 W/kg

Maximum value of SAR (measured) = 12.3 W/kg

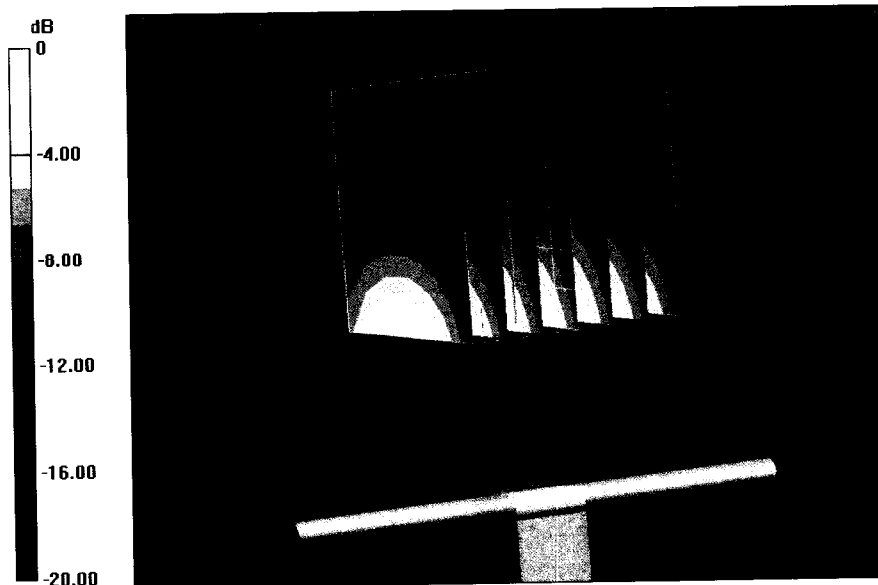

0 dB = 12.3 W/kg = 10.90 dBW/kg

Impedance Measurement Plot for Head TSL

6 Dec 2012 12:59:53

CH1 S11 1 U FS 1: 51.367 Ω 6.6406 Ω 556.26 μ H 1 900.000 000 MHz

*
De1
Cor
Avg
16
H1d

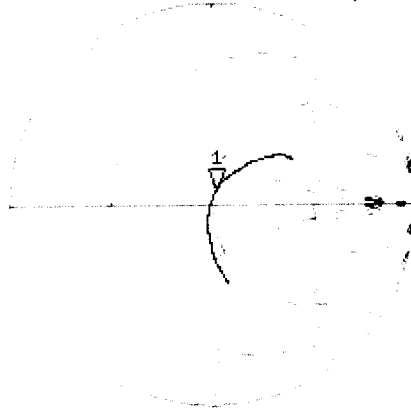

CH2 S11 LOG 5 dB/REF -20 dB 1: -23.512 dB 1 900.000 000 MHz

Cor
Avg
16
H1d

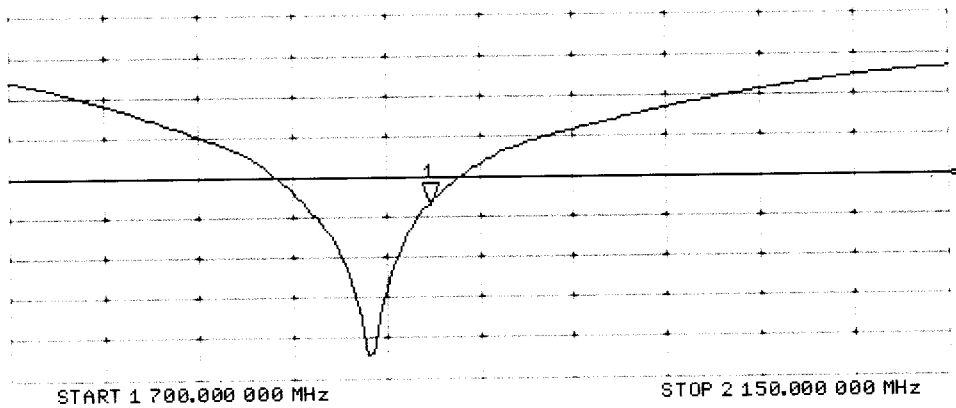

DASY5 Validation Report for Body TSL

Date: 06.12.2012

Test Laboratory: SPEAG, Zurich, Switzerland

DUT: Dipole 1900 MHz; Type: D1900V2; Serial: D1900V2 - SN: 5d116

Communication System: CW; Frequency: 1900 MHz

Medium parameters used: $f = 1900$ MHz; $\sigma = 1.52$ mho/m; $\epsilon_r = 52.2$; $\rho = 1000$ kg/m³

Phantom section: Flat Section

Measurement Standard: DASY5 (IEEE/IEC/ANSI C63.19-2007)

DASY52 Configuration:

- Probe: ES3DV3 - SN3205; ConvF(4.62, 4.62, 4.62); Calibrated: 30.12.2011;
- Sensor-Surface: 3mm (Mechanical Surface Detection)
- Electronics: DAE4 Sn601; Calibrated: 27.06.2012
- Phantom: Flat Phantom 5.0 (back); Type: QD000P50AA; Serial: 1002
- DASY52 52.8.3(988); SEMCAD X 14.6.7(6848)

Dipole Calibration for Body Tissue/Pin=250 mW, d=10mm/Zoom Scan (7x7x7)/Cube 0:

Measurement grid: dx=5mm, dy=5mm, dz=5mm

Reference Value = 95.415 V/m; Power Drift = 0.07 dB

Peak SAR (extrapolated) = 17.7 W/kg

SAR(1 g) = 10.1 W/kg; SAR(10 g) = 5.31 W/kg

Maximum value of SAR (measured) = 12.7 W/kg

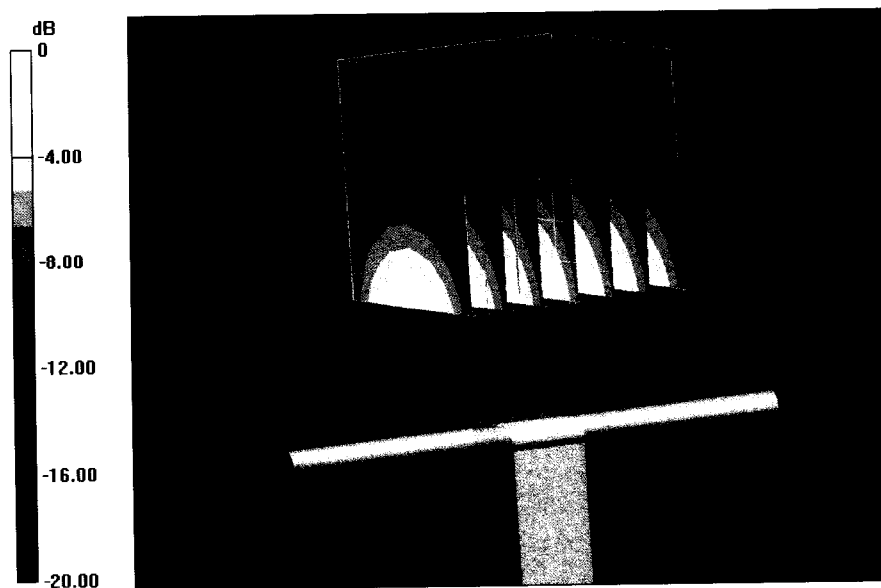

0 dB = 12.7 W/kg = 11.04 dBW/kg

Impedance Measurement Plot for Body TSL

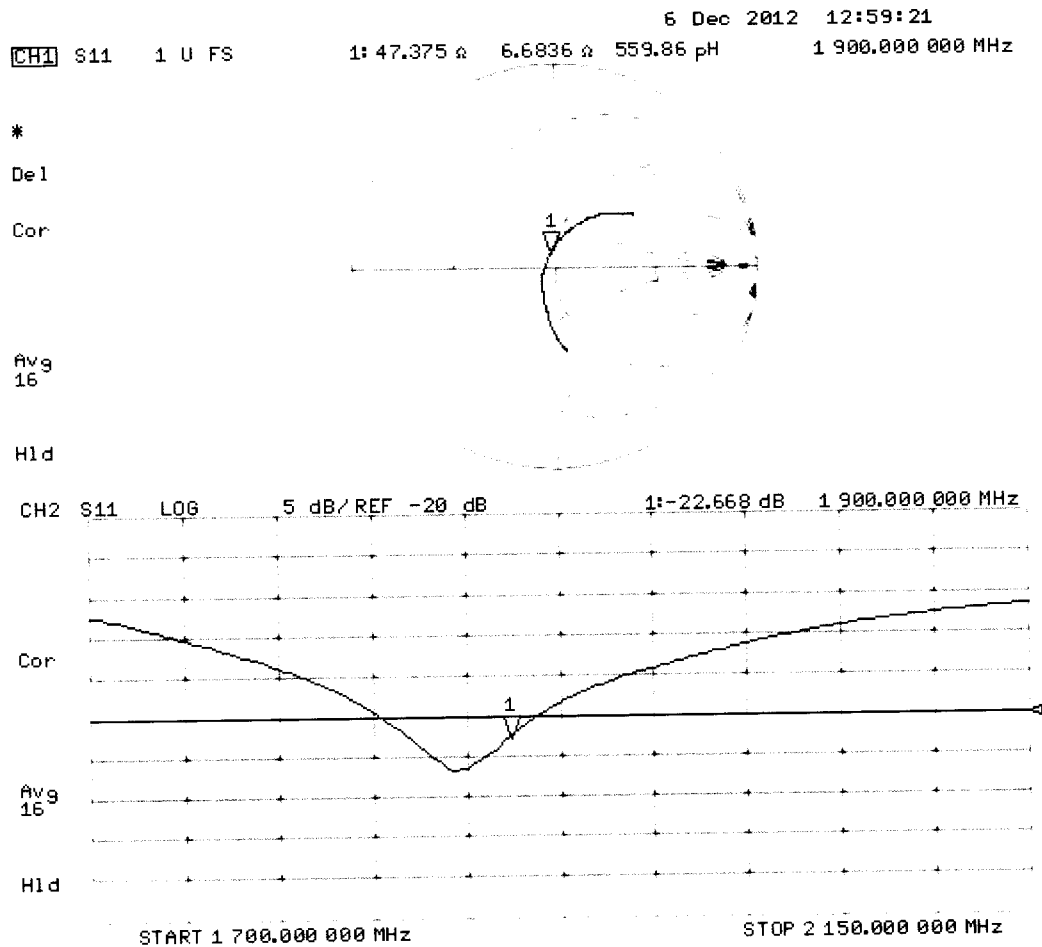

Extended Calibration

Usage of SAR dipoles calibrated less than 2 years ago but more than 1 year ago were confirmed in maintaining return loss (< -20 dB, within 20% of prior calibration) and impedance (within 5 ohm from prior calibration) requirements per extended calibrations in KDB Publication 865664 D01 v01r03.

D1900V2 SN: 5d116 - Head						
Date of Measurement	Return Loss (dB)	$\Delta\%$	Impedance (Ω)	$\Delta\Omega$	Impedance Imaginary ($j\Omega$)	$\Delta\Omega$
12/6/2012	-23.5		51.4		6.6	
12/6/2013	-23.6	0.4	51.0	-0.4	6.1	-0.5
12/6/2014	-22.7	-3.4	50.5	-0.9	6.7	0.1

D1900V2 SN: 5d116 - Body						
Date of Measurement	Return Loss (dB)	$\Delta\%$	Impedance (Ω)	$\Delta\Omega$	Impedance Imaginary ($j\Omega$)	$\Delta\Omega$
12/6/2012	-22.7		47.4		6.7	
12/6/2013	-21.9	-3.5	46.9	-0.5	5.8	-0.9
12/6/2014	-22.9	0.9	45.4	-2.0	6.1	-0.6

Appendix F – Phantom Calibration Data Sheets

Zeughausstrasse 43, 8004 Zurich, Switzerland
 Phone +41 44 245 9700, Fax +41 44 245 9779
 info@speag.com, http://www.speag.com

Certificate of Conformity / First Article Inspection

Item	Oval Flat Phantom ELI 4.0
Type No	QD OVA 001 B
Series No	1003 and higher
Manufacturer	Untersee Composites Knebelstrasse 8 CH-8268 Mannenbach, Switzerland

Tests

Complete tests were made on the prototype units QD OVA 001 AA 1001, QD OVA 001 AB 1002, pre-series units QD OVA 001 BA 1003-1005 as well as on the series units QD OVA 001 BB, 1006 ff.

Test	Requirement	Details	Units tested
Material thickness	Compliant with the standard requirements	Bottom plate: 2.0mm +/- 0.2mm	all
Material parameters	Dielectric parameters for required frequencies	< 6 GHz: Rel. permittivity = 4 +/-1, Loss tangent ≤ 0.05	Material sample
Material resistivity	The material has been tested to be compatible with the liquids defined in the standards if handled and cleaned according to the instructions.	DGBE based simulating liquids. Observe Technical Note for material compatibility.	Equivalent phantoms, Material sample
Shape	Thickness of bottom material, Internal dimensions, Sagging compatible with standards from minimum frequency	Bottom elliptical 600 x 400 mm Depth 190 mm, Shape is within tolerance for filling height up to 155 mm, Eventual sagging is reduced or eliminated by support via DUT	Prototypes, Sample testing

Standards

- [1] CENELEC EN 50361-2001, « Basic standard for the measurement of the Specific Absorption Rate related to human exposure to electromagnetic fields from mobile phones (300 MHz – 3 GHz) », July 2001
- [2] IEEE 1528-2003, "Recommended Practice for Determining the Peak Spatial-Average Specific Absorption Rate (SAR) in the Human Head from Wireless Communications Devices: Measurement Techniques, December 2003
- [3] IEC 62209 – 1, "Specific Absorption Rate (SAR) in the frequency range of 300 MHz to 3 GHz – Measurement Procedure, Part 1: Hand-held mobile wireless communication devices", February 2005
- [4] IEC 62209 – 2, Draft, "Human Exposure to Radio Frequency Fields from Handheld and Body-Mounted Wireless Communication Devices – Human models, Instrumentation and Procedures – Part 2: Procedure to determine the Specific Absorption Rate (SAR) in the head and body for 30 MHz to 6 GHz Handheld and Body-Mounted Devices used in close proximity to the Body.", February 2005
- [5] OET Bulletin 65, Supplement C, "Evaluating Compliance with FCC Guidelines for Human Exposure to Radiofrequency Electromagnetic Fields", Edition January 2001

Based on the tests above, we certify that this item is in compliance with the standards [1] to [5] if operated according to the specific requirements and considering the thickness. The dimensions are fully compliant with [4] from 30 MHz to 6 GHz. For the other standards, the minimum lower frequency limit is limited due to the dimensional requirements ([1]: 450 MHz, [2]: 300 MHz, [3]: 800 MHz, [5]: 375 MHz) and possibly further by the dimensions of the DUT.

Date 28.4.2008 Signature / Stamp

s p e a g
 Schmid & Partner Engineering AG
 Zeughausstrasse 43, 8004 Zurich, Switzerland
 Phone +41 44 245 9700, Fax +41 44 245 9779
 info@speag.com; http://www.speag.com