



MOMENT

Wireless Karaoke Soundbar

USER MANUAL



Table of Contents

| | |
|---|----|
| 1 Important Safety Information..... | 1 |
| Safety..... | 1 |
| Warning..... | 2 |
| Location..... | 4 |
| Proper Ventilation..... | 4 |
| Usage..... | 5 |
| Cleaning & Maintenance..... | 5 |
| 2 Moment Wireless Karaoke Soundbar..... | 6 |
| 3 In the box..... | 7 |
| 4 Before you begin..... | 8 |
| 5 Selecting a location..... | 9 |
| Tabletop - Moment Soundbar..... | 9 |
| Wall Mounting - Moment Soundbar..... | 10 |
| What you will need..... | 10 |
| 6 How-to..... | 11 |
| Moment Subwoofer..... | 13 |
| 7 Setting Up Moment..... | 14 |
| 8 Indicator Light Explanations..... | 15 |
| 9 Connection Ports..... | 17 |
| 10 Remote Control..... | 18 |
| First-time use..... | 19 |
| Remote Control Battery Replacement..... | 19 |
| Precautions Concerning Batteries..... | 19 |
| 11 Microphone..... | 20 |
| 12 Basic Troubleshooting..... | 21 |
| Customer Support..... | 21 |
| Moment does not turn on..... | 21 |
| Moment Subwoofer not detected..... | 21 |
| No sound from microphone..... | 22 |
| Flashing LED on microphone..... | 22 |
| Replacement/ additional microphone..... | 22 |
| Turning off your television's speakers..... | 22 |
| Can't turn off TV speakers..... | 22 |
| 13 Moment Specifications..... | 23 |
| 14 Warranty..... | 23 |

Important Safety Information



WARNING: TO REDUCE THE RISK OF ELECTRIC SHOCK, DO NOT REMOVE COVER (OR BACK) AS THERE ARE NO USER-SERVICEABLE PARTS INSIDE. REFER SERVICING TO QUALIFIED SERVICE PERSONNEL



The lightning flash with arrowhead symbol, within an equilateral triangle, is intended to alert the user to the presence of non-insulated "dangerous voltage" within the product's enclosure that may be of sufficient magnitude to constitute a risk of electric shock.



The exclamation point within an equilateral triangle is intended to alert the user to the presence of important operating and maintenance instructions in the literature accompanying the appliance.

Safety

1. Read these instructions – All the safety and operating instructions should be read before this product is operated.
2. Keep these instructions – The safety and operating instructions should be retained for future reference.
3. Heed all warnings – All warnings on the appliance and in the operating instructions should be adhered to.
4. Follow all instructions – All operating and use instructions should be followed.
5. Do not use this apparatus near water
 - The appliance should not be used near water or moisture – for example, in a wet basement or near a swimming pool and the like.
6. Clean only with a dry cloth.
7. Do not block any ventilation openings. Install in accordance with the manufacturer's instructions.
8. Do not install near any heat sources such as radiators, heaters, stoves, or other apparatus (including amplifiers) that produce heat.
9. Protect the power cord from being walked on or pinched, particularly at plugs, convenience receptacles and at the point where they exit from the apparatus.
10. Only use attachments/accessories specified by the manufacturer.
11. Attention should be drawn to the environmental aspects of battery disposal.
12. The use of apparatus in moderate climates.
13.  Use only with the cart, stand, tripod, bracket, or table specified by the manufacturer, or sold with the apparatus. When a cart or rack is used, use caution when moving the cart/apparatus combination to avoid injury from tip-over.
14. Unplug the apparatus during lightning storms or when unused for long periods of time.

15. Refer all servicing to qualified personnel. Servicing is required when the apparatus has been damaged in any way, such as power supply cord or plug is damaged, liquid has been spilled or objects have fallen into the apparatus, the unit has been exposed to rain or moisture, does not operate normally, or has been dropped.
16. This equipment is a Class II or double insulated electrical appliance. It has been designed in such a way that it does not require a safety connection to electrical earth.
17. To prevent injury, this apparatus must be securely attached to the floor/wall in accordance with the installation instructions.

Caution:

- Use of controls or adjustments or performance of procedures other than those described herein, may result in hazardous radiation exposure or other unsafe operation.
- To reduce the risk of fire or electric shock, do not expose this apparatus to rain or moisture. The apparatus must not be exposed to dripping or splashing and objects filled with liquids, such as vases, must not be placed on apparatus.
- The mains plug is used as the disconnect device, the disconnect device must remain readily operable.
- Danger of explosion if battery is incorrectly replaced. Replace only with the same or equivalent type.

Warning

- The battery (battery or batteries or battery pack) must not be exposed to excessive heat such as sunshine, fire or the like.
- Before operating this system, check the voltage of this system to see if it is identical to the voltage of your local power supply.
- Do not place this unit close to strong magnetic fields.
- Do not place the unit on the amplifier or receiver.
- Do not place this unit close to damp areas as the moisture will affect the life of the laser head.
- Should any solid object or liquid fall into the system, unplug the system and have it checked by qualified personnel before operating it any further.
- Do not attempt to clean the unit with chemical solvents as this might damage the finish. Use a clean, dry or slightly damp cloth.
- When removing the power plug from the wall outlet, always pull directly on the plug, never yank on the cord.

- No naked flame sources, such as lighted candles, should be placed on the apparatus.
- Changes or modifications to this unit not expressly approved by the party responsible for compliance will void the user's authority to operate the equipment.
-  Correct Disposal Of This Product. This marking indicates that this product should not be disposed of with other household wastes throughout the EU. To prevent possible harm to the environment or human health from uncontrolled waste disposal, recycle it responsibly to promote the sustainable re-use of material resources. To return your used device, please use the return and collection systems or contact the retailer where the product was purchased as they can take this product for environmental safe recycling. The marking label is pasted on the bottom of the equipment.



WARNING

DO NOT INGEST BATTERY, CHEMICAL BURN HAZARD

The remote control supplied with this product contains a coin/button cell battery. If the coin/button cell battery is swallowed, it can cause severe internal burns in just 2 hours and lead to death. Keep new and used batteries away from children. If the battery compartment does not close securely, stop using the product and keep it away from children. If you think batteries might have been swallowed or placed inside any part of the body, seek immediate medical attention.

Location

- Do not place Moment where it will be exposed to excessive heat (e.g. radiators, heat registers, stoves), direct sunlight, or a dusty environment (e.g. woodworking shop).
- Do not place Moment where it will be exposed to flammable liquids and/or fumes.
- Do not place Moment in a small confined space (e.g. closet or cabinet, under a bed or sofa) where ventilation is restricted. All sides of Moment Soundbar should be at least 1 ft. (30cm) from a wall or other obstruction.
- Protect the power cable from being walked on or pinched, particularly at plugs, convenience receptacles, and the point where it exits the product. The mains cord should be readily available to disconnect the power.
- Moment should not be used near water—avoid close proximity to a bathtub, kitchen sink, laundry tub, wet basement, swimming pool, etc.
- If Moment is being wall-mounted, use its Wall Mounting Kit (included in the package) and follow the instructions carefully. Improper or inadequate installation could cause your device to fall, resulting in personal injury and equipment damage.

Proper Ventilation

- Ventilation should not be impeded by covering any openings with items such as tablecloths, curtains, or papers.
- Do not let foreign objects into the unit. If a foreign object should get into the unit, unplug the unit and contact Moment for servicing guidance.

Usage

- Do not operate or handle with wet hands.
- Do not place any object on top of the product (e.g. vase, coffee cup, potted plant, books, magazines, etc).
- Only use attachment/ accessories specified by Moment.
- Unplug the power cord during lightning storms or when unused for long periods of time.
- Never disassemble or modify the product in any way.
- If Moment is wall-mounted, never hang from Moment or the wall mount bracket.
- Perform safety checks on a regular basis to ensure wall mount screws remain tightened securely.

Cleaning & Maintenance

- Keep Moment free from dust, pet hair, and other fine particles.
- Use only a dry, soft cloth for cleaning. Household cleaners or solvents may damage the finish on your Moment Soundbar and/or Subwoofer.
- Do not use chemical solvents (e.g. alcohol, benzene, paint thinner) or other flammable cleaning liquids.
- Refer all servicing to Moment qualified service personnel. Servicing is required when the unit or the power cord has been damaged in any way, if liquid or other foreign matter has fallen into the ventilation openings, or the unit has been exposed to rain or moisture.

Moment Wireless Karaoke Soundbar

The world's smallest karaoke sound bar with high fidelity audio.



Moment is a high-fidelity soundbar, only more versatile. This world's first compact soundbar comes with a built-in mixer, complete with a wireless microphone & subwoofer to serve your entertainment needs. Whether it's singing karaoke, listening to music, enjoying a movie at home or even gaming - Moment does it all minus the cable mess. Isn't that awesome?

Because it's designed for plug & play usage, it'll only take a few minutes to get your Moment Wireless Karaoke Soundbar up and running. The next few pages will show you more information.

In The Box

- Moment Wireless Karaoke Soundbar
- Moment Wireless Subwoofer
- Moment Wireless Microphone(s) *
- IR Remote Control
- Power Cords
- TOSLINK Optical Audio Cable
- AUX L/R Audio Cable
- AUX L/R to 3.5mm Audio Cable
- Wall Mounting Kit
- User Manual

* Depending on the package purchased, you might have 1 or 2 Moment Wireless Microphones in the box. Please refer to your purchase invoice for more information.

Before You Begin

Prior to installing your Moment Wireless Karaoke Soundbar, make sure all external components, such as your cable box, DVD player, etc are connected directly to your TV.

If you have any existing home theatre or surround sound equipment, disconnect it from your television.

Mute your television's volume by using it's Volume - button, do not use the mute button.

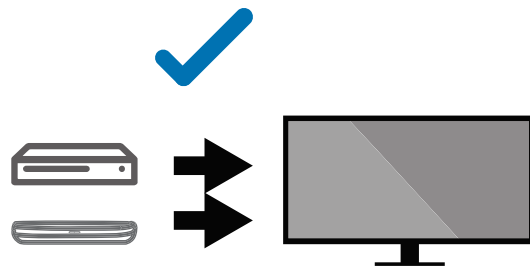

Selecting a Location

Moment's small 16-inch footprint was created with modern homes in mind, allowing for great flexibility when positioning. You can wall mount it above or below your television or place it on a tabletop or TV console. See the guidelines below for more information.

Tabletop - Moment Soundbar

- Place Moment Soundbar horizontally and flat on its feet.
- Do not place vertically or upright on its side.
- For optimum audio quality, ensure that the Moment logo faces towards you.
- There is no placement restriction between Moment and the TV as long as the television's IR receiver is not obstructed.

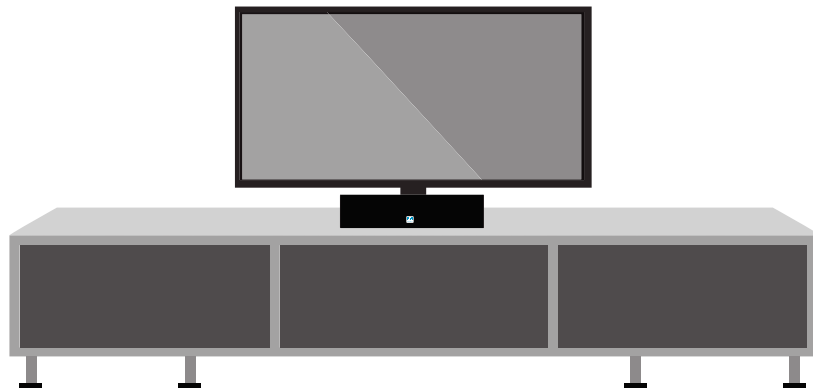

Wall Mounting - Moment Soundbar

Moment can be wall mounted above or below your wall-mounted television using the provided Wall Mount Kit. For optimum audio quality, ensure that the Moment logo faces towards you.

Note: It is recommended that you connect the power and audio cables to the Moment Soundbar before mounting on the wall.

What you will need

- Moment Wall Mount Kit (included)
- Masking tape
- An awl or other pointed tool
- A Phillips head screw driver
- Power drill with Phillips head attachment
- A level

How-to

- Hold the Moment wall mount template (included in the wall mount kit) in the desired position on your wall. Your Moment Soundbar can be mounted either above or below the television.

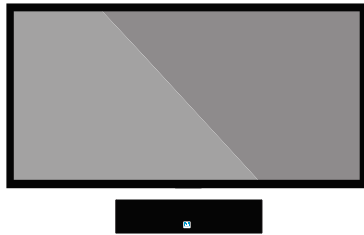

IMPORTANT: For optimal audio performance, we recommend: When mounting below a television, allow 1 inch (25mm) clearance between Moment and the TV. When mounting above a television, allow 2 inches (50mm) clearance between Moment and the TV.

- Use a level to ensure the template is horizontally level, and then tape the template securely to the wall.
- Using an awl or other sharp object, punch 4 small holes through 4 of the marked locations on the template.

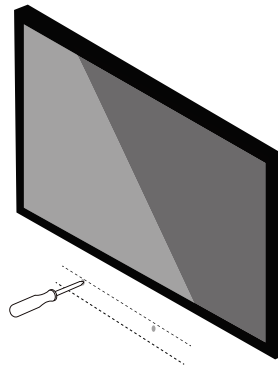
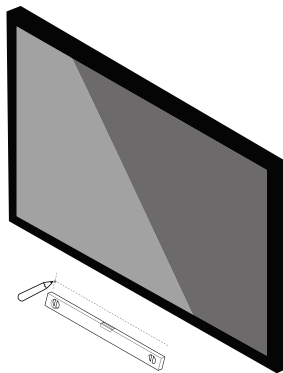

- Remove the template from the wall.
- Drill pilot holes. Pre-drilling results in a more accurate installation.

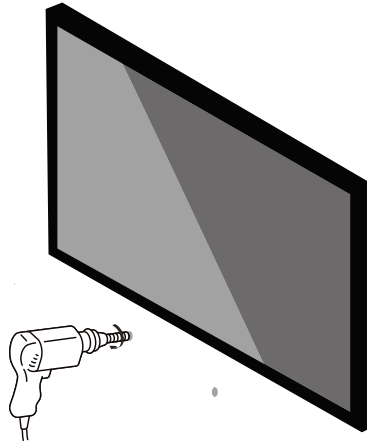

- Insert and secure the wall anchors (supplied in the wall mount kit).
 - If you are drilling into wood stud, do not use the wall anchors.
 - If you are drilling into Sheetrock, screw the wall anchors into the drywall with a Phillips head screwdriver until the head is flat against or slightly below the wall surface, being careful not to over-tighten.

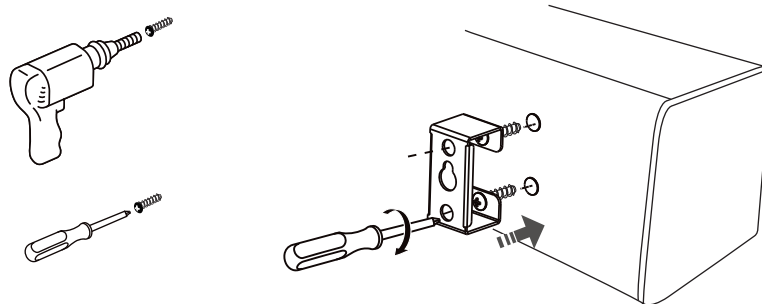

Note: The anchors can be installed using a screw gun or a regular power drill with a Phillips head screwdriver attachment. If you are drilling into sheetrock, the surface of the drywall may distort slightly or dimple as the anchor is installed. This is not unusual.

- Fasten the wall mount bracket to the wall using the screws supplied in the wall mount kit. Use the level to verify accuracy a final time, and then tighten the screws securely.

Note: If using wall anchors, continue to drill for a few seconds even after it appears the screw is secure— the anchor will likely spin a little as the anchor expands inside the wall.

- Hang Moment securely on the two (2) bracket pegs.

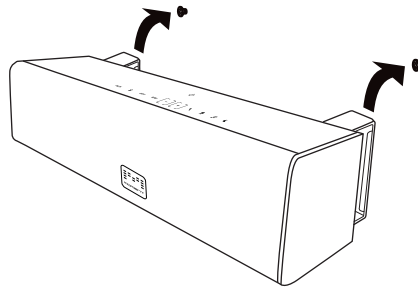

Moment Subwoofer

- Place Moment Subwoofer vertically, making sure to allow access to the back of the Subwoofer where the power button is located.
- You may also choose to position Moment Subwoofer horizontally, with its grill cloth side facing upwards.
- For optimum audio quality, ensure that the grill cloth isn't obstructed and has at least 1 ft. (30cm) clearance from the wall.

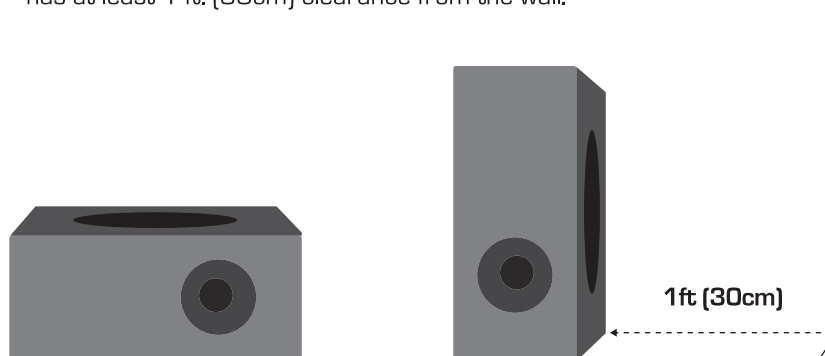

Setting Up Moment

- Carefully unpack the package contents.
- Choose a location for your Moment Soundbar. Refer to 'Selecting a Location' for help with this step.
- Attach the power cords to Moment Soundbar and Moment Subwoofer, and apply power. Be sure to push the power cord firmly in until it is flush with the surface.
- Turn on Moment Soundbar using the supplied IR Remote Control, or by tapping on the power icon located on its top surface.
- Turn on Moment Subwoofer by flicking the switch located on the back, moving it to the 'ON' position.
- Choose your preferred connection method using the IR Remote Control
 - Optical Audio In (OPT)
 - Remove the protective caps from each end of the optical audio cable [supplied].
 - Connect the optical audio cable from your TV's digital audio out (optical) to Moment's OPTICAL IN port being careful not to twist or bend the cable. Be sure to align for proper insertion.
 - Auxiliary/ Line Audio In (AUX)
 - Connect the AUX L/R Audio Cable [supplied] from your TV's AUX Out or RCA Out to Moment's AUX IN, matching the cables' colour with its respective port.
 - If connecting Moment to your computer/ smartphone/tablet, use the supplied AUX L/R to 3.5mm Audio Cable instead.
 - Bluetooth aptX (BT logo)
 - Ensure your media device's Bluetooth is turned on.
 - Under the list of available Bluetooth devices, select 'Moment' and automatic pairing will begin.

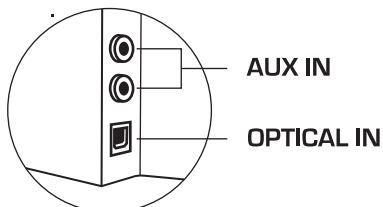

Press and hold onto the 'Bluetooth' button on IR Remote Control to go into pairing mode. In pairing mode, Moment terminates all Bluetooth connection and is ready to pair with any new device.

Indicator Light Explanations

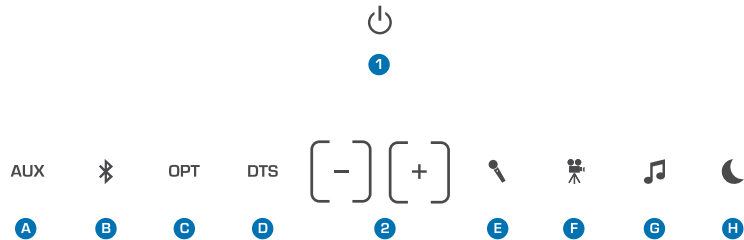

1. Power Button/ Status Indicator Light

- Toggles between ON (White LED light) and Standby (Red LED light) mode.
 - When Moment is on Standby, tap once to turn on.
 - When Moment is ON, tap once to go to standby mode.
- Indicates the status of the Moment Soundbar
 - When Moment is in normal operation, the LED is white.
 - When Moment receives a volume/ echo/ bass/ treble adjustment command, the white LED will flash once.
 - When the volume/ echo/ bass/ treble levels are already at their minimum or maximum, the white LED flashes 3 times in quick succession.

2. Volume Controls

- Press these buttons to adjust the volume up and down.

A. Auxiliary/ Line Audio In

- Activate by pressing the 'AUX' button on IR Remote Control.
- When choosing to output audio from the currently connected AUX/ LINE device, this indicator LED is red.

B. Bluetooth aptX Audio

- Activate by pressing the 'Bluetooth' button on IR Remote Control.
- When choosing to output audio from the currently connected Bluetooth enabled device, this indicator LED is blue.
- In pairing mode, this blue indicator LED will flash continuously.

Note: Press and hold onto the 'Bluetooth' button on IR Remote Control to go into pairing mode. In pairing mode, Moment terminates all Bluetooth connection and is ready to pair with any new device.

C. Optical Audio In

- Activate by pressing the 'OPT' button on IR Remote Control.
- When choosing to output audio from the currently connected Optical Audio device, this indicator LED is white.

D. DTS TruSurround™

- Activate by pressing the 'DTS' button on IR Remote Control.
- When DTS TruSurround™ is activated, this indicator LED is white.

E. Karaoke Mode

- Cycle through the 4 preset modes by pressing the 'EQ' button on IR Remote Control.
- When in Karaoke Mode, this indicator LED is white.
- Karaoke Mode enables the use of your Moment Wireless Microphones, echo level adjustments and prioritises vocal clarity.

F. Movie Mode

- Cycle through the 4 preset modes by pressing the 'EQ' button on IR Remote Control.
- When in Movie Mode, this indicator LED is white.
- Movie Mode enhances effects and bass, and activates DTS TruSurround™ for an immersive movie experience.

G. Music Mode

- Cycle through the 4 preset modes by pressing the 'EQ' button on IR Remote Control.
- When in Music Mode, this indicator LED is white.
- Music Mode emphasises vocals, bass, mid-bass and treble levels for a great music experience.

H. Night Mode

- Cycle through the 4 preset modes by pressing the 'EQ' button on IR Remote Control.
- When in Night Mode, this indicator LED is white.
- Night Mode adjusts the audio for night time viewing so you can reduce the volume and still experience proper balance and range. At lower volumes, vocal dialogs are enhanced and loud sounds and effects are subdued.

Connection Ports

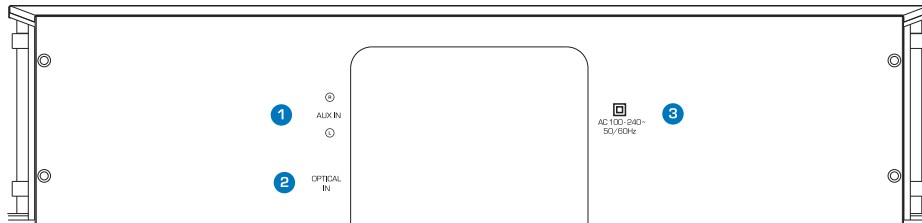

1. Auxiliary/ Line Audio In

- Connect Moment to your devices capable of an AUX L/R Audio or RCA Audio connection, matching the cables' colour with its respective port.
- If connecting Moment to your computer/ smartphone/ tablet, use the supplied AUX L/R to 3.5mm Audio Cable instead.

2. Optical Audio In

- Connect Moment to your devices capable of an Optical Audio connection.
- Be sure to remove the protective caps from the supplied Optical Audio cables before proceeding.

3. AC Power (Mains) Input

- Use only the supplied power cord to connect to a power outlet (using a third party power cord will void your warranty). Be sure to use the proper power cord for your country.
- Be sure to push the power cord firmly in until it is flush with the surface.

Remote Control

1. Power/ Standby Button

- Toggles between ON (White LED light) and Standby (Red LED light) mode.
- When Moment is on Standby, press once to turn on.
- When Moment is ON, press once to go to standby mode.

2. DTS TruSurround™

- Activates DTS TruSurround™ for enhanced bass and dialogs, high-definition and realistic virtual surround sound.
 - When DTS TruSurround™ is OFF, press once to turn on.
 - When DTS TruSurround™ is ON, press once to turn off.

3. Volume Controls

- Press these buttons to adjust the volume up and down.
- Press the 'Mute' button to suppress all sounds.

4. Treble Controls

- Press these buttons to adjust the treble up and down.

5. Bass Controls

- Press these buttons to adjust the bass up and down.

6. Equaliser

- Cycle through the 4 preset (Karaoke, Movie, Music, Night) modes.

7. Auxiliary/ Line Audio In

- Output audio from the currently connected AUX/ LINE IN device.

8. Bluetooth aptX Audio

- Output audio from the currently connected Bluetooth enabled device.
- Press and hold onto the 'Bluetooth' button on IR Remote Control to go into pairing mode.

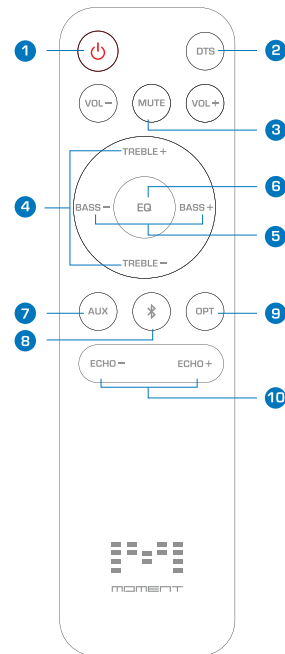

Remote Control

- In pairing mode, Moment terminates all Bluetooth connection and is ready to pair with any new device.

9. Optical Audio In

- Output audio from the currently connected Optical Audio device.

10. Echo Controls

- Press these buttons to adjust the echo up and down.
- Echo only works in Karaoke Mode when using the Moment Wireless Microphones

Remote Control Battery Replacement

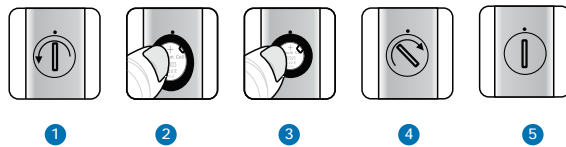

CAUTION

Danger of explosion if battery is incorrectly replaced.
Replace only with the same or equivalent type.

1. Turn the battery cover counter clockwise to open it.
2. Insert the battery in at a slight angle with its positive side facing up.
3. Ensure battery is seated under the “U” shaped metal piece.
4. Replace the battery cover and turn clockwise to secure it.
5. The installation is complete.

Precautions Concerning Batteries

- When the Remote Control is not to be used for a long time (more than a month), remove the battery from the Remote Control to prevent it from leaking.
- If the batteries leak, wipe away the leakage inside the battery compartment and replace the batteries with new ones.
- Do not use any batteries other than those specified.
- Do not heat or disassemble batteries. Never throw them in fire or water.
- Do not carry or store batteries with other metallic objects. Doing so could cause batteries to short circuit, leak or explode.
- Never recharge a battery unless it is confirmed to be a rechargeable type.

Microphone

1. Power Button

- Toggles between ON (White LED light) and OFF (no LED light).
- When microphone is ON, a slow flash indicates Mic 1 and two slow flashes indicates Mic 2.

2. Microphone Volume Controls

- Press these buttons to adjust the microphone's volume up and down.

3. Wireless Frequency Switch

- Press and hold the Power & Vol - button for approximately 5 seconds to switch to the 2nd preset frequency. A slow flashing white LED on your microphone indicates it is on the 2nd preset frequency.
- Press and hold the Power & Vol + button for approximately 5 seconds to switch to the 1st preset frequency. A fast flashing white LED on your microphone indicates it is on the 1st preset frequency.
- After changing the microphone frequency, use Moment Console App from your smartphone to set the appropriate frequency.

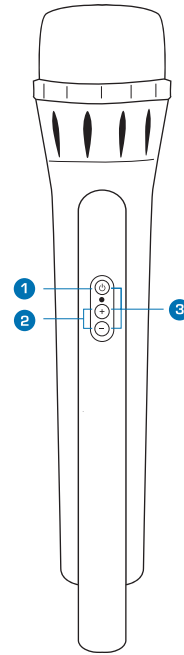

REMINDER

You will need to also use the Moment Console app available on iOS or Android to complete the frequency switch on your Moment Soundbar

Note: If you experience a conflict with other UHF devices (e.g. your TV receiver, a 2nd Moment set) in your house, you might need to switch UHF frequencies on your Moment Wireless Microphone(s).

Basic Troubleshooting

Warning: Do not open the product as there is a risk of electric shock. Under no circumstances should the product be repaired by anyone other than an authorised Moment service center, as this will invalidate the warranty. Please contact Moment Customer Support for more information.

The grill is not removable. Tampering with the grill or grill cloth may damage your Moment Soundbar.

If a problem occurs, you can try the troubleshooting suggestions listed below. If one of these doesn't remedy the problem, or if you are not sure how to proceed, please contact the Moment Customer Support team and we'll be happy to help.

Customer Support

- Visit our Facebook page at www.facebook.com/KaraokeMoment
- Visit our website at www.moment-sound.com
- Email us at support@moment-sound.com

Moment does not turn on

- Is the power cord properly seated? Be sure to push the power cord firmly in until it is flush with the surface.

Moment Subwoofer not detected

- Unplug the AC power outlet connected to your Moment Soundbar.
- Connect AC power outlet to Subwoofer and power ON.
- Press and hold onto the "Pairing" button located on the back of your subwoofer, near the top side.
- Notice that the white LED on the front of your subwoofer is blinking.
- While the white LED on the front of your subwoofer is blinking, connect the AC power to your Moment Soundbar.
- Turn on your Moment Soundbar by tapping on its touch panel, or by using the supplied IR remote.

Your Subwoofer's white LED should be lit up now [not blinking].

No sound from microphone

- Ensure Moment soundbar is in the Karaoke mode. 🔑
- Check that the microphone is turned on with the white LED lit up.
- If microphone frequency is changed, please ensure Moment Soundbar is set to the correct frequency using the Moment Console App.

Flashing LED on microphone

- This indicates that your microphone's battery level is low.
- If the microphone is left ON without activity it will shutdown automatically after 2 minutes to conserve battery.

Replacement/ additional microphone

- Press and hold the Power & Vol - button for 5 seconds, then release Vol - button [still holding on Power button] and press and hold Vol + button for another 5 secs to switch Mic 1 to Mic 2 or vice versa. Your microphone's LED blinks once for Mic 1 while two blinks indicates it is Mic 2.

Turning off your television's speakers

To ensure optimum audio quality, turn off your TV speakers so the sound comes only through your Moment Soundbar.

Can't turn off TV speakers

You should make every effort to turn off your TV's internal speakers. However some brands may not include this setting. If you are unable to turn off the TV speakers, follow the steps below.

- Using the volume control buttons on your television, turn the TV volume all the way down. Do NOT use the Mute button.
- From this point forward use only the volume buttons on your Moment IR Remote Control to adjust Moment Soundbar's volume.

Moment Specifications

Moment Sound Bar

| | |
|----------------|-----------------------|
| Height | 3.54 in |
| Width | 16.14 in |
| Depth | 3.10 in |
| Weight | 4.41 lbs |
| Drivers | 2 x 3" mid-range |
| Tweeters | 2 x 1" high-frequency |
| Stand-by Power | < 0.5W |
| Output Power | 60W |

Connectivity

| | |
|---------------------|---------|
| AUX L/R Audio | 1 |
| Optical Audio | 1 |
| Bluetooth aptX® | 1 |
| Wireless Microphone | Up to 2 |

Warranty

| | |
|-----------------|--------|
| Labor and parts | 1 year |
|-----------------|--------|

Subwoofer

| | |
|----------------|-----------|
| Height | 14.37 in |
| Width | 6.30 in |
| Depth | 12.60 in |
| Weight | 10.23 lbs |
| Driver | 1 x 6.5" |
| Stand-by Power | < 0.5W |
| Output Power | 60W |

In the box

| | |
|------------------------|---|
| Remote Control | 1 |
| Wireless Microphone | 1 |
| AUX L/R Audio Cable | 1 |
| AUX L/R to 3.5mm Cable | 1 |
| Optical Cable | 1 |
| Wall mount brackets | 1 |
| Wireless Subwoofer | 1 |

Warranty

A.C. Ryan
Defining Digital Entertainment

Your Moment™ comes with 12 months limited manufacturer's warranty.

Visit <http://acryan.com> to register your Moment™.

Your Moment™ warranty status and eligibility for support and extended coverage works best with proof of purchase.

We recommend taking a picture of your purchase receipt.



MOMENT

www.moment-sound.com



Manufactured under license from DTS Licensing Limited. DTS, the Symbol, & DTS and the Symbol together are registered trademarks, and DTS TruSurround is a trademark of DTS, Inc. © DTS, Inc. All Rights Reserved.