

## Appendix A

### RF Test Data (Conducted Measurement)

Product Name: VM 1W LoRa modem with dual receiver

Trade Mark: Vision Metering, LLC

Test Model: A-00700-VL

#### Environmental Conditions

Temperature:	22.8° C
Relative Humidity:	53.7%
ATM Pressure:	100.0 kPa
Test Engineer:	Jay Li
Supervised by:	Li Huan

#### A.1 Maximum Conducted Peak Output Power

Mode	Channel.	Maximum Peak Output Power [dBm]	Limit [dBm]	Verdict
LORA	LCH	29.469	30	PASS
	MCH	29.561	30	PASS
	HCH	29.355	30	PASS

Test Graphs

LORA/LCH

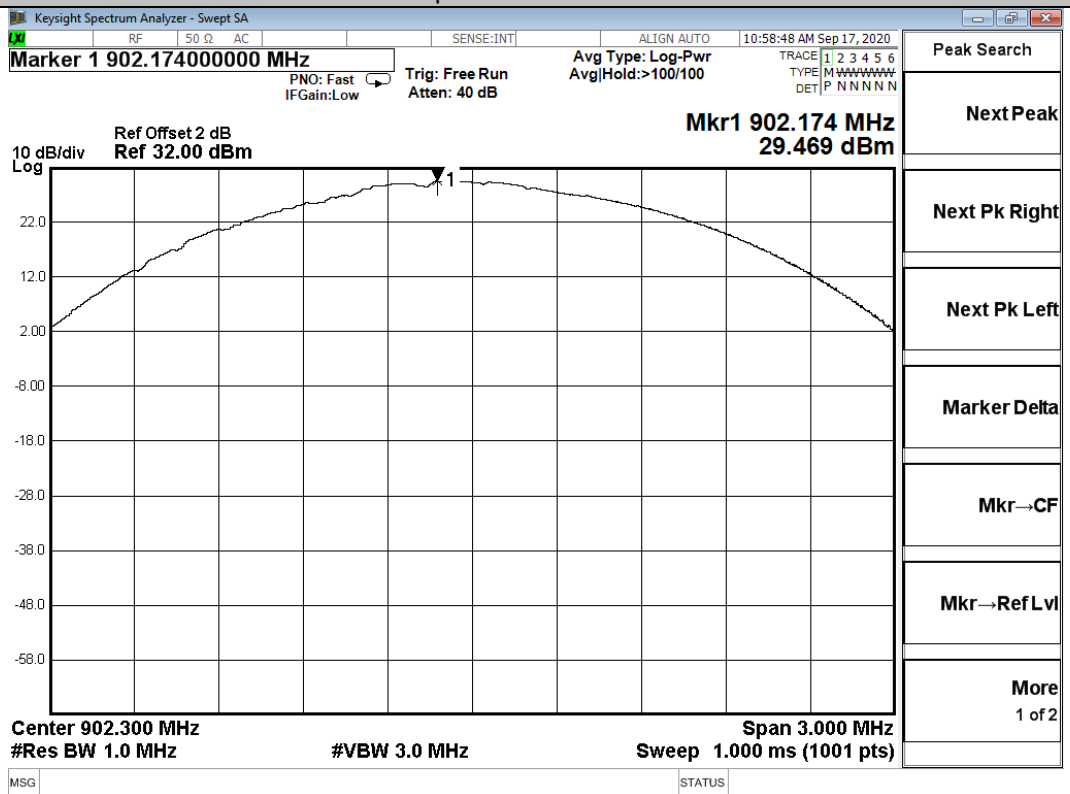

LORA/MCH

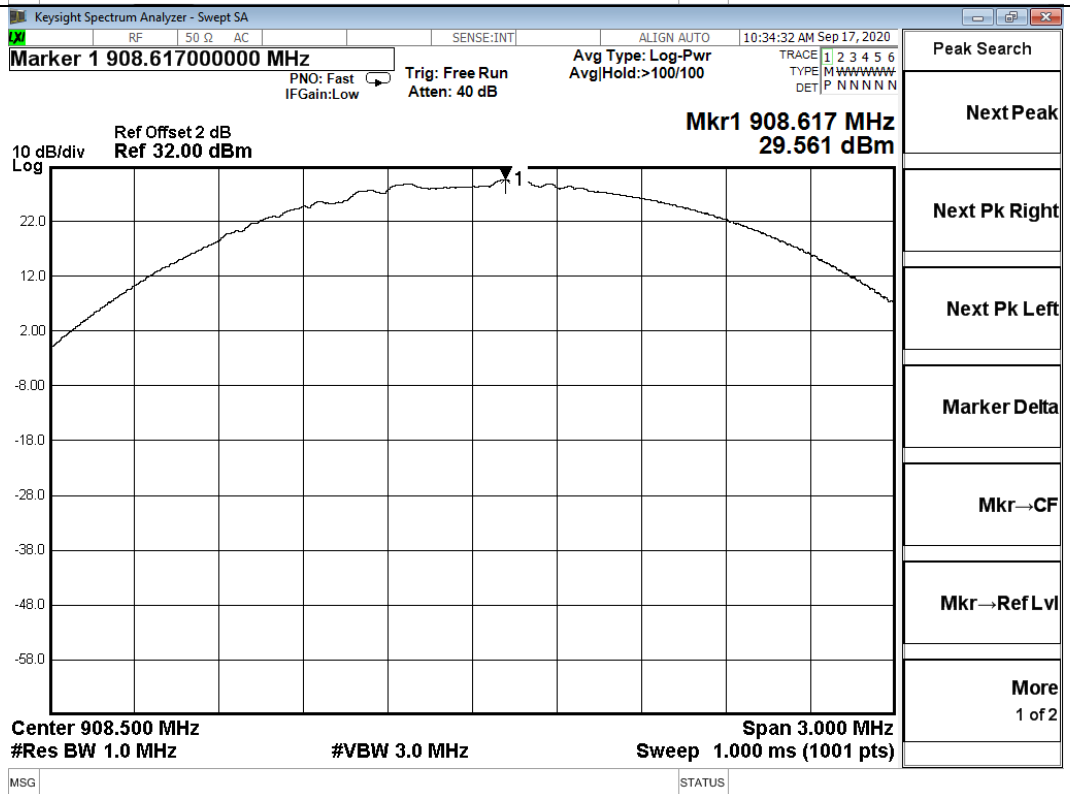

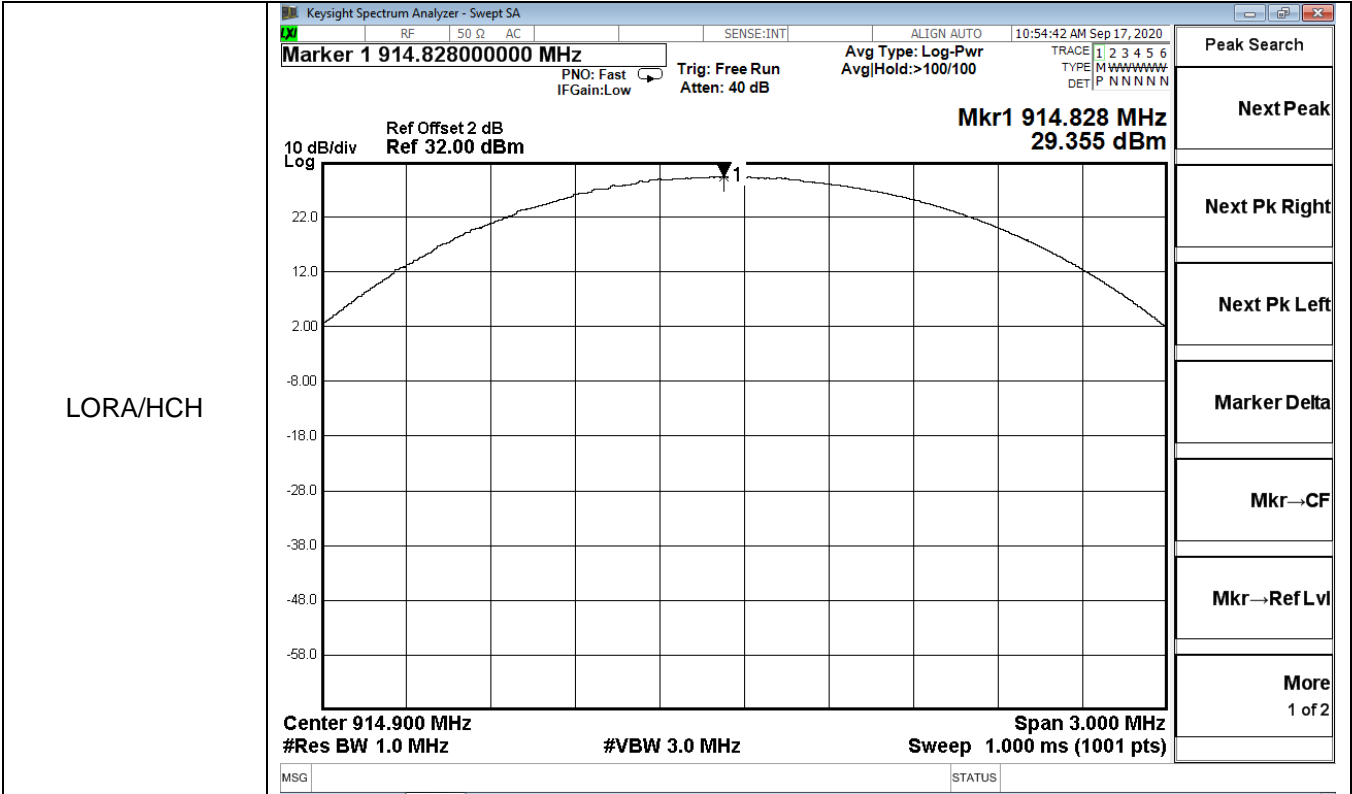

**A.2 20dB Bandwidth**

Mode	Channel.	20dB Bandwidth [KHz]	Limit [KHz]	Verdict
LORA	LCH	136.9	Not Specified	PASS
	MCH	136.8	Not Specified	PASS
	HCH	137.5	Not Specified	PASS

**Test Graphs**

LORA/LCH	<p>Key parameters for LORA/LCH:</p> <ul style="list-style-type: none"> <li>Center Freq: 902.300000 MHz</li> <li>Span: 500.00 kHz</li> <li>Res BW: 3 kHz</li> <li>Occupied Bandwidth: 124.91 kHz</li> <li>Total Power: 27.2 dBm</li> <li>Transmit Freq Error: -1.309 kHz</li> <li>x dB Bandwidth: 136.9 kHz</li> </ul>	Trace/Detector  Clear Write  Average  Max Hold  Min Hold  Detector Average ▶ Auto Man
LORA/MCH	<p>Key parameters for LORA/MCH:</p> <ul style="list-style-type: none"> <li>Center Freq: 908.500000 MHz</li> <li>Span: 500.00 kHz</li> <li>Res BW: 3 kHz</li> <li>Occupied Bandwidth: 125.11 kHz</li> <li>Total Power: 30.7 dBm</li> <li>Transmit Freq Error: -1.415 kHz</li> <li>x dB Bandwidth: 136.8 kHz</li> </ul>	Trace/Detector  Clear Write  Average  Max Hold  Min Hold  Detector Average ▶ Auto Man

LORA/HCH

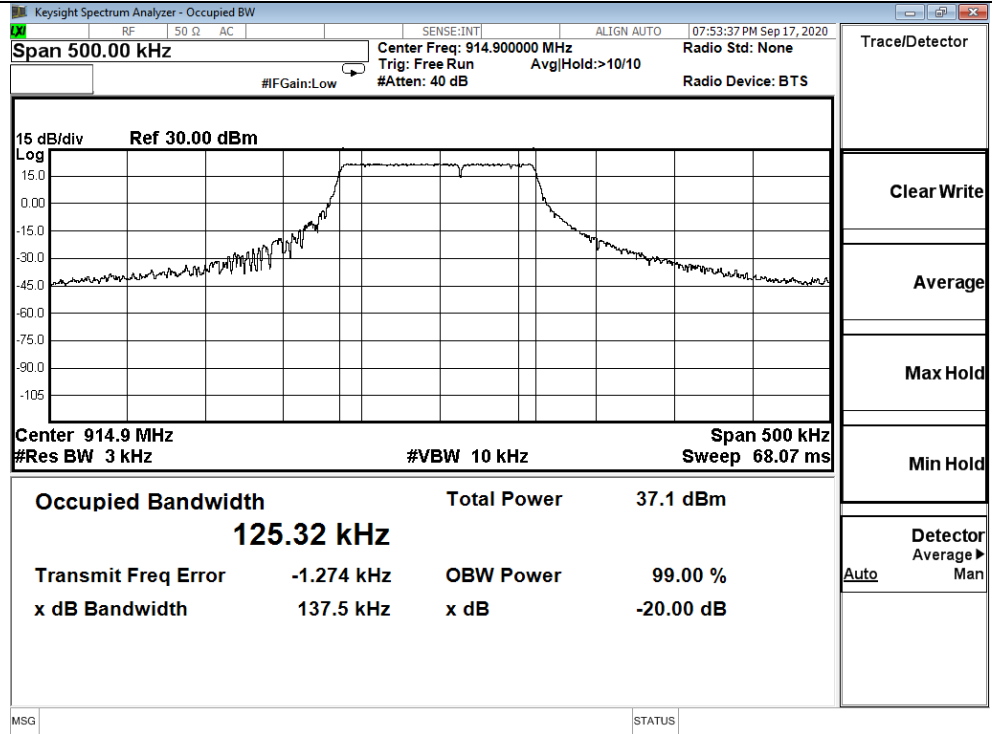

### A.3 Carrier Frequency Separation

Mode	Channel.	Carrier Frequency Separation [KHz]	Limit [KHz]	Verdict
LORA	LCH	429	91.7	PASS
	MCH	425	91.7	PASS
	HCH	426	91.7	PASS

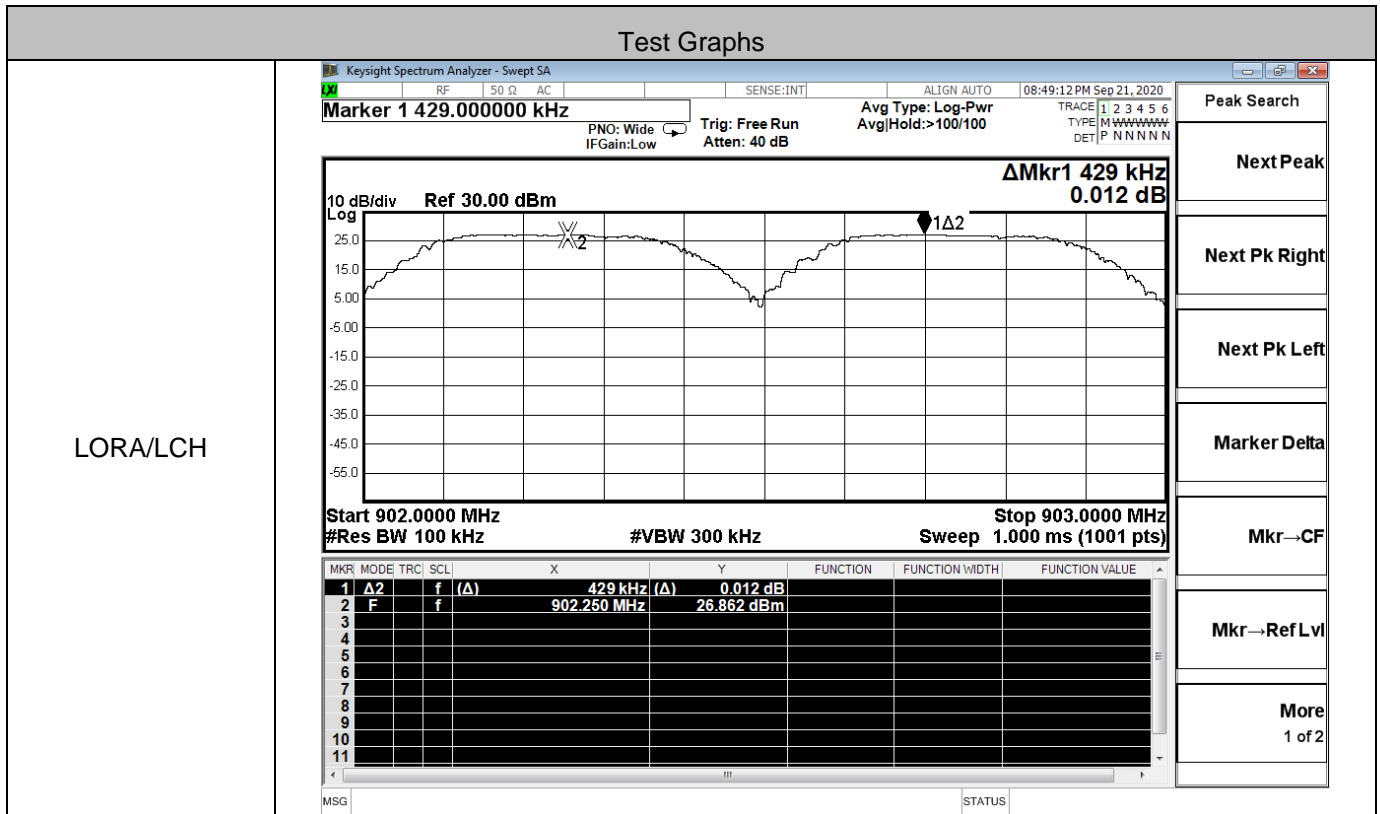

LORA/MCH

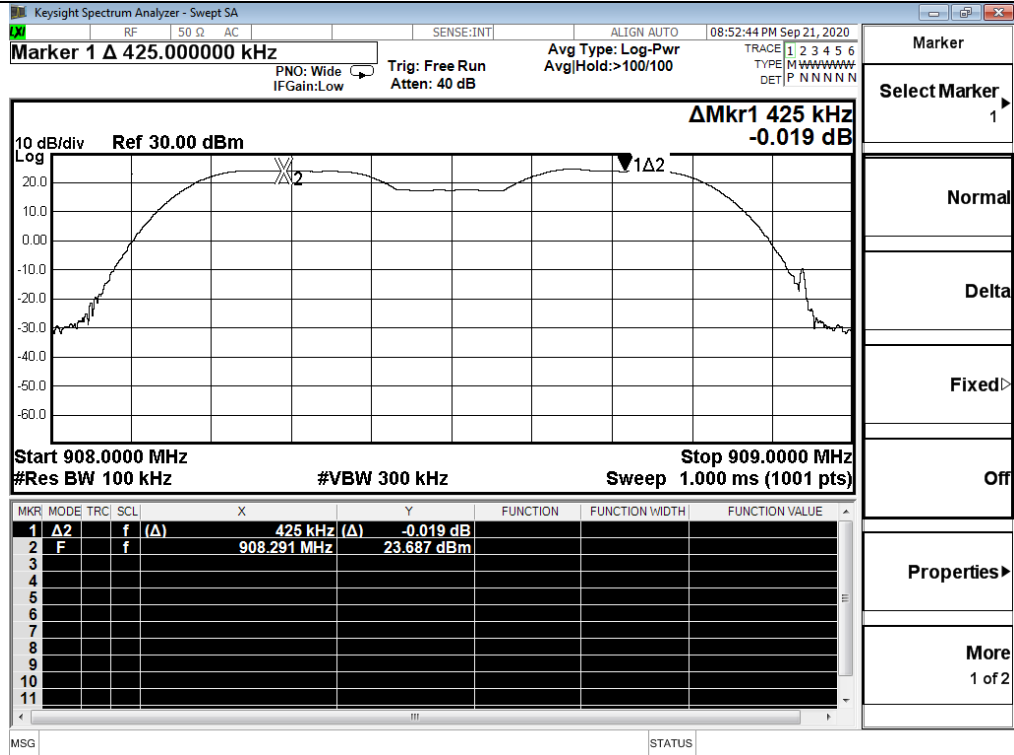

LORA/HCH

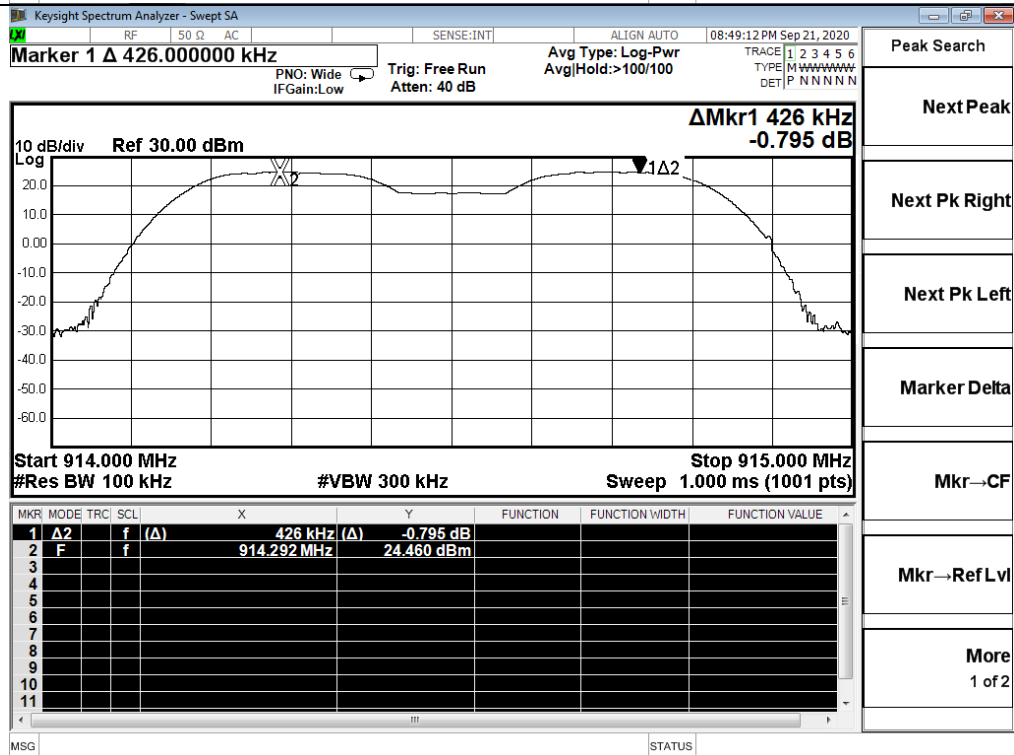

### A.4 Hopping Channel Number

Mode	Channel.	Number of Hopping Channel [N]	Limit [N]	Verdict
LORA	Hop	64	>=50	PASS

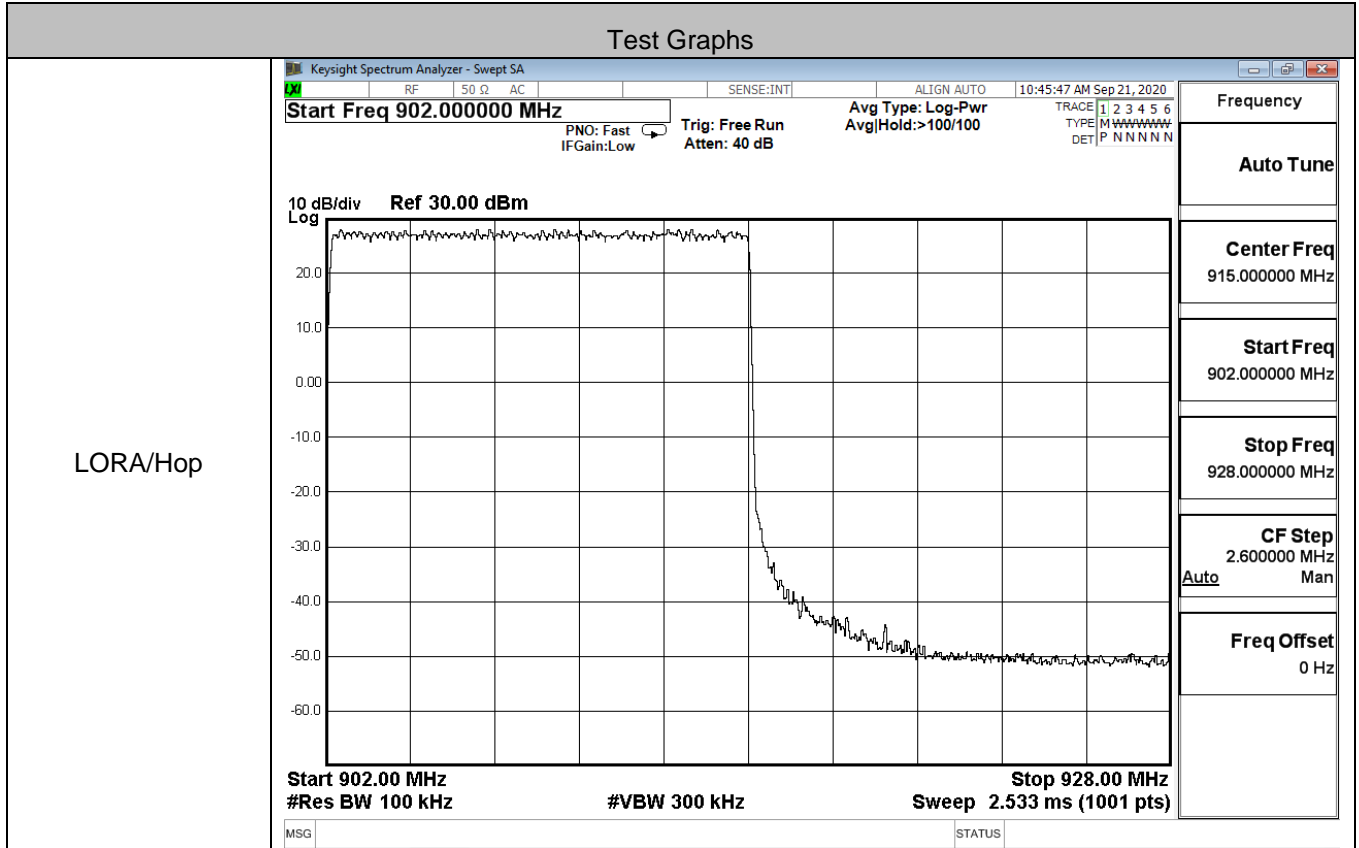

LORA/Hop



### A.5 Dwell Time

Mode	Frequency (MHz)	Burst Width [ms/hop/ch]	Total Hops[hop*ch]	Dwell Time[s]	Limit [s]	Verdict
LORA	908.5	370	1	0.370	0.4	PASS

#### Test Graphs

LORA MCH

Keysight Spectrum Analyzer - Swept SA

Center Freq 908.505000 MHz

Trig Delay: 150.0 ms

Avg Type: Log-Pwr

Trig: Video

Atten: 40 dB

10 dB/div Ref 30.00 dBm

Log

ΔMkr2 370.0 ms

2.19 dB

Center 908.500000 MHz

Res BW 100 kHz

#VBW 300 kHz

Span 0 Hz

Sweep 1.000 s (1001 pts)

MKR	MODE	TRC	SCL	X	Y	FUNCTION	FUNCTION WIDTH	FUNCTION VALUE
1	N	t		153.0 ms	1.63 dBm			
2	Δf	t (Δ)		370.0 ms (Δ)	2.19 dB			

---

Keysight Spectrum Analyzer - Swept SA

Center Freq 908.500000 MHz

Trig: Free Run

Atten: 40 dB

10 dB/div Ref 30.00 dBm

Log

Center 908.500000 MHz

Res BW 100 kHz

#VBW 100 kHz

Span 0 Hz

Sweep 20.00 s (1001 pts)

### A.6 RF Conducted Spurious Emissions

Mode	Channel	Pref [dBm]	Max. Level [dBm]	Limit [dBm]	Verdict
LORA	LCH	22.578	-25.044	2.58	PASS
	HCH	21.382	-28.912	1.38	PASS

LORA\_LCH\_Graphs

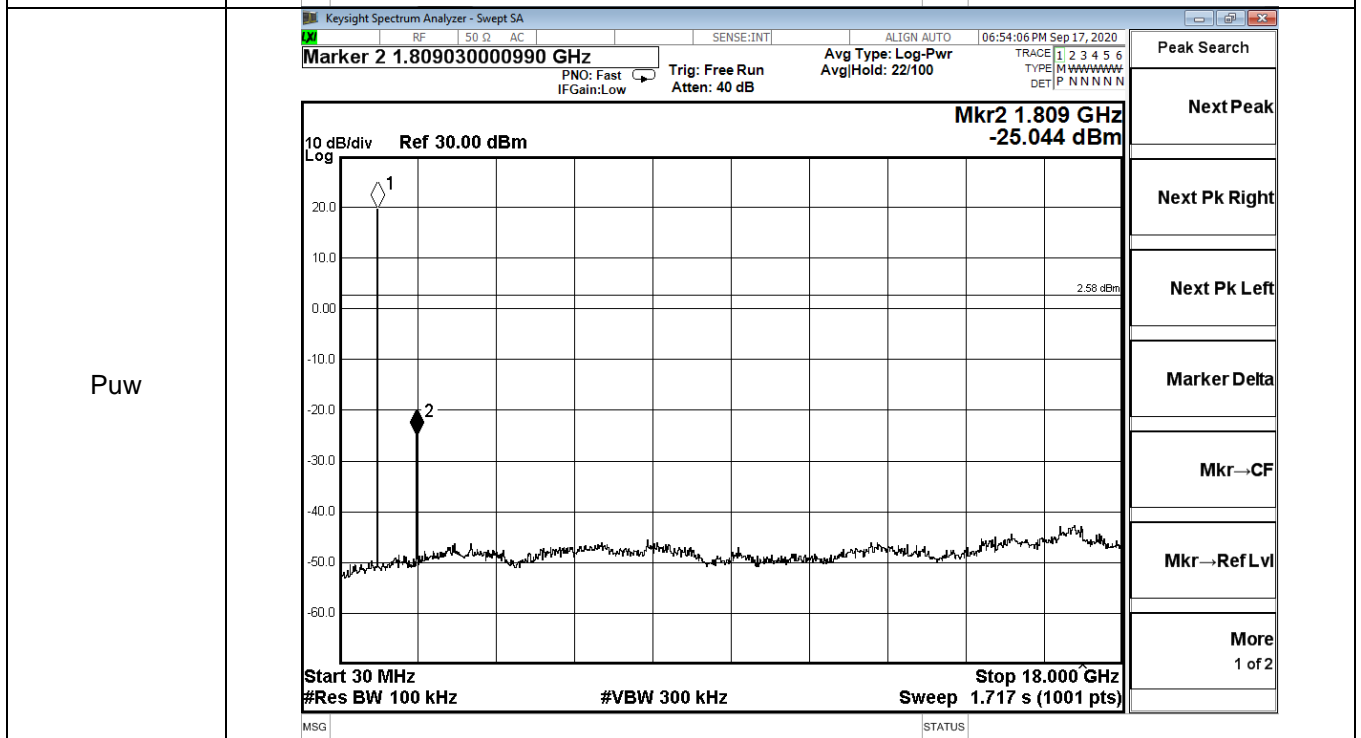
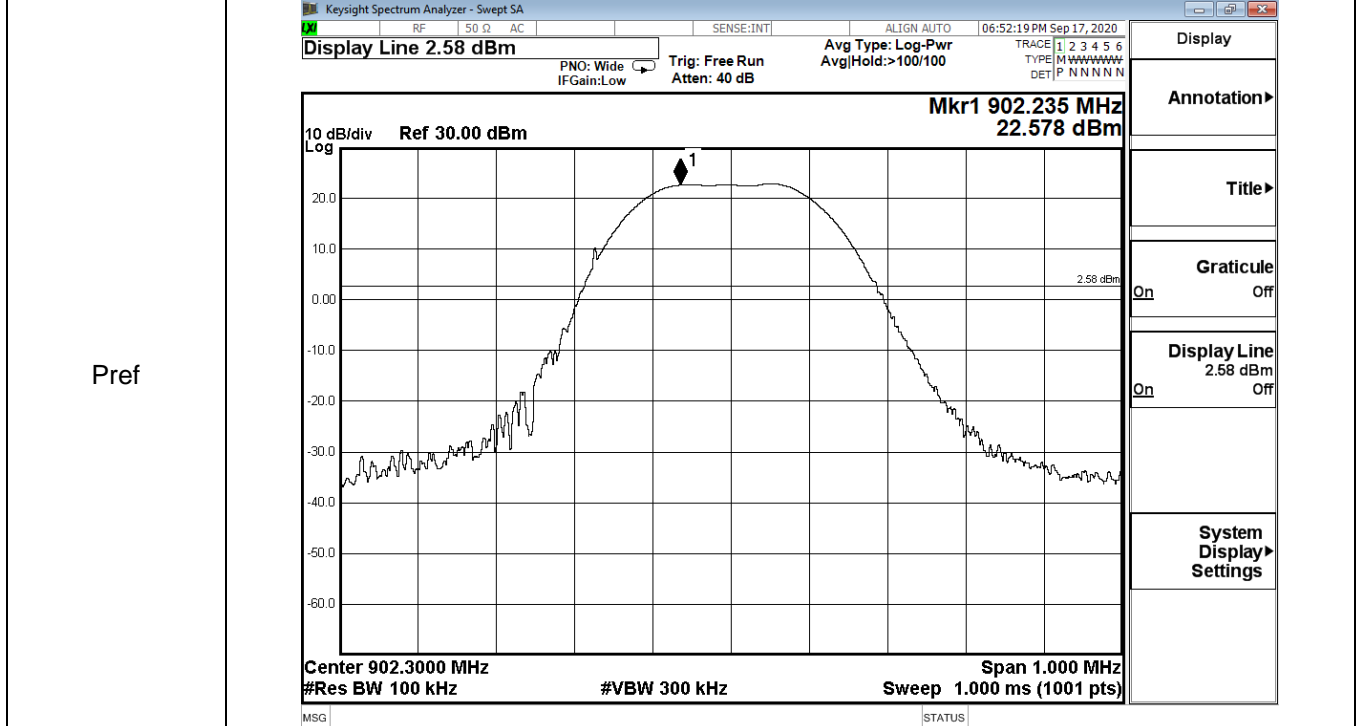

### LORA\_HCH\_Graphs

Pref

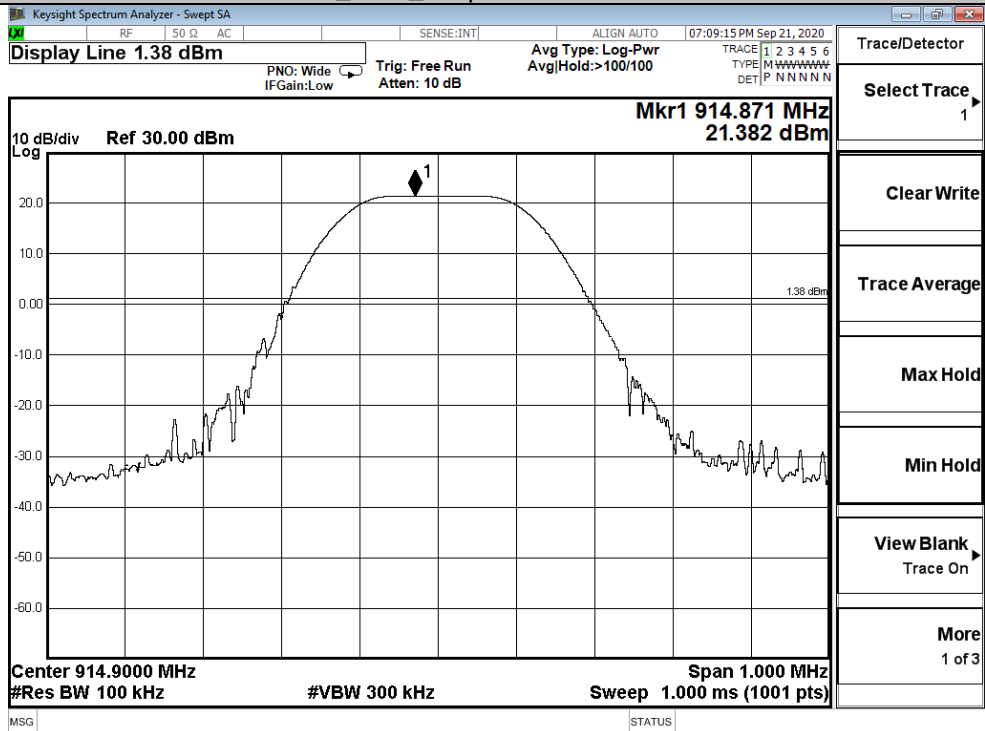

Puw

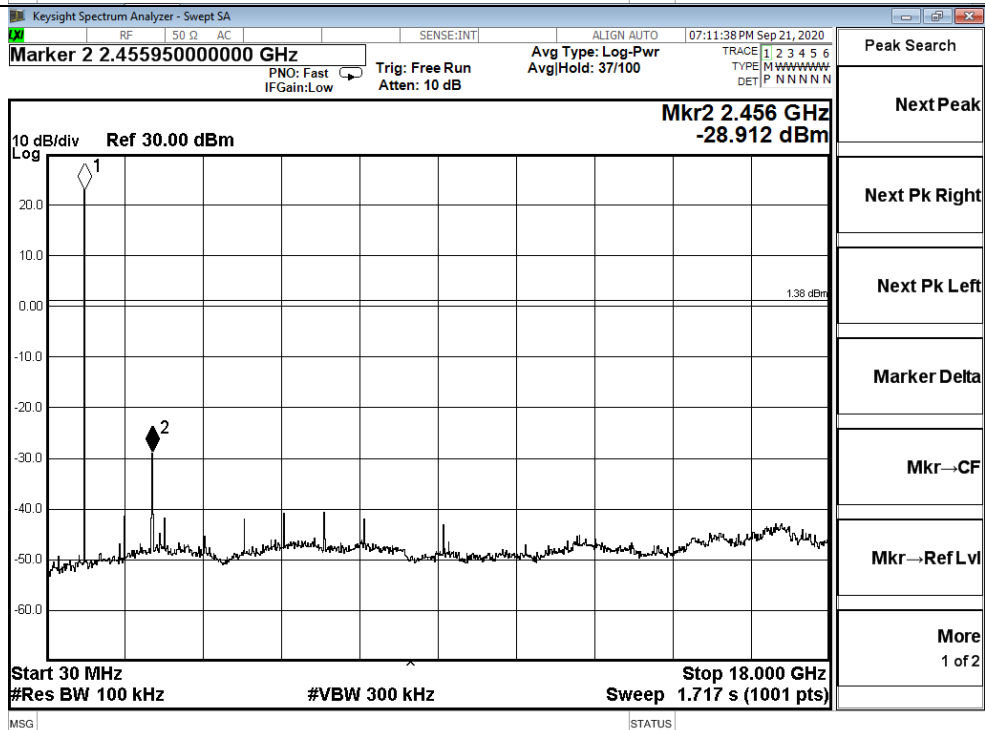

**A.7 Band-edge for RF Conducted Emissions**

Mode	Channel	Carrier Frequency [MHz]	Carrier Power [dBm]	Frequency Hopping	Max Spurious Level [dBm]	Limit [dBm]	Verdict
LORA	LCH	902.3	22.816	Off	-21.653	2.82	PASS
			25.011	On	-40.525	5.01	PASS
	HCH	914.9	18.996	Off	-48.862	-1.00	PASS
			25.013	On	-50.742	5.01	PASS

Test Graphs

LORA/LCH/No Hop

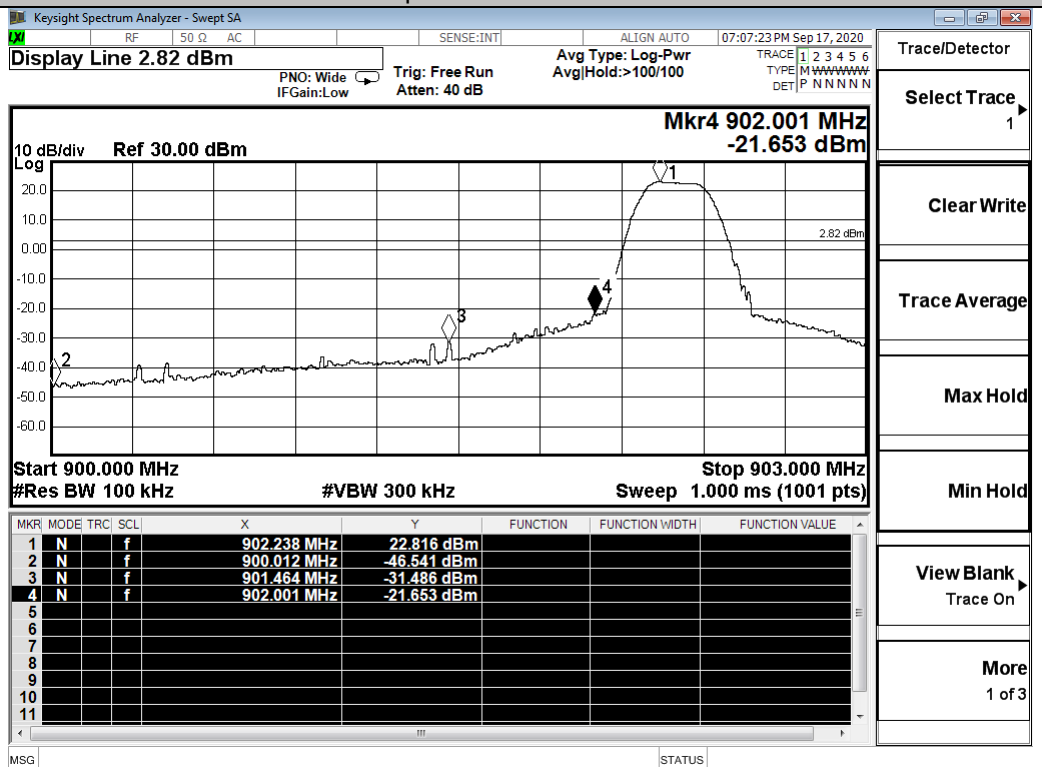

LORA/LCH/Hop

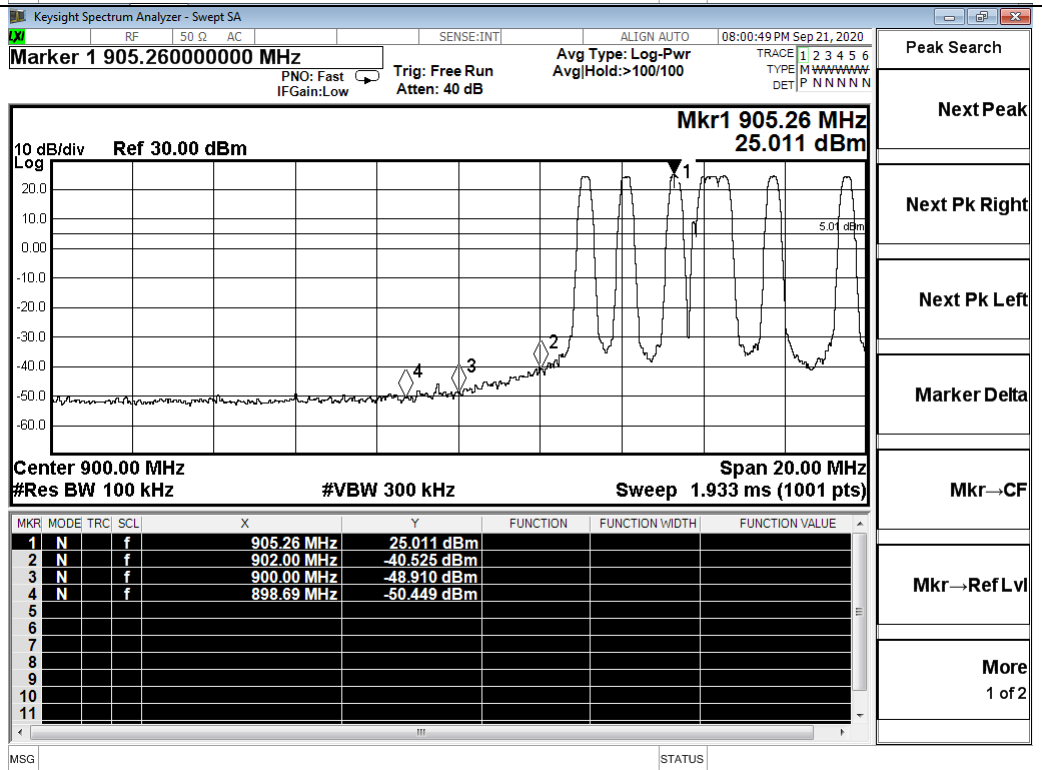

LORA/HCH/No Hop

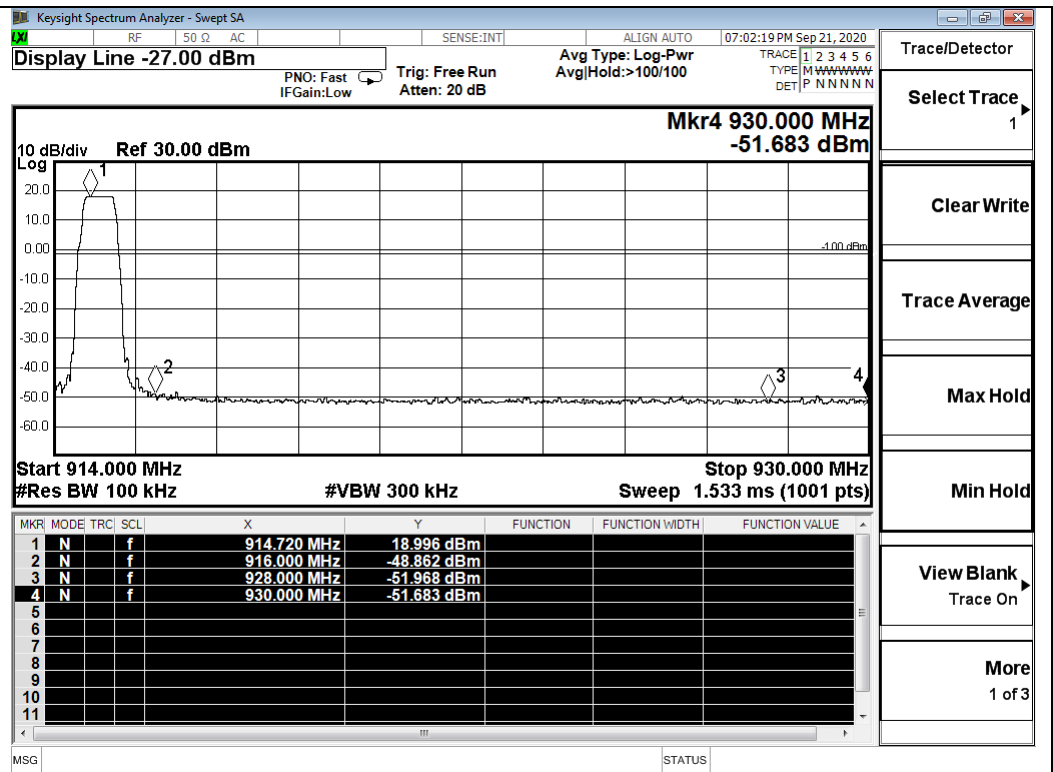

LORA/HCH/Hop

