



SAR Test Report

Report No.: AGC00529140603FH01

FCC ID : Y7WPLUMZ550

APPLICATION PURPOSE : Original Equipment

PRODUCT DESIGNATION : Pilot PLUS

BRAND NAME : plum

MODEL NAME : Z550

CLIENT : CLC Hong Kong Limited

DATE OF ISSUE : July 04,2014

STANDARD(S) : IEEE Std. 1528:2003
47CFR § 2.1093
IEEE/ANSI C95.1

REPORT VERSION : V1.0

Attestation of Global Compliance(Shenzhen) Co., Ltd.



CAUTION:

This report shall not be reproduced except in full without the written permission of the test laboratory and shall not be quoted out of context.

Report Revise Record

Report Version	Revise Time	Issued Date	Valid Version	Notes
V1.0	/	July 04,2014	Valid	Original Report

The test plans were performed in accordance with IEEE Std. 1528:2003; 47CFR § 2.1093; IEEE/ANSI C95.1 and the following specific FCC Test Procedures:

- KDB 447498 D01 General RF Exposure Guidance v05r02
- KDB 648474 D04 SAR Handsets Multi Xmitter and Ant v01
- KDB 865664 D01 SAR measurement 100 MHz to 6 GHz v01r03
- KDB 941225 D01 SAR test for 3G devices v02
- KDB 941225 D02 Guidance for 3GPP R6 and R7 HSPA v02r02
- KDB 941225 D03 SAR Test Reduction GSM GPRS EDGE v01
- KDB 941225 D06 Hot Spot SAR v01
- KDB 248227 D01 SAR meas for 802 11 a b g v01r02

Test Report Certification

Applicant Name	CLC Hong Kong Limited
Applicant Address	1011A, 10/F., Harbour Centre Tower 1, No.1 Hok Cheung St., Hung Hom, Kowloon Hong Kong
Manufacturer Name	CLC Technology Co., Ltd.
Manufacturer Address	Room 6G, Block C, NEO Building, Chegongmiao, Futian District, Shenzhen, P.R. China
Product Designation	Pilot PLUS
Brand Name	plum
Model Name	Z550
Different Description	N/A
EUT Voltage	DC3.7V by battery
Applicable Standard	IEEE Std. 1528:2003 47CFR § 2.1093 IEEE/ANSI C95.1
Test Date	June 26,2014
Performed Location	Attestation of Global Compliance(Shenzhen) Co., Ltd.
	2 F, Building 2, No.1-No.4, Chaxi Sanwei Technical Industrial Park, Gushu, Xixiang Street, Bao'an District, Shenzhen, China
Report Template	AGCRT-US-3G3/SAR (2014-04-01)

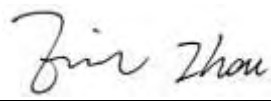
Tested By 
Eric Zhou July 04,2014

Checked By 
Angela Li July 04,2014

Authorized By 
Solger Zhang July 04,2014

TABLE OF CONTENTS

1. SUMMARY OF MAXIMUM SAR VALUE	5
2. GENERAL INFORMATION.....	7
2.1. EUT DESCRIPTION.....	7
2.2. TEST PROCEDURE	9
2.3. TEST ENVIRONMENT	9
2.4. TEST CONFIGURATION AND SETTING	10
3. SAR MEASUREMENT SYSTEM.....	11
3.1. SPECIFIC ABSORPTION RATE (SAR).....	11
3.2. SAR MEASUREMENT PROCEDURE	12
3.3. COMOSAR SYSTEM DESCRIPTION	13
3.4. COMOSAR E-FIELD PROBE	15
3.5. ISOTROPIC E-FIELD PROBE SPECIFICATION	15
3.6. ROBOT.....	15
3.7. VIDEO POSITIONING SYSTEM	16
3.8. DEVICE HOLDER	16
3.9. SAM TWIN PHANTOM.....	17
4. TISSUE SIMULATING LIQUID	18
4.1. THE COMPOSITION OF THE TISSUE SIMULATING LIQUID.....	18
4.2. TISSUE CALIBRATION RESULT	19
4.3. TISSUE DIELECTRIC PARAMETERS FOR HEAD AND BODY PHANTOMS	20
5. SAR MEASUREMENT PROCEDURE.....	21
5.1. SAR SYSTEM VALIDATION PROCEDURES.....	21
5.2. SAR SYSTEM VALIDATION	22
6. EUT TEST POSITION.....	24
6.1. DEFINE TWO IMAGINARY LINES ON THE HANDSET.....	24
6.2. CHEEK POSITION	25
6.3. TITLE POSITION	25
6.4. BODY WORN POSITION.....	26
7. SAR EXPOSURE LIMITS	27
8. TEST EQUIPMENT LIST	28
9. MEASUREMENT UNCERTAINTY	29
10. CONDUCTED POWER MEASUREMENT.....	30
31.33	31
28.45	31
11. TEST RESULTS	36
11.1. SAR TEST RESULTS SUMMARY	36
APPENDIX A. SAR SYSTEM VALIDATION DATA	44
APPENDIX B. SAR MEASUREMENT DATA.....	56
APPENDIX C. TEST SETUP PHOTOGRAPHS &EUT PHOTOGRAPHS.....	124
APPENDIX D. PROBE CALIBRATION DATA	136
APPENDIX E. DIPOLE CALIBRATION DATA	146

1. SUMMARY OF MAXIMUM SAR VALUE

The maximum results of Specific Absorption Rate (SAR) found during testing for EUT are as follows:

Highest Report standalone SAR Summary

Exposure Position	Frequency Band	Highest Tested 1g-SAR(W/Kg)	Highest Scaled Maximum SAR(W/Kg)
Head	GSM 835	0.118	0.149
	PCS 1900	0.339	0.427
	WCDMA Band II	0.745	0.938
	WCDMA Band V	0.209	0.263
Body- worn	GSM 835	0.244	0.307
	PCS 1900	0.189	0.238
	WCDMA Band II	0.358	0.451
	WCDMA Band V	0.393	0.495

Exposure Position	Test Mode	Highest Tested 1g-SAR(W/Kg)	Highest Scaled Maximum SAR(W/Kg)
Head	802.11b	0.256	0.322
	HOTSPOT	0.177	0.223
Body	802.11b	0.154	0.194
	HOTSPOT	0.103	0.130

Highest Simultaneous transmission SAR Summary

Exposure Position	Frequency Band	Highest Simultaneous SAR(W/Kg)
Head	GSM 835+Bluetooth	0.421
	GSM 835+WLAN	
	GSM 835+HOTSPOT	
	PCS 1900+Bluetooth	0.699
	PCS 1900+WLAN	
	PCS 1900+HOTSPOT	
	WCDMA Band II +Bluetooth	1.210
	WCDMA Band II+WLAN	
	WCDMA Band II+HOTSPOT	
	WCDMA Band V +Bluetooth	0.535
	WCDMA Band V+WLAN	
	WCDMA Band V+HOTSPOT	
Body-worn	GSM 835+Bluetooth	0.579
	GSM 835+WLAN	
	GSM 835+HOTSPOT	
	PCS 1900+Bluetooth	0.510
	PCS 1900+WLAN	
	PCS 1900+HOTSPOT	
	WCDMA Band II +Bluetooth	0.723
	WCDMA Band II+WLAN	
	WCDMA Band II+HOTSPOT	
	WCDMA Band V +Bluetooth	0.767
	WCDMA Band V+WLAN	
	WCDMA Band V+HOTSPOT	

This device is compliance with Specific Absorption Rate (SAR) for general population/uncontrolled exposure limits (1.6W/Kg) specified in FCC 47 CFR part 2 (2.1093) and ANSI/IEEE C95.1, and had been tested in accordance with measurement methods and procedures specified in IEEE 1528-2003 and the relevant KDB files like KDB 941225 D01 , KDB 941225 D03 ,KDB 865664 D02....etc.

2. GENERAL INFORMATION

2.1. EUT Description

General Information	
Product Designation	Pilot PLUS
Test Model	Z550
Hardware Version	Q605_MB_V1.0
Software Version	N/A
Device Category	Portable
RF Exposure Environment	Uncontrolled
Antenna Type	Internal
GSM and GPRS&EGPRS	
Support Band	<input checked="" type="checkbox"/> GSM 850 <input checked="" type="checkbox"/> PCS 1900 (U.S. Bands) <input checked="" type="checkbox"/> GSM 900 <input checked="" type="checkbox"/> DCS 1800 (Non-U.S. Bands)
GPRS &EGPRS Type	Class B
GPRS &EGPRS Class	Class 12(1Tx+4Rx, 2Tx+3Rx, 3Tx+2Rx, 4Tx+1Rx)
TX Frequency Range	GSM 850 : 824.2~848.8MHz; PCS 1900: 1850.2~1909.8MHz;
RX Frequency Range	GSM 850 : 869~894MHz PCS 1900: 1930~1990MHz
Release Version	R99
Type of modulation	GMSK for GSM/GPRS, GMSK&8-PSK for EGPRS
Antenna Gain	-1.0dBi(GSM/WCDMA 850), -0.8dBi (GSM/WCDMA 1900)
Max. Average Power (Max. Peak Power)	GSM850: 31.79dBm(32.56dBm- Peak Power) PCS1900: 28.87dBm(29.67dBm-Peak Power)

EUT Description(Continue)

WCDMA	
Support Band	U.S. Bands: <input checked="" type="checkbox"/> UMTS FDD Band II <input checked="" type="checkbox"/> UMTS FDD Band V Non-U.S. Bands: <input type="checkbox"/> UMTS FDD Band I <input type="checkbox"/> UMTS FDD Band III <input type="checkbox"/> UMTS FDD Band VIII
HS Type	HSPA(HSUPA/HSDPA)
TX Frequency Range	WCDMA FDD Band II: 1852.4 -1907.6MHz WCDMA FDD Band V: 826.4-846.6MHz
RX Frequency Range	WCDMA FDD Band II: 1930-1990MHz WCDMA FDD Band V: 869-894MHz
Release Version	Rel-6
Type of modulation	QPSK
Antenna Gain	-1.0dBi(GSM/WCDMA 850), -0.8dBi (GSM/WCDMA 1900)
Max. Average Power (Max. Peak Power)	Band II: 22.99dBm (23.39dBm- Peak Power) Band V: 22.98dBm (23.36dBm- Peak Power)
Bluetooth	
Bluetooth Version	<input type="checkbox"/> V2.0 <input type="checkbox"/> V2.1 <input type="checkbox"/> V2.1+EDR <input checked="" type="checkbox"/> V3.0 <input type="checkbox"/> V3.0+HS <input checked="" type="checkbox"/> V4.0
Operation Frequency	2402~2480MHz
Type of modulation	<input checked="" type="checkbox"/> GFSK <input checked="" type="checkbox"/> II/4-DQPSK <input checked="" type="checkbox"/> 8-DPSK
Avg. Burst Power	7.11dBm
Antenna Gain	1.0dBi
WIFI	
WIFI Specification	<input type="checkbox"/> 802.11a <input checked="" type="checkbox"/> 802.11b <input checked="" type="checkbox"/> 802.11g <input checked="" type="checkbox"/> 802.11n(20) <input checked="" type="checkbox"/> 802.11n(40)
Operation Frequency	2412~2472MHz
Avg. Burst Power	11b: 12.8dBm,11g: 8.06dBm,11n(20): 8.16dBm,11n(40): 3.65dBm
Antenna Gain	1.0dBi
Accessories	
Battery	Brand name: plum Model No. : PMB47 Voltage and Capacitance: 3.7 V &2200Ah
Adapter	Brand name: plum Model No. : PMC43 Input: AC 100-240V, 50/60Hz, 0.2A Output: DC 5V, 1A
Earphone	Brand name: N/A Model No. : N/A

Note: The sample used for testing is end product.

2.2. Test Procedure

1	Setup the EUT and simulators as shown on above.
2	Turn on the power of all equipment.
3	EUT Communicate with 8960, and test them respectively at U.S. bands

2.3. Test Environment

Ambient conditions in the laboratory:

Items	Required	Actual
Temperature (°C)	18-25	21± 2
Humidity (%RH)	30-70	55±2

2.4. Test Configuration and setting

The EUT is a model of GSM Portable Mobile Station (MS). It supports GSM/GPRS/EGPRS, WCDMA/HSPA, BT, WIFI and hotspot mode.

For WWAN SAR testing, the device was controlled by using a base station emulator. Communication between the device and the emulator were established by air link. The distance between the EUT and the antenna is larger than 50cm, and the output power radiated from the emulator antenna is at least 30db smaller than the output power of EUT.

For WLAN testing, the EUT is configured with the WLAN continuous TX tool through engineering command.

Antenna Location:

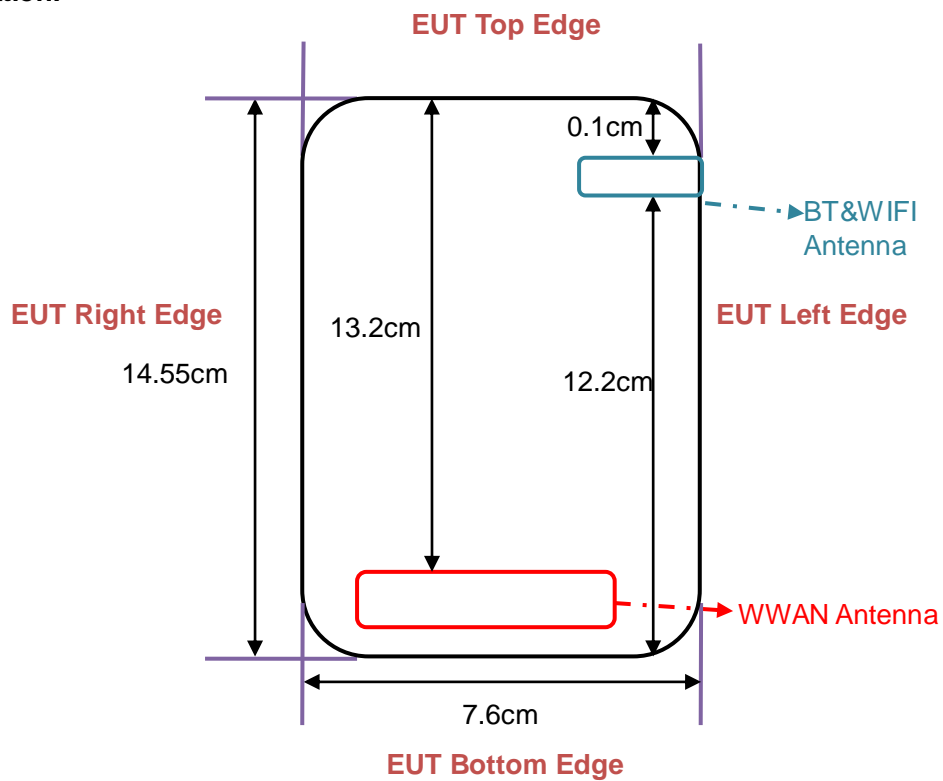

The separation distance for antenna to edge:

Antenna	To Top Side(cm)	To Bottom Side(cm)	To Left Side(cm)	To Right Side(cm)
WWAN	13.6	0.1	1.1	0.1
BT/WIFI	0.1	12.2	6.1	0.1

The simultaneous transmission possibilities are listed as below:

Simultaneous TX Combination	Configuration	Head	Body	Hotspot
1	GSM835(Voice)+WLAN/BT	Yes	Yes	Yes
2	PCS 1900(Voice)+WLAN/BT	Yes	Yes	Yes
3	WCDMA Band II+WLAN/BT	Yes	Yes	Yes
4	WCDMA Band V +WLAN/BT	Yes	Yes	Yes

3. SAR MEASUREMENT SYSTEM

3.1. Specific Absorption Rate (SAR)

SAR is related to the rate at which energy is absorbed per unit mass in object exposed to a radio field. The SAR distribution in a biological body is complicated and is usually carried out by experimental techniques or numerical modeling. The standard recommends limits for two tiers of groups, occupational/controlled and occupational/uncontrolled, based on a person's awareness and ability to exercise control over his or her exposure. In general, occupational/controlled exposure limits are higher than the limits for general population/uncontrolled.

The SAR definition is the time derivative (rate) of the incremental energy (dW) absorbed by (dissipated in) an incremental mass (dm) contained in a volume (dv) of given mass density (ρ). The equation description is as below:

$$SAR = \frac{d}{dt} \left(\frac{dW}{dm} \right) = \frac{d}{dt} \left(\frac{dW}{\rho dV} \right)$$

SAR is expressed in units of Watts per kilogram (W/Kg)

SAR can be obtained using either of the following equations:

$$SAR = \frac{\sigma E^2}{\rho}$$

$$SAR = c_h \left. \frac{dT}{dt} \right|_{t=0}$$

Where

SAR	is the specific absorption rate in watts per kilogram;
E	is the r.m.s. value of the electric field strength in the tissue in volts per meter;
σ	is the conductivity of the tissue in siemens per metre;
ρ	is the density of the tissue in kilograms per cubic metre;
c_h	is the heat capacity of the tissue in joules per kilogram and Kelvin;

$\left. \frac{dT}{dt} \right|_{t=0}$ is the initial time derivative of temperature in the tissue in kelvins per second

3.2. SAR Measurement Procedure

The EUT is set to transmit at the required power in line with product specification, at each frequency relating to the LOW, MID, and HIGH channel settings.

Pre-scans are made on the device to establish the location for the transmitting antenna, using a large area scan in either air or tissue simulation fluid.

The EUT is placed against the Universal Phantom where the maximum area scan dimensions are larger than the physical size of the resonating antenna. When the scan size is not large enough to cover the peak SAR distribution, it is modified by either extending the area scan size in both the X and Y directions, or the device is shifted within the predefined area.

The area scan is then run to establish the peak SAR location (interpolated resolution set at 1mm^2) which is then used to orient the center of the zoom scan. The zoom scan is then executed and the 1g and 10g averages are derived from the zoom scan volume (interpolated resolution set at 1mm^3).

When multiple peak SAR location were found during the same configuration or test mode, Zoom scan shall performed on each peak SAR location, only the peak point with maximum SAR value will be reported for the configuration or test mode.

3.3. COMOSAR System Description

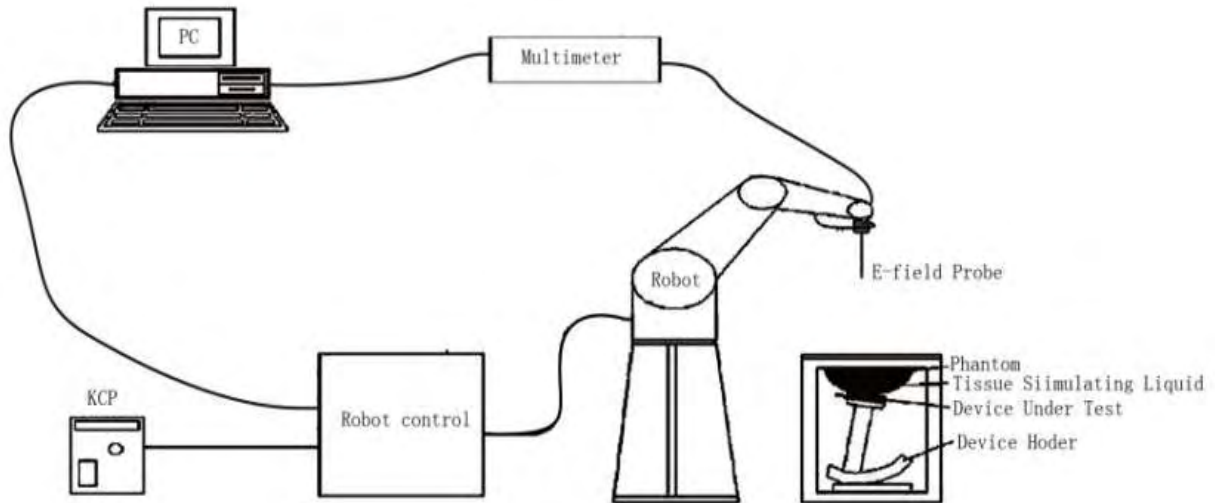

The COMOSAR system for performing compliance tests consists of the following items:

- The PC. It controls most of the bench devices and stores measurement data. A computer running WinXP and the Opensar software.
- The E-Field probe. The probe is a 3-axis system made of 3 distinct dipoles. Each dipole returns a voltage in function of the ambient electric field.
- The Keithley multimeter measures each probe dipole voltages.
- The SAM phantom simulates a human head. The measurement of the electric field is made inside the phantom.
- The liquids simulate the dielectric properties of the human head tissues.
- The network emulator controls the mobile phone under test.
- The validation dipoles are used to measure a reference SAR. They are used to periodically check the bench to make sure that there is no drift of the system characteristics over time.
- The phantom, the device holder and other accessories according to the targeted measurement.

3.3.1. Applications

Predefined procedures and evaluations for automated compliance testing with all worldwide standards, e.g., IEEE 1528, OET 65, IEC 62209-1, IEC 62209-2, EN 50360, EN 50383 and others.

3.3.2. Area Scans

Area scans are defined prior to the measurement process being executed with a user defined variable spacing between each measurement point (integral) allowing low uncertainty measurements to be conducted. Scans defined for FCC applications utilize a 10mm² step integral, with 1mm interpolation used to locate the peak SAR area used for zoom scan assessments.

When an Area Scan has measured all reachable points, it computes the field maxima found in the scanned area, within a range of the global maximum. The range (in dB) is specified in the standards for compliance testing. For example, a 2 dB range is required in IEEE 1528-2003, EN 50361 and IEC 62209 standards, whereby 3 dB is a requirement when compliance is assessed in accordance with the ARIB standard (Japan).

3.3.3. Zoom Scan (Cube Scan Averaging)

Zoom Scans are used to assess the peak spatial SAR values within a cubic averaging volume containing 1 g and 10 g of simulated tissue. A density of 1000 kg/m³ is used to represent the head and body tissue density and not the phantom liquid density, in order to be consistent with the definition of the liquid dielectric properties, i.e. the side length of the 1 g cube is 10mm, with the side length of the 10 g cube 21,5mm.

The zoom scan integer steps can be user defined so as to reduce uncertainty, but normal practice for typical test applications utilize a physical step of 7x7x7 (5mmx5mmx5mm) providing a volume of 30mm in the X & Y axis, and 30mm in the Z axis.

3.3.4. Uncertainty of Inter-/Extrapolation and Averaging

In order to evaluate the uncertainty of the interpolation, extrapolation and averaged SAR calculation algorithms of the Post processor, COMOSAR allows the generation of measurement grids which are artificially predefined by analytically based test functions. Therefore, the grids of area scans and zoom scans can be filled with uncertainty test data, according to the SAR benchmark functions of IEEE 1528. The three analytical functions shown in equations as below are used to describe the possible range of the expected SAR distributions for the tested handsets. The field gradients are covered by the spatially flat distribution f1, the spatially steep distribution f3 and f2 accounts for H-field cancellation on the phantom/tissue surface.

$$f_1(x, y, z) = Ae^{-\frac{z}{2a}} \cos^2 \left(\frac{\pi \sqrt{x'^2 + y'^2}}{2 \cdot 5a} \right)$$

$$f_2(x, y, z) = Ae^{-\frac{z}{a}} \frac{a^2}{a^2 + x'^2} \left(3 - e^{-\frac{2z}{a}} \right) \cos^2 \left(\frac{\pi y'}{2 \cdot 3a} \right)$$

$$f_3(x, y, z) = A \frac{a^2}{\frac{a^2}{4} + x'^2 + y'^2} \left(e^{-\frac{2z}{a}} + \frac{a^2}{2(a + 2z)^2} \right)$$

3.4. COMOSAR E-Field Probe

The SAR measurement is conducted with the dissymmetric probe manufactured by SATIMO. The probe is specially designed and calibrated for use in liquid with high permittivity. The dissymmetric probe has special calibration in liquid at different frequency. SATIMO conducts the probe calibration in compliance with international and national standards (e.g. IEEE 1528, EN62209-1, IEC 62209, etc.) under ISO17025. The calibration data are in Appendix D.

3.5. Isotropic E-Field Probe Specification

Model	SSE5	
Manufacture	SATIMO	
Frequency	0.3GHz-3GHz Linearity:±0.09dB(300MHz-3GHz)	
Dynamic Range	0.01W/Kg-100W/Kg Linearity:±0.09dB	
Dimensions	Overall length:330mm Length of individual dipoles:4.5mm Maximum external diameter:8mm Probe Tip external diameter:5mm Distance between dipoles/ probe extremity:2.7mm	
Application	High precision dosimetric measurements in any exposure scenario (e.g., very strong gradient fields). Only probe which enables compliance testing for frequencies up to 3 GHz with precision of better 30%.	

3.6. Robot

The COMOSAR system uses the KUKA robot from SATIMO SA (France).For the 6-axis controller COMOSAR system, the KUKA robot controller version from SATIMO is used.

The XL robot series have many features that are important for our application:

- High precision (repeatability 0.02 mm)
- High reliability (industrial design)
- Jerk-free straight movements
- Low ELF interference (the closed metallic construction shields against motor control fields)
- 6-axis controller



3.7. Video Positioning System

The video positioning system is used in OpenSAR to check the probe. Which is composed of a camera, LED, mirror and mechanical parts. The camera is piloted by the main computer with firewire link.

During the process, the actual position of the probe tip with respect to the robot arm is measured, as well as the probe length and the horizontal probe offset. The software then corrects all movements, such that the robot coordinates are valid for the probe tip.

The repeatability of this process is better than 0.1 mm. If a position has been taught with an aligned probe, the same position will be reached with another aligned probe within 0.1 mm, even if the other probe has different dimensions. During probe rotations, the probe tip will keep its actual position.

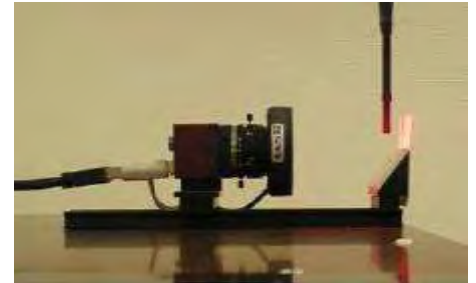

3.8. Device Holder

The COMOSAR device holder is designed to cope with different positions given in the standard. It has two scales for the device rotation (with respect to the body axis) and the device inclination (with respect to the line between the ear reference points). The rotation center for both scales is the ear reference point (EPR).

Thus the device needs no repositioning when changing the angles.

The COMOSAR device holder has been made out of low-loss POM material having the following dielectric parameters: relative permittivity $\epsilon_r = 3$ and loss tangent $\delta = 0.02$. The amount of dielectric material has been reduced in the closest vicinity of the device, since measurements have suggested that the influence of the clamp on the test results could thus be lowered.

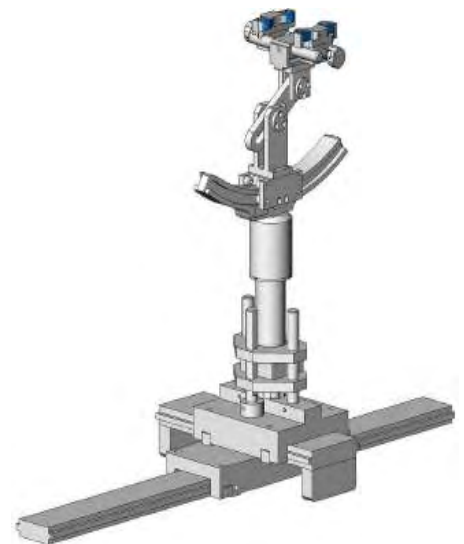

3.9. SAM Twin Phantom

The SAM twin phantom is a fiberglass shell phantom with 2mm shell thickness (except the ear region where shell thickness increases to 6mm). It has three measurement areas:

- Left head
- Right head
- Flat phantom

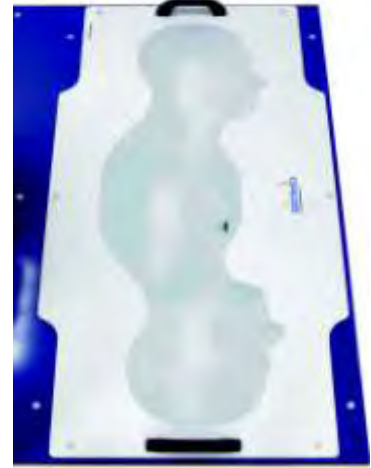

The bottom plate contains three pair of bolts for locking the device holder. The device holder positions are adjusted to the standard measurement positions in the three sections. A white cover is provided to tap the phantom during off-periods to prevent water evaporation and changes in the liquid parameters. On the phantom top, three reference markers are provided to identify the phantom position with respect to the robot.

4.2. Tissue Calibration Result

The dielectric parameters of the liquids were verified prior to the SAR evaluation using COMOSAR Dielectric Probe Kit and R&S Network Analyzer ZVL6 .

Tissue Stimulant Measurement for GSM835							
Fr. (MHz)	Ch.	Dielectric Parameters ($\pm 5\%$)				Tissue Temp [°C]	Test time
		head		body			
		ϵ_r 41.5 39.425-43.575	δ [s/m] 0.90 0.855-0.945	ϵ_r 55.20 52.44-57.96	δ [s/m] 0.97 0.9215-1.0185		
850	128	41.26	0.89	55.46	0.95	21	June 26,2014
850	190	41.94	0.90	55.73	0.98	21	June 26,2014
850	251	41.67	0.87	55.10	0.95	21	June 26,2014

Tissue Stimulant Measurement for PCS 1900							
Fr. (MHz)	Ch.	Dielectric Parameters ($\pm 5\%$)				Tissue Temp [°C]	Test time
		head		body			
		ϵ_r 40.00 38.00-42.00	δ [s/m] 1.40 1.33-1.47	ϵ_r 53.30 50.635-55.965	δ [s/m] 1.52 1.444-1.596		
1900	512	40.31	1.38	53.19	1.53	21	June 26,2014
1900	661	40.19	1.42	53.92	1.49	21	June 26,2014
1900	810	40.29	1.43	53.55	1.50	21	June 26,2014

Tissue Stimulant Measurement for 2450MHz							
Fr. (MHz)	Ch.	Dielectric Parameters ($\pm 5\%$)				Tissue Temp [°C]	Test time
		head		body			
		ϵ_r 39.2 37.24-41.16	δ [s/m] 1.80 1.71-1.89	ϵ_r 52.7 50.065-55.335	δ [s/m] 1.95 1.8525-2.0475		
2450	1	39.16	1.82	52.33	1.93	21	June 26,2014
2450	6	40.00	1.78	52.68	1.90	21	June 26,2014
2450	11	40.23	1.80	52.79	1.95	21	June 26,2014

4.3. Tissue Dielectric Parameters for Head and Body Phantoms

The head tissue dielectric parameters recommended by the IEEE SCC-34/SC-2 in P1528 have been incorporated in the following table. These head parameters are derived from planar layer models simulating the highest expected SAR for the dielectric properties and tissue thickness variations in a human head. Other head and body tissue parameters that have not been specified in P1528 are derived from the tissue dielectric parameters computed from the 4-Cole-Cole equations described in Reference [12] and extrapolated according to the head parameters specified in P1528.

Target Frequency (MHz)	head		body	
	ϵ_r	σ (S/m)	ϵ_r	σ (S/m)
300	45.3	0.87	58.2	0.92
450	43.5	0.87	56.7	0.94
835	41.5	0.90	55.2	0.97
900	41.5	0.97	55.0	1.05
915	41.5	1.01	55.0	1.06
1450	40.5	1.20	54.0	1.30
1610	40.3	1.29	53.8	1.40
1800 – 2000	40.0	1.40	53.3	1.52
2450	39.2	1.80	52.7	1.95
3000	38.5	2.40	52.0	2.73
5800	35.3	5.27	48.2	6.00

(ϵ_r = relative permittivity, σ = conductivity and $\rho = 1000$ kg/m³)

5. SAR MEASUREMENT PROCEDURE

5.1. SAR System Validation Procedures

Each SATIMO system is equipped with one or more system validation kits. These units, together with the predefined measurement procedures within the SATIMO software, enable the user to conduct the system performance check and system validation. System kit includes a dipole, and dipole device holder.

The system check verifies that the system operates within its specifications. It's performed daily or before every SAR measurement. The system check uses normal SAR measurement in the flat section of the phantom with a matched dipole at a specified distance. The system validation setup is shown as below.

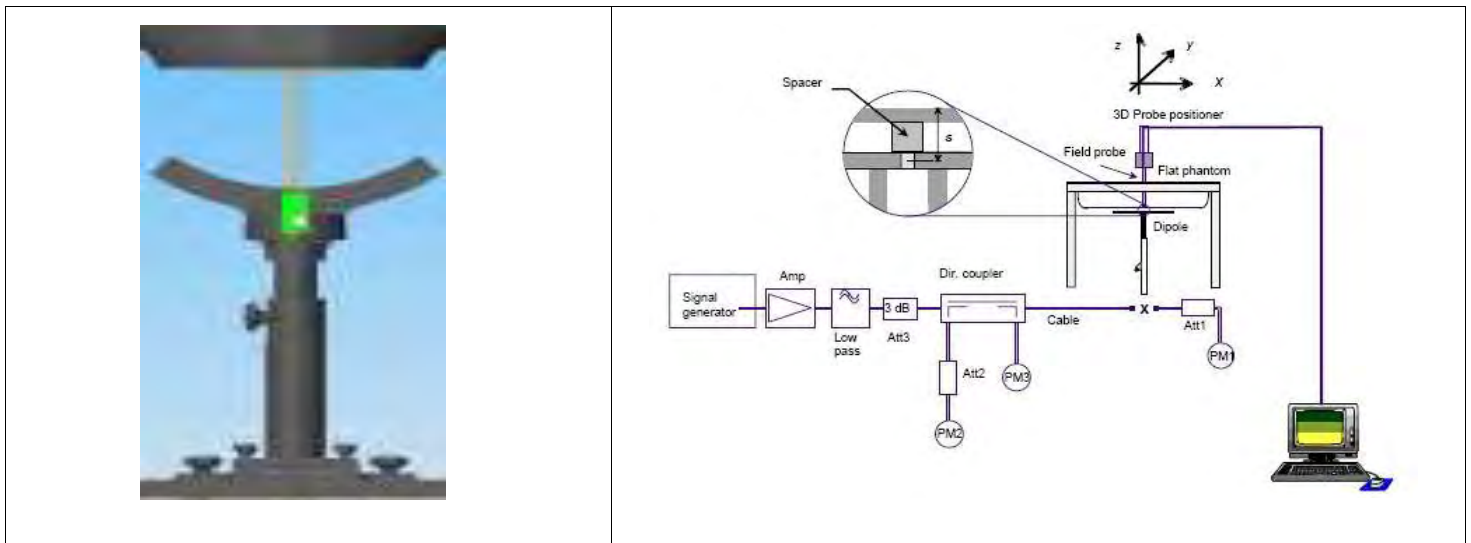

5.2. SAR System Validation
5.2.1. Validation Dipoles

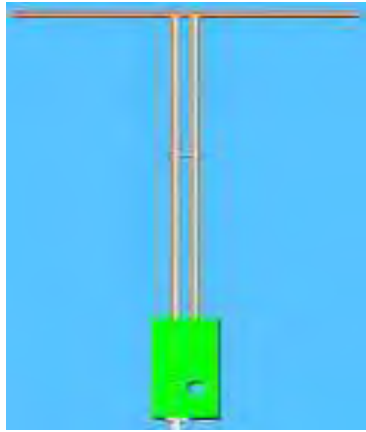

The dipoles used is based on the IEEE-1528 standard, and is complied with mechanical and electrical specifications in line with the requirements of both IEEE and FCC Supplement C. the table below provides details for the mechanical and electrical Specifications for the dipoles.

Frequency	L (mm)	h (mm)	d (mm)
900 MHz	149.0	83.3	3.6
1900MHz	68	39.5	3.6
2450MHz	51.5	30.4	3.6

5.2.2. Validation Result

System Performance Check at 835 MHz &1900MHz & 2450MHz for Head								
Validation Kit: SN 46/11DIP 0G900-185 & SN 46/11DIP 1G900-187 &SN 46/11DIP 2G450-189								
Frequency [MHz]	Target Value(W/Kg)		Reference Result ($\pm 10\%$)		Tested Value(W/Kg)		Tissue Temp. [°C]	Test time
	1g	10g	1g	10g	1g	10g		
835	10.70	6.72	9.63-11.77	6.048-7.392	10.32	6.50	21	June 26,2014
1900	39.65	20.24	35.685-43.615	18.216-22.264	38.74	20.57	21	June 26,2014
2450	54.40	23.75	48.96-59.84	21.375-26.125	49.98	23.90	21	June 26,2014

System Performance Check at 835 MHz &1900MHz & 2450MHz for Body								
Validation Kit: SN 46/11DIP 0G900-185 & SN 46/11DIP 1G900-187 &SN 46/11DIP 2G450-189								
Frequency [MHz]	Target Value(W/Kg)		Reference Result ($\pm 10\%$)		Tested Value(W/Kg)		Tissue Temp. [°C]	Test time
	1g	10g	1g	10g	1g	10g		
835	11.27	7.18	10.143-12.397	6.462-7.898	10.90	6.81	21	June 26,2014
1900	40.74	21.43	36.666-44.814	19.287-23.573	39.75	20.86	21	June 26,2014
2450	54.19	24.96	48.771-59.609	22.464-27.456	49.99	23.88	21	June 26,2014

6. EUT TEST POSITION

This EUT was tested in **Right Cheek, Right Titled, Left Cheek, Left Titled, Front Face and Rear Face.**

6.1. Define Two Imaginary Lines on the Handset

- (1)The vertical centerline passes through two points on the front side of the handset the midpoint of the width w_t of the handset at the level of the acoustic output, and the midpoint of the width w_b of the handset.
- (2)The horizontal line is perpendicular to the vertical centerline and passes through the center of the acoustic output. The horizontal line is also tangential to the face of the handset at point A.
- (3)The two lines intersect at point A. Note that for many handsets, point A coincides with the center of the acoustic output; however, the acoustic output may be located elsewhere on the horizontal line. Also note that the vertical centerline is not necessarily to the front face of the handset, especially for clamshell handsets, handsets with flip covers, and other irregularly shaped handsets.

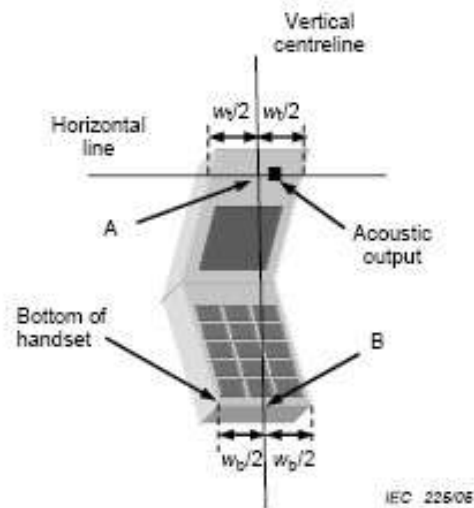
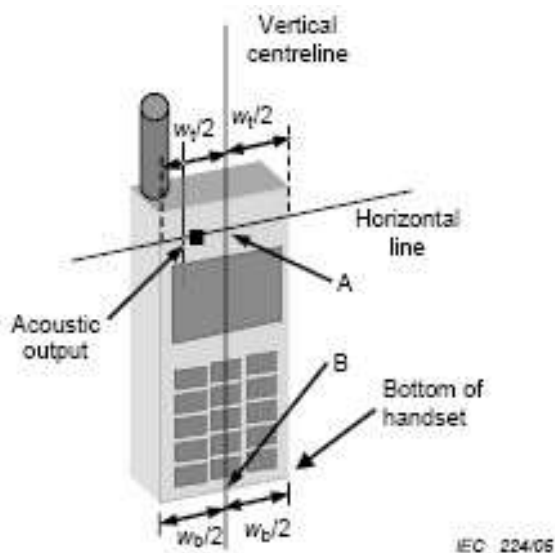

6.2. Cheek Position

- (1) To position the device with the vertical center line of the body of the device and the horizontal line crossing the center piece in a plane parallel to the sagittal plane of the phantom. While maintaining the device in this plane, align the vertical center line with the reference plane containing the ear and mouth reference point (M: Mouth, RE: Right Ear, and LE: Left Ear) and align the center of the ear piece with the line RE-LE.
- (2) To move the device towards the phantom with the ear piece aligned with the the line LE-RE until the phone touched the ear. While maintaining the device in the reference plane and maintaining the phone contact with ear, move the bottom of the phone until any point on the front side is in contact with the cheek of the phantom or until contact with the ear is lost



6.3. Title Position

- (1) To position the device in the “cheek” position described above.
- (2) While maintaining the device in the reference plane described above and pivoting against the ear, moves it outward away from the mouth by an angle of 15 degrees or until with the ear is lost.



6.4. Body Worn Position

- (1) To position the EUT parallel to the phantom surface.
- (2) To adjust the EUT parallel to the flat phantom.
- (3) To adjust the distance between the EUT surface and the flat phantom to **5mm**.

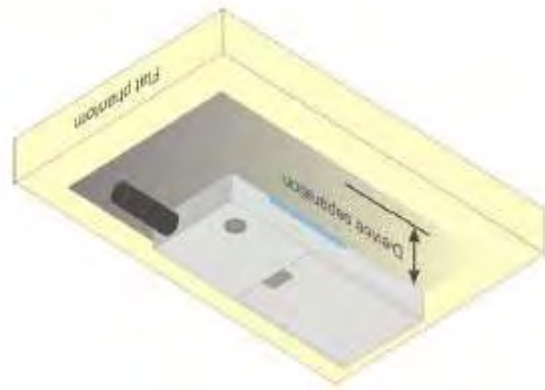

7. SAR EXPOSURE LIMITS

SAR assessments have been made in line with the requirements of IEEE-1528, FCC Supplement C, and comply with ANSI/IEEE C95.1-1992 "Uncontrolled Environments" limits. These limits apply to a location which is deemed as "Uncontrolled Environment" which can be described as a situation where the general public may be exposed to an RF source with no prior knowledge or control over their exposure.

Limits for General Population/Uncontrolled Exposure (W/kg)

Type Exposure	Uncontrolled Environment Limit
Spatial Peak SAR (1g cube tissue for brain or body)	1.60 W/kg

8. TEST EQUIPMENT LIST

Equipment description	Manufacturer/ Model	Identification No.	Current calibration date	Next calibration date
SAR Probe	SATIMO	SN 22/12 EP159	01/12/2014	01/11/2015
Phantom	SATIMO	SN_4511_SAM90	Validated. No cal required.	Validated. No cal required.
Liquid	SATIMO	-	Validated. No cal required.	Validated. No cal required.
Comm Tester	R&S - CMU200	069Y7-158-13-712	02/17/2014	02/16/2015
Comm Tester	Agilent-8960	GB46310822	02/17/2014	02/16/2015
Multimeter	Keithley 2000	1188656	02/17/2014	02/16/2015
Dipole	SATIMO SID900	SN46/11 DIP 0G900-185	11/14/2013	11/13/2015
Dipole	SATIMO SID1900	SN46/11 DIP 1G900-187	11/14/2013	11/13/2015
Dipole	SATIMO SID2450	SN46/11 DIP 2G450-189	11/14/2013	11/13/2015
Amplifier	Aethercomm	SN 046	12/08/2013	12/07/2014
Signal Generator	Agilent- E4438C	MY44260051	02/23/2014	02/22/2015
Power Probe	HP E4418A	US38261498	02/17/2014	02/16/2015
SPECTRUM ANALYZER	Agilent/E4440A	MY44303916	10/22/2013	10/21/2014
Power Attenuator	BED	DLA-5W	07/30/2013	07/29/2014
Network Analyzer	Rhode & Schwarz ZVA	SN100132	02/17/2014	02/16/2015

Note: Per KDB 865664 Dipole SAR Validation Verification, AGC Lab has adopted 3 years calibration intervals. On annual basis, every measurement dipole has been evaluated and is in compliance with the following criteria:

1. There is no physical damage on the dipole;
2. System validation with specific dipole is within 10% of calibrated value;
3. Return-loss is within 20% of calibrated measurement;
4. Impedance is within 5Ω of calibrated measurement.

9. MEASUREMENT UNCERTAINTY

SATIMO Uncertainty									
Measurement uncertainty for 300MHz to 3GHz averaged over 1 gram / 10 gram.									
Error Description	Sec	Sec	Tol (±%)	Prob. Dist.	(Ci) 1g	(Ci) 10g	Std. Unc. (1g) (±%)	Std. Unc. (10g)(±%)	(Vi) Veff
Measurement System									
Probe Calibration	E.2.1	6	N	1	1	1	6	6	∞
Axial Isotropy	E.2.2	3	R	$\sqrt{3}$	$(1 - C_p)^{1/2}$	$(1 - C_p)^{1/2}$	1.22474	1.22474	∞
Hemispherical Isotropy	E.2.2	5	R	$\sqrt{3}$	$\sqrt{C_p}$	$\sqrt{C_p}$	2.04124	2.04124	∞
Boundary Effects	E.2.3	1	R	$\sqrt{3}$	1	1	0.57735	0.57735	∞
Linearity	E.2.4	5	R	$\sqrt{3}$	1	1	2.88675	2.88675	∞
System Detection Limits	E.2.5	1	R	$\sqrt{3}$	1	1	0.57735	0.57735	∞
Readout Electronics	E.2.6	0.5	N	1	1	1	0.5	0.5	∞
Response Time	E.2.7	0.2	R	$\sqrt{3}$	1	1	0.11547	0.11547	∞
Integration Time	E.2.8	2	R	$\sqrt{3}$	1	1	1.1547	1.1547	∞
RF Ambient Noise	E.6.1	3	R	$\sqrt{3}$	1	1	1.73205	1.73205	∞
Probe Positioner Mechanical Tolerance	E.6.2	2	R	$\sqrt{3}$	1	1	1.1547	1.1547	∞
Probe Positioning with Respect to Phantom Shell	E.6.3	1	R	$\sqrt{3}$	1	1	0.57735	0.57735	∞
Extrapolation, interpolation and Integration Algorithms for Max. SAR Evaluation	E.5.2	1.5	R	$\sqrt{3}$	1	1	0.86603	0.86603	∞
Dipole									
Device Positioning	8,E.4.2	1	N	$\sqrt{3}$	1	1	0.57735	0.57735	N-1
Power Drift	8.6.6.2	2	R	$\sqrt{3}$	1	1	1.1547	1.1547	∞
Phantom and Tissue Parameters									
Phantom Uncertainty	E.3.1	4	R	$\sqrt{3}$	1	1	2.3094	2.3094	∞
Liquid Conductivity (target)	E.3.2	5	R	$\sqrt{3}$	0.64	0.43	1.84752	1.2413	∞
Liquid Conductivity (meas.)	E.3.3	2.5	N	1	0.64	0.43	1.6	1.075	∞
Liquid Permittivity (target)	E.3.2	3	R	$\sqrt{3}$	0.6	0.49	1.03923	0.8487	∞
Liquid Permittivity (meas.)	E.3.3	2.5	N	1	0.6	0.49	1.5	1.225	M
Combined Standard Uncertainty			RSS				8.09272	7.9296	
Expanded Uncertainty (95%CONFIDENCE INTERVAL)			k				16.18544	15.8592	

10. CONDUCTED POWER MEASUREMENT GSM BAND

Mode	Frequency(MHz)	Avg. Burst Power(dBm)	Duty cycle Factor(dBm)	Frame Power(dBm)
Maximum Power <1>				
GSM 850	824.2	31.79	-9	22.79
	836.6	31.75	-9	22.75
	848.8	31.72	-9	22.72
GPRS 850 (1 Slot)	824.2	31.71	-9	22.71
	836.6	31.67	-9	22.67
	848.8	31.63	-9	22.63
GPRS 850 (2 Slot)	824.2	28.72	-6	22.72
	836.6	28.64	-6	22.64
	848.8	28.61	-6	22.61
GPRS 850 (3 Slot)	824.2	26.65	-4.26	22.39
	836.6	26.62	-4.26	22.36
	848.8	26.58	-4.26	22.32
GPRS 850 (4 Slot)	824.2	25.63	-3	22.63
	836.6	25.57	-3	22.57
	848.8	25.51	-3	22.51
EGPRS 850 (1 Slot)	824.2	26.27	-9	35.27
	836.6	26.22	-9	35.22
	848.8	26.19	-9	35.19
EGPRS 850 (2 Slot)	824.2	24.82	-6	30.82
	836.6	24.78	-6	30.78
	848.8	24.68	-6	30.68
EGPRS 850 (3 Slot)	824.2	22.73	-4.26	26.99
	836.6	22.65	-4.26	26.91
	848.8	22.59	-4.26	26.85
EGPRS 850 (4 Slot)	824.2	21.84	-3	24.84
	836.6	21.77	-3	24.77
	848.8	21.73	-3	24.73

Continue

Mode	Frequency(MHz)	Avg. Burst Power(dBm)	Duty cycle Factor(dBm)	Frame Power(dBm)
Maximum Power <1>				
PCS1900	1850.2	28.87	-9	19.87
	1880	28.82	-9	19.82
	1909.8	28.77	-9	19.77
GPRS1900 (1 Slot)	1850.2	28.78	-9	19.78
	1880	28.76	-9	19.76
	1909.8	28.72	-9	19.72
GPRS1900 (2 Slot)	1850.2	25.72	-6	19.72
	1880	25.68	-6	19.68
	1909.8	25.64	-6	19.64
GPRS1900 (3 Slot)	1850.2	23.92	-4.26	19.66
	1880	23.88	-4.26	19.62
	1909.8	23.84	-4.26	19.58
GPRS1900 (4 Slot)	1850.2	22.73	-3	19.73
	1880	22.71	-3	19.71
	1909.8	22.68	-3	19.68
EGPRS1900 (1 Slot)	1850.2	25.14	-9	34.14
	1880	25.12	-9	34.12
	1909.8	25.09	-9	34.09
EGPRS1900 (2 Slot)	1850.2	23.73	-6	29.73
	1880	23.67	-6	29.67
	1909.8	23.63	-6	29.63
EGPRS1900 (3 Slot)	1850.2	22.08	-4.26	26.34
	1880	22.05	-4.26	26.31
	1909.8	22.03	-4.26	26.29
EGPRS1900 (4 Slot)	1850.2	20.86	-3	23.86
	1880	20.75	-3	23.75
	1909.8	20.72	-3	23.72
Maximum Power <2>				
GSM 835	836.6	31.33	-9	40.33
PCS1900	1850.2	28.45	-9	37.45

Note 1:

The Frame Power (Source-based time-averaged Power) is scaled the maximum burst average power based on time slots. The calculated methods are show as following:

Frame Power = Max burst power (1 Up Slot) – 9 dB

Frame Power = Max burst power (2 Up Slot) – 6 dB

Frame Power = Max burst power (3 Up Slot) -4.26dB

Frame Power = Max burst power (4 Up Slot) – 3 dB

UMTS BAND II

Mode	Frequency (MHz)	Avg. Burst Power (dBm)
WCDMA 1900 RMC	1852.4	22.99
	1880	22.92
	1907.6	22.89
WCDMA 1900 AMR	1852.4	22.15
	1880	22.14
	1907.6	22.08
HSDPA Subtest 1	1852.4	22.07
	1880	22.06
	1907.6	22.02
HSDPA Subtest 2	1852.4	22.16
	1880	22.14
	1907.6	22.11
HSDPA Subtest 3	1852.4	22.24
	1880	22.22
	1907.6	22.17
HSDPA Subtest 4	1852.4	22.19
	1880	22.15
	1907.6	22.13
HSUPA Subtest 1	1852.4	22.1
	1880	22.06
	1907.6	22.04
HSUPA Subtest 2	1852.4	22.13
	1880	22.11
	1907.6	22.04
HSUPA Subtest 3	1852.4	22.13
	1880	22.12
	1907.6	22.08
HSUPA Subtest 4	1852.4	22.06
	1880	22.05
	1907.6	22.01
HSUPA Subtest 5	1852.4	22.26
	1880	22.23
	1907.6	22.18

UMTS BAND V

Mode	Frequency (MHz)	Avg. Burst Power (dBm)
WCDMA 835 RMC	826.4	22.98
	836.6	22.93
	846.6	22.9
WCDMA 835 AMR	826.4	22.15
	836.6	22.12
	846.6	22.07
HSDPA Subtest 1	826.4	22.11
	836.6	22.08
	846.6	22.06
HSDPA Subtest 2	826.4	22.12
	836.6	22.08
	846.6	22.06
HSDPA Subtest 3	826.4	22.18
	836.6	22.14
	846.6	22.12
HSDPA Subtest 4	826.4	22.17
	836.6	22.14
	846.6	22.13
HSUPA Subtest 1	826.4	22.16
	836.6	22.13
	846.6	22.08
HSUPA Subtest 2	826.4	22.15
	836.6	22.13
	846.6	22.09
HSUPA Subtest 3	826.4	22.11
	836.6	22.08
	846.6	22.06
HSUPA Subtest 4	826.4	22.08
	836.6	22.04
	846.6	22.02
HSUPA Subtest 5	826.4	22.06
	836.6	22.03
	846.6	22.01

WIFI

Mode	Data Rate (Mbps)	Channel	Frequency(MHz)	Avg. Burst Power(dBm)
802.11b	1	01	2412	10.57
		06	2437	12.56
		11	2462	12.8
802.11g	6	01	2412	6.1
		06	2437	7.59
		11	2462	8.06
802.11n(20)	6.5	01	2412	6.12
		06	2437	7.73
		11	2462	8.16
802.11n(40)	13.5	03	2422	3
		06	2437	3.08
		09	2452	3.65

Bluetooth

Modulation	Channel	Frequency(MHz)	Average Power (dBm)
GFSK	0	2402	6.55
	39	2441	7.04
	78	2480	7.11
$\pi/4$ -DQPSK	0	2402	5.68
	39	2441	6.16
	78	2480	6.21
8-DPSK	0	2402	5.68
	39	2441	6.16
	78	2480	6.2

According to 3GPP 25.101 sub-clause 6.2.2 , the maximum output power is allowed to be reduced by following the table.

Table 6.1aA: UE maximum output power with HS-DPCCH and E-DCH

UE Transmit Channel Configuration	CM(db)	MPR(db)
For all combinations of ,DPDCH,DPCCH HS-DPDCH,E-DPDCH and E-DPCCH	$0 \leq CM \leq 3.5$	$\text{MAX}(CM-1,0)$
Note: CM=1 for $\beta_c/\beta_d=12/15$, $\beta_{hs}/\beta_c=24/15$.For all other combinations of DPDCH, DPCCH, HS-DPCCH, E-DPDCH and E-DPCCH the MPR is based on the relative CM difference.		

The device supports MPR to solve linearity issues (ACLR or SEM) due to the higher peak-to average ratios (PAR) of the HSUPA signal. This prevents saturating the full range of the TX DAC inside of device and provides a reduced power output to the RF transceiver chip according to the Cubic Metric (a function of the combinations of DPDCH, DPCCH, HS-DPCCH, E-DPDCH and E-DPCCH).

When E-DPDCH channels are present the beta gains on those channels are reduced firsts to try to get the power under the allowed limit. If the beta gains are lowered as far as possible, then a hard limiting is applied at the maximum allowed level.

The SW currently recalculates the cubic metric every time the beta gains on the E-DPDCH are reduced. The cubic metric will likely get lower each time this is done .However, there is no reported reduction of maximum output power in the HSUPA mode since the device also provides a compensation for the power back-off by increasing the gain of TX_AGC in the transceiver (PA) device.

The end effect is that the DUT output power is identical to the case where there is no MPR in the device.

11. TEST RESULTS

11.1. SAR Test Results Summary

11.1.1. Test position and configuration

Head SAR was performed with the device configured in the positions according to IEEE1528, and Body SAR was performed with the device 5mm from the phantom; Body SAR was also performed with the headset attached and without. The overall device length and width(15.1cm×7.2cm) are >9cm×5cm, Hotspot mode with a test separation distance of 10mm.

11.1.2. Operation Mode

- According to KDB 447498 D01 v05r01 ,for each exposure position, if the highest 1-g SAR is ≤ 0.8 W/kg, testing for low and high channel is optional.
- Per KDB 865664 D01 v01r01,for each frequency band, if the measured SAR is ≥ 0.8 W/Kg, testing for repeated SAR measurement is required , that the highest measured SAR is only to be tested. When the SAR results are near the limit, the following procedures are required for each device to verify these types of SAR measurement related variation concerns by repeating the highest measured SAR configuration in each frequency band.
 - (1) When the original highest measured SAR is ≥ 0.8 W/Kg, repeat that measurement once.
 - (2) Perform a second repeated measurement only if the ratio of largest to smallest SAR for the original and first repeated measurements is > 1.20 or when the original or repeated measurement is ≥ 1.45 W/Kg.
 - (3) Perform a third repeated measurement only if the original, first and second repeated measurement is ≥ 1.5 W/Kg and ratio of largest to smallest SAR for the original, first and second measurement is ≥ 1.20 .
- Body-worn exposure conditions are intended to voice call operations, therefore GSM voice call mode is selected to be test.
- According to KDB 648474 D04 v01r01,when the reported SAR for a body-worn accessory measured without a headset connected to the handset is ≤ 1.2 W/Kg, SAR testing with a headset connected is not required.
- According to 941225 D06, when the overall device length and width are >9cm×5cm, Hotspot mode with a test separation distance of 10mm. For device with form factors smaller than 9cm×5cm, Hotspot mode with a test separation distance of 5mm. Body SAR was also performed with the headset attached and without.
- According to 248227 D01, SAR is not required for 802.11g channels when the maximum average output power is less than 1/4dB higher than measured on the corresponding 802.11b channels.
- Maximum Scaling SAR in order to calculate the Maximum SAR values to test under the standard Peak Power, Calculation method is as follows: Maximum Scaling SAR =tested SAR (Max.) ×[maximum turn-up power (mw)/ maximum measurement output power(mw)]

11.1.3. Test Result

SAR MEASUREMENT									
Ambient Temperature (°C) : 21 ± 2					Relative Humidity (%): 55				
Liquid Temperature (°C) : 21 ± 2					Depth of Liquid (cm):>15				
Product: Pilot PLUS									
Test Mode: GSM835 with GMSK modulation									
Position	Mode	Ch.	Fr. (MHz)	Power Drift (<±5%)	SAR (1g) (W/kg)	Max. Turn-up Power (dBm)	Meas. output Power (dBm)	Scaled SAR (W/Kg)	Limit W/kg
SIM 1 Card									
Left Cheek	voice	190	836.6	-0.35	0.118	32.75	31.75	0.149	1.6
Left Tilt	voice	190	836.6	-1.03	0.089	32.75	31.75	0.112	1.6
Right Cheek	voice	190	836.6	0.19	0.108	32.75	31.75	0.136	1.6
Right Tilt	voice	190	836.6	-0.61	0.100	32.75	31.75	0.126	1.6
Body back	voice	190	836.6	0.84	0.244	32.75	31.75	0.307	1.6
Body front	voice	190	836.6	-0.62	0.119	32.75	31.75	0.150	1.6
SIM 2 Card									
Left Cheek	voice	190	836.6	0.05	0.111	32.75	31.75	0.140	1.6

Note:

- The test separation of all above table for body part is 5mm.
- The worst mode is voice mode.

SAR MEASUREMENT									
Ambient Temperature (°C) : 21 ± 2					Relative Humidity (%): 55				
Liquid Temperature (°C) : 21 ± 2					Depth of Liquid (cm):>15				
Product: Pilot PLUS									
Test Mode: GSM1900 with GMSK modulation									
Position	Mode	Ch.	Fr. (MHz)	Power Drift (<±5%)	SAR (1g) (W/kg)	Max. Turn-up Power (dBm)	Meas. output Power (dBm)	Scaled SAR (W/Kg)	Limit W/kg
SIM 1 Card									
Left Cheek	voice	661	1880.0	-0.32	0.204	29.82	28.82	0.257	1.6
Left Tilt	voice	661	1880.0	-1.05	0.062	29.82	28.82	0.078	1.6
Right Cheek	voice	661	1880.0	0.65	0.339	29.82	28.82	0.427	1.6
Right Tilt	voice	661	1880.0	-0.32	0.087	29.82	28.82	0.110	1.6
Body back	voice	661	1880.0	0.78	0.189	29.82	28.82	0.238	1.6
Body front	voice	661	1880.0	-0.65	0.140	29.82	28.82	0.176	1.6
SIM 2 Card									
Right Cheek	voice	661	1880.0	-0.39	0.305	29.82	28.82	0.384	1.6

Note:

- The test separation of all above table for body part is 5mm.
- The worst mode is voice mode.

SAR MEASUREMENT									
Ambient Temperature (°C) : 21 ± 2					Relative Humidity (%): 55				
Liquid Temperature (°C) : 21 ± 2					Depth of Liquid (cm):>15				
Product: Pilot PLUS									
Test Mode: WCDMA Band II with QPSK modulation									
Position	Mode	Ch.	Fr. (MHz)	Power Drift (<±5%)	SAR (1g) (W/kg)	Max. Turn-up Power (dBm)	Meas. output Power (dBm)	Scaled SAR (W/Kg)	Limit W/kg
SIM 1 Card									
Left Cheek	RMC 12.2kbps	9400	1880	-0.32	0.421	23.92	22.92	0.530	1.6
Left Tilt	RMC 12.2kbps	9400	1880	-1.06	0.106	23.92	22.92	0.133	1.6
Right Cheek	RMC 12.2kbps	9400	1880	0.31	0.745	23.92	22.92	0.938	1.6
Right Tilt	RMC 12.2kbps	9400	1880	-0.25	0.163	23.92	22.92	0.205	1.6
Body back	RMC 12.2kbps	9400	1880	-1.09	0.358	23.92	22.92	0.451	1.6
Body front	RMC 12.2kbps	9400	1880	0.25	0.313	23.92	22.92	0.394	1.6

Note:

- The test separation of all above table for body part is 5mm.
- The worst mode is voice mode.

SAR MEASUREMENT									
Ambient Temperature (°C) : 21 ± 2					Relative Humidity (%): 55				
Liquid Temperature (°C) : 21 ± 2					Depth of Liquid (cm):>15				
Product: Pilot PLUS									
Test Mode: WCDMA Band V with QPSK modulation									
Position	Mode	Ch.	Fr. (MHz)	Power Drift (<±5%)	SAR (1g) (W/kg)	Max. Turn-up Power (dBm)	Meas. output Power (dBm)	Scaled SAR (W/Kg)	Limit W/kg
SIM 1 Card									
Left Cheek	RMC 12.2kbps	4183	836.6	-0.23	0.209	23.93	22.93	0.263	1.6
Left Tilt	RMC 12.2kbps	4183	836.6	-0.14	0.190	23.93	22.93	0.239	1.6
Right Cheek	RMC 12.2kbps	4183	836.6	1.06	0.196	23.93	22.93	0.247	1.6
Right Tilt	RMC 12.2kbps	4183	836.6	-0.32	0.198	23.93	22.93	0.249	1.6
Body back	RMC 12.2kbps	4183	836.6	1.05	0.393	23.93	22.93	0.495	1.6
Body front	RMC 12.2kbps	4183	836.6	-0.32	0.216	23.93	22.93	0.272	1.6

Note:

- The test separation of all above table for body part is 5mm.
- The worst mode is voice mode.

SAR MEASUREMENT									
Ambient Temperature (°C) : 21 ± 2					Relative Humidity (%): 55				
Liquid Temperature (°C) : 21 ± 2					Depth of Liquid (cm):>15				
Product: Pilot PLUS									
Test Mode:802.11b									
Position	Mode	Ch.	Fr. (MHz)	Power Drift (<±5%)	SAR (1g) (W/kg)	Max. Turn-up Power (dBm)	Meas. output Power (dBm)	Scaled SAR (W/Kg)	Limit W/kg
SIM 1 Card									
Left Cheek	DTS	6	2437	-0.02	0.147	13.56	12.56	0.185	1.6
Left Tilt	DTS	6	2437	-0.31	0.162	13.56	12.56	0.204	1.6
Right Cheek	DTS	6	2437	0.65	0.203	13.56	12.56	0.256	1.6
Right Tilt	DTS	6	2437	-0.32	0.256	13.56	12.56	0.322	1.6
Body back	DTS	6	2437	-0.14	0.154	13.56	12.56	0.194	1.6
Body front	DTS	6	2437	0.34	0.133	13.56	12.56	0.167	1.6

Note:

- According to KDB248227, SAR is not required for 802.11n HT20/HT40 channels when the maximum average output power is less than 1/4 dB higher than that measured on the corresponding 802.11a/b channels.
- All of above "DTS" means data transmitters.
- The test separation of all above table for body part is 5mm.

SAR MEASUREMENT									
Ambient Temperature (°C) : 21 ± 2					Relative Humidity (%): 55				
Liquid Temperature (°C) : 21 ± 2					Depth of Liquid (cm):>15				
Product: Mobile Phone									
Test Mode: Hotspot									
Position	Mode	Ch.	Fr. (MHz)	Power Drift (<±5%)	SAR (1g) (W/kg)	Max. Turn-up Power (dBm)	Meas. output Power (dBm)	Scaled SAR (W/Kg)	Limit W/kg
SIM 1 Card									
Body back	DTS	6	2437	-0.69	0.177	13.56	12.56	0.223	1.6
Body front	DTS	6	2437	0.38	0.103	13.56	12.56	0.130	1.6

Note:

- According to KDB248227, SAR is not required for 802.11n HT20/HT40 channels when the maximum average output power is less than 1/4 dB higher than that measured on the corresponding 802.11a/b channels.
- All of above "DTS" means data transmitters.
- The test separation of all above table for body part is 10mm.

Simultaneous Multi-band Transmission Evaluation:
Application Simultaneous Transmission information:

Position	Simultaneous state
Head	1.WWAN(voice)+WLAN 2.4GHz band
	2.WWAN(voice)+Bluetooth
	3.WWAN(voice)+ HOTSPOT 2.4GHz band
Body	4. WWAN(voice)+WLAN 2.4GHz band
	5. WWAN(voice)+Bluetooth
	6.WWAN(voice)+ HOTSPOT 2.4GHz band

NOTE:

1. WLAN and BT share the same antenna, and cannot transmit simultaneously.
2. Simultaneous with every transmitter must be the same test position.
3. Based upon KDB 447498 D01 v05, BT SAR is excluded as below table.
4. Based upon KDB 447498 D01 v05,for handsets the test separation distance is determined by the smallest distance between the outer surface of the device and the user; which is 0mm for head SAR AND 5mm for body-worn SAR.
5. If the test separation distance is <5mm, 5mm is used for excluded SAR calculation.
6. For minimum test separation distance $\leq 50\text{mm}$,Bluetooth standalone SAR is excluded according to $[(\text{max. power of channel, including tune-up tolerance, mW}) / (\text{min. test separation distance, mm}) \cdot \sqrt{f \text{ (GHz)}} / x] \leq 3.0$ for 1-g SAR and ≤ 7.5 for 10-g extremity SAR
7. KDB 447498 / 4.3.2 (2) when standalone SAR test exclusion applies to an antenna that transmits simultaneously with other antennas, the standalone SAR must be estimated according to following to determine simultaneous transmission SAR test exclusion:
 - a) $(\text{max. power of channel, including tune-up tolerance, mW}) / (\text{min. test separation distance, mm}) \cdot \sqrt{f \text{ (GHz)}} / x \leq 3.0$ for test separation distances $\leq 50 \text{ mm}$;
Where $x = 7.5$ for 1-g SAR, and $x = 18.75$ for 10-g SAR.
 - b) 0.4W/Kg for 1-g SAR and 1.0W/Kg for 10-g SAR, when the separation distance is $>50\text{mm}$.

		Maximum Average Power		Antenna to user (mm)	SAR exclusion threshold (mW)	SAR testing required (Yes/No)	Head (0mm gap)	Body (5mm gap)
		dBm	mW					
BT	Head	8.11	6.471	5	10	NO	0.272	0.272
	Body			5	10	NO	W/kg	W/kg

Maximum test results (WWAN) with BT and WIFI/ HOTSPOT SAR:

BT: Head (0 cm gap): 0.272 W/kg and Body (0.5 cm gap): 0.272 W/kg
WIFI: Head (0 cm gap): 0.322W/kg and Body (0.5 cm gap): 0.194 W/kg
HOTSPOT: Body 1.0 cm gap):0.223 W/kg

WIFI

Position	Max. WWAN SAR (W/Kg)	Max. WLAN SAR (W/Kg)	SAR Summation	Limit (W/kg)	SPLSR ≤ 0.04 (Yes/No)
GSM850+WLAN 2.4G-DTS					
Left Cheek	0.149	0.185	0.334	1.6	No
Left Tilt	0.112	0.204	0.316	1.6	No
Right Cheek	0.136	0.256	0.392	1.6	No
Right Tilt	0.126	0.322	0.448	1.6	No
Body back	0.307	0.194	0.501	1.6	No
Body front	0.150	0.167	0.317	1.6	No
PCS1900+WLAN 2.4G-DTS					
Left Cheek	0.257	0.185	0.442	1.6	No
Left Tilt	0.078	0.204	0.282	1.6	No
Right Cheek	0.427	0.256	0.683	1.6	No
Right Tilt	0.110	0.322	0.432	1.6	No
Body back	0.238	0.194	0.432	1.6	No
Body front	0.176	0.167	0.343	1.6	No
WCDMA Band II +WLAN 2.4G-DTS					
Left Cheek	0.530	0.185	0.715	1.6	No
Left Tilt	0.133	0.204	0.337	1.6	No
Right Cheek	0.938	0.256	1.194	1.6	No
Right Tilt	0.205	0.322	0.527	1.6	No
Body back	0.451	0.194	0.645	1.6	No
Body front	0.394	0.167	0.561	1.6	No
WCDMA Band V +WLAN 2.4G-DTS					
Left Cheek	0.263	0.185	0.448	1.6	No
Left Tilt	0.239	0.204	0.443	1.6	No
Right Cheek	0.247	0.256	0.503	1.6	No
Right Tilt	0.249	0.322	0.571	1.6	No
Body back	0.495	0.194	0.689	1.6	No
Body front	0.272	0.167	0.439	1.6	No

HOTSPOT

Position	Max. WWAN SAR (W/Kg)	Max. WLAN SAR (W/Kg)	SAR Summation	Limit (W/kg)	SPLSR ≤ 0.04 (Yes/No)
GSM850+WLAN 2.4G-DTS					
Body back	0.307	0.223	0.53	1.6	No
Body front	0.150	0.130	0.28	1.6	No
PCS1900+WLAN 2.4G-DTS					
Body back	0.238	0.223	0.461	1.6	No
Body front	0.176	0.130	0.306	1.6	No
WCDMA Band II +WLAN 2.4G-DTS					
Body back	0.451	0.223	0.674	1.6	No
Body front	0.394	0.130	0.524	1.6	No
WCDMA Band V +WLAN 2.4G-DTS					
Body back	0.495	0.223	0.718	1.6	No
Body front	0.272	0.130	0.402	1.6	No

BT

Position	Max. WWAN SAR (W/Kg)	Estimated SAR (W/Kg)	SAR Summation	Limit (W/kg)	SPLSR ≤ 0.04 (Yes/No)
GSM850+WLAN 2.4G-DTS					
Left Cheek	0.149	0.272	0.421	1.6	No
Left Tilt	0.112	0.272	0.384	1.6	No
Right Cheek	0.136	0.272	0.408	1.6	No
Right Tilt	0.126	0.272	0.398	1.6	No
Body back	0.307	0.272	0.579	1.6	No
Body front	0.150	0.272	0.422	1.6	No
PCS1900+WLAN 2.4G-DTS					
Left Cheek	0.257	0.272	0.529	1.6	No
Left Tilt	0.078	0.272	0.35	1.6	No
Right Cheek	0.427	0.272	0.699	1.6	No
Right Tilt	0.110	0.272	0.382	1.6	No
Body back	0.238	0.272	0.510	1.6	No
Body front	0.176	0.272	0.448	1.6	No
WCDMA Band II +WLAN 2.4G-DTS					
Left Cheek	0.530	0.272	0.802	1.6	No
Left Tilt	0.133	0.272	0.405	1.6	No
Right Cheek	0.938	0.272	1.210	1.6	No
Right Tilt	0.205	0.272	0.477	1.6	No
Body back	0.451	0.272	0.723	1.6	No
Body front	0.394	0.272	0.666	1.6	No
WCDMA Band V +WLAN 2.4G-DTS					
Left Cheek	0.263	0.272	0.535	1.6	No
Left Tilt	0.239	0.272	0.511	1.6	No
Right Cheek	0.247	0.272	0.519	1.6	No
Right Tilt	0.249	0.272	0.521	1.6	No
Body back	0.495	0.272	0.767	1.6	No
Body front	0.272	0.272	0.544	1.6	No

APPENDIX A. SAR SYSTEM VALIDATION DATA

Test Laboratory: AGC Lab

Date: June 26,2014

System Check Head 835 MHz

DUT: Dipole 900 MHz Type: SID 900

Communication System CW; Communication System Band: D835 (835.0 MHz); Duty Cycle: 1:1; Conv.F=5.27

Frequency: 835 MHz; Medium parameters used: $f = 835$ MHz; $\sigma=0.90$ mho/m; $\epsilon_r =41.94$; $\rho= 1000$ kg/m³ ;

Phantom section: Flat Section; Input Power=10dBm

Ambient temperature (°C): 21, Liquid temperature (°C): 21

SATIMO Configuration:

- Probe: SSE5; Calibrated: 01/12/2014; Serial No.:SN 22/12 EP159
- Sensor-Surface: 4mm (Mechanical Surface Detection)
- Phantom: Flat Phantom; Type: Elliptical Phantom
- Measurement SW: OpenSAR V4_02_01

Configuration/System Check GSM 835 Head/Area Scan: Measurement grid: dx=8mm, dy=8mm

Configuration/System Check GSM 835 Head/Zoom Scan: Measurement grid: dx=8mm, dy=8mm, dz=5mm

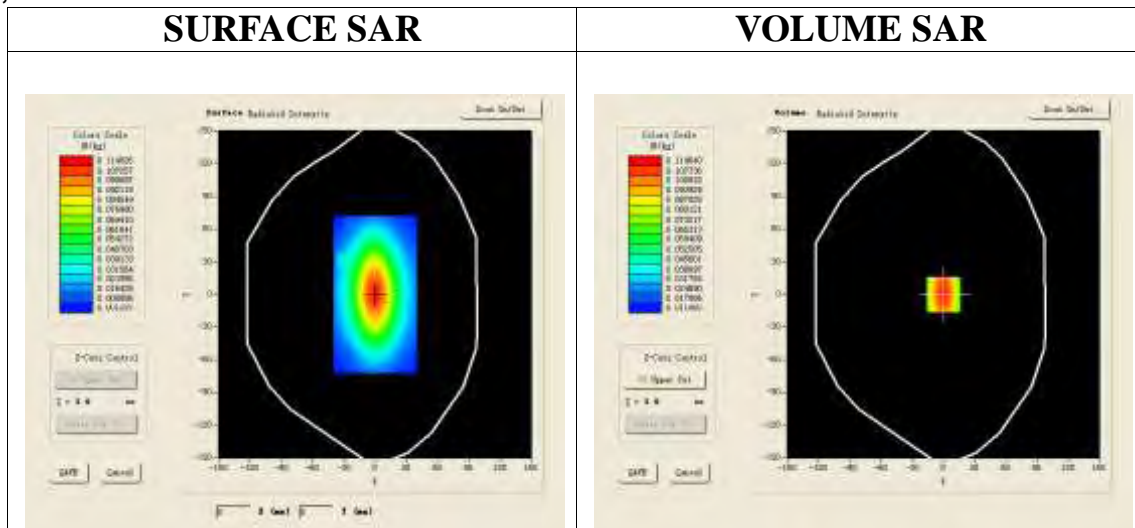

Maximum location: X=0.00, Y=0.00

SAR 10g (W/Kg)	0.065046
SAR 1g (W/Kg)	0.103234

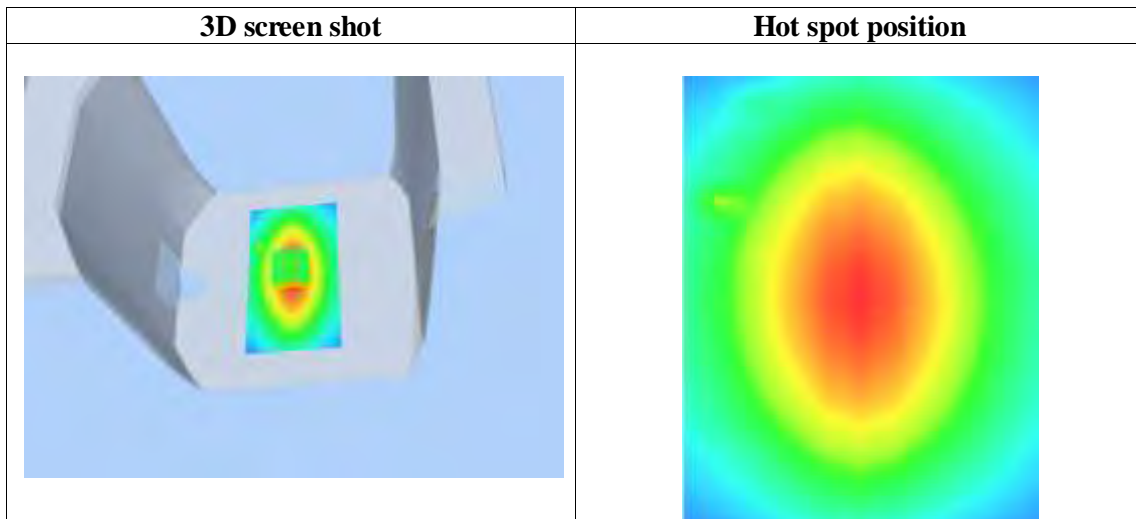
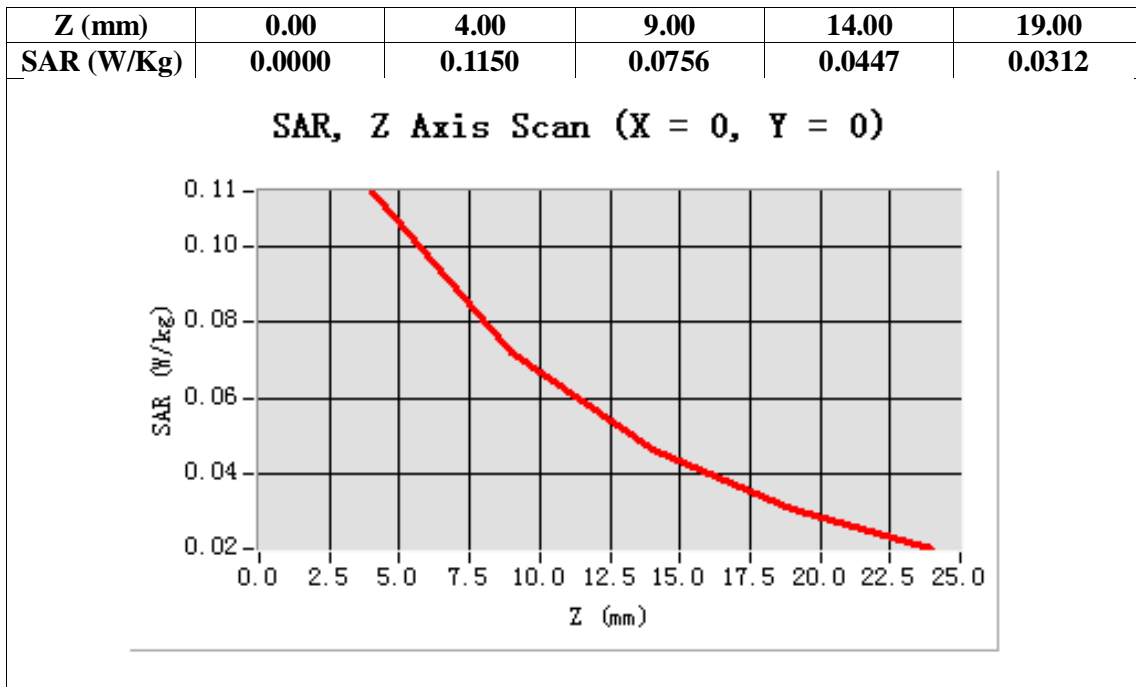

Test Laboratory: AGC Lab
System Check Body 835 MHz
DUT: Dipole 900 MHz Type: SID 900

Date: June 26,2014

Communication System CW; Communication System Band: D835 (835.0 MHz); Duty Cycle: 1:1; Conv.F=5.48
Frequency: 835 MHz; Medium parameters used: $f = 835$ MHz; $\sigma=0.98$ mho/m; $\epsilon_r =55.73$; $\rho= 1000$ kg/m³ ;
Phantom section: Flat Section; Input Power=10dBm
Ambient temperature (°C): 21, Liquid temperature (°C): 21

SATIMO Configuration:

- Probe: SSE5; Calibrated: 01/12/2014; Serial No.:SN 22/12 EP159
- Sensor-Surface: 4mm (Mechanical Surface Detection)
- Phantom: Flat Phantom; Type: Elliptical Phantom
- Measurement SW: OpenSAR V4_02_01

Configuration/System Check GSM 835 Body/Area Scan: Measurement grid: dx=8mm, dy=8mm
Configuration/System Check GSM 835 Body/Zoom Scan: Measurement grid: dx=8mm, dy=8mm, dz=5mm

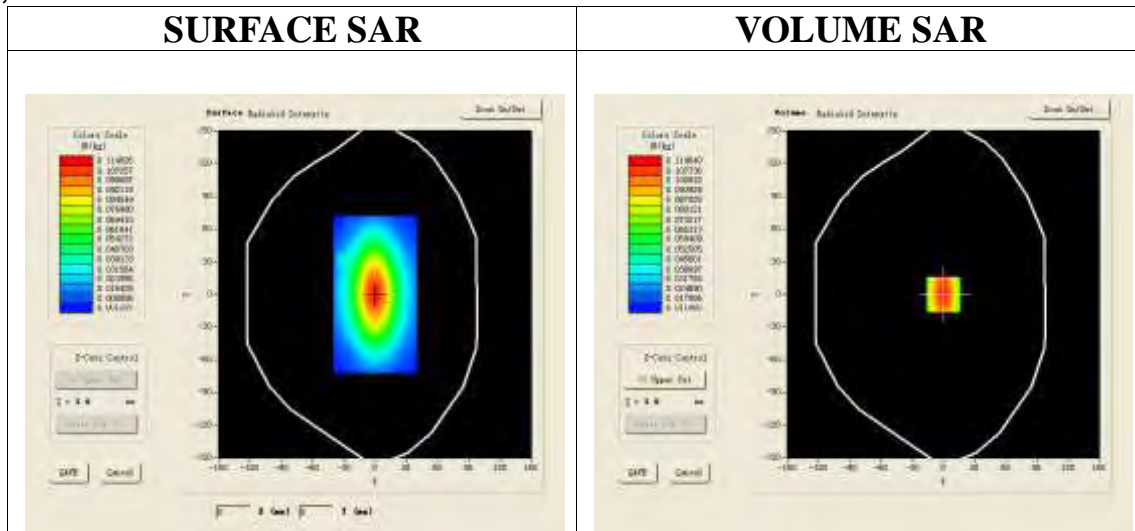

Maximum location: X=0.00, Y=0.00

SAR 10g (W/Kg)	0.068064
SAR 1g (W/Kg)	0.109014

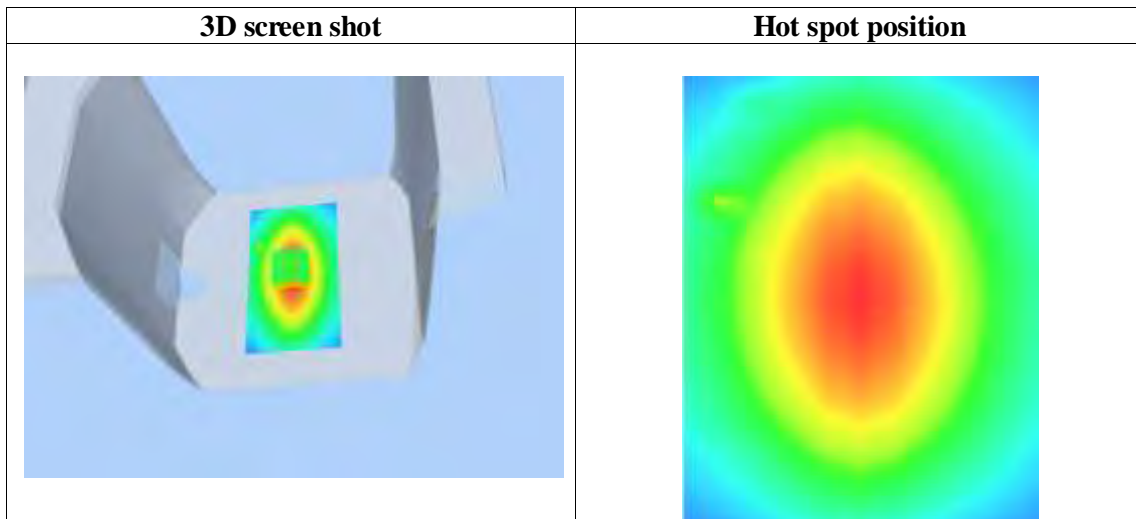
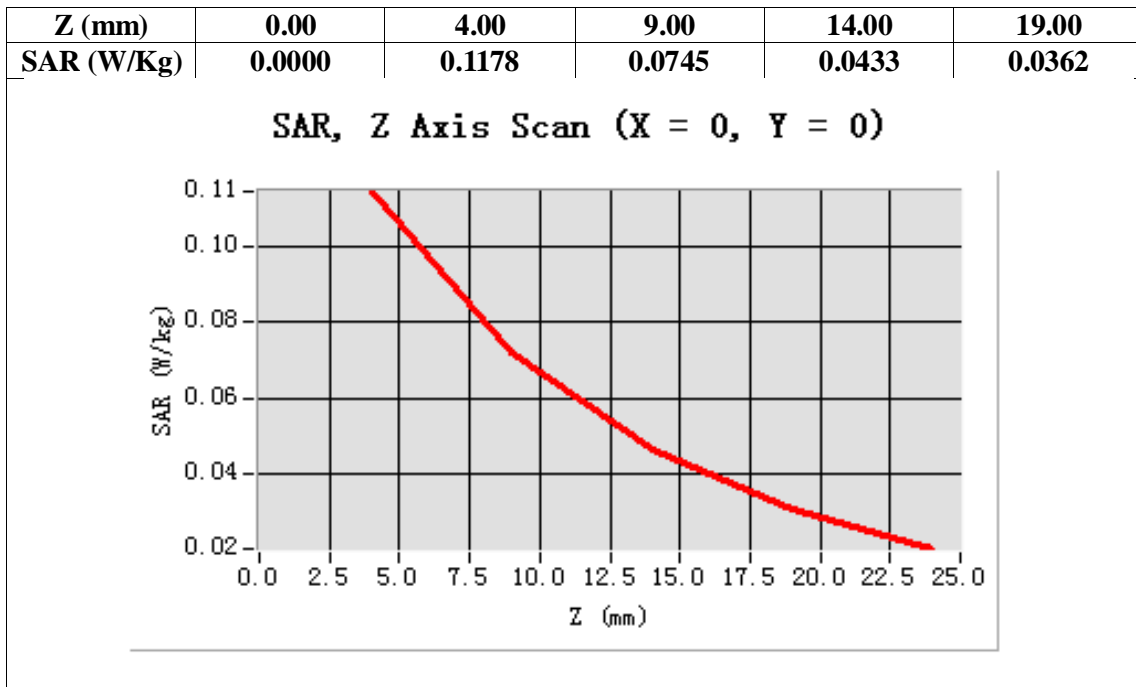

Test Laboratory: AGC Lab
System Check Head 1900MHz

Date: June 26,2014

DUT: Dipole 1900 MHz; Type: SID 1900

Communication System: CW; Communication System Band: D1900 (1900.0 MHz); Duty Cycle:1:1; Conv.F=4.51
Frequency: 1900 MHz; Medium parameters used: $f = 1900$ MHz; $\sigma=1.42$ mho/m; $\epsilon_r =40.19$; $\rho= 1000$ kg/m³ ;
Phantom section: Flat Section; Input Power=10dBm
Ambient temperature (°C): 21, Liquid temperature (°C): 21

SATIMO Configuration:

- Probe: SSE5; Calibrated: 01/12/2014; Serial No.:SN 22/12 EP159
- Sensor-Surface: 4mm (Mechanical Surface Detection)
- Phantom: Flat Phantom; Type: Elliptical Phantom
- Measurement SW: OpenSAR V4_02_01

Configuration/System Check PCS1900 Head/Area Scan: Measurement grid: dx=8mm,dy=8mm

Configuration/System Check PCS1900 Head/Zoom Scan: Measurement grid: dx=8mm, dy=8mm, dz=5mm

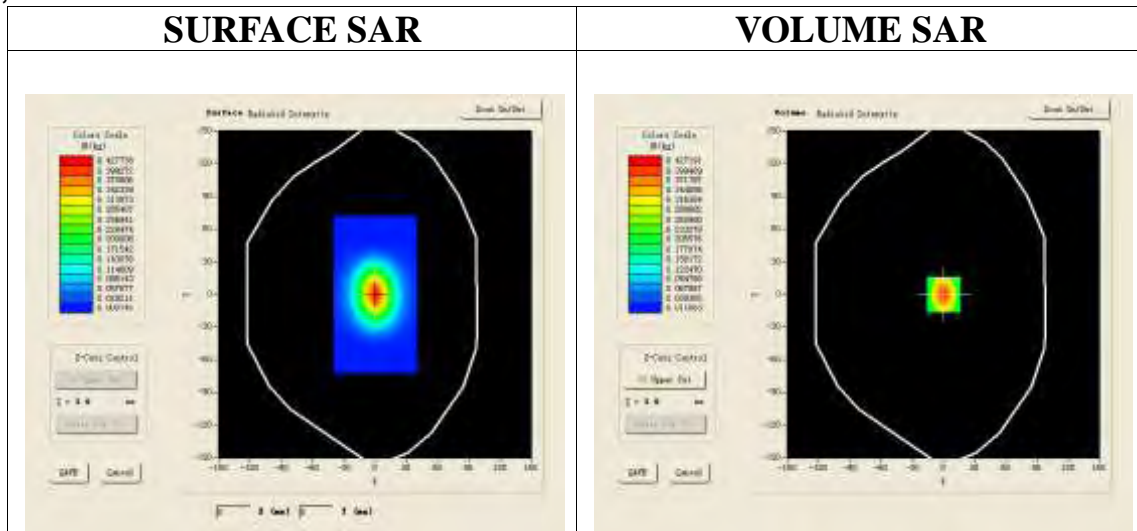

Maximum location: X=0.00, Y=0.00

SAR 10g (W/Kg)	0.205689
SAR 1g (W/Kg)	0.387415

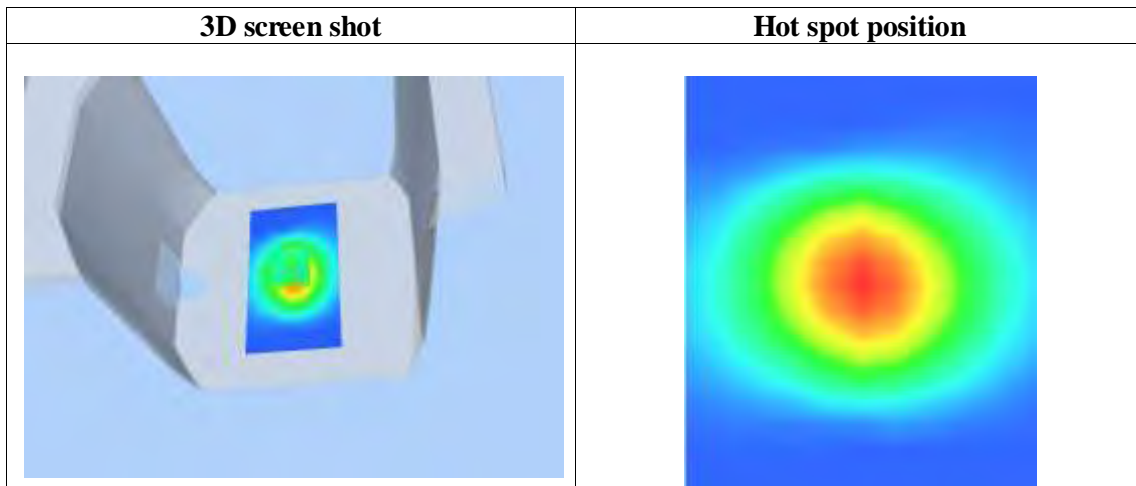
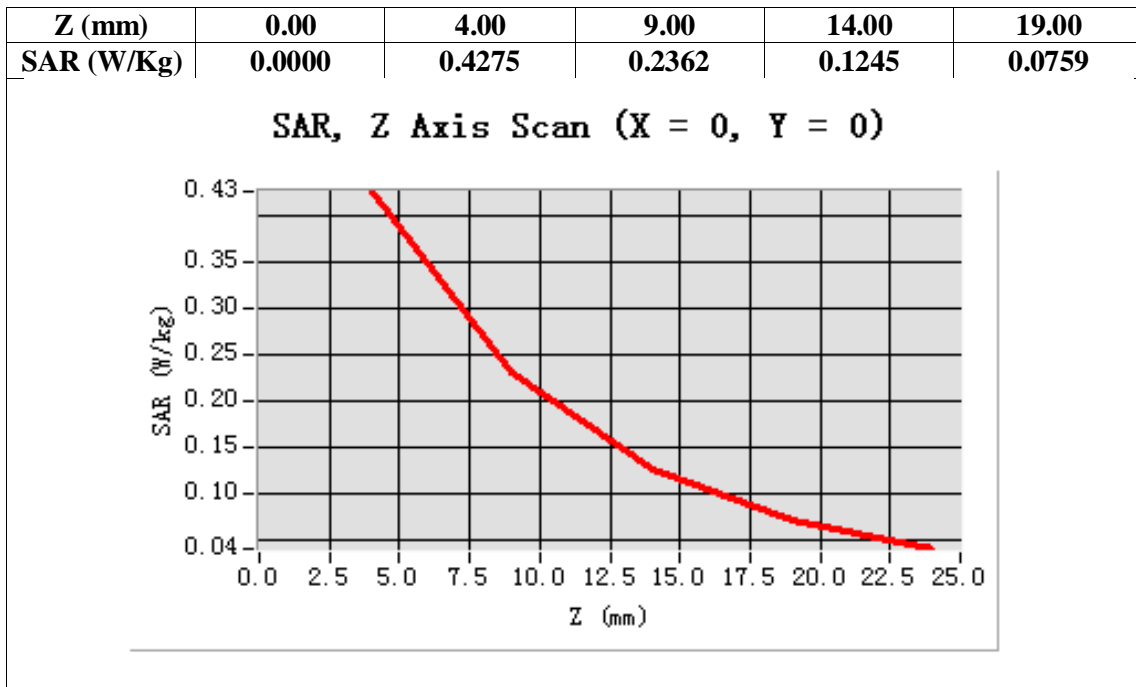

Test Laboratory: AGC Lab
System Check Body 1900MHz
DUT: Dipole 1900 MHz; Type: SID 1900

Date: June 26,2014

Communication System: CW; Communication System Band: D1900 (1900.0 MHz); Duty Cycle:1:1; Conv.F=4.45
Frequency: 1900 MHz; Medium parameters used: $f = 1900$ MHz; $\sigma=1.49$ mho/m; $\epsilon_r =53.92$; $\rho= 1000$ kg/m³ ;
Phantom section: Flat Section; Input Power=10dBm
Ambient temperature (°C): 21, Liquid temperature (°C): 21

SATIMO Configuration:

- Probe: SSE5; Calibrated: 01/12/2014; Serial No.:SN 22/12 EP159
- Sensor-Surface: 4mm (Mechanical Surface Detection)
- Phantom: Flat Phantom; Type: Elliptical Phantom
- Measurement SW: OpenSAR V4_02_01

Configuration/System Check PCS1900 Body/Area Scan: Measurement grid: dx=8mm,dy=8mm
Configuration/System Check PCS1900 Body/Zoom Scan: Measurement grid: dx=8mm, dy=8mm, dz=5mm

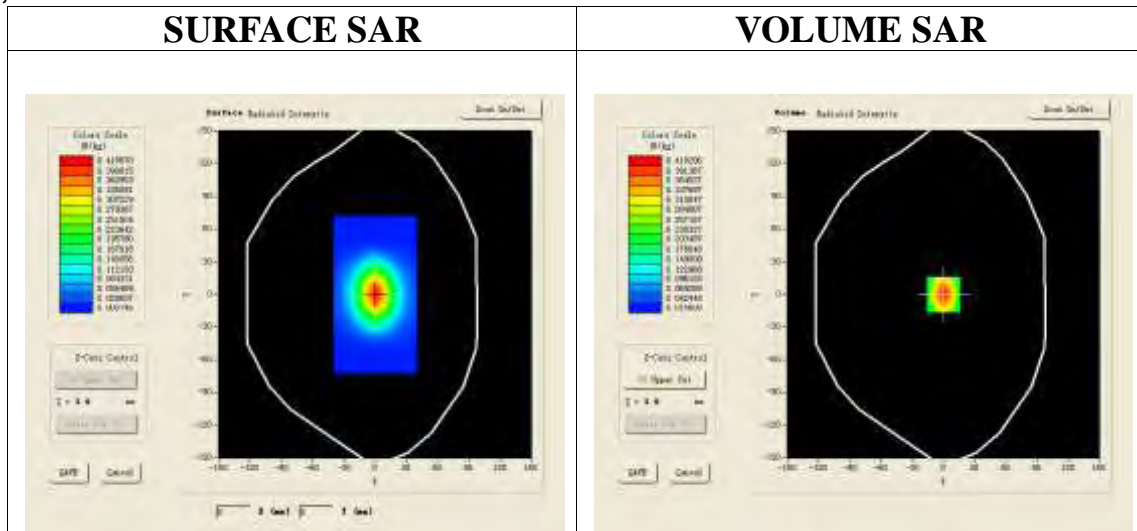

Maximum location: X=0.00, Y=0.00

SAR 10g (W/Kg)	0.208563
SAR 1g (W/Kg)	0.397512

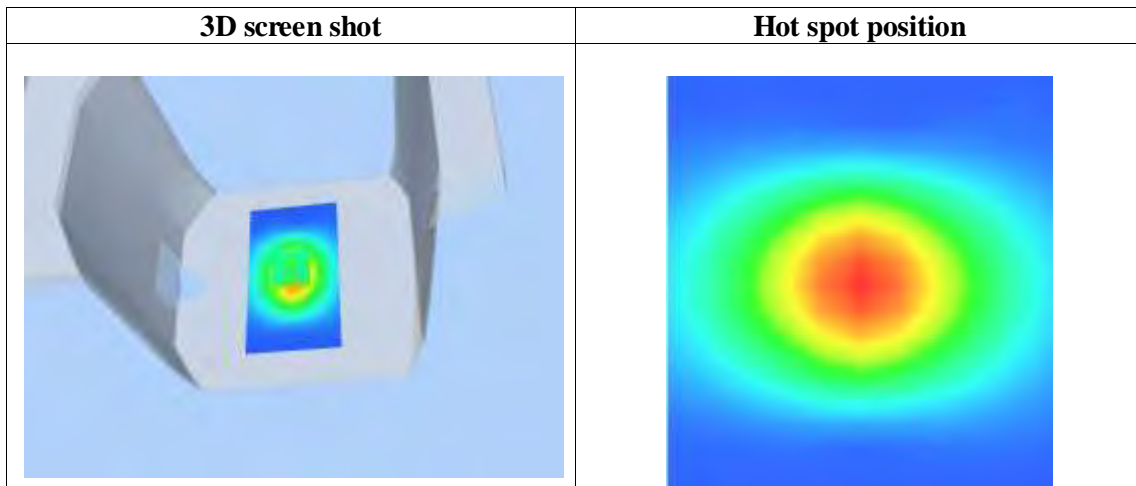
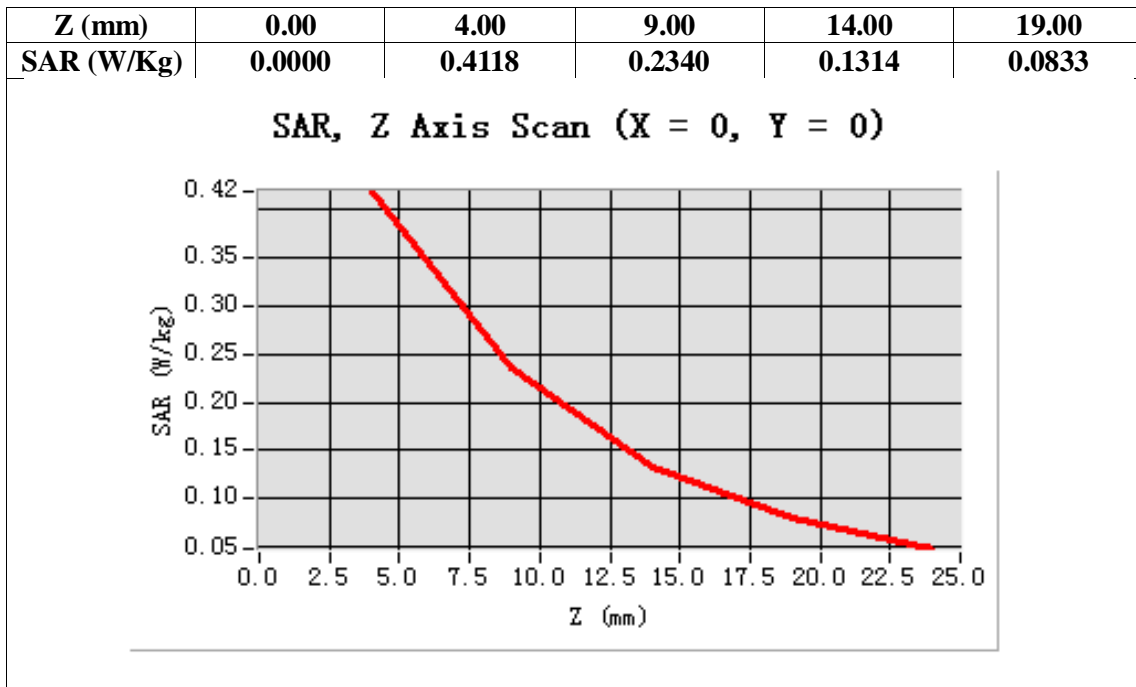

Test Laboratory: AGC Lab
System Check Head 2450 MHz
DUT: Dipole 2450 MHz Type: SID 2450

Date: June 26,2014

Communication System: CW; Communication System Band: D2450 (2450.0 MHz); Duty Cycle: 1:1; Conv.F=4.42
Frequency: 2450 MHz; Medium parameters used: $f = 2450$ MHz; $\sigma = 1.78$ mho/m; $\epsilon_r = 40.00$; $\rho = 1000$ kg/m³ ;
Phantom section: Flat Section; Input Power=10dBm
Ambient temperature (°C): 21, Liquid temperature (°C): 21

SATIMO Configuration:

- Probe: SSE5; Calibrated: 01/12/2014; Serial No.:SN 22/12 EP159
- Sensor-Surface: 4mm (Mechanical Surface Detection)
- Phantom: Flat Phantom; Type: Elliptical Phantom
- Measurement SW: OpenSAR V4_02_01

Configuration/System Check 2450 MHz Head/Area Scan: Measurement grid: dx=8mm,dy=8mm
Configuration/System Check 2450 MHz Head/Zoom Scan: Measurement grid: dx=8mm, dy=8mm, dz=5mm

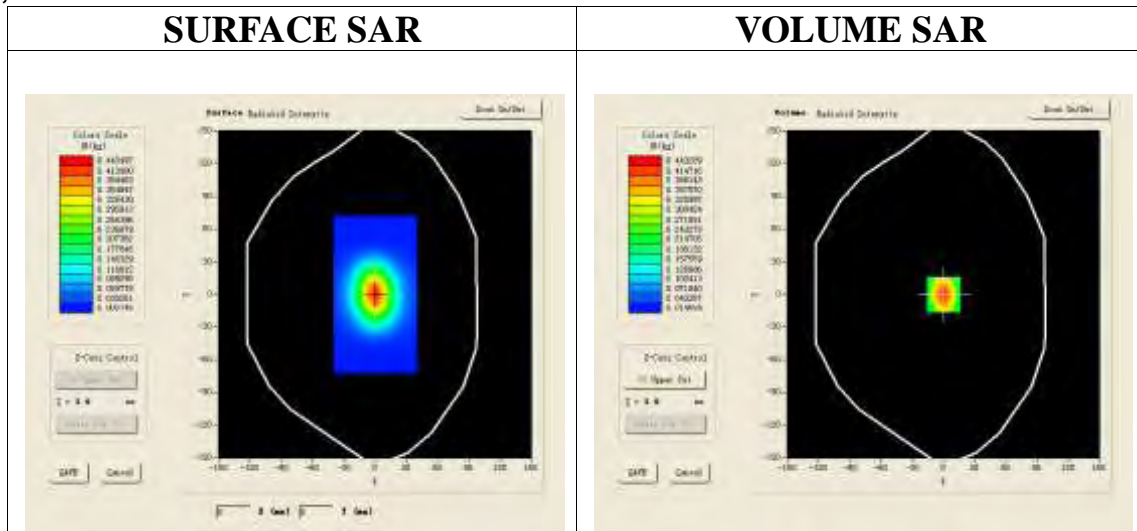

Maximum location: X=0.00, Y=0.00

SAR 10g (W/Kg)	0.239013
SAR 1g (W/Kg)	0.499846

Z (mm)	0.00	4.00	9.00	14.00	19.00
SAR (W/Kg)	0.0000	0.4442	0.2461	0.1356	0.0879

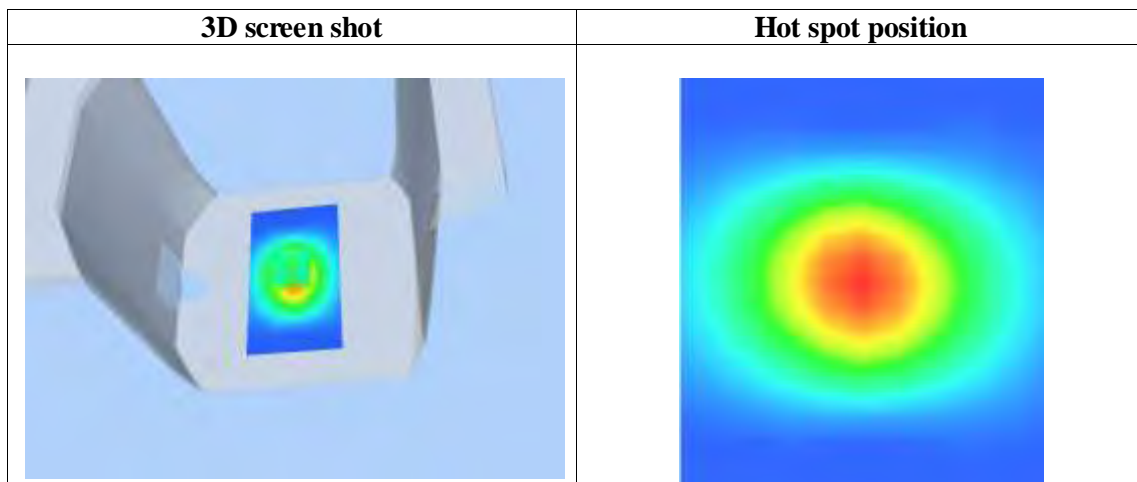
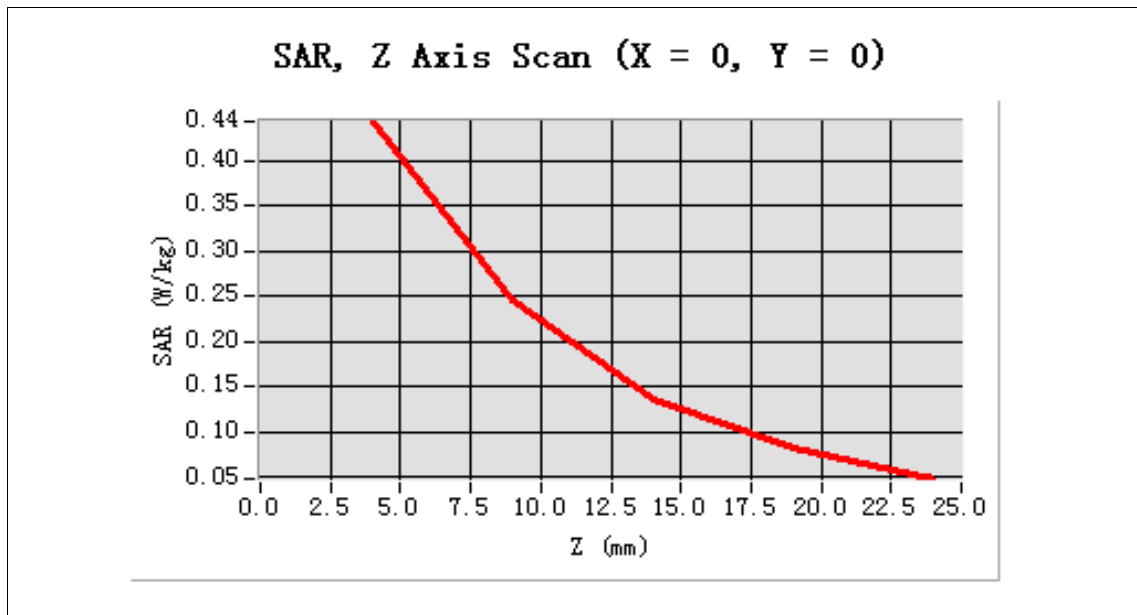

Test Laboratory: AGC Lab
System Check Body 2450 MHz
DUT: Dipole 2450 MHz Type: SID 2450

Date: June 26,2014

Communication System: CW; Communication System Band: D2450 (2450.0 MHz); Duty Cycle: 1:1; Conv.F=4.31
Frequency: 2450 MHz; Medium parameters used: $f = 2450$ MHz; $\sigma = 1.90$ mho/m; $\epsilon_r = 52.68$; $\rho = 1000$ kg/m³ ;
Phantom section: Flat Section; Input Power=10dBm
Ambient temperature (°C): 21, Liquid temperature (°C): 21

SATIMO Configuration:

- Probe: SSE5; Calibrated: 01/12/2014; Serial No.:SN 22/12 EP159
- Sensor-Surface: 4mm (Mechanical Surface Detection)
- Phantom: Flat Phantom; Type: Elliptical Phantom
- Measurement SW: OpenSAR V4_02_01

Configuration/System Check 2450 MHz Body/Area Scan: Measurement grid: dx=8mm,dy=8mm
Configuration/System Check 2450 MHz Body/Zoom Scan: Measurement grid: dx=8mm, dy=8mm, dz=5mm

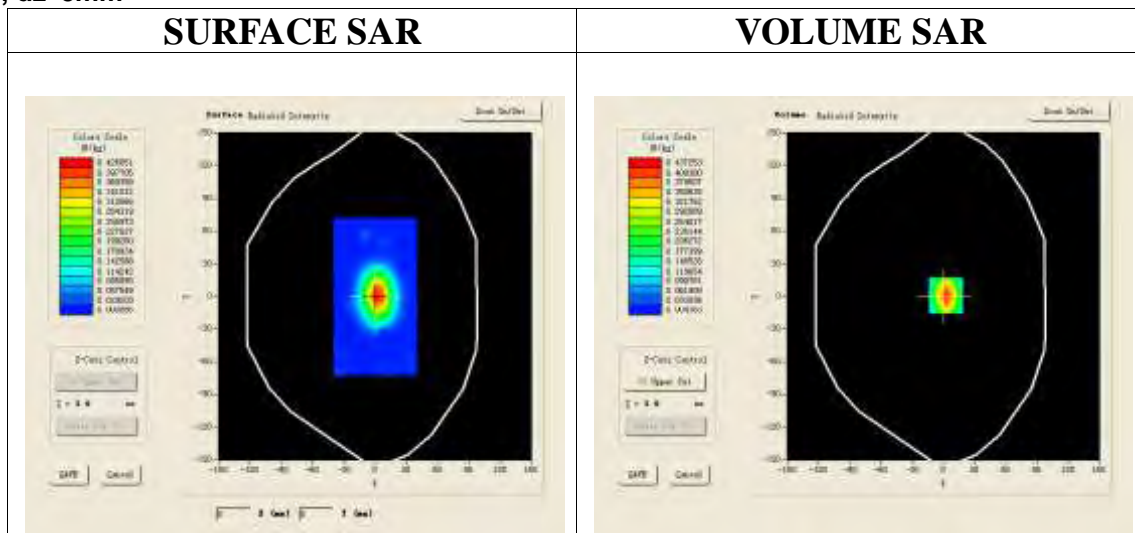

Maximum location: X=2.00, Y=1.00

SAR 10g (W/Kg)	0.238846
SAR 1g (W/Kg)	0.499910

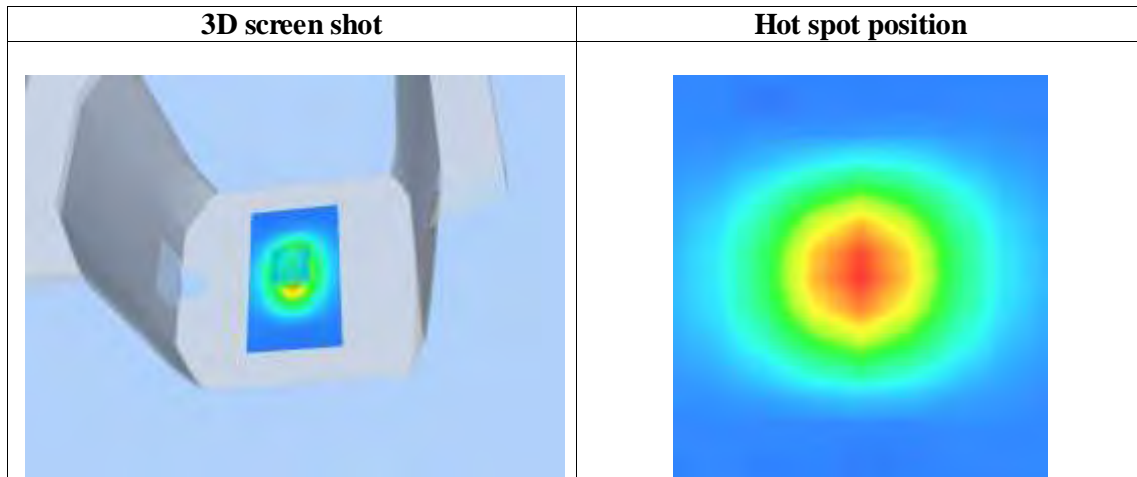
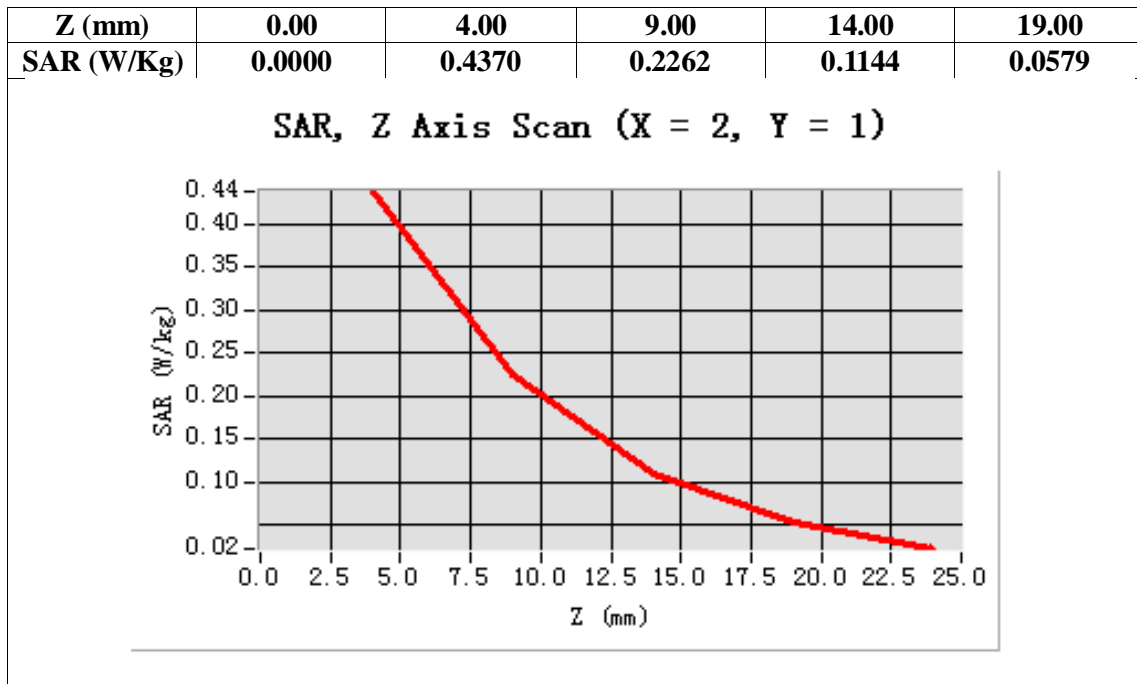

APPENDIX B. SAR MEASUREMENT DATA

Test Laboratory: AGC Lab
GSM 835 Mid-Touch-Left <SIM 1>
DUT: Pilot PLUS; Type: Z550

Date: June 26,2014

Communication System: Generic GSM; Communication System Band: GSM 835; Duty Cycle: 1:8.3; Conv.F=5.27
Frequency: 836.6 MHz; Medium parameters used: $f = 835$ MHz; $\sigma=0.90$ mho/m; $\epsilon_r = 41.94$; $\rho = 1000$ kg/m³ ;
Phantom section: Left Section
Ambient temperature (°C): 21.0, Liquid temperature (°C): 21.0

SATIMO Configuration:

- Probe: SSE5; Calibrated: 01/12/2014; Serial No.:SN 22/12 EP159
- Sensor-Surface: 4mm (Mechanical Surface Detection)
- Phantom: Flat Phantom; Type: Elliptical Phantom
- Measurement SW: OpenSAR V4_02_01

Configuration/GSM 835 Mid-Touch-Left/Area Scan (6x8x1): Measurement grid: dx=8mm, dy=8mm
Configuration/GSM 835 Mid-Touch-Left/Zoom Scan (5x5x7)/Cube 0: Measurement grid: dx=8mm, dy=8mm, dz=5mm

Area Scan	sam_direct_droit2_surf8mm.txt
ZoomScan	5x5x7,dx=8mm dy=8mm dz=5mm,Very fast
Phantom	Left head
Device Position	Cheek
Band	GSM 835
Channels	Middle
Signal	TDMA (Crest factor: 8.0)

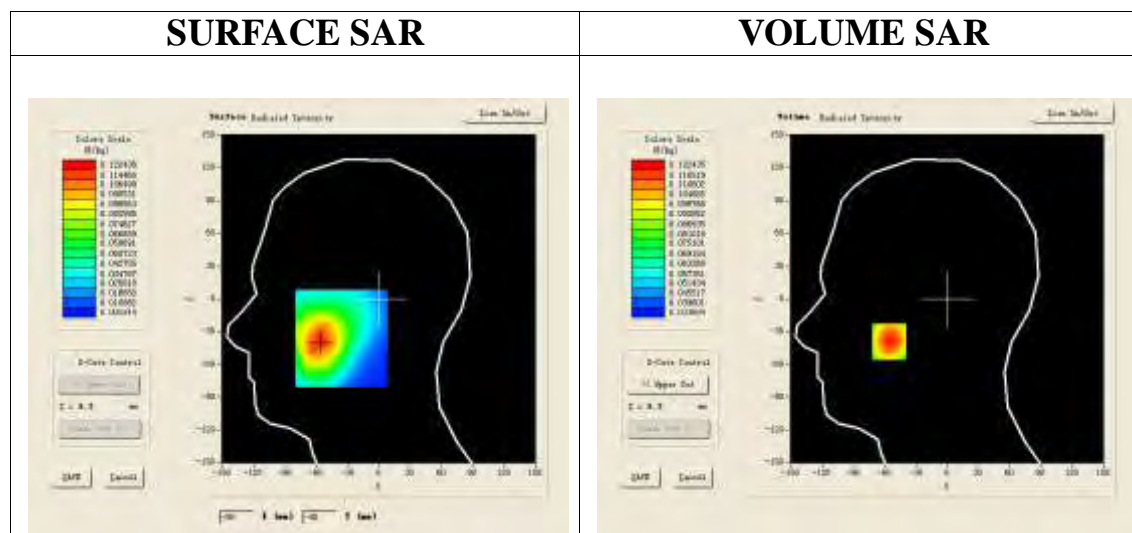

Maximum location: X=-56.00, Y=-39.00

SAR 10g (W/Kg)	0.090588
SAR 1g (W/Kg)	0.118065

Z (mm)	0.00	4.00	9.00	14.00	19.00
SAR (W/Kg)	0.0000	0.1224	0.1032	0.0852	0.0687

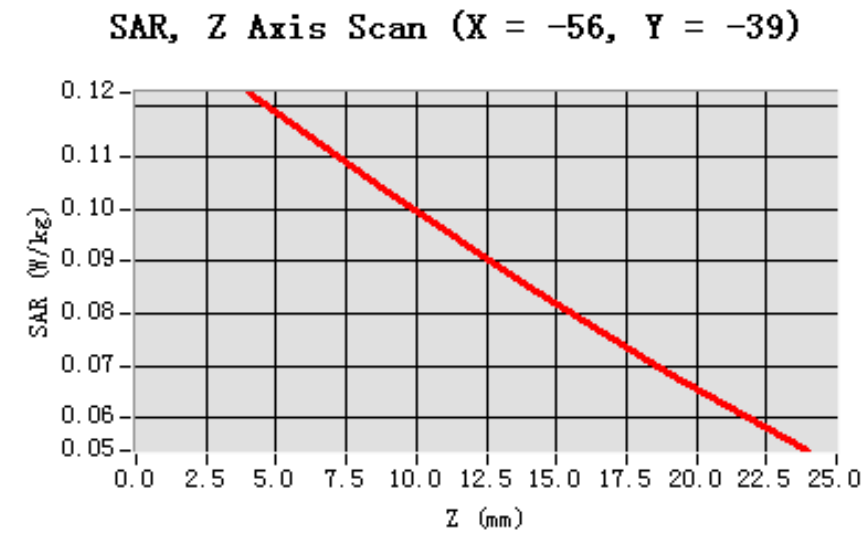

3D screen shot	Hot spot position

Test Laboratory: AGC Lab
GSM 835 Mid-Tilt-Left <SIM 1>
DUT: Pilot PLUS; Type: Z550

Date: June 26,2014

Communication System: Generic GSM; Communication System Band: GSM 835; Duty Cycle: 1:8.3; Conv.F=5.27;
Frequency: 836.6 MHz; Medium parameters used: f = 835 MHz; $\sigma=0.90$ mho/m; $\epsilon_r=41.94$; $\rho= 1000$ kg/m³ ;
Phantom section: Left Section
Ambient temperature (°C): 21.0, Liquid temperature(°C): 21.0

SATIMO Configuration:

- Probe: SSE5; Calibrated: 01/12/2014; Serial No.:SN 22/12 EP159
- Sensor-Surface: 4mm (Mechanical Surface Detection)
- Phantom: Flat Phantom; Type: Elliptical Phantom
- Measurement SW: OpenSAR V4_02_01

Configuration/GSM 835 Mid-Tilt-Left/Area Scan (6x8x1): Measurement grid: dx=8mm, dy=8mm
Configuration/GSM 835 Mid-Tilt-Left/Zoom Scan (5x5x7)/Cube 0: Measurement grid: dx=8mm, dy=8mm,dz=5mm;

Area Scan	sam_direct_droit2_surf8mm.txt
ZoomScan	5x5x7,dx=8mm dy=8mm dz=5mm,Very fast
Phantom	Left head
Device Position	Tilt
Band	GSM 835
Channels	Middle
Signal	TDMA (Crest factor: 8.0)

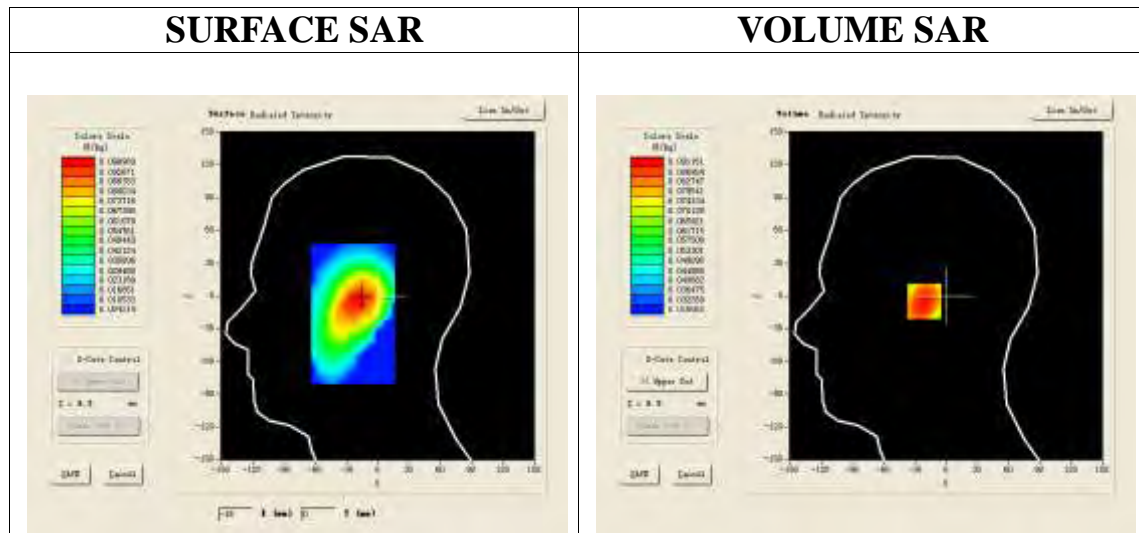

Maximum location: X=-18.00, Y=-5.00

SAR 10g (W/Kg)	0.071541
SAR 1g (W/Kg)	0.088743

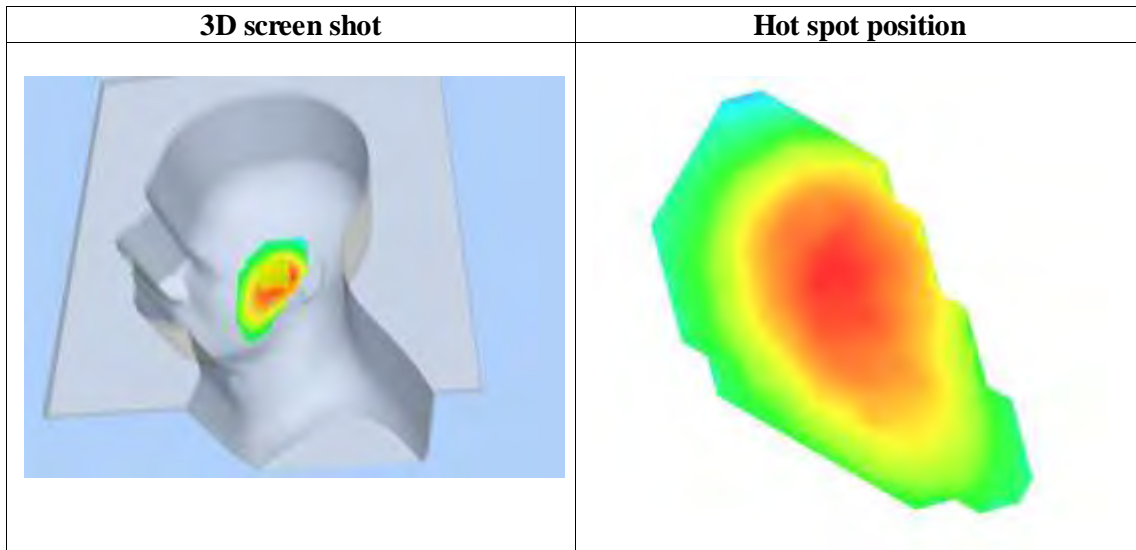
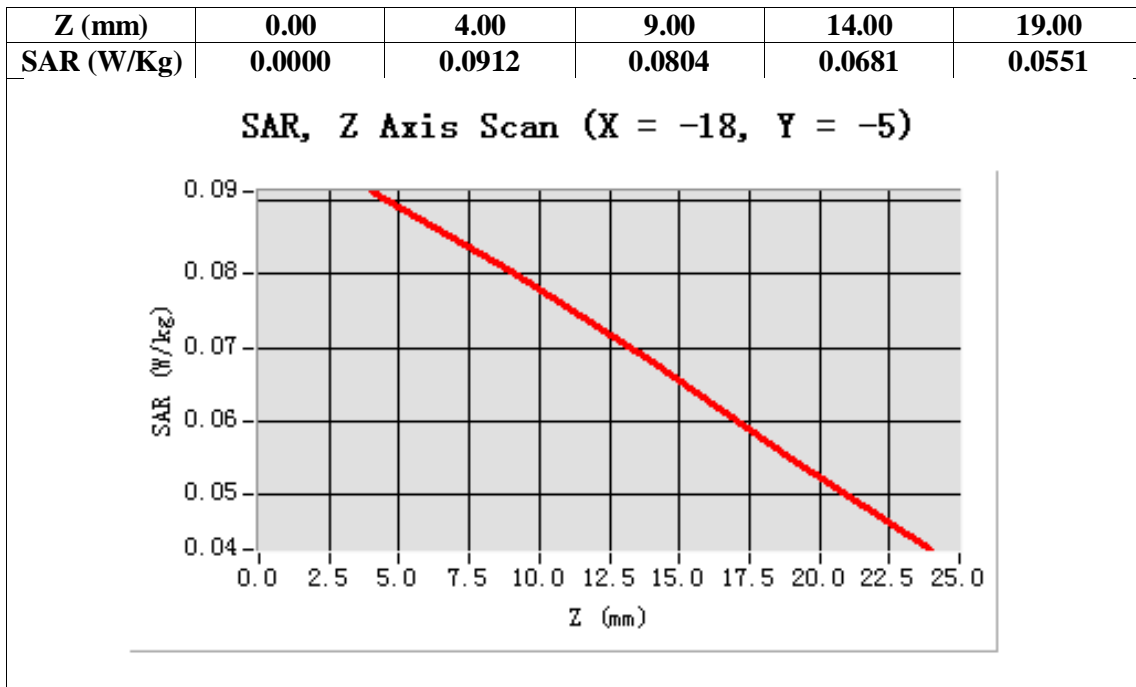

Test Laboratory: AGC Lab
GSM 835 Mid-Touch-Right <SIM 1>
DUT: Pilot PLUS; Type: Z550

Date: June 26,2014

Communication System: Generic GSM; Communication System Band: GSM 835; Duty Cycle: 1:8.3; Conv.F=5.27;
Frequency: 836.6 MHz; Medium parameters used: f = 835 MHz; $\sigma = 0.90$ mho/m; $\epsilon_r = 41.94$; $\rho = 1000$ kg/m³ ;
Phantom section: Right Section
Ambient temperature (°C): 21.0, Liquid temperature (°C): 21.0

SATIMO Configuration:

- Probe: SSE5; Calibrated: 01/12/2014; Serial No.:SN 22/12 EP159
- Sensor-Surface: 4mm (Mechanical Surface Detection)
- Phantom: Flat Phantom; Type: Elliptical Phantom
- Measurement SW: OpenSAR V4_02_01

Configuration/GSM 835 Mid-Touch-Right/Area Scan: Measurement grid: dx=8mm, dy=8mm
Configuration/GSM 835 Mid-Touch-Right/Zoom Scan: Measurement grid: dx=8mm, dy=8mm, dz=5mm;

Area Scan	sam_direct_droit2_surf8mm.txt
ZoomScan	5x5x7,dx=8mm dy=8mm dz=5mm,Very fast
Phantom	Right head
Device Position	Cheek
Band	GSM 835
Channels	Middle
Signal	TDMA (Crest factor: 8.0)

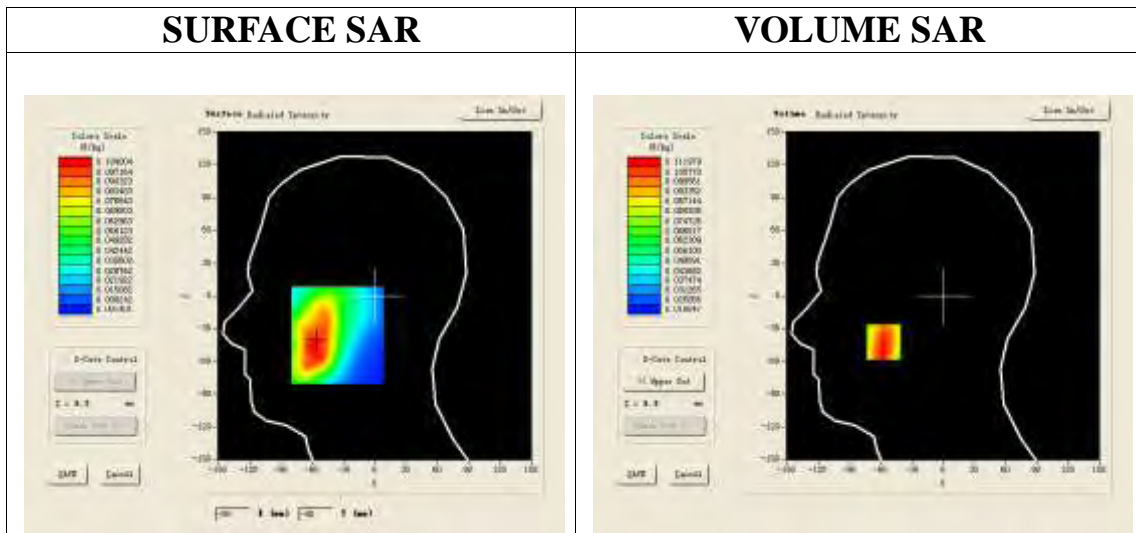

Maximum location: X=-57.00, Y=-42.00

SAR 10g (W/Kg)	0.073623
SAR 1g (W/Kg)	0.107688

Z (mm)	0.00	4.00	9.00	14.00	19.00
SAR (W/Kg)	0.0000	0.1110	0.0771	0.0553	0.0416

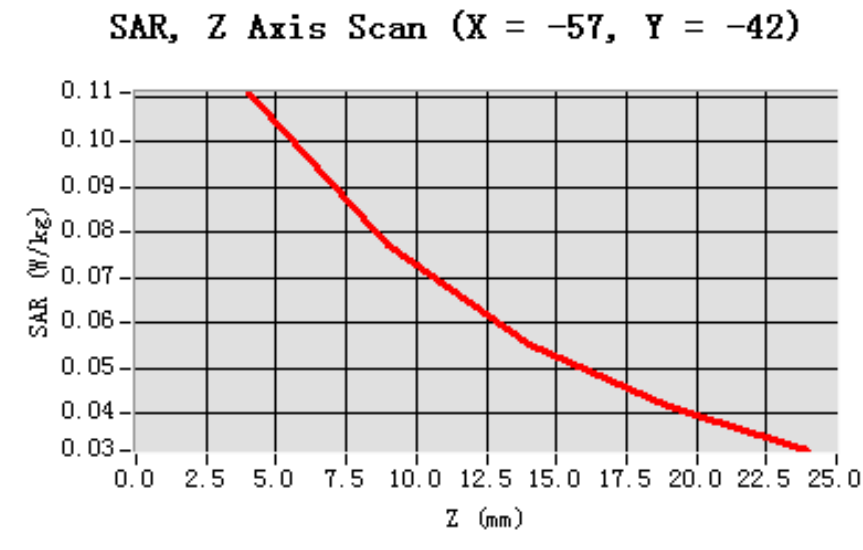

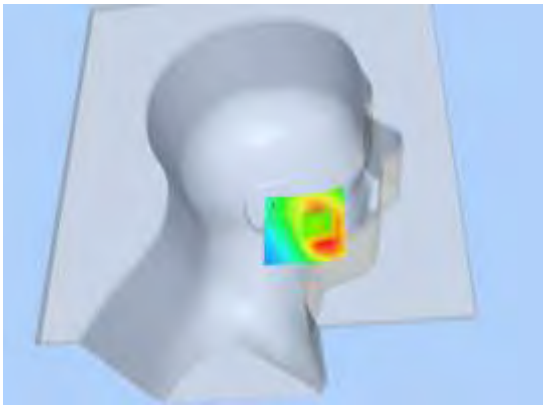
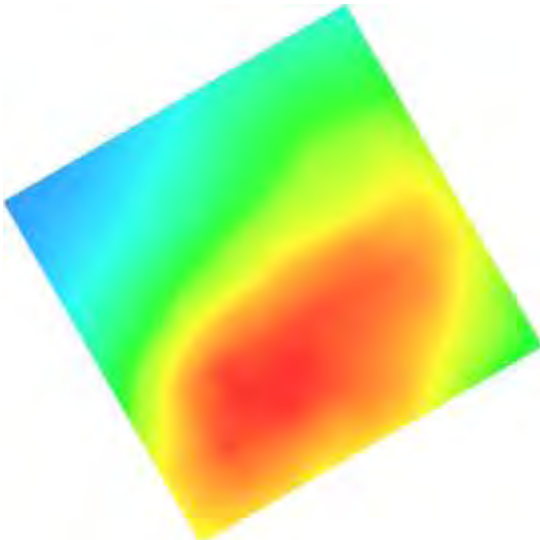
3D screen shot	Hot spot position
	

Test Laboratory: AGC Lab
GSM 835 Mid-Tilt-Right <SIM 1>
DUT: Pilot PLUS; Type: Z550

Date: June 26,2014

Communication System: Generic GSM; Communication System Band: GSM 835; Duty Cycle: 1:8.3; Conv.F=5.27;
Frequency: 836.6 MHz; Medium parameters used: f = 835 MHz; $\sigma=0.90$ mho/m; $\epsilon_r=41.94$; $\rho= 1000$ kg/m³ ;
Phantom section: Right Section
Ambient temperature (°C): 21.0, Liquid temperature (°C): 21.0

SATIMO Configuration:

- Probe: SSE5; Calibrated: 01/12/2014; Serial No.:SN 22/12 EP159
- Sensor-Surface: 4mm (Mechanical Surface Detection)
- Phantom: Flat Phantom; Type: Elliptical Phantom
- Measurement SW: OpenSAR V4_02_01

Configuration/GSM 835 Mid-Tilt-Right/Area Scan: Measurement grid: dx=8mm, dy=8mm
Configuration/GSM 835 Mid-Tilt-Right/Zoom Scan: Measurement grid: dx=8mm, dy=8mm, dz=5mm;

Area Scan	sam_direct_droit2_surf8mm.txt
Zoom Scan	5x5x7,dx=8mm dy=8mm dz=5mm,Very fast
Phantom	Right head
Device Position	Tilt
Band	GSM 835
Channels	Middle
Signal	TDMA (Crest factor: 8.0)

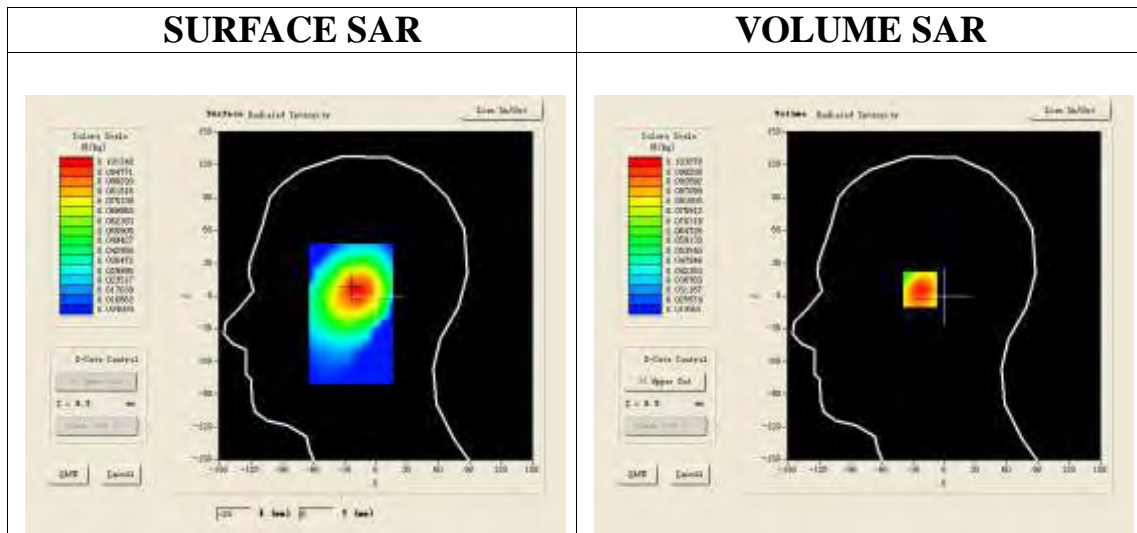

Maximum location: X=-21.00, Y=7.00

SAR 10g (W/Kg)	0.072054
SAR 1g (W/Kg)	0.099936

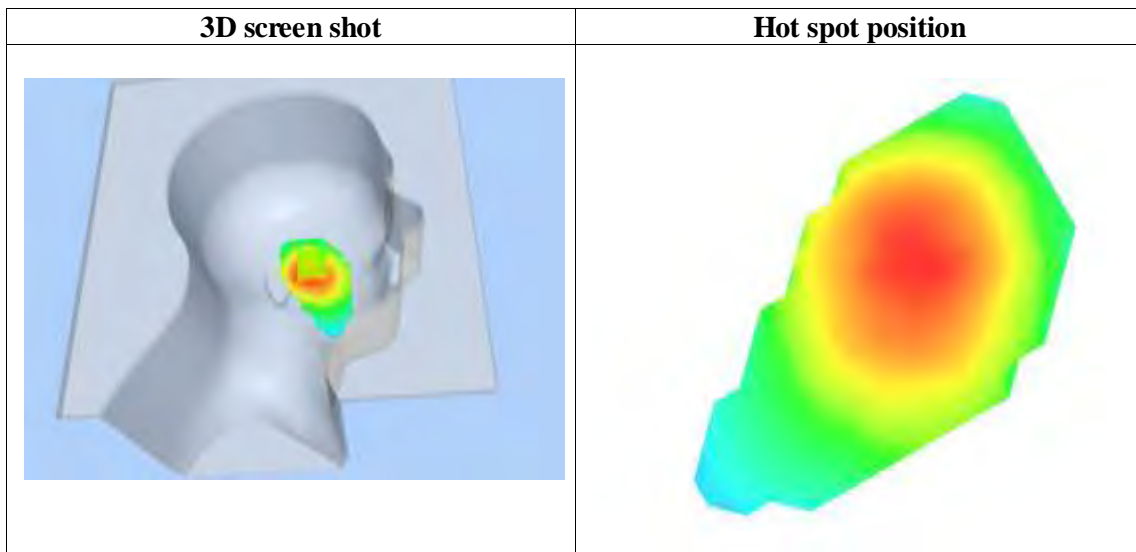
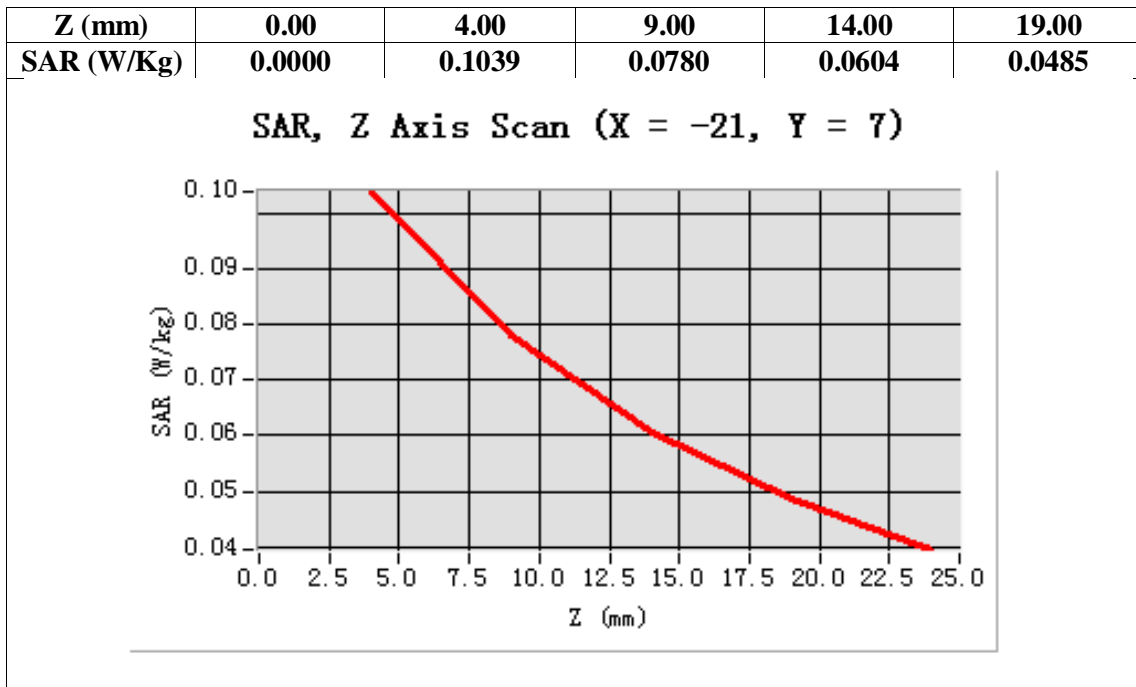

Test Laboratory: AGC Lab
GSM 835 Mid-Touch-Left <SIM 2>
DUT: Pilot PLUS; Type: Z550

Date: June 26,2014

Communication System: Generic GSM; Communication System Band: GSM 835; Duty Cycle: 1:8.3; Conv.F=5.27
Frequency: 836.6 MHz; Medium parameters used: f = 835 MHz; $\sigma=0.90$ mho/m; $\epsilon_r=41.94$; $\rho= 1000$ kg/m³ ;
Phantom section: Left Section
Ambient temperature (°C): 21.0, Liquid temperature (°C): 21.0

SATIMO Configuration:

- Probe: SSE5; Calibrated: 01/12/2014; Serial No.:SN 22/12 EP159
- Sensor-Surface: 4mm (Mechanical Surface Detection)
- Phantom: Flat Phantom; Type: Elliptical Phantom
- Measurement SW: OpenSAR V4_02_01

Configuration/GSM 835 Mid-Touch-Left/Area Scan (6x8x1): Measurement grid: dx=8mm, dy=8mm
Configuration/GSM 835 Mid-Touch-Left/Zoom Scan (5x5x7)/Cube 0: Measurement grid: dx=8mm, dy=8mm, dz=5mm

Area Scan	sam_direct_droit2_surf8mm.txt
ZoomScan	5x5x7,dx=8mm dy=8mm dz=5mm,Very fast
Phantom	Left head
Device Position	Cheek
Band	GSM 835
Channels	Middle
Signal	TDMA (Crest factor: 8.0)

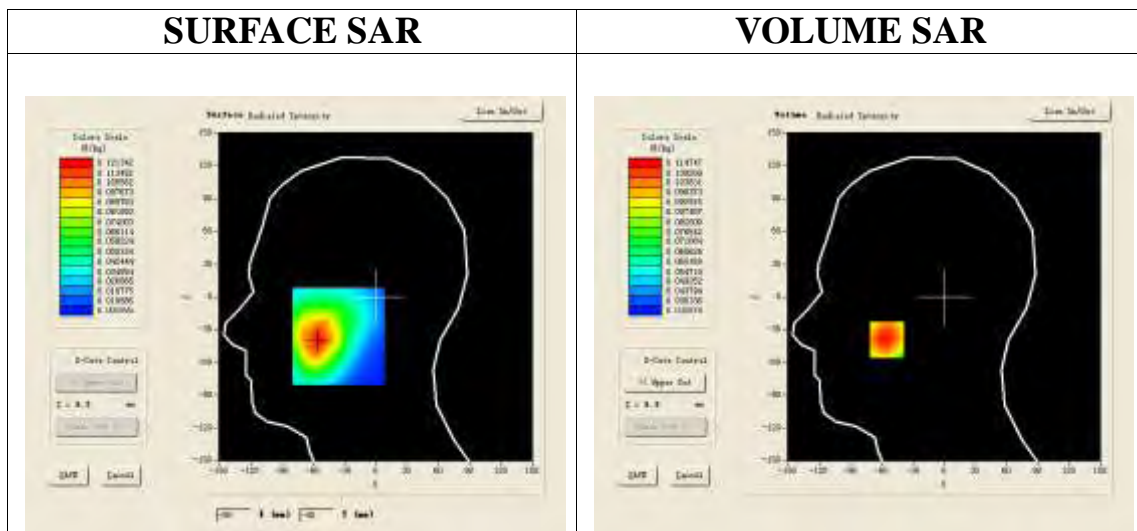

Maximum location: X=-55.00, Y=-39.00

SAR 10g (W/Kg)	0.087112
SAR 1g (W/Kg)	0.111301

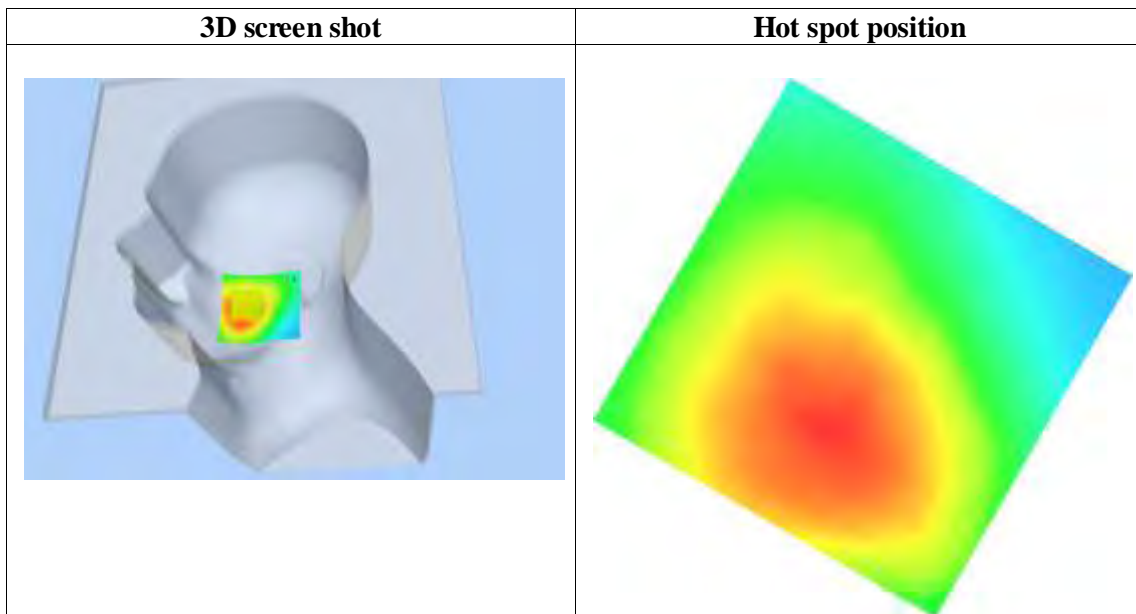
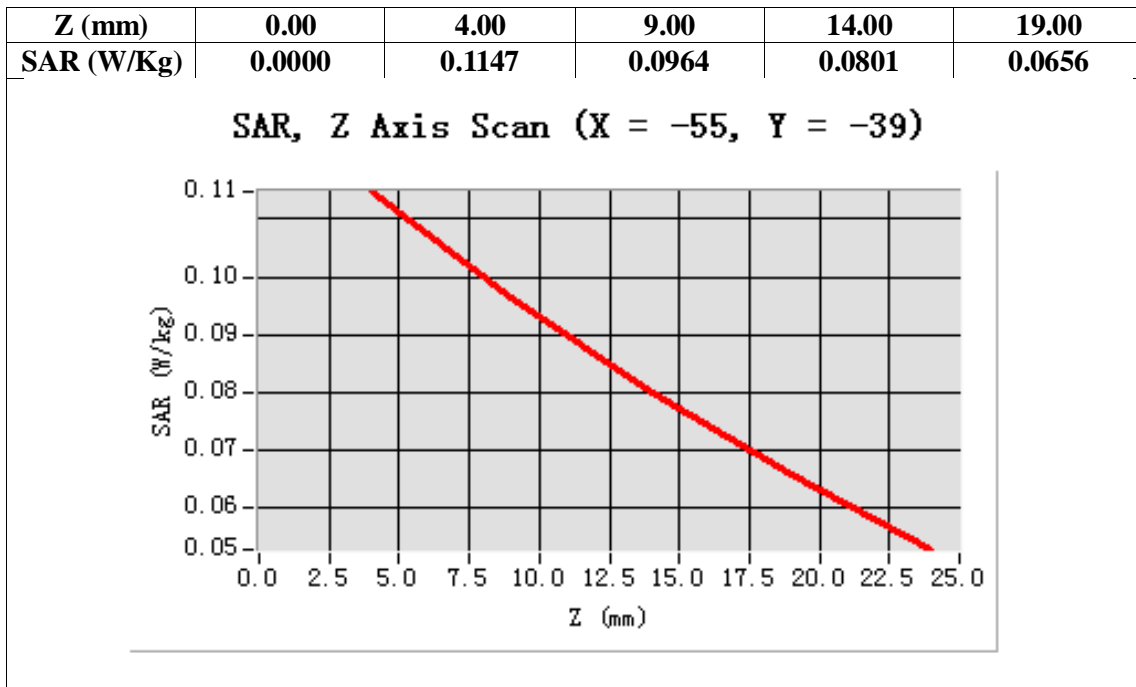

Test Laboratory: AGC Lab
GSM 835 Mid- Body- Back <SIM 1>
DUT: Pilot PLUS; Type: Z550

Date: June 26,2014

Communication System: Generic GSM; Communication System Band: GSM 835; Duty Cycle: 1:8.3; Conv.F=5.48;
Frequency: 836.6 MHz; Medium parameters used: f = 835 MHz; $\sigma = 0.98\text{mho/m}$; $\epsilon_r = 55.73$; $\rho = 1000 \text{ kg/m}^3$;
Phantom section: Flat Section
Ambient temperature (°C): 21.0, Liquid temperature (°C): 21.0

SATIMO Configuration:

- Probe: SSE5; Calibrated: 01/12/2014; Serial No.:SN 22/12 EP159
- Sensor-Surface: 4mm (Mechanical Surface Detection)
- Phantom: Flat Phantom; Type: Elliptical Phantom
- Measurement SW: OpenSAR V4_02_01

Configuration/GSM 835 Mid-Body-Back/Area Scan (6x8x1): Measurement grid: dx=8mm, dy=8mm
Configuration/GSM 835 Mid-Body-Back/Zoom Scan (5x5x7)/Cube 0: Measurement grid: dx=8mm, dy=8mm, dz=5mm;

Area Scan	surf_sam_plan.txt
ZoomScan	5x5x7,dx=8mm dy=8mm dz=5mm,Very fast
Phantom	Validation plane
Device Position	Body Back
Band	GSM 835
Channels	Middle
Signal	TDMA (Crest factor: 8.0)

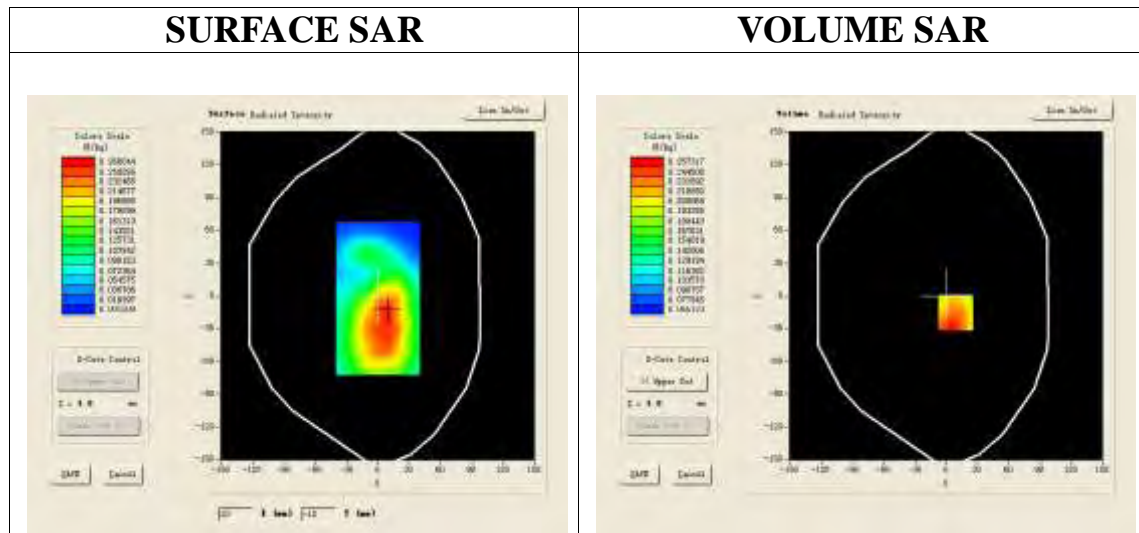

Maximum location: X=9.00, Y=-15.00

SAR 10g (W/Kg)	0.184501
SAR 1g (W/Kg)	0.244414

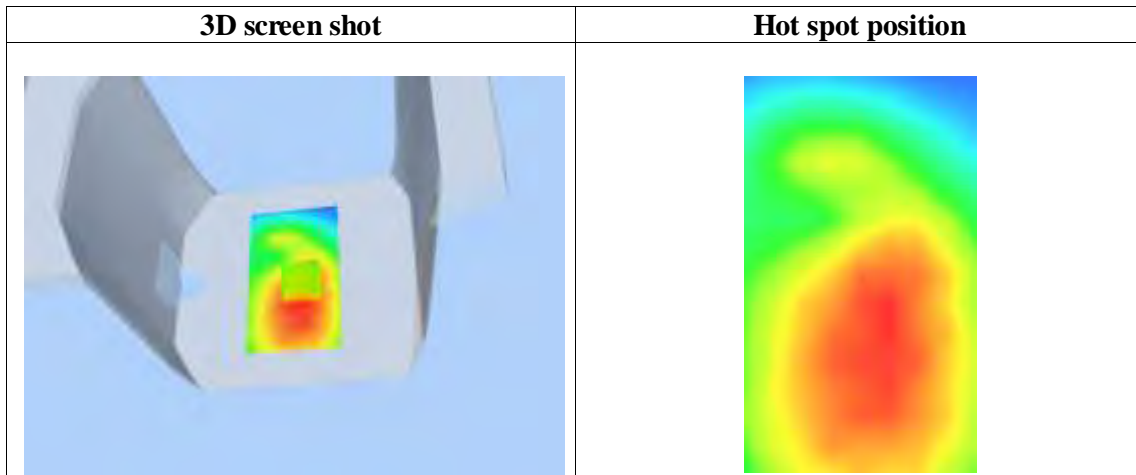
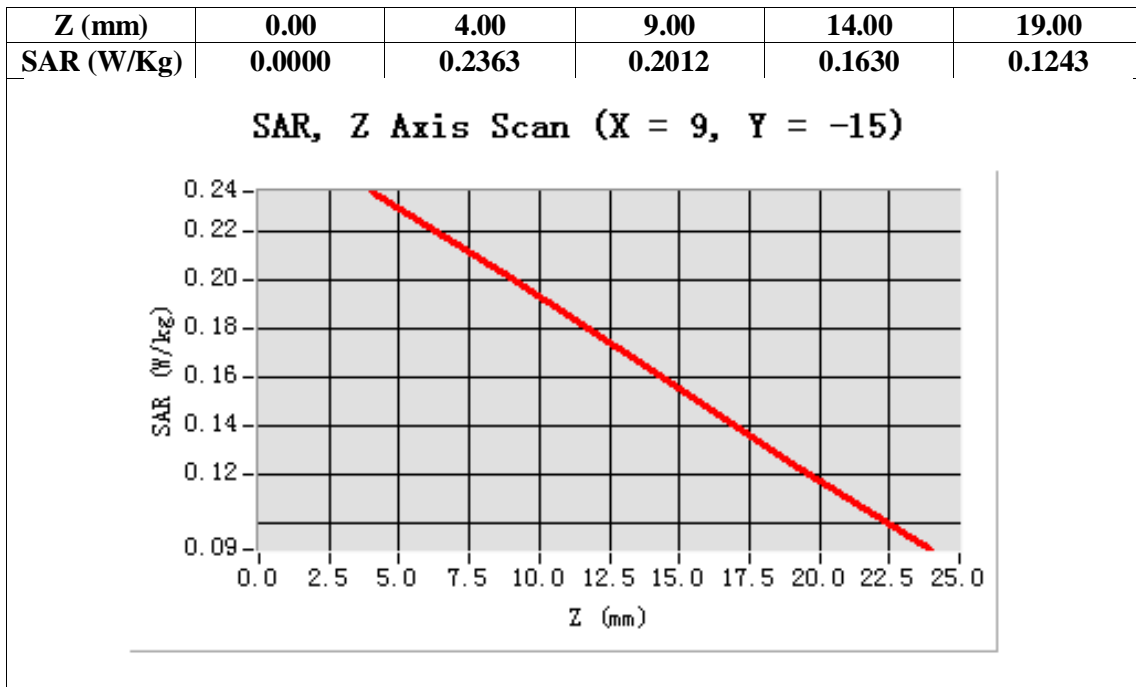

Test Laboratory: AGC Lab
GSM 835 Mid- Body- Front (MS) <SIM 1>
DUT: Pilot PLUS; Type: Z550

Date: June 26,2014

Communication System: Generic GSM; Communication System Band: GSM 835; Duty Cycle: 1:8.3; Conv.F=5.48;
Frequency: 836.6 MHz; Medium parameters used: f = 835 MHz; $\sigma = 0.98\text{mho/m}$; $\epsilon_r = 55.73$; $\rho = 1000 \text{ kg/m}^3$;
Phantom section: Flat Section
Ambient temperature (°C): 21.0, Liquid temperature (°C): 21.0

SATIMO Configuration:

- Probe: SSE5; Calibrated: 01/12/2014; Serial No.:SN 22/12 EP159
- Sensor-Surface: 4mm (Mechanical Surface Detection)
- Phantom: Flat Phantom; Type: Elliptical Phantom
- Measurement SW: OpenSAR V4_02_01

Configuration/GSM 835 Mid-Body- Front /Area Scan (6x8x1): Measurement grid: dx=8mm, dy=8mm
Configuration/GSM 835 Mid-Body- Front Zoom Scan (5x5x7)/Cube 0: Measurement grid: dx=8mm, dy=8mm, dz=5mm;

Area Scan	surf_sam_plan.txt
ZoomScan	5x5x7,dx=8mm dy=8mm dz=5mm,Very fast
Phantom	Validation plane
Device Position	Body Front
Band	GSM 835
Channels	Middle
Signal	TDMA (Crest factor: 8.0)

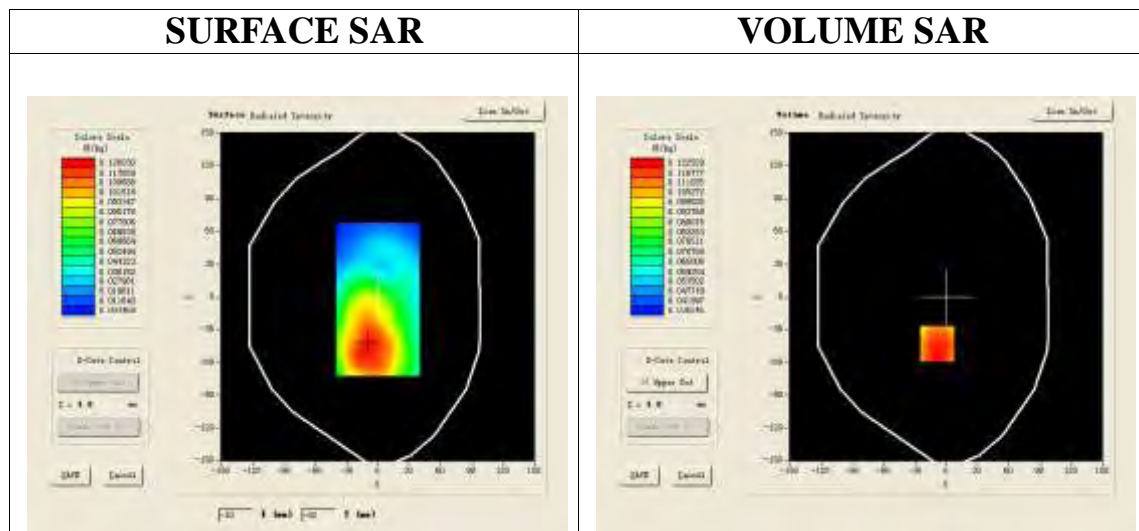

Maximum location: X=-9.00, Y=-43.00

SAR 10g (W/Kg)	0.089984
SAR 1g (W/Kg)	0.118502

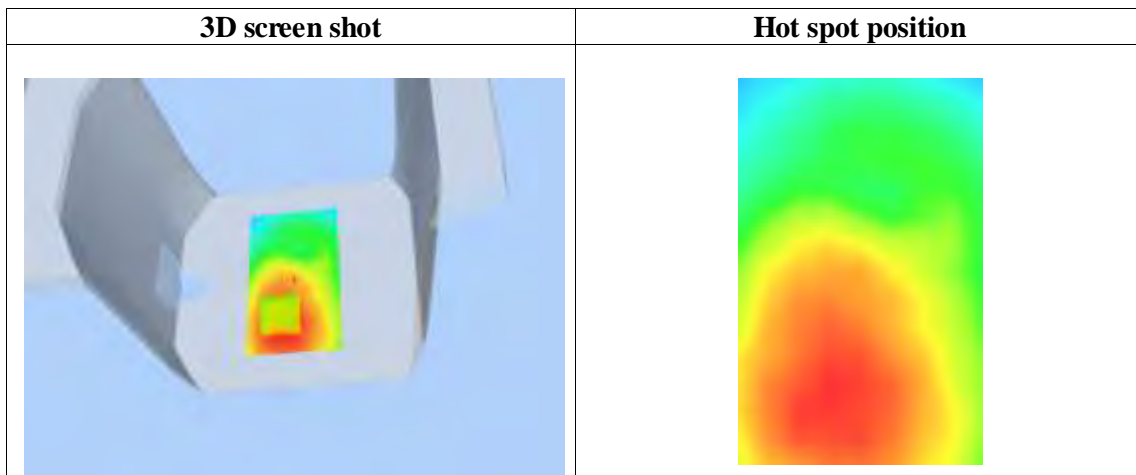
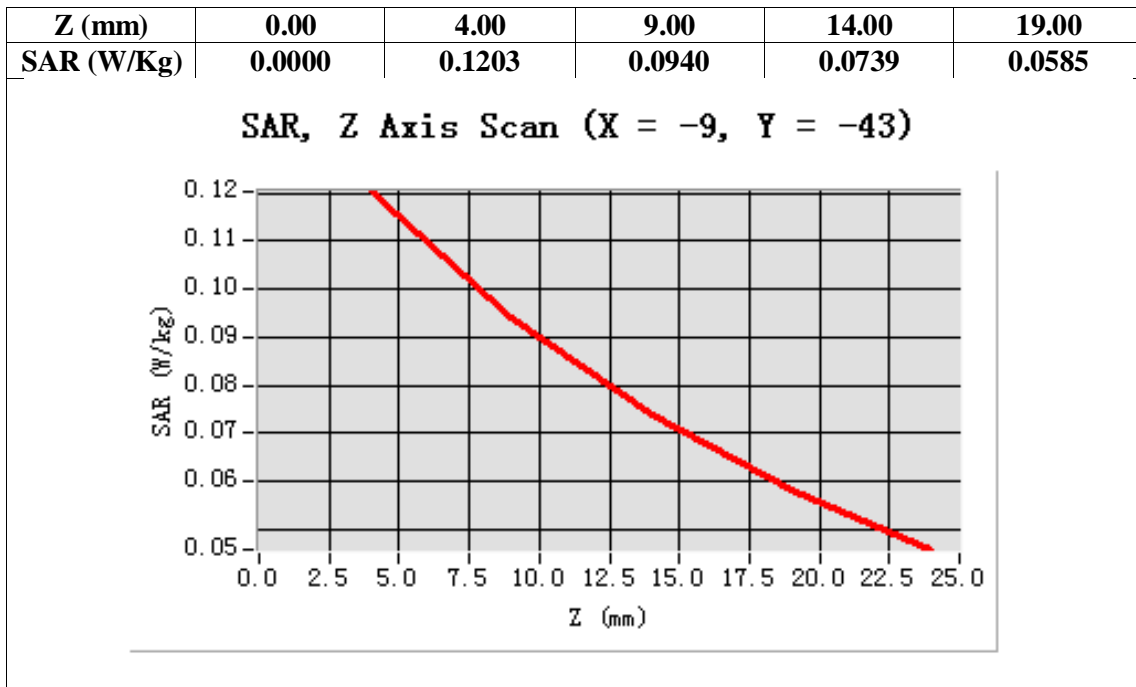

Test Laboratory: AGC Lab
PCS 1900 Mid-Touch-Left <SIM 1>
DUT: Pilot PLUS; Type: Z550

Date: June 26,2014

Communication System: Generic GSM; Communication System Band: PCS 1900; Duty Cycle: 1:8.3; Conv.F=4.51;
Frequency: 1880 MHz; Medium parameters used: $f = 1900$ MHz; $\sigma = 1.42$ mho/m; $\epsilon_r = 40.19$; $\rho = 1000$ kg/m³ ;
Phantom section: Left Section
Ambient temperature (°C): 21.0, Liquid temperature (°C): 21.0

SATIMO Configuration:

- Probe: SSE5; Calibrated: 01/12/2014; Serial No.:SN 22/12 EP159
- Sensor-Surface: 4mm (Mechanical Surface Detection)
- Phantom: Flat Phantom; Type: Elliptical Phantom
- Measurement SW: OpenSAR V4_02_01

Configuration/PCS1900 Mid-Touch-Left/Area Scan: Measurement grid: dx=8mm, dy=8mm

Configuration/PCS1900 Mid-Touch-Left/Zoom Scan: Measurement grid: dx=8mm, dy=8mm, dz=5mm;

Area Scan	sam_direct_droit2_surf8mm.txt
ZoomScan	5x5x7,dx=8mm dy=8mm dz=5mm,Very fast
Phantom	Left head
Device Position	Cheek
Band	PCS 1900
Channels	Middle
Signal	TDMA (Crest factor: 8.0)

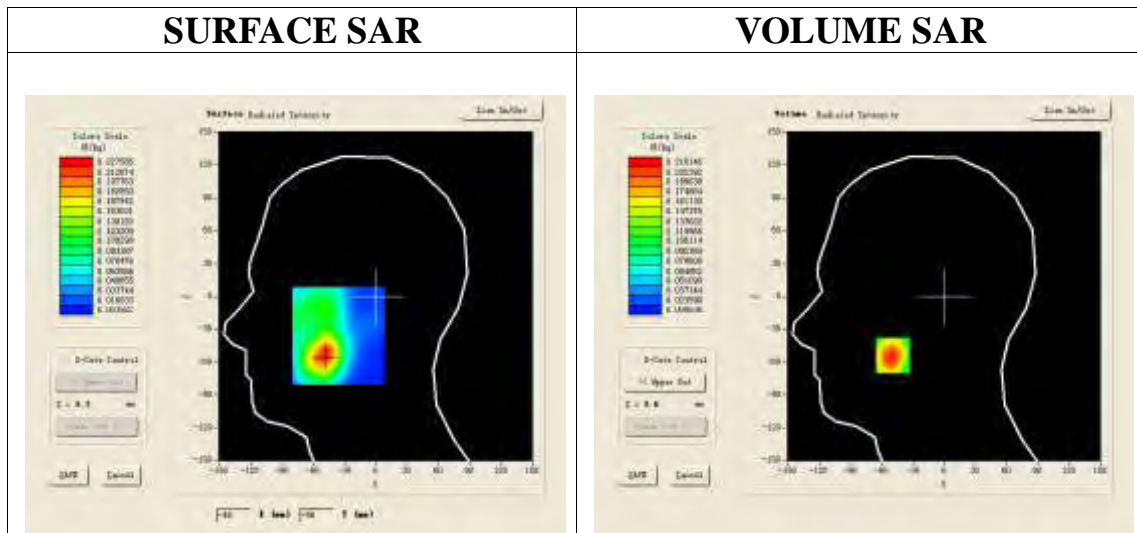

Maximum location: X=-49.00, Y=-54.00

SAR 10g (W/Kg)	0.121517
SAR 1g (W/Kg)	0.204179

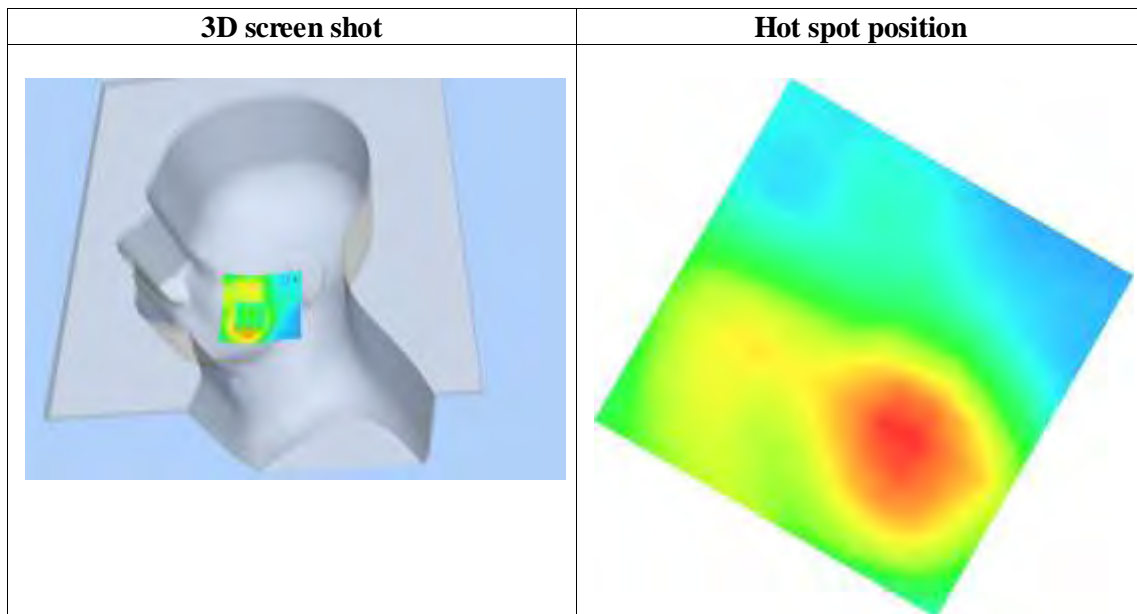
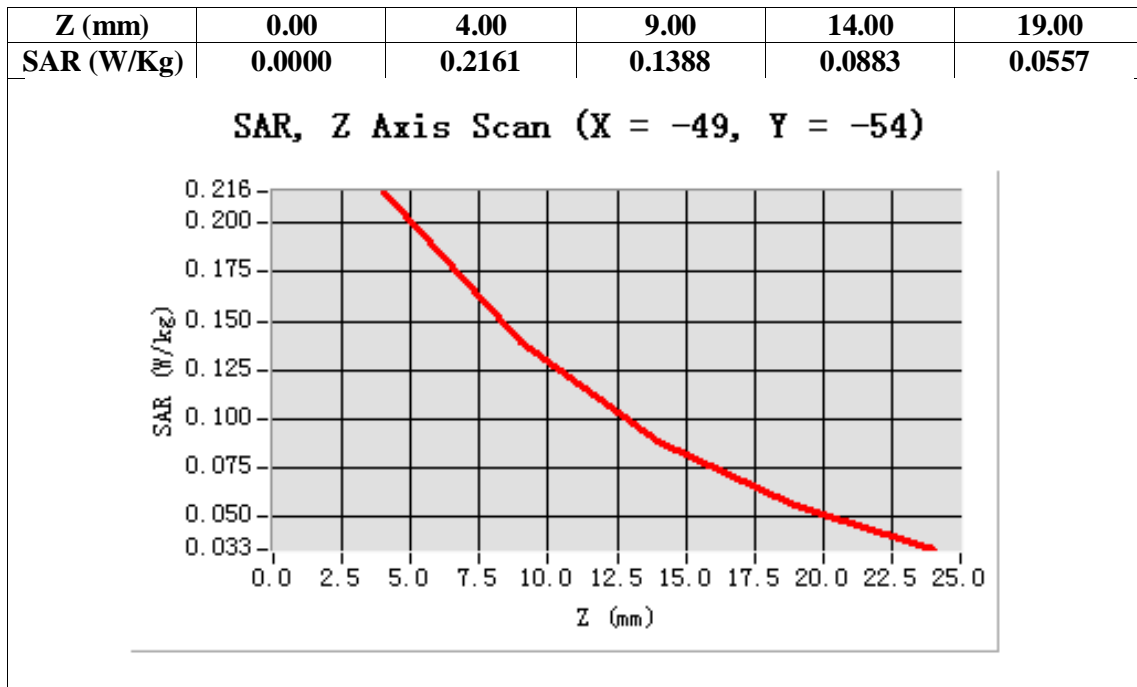

Test Laboratory: AGC Lab
PCS 1900 Mid-Tilt-Left <SIM 1>
DUT: Pilot PLUS; Type: Z550

Date: June 26,2014

Communication System: Generic GSM; Communication System Band: PCS 1900; Duty Cycle: 1:8.3; Conv.F=4.51;
Frequency: 1880 MHz; Medium parameters used: $f = 1900$ MHz; $\sigma = 1.42$ mho/m; $\epsilon_r = 40.19$; $\rho = 1000$ kg/m³ ;
Phantom section: Left Section
Ambient temperature (°C): 21.0, Liquid temperature (°C): 21.0

SATIMO Configuration:

- Probe: SSE5; Calibrated: 01/12/2014; Serial No.:SN 22/12 EP159
- Sensor-Surface: 4mm (Mechanical Surface Detection)
- Phantom: Flat Phantom; Type: Elliptical Phantom
- Measurement SW: OpenSAR V4_02_01

Configuration/PCS1900 Mid-Tilt-Left/Area Scan: Measurement grid: dx=8mm, dy=8mm
Configuration/PCS1900 Mid-Tilt-Left/Zoom Scan: Measurement grid: dx=8mm, dy=8mm,dz=5mm;

Area Scan	sam_direct_droit2_surf8mm.txt
ZoomScan	5x5x7,dx=8mm dy=8mm dz=5mm,Very fast
Phantom	Left head
Device Position	Tilt
Band	PCS 1900
Channels	Middle
Signal	TDMA (Crest factor: 8.0)

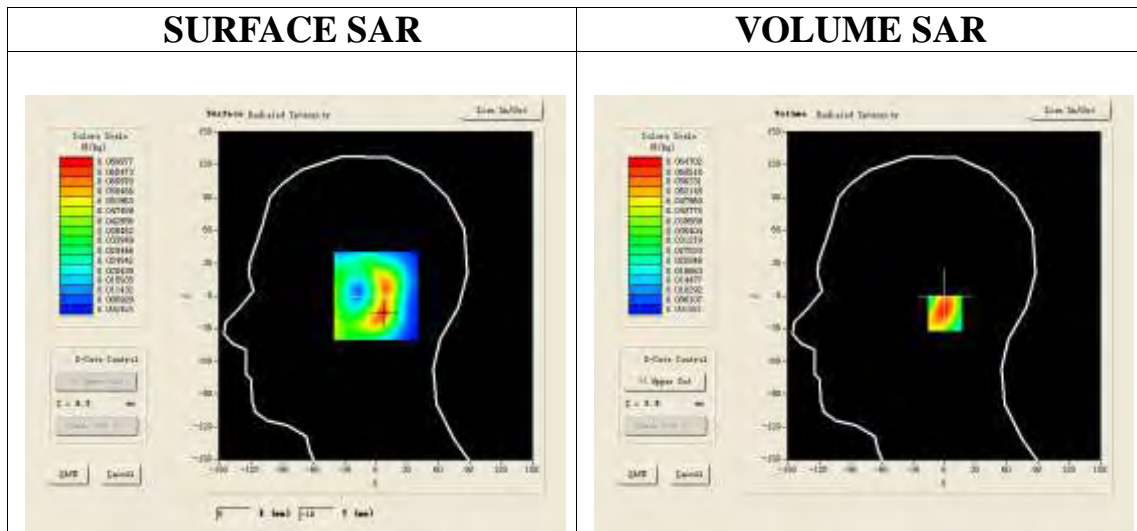

Maximum location: X=7.00, Y=-16.00

SAR 10g (W/Kg)	0.035412
SAR 1g (W/Kg)	0.061844

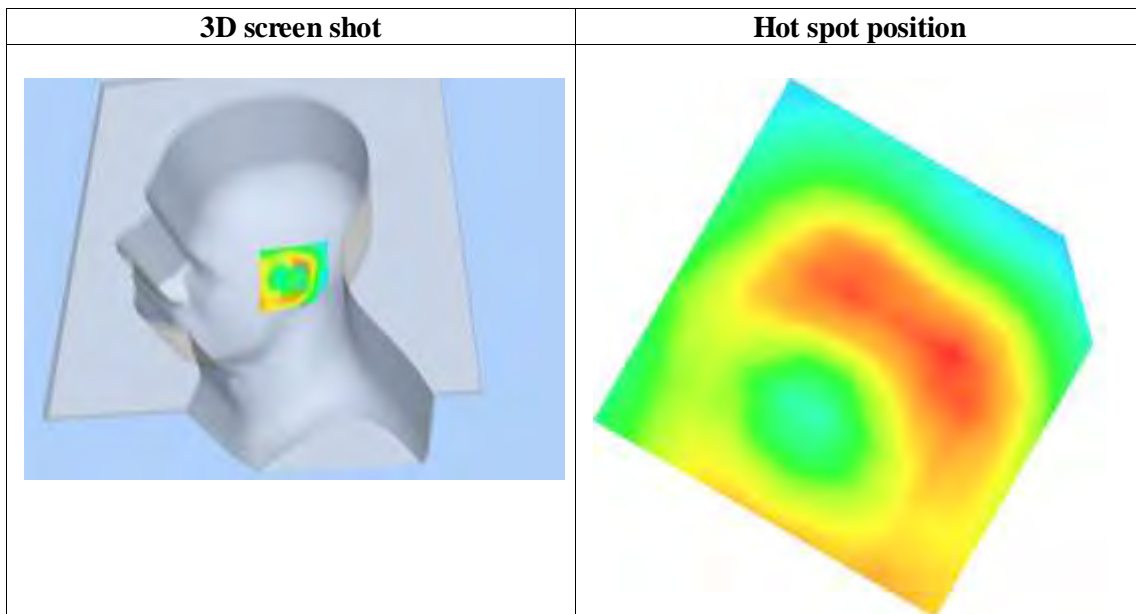
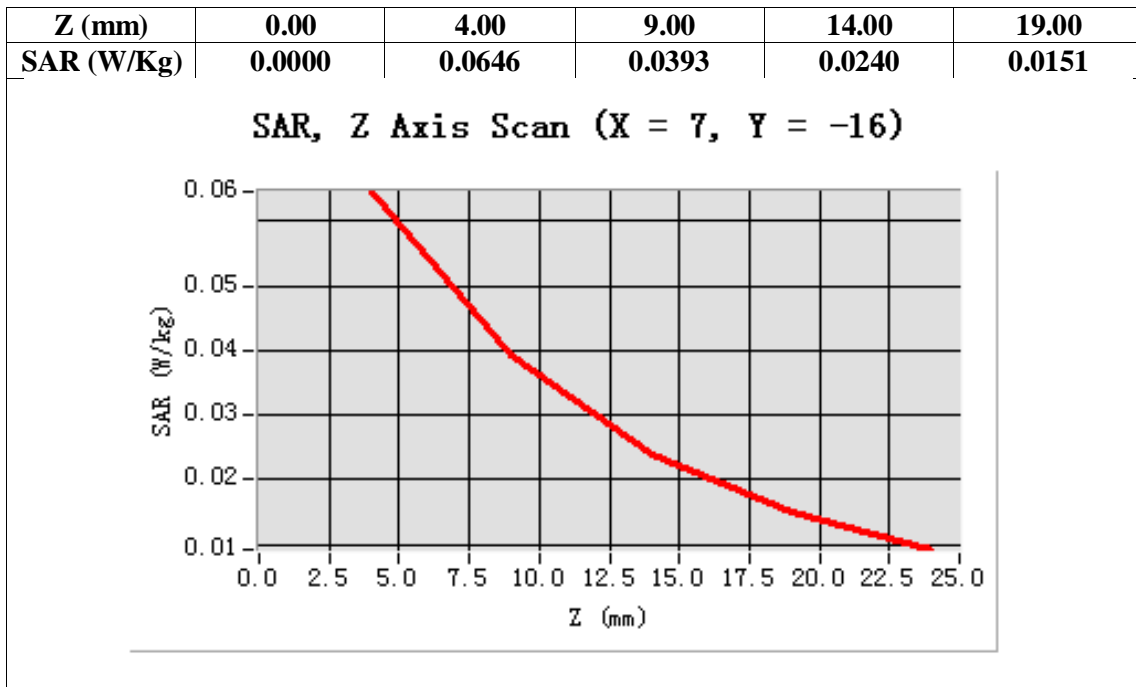

Test Laboratory: AGC Lab
PCS 1900 Mid-Touch-Right <SIM 1>
DUT: Pilot PLUS; Type: Z550

Date: June 26,2014

Communication System: Generic GSM; Communication System Band: PCS 1900; Duty Cycle: 1:8.3; Conv.F=4.51;
Frequency: 1880 MHz; Medium parameters used: $f = 1900$ MHz; $\sigma = 1.42$ mho/m; $\epsilon_r = 40.19$; $\rho = 1000$ kg/m³ ;
Phantom section: Right Section
Ambient temperature (°C): 21.0, Liquid temperature (°C): 21.0

SATIMO Configuration:

- Probe: SSE5; Calibrated: 01/12/2014; Serial No.:SN 22/12 EP159
- Sensor-Surface: 4mm (Mechanical Surface Detection)
- Phantom: Flat Phantom; Type: Elliptical Phantom
- Measurement SW: Open SAR V4_02_01

Configuration/PCS1900 Mid-Touch-Right/Area Scan: Measurement grid: dx=8mm, dy=8mm
Configuration/PCS1900 Mid-Touch-Right/Zoom Scan: Measurement grid: dx=8mm, dy=8mm, dz=5mm;

Area Scan	sam_direct_droit2_surf8mm.txt
ZoomScan	5x5x7,dx=8mm dy=8mm dz=5mm,Very fast
Phantom	Right head
Device Position	Cheek
Band	PCS 1900
Channels	Middle
Signal	TDMA (Crest factor: 8.0)

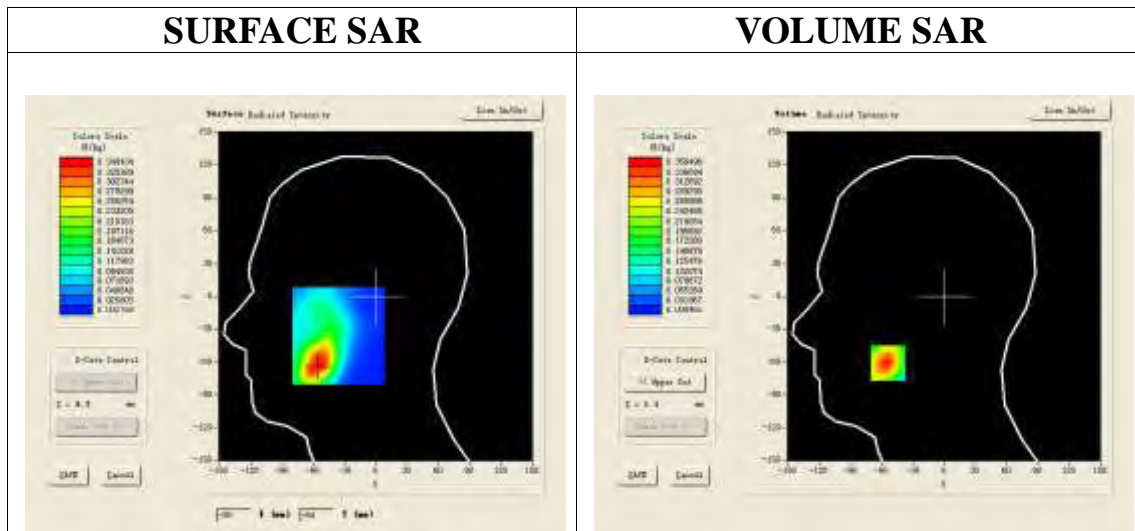

Maximum location: X=-54.00, Y=-61.00

SAR 10g (W/Kg)	0.190083
SAR 1g (W/Kg)	0.339216

Z (mm)	0.00	4.00	9.00	14.00	19.00
SAR (W/Kg)	0.0000	0.3595	0.2088	0.1239	0.0781

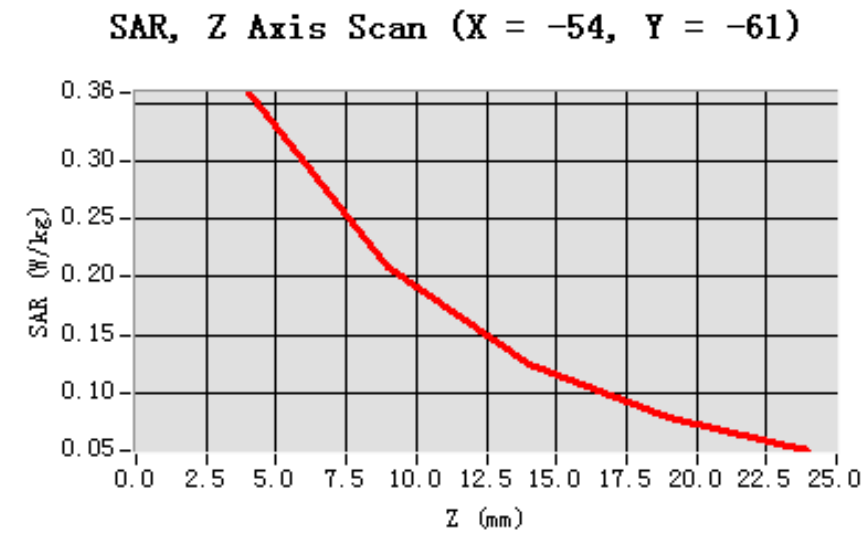

3D screen shot

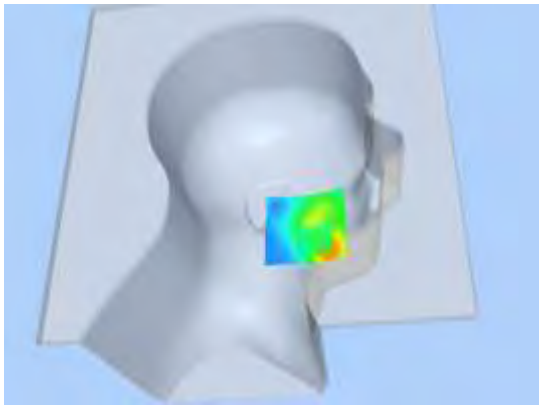

Hot spot position

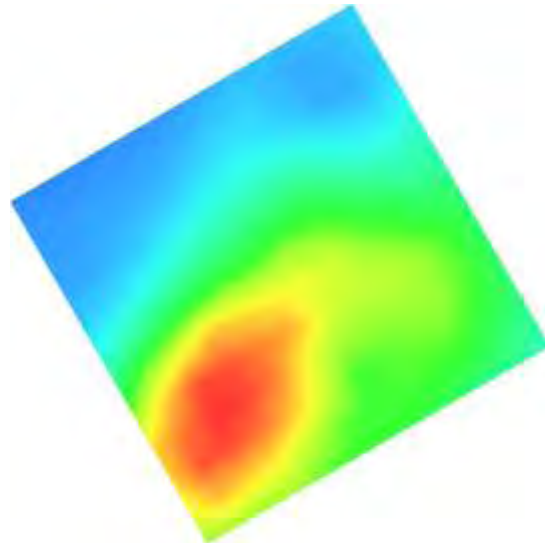

Test Laboratory: AGC Lab
PCS 1900 Mid-Tilt-Right <SIM 1>
DUT: Pilot PLUS; Type: Z550

Date: June 26,2014

Communication System: Generic GSM; Communication System Band: PCS 1900; Duty Cycle: 1:8.3; Conv.F=4.51;
Frequency: 1880 MHz; Medium parameters used: $f = 1900$ MHz; $\sigma = 1.42$ mho/m; $\epsilon_r = 40.19$; $\rho = 1000$ kg/m³ ;
Phantom section: Right Section
Ambient temperature (°C): 21.0, Liquid temperature (°C): 21.0

SATIMO Configuration:

- Probe: SSE5; Calibrated: 01/12/2014; Serial No.:SN 22/12 EP159
- Sensor-Surface: 4mm (Mechanical Surface Detection)
- Phantom: Flat Phantom; Type: Elliptical Phantom
- Measurement SW: OpenSAR V4_02_01

Configuration/PCS1900 Mid-Tilt-Right/Area Scan: Measurement grid: dx=8mm, dy=8mm
Configuration/PCS1900 Mid-Tilt-Right/Zoom Scan: Measurement grid: dx=8mm, dy=8mm, dz=5mm;

Area Scan	sam_direct_droit2_surf8mm.txt
ZoomScan	5x5x7,dx=8mm dy=8mm dz=5mm,Very fast
Phantom	Right head
Device Position	Tilt
Band	PCS 1900
Channels	Middle
Signal	TDMA (Crest factor: 8.0)

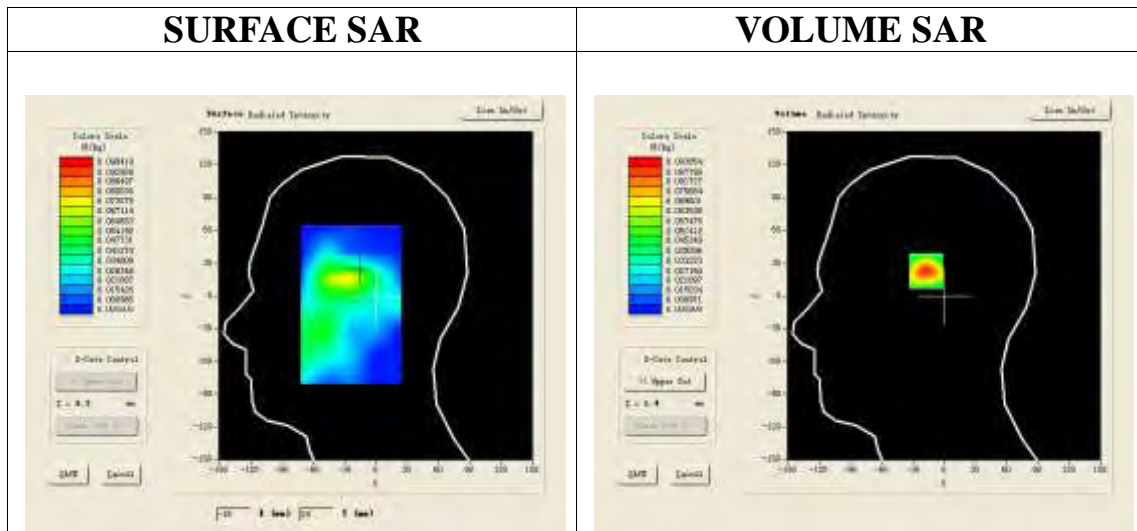

Maximum location: X=-16.00, Y=25.00

SAR 10g (W/Kg)	0.050811
SAR 1g (W/Kg)	0.087265

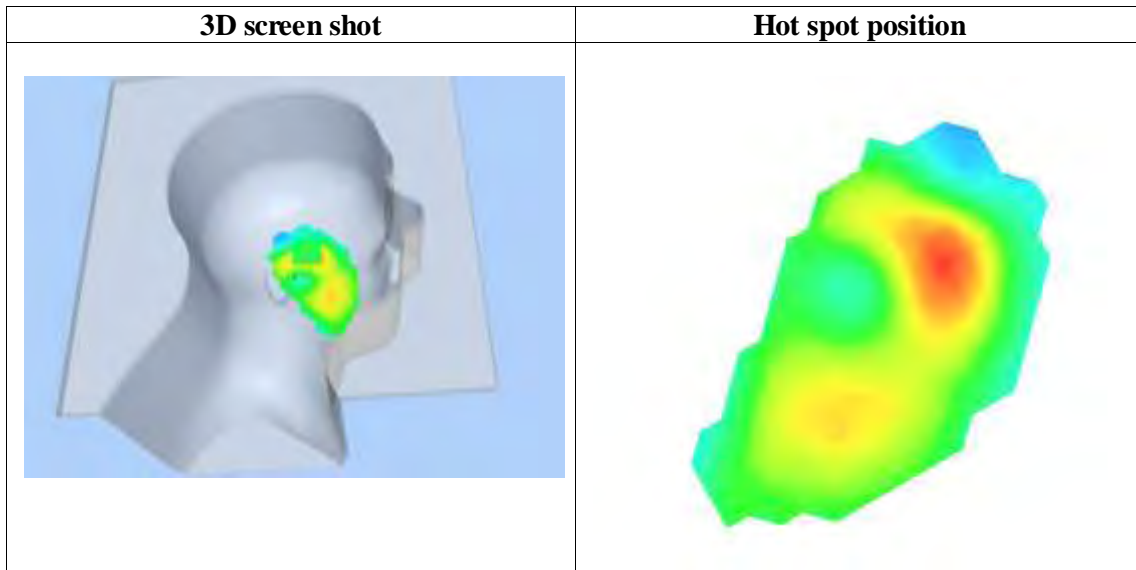
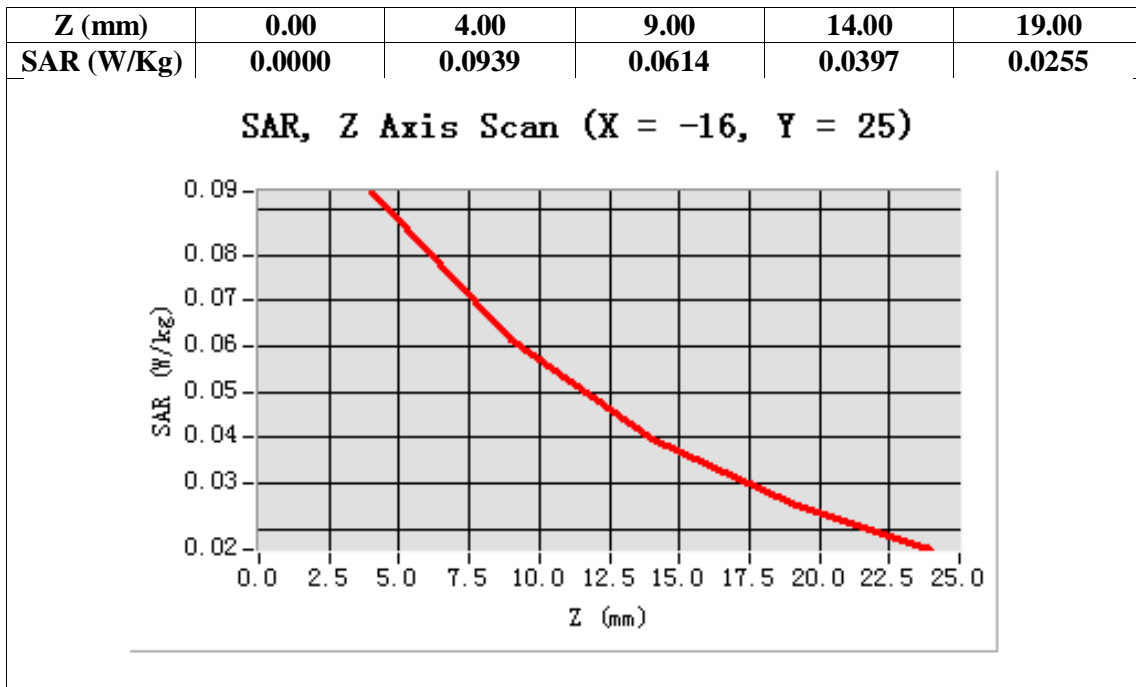

Test Laboratory: AGC Lab
PCS 1900 Mid-Touch-Right <SIM 2>
DUT: Pilot PLUS; Type: Z550

Date: June 26,2014

Communication System: Generic GSM; Communication System Band: PCS 1900; Duty Cycle: 1:8.3; Conv.F=4.51;
Frequency: 1880 MHz; Medium parameters used: $f = 1900$ MHz; $\sigma = 1.42$ mho/m; $\epsilon_r = 40.19$; $\rho = 1000$ kg/m³ ;
Phantom section: Right Section
Ambient temperature (°C): 21.0, Liquid temperature (°C): 21.0

SATIMO Configuration:

- Probe: SSE5; Calibrated: 01/12/2014; Serial No.:SN 22/12 EP159
- Sensor-Surface: 4mm (Mechanical Surface Detection)
- Phantom: Flat Phantom; Type: Elliptical Phantom
- Measurement SW: OpenSAR V4_02_01

Configuration/PCS1900 Mid-Touch- Right /Area Scan: Measurement grid: dx=8mm, dy=8mm
Configuration/PCS1900 Mid-Touch- Right /Zoom Scan: Measurement grid: dx=8mm,
dy=8mm, dz=5mm;

Area Scan	sam_direct_droit2_surf8mm.txt
ZoomScan	5x5x7,dx=8mm dy=8mm dz=5mm,Very fast
Phantom	Righthead
Device Position	Cheek
Band	PCS 1900
Channels	Right
Signal	TDMA (Crest factor: 8.0)

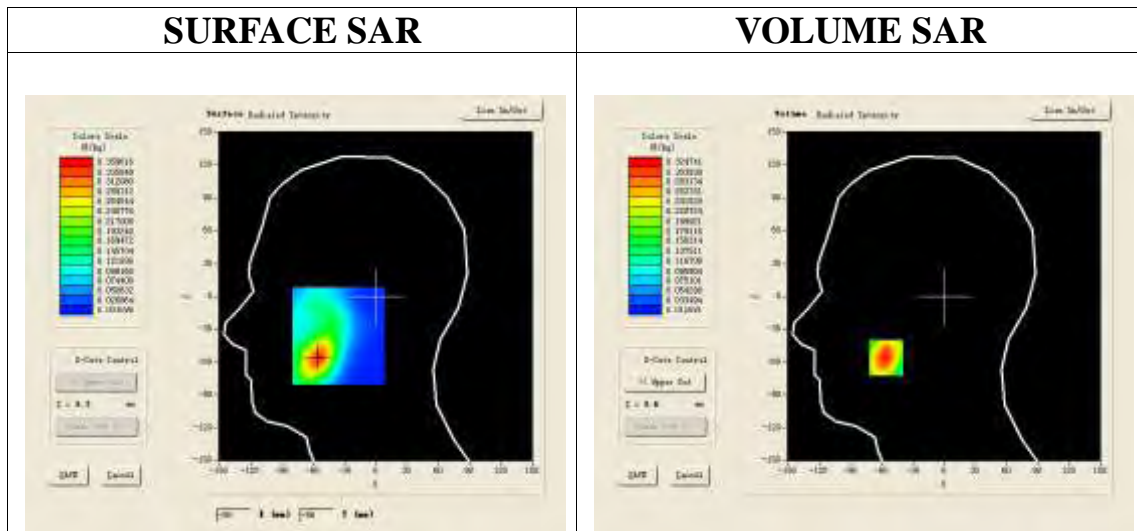

Maximum location: X=-56.00, Y=-56.00

SAR 10g (W/Kg)	0.181416
SAR 1g (W/Kg)	0.305339

Z (mm)	0.00	4.00	9.00	14.00	19.00
SAR (W/Kg)	0.0000	0.3247	0.2093	0.1332	0.0838

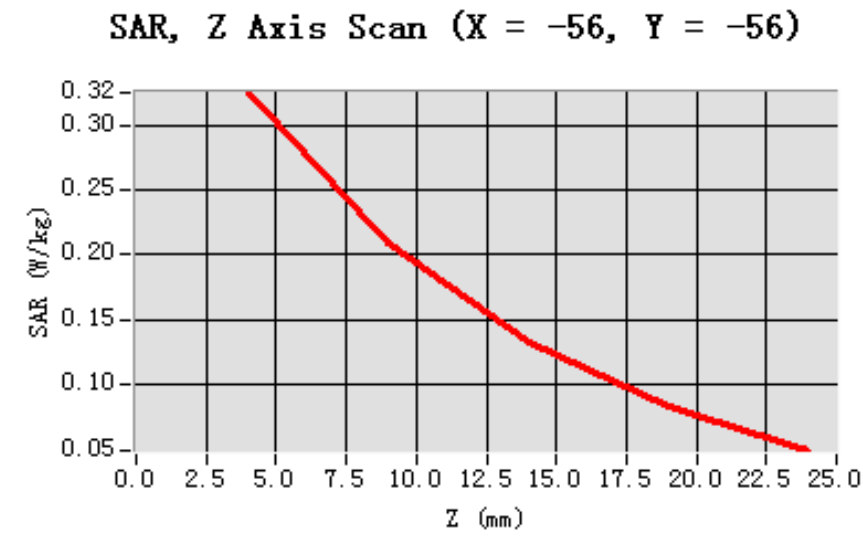

3D screen shot

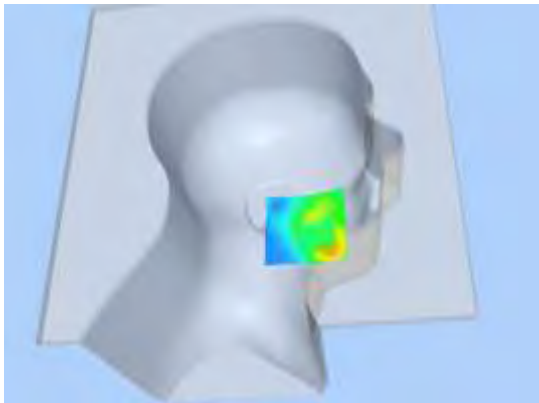

Hot spot position

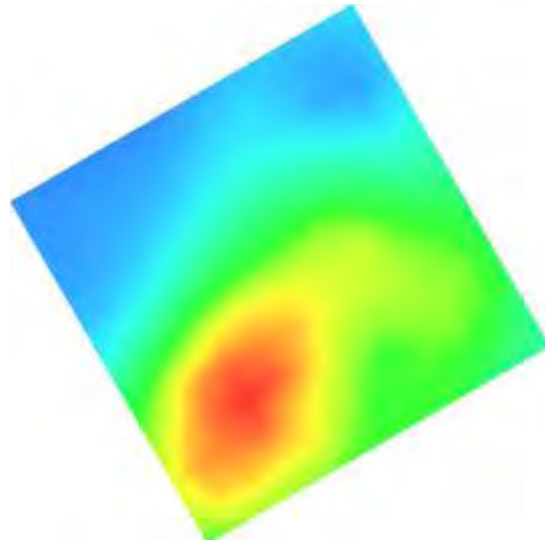

Test Laboratory: AGC Lab
PCS 1900 Mid-Body- Back <SIM 1>
DUT: Pilot PLUS; Type: Z550

Date: June 26,2014

Communication System: Generic GSM; Communication System Band: PCS 1900; Duty Cycle: 1:8.3; Conv.F=4.45;
Frequency: 1880 MHz; Medium parameters used: $f = 1900$ MHz; $\sigma = 1.49$ mho/m; $\epsilon_r = 53.92$; $\rho = 1000$ kg/m³ ;
Phantom section: Flat Section
Ambient temperature (°C): 21.0, Liquid temperature (°C): 21.0

SATIMO Configuration:

- Probe: SSE5; Calibrated: 01/12/2014; Serial No.:SN 22/12 EP159
- Sensor-Surface: 4mm (Mechanical Surface Detection)
- Phantom: Flat Phantom; Type: Elliptical Phantom
- Measurement SW: Open SAR V4_02_01

Configuration/PCS1900 Mid-Body-Back/Area Scan: Measurement grid: dx=8mm, dy=8mm

Configuration/PCS1900 Mid-Body-Back/Zoom Scan: Measurement grid: dx=8mm, dy=8mm, dz=5mm;

Area Scan	surf_sam_plan.txt
ZoomScan	5x5x7,dx=8mm dy=8mm dz=5mm,Very fast
Phantom	Validation plane
Device Position	Body Back
Band	PCS 1900
Channels	Middle
Signal	TDMA (Crest factor: 8.0)

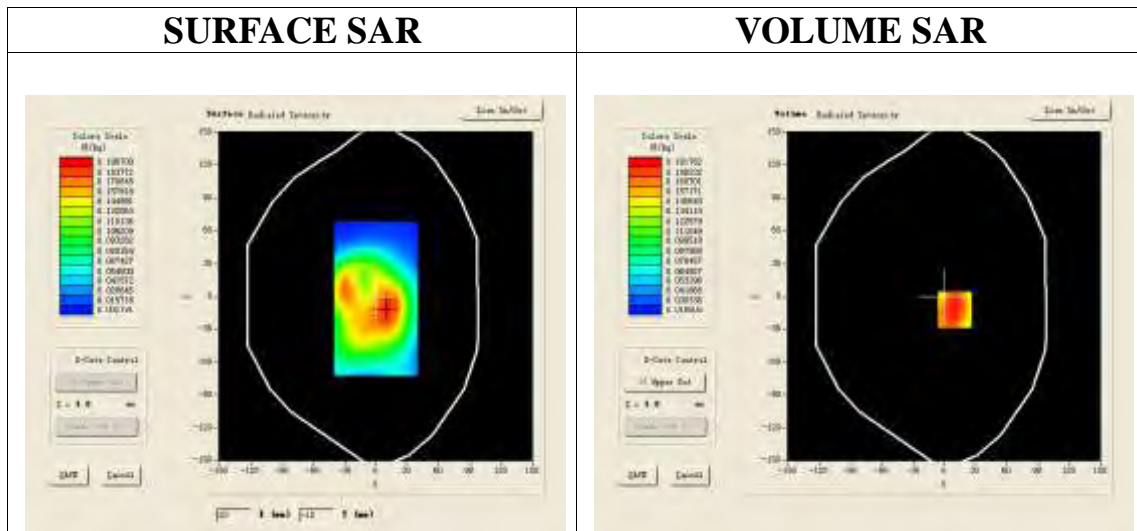

Maximum location: X=10.00, Y=-12.00

SAR 10g (W/Kg)	0.119460
SAR 1g (W/Kg)	0.188811

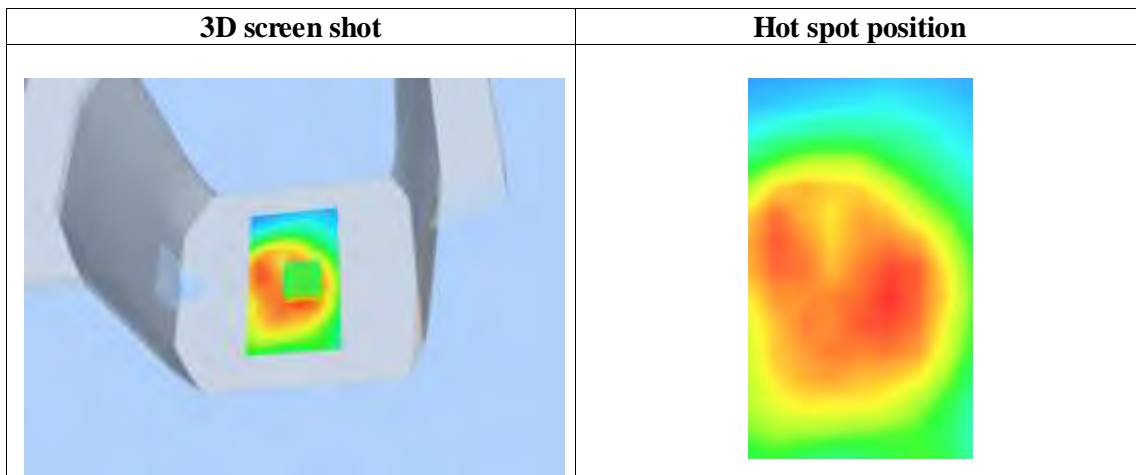
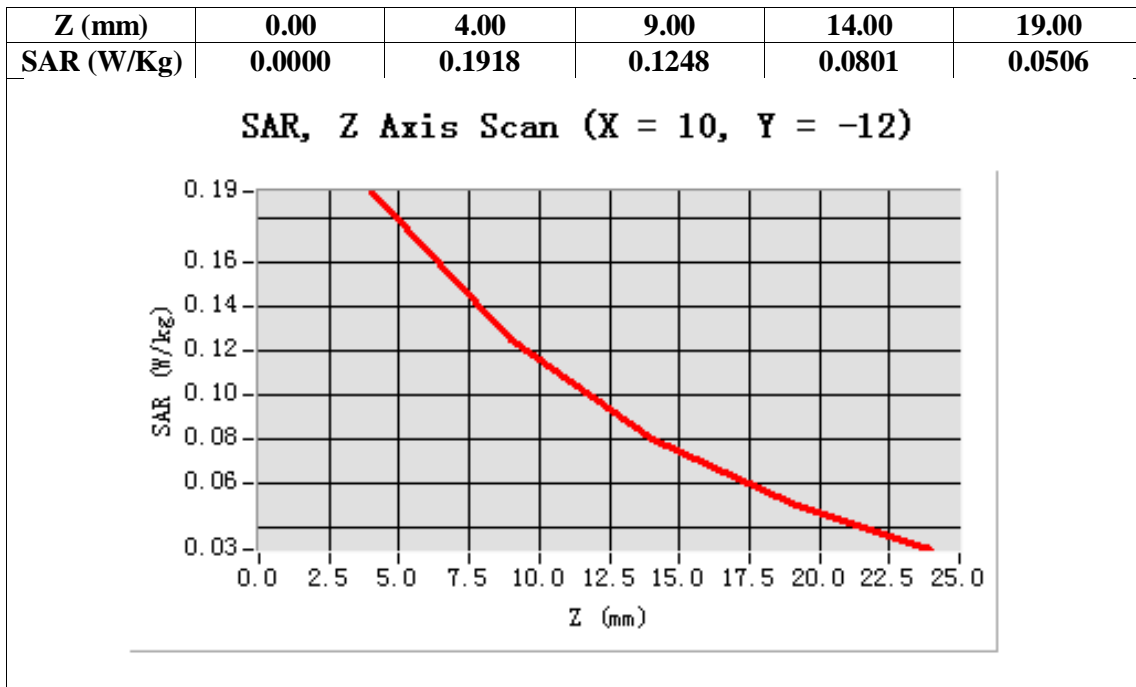

Test Laboratory: AGC Lab
PCS 1900 Mid-Body -Front (MS) <SIM 1>
DUT: Pilot PLUS; Type: Z550

Date: June 26,2014

Communication System: Generic GSM; Communication System Band: PCS 1900; Duty Cycle: 1:8.3; Conv.F=4.45;
Frequency: 1880 MHz; Medium parameters used: $f = 1900$ MHz; $\sigma = 1.49$ mho/m; $\epsilon_r = 53.92$; $\rho = 1000$ kg/m³ ;
Phantom section: Flat Section
Ambient temperature (°C): 21.0, Liquid temperature (°C): 21.0

SATIMO Configuration:

- Probe: SSE5; Calibrated: 01/12/2014; Serial No.:SN 22/12 EP159
- Sensor-Surface: 4mm (Mechanical Surface Detection)
- Phantom: Flat Phantom; Type: Elliptical Phantom
- Measurement SW: OpenSAR V4_02_01

Configuration/PCS1900 Mid-Body- Front /Area Scan: Measurement grid: dx=8mm, dy=8mm
Configuration/PCS1900 Mid-Body- Front /Zoom Scan: Measurement grid: dx=8mm, dy=8mm, dz=5mm;

Area Scan	surf_sam_plan.txt
ZoomScan	5x5x7,dx=8mm dy=8mm dz=5mm,Very fast
Phantom	Validation plane
Device Position	Body Front
Band	PCS 1900
Channels	Middle
Signal	TDMA (Crest factor: 8.0)

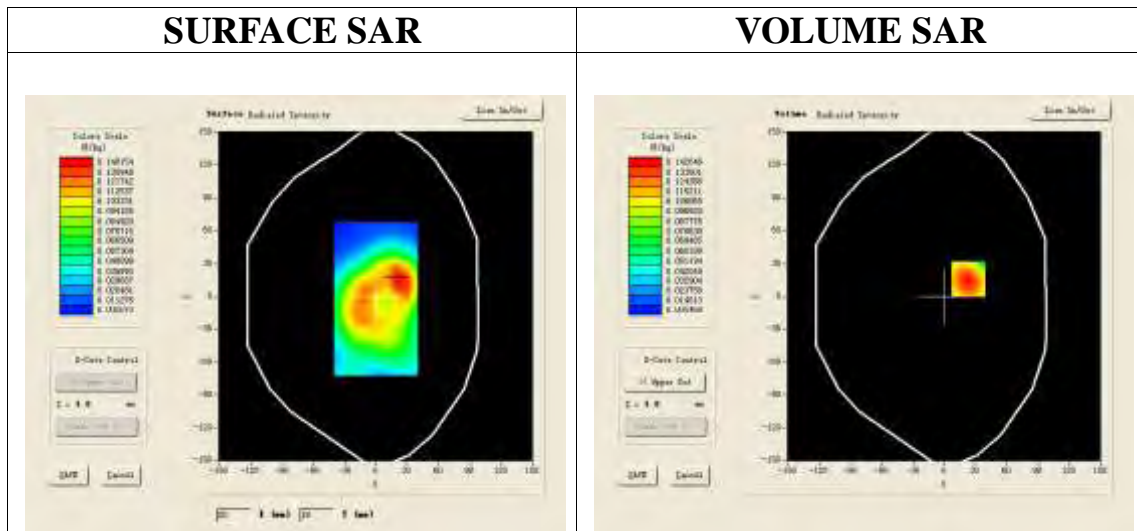

Maximum location: X=23.00, Y=16.00

SAR 10g (W/Kg)	0.079543
SAR 1g (W/Kg)	0.139938

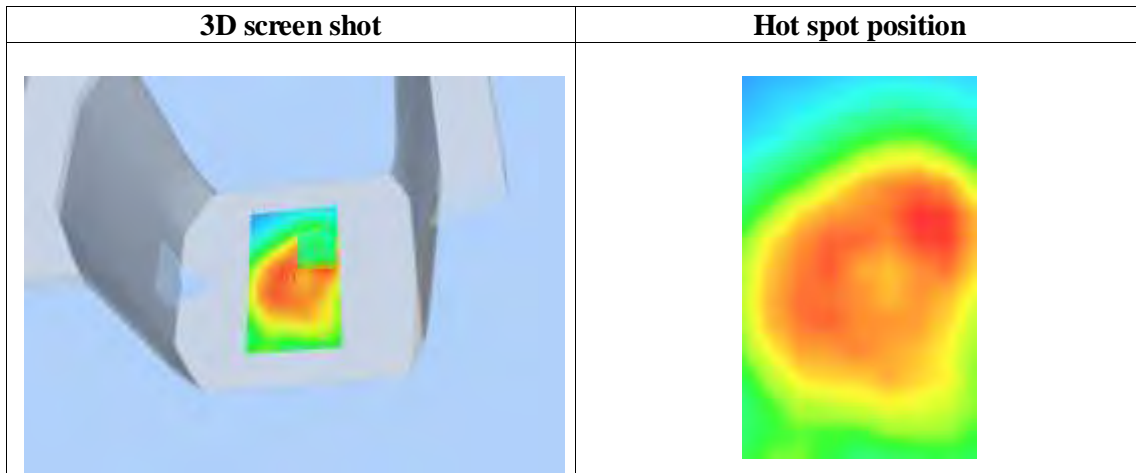
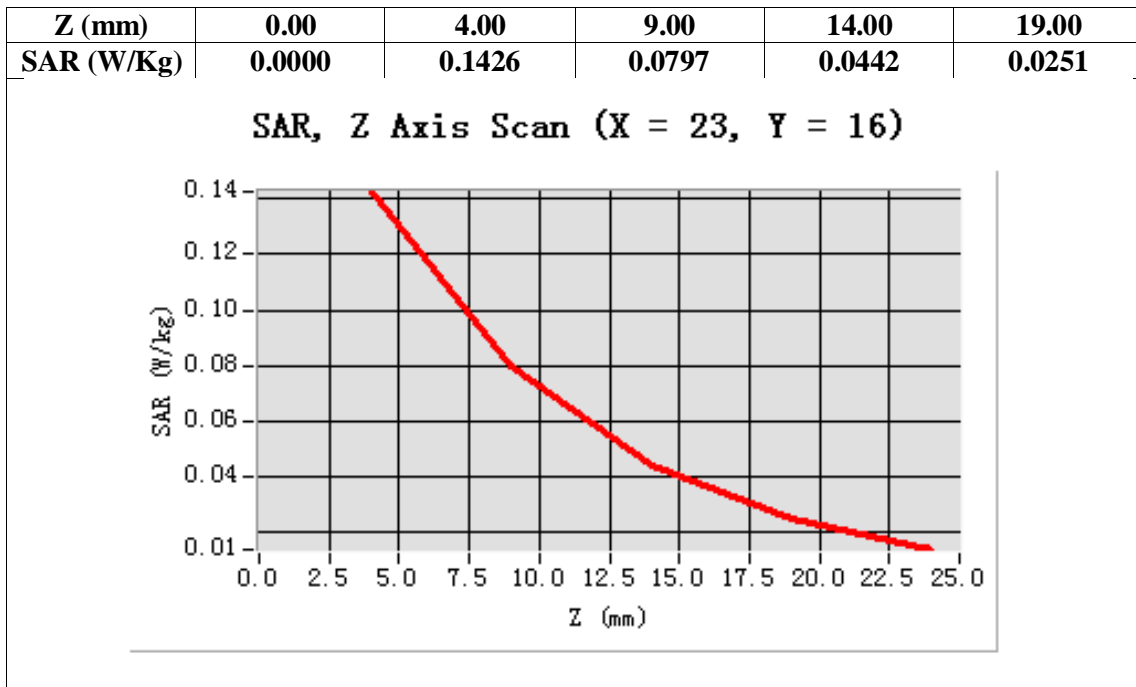

Test Laboratory: AGC Lab
WCDMA Band II Mid-Touch-Left (RMC)
DUT: Pilot PLUS; Type: Z550

Date: June 26,2014

Communication System: UMTS; Communication System Band: Band II UTRA/FDD ;Duty Cycle:1:1;Conv.F=4.51
Frequency: 1880 MHz; Medium parameters used: f = 1900 MHz; $\sigma = 1.42$ mho/m; $\epsilon_r = 40.19$; $\rho = 1000$ kg/m³ ;
Phantom section: Left Section
Ambient temperature (°C):21, Liquid temperature (°C):21

SATIMO Configuration:

- Probe: SSE5; Calibrated: 01/12/2014; Serial No.:SN 22/12 EP159
- Sensor-Surface: 4mm (Mechanical Surface Detection)
- Phantom: Flat Phantom; Type: Elliptical Phantom
- Measurement SW: OpenSAR V4_02_01

Configuration/ WCDMA Band II Mid-Touch-Left/Area Scan: Measurement grid: dx=8mm, dy=8mm
Configuration/ WCDMA Band II Mid-Touch-Left/Zoom Scan: Measurement grid:
dx=8mm,dy=8mm,dz=5mm;

Area Scan	sam_direct_droit2_surf8mm.txt
ZoomScan	5x5x7,dx=8mm dy=8mm dz=5mm,Very fast
Phantom	Left head
Device Position	Cheek
Band	WCDMA Band II
Channels	Middle
Signal	TDMA (Crest factor: 1.0)

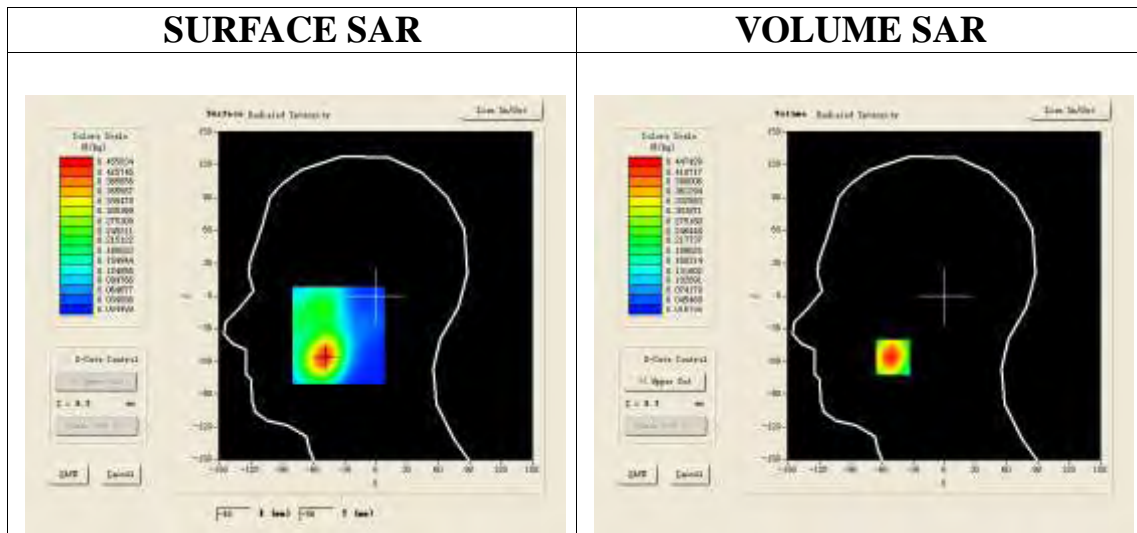

Maximum location: X=-49.00, Y=-56.00

SAR 10g (W/Kg)	0.244035
SAR 1g (W/Kg)	0.421344

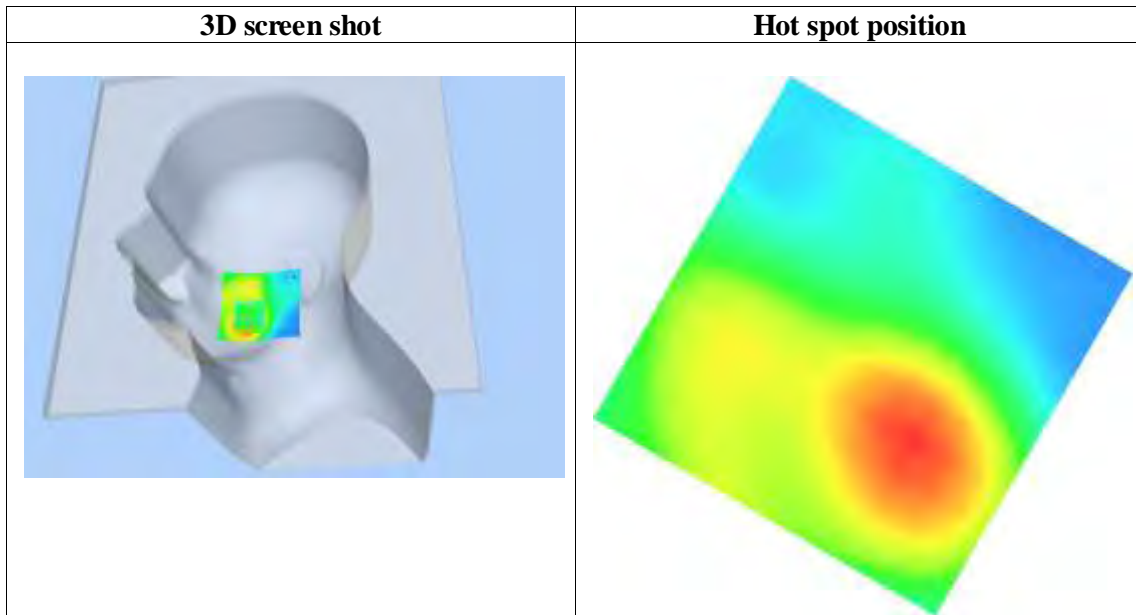
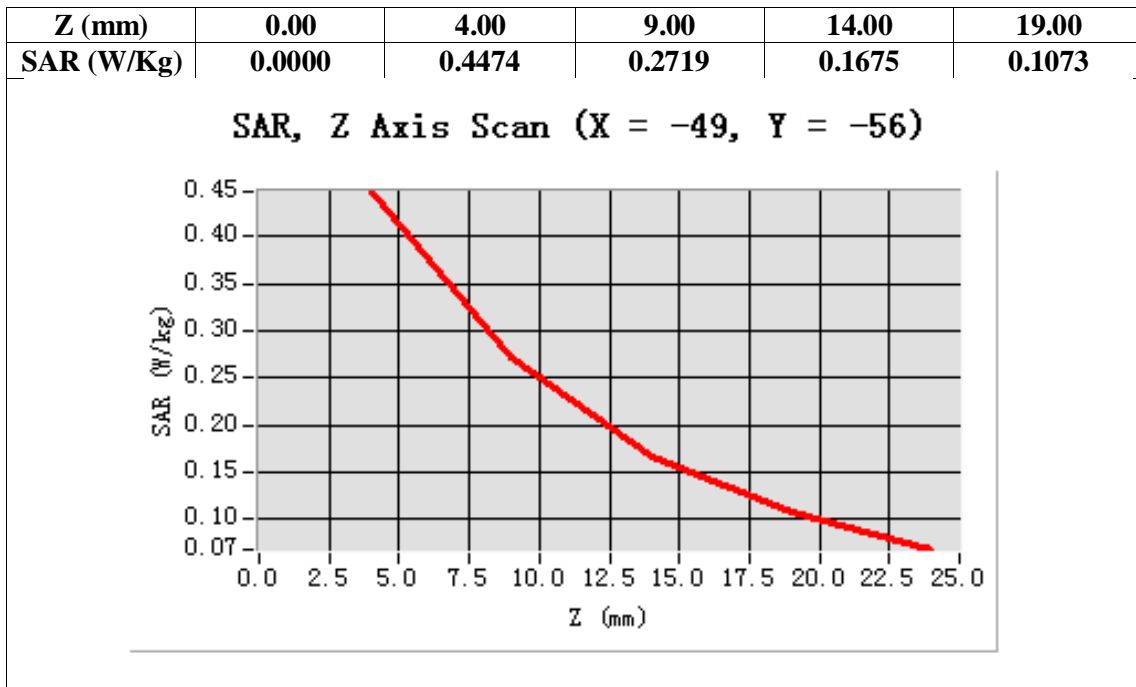

Test Laboratory: AGC Lab
WCDMA Band II Mid-Tilt-Left (RMC)
DUT: Pilot PLUS; Type: Z550

Date: June 26,2014

Communication System: UMTS; Communication System Band: Band II UTRA/FDD ;Duty Cycle:1:1; Conv.F=4.51
Frequency: 1880 MHz; Medium parameters used: f = 1900 MHz; σ = 1.42 mho/m; ϵ_r =40.19; ρ = 1000 kg/m³ ;
Phantom section: Left Section
Ambient temperature (°C):21, Liquid temperature (°C):21

SATIMO Configuration:

- Probe: SSE5; Calibrated: 01/12/2014; Serial No.:SN 22/12 EP159
- Sensor-Surface: 4mm (Mechanical Surface Detection)
- Phantom: Flat Phantom; Type: Elliptical Phantom
- Measurement SW: OpenSAR V4_02_01

Configuration/ WCDMA Band II Mid-Tilt-Left/Area Scan: Measurement grid: dx=8mm, dy=8mm
Configuration/ WCDMA Band II Mid-Tilt-Left/Zoom Scan: Measurement grid: dx=8mm, dy=8mm, dz=5mm;

Area Scan	sam_direct_droit2_surf8mm.txt
ZoomScan	5x5x7,dx=8mm dy=8mm dz=5mm,Very fast
Phantom	Left head
Device Position	Tilt
Band	WCDMA Band II
Channels	Middle
Signal	TDMA (Crest factor: 1.0)

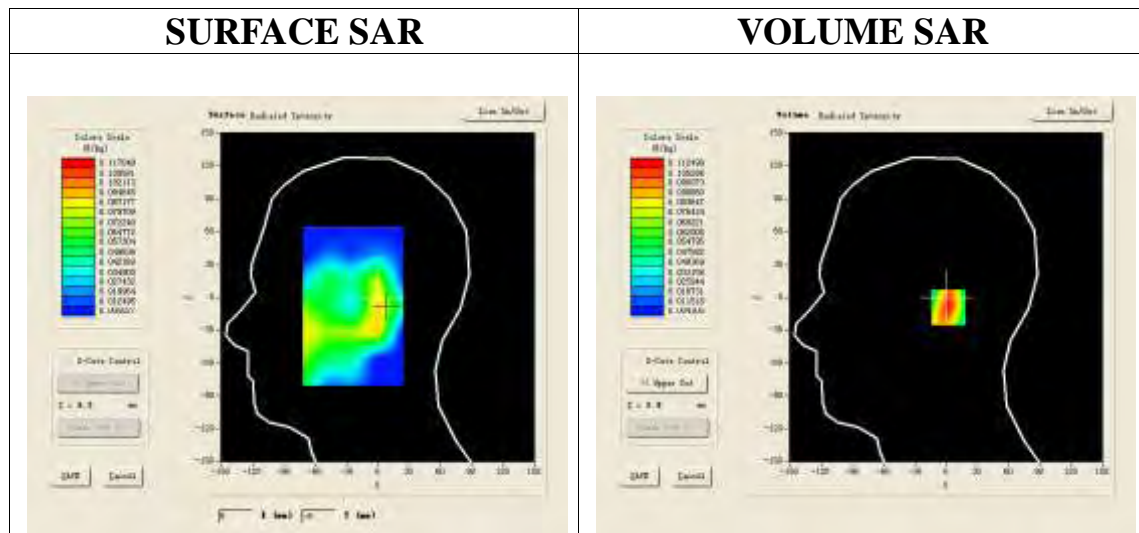

Maximum location: X=8.00, Y=-9.00

SAR 10g (W/Kg)	0.061945
SAR 1g (W/Kg)	0.105817

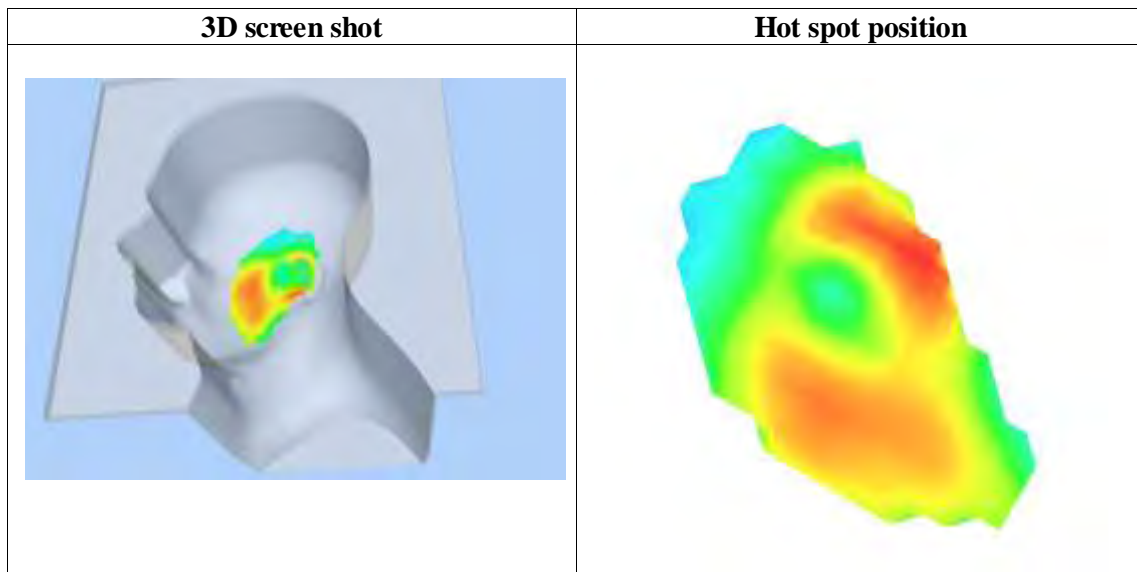
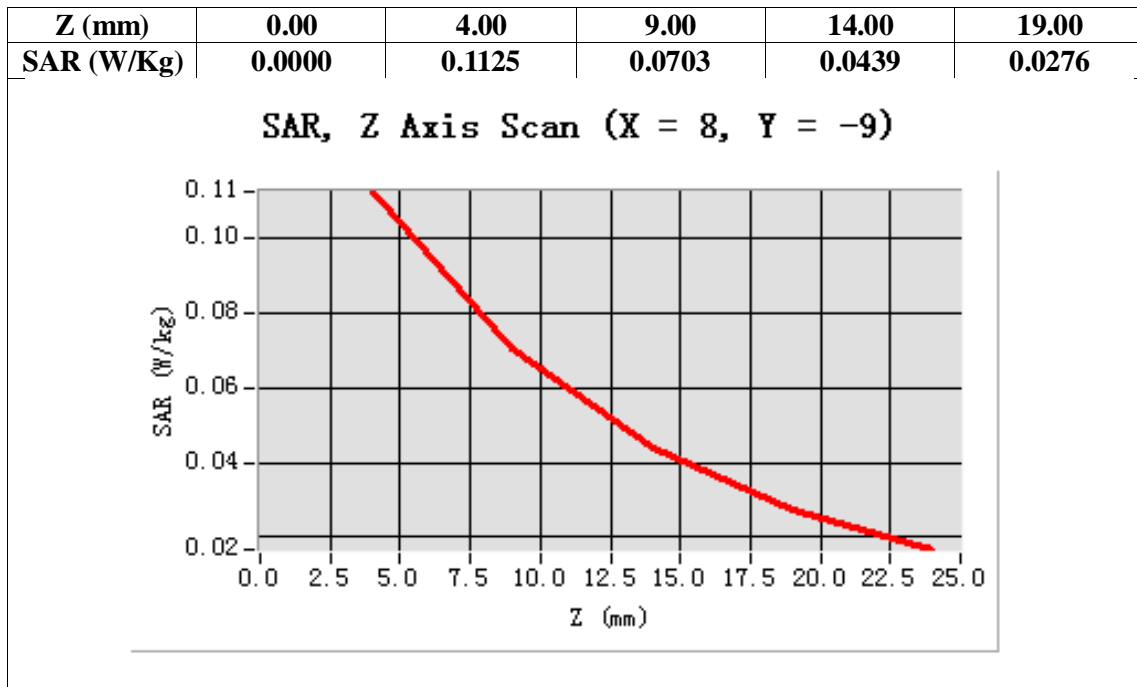

Test Laboratory: AGC Lab
WCDMA Band II Mid-Touch-Right (RMC)
DUT: Pilot PLUS; Type: Z550

Date: June 26,2014

Communication System: UMTS; Communication System Band: Band II UTRA/FDD ;Duty Cycle:1:1; Conv.F=4.51
Frequency: 1880 MHz; Medium parameters used: $f = 1900$ MHz; $\sigma = 1.42$ mho/m; $\epsilon_r = 40.19$; $\rho = 1000$ kg/m³ ;
Phantom section: Right Section
Ambient temperature (°C):21, Liquid temperature (°C):21

SATIMO Configuration:

- Probe: SSE5; Calibrated: 01/12/2014; Serial No.:SN 22/12 EP159
- Sensor-Surface: 4mm (Mechanical Surface Detection)
- Phantom: Flat Phantom; Type: Elliptical Phantom
- Measurement SW: OpenSAR V4_02_01

Configuration/ WCDMA band II Mid-Touch-Right/Area Scan: Measurement grid: dx=8mm, dy=8mm
Configuration/ WCDMA band II Mid-Touch-Right/Zoom Scan: Measurement grid: dx=8mm, dy=8mm, dz=5mm;

Area Scan	sam_direct_droit2_surf8mm.txt
ZoomScan	5x5x7,dx=8mm dy=8mm dz=5mm,Very fast
Phantom	Right head
Device Position	Cheek
Band	WCDMA band II
Channels	Middle
Signal	TDMA (Crest factor: 1.0)

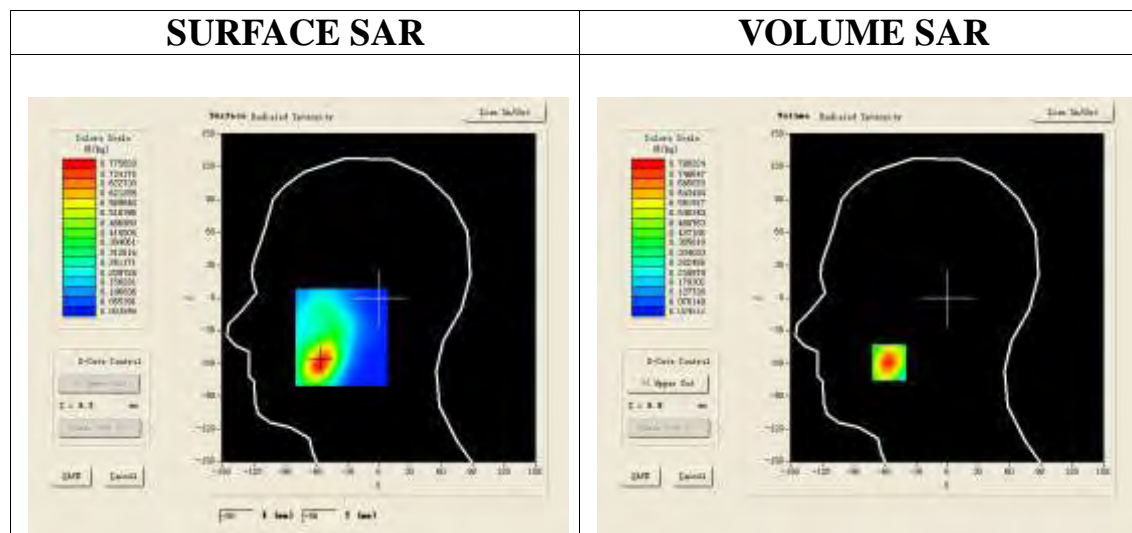

Maximum location: X=-56.00, Y=-59.00

SAR 10g (W/Kg)	0.422567
SAR 1g (W/Kg)	0.745070

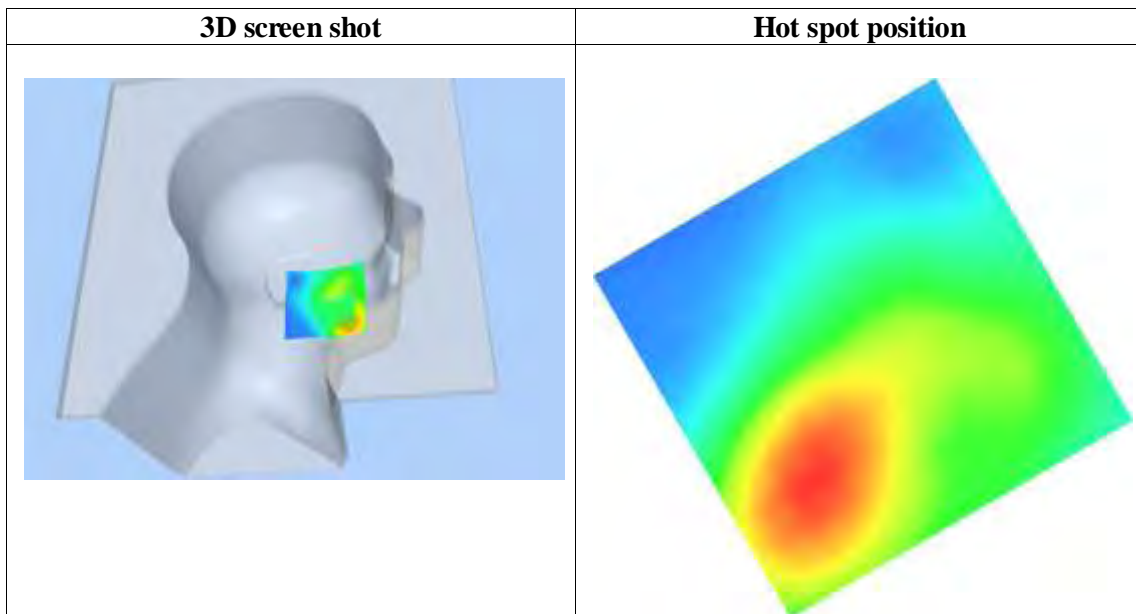
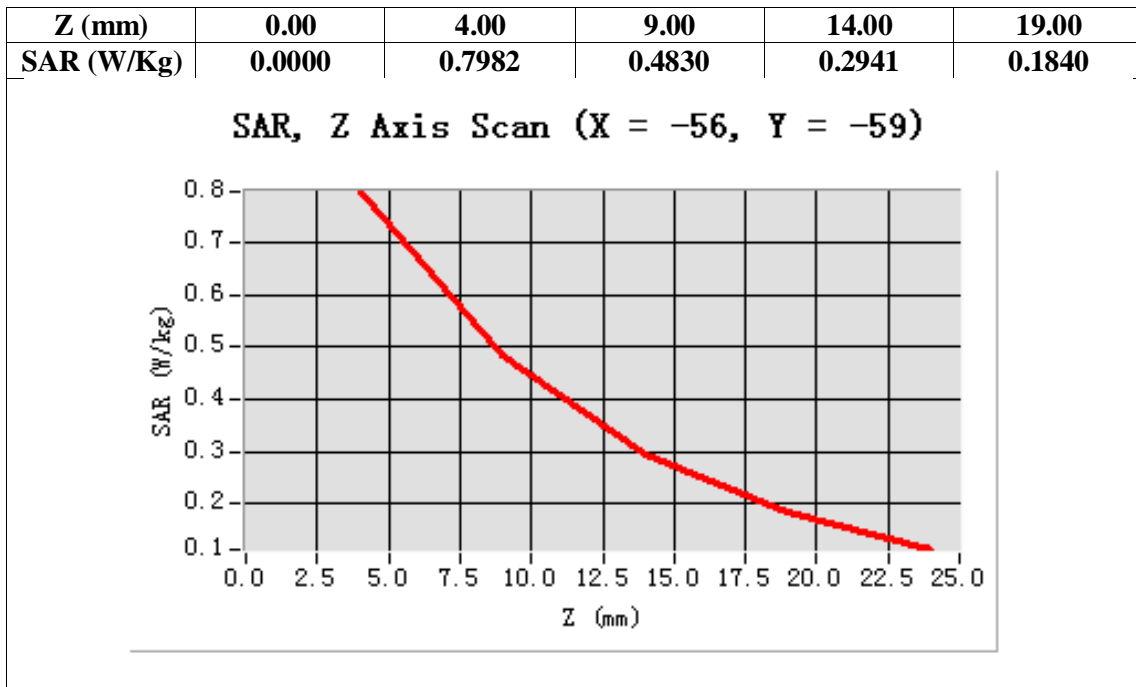

Test Laboratory: AGC Lab
WCDMA Band II Mid-Tilt-Right <RMC>
DUT: Pilot PLUS; Type: Z550

Date: June 26,2014

Communication System: UMTS; Communication System Band: Band II UTRA/FDD ;Duty Cycle:1:1; Conv.F=4.51
Frequency: 1880 MHz; Medium parameters used: f = 1900 MHz; σ = 1.42 mho/m; ϵ_r =40.19; ρ = 1000 kg/m³ ;
Phantom section: Right Section
Ambient temperature (°C):21, Liquid temperature (°C):21

SATIMO Configuration:

- Probe: SSE5; Calibrated: 01/12/2014; Serial No.:SN 22/12 EP159
- Sensor-Surface: 4mm (Mechanical Surface Detection)
- Phantom: Flat Phantom; Type: Elliptical Phantom
- Measurement SW: Open SAR V4_02_01

Configuration/PCS1900 Mid-Tilt-Right/Area Scan: Measurement grid: dx=8mm, dy=8mm
Configuration/PCS1900 Mid-Tilt-Right/Zoom Scan: Measurement grid: dx=8mm, dy=8mm, dz=5mm;

Area Scan	sam_direct_droit2_surf8mm.txt
ZoomScan	5x5x7,dx=8mm dy=8mm dz=5mm,Very fast
Phantom	Right head
Device Position	Tilt
Band	WCDMA band II
Channels	Middle
Signal	TDMA (Crest factor: 1.0)

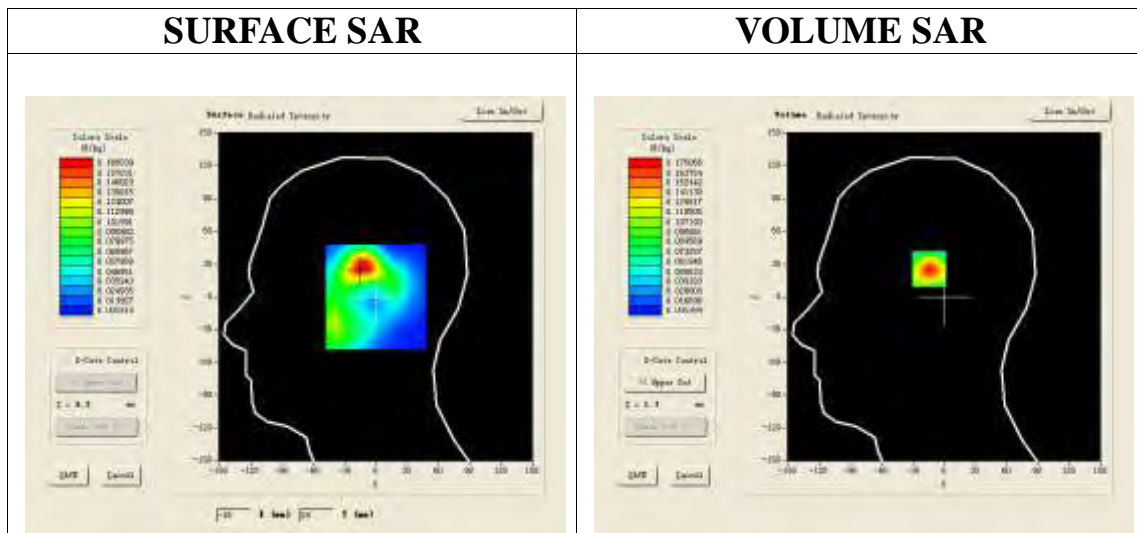

Maximum location: X=-13.00, Y=28.00

SAR 10g (W/Kg)	0.092825
SAR 1g (W/Kg)	0.163243

Z (mm)	0.00	4.00	9.00	14.00	19.00
SAR (W/Kg)	0.0000	0.1751	0.1094	0.0685	0.0435

SAR, Z Axis Scan (X = -13, Y = 28)

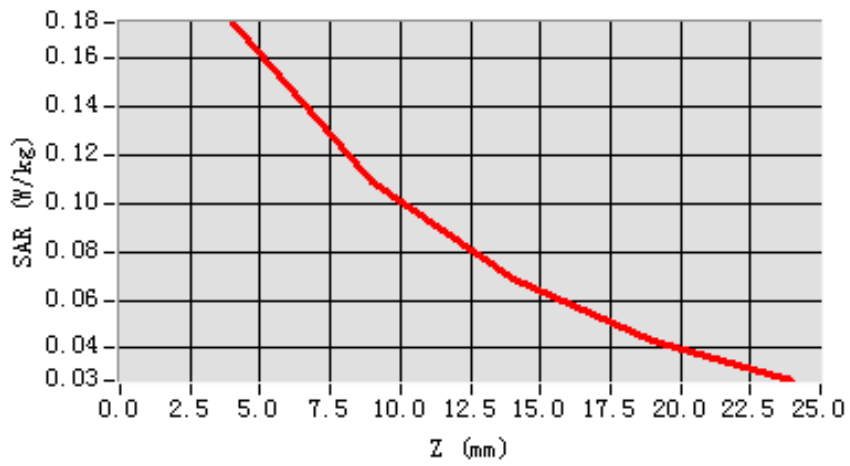

3D screen shot

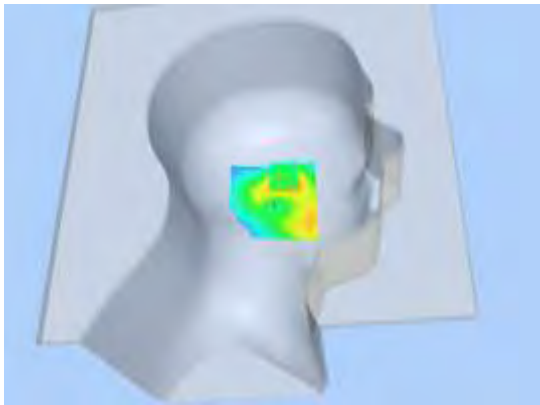

Hot spot position

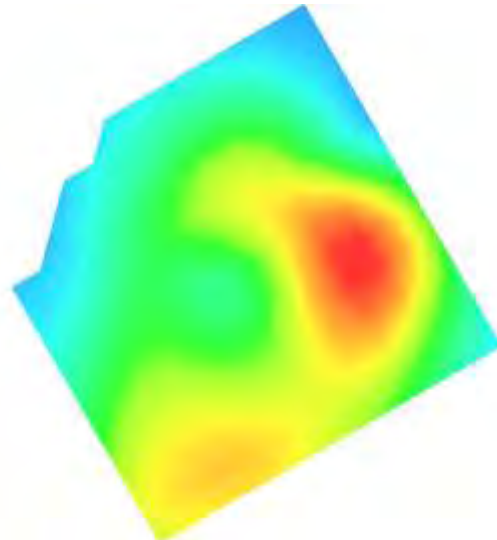

Test Laboratory: AGC Lab
WCDMA Band II Mid-Body-Towards Grounds (RMC 12.2kbps)
DUT: Pilot PLUS; Type: Z550

Date: June 26,2014

Communication System: UMTS; Communication System Band: Band II UTRA/FDD ;Duty Cycle:1:1; Conv.F=4.45
Frequency: 1880 MHz; Medium parameters used: f = 1900 MHz; $\sigma=1.49$ mho/m; $\epsilon_r=53.92$; $\rho=1000$ kg/m³ ;
Phantom section: Flat Section
Ambient temperature (°C):21, Liquid temperature (°C):21

SATIMO Configuration:

- Probe: SSE5; Calibrated: 01/12/2014; Serial No.:SN 22/12 EP159
- Sensor-Surface: 4mm (Mechanical Surface Detection)
- Phantom: Flat Phantom; Type: Elliptical Phantom
- Measurement SW: OpenSAR V4_02_01

Configuration/ WCDMA band II Mid-Body-back/Area Scan: Measurement grid: dx=8mm, dy=8mm
Configuration/ WCDMA band II Mid-Body-back/Zoom Scan: Measurement grid: dx=8mm, dy=8mm, dz=5mm;

Area Scan	surf_sam_plan.txt
ZoomScan	5x5x7,dx=8mm dy=8mm dz=5mm,Very fast
Phantom	Validation plane
Device Position	Body Back
Band	WCDMA band II
Channels	Middle
Signal	TDMA (Crest factor: 1.0)

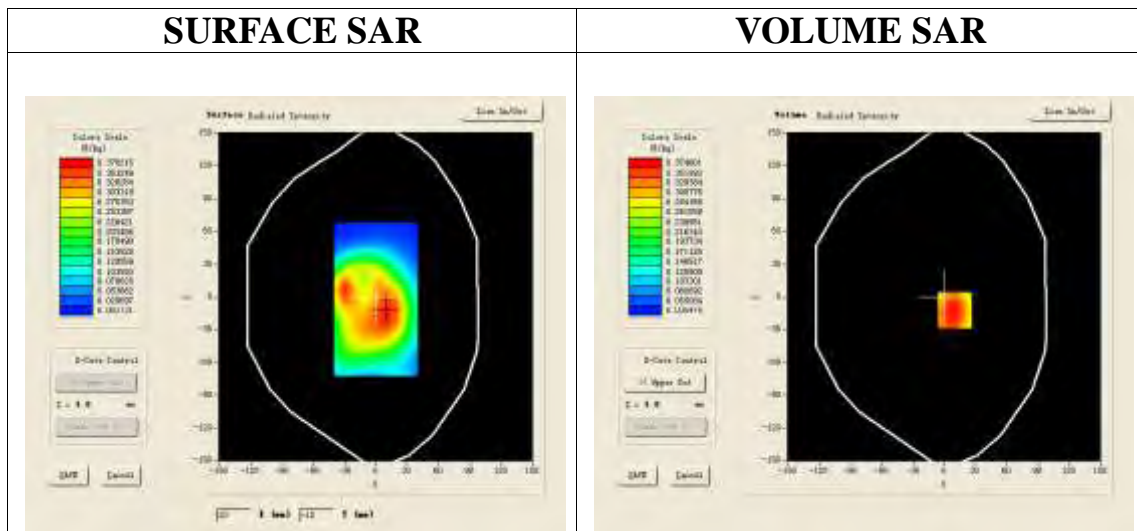

Maximum location: X=10.00, Y=-12.00

SAR 10g (W/Kg)	0.224433
SAR 1g (W/Kg)	0.357889

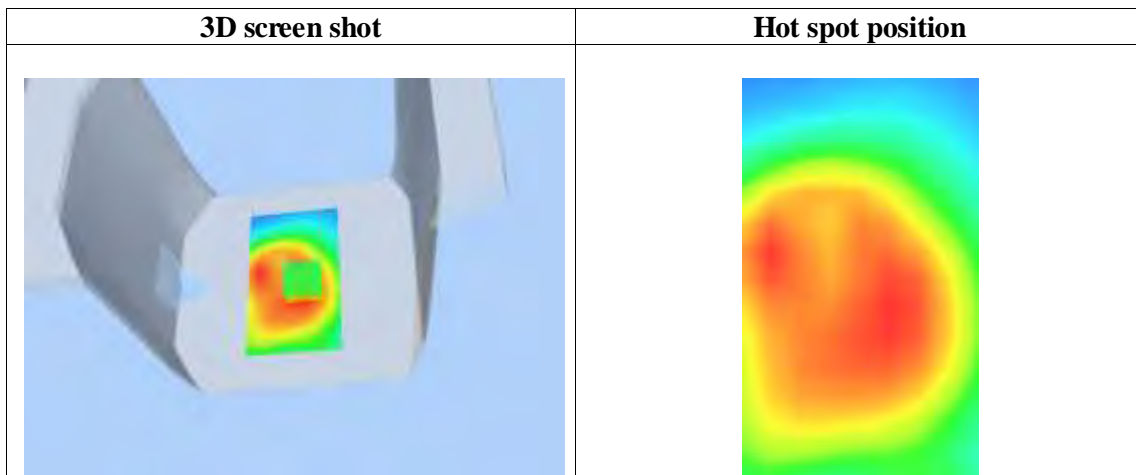
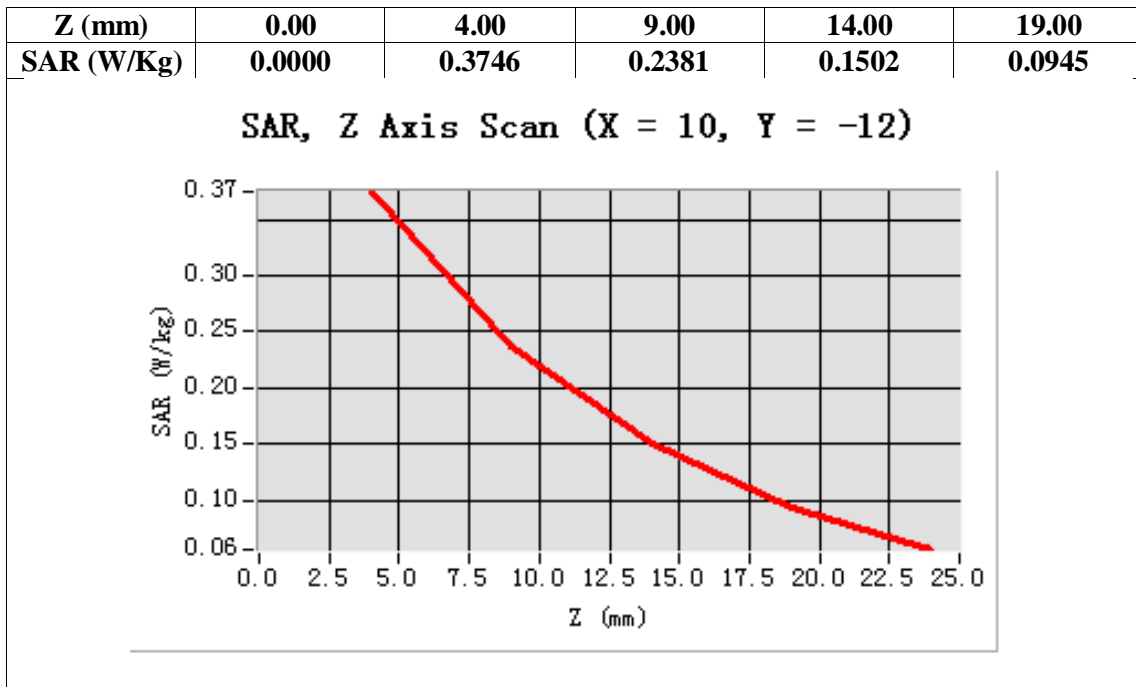

Test Laboratory: AGC Lab
WCDMA Band II Mid-Body-Towards Phantom (RMC 12.2kbps)
DUT: Pilot PLUS; Type: Z550

Date: June 26,2014

Communication System: UMTS; Communication System Band: Band II UTRA/FDD ;Duty Cycle:1:1; Conv.F=4.45
Frequency: 1880 MHz; Medium parameters used: $f = 1900$ MHz; $\sigma=1.49$ mho/m; $\epsilon_r =53.92$; $\rho= 1000$ kg/m³ ;
Phantom section: Flat Section
Ambient temperature (°C):21, Liquid temperature (°C):21

SATIMO Configuration:

- Probe: SSE5; Calibrated: 01/12/2014; Serial No.:SN 22/12 EP159
- Sensor-Surface: 4mm (Mechanical Surface Detection)
- Phantom: Flat Phantom; Type: Elliptical Phantom
- Measurement SW: Open SAR V4_02_01

Configuration/ WCDMA band II Mid-Body-Front/Area Scan: Measurement grid: dx=8mm, dy=8mm
Configuration/ WCDMA band II Mid-Body-Front/Zoom Scan: Measurement grid: dx=8mm, dy=8mm, dz=5mm;

Area Scan	surf_sam_plan.txt
ZoomScan	5x5x7,dx=8mm dy=8mm dz=5mm,Very fast
Phantom	Validation plane
Device Position	Body Front
Band	WCDMA band II
Channels	Middle
Signal	TDMA (Crest factor: 1.0)

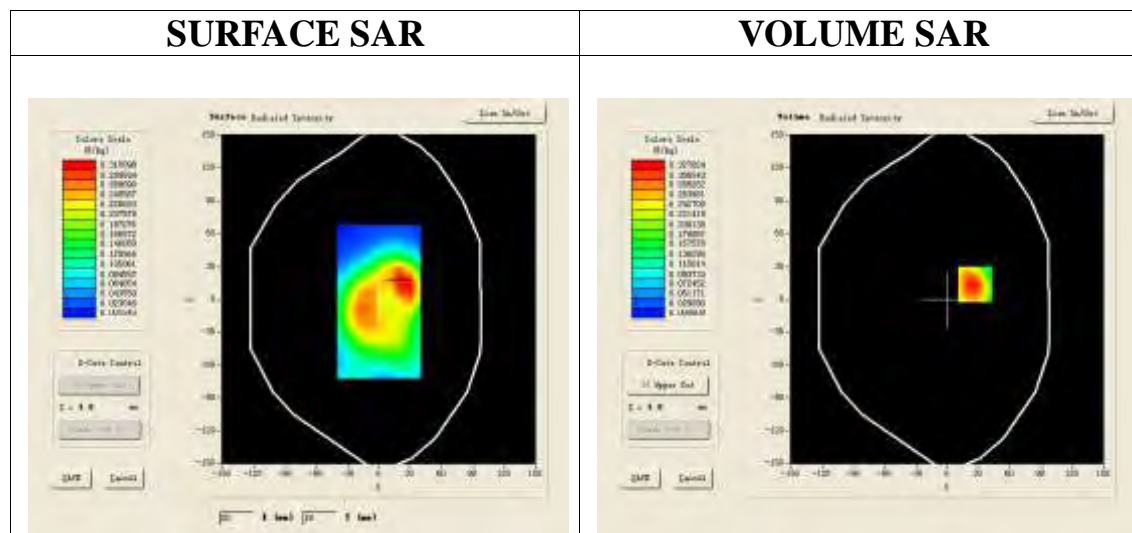

Maximum location: X=27.00, Y=14.00

SAR 10g (W/Kg)	0.171185
SAR 1g (W/Kg)	0.312884

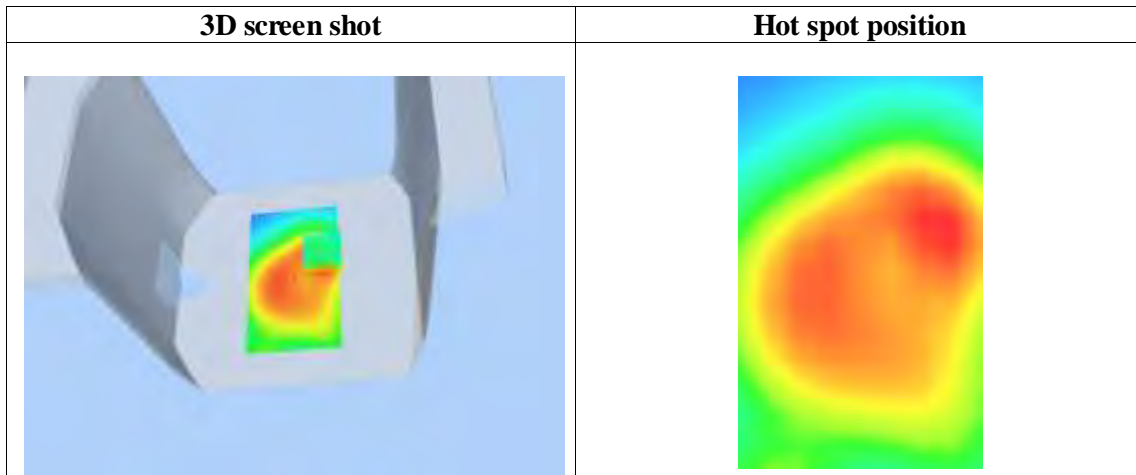
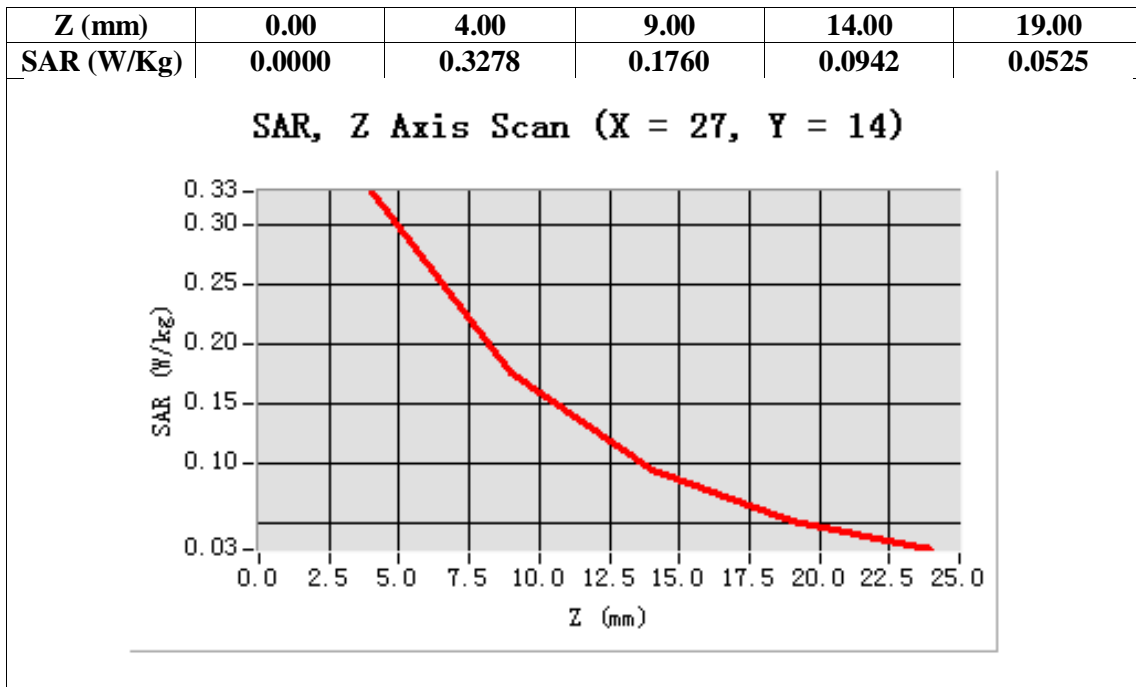

Test Laboratory: AGC Lab

Date: June 26,2014

WCDMA Band V Mid-Touch-Left (RMC)

DUT: Pilot PLUS; Type: Z550

Communication System: UMTS; Communication System Band: BAND V UTRA/FDD ; Duty Cycle:1: 1; Conv.F=5.27
Frequency: 835 MHz; Medium parameters used: f = 836.6 MHz; $\sigma=0.90$ mho/m; $\epsilon_r=41.94$; $\rho= 1000$ kg/m³ ;
Phantom section: Left Section
Ambient temperature (°C): 21, Liquid temperature (°C): 21

SATIMO Configuration:

- Probe: SSE5; Calibrated: 01/12/2014; Serial No.:SN 22/12 EP159
- Sensor-Surface: 4mm (Mechanical Surface Detection)
- Phantom: Flat Phantom; Type: Elliptical Phantom
- Measurement SW: Open SAR V4_02_01

Configuration/ WCDMA Band V Mid-Touch-Left/Area Scan (6x8x1): Measurement grid: dx=8mm, dy=8mm
Configuration/ WCDMA Band V Mid-Touch-Left/Zoom Scan (5x5x7)/Cube 0: Measurement grid: dx=8mm, dy=8mm, dz=5mm

Area Scan	sam_direct_droit2_surf8mm.txt
ZoomScan	5x5x7,dx=8mm dy=8mm dz=5mm,Very fast
Phantom	Left head
Device Position	Cheek
Band	WCDMA Band V
Channels	Middle
Signal	TDMA (Crest factor: 1.0)

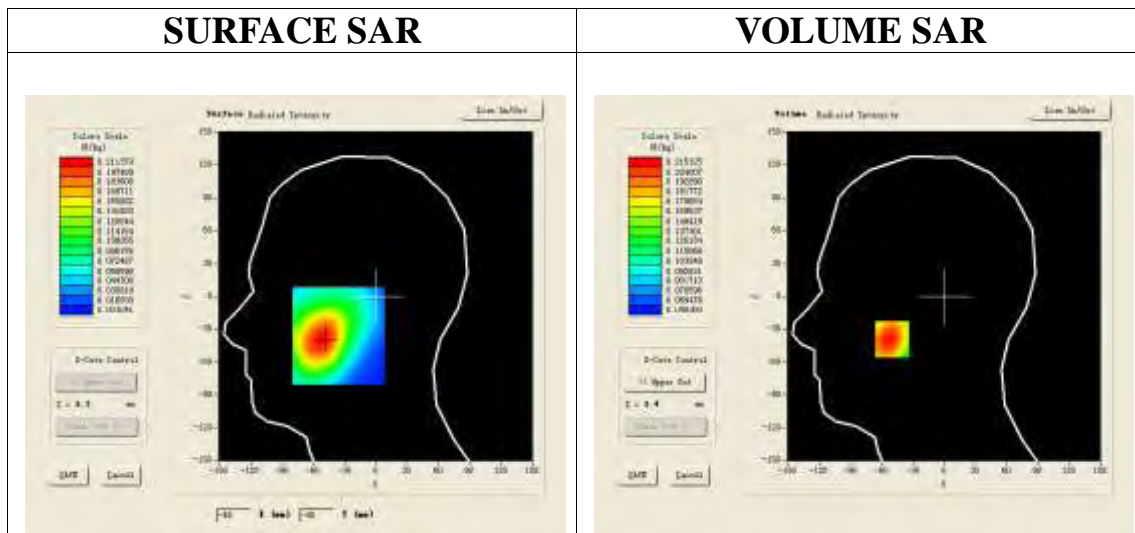

Maximum location: X=-50.00, Y=-39.00

SAR 10g (W/Kg)	0.158251
SAR 1g (W/Kg)	0.208828

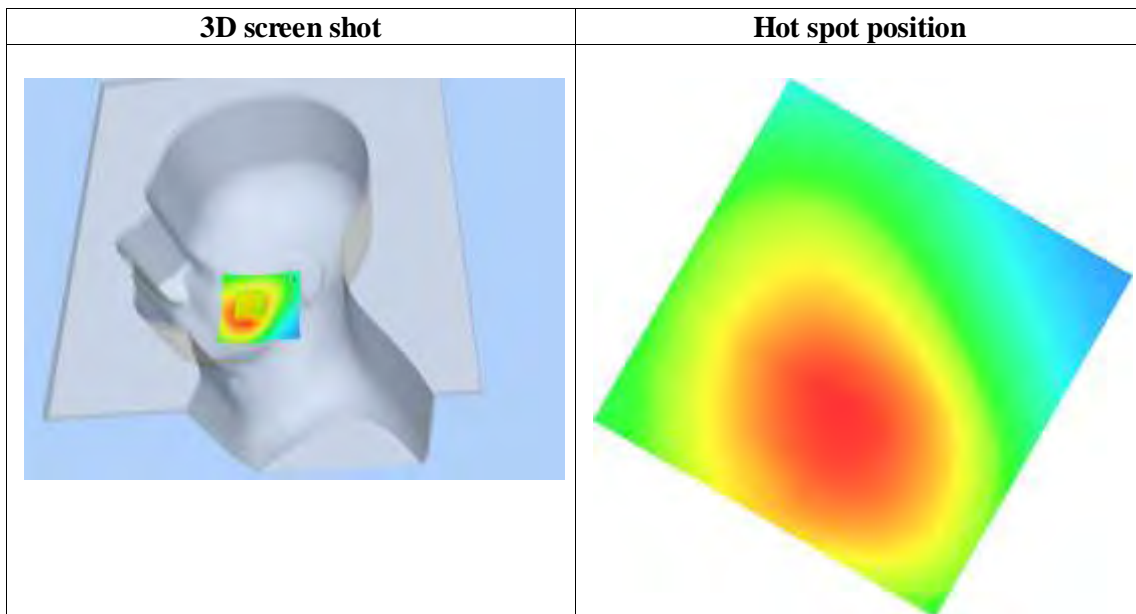
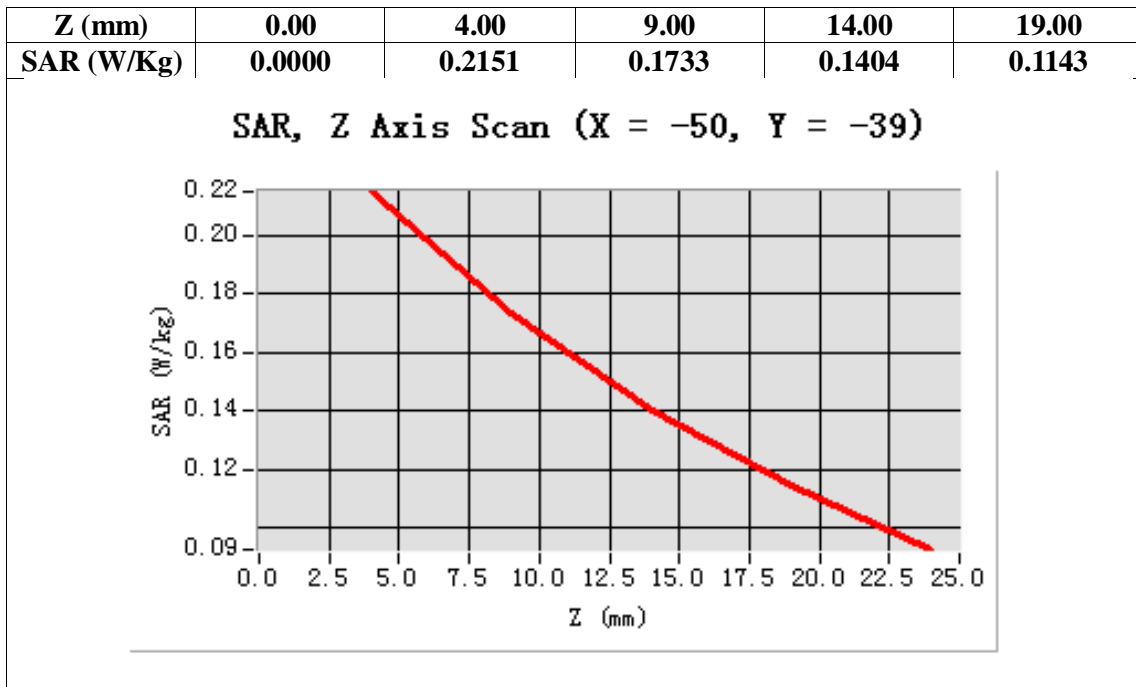

Test Laboratory: AGC Lab

Date: June 26,2014

WCDMA Band V Mid-Tilt-Left (RMC)

DUT: Pilot PLUS; Type: Z550

Communication System: UMTS; Communication System Band: BAND V UTRA/FDD ; Duty Cycle:1: 1; Conv.F=5.27
Frequency: 835 MHz; Medium parameters used: $f = 836.6\text{MHz}$; $\sigma=0.90\text{ mho/m}$; $\epsilon_r = 41.94$; $\rho= 1000\text{ kg/m}^3$;
Phantom section: Left Section
Ambient temperature ($^{\circ}\text{C}$): 21, Liquid temperature ($^{\circ}\text{C}$): 21

SATIMO Configuration:

- Probe: SSE5; Calibrated: 01/12/2014; Serial No.:SN 22/12 EP159
- Sensor-Surface: 4mm (Mechanical Surface Detection)
- Phantom: Flat Phantom; Type: Elliptical Phantom
- Measurement SW: OpenSAR V4_02_01

Configuration/ WCDMA Band V Mid-Tilt-Left/Area Scan (6x8x1): Measurement grid: $dx=8\text{mm}$, $dy=8\text{mm}$
Configuration/ WCDMA Band V Mid-Tilt-Left/Zoom Scan (5x5x7)/Cube 0: Measurement grid: $dx=8\text{mm}$,
 $dy=8\text{mm}$, $dz=5\text{mm}$;

Area Scan	sam_direct_droit2_surf8mm.txt
ZoomScan	5x5x7,dx=8mm dy=8mm dz=5mm,Very fast
Phantom	Left head
Device Position	Tilt
Band	WCDMA Band V
Channels	Middle
Signal	TDMA (Crest factor: 1.0)

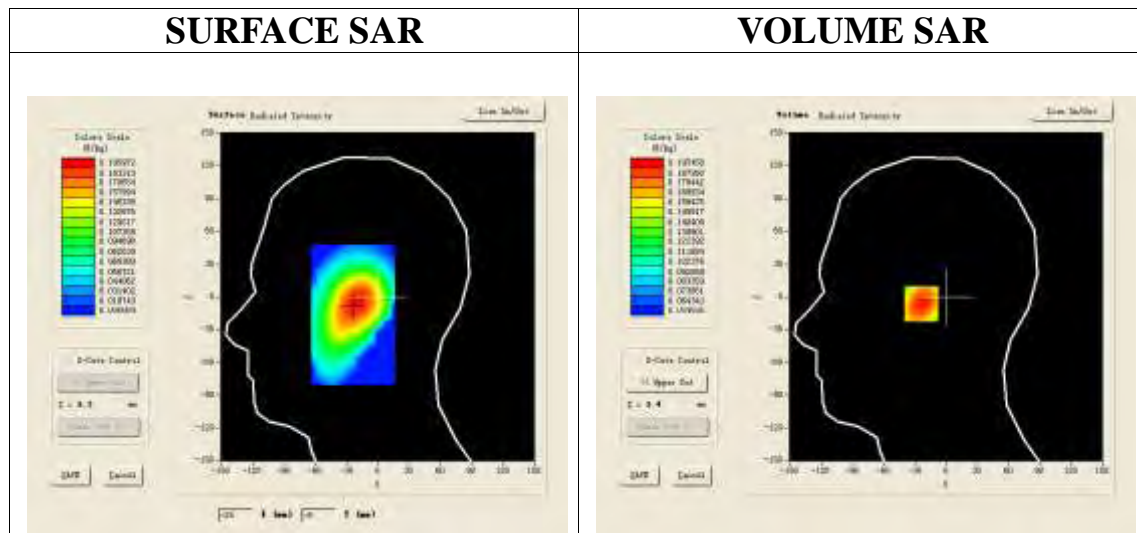

Maximum location: X=-21.00, Y=-6.00

SAR 10g (W/Kg)	0.144452
SAR 1g (W/Kg)	0.190497

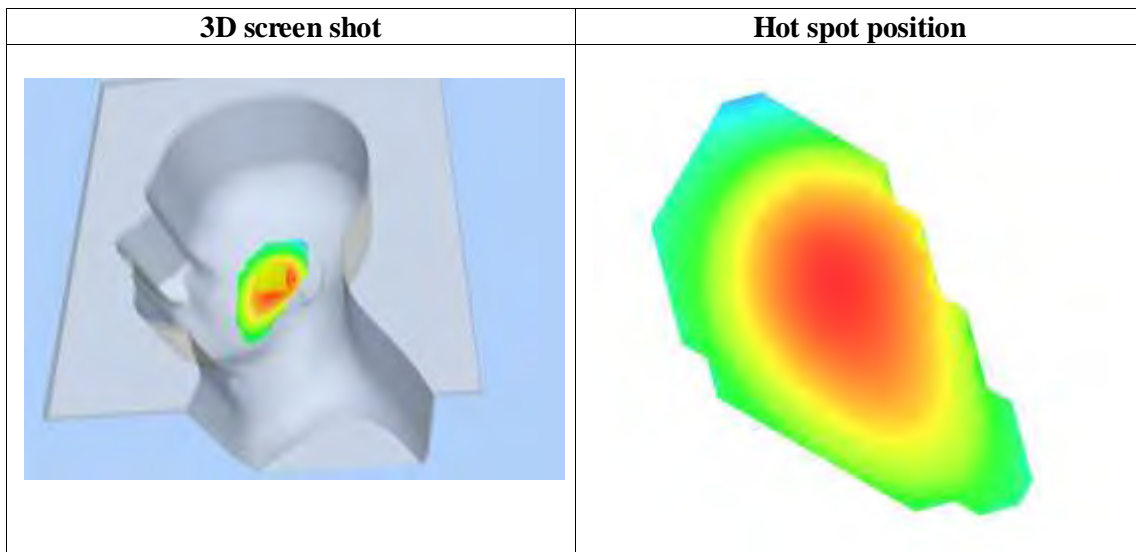
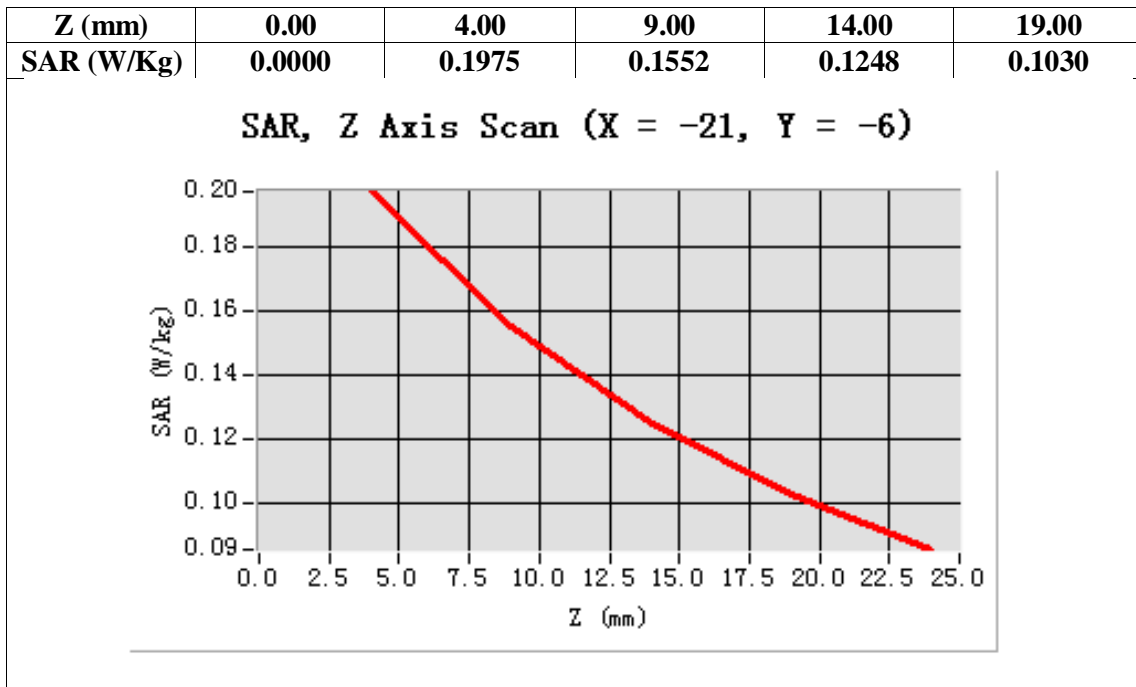

Test Laboratory: AGC Lab

Date: June 26,2014

WCDMA Band V Mid- Touch-Right (RMC)

DUT: Pilot PLUS; Type: Z550

Communication System: UMTS; Communication System Band: BAND V UTRA/FDD ; Duty Cycle:1: 1; Conv.F=5.27
Frequency: 835 MHz; Medium parameters used: $f = 836.6$ MHz; $\sigma=0.90$ mho/m; $\epsilon_r = 41.94$; $\rho = 1000$ kg/m³ ;
Phantom section: Right Section
Ambient temperature (°C): 21, Liquid temperature (°C): 21

SATIMO Configuration:

- Probe: SSE5; Calibrated: 01/12/2014; Serial No.:SN 22/12 EP159
- Sensor-Surface: 4mm (Mechanical Surface Detection)
- Phantom: Flat Phantom; Type: Elliptical Phantom
- Measurement SW: OpenSAR V4_02_01

Configuration/ WCDMA Band V Mid-Touch-Right/Area Scan: Measurement grid: dx=8mm, dy=8mm
Configuration/ WCDMA Band V Mid-Touch-Right/Zoom Scan: Measurement grid: dx=8mm, dy=8mm, dz=5mm;

Area Scan	sam_direct_droit2_surf8mm.txt
ZoomScan	5x5x7,dx=8mm dy=8mm dz=5mm,Very fast
Phantom	Right head
Device Position	Cheek
Band	WCDMA Band V
Channels	Middle
Signal	TDMA (Crest factor: 1.0)

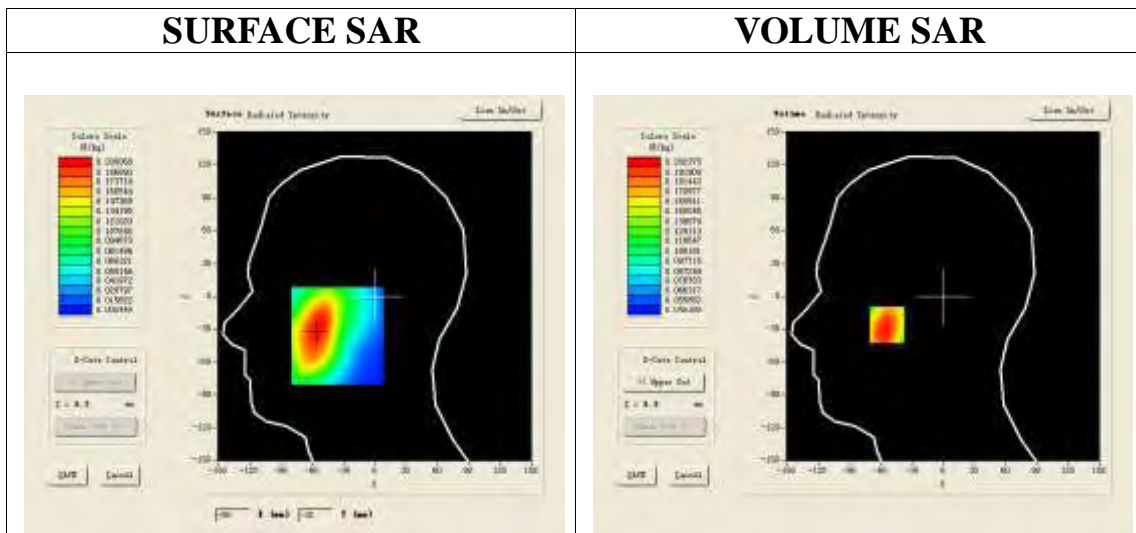

Maximum location: X=-54.00, Y=-26.00

SAR 10g (W/Kg)	0.146988
SAR 1g (W/Kg)	0.196224

Z (mm)	0.00	4.00	9.00	14.00	19.00
SAR (W/Kg)	0.0000	0.2024	0.1639	0.1310	0.1029

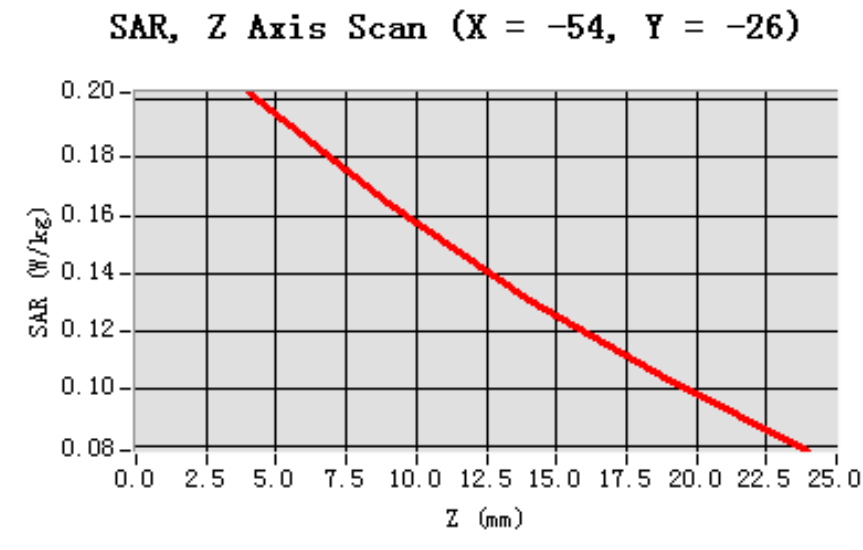

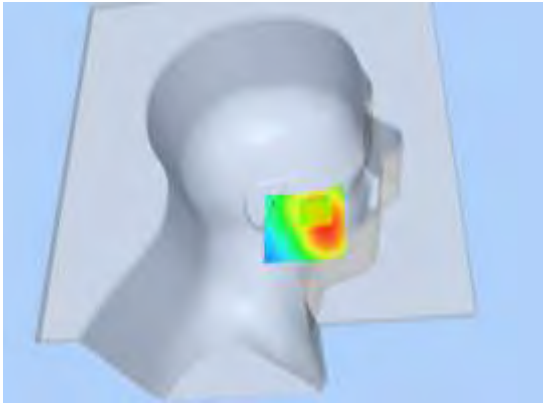
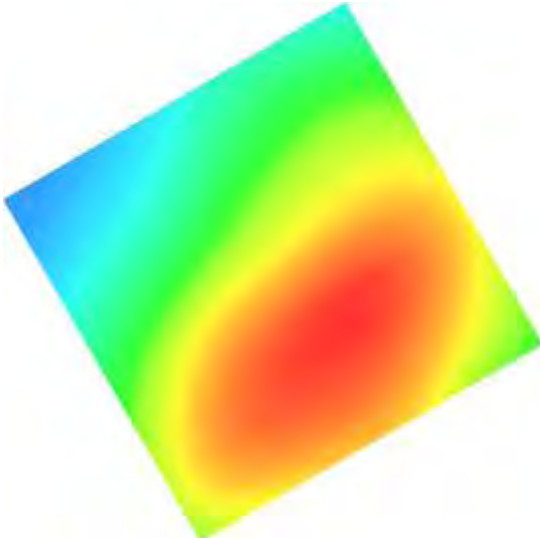
3D screen shot	Hot spot position
	

Test Laboratory: AGC Lab

Date: June 26,2014

WCDMA Band V Mid-Tilt-Right (RMC)

DUT: Pilot PLUS; Type: Z550

Communication System: UMTS; Communication System Band: BAND V UTRA/FDD ; Duty Cycle:1: 1; Conv.F=5.27
Frequency: 835 MHz; Medium parameters used: $f = 836.6$ MHz; $\sigma=0.90$ mho/m; $\epsilon_r =41.94$; $\rho= 1000$ kg/m³ ;
Phantom section: Right Section
Ambient temperature (°C): 21, Liquid temperature (°C): 21

SATIMO Configuration:

- Probe: SSE5; Calibrated: 01/12/2014; Serial No.:SN 22/12 EP159
- Sensor-Surface: 4mm (Mechanical Surface Detection)
- Phantom: Flat Phantom; Type: Elliptical Phantom
- Measurement SW: Open SAR V4_02_01

Configuration/ WCDMA Band V Mid-Tilt-Right/Area Scan: Measurement grid: dx=8mm, dy=8mm
Configuration/ WCDMA Band V Mid-Tilt-Right/Zoom Scan: Measurement grid: dx=8mm, dy=8mm, dz=5mm;

Area Scan	sam_direct_droit2_surf8mm.txt
Zoom Scan	5x5x7,dx=8mm dy=8mm dz=5mm,Very fast
Phantom	Right head
Device Position	Tilt
Band	WCDMA Band V
Channels	Middle
Signal	TDMA (Crest factor: 1.0)

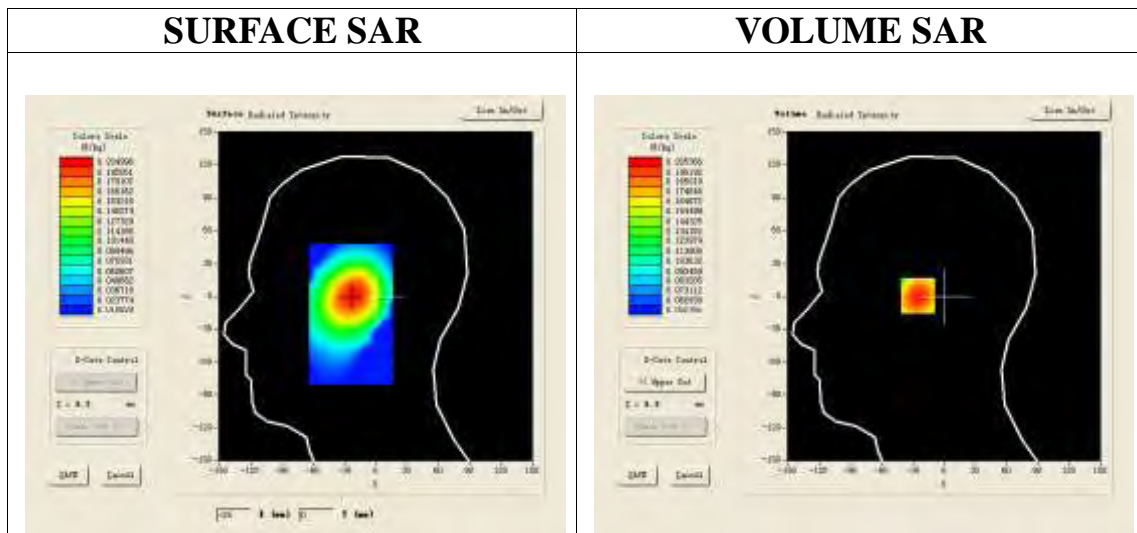

Maximum location: X=-23.00, Y=1.00

SAR 10g (W/Kg)	0.148749
SAR 1g (W/Kg)	0.197931

Z (mm)	0.00	4.00	9.00	14.00	19.00
SAR (W/Kg)	0.0000	0.2054	0.1614	0.1288	0.1047

SAR, Z Axis Scan (X = -23, Y = 1)

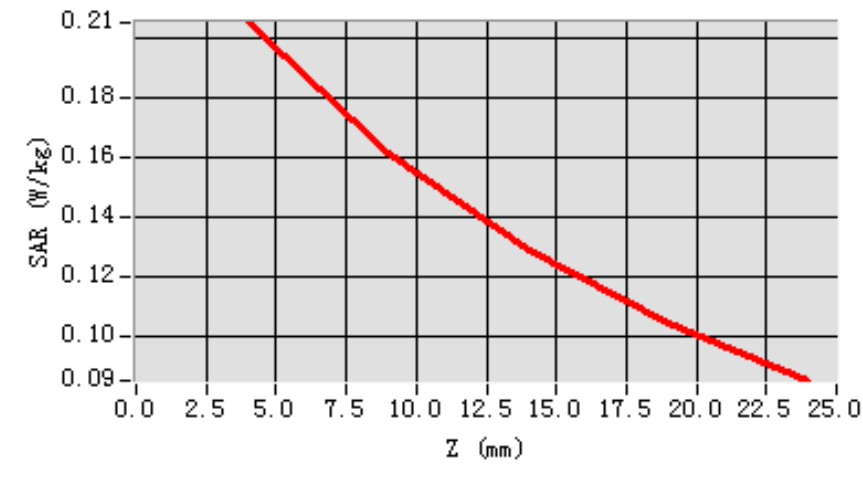

3D screen shot

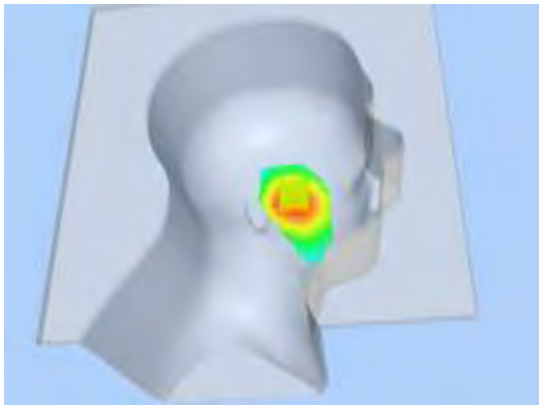

Hot spot position

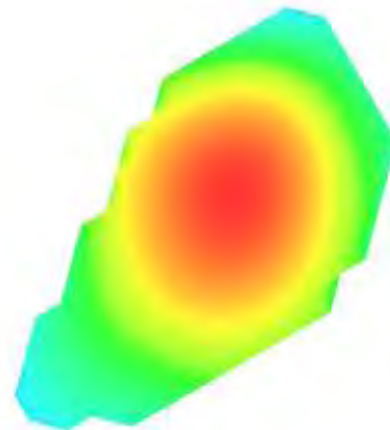

Test Laboratory: AGC Lab

Date: June 26,2014

WCDMA Band V Mid-Body-Towards Grounds (RMC)

DUT: Pilot PLUS; Type: Z550

Communication System: UMTS; Communication System Band: BAND V UTRA/FDD; Duty Cycle:1: 1; Conv.F=5.48
Frequency: 835 MHz; Medium parameters used: $f = 836.6$ MHz; $\sigma=0.98$ mho/m; $\epsilon_r =55.73$; $\rho= 1000$ kg/m³ ;
Phantom section: Flat Section
Ambient temperature (°C):21, Liquid temperature (°C):21

SATIMO Configuration:

- Probe: SSE5; Calibrated: 01/12/2014; Serial No.:SN 22/12 EP159
- Sensor-Surface: 4mm (Mechanical Surface Detection)
- Phantom: Flat Phantom; Type: Elliptical Phantom
- Measurement SW: OpenSAR V4_02_01

Configuration/ WCDMA Band V Mid-Body-Back/Area Scan (6x8x1): Measurement grid: dx=8mm, dy=8mm
Configuration/ WCDMA Band V Mid-Body-Back/Zoom Scan (5x5x7)/Cube 0: Measurement grid:
dx=8mm,dy=8mm, dz=5mm;

Area Scan	surf_sam_plan.txt
ZoomScan	5x5x7,dx=8mm dy=8mm dz=5mm,Very fast
Phantom	Validation plane
Device Position	Body Back
Band	WCDMA Band V
Channels	Middle
Signal	TDMA (Crest factor: 1.0)

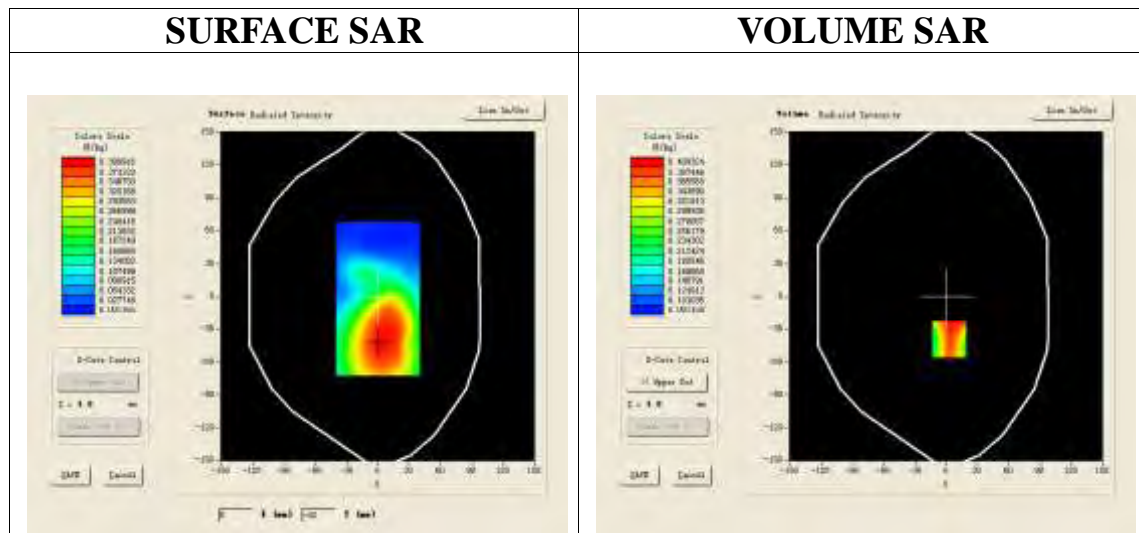

Maximum location: X=3.00, Y=-39.00

SAR 10g (W/Kg)	0.296574
SAR 1g (W/Kg)	0.393161

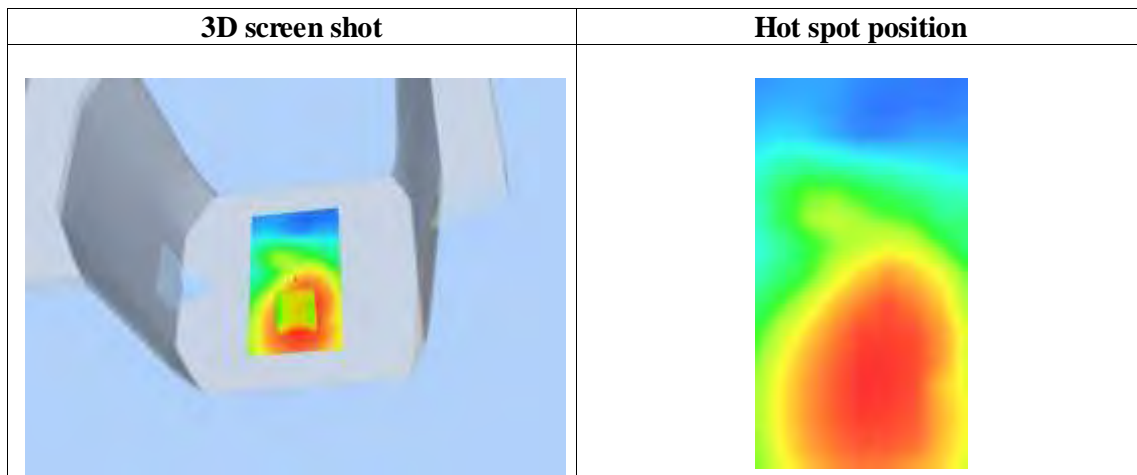
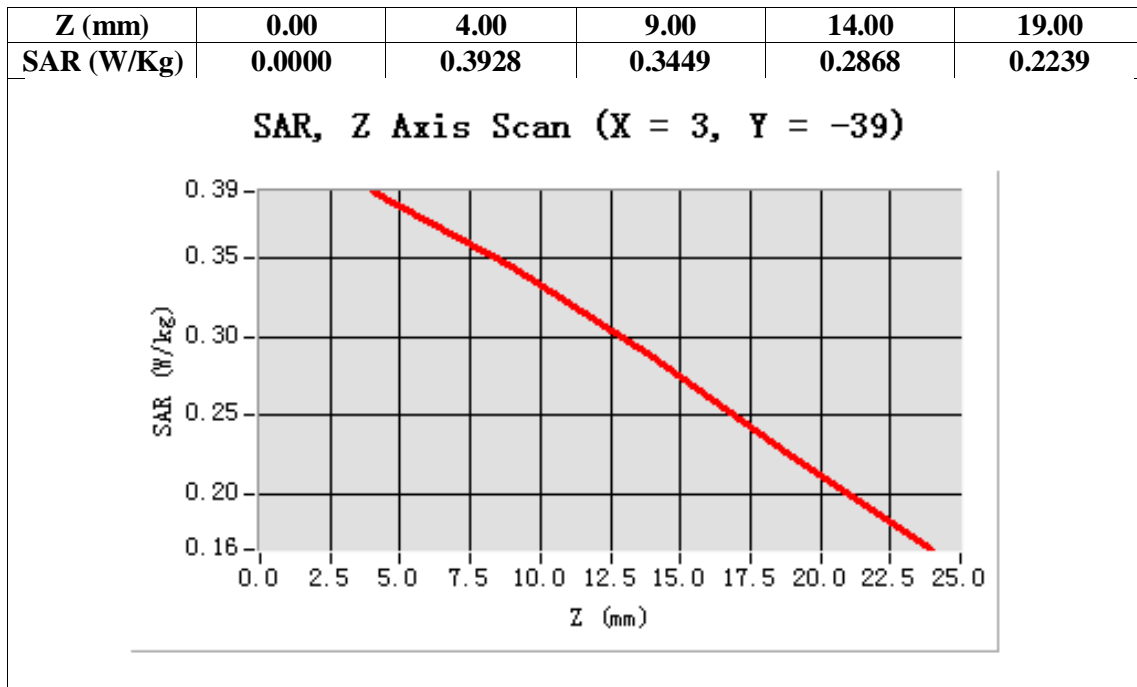

Test Laboratory: AGC Lab

Date: June 26,2014

WCDMA Band V Mid- Body - Towards Phantom (RMC)

DUT: Pilot PLUS; Type: Z550

Communication System: UMTS; Communication System Band: BAND V UTRA/FDD ; Duty Cycle:1: 1; Conv.F=5.48
Frequency: 835 MHz; Medium parameters used: $f = 836.6$ MHz; $\sigma=0.98$ mho/m; $\epsilon_r =55.73$; $\rho= 1000$ kg/m³ ;
Phantom section: Flat Section
Ambient temperature (°C):21, Liquid temperature (°C):21

SATIMO Configuration:

- Probe: SSE5; Calibrated: 01/12/2014; Serial No.:SN 22/12 EP159
- Sensor-Surface: 4mm (Mechanical Surface Detection)
- Phantom: Flat Phantom; Type: Elliptical Phantom
- Measurement SW: Open SAR V4_02_01

Configuration/ WCDMA Band V Mid-Body-Front/Area Scan (6x8x1): Measurement grid: dx=8mm, dy=8mm
Configuration/ WCDMA Band V Mid-Body-Front/Zoom Scan (5x5x7)/Cube 0: Measurement grid: dx=8mm, dy=8mm, dz=5mm;

Area Scan	surf_sam_plan.txt
ZoomScan	5x5x7,dx=8mm dy=8mm dz=5mm,Very fast
Phantom	Validation plane
Device Position	Body Front
Band	WCDMA Band V
Channels	Middle
Signal	TDMA (Crest factor: 1.0)

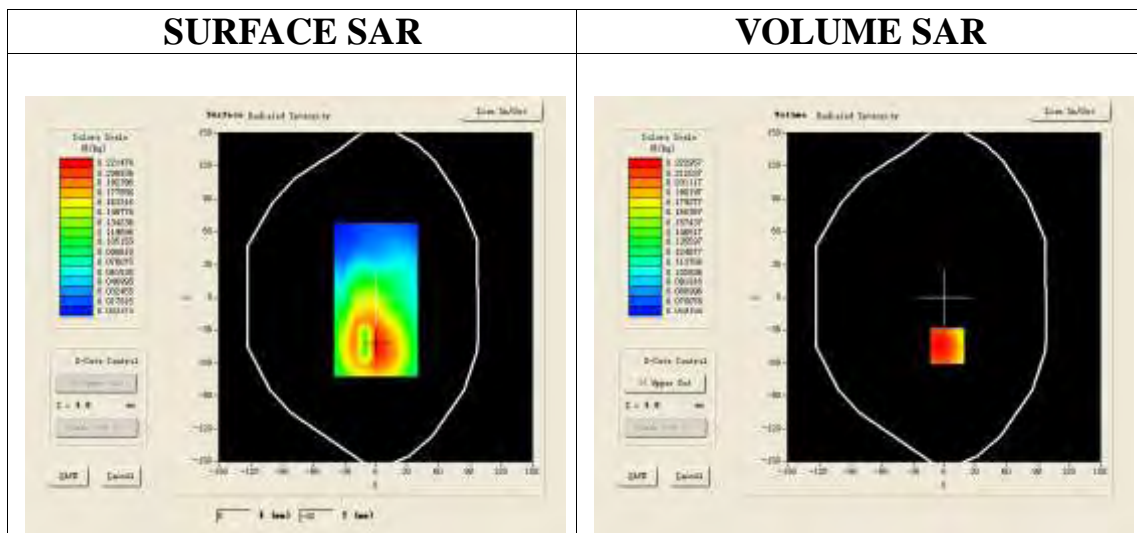

Maximum location: X=3.00, Y=-44.00

SAR 10g (W/Kg)	0.164383
SAR 1g (W/Kg)	0.215896

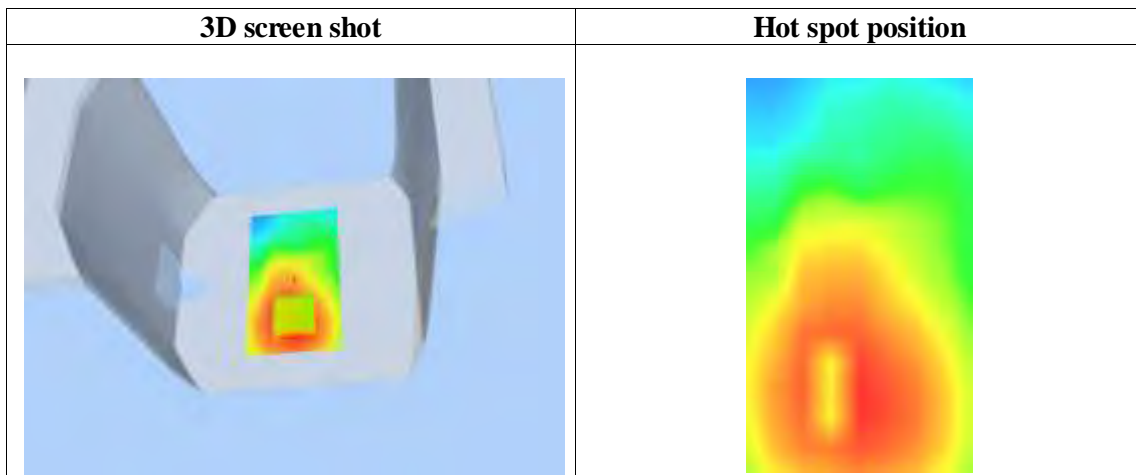
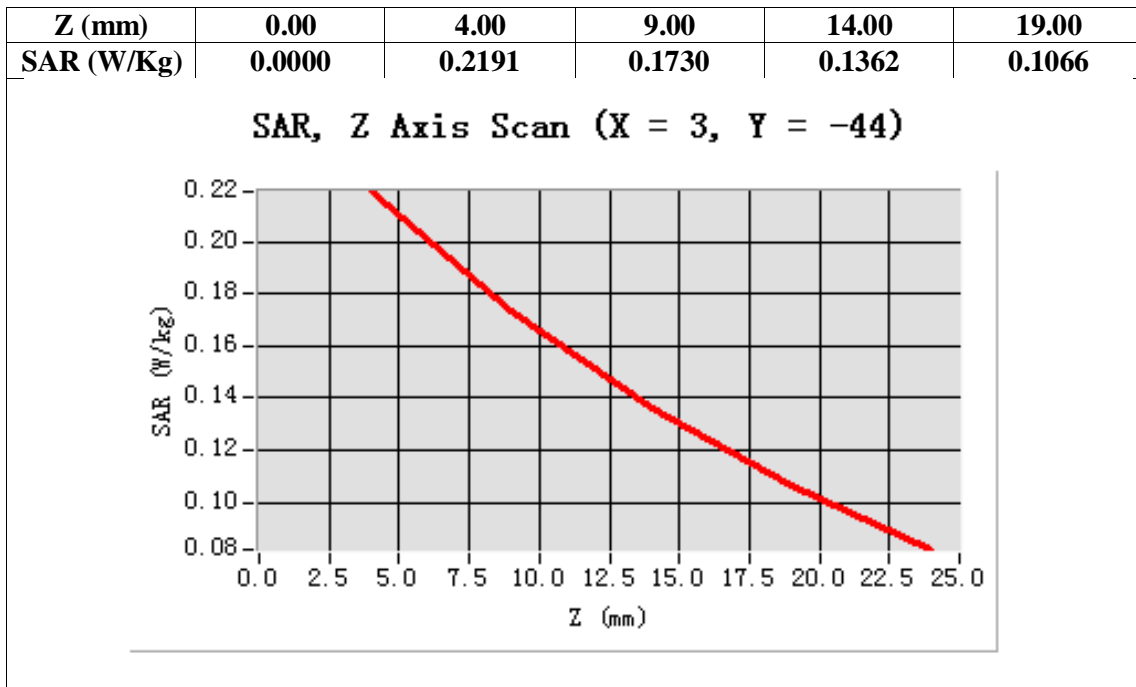

WIFI MODE

Test Laboratory: AGC Lab
802.11b Mid-Touch-Left -DTS
DUT: Pilot PLUS; Type: Z550

Date: June 26,2014

Communication System: Wi-Fi; Communication System Band: 802.11b; Duty Cycle: 1:1; Conv.F=4.42;
Frequency: 2437 MHz; Medium parameters used: $f = 2450$ MHz; $\sigma = 1.78$ mho/m; $\epsilon_r = 40.00$; $\rho = 1000$ kg/m³ ;
Phantom section: Left Section
Ambient temperature (°C): 21, Liquid temperature (°C): 21

SATIMO Configuration:

- Probe: SSE5; Calibrated: 01/12/2014; Serial No.:SN 22/12 EP159
- Sensor-Surface: 4mm (Mechanical Surface Detection)
- Phantom: Flat Phantom; Type: Elliptical Phantom
- Measurement SW: OpenSAR V4_02_01

Configuration/802.11b Mid- Touch-Left/Area Scan (6x8x1): Measurement grid: dx=8mm, dy=8mm
Configuration/802.11b Mid- Touch-Left/Zoom Scan (5x5x7)/Cube 0: Measurement grid: dx=8mm, dy=8mm, dz=5mm

Area Scan	sam_direct_droit2_surf8mm.txt
ZoomScan	5x5x7,dx=8mm dy=8mm dz=5mm,Very fast
Phantom	Left head
Device Position	Cheek
Band	2450MHz
Channels	Middle
Signal	TDMA (Crest factor: 8.0)

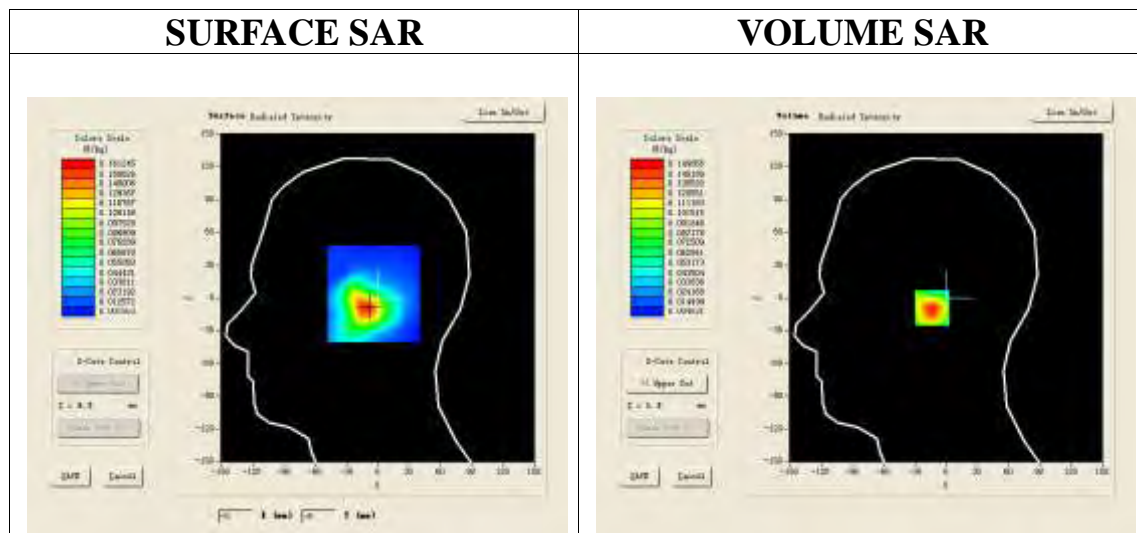

Maximum location: X=-9.00, Y=-9.00

SAR 10g (W/Kg)	0.071795
SAR 1g (W/Kg)	0.147106

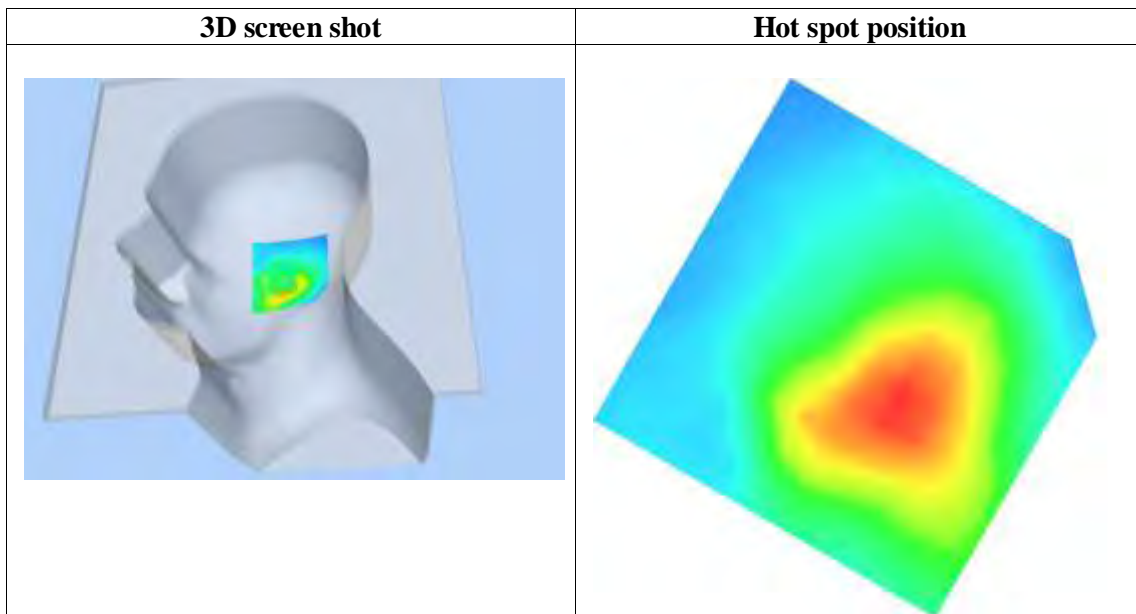
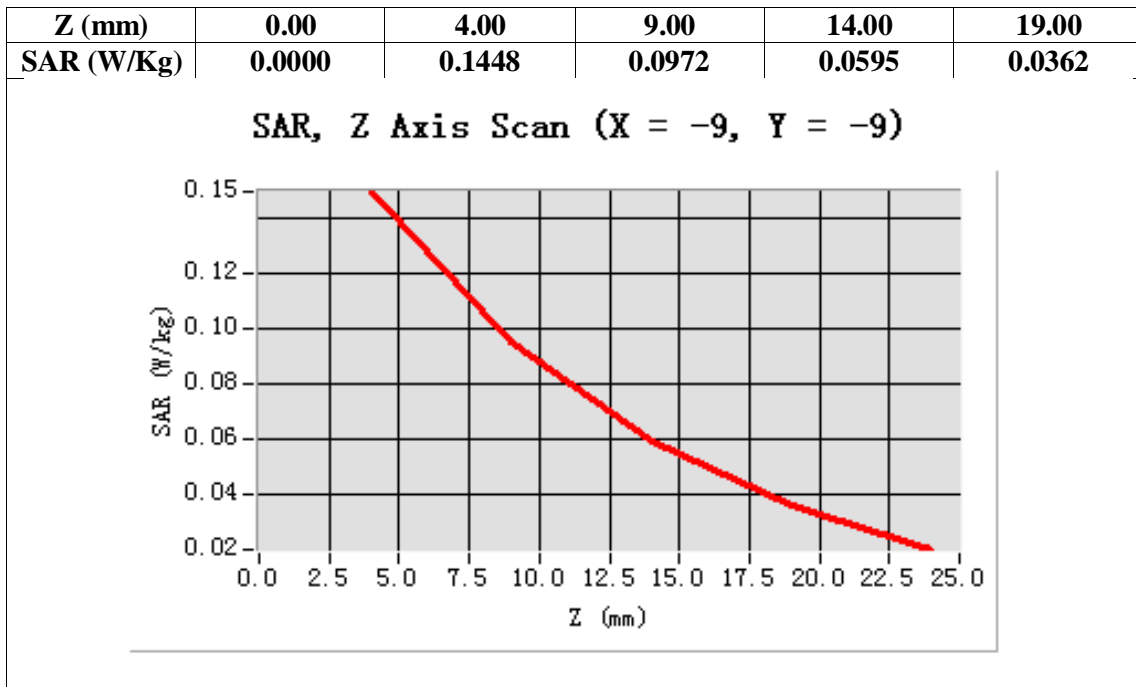

Test Laboratory: AGC Lab
802.11b Mid -Tilt-Left -DTS
DUT: Pilot PLUS; Type: Z550

Date: June 26,2014

Communication System: Wi-Fi; Communication System Band: 802.11b; Duty Cycle: 1:1; Conv.F=4.42;
Frequency: 2437 MHz; Medium parameters used: $f = 2450$ MHz; $\sigma = 1.78$ mho/m; $\epsilon_r = 40.00$; $\rho = 1000$ kg/m³ ;
Phantom section: Left Section
Ambient temperature (°C): 21, Liquid temperature (°C): 21

SATIMO Configuration:

- Probe: SSE5; Calibrated: 01/12/2014; Serial No.:SN 22/12 EP159
- Sensor-Surface: 4mm (Mechanical Surface Detection)
- Phantom: Flat Phantom; Type: Elliptical Phantom
- Measurement SW: OpenSAR V4_02_01

Configuration/802.11b Mid- Tilt-Left/Area Scan (6x8x1): Measurement grid: dx=8mm, dy=8mm
Configuration/802.11b Mid- Tilt-Left/Zoom Scan (5x5x7)/Cube 0: Measurement grid: dx=8mm, dy=8mm,dz=5mm;

Area Scan	sam_direct_droit2_surf8mm.txt
ZoomScan	5x5x7,dx=8mm dy=8mm dz=5mm,Very fast
Phantom	Left head
Device Position	Tilt
Band	2450MHz
Channels	Middle
Signal	TDMA (Crest factor: 8.0)

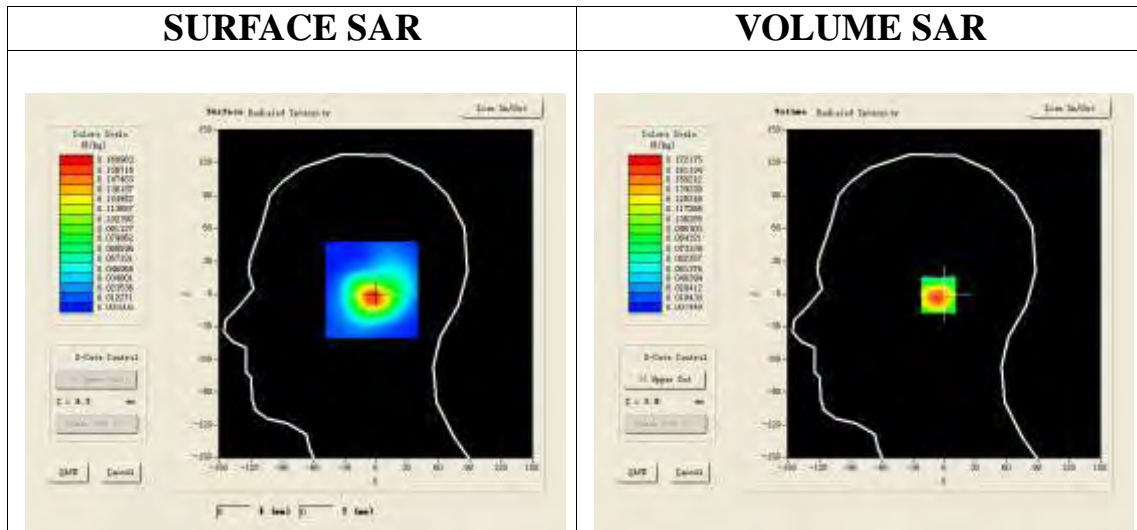

Maximum location: X=-1.00, Y=-1.00

SAR 10g (W/Kg)	0.089091
SAR 1g (W/Kg)	0.162425

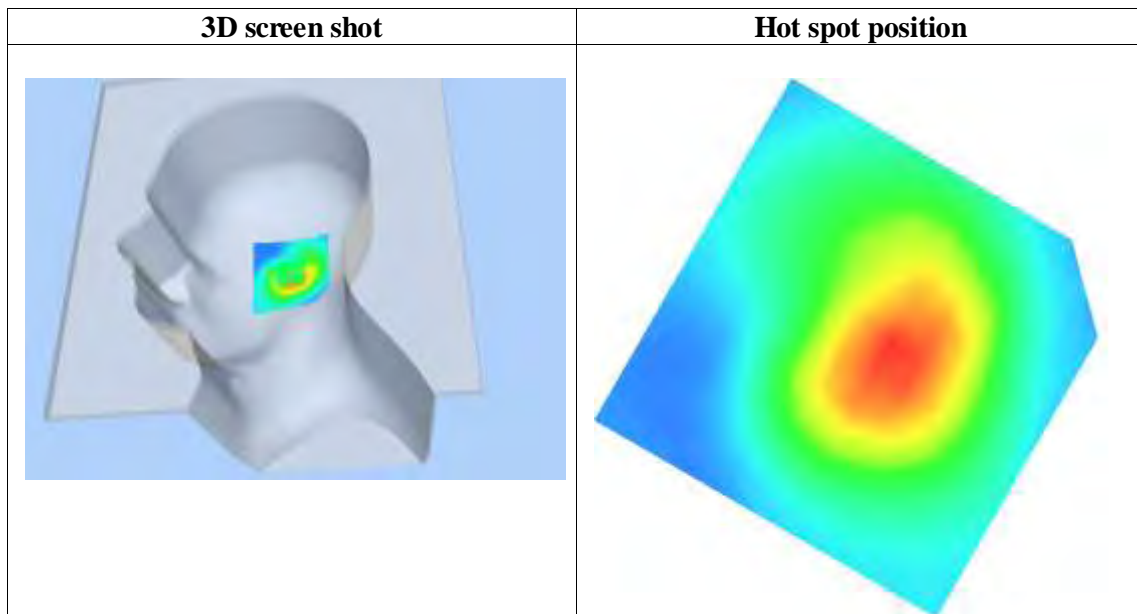
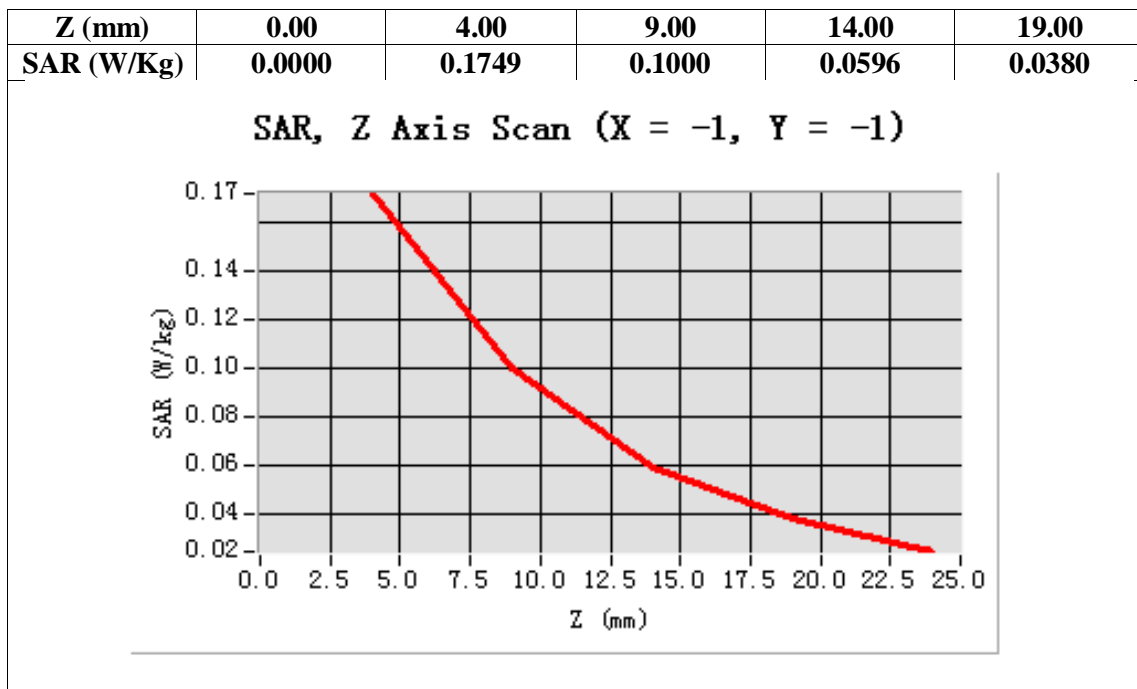

Test Laboratory: AGC Lab
802.11b Mid- Touch-Right -DTS
DUT: Pilot PLUS; Type: Z550

Date: June 26,2014

Communication System: Wi-Fi; Communication System Band: 802.11b; Duty Cycle: 1:1; Conv.F=4.42;
Frequency: 2437 MHz; Medium parameters used: $f = 2450$ MHz; $\sigma = 1.78$ mho/m; $\epsilon_r = 40.00$; $\rho = 1000$ kg/m³ ;
Phantom section: Right Section
Ambient temperature (°C): 21, Liquid temperature (°C): 21

SATIMO Configuration:

- Probe: SSE5; Calibrated: 01/12/2014; Serial No.:SN 22/12 EP159
- Sensor-Surface: 4mm (Mechanical Surface Detection)
- Phantom: Flat Phantom; Type: Elliptical Phantom
- Measurement SW: OpenSAR V4_02_01

Configuration/802.11b Mid- Touch-Right /Area Scan: Measurement grid: dx=8mm, dy=8mm
Configuration/802.11b Mid- Touch-Right /Zoom Scan: Measurement grid: dx=8mm, dy=8mm, dz=5mm;

Area Scan	sam_direct_droit2_surf8mm.txt
ZoomScan	5x5x7,dx=8mm dy=8mm dz=5mm,Very fast
Phantom	Right head
Device Position	Cheek
Band	2450MHz
Channels	Middle
Signal	TDMA (Crest factor: 8.0)

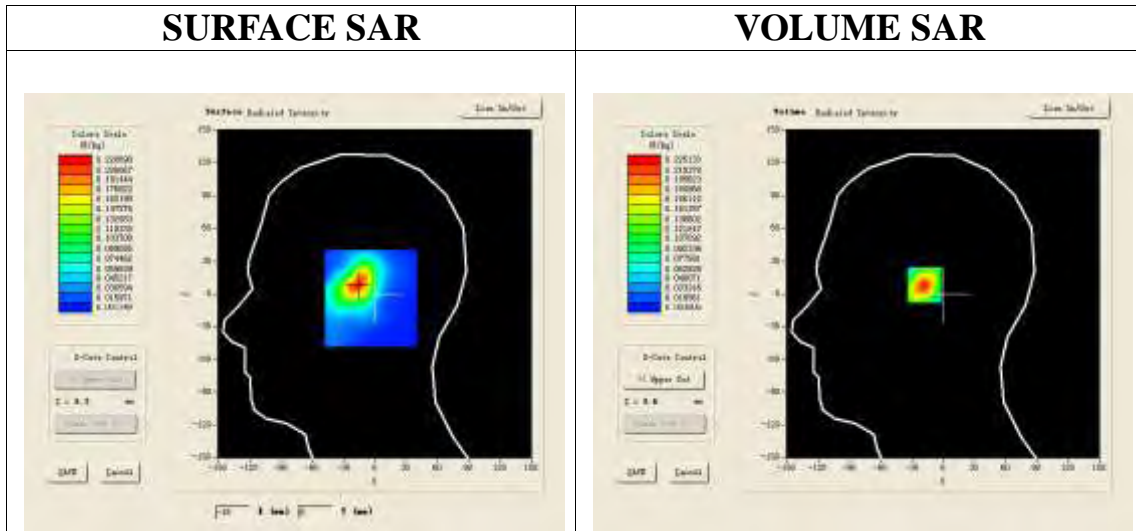

Maximum location: X=-16.00, Y=9.00

SAR 10g (W/Kg)	0.114846
SAR 1g (W/Kg)	0.202687

Z (mm)	0.00	4.00	9.00	14.00	19.00
SAR (W/Kg)	0.0000	0.2251	0.1425	0.0881	0.0530

SAR, Z Axis Scan (X = -16, Y = 9)

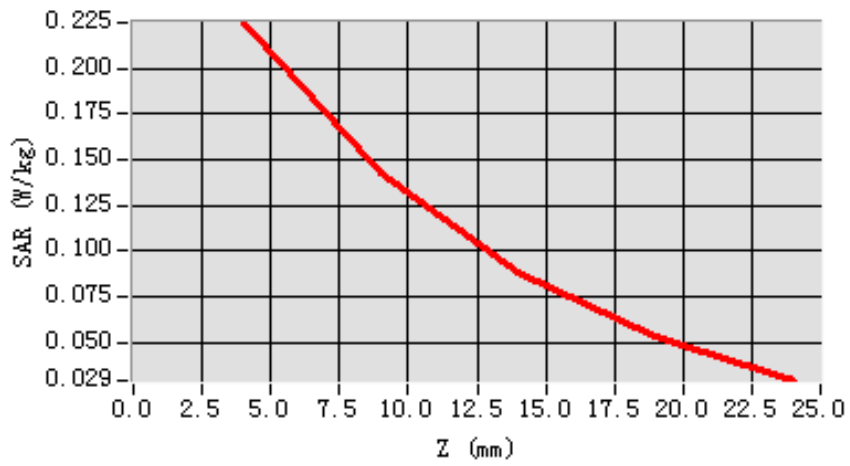

3D screen shot

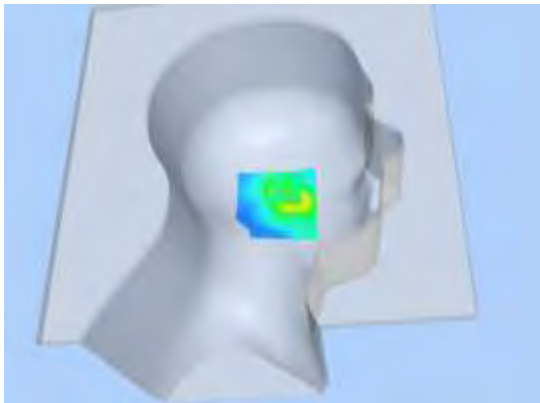

Hot spot position

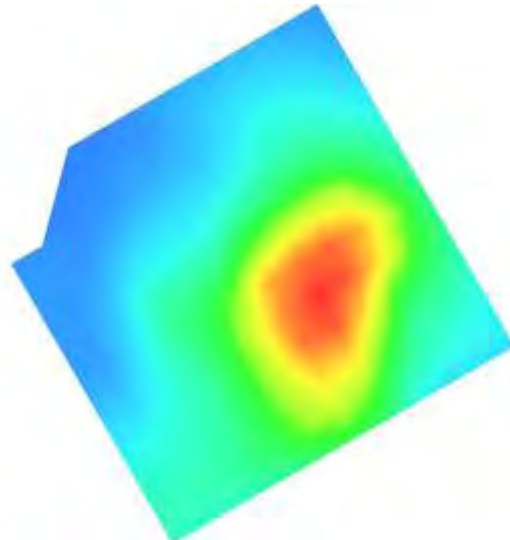

Test Laboratory: AGC Lab
802.11b Mid-Tilt-Right -DTS
DUT: Pilot PLUS; Type: Z550

Date: June 26,2014

Communication System: Wi-Fi; Communication System Band: 802.11b; Duty Cycle: 1:1; Conv.F=4.42;
Frequency: 2437 MHz; Medium parameters used: $f = 2450$ MHz; $\sigma = 1.78$ mho/m; $\epsilon_r = 40.00$; $\rho = 1000$ kg/m³ ;
Phantom section: Right Section
Ambient temperature (°C): 21, Liquid temperature (°C): 21

SATIMO Configuration:

- Probe: SSE5; Calibrated: 01/12/2014; Serial No.:SN 22/12 EP159
- Sensor-Surface: 4mm (Mechanical Surface Detection)
- Phantom: Flat Phantom; Type: Elliptical Phantom
- Measurement SW: OpenSAR V4_02_01

Configuration/802.11b Mid- Tilt-Right/Area Scan: Measurement grid: dx=8mm, dy=8mm

Configuration/802.11b Mid- Tilt-Right/Zoom Scan: Measurement grid: dx=8mm, dy=8mm, dz=5mm;

Area Scan	sam_direct_droit2_surf8mm.txt
Zoom Scan	5x5x7,dx=8mm dy=8mm dz=5mm,Very fast
Phantom	Right head
Device Position	Tilt
Band	2450MHz
Channels	Middle
Signal	TDMA (Crest factor: 8.0)

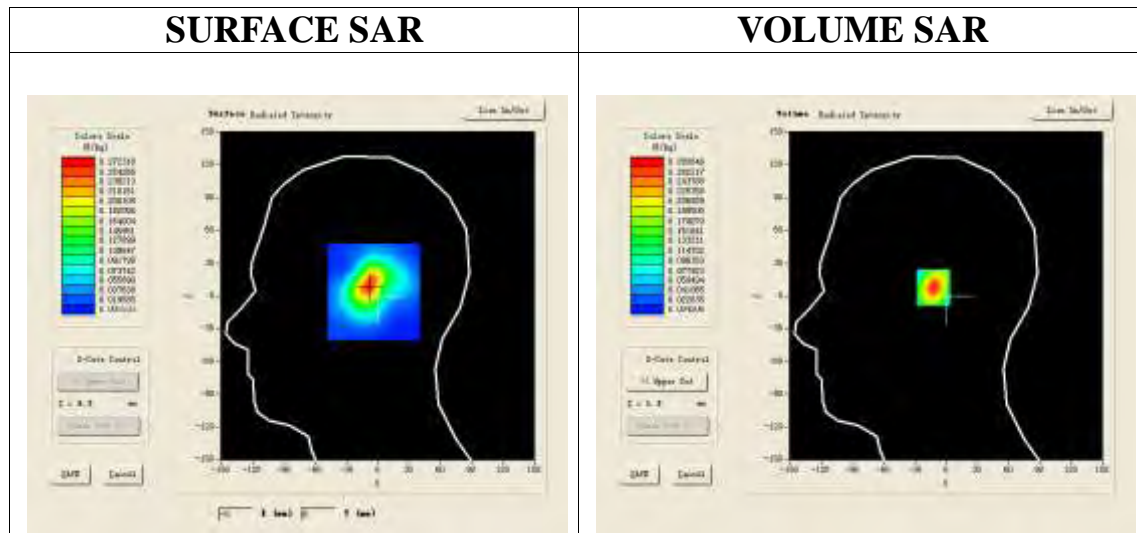

Maximum location: X=-9.00, Y=8.00

SAR 10g (W/Kg)	0.145418
SAR 1g (W/Kg)	0.255896

Z (mm)	0.00	4.00	9.00	14.00	19.00
SAR (W/Kg)	0.0000	0.2806	0.1817	0.1143	0.0693

SAR, Z Axis Scan (X = -9, Y = 8)

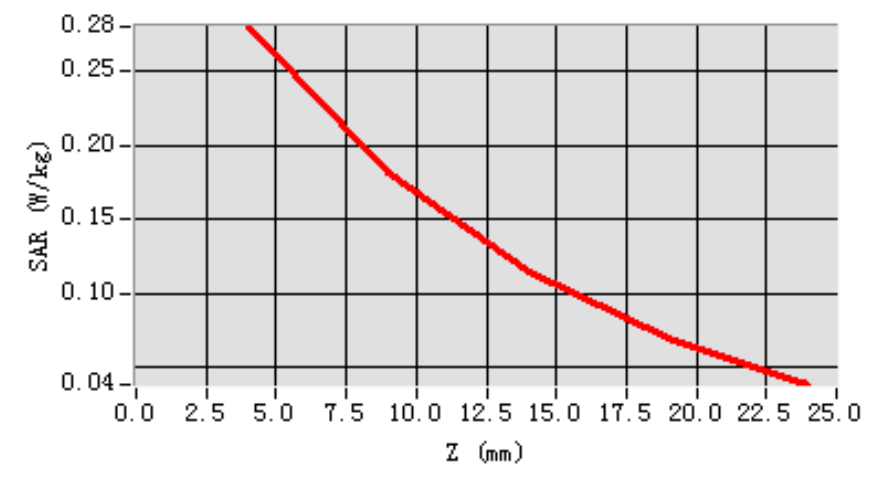

3D screen shot

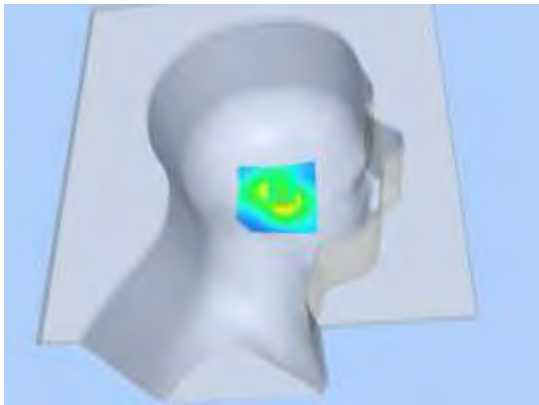

Hot spot position

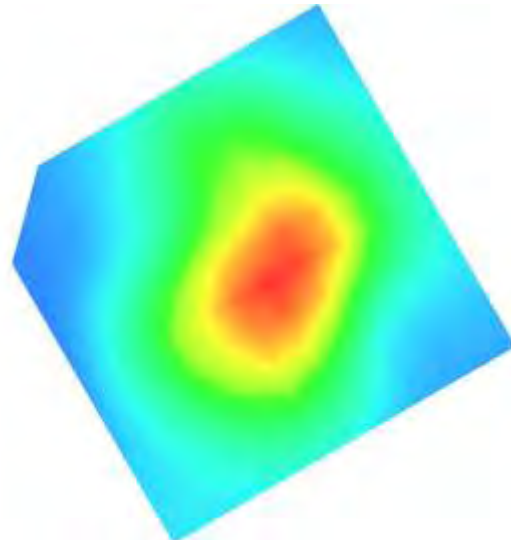

Test Laboratory: AGC Lab
802.11b Mid-Body-Wom- Back (DTS)
DUT: Pilot PLUS; Type: Z550

Date: June 26,2014

Communication System: Wi-Fi; Communication System Band: 802.11b; Duty Cycle: 1:1; Conv.F=4.31;
Frequency: 2437 MHz; Medium parameters used: $f = 2450$ MHz; $\sigma=1.90$ mho/m; $\epsilon_r = 52.68$; $\rho= 1000$ kg/m³ ;
Phantom section: Flat Section
Ambient temperature (°C):21, Liquid temperature (°C):21

SATIMO Configuration:

- Probe: SSE5; Calibrated: 01/12/2014; Serial No.:SN 22/12 EP159
- Sensor-Surface: 4mm (Mechanical Surface Detection)
- Phantom: Flat Phantom; Type: Elliptical Phantom
- Measurement SW: Open SAR V4_02_01

Configuration/802.11b Mid- Body- Back /Area Scan (6x8x1): Measurement grid: dx=8mm, dy=8mm
Configuration/802.11b Mid- Body- Back /Zoom Scan (5x5x7)/Cube 0: Measurement grid: dx=8mm, dy=8mm, dz=5mm;

Area Scan	surf_sam_plan.txt
ZoomScan	5x5x7,dx=8mm dy=8mm dz=5mm,Very fast
Phantom	Validation plane
Device Position	Body Back
Band	2450MHz
Channels	Middle
Signal	TDMA (Crest factor: 8.0)

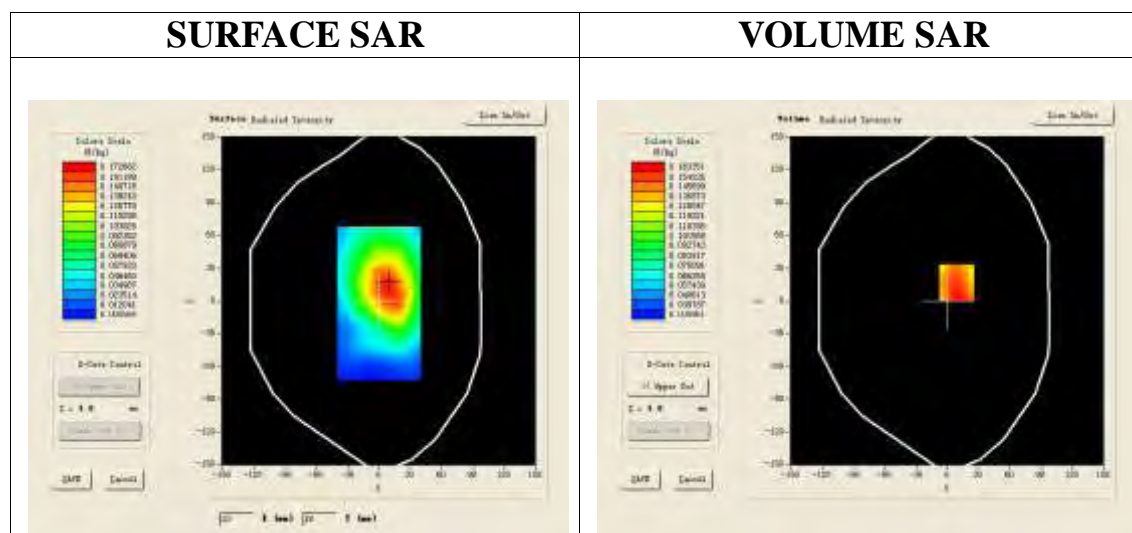

Maximum location: X=9.00, Y=17.00

SAR 10g (W/Kg)	0.109562
SAR 1g (W/Kg)	0.153808

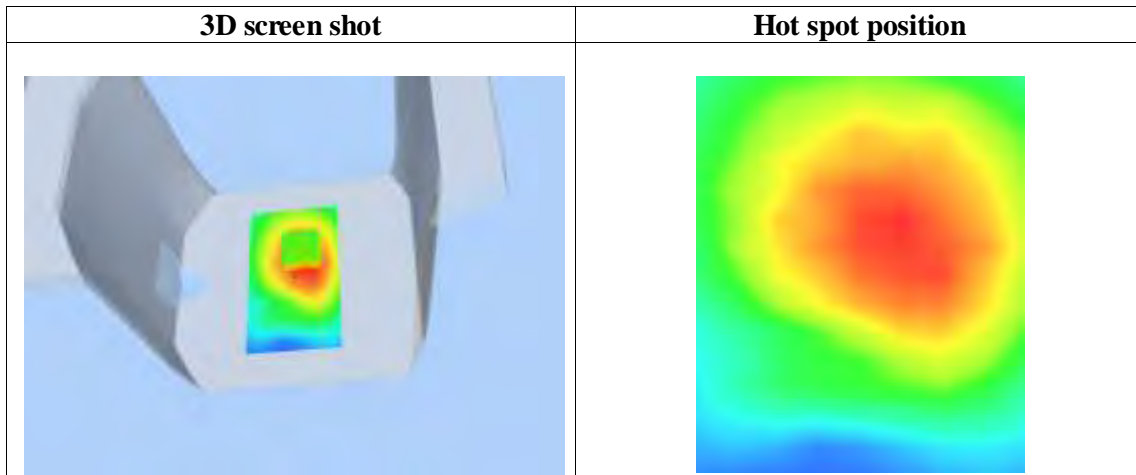
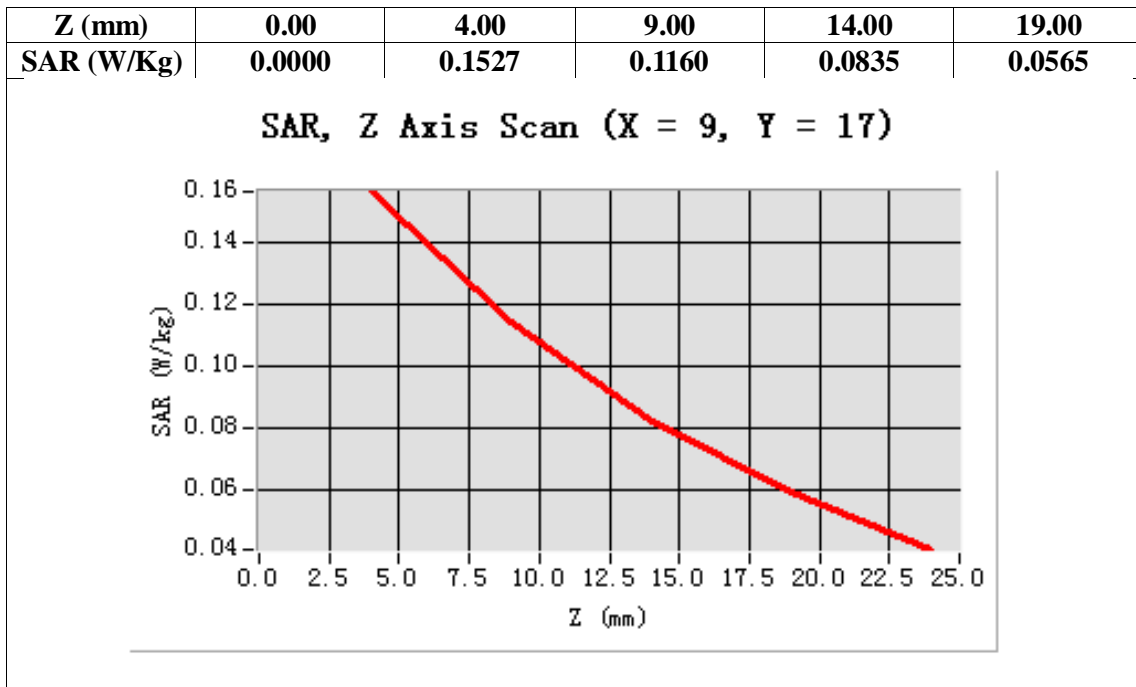

Test Laboratory: AGC Lab
802.11b Mid-Body -Front (DTS)
DUT: Pilot PLUS; Type: Z550

Date: June 26,2014

Communication System: Wi-Fi; Communication System Band: 802.11b; Duty Cycle: 1:1; Conv.F=4.31;
Frequency: 2437 MHz; Medium parameters used: $f = 2450$ MHz; $\sigma=1.90$ mho/m; $\epsilon_r = 52.68$; $\rho= 1000$ kg/m³ ;
Phantom section: Flat Section
Ambient temperature (°C):21, Liquid temperature (°C):21

SATIMO Configuration:

- Probe: SSE5; Calibrated: 01/12/2014; Serial No.:SN 22/12 EP159
- Sensor-Surface: 4mm (Mechanical Surface Detection)
- Phantom: Flat Phantom; Type: Elliptical Phantom
- Measurement SW: OpenSAR V4_02_01

Configuration/802.11b Mid-Body- Front /Area Scan: Measurement grid: dx=8mm, dy=8mm
Configuration/802.11b Mid-Body- Front /Zoom Scan: Measurement grid: dx=8mm, dy=8mm, dz=5mm;

Area Scan	surf_sam_plan.txt
ZoomScan	5x5x7,dx=8mm dy=8mm dz=5mm,Very fast
Phantom	Validation plane
Device Position	Body Front
Band	2450MHz
Channels	Middle
Signal	TDMA (Crest factor: 8.0)

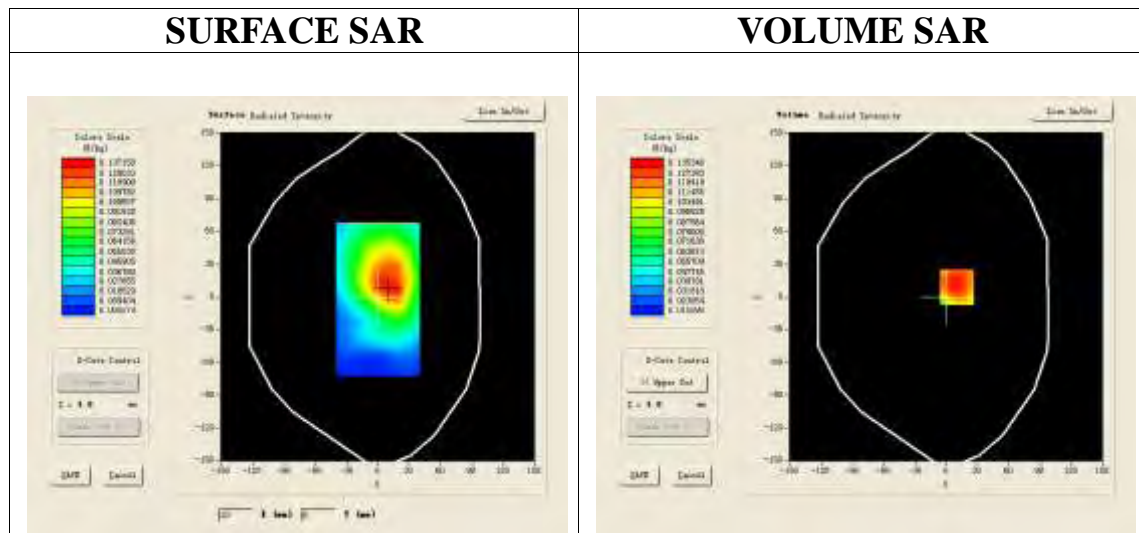

Maximum location: X=10.00, Y=9.00

SAR 10g (W/Kg)	0.089840
SAR 1g (W/Kg)	0.132762

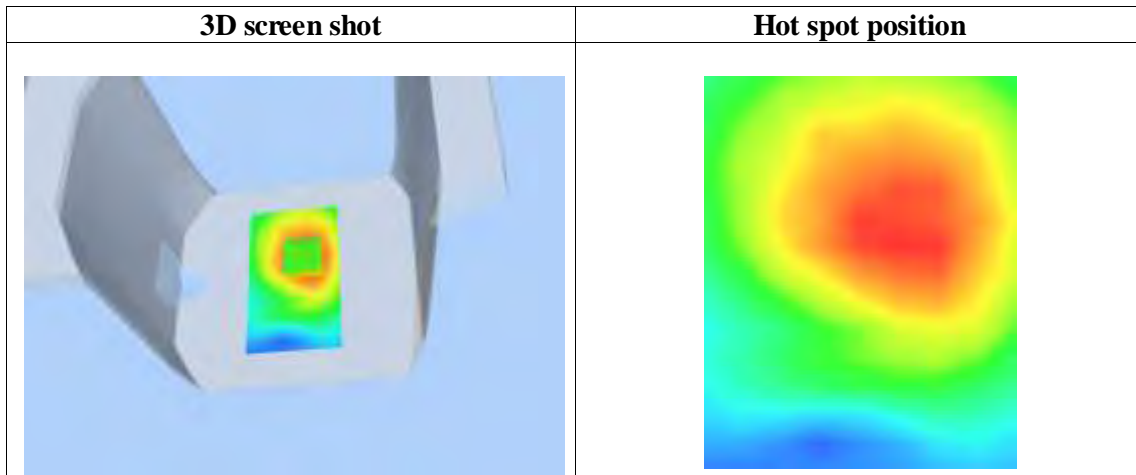
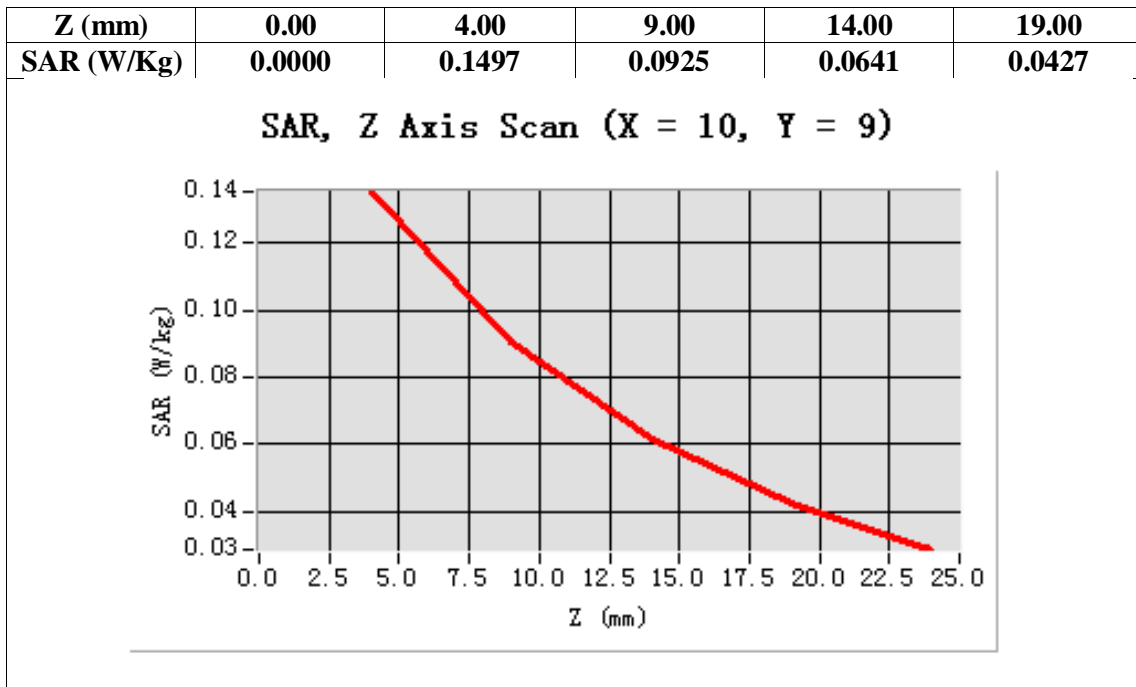

HOTSPOT MODE

Test Laboratory: AGC Lab

Date: June 26,2014

Hotspot Mid-Body-Worn- Back (DTS)

DUT: Pilot PLUS; Type: Z550

Communication System: Wi-Fi; Communication System Band: Hotspot; Duty Cycle: 1:1; Conv.F=4.31;
Frequency: 2437 MHz; Medium parameters used: $f = 2450$ MHz; $\sigma = 1.90$ mho/m; $\epsilon_r = 52.68$; $\rho = 1000$ kg/m³ ;
Phantom section: Flat Section
Ambient temperature (°C):21, Liquid temperature (°C):21

SATIMO Configuration:

- Probe: SSE5; Calibrated: 01/12/2014; Serial No.:SN 22/12 EP159
- Sensor-Surface: 4mm (Mechanical Surface Detection)
- Phantom: Flat Phantom; Type: Elliptical Phantom
- Measurement SW: OpenSAR V4_02_01

Configuration/Hotspot Mid- Body- Back /Area Scan (6x8x1): Measurement grid: dx=8mm, dy=8mm
Configuration/Hotspot Mid- Body- Back /Zoom Scan (5x5x7)/Cube 0: Measurement grid: dx=8mm, dy=8mm, dz=5mm;

Area Scan	surf_sam_plan.txt
ZoomScan	5x5x7,dx=8mm dy=8mm dz=5mm,Very fast
Phantom	Validation plane
Device Position	Body Back
Band	2450MHz
Channels	Middle
Signal	TDMA (Crest factor: 8.0)

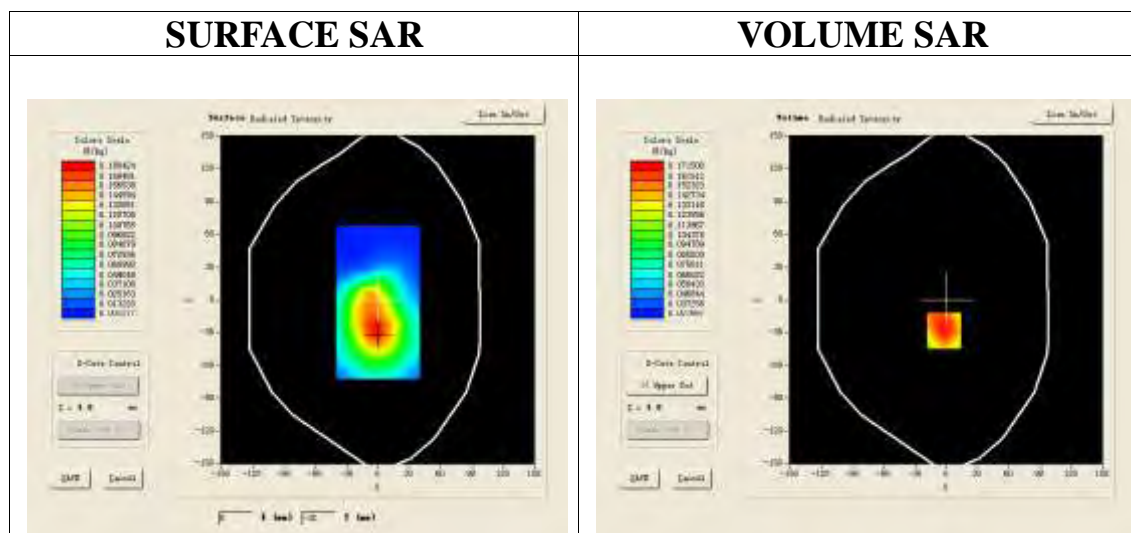

Maximum location: X=-2.00, Y=-28.00

SAR 10g (W/Kg)	0.127289
SAR 1g (W/Kg)	0.177248

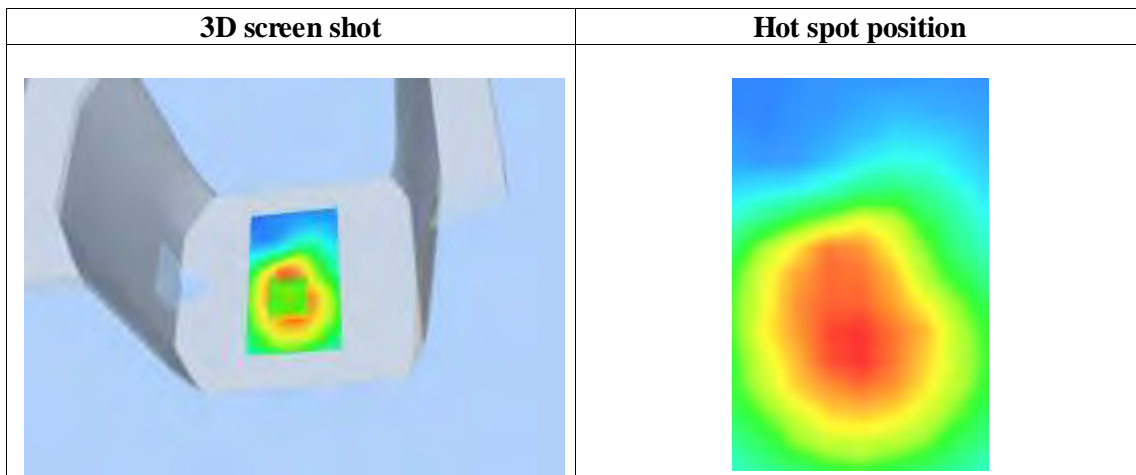
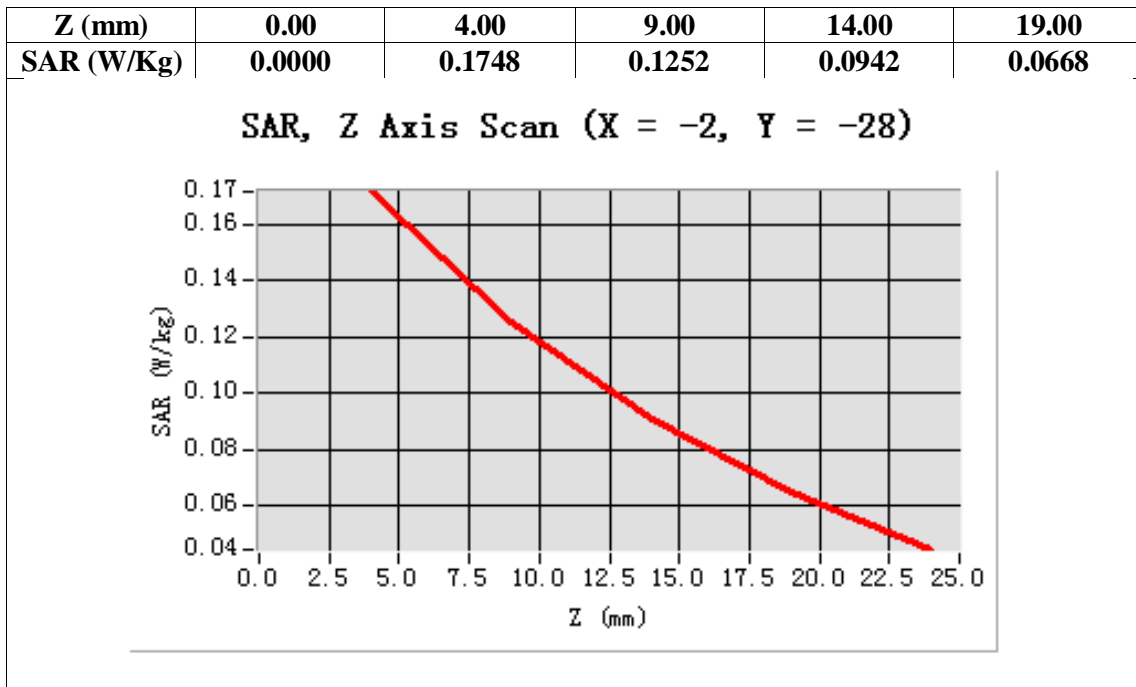

Test Laboratory: AGC Lab
Hotspot Mid-Body -Front (DTS)
DUT: Pilot PLUS; Type: Z550

Date: June 26,2014

Communication System: Wi-Fi; Communication System Band: Hotspot; Duty Cycle: 1:1; Conv.F=4.31;
Frequency: 2437 MHz; Medium parameters used: $f = 2450$ MHz; $\sigma=1.90$ mho/m; $\epsilon_r = 52.68$; $\rho= 1000$ kg/m³ ;
Phantom section: Flat Section
Ambient temperature (°C):21, Liquid temperature (°C):21

SATIMO Configuration:

- Probe: SSE5; Calibrated: 01/12/2014; Serial No.:SN 22/12 EP159
- Sensor-Surface: 4mm (Mechanical Surface Detection)
- Phantom: Flat Phantom; Type: Elliptical Phantom
- Measurement SW: OpenSAR V4_02_01

Configuration/Hotspot Mid-Body- Front /Area Scan: Measurement grid: dx=8mm, dy=8mm
Configuration/Hotspot Mid-Body- Front /Zoom Scan: Measurement grid: dx=8mm, dy=8mm, dz=5mm;

Area Scan	surf_sam_plan.txt
ZoomScan	5x5x7,dx=8mm dy=8mm dz=5mm,Very fast
Phantom	Validation plane
Device Position	Body Front
Band	2450MHz
Channels	Middle
Signal	TDMA (Crest factor: 8.0)

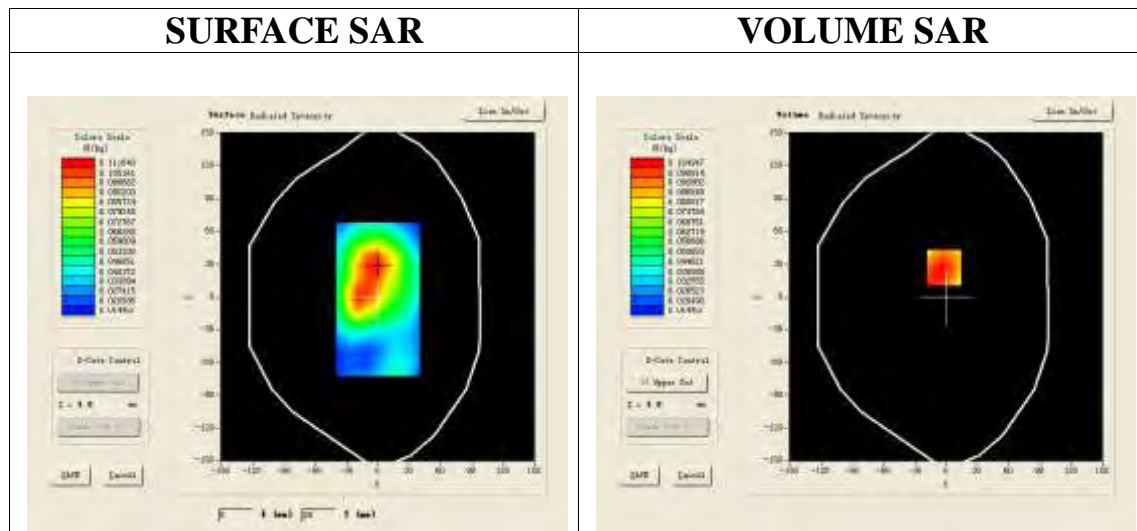

Maximum location: X=-2.00, Y=27.00

SAR 10g (W/Kg)	0.078263
SAR 1g (W/Kg)	0.102760

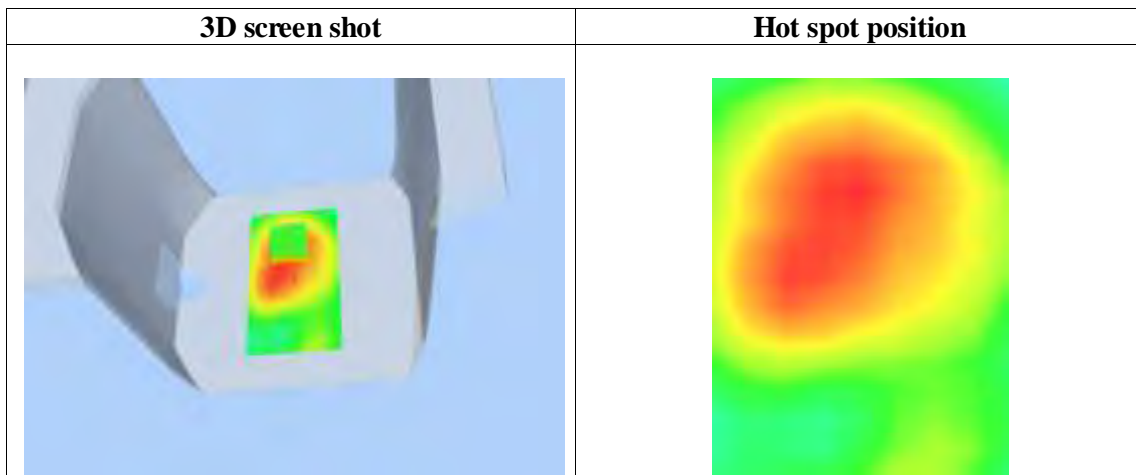
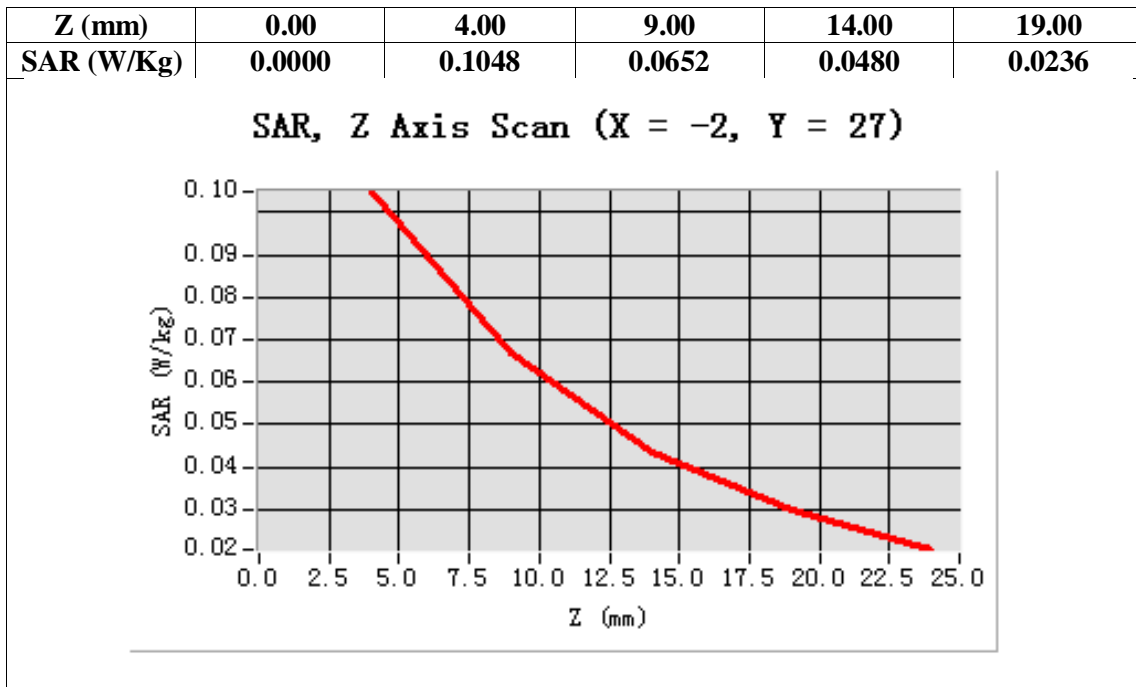

APPENDIX C. TEST SETUP PHOTOGRAPHS & EUT PHOTOGRAPHS

Test Setup Photographs

LEFT-CHECK TOUCH

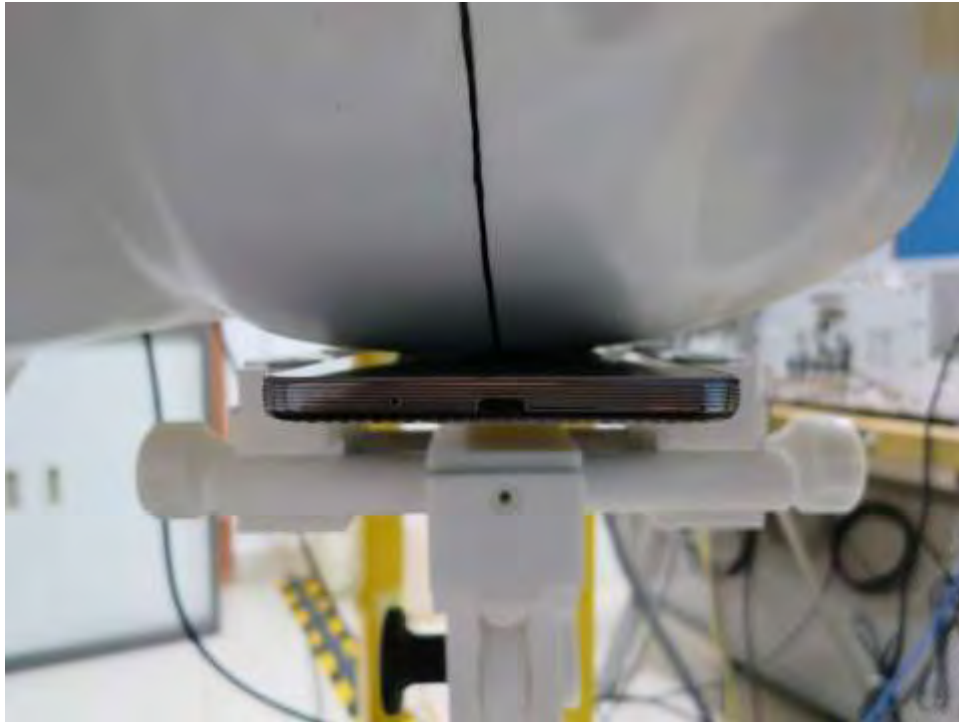

LEFT-TILT 15°



RIGHT-CHECK TOUCH

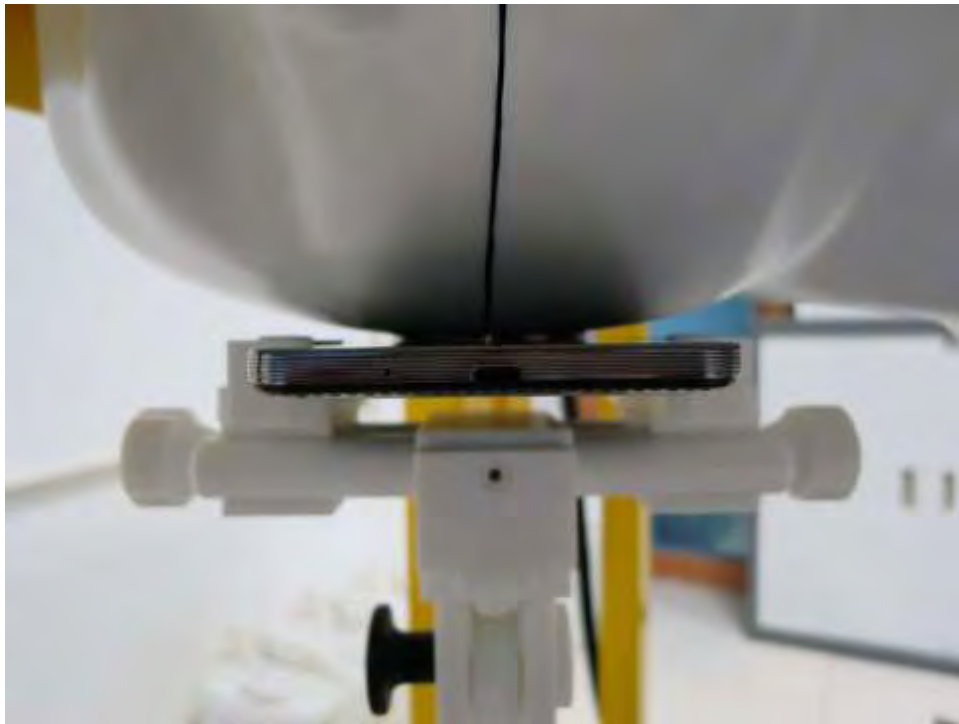

RIGHT-TILT 15°



Body Back 5mm



Body Front 5mm



Body back with Headset



Body Back 10mm--Hotspot



Body Front 10mm—Hotspot



DEPTH OF THE LIQUID IN THE PHANTOM—ZOOM IN

Note : The position used in the measurement were according to IEEE 1528-2003

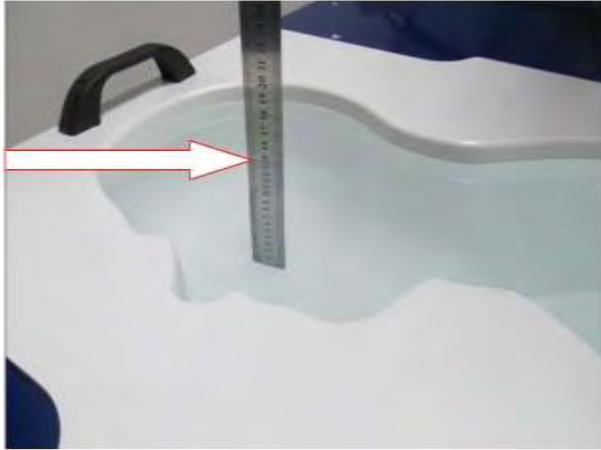

EUT PHOTOGRAPHS
TOTAL VIEW OF EUT



TOP VIEW OF EUT

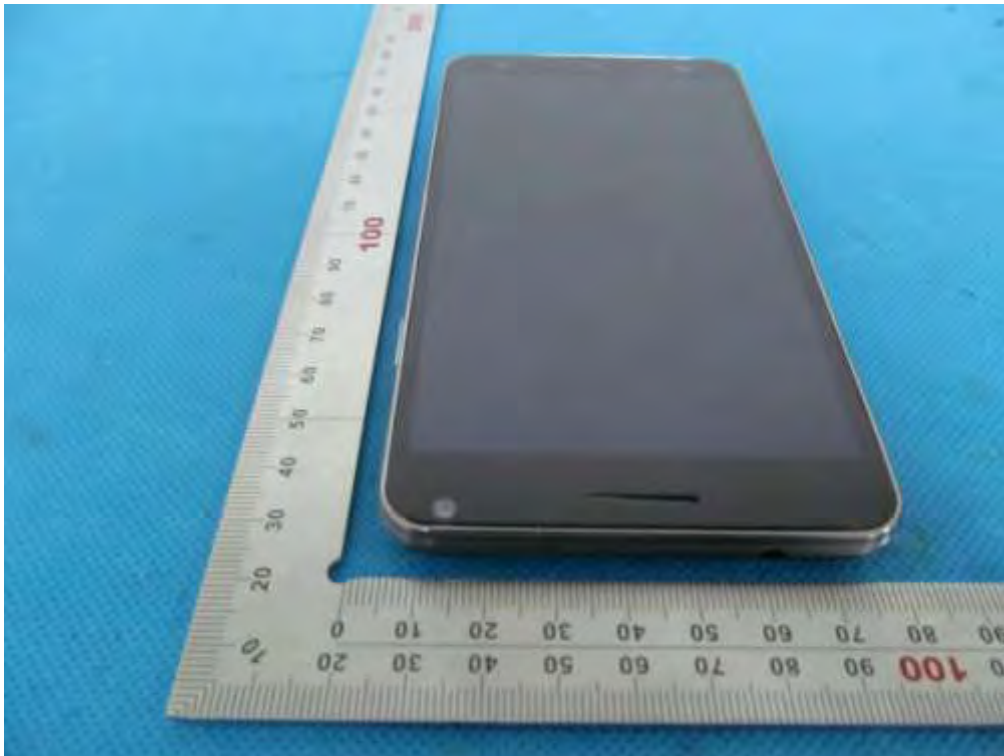

BOTTOM VIEW OF EUT

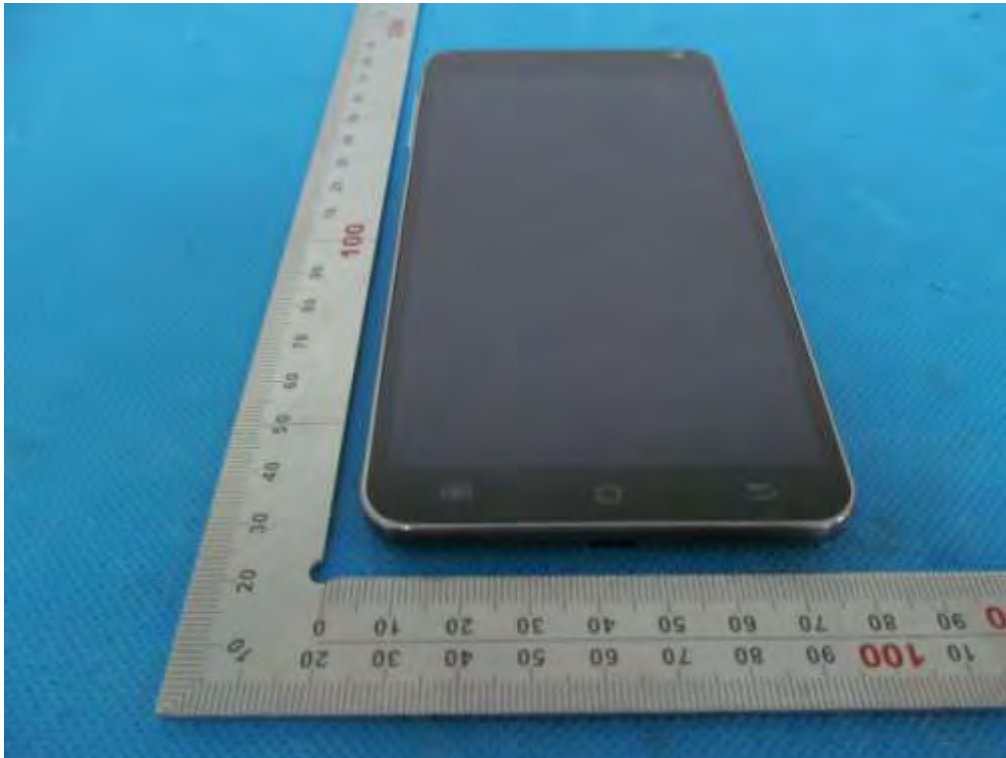

FRONT VIEW OF EUT



BACK VIEW OF EUT



LEFT VIEW OF EUT



RIGHT VIEW OF EUT

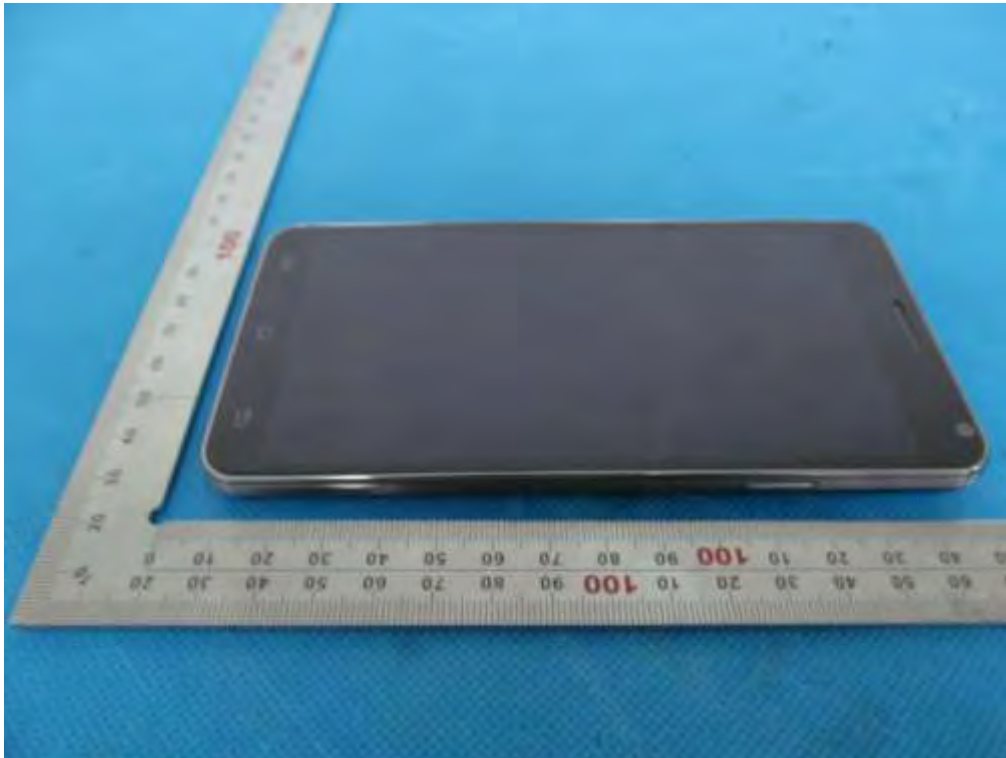

OPEN VIEW OF EUT-1



OPEN VIEW OF EUT-2



OPEN VIEW OF EUT-3



INTERNAL VIEW OF EUT-1

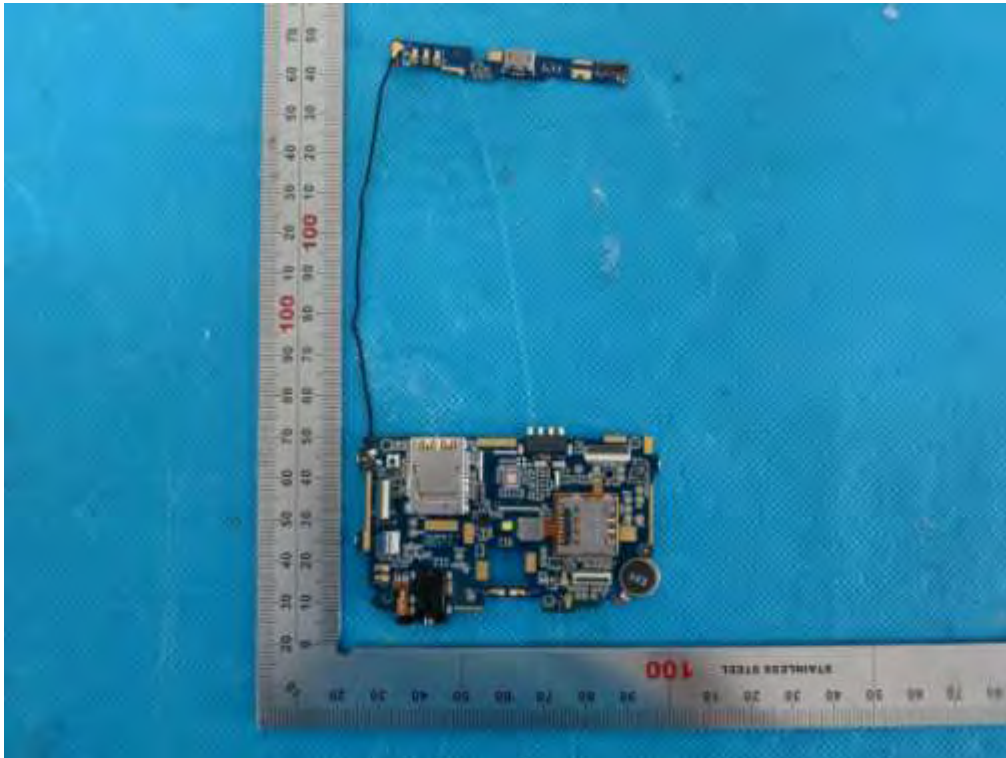

INTERNAL VIEW OF EUT-2

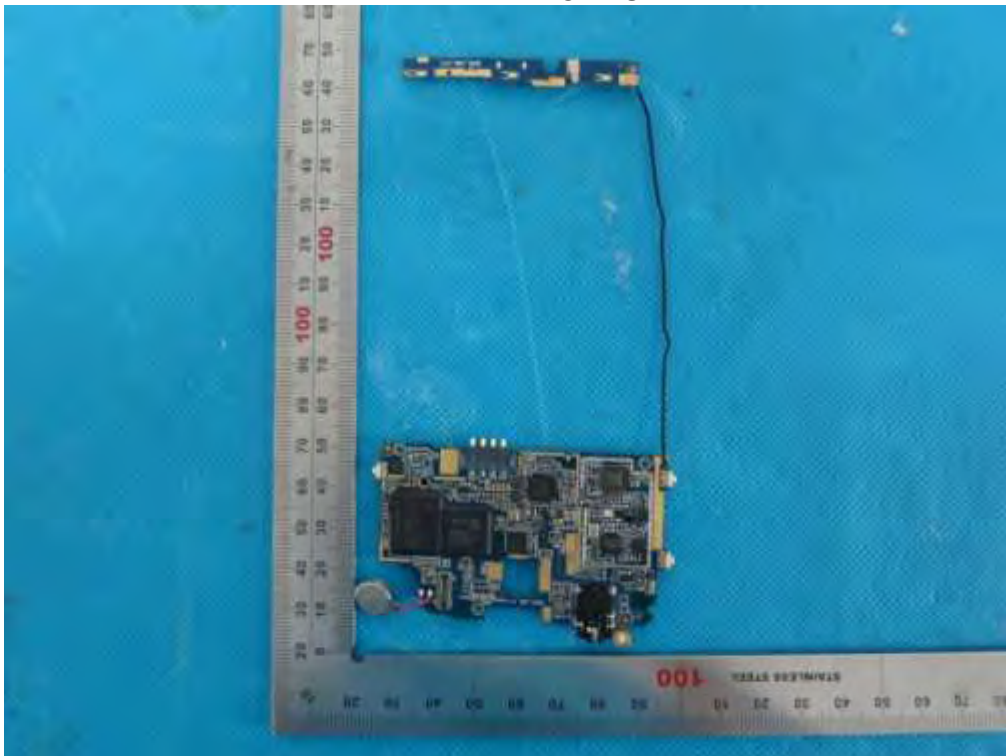

APPENDIX D. PROBE CALIBRATION DATA



COMOSAR E-Field Probe Calibration Report

Ref : ACR.351.1.14.SATU.A

ATTESTATION OF GLOBAL COMPLIANCE CO. LTD.

1&2F, NO.2 BUILDING, HUAFENG NO.1 INDUSTRIAL
PARK, GUSHU COMMUNITY XIXIANG STREET
BAOAN DISTRICT, SHENZHEN, P.R. CHINA

SATIMO COMOSAR DOSIMETRIC E-FIELD PROBE

SERIAL NO.: SN 22/12 EP159

Calibrated at SATIMO US
2105 Barrett Park Dr. - Kennesaw, GA 30144



01/12/14

Summary:

This document presents the method and results from an accredited COMOSAR Dosimetric E-Field Probe calibration performed in SATIMO USA using the CALISAR / CALIBAIR test bench, for use with a SATIMO COMOSAR system only. All calibration results are traceable to national metrology institutions.



COMOSAR E-FIELD PROBE CALIBRATION REPORT

Ref ACR.351.1.14 SATU A

	<i>Name</i>	<i>Function</i>	<i>Date</i>	<i>Signature</i>
<i>Prepared by :</i>	Jérôme LUC	Product Manager	1/12/2014	<i>JS</i>
<i>Checked by :</i>	Jérôme LUC	Product Manager	1/12/2014	<i>JS</i>
<i>Approved by :</i>	Kim RUTKOWSKI	Quality Manager	1/12/2014	<i>Kim Rutkowski</i>

	<i>Customer Name</i>
<i>Distribution :</i>	ATTESTATION OF GLOBAL COMPLIANCE CO. LTD.

<i>Issue</i>	<i>Date</i>	<i>Modifications</i>
A	1/12/2014	Initial release



TABLE OF CONTENTS

1	Device Under Test	4
2	Product Description.....	4
2.1	General Information	4
3	Measurement Method.....	4
3.1	Linearity	4
3.2	Sensitivity	5
3.3	Lower Detection Limit	5
3.4	Isotropy.....	5
3.5	Boundary Effect	5
4	Measurement Uncertainty	5
5	Calibration Measurement Results	6
5.1	Sensitivity in air	6
5.2	Linearity	7
5.3	Sensitivity in liquid	7
5.4	Isotropy.....	8
6	List of Equipment	10



1 DEVICE UNDER TEST

Device Under Test	
Device Type	COMOSAR DOSIMETRIC E FIELD PROBE
Manufacturer	Satimo
Model	SSE5
Serial Number	SN 22/12 EP159
Product Condition (new / used)	used
Frequency Range of Probe	0.3 GHz-3GHz
Resistance of Three Dipoles at Connector	Dipole 1: R1=0.230 MΩ Dipole 2: R2=0.226 MΩ Dipole 3: R3=0.231 MΩ

A yearly calibration interval is recommended.

2 PRODUCT DESCRIPTION

2.1 GENERAL INFORMATION

Satimo's COMOSAR E field Probes are built in accordance to the IEEE 1528, OET 65 Bulletin C and CEI/IEC 62209 standards.



Figure 1 – Satimo COMOSAR Dosimetric E field Dipole

Probe Length	330 mm
Length of Individual Dipoles	4.5 mm
Maximum external diameter	8 mm
Probe Tip External Diameter	5 mm
Distance between dipoles / probe extremity	2.7 mm

3 MEASUREMENT METHOD

The IEEE 1528, OET 65 Bulletin C, CENELEC EN50361 and CEI/IEC 62209 standards provide recommended practices for the probe calibrations, including the performance characteristics of interest and methods by which to assess their affect. All calibrations / measurements performed meet the fore mentioned standards.

3.1 LINEARITY

The evaluation of the linearity was done in free space using the waveguide, performing a power sweep to cover the SAR range 0.01W/kg to 100W/kg.



3.2 SENSITIVITY

The sensitivity factors of the three dipoles were determined using a two step calibration method (air and tissue simulating liquid) using waveguides as outlined in the standards.

3.3 LOWER DETECTION LIMIT

The lower detection limit was assessed using the same measurement set up as used for the linearity measurement. The required lower detection limit is 10 mW/kg.

3.4 ISOTROPY

The axial isotropy was evaluated by exposing the probe to a reference wave from a standard dipole with the dipole mounted under the flat phantom in the test configuration suggested for system validations and checks. The probe was rotated along its main axis from 0 - 360 degrees in 15 degree steps. The hemispherical isotropy is determined by inserting the probe in a thin plastic box filled with tissue-equivalent liquid, with the plastic box illuminated with the fields from a half wave dipole. The dipole is rotated about its axis (0°-180°) in 15° increments. At each step the probe is rotated about its axis (0°-360°).

3.5 BOUNDARY EFFECT

The boundary effect is defined as the deviation between the SAR measured data and the expected exponential decay in the liquid when the probe is oriented normal to the interface. To evaluate this effect, the liquid filled flat phantom is exposed to fields from either a reference dipole or waveguide. With the probe normal to the phantom surface, the peak spatial average SAR is measured and compared to the analytical value at the surface.

4 MEASUREMENT UNCERTAINTY

The guidelines outlined in the IEEE 1528, OET 65 Bulletin C, CENELEC EN50361 and CEI/IEC 62209 standards were followed to generate the measurement uncertainty associated with an E-field probe calibration using the waveguide technique. All uncertainties listed below represent an expanded uncertainty expressed at approximately the 95% confidence level using a coverage factor of k=2, traceable to the Internationally Accepted Guides to Measurement Uncertainty.

Uncertainty analysis of the probe calibration in waveguide					
ERROR SOURCES	Uncertainty value (%)	Probability Distribution	Divisor	ci	Standard Uncertainty (%)
Incident or forward power	3.00%	Rectangular	$\sqrt{3}$	1	1.732%
Reflected power	3.00%	Rectangular	$\sqrt{3}$	1	1.732%
Liquid conductivity	5.00%	Rectangular	$\sqrt{3}$	1	2.887%
Liquid permittivity	4.00%	Rectangular	$\sqrt{3}$	1	2.309%
Field homogeneity	3.00%	Rectangular	$\sqrt{3}$	1	1.732%
Field probe positioning	5.00%	Rectangular	$\sqrt{3}$	1	2.887%
Field probe linearity	3.00%	Rectangular	$\sqrt{3}$	1	1.732%



Combined standard uncertainty					5.831%
Expanded uncertainty 95 % confidence level k = 2					11.662%

5 CALIBRATION MEASUREMENT RESULTS

Calibration Parameters	
Liquid Temperature	21 °C
Lab Temperature	21 °C
Lab Humidity	45 %

5.1 SENSITIVITY IN AIR

Normx dipole 1 ($\mu\text{V}/(\text{V}/\text{m})^2$)	Normy dipole 2 ($\mu\text{V}/(\text{V}/\text{m})^2$)	Normz dipole 3 ($\mu\text{V}/(\text{V}/\text{m})^2$)
5.41	4.68	5.48

DCP dipole 1 (mV)	DCP dipole 2 (mV)	DCP dipole 3 (mV)
102	99	95

Calibration curves $e_i=f(V)$ ($i=1,2,3$) allow to obtain H-field value using the formula:

$$E = \sqrt{E_1^2 + E_2^2 + E_3^2}$$

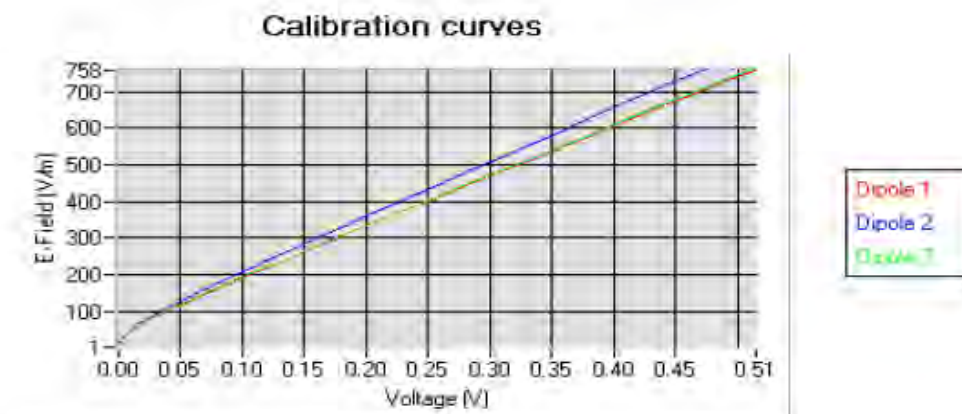



5.2 LINEARITY

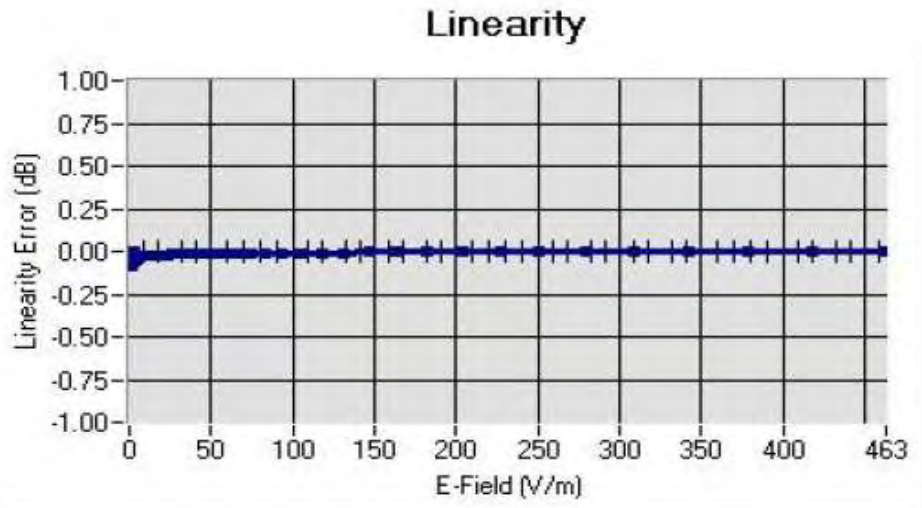

Linearity: $\pm 1.97\%$ ($\pm 0.09\text{dB}$)

5.3 SENSITIVITY IN LIQUID

Liquid	Frequency (MHz +/- 100MHz)*	Permittivity	Epsilon (S/m)	ConvF
HL300	300	45.27	0.85	4.60
BL300	300	58.01	0.94	4.68
HL450	450	42.87	0.89	4.71
BL450	450	56.37	0.93	4.83
HL850	835	41.12	0.91	5.27
BL850	835	55.03	0.97	5.48
HL900	900	40.77	0.98	5.20
BL900	900	55.49	1.04	5.28
HL1800	1750	39.22	1.38	4.58
BL1800	1750	53.27	1.51	4.71
HL1900	1880	39.54	1.41	4.51
BL1900	1880	52.88	1.55	4.45
HL2000	1950	38.97	1.45	4.31
BL2000	1950	52.01	1.58	4.33
HL2450	2450	39.17	1.85	4.42
BL2450	2450	52.47	1.99	4.31

LOWER DETECTION LIMIT: 9mW/kg



5.4 ISOTROPY

HL 900 MHz

- Axial isotropy: 0.04 dB
- Hemispherical isotropy: 0.08 dB

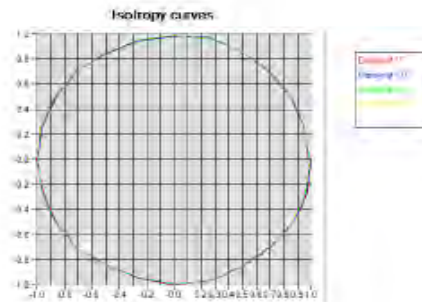

HL 1800 MHz

- Axial isotropy: 0.07 dB
- Hemispherical isotropy: 0.12 dB

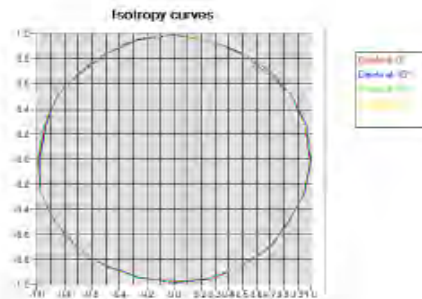



HL 2450 MHz

- Axial isotropy: 0.09 dB
- Hemispherical isotropy: 0.14 dB

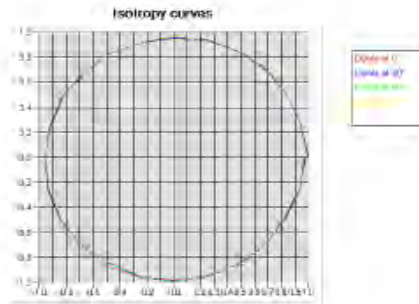



6 LIST OF EQUIPMENT

Equipment Summary Sheet				
Equipment Description	Manufacturer / Model	Identification No.	Current Calibration Date	Next Calibration Date
Flat Phantom	Satimo	SN-20/09-SAM71	Validated. No cal required.	Validated. No cal required.
COMOSAR Test Bench	Version 3	NA	Validated. No cal required.	Validated. No cal required.
Network Analyzer	Rhode & Schwarz ZVA	SN100132	02/2013	02/2016
Reference Probe	Satimo	EP 94 SN 37/08	Characterized prior to test. No cal required.	Characterized prior to test. No cal required.
Multimeter	Keithley 2000	1188656	11/2013	11/2016
Signal Generator	Agilent E4438C	MY49070581	12/2013	12/2016
Amplifier	Aethercomm	SN 046	Characterized prior to test. No cal required.	Characterized prior to test. No cal required.
Power Meter	HP E4416A	US38261498	11/2013	11/2016
Power Sensor	HP ECP-E26A	US37181460	11/2013	11/2016
Directional Coupler	Narda 4216-20	01386	Characterized prior to test. No cal required.	Characterized prior to test. No cal required.
Waveguide	Mega Industries	069Y7-158-13-712	Validated. No cal required.	Validated. No cal required.
Waveguide Transition	Mega Industries	069Y7-158-13-701	Validated. No cal required.	Validated. No cal required.
Waveguide Termination	Mega Industries	069Y7-158-13-701	Validated. No cal required.	Validated. No cal required.
Temperature / Humidity Sensor	Control Company	11-661-9	3/2012	3/2014

APPENDIX E. DIPOLE CALIBRATION DATA



SAR Reference Dipole Calibration Report

Ref: ACR.318.5.13.SATU.A

ATTESTATION OF GLOBAL COMPLIANCE CO. LTD.

**1&2F, NO.2 BUILDING, HUAFENG NO.1 INDUSTRIAL
PARK, GUSHU COMMUNITY XIXIANG STREET
BAOAN DISTRICT, SHENZHEN, P.R. CHINA**

SATIMO COMOSAR REFERENCE DIPOLE

FREQUENCY: 900 MHZ

SERIAL NO.: SN 46/11 DIP 0G900-185

Calibrated at SATIMO US

2105 Barrett Park Dr. - Kennesaw, GA 30144



11/14/13

Summary:

This document presents the method and results from an accredited SAR reference dipole calibration performed in SATIMO USA using the COMOSAR test bench. All calibration results are traceable to national metrology institutions.



	<i>Name</i>	<i>Function</i>	<i>Date</i>	<i>Signature</i>
<i>Prepared by :</i>	Jérôme LUC	Product Manager	11/14/2013	<i>JLS</i>
<i>Checked by :</i>	Jérôme LUC	Product Manager	11/14/2013	<i>JLS</i>
<i>Approved by :</i>	Kim RUTKOWSKI	Quality Manager	11/14/2013	<i>Kim Rutkowski</i>

	<i>Customer Name</i>
<i>Distribution :</i>	ATTESTATION OF GLOBAL COMPLIANCE CO. LTD.

<i>Issue</i>	<i>Date</i>	<i>Modifications</i>
A	11/14/2013	Initial release



TABLE OF CONTENTS

1	Introduction.....	4
2	Device Under Test.....	4
3	Product Description.....	4
3.1	General Information.....	4
4	Measurement Method.....	5
4.1	Return Loss Requirements.....	5
4.2	Mechanical Requirements.....	5
5	Measurement Uncertainty.....	5
5.1	Return Loss.....	5
5.2	Dimension Measurement.....	5
5.3	Validation Measurement.....	5
6	Calibration Measurement Results.....	6
6.1	Return Loss and Impedance.....	6
6.2	Mechanical Dimensions.....	6
7	Validation measurement.....	7
7.1	Measurement Condition.....	7
7.2	Head Liquid Measurement.....	7
7.3	Measurement Result.....	8
7.4	Body Measurement Result.....	9
8	List of Equipment.....	10



1 INTRODUCTION

This document contains a summary of the requirements set forth by the IEEE 1528, OET 65 Bulletin C and CEI/IEC 62209 standards for reference dipoles used for SAR measurement system validations and the measurements that were performed to verify that the product complies with the fore mentioned standards.

2 DEVICE UNDER TEST

Device Under Test	
Device Type	COMOSAR 900 MHz REFERENCE DIPOLE
Manufacturer	Satimo
Model	SID900
Serial Number	SN 46/11 DIP 0G900-185
Product Condition (new / used)	Used

A yearly calibration interval is recommended.

3 PRODUCT DESCRIPTION

3.1 GENERAL INFORMATION

Satimo's COMOSAR Validation Dipoles are built in accordance to the IEEE 1528, OET 65 Bulletin C and CEI/IEC 62209 standards. The product is designed for use with the COMOSAR test bench only.



Figure 1 – Satimo COMOSAR Validation Dipole



4 MEASUREMENT METHOD

The IEEE 1528, OET 65 Bulletin C and CEI/IEC 62209 standards provide requirements for reference dipoles used for system validation measurements. The following measurements were performed to verify that the product complies with the fore mentioned standards.

4.1 RETURN LOSS REQUIREMENTS

The dipole used for SAR system validation measurements and checks must have a return loss of -20 dB or better. The return loss measurement shall be performed against a liquid filled flat phantom, with the phantom constructed as outlined in the fore mentioned standards.

4.2 MECHANICAL REQUIREMENTS

The IEEE Std. 1528 and CEI/IEC 62209 standards specify the mechanical components and dimensions of the validation dipoles, with the dimensions frequency and phantom shell thickness dependent. The COMOSAR test bench employs a 2 mm phantom shell thickness therefore the dipoles sold for use with the COMOSAR test bench comply with the requirements set forth for a 2 mm phantom shell thickness.

5 MEASUREMENT UNCERTAINTY

All uncertainties listed below represent an expanded uncertainty expressed at approximately the 95% confidence level using a coverage factor of k=2, traceable to the Internationally Accepted Guides to Measurement Uncertainty.

5.1 RETURN LOSS

The following uncertainties apply to the return loss measurement:

Frequency band	Expanded Uncertainty on Return Loss
400-6000MHz	0.1 dB

5.2 DIMENSION MEASUREMENT

The following uncertainties apply to the dimension measurements:

Length (mm)	Expanded Uncertainty on Length
3 - 300	0.05 mm

5.3 VALIDATION MEASUREMENT

The guidelines outlined in the IEEE 1528, OET 65 Bulletin C, CENELEC EN50361 and CEI/IEC 62209 standards were followed to generate the measurement uncertainty for validation measurements.

Scan Volume	Expanded Uncertainty
1 g	20.3 %
10 g	20.1 %



6 CALIBRATION MEASUREMENT RESULTS

6.1 RETURN LOSS AND IMPEDANCE

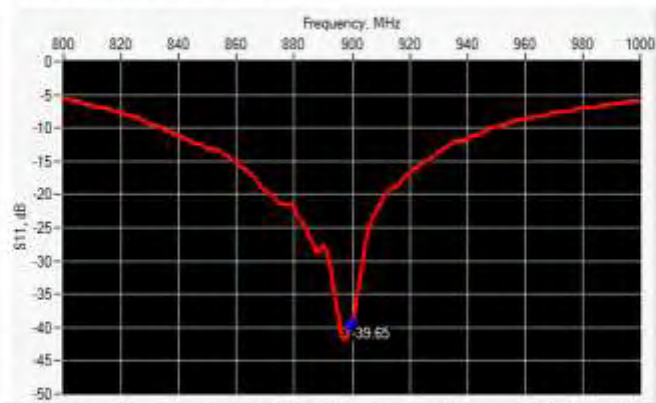

Frequency (MHz)	Return Loss (dB)	Requirement (dB)	Impedance
900	-39.65	-20	50.5 Ω - 1.1 j Ω

6.2 MECHANICAL DIMENSIONS

Frequency MHz	L mm		h mm		d mm	
	required	measured	required	measured	required	measured
300	420.0 \pm 1 %		250.0 \pm 1 %		6.35 \pm 1 %	
450	290.0 \pm 1 %		166.7 \pm 1 %		6.35 \pm 1 %	
750	176.0 \pm 1 %		100.0 \pm 1 %		6.35 \pm 1 %	
895	161.0 \pm 1 %		89.8 \pm 1 %		3.6 \pm 1 %	
900	149.0 \pm 1 %	PASS	83.3 \pm 1 %	PASS	3.6 \pm 1 %	PASS
1450	89.1 \pm 1 %		51.7 \pm 1 %		3.6 \pm 1 %	
1500	80.5 \pm 1 %		50.0 \pm 1 %		3.6 \pm 1 %	
1640	79.0 \pm 1 %		45.7 \pm 1 %		3.6 \pm 1 %	
1750	75.2 \pm 1 %		42.9 \pm 1 %		3.6 \pm 1 %	
1800	72.0 \pm 1 %		41.7 \pm 1 %		3.6 \pm 1 %	
1900	68.0 \pm 1 %		39.5 \pm 1 %		3.6 \pm 1 %	
1950	66.3 \pm 1 %		38.5 \pm 1 %		3.6 \pm 1 %	
2000	64.5 \pm 1 %		37.5 \pm 1 %		3.6 \pm 1 %	
2100	61.0 \pm 1 %		35.7 \pm 1 %		3.6 \pm 1 %	
2300	55.5 \pm 1 %		32.6 \pm 1 %		3.6 \pm 1 %	
2450	51.5 \pm 1 %		30.4 \pm 1 %		3.6 \pm 1 %	
2600	48.5 \pm 1 %		28.8 \pm 1 %		3.6 \pm 1 %	
3000	41.5 \pm 1 %		25.0 \pm 1 %		3.6 \pm 1 %	
3500	37.0 \pm 1 %		26.4 \pm 1 %		3.6 \pm 1 %	
3700	34.7 \pm 1 %		26.4 \pm 1 %		3.6 \pm 1 %	



7 VALIDATION MEASUREMENT

The IEEE Std. 1528, OET 65 Bulletin C and CEI/IEC 62209 standards state that the system validation measurements must be performed using a reference dipole meeting the fore mentioned return loss and mechanical dimension requirements. The validation measurement must be performed against a liquid filled flat phantom, with the phantom constructed as outlined in the fore mentioned standards. Per the standards, the dipole shall be positioned below the bottom of the phantom, with the dipole length centered and parallel to the longest dimension of the flat phantom, with the top surface of the dipole at the described distance from the bottom surface of the phantom.

7.1 MEASUREMENT CONDITION

Software	OPENSAR V4
Phantom	SN 20/09 SAM71
Probe	SN 18/11 EP3122
Liquid	Head Liquid Values: $\epsilon_p \approx 41.8$ $\sigma_p \approx 0.96$
Distance between dipole center and liquid	15.0 mm
Area scan resolution	$dx=8mm/dy=8mm$
Zoon Scan Resolution	$dx=8mm/dy=8m/dz=5mm$
Frequency	900 MHz
Input power	20 dBm
Liquid Temperature	21 °C
Lab Temperature	21 °C
Lab Humidity	45 %

7.2 HEAD LIQUID MEASUREMENT

Frequency MHz	Relative permittivity (ϵ_r)		Conductivity (σ) S/m	
	required	measured	required	measured
300	45.3 ± 5 %		0.87 ± 5 %	
450	43.5 ± 5 %		0.87 ± 5 %	
750	41.9 ± 5 %		0.89 ± 5 %	
835	41.5 ± 5 %		0.90 ± 5 %	
900	41.5 ± 5 %	PASS	0.97 ± 5 %	PASS
1450	40.5 ± 5 %		1.20 ± 5 %	
1500	40.4 ± 5 %		1.23 ± 5 %	
1640	40.2 ± 5 %		1.31 ± 5 %	
1750	40.1 ± 5 %		1.37 ± 5 %	
1800	40.0 ± 5 %		1.40 ± 5 %	
1900	40.0 ± 5 %		1.40 ± 5 %	
1950	40.0 ± 5 %		1.40 ± 5 %	
2000	40.0 ± 5 %		1.40 ± 5 %	
2100	39.8 ± 5 %		1.49 ± 5 %	
2300	39.5 ± 5 %		1.67 ± 5 %	
2450	39.2 ± 5 %		1.80 ± 5 %	
2600	39.0 ± 5 %		1.96 ± 5 %	
3000	38.5 ± 5 %		2.40 ± 5 %	
3500	37.9 ± 5 %		2.91 ± 5 %	

Page: 7/10

This document shall not be reproduced, except in full or in part, without the written approval of SATIMO. The information contained herein is to be used only for the purpose for which it is submitted and is not to be released in whole or part without written approval of SATIMO.



7.3 MEASUREMENT RESULT

The IEEE Std. 1528 and CEI/IEC 62209 standards state that the system validation measurements should produce the SAR values shown below (for phantom thickness of 2 mm), within the uncertainty for the system validation. All SAR values are normalized to 1 W forward power. In bracket, the measured SAR is given with the used input power.

Frequency MHz	1 g SAR (W/kg/W)		10 g SAR (W/kg/W)	
	required	measured	required	measured
300	2.85		1.94	
450	4.58		3.06	
750	8.49		5.55	
835	9.56		6.22	
900	10.9	10.70 (1.07)	6.99	6.72 (0.67)
1450	29		16	
1500	30.5		16.8	
1640	34.2		18.4	
1750	36.4		19.3	
1800	38.4		20.1	
1900	39.7		20.5	
1950	40.5		20.9	
2000	41.1		21.1	
2100	43.6		21.9	
2300	48.7		23.3	
2450	52.4		24	
2600	55.3		24.6	
3000	63.8		25.7	
3500	67.1		25	

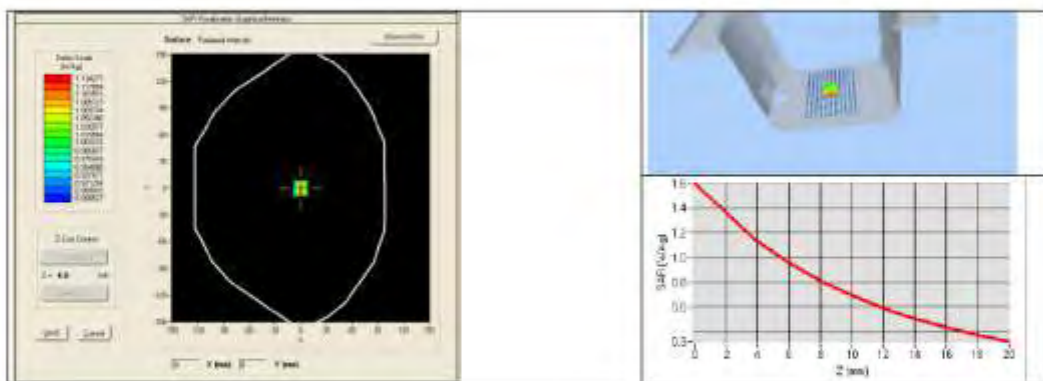



7.4 BODY MEASUREMENT RESULT

Software	OPENSAR V4
Phantom	SN 20/09 SAM71
Probe	SN 18/11 EPG122
Liquid	Body Liquid Values: ϵ_{ps} : 56.0 σ : 1.04
Distance between dipole center and liquid	15.0 mm
Area scan resolution	$dx=8mm/dy=8mm$
Zoon Scan Resolution	$dx=8mm/dy=8mm/dz=5mm$
Frequency	900 MHz
Input power	20 dBm
Liquid Temperature	21 °C
Lab Temperature	21 °C
Lab Humidity	45 %

Frequency MHz	1 g SAR (W/kg/W)	10 g SAR (W/kg/W)
	measured	measured
900	11.27 (1.13)	7.18 (0.72)

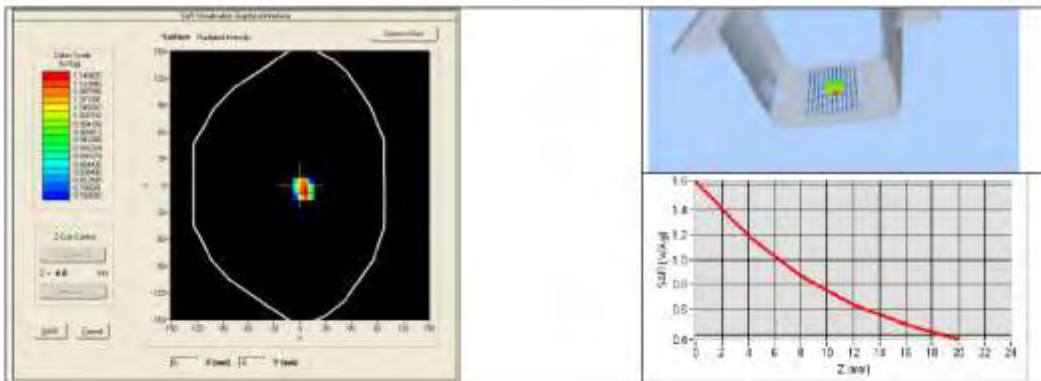



8 LIST OF EQUIPMENT

Equipment Summary Sheet				
Equipment Description	Manufacturer / Model	Identification No.	Current Calibration Date	Next Calibration Date
SAM Phantom	Satimo	SN-20/09-SAM71	Validated. No cal required.	Validated. No cal required.
CÓMÓSTAR Test Bench	Version 3	NA	Validated. No cal required.	Validated. No cal required.
Network Analyzer	Rhode & Schwarz ZVA	SN100132	02/2013	02/2016
Calipers	Camera	CALIPER-01	12/2010	12/2013
Reference Probe	Satimo	EPG122 SN 18/11	Characterized prior to test. No cal required.	Characterized prior to test. No cal required.
Multimeter	Keithley 2000	1188656	11/2010	11/2013
Signal Generator	Agilent E4438C	MY49070581	12/2010	12/2013
Amplifier	Aethercomm	SN 046	Characterized prior to test. No cal required.	Characterized prior to test. No cal required.
Power Meter	HP E4418A	US38261498	11/2010	11/2013
Power Sensor	HP ECP-E26A	US37181460	11/2010	11/2013
Directional Coupler	Narda 4216-20	01386	Characterized prior to test. No cal required.	Characterized prior to test. No cal required.
Temperature and Humidity Sensor	Control Company	11-661-9	3/2012	3/2014



SAR Reference Dipole Calibration Report

Ref: ACR.318.7.13.SATU.A

ATTESTATION OF GLOBAL COMPLIANCE CO. LTD.

**1&2F, NO.2 BUILDING, HUA FENG NO.1 INDUSTRIAL
PARK, GUSHU COMMUNITY XIXIANG STREET
BAOAN DISTRICT, SHENZHEN, P.R. CHINA
SATIMO COMOSAR REFERENCE DIPOLE
FREQUENCY: 1900 MHZ
SERIAL NO.: SN 46/11 DIP 1G900-187**

**Calibrated at SATIMO US
2105 Barrett Park Dr. - Kennesaw, GA 30144**



11/14/13

Summary:

This document presents the method and results from an accredited SAR reference dipole calibration performed in SATIMO USA using the COMOSAR test bench. All calibration results are traceable to national metrology institutions.



	<i>Name</i>	<i>Function</i>	<i>Date</i>	<i>Signature</i>
<i>Prepared by :</i>	Jérôme LUC	Product Manager	11/14/2013	<i>JS</i>
<i>Checked by :</i>	Jérôme LUC	Product Manager	11/14/2013	<i>JS</i>
<i>Approved by :</i>	Kim RUTKOWSKI	Quality Manager	11/14/2013	<i>Kim Rutkowski</i>

	<i>Customer Name</i>
<i>Distribution :</i>	ATTESTATION OF GLOBAL COMPLIANCE CO. LTD.

<i>Issue</i>	<i>Date</i>	<i>Modifications</i>
A	11/14/2013	Initial release



TABLE OF CONTENTS

1	Introduction.....	4
2	Device Under Test.....	4
3	Product Description	4
3.1	General Information	4
4	Measurement Method	5
4.1	Return Loss Requirements	5
4.2	Mechanical Requirements	5
5	Measurement Uncertainty.....	5
5.1	Return Loss	5
5.2	Dimension Measurement	5
5.3	Validation Measurement	5
6	Calibration Measurement Results.....	6
6.1	Return Loss and Impedance	6
6.2	Mechanical Dimensions	6
7	Validation measurement	7
7.1	Measurement Condition	7
7.2	Head Liquid Measurement	7
7.3	Measurement Result	8
7.4	Body Measurement Result	9
8	List of Equipment	10



1 INTRODUCTION

This document contains a summary of the requirements set forth by the IEEE 1528, OET 65 Bulletin C and CEI/IEC 62209 standards for reference dipoles used for SAR measurement system validations and the measurements that were performed to verify that the product complies with the fore mentioned standards.

2 DEVICE UNDER TEST

Device Under Test	
Device Type	COMOSAR 1900 MHz REFERENCE DIPOLE
Manufacturer	Satimo
Model	SID1900
Serial Number	SN 46/11 DIP 1G900-187
Product Condition (new / used)	Used

A yearly calibration interval is recommended.

3 PRODUCT DESCRIPTION

3.1 GENERAL INFORMATION

Satimo's COMOSAR Validation Dipoles are built in accordance to the IEEE 1528, OET 65 Bulletin C and CEI/IEC 62209 standards. The product is designed for use with the COMOSAR test bench only.



Figure 1 – Satimo COMOSAR Validation Dipole



4 MEASUREMENT METHOD

The IEEE 1528, OET 65 Bulletin C and CEI/IEC 62209 standards provide requirements for reference dipoles used for system validation measurements. The following measurements were performed to verify that the product complies with the fore mentioned standards.

4.1 RETURN LOSS REQUIREMENTS

The dipole used for SAR system validation measurements and checks must have a return loss of -20 dB or better. The return loss measurement shall be performed against a liquid filled flat phantom, with the phantom constructed as outlined in the fore mentioned standards.

4.2 MECHANICAL REQUIREMENTS

The IEEE Std. 1528 and CEI/IEC 62209 standards specify the mechanical components and dimensions of the validation dipoles, with the dimensions frequency and phantom shell thickness dependent. The COMOSAR test bench employs a 2 mm phantom shell thickness therefore the dipoles sold for use with the COMOSAR test bench comply with the requirements set forth for a 2 mm phantom shell thickness.

5 MEASUREMENT UNCERTAINTY

All uncertainties listed below represent an expanded uncertainty expressed at approximately the 95% confidence level using a coverage factor of $k=2$, traceable to the Internationally Accepted Guides to Measurement Uncertainty.

5.1 RETURN LOSS

The following uncertainties apply to the return loss measurement:

Frequency band	Expanded Uncertainty on Return Loss
400-6000MHz	0.1 dB

5.2 DIMENSION MEASUREMENT

The following uncertainties apply to the dimension measurements:

Length (mm)	Expanded Uncertainty on Length
3 - 300	0.05 mm

5.3 VALIDATION MEASUREMENT

The guidelines outlined in the IEEE 1528, OET 65 Bulletin C, CENELEC EN50361 and CEI/IEC 62209 standards were followed to generate the measurement uncertainty for validation measurements.

Scan Volume	Expanded Uncertainty
1 g	20.3 %
10 g	20.1 %



6 CALIBRATION MEASUREMENT RESULTS

6.1 RETURN LOSS AND IMPEDANCE

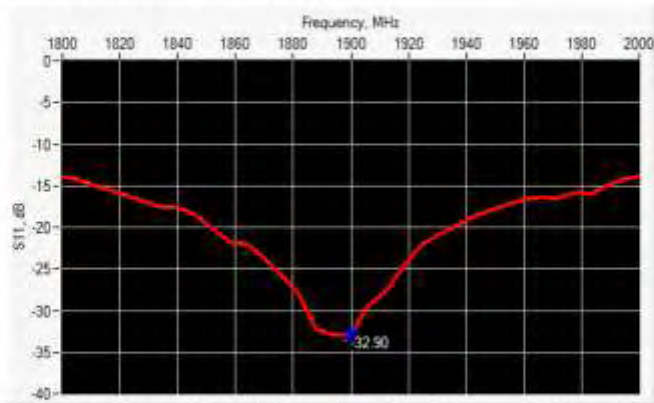

Frequency (MHz)	Return Loss (dB)	Requirement (dB)	Impedance
1900	-32.90	-20	48.9 Ω + 2.3 jΩ

6.2 MECHANICAL DIMENSIONS

Frequency MHz	L mm		h mm		d mm	
	required	measured	required	measured	required	measured
300	420.0 ±1 %		250.0 ±1 %		6.35 ±1 %	
450	290.0 ±1 %		166.7 ±1 %		6.35 ±1 %	
750	176.0 ±1 %		100.0 ±1 %		6.35 ±1 %	
835	161.0 ±1 %		89.0 ±1 %		3.6 ±1 %	
900	149.0 ±1 %		89.3 ±1 %		3.6 ±1 %	
1450	89.1 ±1 %		51.7 ±1 %		3.6 ±1 %	
1500	80.5 ±1 %		50.0 ±1 %		3.6 ±1 %	
1640	79.0 ±1 %		45.7 ±1 %		3.6 ±1 %	
1750	75.2 ±1 %		42.9 ±1 %		3.6 ±1 %	
1800	72.0 ±1 %		41.7 ±1 %		3.6 ±1 %	
1900	68.0 ±1 %	PASS	39.5 ±1 %	PASS	3.6 ±1 %	PASS
1950	66.3 ±1 %		38.5 ±1 %		3.6 ±1 %	
2000	64.5 ±1 %		37.5 ±1 %		3.6 ±1 %	
2100	61.0 ±1 %		35.7 ±1 %		3.6 ±1 %	
2300	55.5 ±1 %		32.6 ±1 %		3.6 ±1 %	
2450	51.5 ±1 %		30.4 ±1 %		3.6 ±1 %	
2600	48.5 ±1 %		28.8 ±1 %		3.6 ±1 %	
3000	41.5 ±1 %		25.0 ±1 %		3.6 ±1 %	
3500	37.0 ±1 %		26.4 ±1 %		3.6 ±1 %	
3700	34.7 ±1 %		26.4 ±1 %		3.6 ±1 %	



7 VALIDATION MEASUREMENT

The IEEE Std. 1528, OET 65 Bulletin C and CEI/IEC 62209 standards state that the system validation measurements must be performed using a reference dipole meeting the fore mentioned return loss and mechanical dimension requirements. The validation measurement must be performed against a liquid filled flat phantom, with the phantom constructed as outlined in the fore mentioned standards. Per the standards, the dipole shall be positioned below the bottom of the phantom, with the dipole length centered and parallel to the longest dimension of the flat phantom, with the top surface of the dipole at the described distance from the bottom surface of the phantom.

7.1 MEASUREMENT CONDITION

Software	OPENSAR V4
Phantom	SN 20/09 SAM71
Probe	SN 18/11 EPG122
Liquid	Head Liquid Values: $\epsilon_{ps}' : 39.8$ $\sigma : 1.43$
Distance between dipole center and liquid	10.0 mm
Area scan resolution	$dx=8mm/dy=8mm$
Zoon Scan Resolution	$dx=8mm/dy=8m/dz=5mm$
Frequency	1900 MHz
Input power	20 dBm
Liquid Temperature	21 °C
Lab Temperature	21 °C
Lab Humidity	45 %

7.2 HEAD LIQUID MEASUREMENT

Frequency MHz	Relative permittivity (ϵ_r')		Conductivity (σ) S/m	
	required	measured	required	measured
300	45.3 ±5 %		0.87 ±5 %	
450	43.5 ±5 %		0.87 ±5 %	
750	41.9 ±5 %		0.89 ±5 %	
835	41.5 ±5 %		0.90 ±5 %	
900	41.5 ±5 %		0.97 ±5 %	
1450	40.5 ±5 %		1.20 ±5 %	
1500	40.4 ±5 %		1.23 ±5 %	
1640	40.2 ±5 %		1.31 ±5 %	
1750	40.1 ±5 %		1.37 ±5 %	
1800	40.0 ±5 %		1.40 ±5 %	
1900	40.0 ±5 %	PASS	1.40 ±5 %	PASS
1950	40.0 ±5 %		1.40 ±5 %	
2000	40.0 ±5 %		1.40 ±5 %	
2100	39.8 ±5 %		1.49 ±5 %	
2300	39.5 ±5 %		1.67 ±5 %	
2450	39.2 ±5 %		1.80 ±5 %	
2600	39.0 ±5 %		1.96 ±5 %	
3000	38.5 ±5 %		2.40 ±5 %	
3500	37.9 ±5 %		2.91 ±5 %	

Page: 7/10

This document shall not be reproduced, except in full or in part, without the written approval of SATIMO. The information contained herein is to be used only for the purpose for which it is submitted and is not to be released in whole or part without written approval of SATIMO.



7.3 MEASUREMENT RESULT

The IEEE Std. 1528 and CEI/IEC 62209 standards state that the system validation measurements should produce the SAR values shown below (for phantom thickness of 2 mm), within the uncertainty for the system validation. All SAR values are normalized to 1 W forward power. In bracket, the measured SAR is given with the used input power.

Frequency MHz	1 g SAR (W/kg/W)		10 g SAR (W/kg/W)	
	required	measured	required	measured
300	2.85		1.94	
450	4.58		3.06	
750	8.49		5.55	
835	9.56		6.22	
900	10.9		6.99	
1450	29		16	
1500	30.5		16.8	
1640	34.2		18.4	
1750	36.4		19.3	
1800	38.4		20.1	
1900	39.7	39.65 (3.96)	20.5	20.24 (2.02)
1950	40.5		20.9	
2000	41.1		21.1	
2100	43.6		21.9	
2300	48.7		23.3	
2450	52.4		24	
2600	55.3		24.6	
3000	63.8		25.7	
3500	67.1		25	

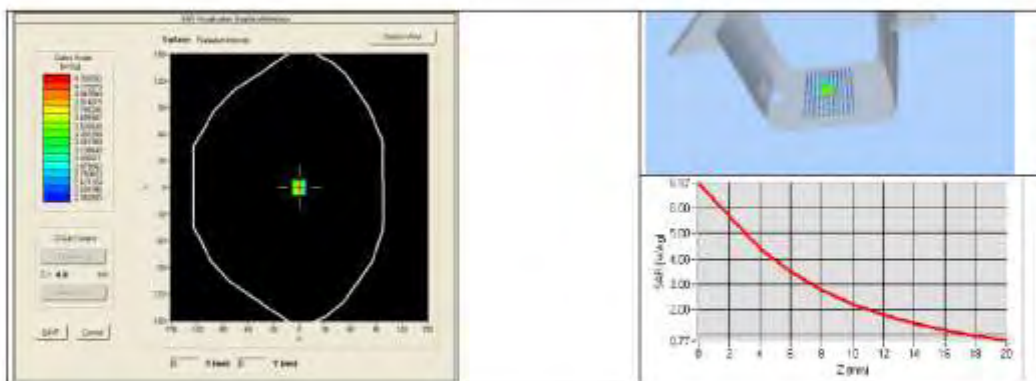



7.4 BODY MEASUREMENT RESULT

Software	OPENSAR V4
Phantom	SN 20/09 SAM71
Probe	SN 18/11 EPG122
Liquid	Body Liquid Values: $\epsilon_p \sigma'$: 52.5 σ'' : 1.50
Distance between dipole center and liquid	10.0 mm
Area scan resolution	$dx=8mm/dy=8mm$
Zoon Scan Resolution	$dx=8mm/dy=8m/dz=5mm$
Frequency	1900 MHz
Input power	20 dBm
Liquid Temperature	21 °C
Lab Temperature	21 °C
Lab Humidity	45 %

Frequency MHz	1 g SAR (W/kg/W)	10 g SAR (W/kg/W)
	measured	measured
1900	40.74 (4.07)	21.43 (2.14)

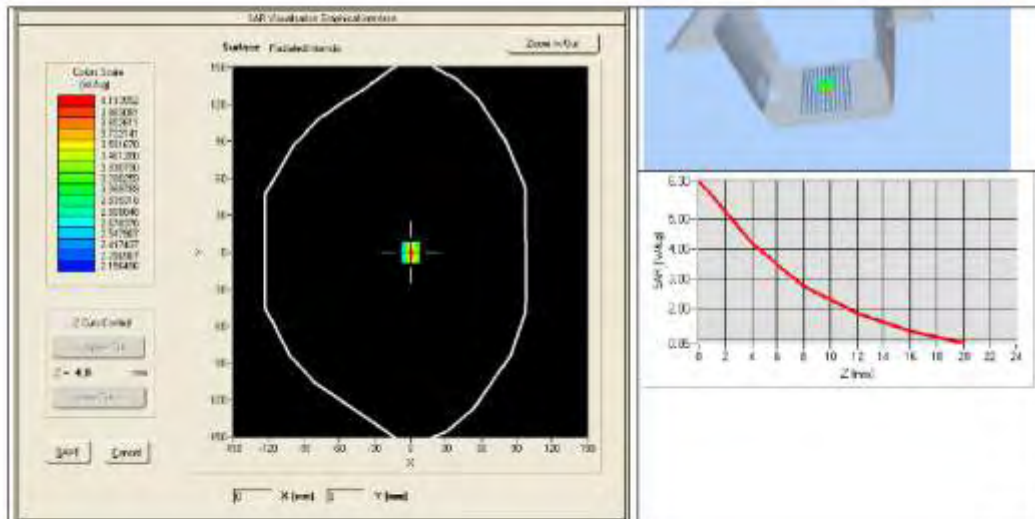



8 LIST OF EQUIPMENT

Equipment Summary Sheet				
Equipment Description	Manufacturer / Model	Identification No.	Current Calibration Date	Next Calibration Date
SAM Phantom	Satimo	SN-20/09-SAM71	Validated. No cal required.	Validated. No cal required.
COMOSAR Test Bench	Version 3	NA	Validated. No cal required.	Validated. No cal required.
Network Analyzer	Rhode & Schwarz ZVA	SN100132	02/2013	02/2016
Calipers	Carrera	CALIPER-01	12/2010	12/2013
Reference Probe	Satimo	EPG122 SN 18/11	Characterized prior to test. No cal required.	Characterized prior to test. No cal required.
Multimeter	Keithley 2000	1188656	11/2010	11/2013
Signal Generator	Agilent E4438C	MY49070581	12/2010	12/2013
Amplifier	Aethercomm	SN 046	Characterized prior to test. No cal required.	Characterized prior to test. No cal required.
Power Meter	HP E4418A	US38261498	11/2010	11/2013
Power Sensor	HP ECP-E26A	US37181460	11/2010	11/2013
Directional Coupler	Narda 4216-20	01386	Characterized prior to test. No cal required.	Characterized prior to test. No cal required.
Temperature and Humidity Sensor	Control Company	11-661-9	3/2012	3/2014



SAR Reference Dipole Calibration Report

Ref: ACR.318.9.13.SATU.A

ATTESTATION OF GLOBAL COMPLIANCE CO. LTD.

**1&2F, NO.2 BUILDING, HUA FENG NO.1 INDUSTRIAL
PARK, GUSHU COMMUNITY XIXIANG STREET
BAOAN DISTRICT, SHENZHEN, P.R. CHINA
SATIMO COMOSAR REFERENCE DIPOLE
FREQUENCY: 2450 MHZ
SERIAL NO.: SN 46/11 DIP 2G450-189**

**Calibrated at SATIMO US
2105 Barrett Park Dr. - Kennesaw, GA 30144**



11/14/13

Summary:

This document presents the method and results from an accredited SAR reference dipole calibration performed in SATIMO USA using the COMOSAR test bench. All calibration results are traceable to national metrology institutions.



	<i>Name</i>	<i>Function</i>	<i>Date</i>	<i>Signature</i>
<i>Prepared by :</i>	Jérôme LUC	Product Manager	11/14/2013	<i>JS</i>
<i>Checked by :</i>	Jérôme LUC	Product Manager	11/14/2013	<i>JS</i>
<i>Approved by :</i>	Kim RUTKOWSKI	Quality Manager	11/14/2013	<i>Kim Rutkowski</i>

	<i>Customer Name</i>
<i>Distribution :</i>	ATTESTATION OF GLOBAL COMPLIANCE CO. LTD.

<i>Issue</i>	<i>Date</i>	<i>Modifications</i>
A	11/14/2013	Initial release



TABLE OF CONTENTS

1	Introduction.....	4
2	Device Under Test	4
3	Product Description	4
3.1	General Information	4
4	Measurement Method	5
4.1	Return Loss Requirements	5
4.2	Mechanical Requirements	5
5	Measurement Uncertainty.....	5
5.1	Return Loss	5
5.2	Dimension Measurement	5
5.3	Validation Measurement	5
6	Calibration Measurement Results.....	6
6.1	Return Loss and Impedance	6
6.2	Mechanical Dimensions	6
7	Validation measurement	7
7.1	Measurement Condition	7
7.2	Head Liquid Measurement	7
7.3	Measurement Result	8
7.4	Body Measurement Result	9
8	List of Equipment	10



1 INTRODUCTION

This document contains a summary of the requirements set forth by the IEEE 1528, OET 65 Bulletin C and CEI/IEC 62209 standards for reference dipoles used for SAR measurement system validations and the measurements that were performed to verify that the product complies with the fore mentioned standards.

2 DEVICE UNDER TEST

Device Under Test	
Device Type	COMOSAR 2450 MHz REFERENCE DIPOLE
Manufacturer	Satimo
Model	SID2450
Serial Number	SN 46/11 DIP 2G450-189
Product Condition (new / used)	Used

A yearly calibration interval is recommended.

3 PRODUCT DESCRIPTION

3.1 GENERAL INFORMATION

Satimo's COMOSAR Validation Dipoles are built in accordance to the IEEE 1528, OET 65 Bulletin C and CEI/IEC 62209 standards. The product is designed for use with the COMOSAR test bench only.



Figure 1 – Satimo COMOSAR Validation Dipole



4 MEASUREMENT METHOD

The IEEE 1528, OET 65 Bulletin C and CEI/IEC 62209 standards provide requirements for reference dipoles used for system validation measurements. The following measurements were performed to verify that the product complies with the fore mentioned standards.

4.1 RETURN LOSS REQUIREMENTS

The dipole used for SAR system validation measurements and checks must have a return loss of -20 dB or better. The return loss measurement shall be performed against a liquid filled flat phantom, with the phantom constructed as outlined in the fore mentioned standards.

4.2 MECHANICAL REQUIREMENTS

The IEEE Std. 1528 and CEI/IEC 62209 standards specify the mechanical components and dimensions of the validation dipoles, with the dimensions frequency and phantom shell thickness dependent. The COMOSAR test bench employs a 2 mm phantom shell thickness therefore the dipoles sold for use with the COMOSAR test bench comply with the requirements set forth for a 2 mm phantom shell thickness.

5 MEASUREMENT UNCERTAINTY

All uncertainties listed below represent an expanded uncertainty expressed at approximately the 95% confidence level using a coverage factor of $k=2$, traceable to the Internationally Accepted Guides to Measurement Uncertainty.

5.1 RETURN LOSS

The following uncertainties apply to the return loss measurement:

Frequency band	Expanded Uncertainty on Return Loss
400-6000MHz	0.1 dB

5.2 DIMENSION MEASUREMENT

The following uncertainties apply to the dimension measurements:

Length (mm)	Expanded Uncertainty on Length
3 - 300	0.05 mm

5.3 VALIDATION MEASUREMENT

The guidelines outlined in the IEEE 1528, OET 65 Bulletin C, CENELEC EN50361 and CEI/IEC 62209 standards were followed to generate the measurement uncertainty for validation measurements.

Scan Volume	Expanded Uncertainty
1 g	20.3 %
10 g	20.1 %

Page: 5/10

*This document shall not be reproduced, except in full or in part, without the written approval of SATIMO.
The information contained herein is to be used only for the purpose for which it is submitted and is not to be released in whole or part without written approval of SATIMO.*



6 CALIBRATION MEASUREMENT RESULTS

6.1 RETURN LOSS AND IMPEDANCE

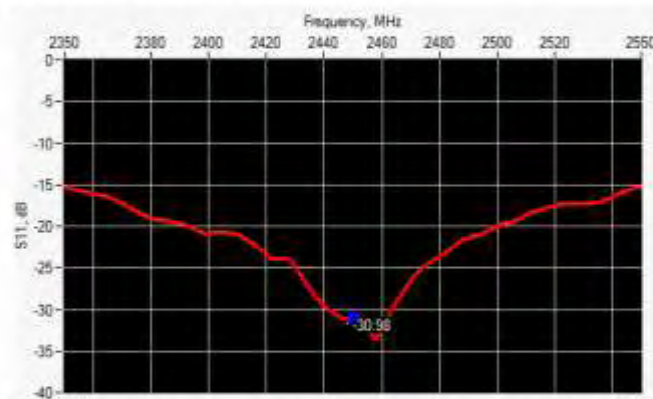

Frequency (MHz)	Return Loss (dB)	Requirement (dB)	Impedance
2450	-30.98	-20	$47.3 \Omega + 0.1 j\Omega$

6.2 MECHANICAL DIMENSIONS

Frequency MHz	L mm		h mm		d mm	
	required	measured	required	measured	required	measured
300	420.0 ± 1 %		250.0 ± 1 %		6.35 ± 1 %	
450	290.0 ± 1 %		166.7 ± 1 %		6.35 ± 1 %	
750	176.0 ± 1 %		100.0 ± 1 %		6.35 ± 1 %	
835	161.0 ± 1 %		89.8 ± 1 %		3.6 ± 1 %	
900	149.0 ± 1 %		83.3 ± 1 %		3.6 ± 1 %	
1450	89.1 ± 1 %		51.7 ± 1 %		3.6 ± 1 %	
1500	80.5 ± 1 %		50.0 ± 1 %		3.6 ± 1 %	
1640	79.0 ± 1 %		45.7 ± 1 %		3.6 ± 1 %	
1750	75.2 ± 1 %		42.9 ± 1 %		3.6 ± 1 %	
1800	72.0 ± 1 %		41.7 ± 1 %		3.6 ± 1 %	
1900	68.0 ± 1 %		39.5 ± 1 %		3.6 ± 1 %	
1950	66.3 ± 1 %		38.5 ± 1 %		3.6 ± 1 %	
2000	64.5 ± 1 %		37.5 ± 1 %		3.6 ± 1 %	
2100	61.0 ± 1 %		35.7 ± 1 %		3.6 ± 1 %	
2300	55.5 ± 1 %		32.6 ± 1 %		3.6 ± 1 %	
2450	51.5 ± 1 %	PASS	30.4 ± 1 %	PASS	3.6 ± 1 %	PASS
2600	48.5 ± 1 %		28.8 ± 1 %		3.6 ± 1 %	
3000	41.5 ± 1 %		25.0 ± 1 %		3.6 ± 1 %	
3500	37.0 ± 1 %		26.4 ± 1 %		3.6 ± 1 %	
3700	34.7 ± 1 %		26.4 ± 1 %		3.6 ± 1 %	



7 VALIDATION MEASUREMENT

The IEEE Std. 1528, OET 65 Bulletin C and CEI/IEC 62209 standards state that the system validation measurements must be performed using a reference dipole meeting the fore mentioned return loss and mechanical dimension requirements. The validation measurement must be performed against a liquid filled flat phantom, with the phantom constructed as outlined in the fore mentioned standards. Per the standards, the dipole shall be positioned below the bottom of the phantom, with the dipole length centered and parallel to the longest dimension of the flat phantom, with the top surface of the dipole at the described distance from the bottom surface of the phantom.

7.1 MEASUREMENT CONDITION

Software	OPENSAR V4
Phantom	SN 20/09 SAM71
Probe	SN 18/11 EPG122
Liquid	Head Liquid Values: $\epsilon_r' = 38.6$ $\sigma = 1.82$
Distance between dipole center and liquid	10.0 mm
Area scan resolution	$dx=8mm/dy=8mm$
Zoon Scan Resolution	$dx=8mm/dy=8m/dz=5mm$
Frequency	2450 MHz
Input power	20 dBm
Liquid Temperature	21 °C
Lab Temperature	21 °C
Lab Humidity	45 %

7.2 HEAD LIQUID MEASUREMENT

Frequency MHz	Relative permittivity (ϵ_r')		Conductivity (σ) S/m	
	required	measured	required	measured
300	45.3 ± 5 %		0.87 ± 5 %	
450	43.5 ± 5 %		0.87 ± 5 %	
750	41.9 ± 5 %		0.89 ± 5 %	
825	41.5 ± 5 %		0.90 ± 5 %	
900	41.5 ± 5 %		0.97 ± 5 %	
1450	40.5 ± 5 %		1.20 ± 5 %	
1500	40.4 ± 5 %		1.23 ± 5 %	
1640	40.2 ± 5 %		1.31 ± 5 %	
1750	40.1 ± 5 %		1.37 ± 5 %	
1800	40.0 ± 5 %		1.40 ± 5 %	
1900	40.0 ± 5 %		1.40 ± 5 %	
1950	40.0 ± 5 %		1.40 ± 5 %	
2000	40.0 ± 5 %		1.40 ± 5 %	
2100	39.8 ± 5 %		1.49 ± 5 %	
2300	39.5 ± 5 %		1.67 ± 5 %	
2450	39.2 ± 5 %	PASS	1.80 ± 5 %	PASS
2600	39.0 ± 5 %		1.96 ± 5 %	
3000	38.5 ± 5 %		2.40 ± 5 %	
3500	37.9 ± 5 %		2.91 ± 5 %	

Page: 7/10

*This document shall not be reproduced, except in full or in part, without the written approval of SATIMO.
The information contained herein is to be used only for the purpose for which it is submitted and is not to be released in whole or part without written approval of SATIMO.*



7.3 MEASUREMENT RESULT

The IEEE Std. 1528 and CEI/IEC 62209 standards state that the system validation measurements should produce the SAR values shown below (for phantom thickness of 2 mm), within the uncertainty for the system validation. All SAR values are normalized to 1 W forward power. In bracket, the measured SAR is given with the used input power.

Frequency MHz	1 g SAR (W/kg/W)		10 g SAR (W/kg/W)	
	required	measured	required	measured
300	2.85		1.94	
450	4.58		3.06	
750	8.49		5.55	
835	9.56		6.22	
900	10.9		6.99	
1450	29		16	
1500	30.5		16.8	
1640	34.2		18.4	
1750	36.4		19.9	
1800	38.4		20.1	
1900	39.7		20.5	
1950	40.5		20.9	
2000	41.1		21.1	
2100	43.6		21.9	
2300	48.7		23.3	
2450	52.4	54.40 (5.44)	24	23.75 (2.38)
2600	55.3		24.6	
3000	63.8		25.7	
3500	67.1		25	

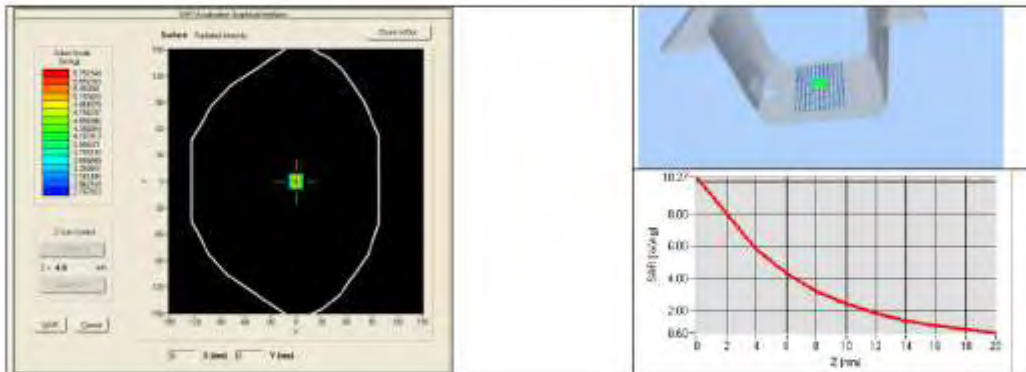



7.4 BODY MEASUREMENT RESULT

Software	OPENSAR V4
Phantom	SN 20/09 SAM71
Probe	SN 18/11 EPG122
Liquid	Body Liquid Values: $\epsilon_p' : 52.0$ $\sigma_{\text{p}} : 1.94$
Distance between dipole center and liquid	10.0 mm
Area scan resolution	$dx=8\text{mm}/dy=8\text{mm}$
Zoon Scan Resolution	$dx=8\text{mm}/dy=8\text{m}/dz=5\text{mm}$
Frequency	2450 MHz
Input power	20 dBm
Liquid Temperature	21 °C
Lab Temperature	21 °C
Lab Humidity	45 %

Frequency MHz	1 g SAR (W/kg/W)	10 g SAR (W/kg/W)
	measured	measured
2450	54.19 (5.42)	24.95 (2.50)

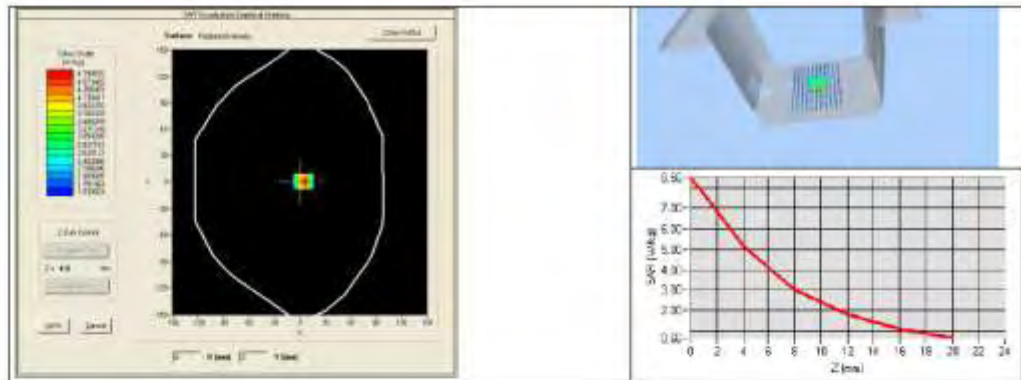



8 LIST OF EQUIPMENT

Equipment Summary Sheet				
Equipment Description	Manufacturer / Model	Identification No.	Current Calibration Date	Next Calibration Date
SAM Phantom	Satimo	SN-20/09-SAM71	Validated. No cal required.	Validated. No cal required.
COMOSAR Test Bench	Version 3	NA	Validated. No cal required.	Validated. No cal required.
Network Analyzer	Rhode & Schwarz ZVA	SN100132	02/2013	02/2016
Calipers	Carrera	CALIPER-01	12/2010	12/2013
Reference Probe	Satimo	EPG122 SN 18/11	Characterized prior to test. No cal required.	Characterized prior to test. No cal required.
Multimeter	Keithley 2000	1188656	11/2010	11/2013
Signal Generator	Agilent E4438C	MY49070581	12/2010	12/2013
Amplifier	Aethercomm	SN 046	Characterized prior to test. No cal required.	Characterized prior to test. No cal required.
Power Meter	HP E4418A	US38261498	11/2010	11/2013
Power Sensor	HP ECP-E26A	US37181460	11/2010	11/2013
Directional Coupler	Narda 4216-20	01388	Characterized prior to test. No cal required.	Characterized prior to test. No cal required.
Temperature and Humidity Sensor	Control Company	11-661-9	3/2012	3/2014