

---

# SAR Test Report

---

Report No.:AGC00529140806FH01

**FCC ID** : Y7WPLUMX350  
**APPLICATION PURPOSE** : Original Equipment  
**PRODUCT DESIGNATION** : Sync Plus 3.5  
**BRAND NAME** : plum  
**MODEL NAME** : X350  
**CLIENT** : CLC Hong Kong Limited  
**DATE OF ISSUE** : Sep. 11,2014  
**STANDARD(S)** : IEEE Std. 1528:2003;  
47CFR § 2.1093  
IEEE/ANSI C95.1  
**REPORT VERSION** : V1.0

Attestation of Global Compliance(Shenzhen) Co., Ltd.

**CAUTION:**

This report shall not be reproduced except in full without the written permission of the test laboratory and shall not be quoted out of context.



### Report Revise Record

| Report Version | Revise Time | Issued Date  | Valid Version | Notes           |
|----------------|-------------|--------------|---------------|-----------------|
| V1.0           | /           | Sep. 11,2014 | Valid         | Original Report |

The test plans were performed in accordance with IEEE Std. 1528:2003; 47CFR § 2.1093; IEEE/ANSI C95.1 and the following specific FCC Test Procedures:

- KDB 447498 D01 General RF Exposure Guidance v05r02
- KDB 648474 D04 SAR Handsets Multi Xmitter and Ant v01
- KDB 865664 D01 SAR measurement 100 MHz to 6 GHz v01r03
- KDB 941225 D03 SAR Test Reduction GSM GPRS EDGE v01
- KDB 941225 D06 Hot Spot SAR v01
- KDB 248227 D01 SAR meas for 802 11 a b g v01r02

## Test Report Certification

|                       |   |
|-----------------------|---|
| Applicant Name        | CLC Hong Kong Limited   |
| Applicant Address     | 1011A, 10/F., Harbour Centre Tower 1, No.1 Hok Cheung St., Hung Hom Kowloon, Hong Kong                                      |
| Manufacturer Name     | CLC Technology Co. Ltd.   |
| Manufacturer Address  | Room 6G, Block C, NEO Building, Chegongmiao, Futian District, Shenzhen, P.R China   |
| Product Designation   | Sync Plus 3.5   |
| Brand Name            | plum  |
| Model Name            | X350  |
| Different Description | N/A   |
| EUT Voltage           | DC3.7V by battery   |
| Applicable Standard   | IEEE Std. 1528:2003<br>47CFR § 2.1093<br>IEEE/ANSI C95.1  |
| Test Date             | Sep. 09,2014  |
| Performed Location    | Attestation of Global Compliance(Shenzhen) Co., Ltd.  |
|                       | 2 F, Building 2, No.1-No.4, Chaxi Sanwei Technical Industrial Park, Gushu, Xixiang Street, Bao'an District, Shenzhen, China |
| Report Template       | AGCRT-US-2.5G/SAR (2014-04-01)  |

Tested By



Eric Zhou      Sep. 11,2014

Checked By



Angela Li      Sep. 11,2014

Authorized By



Solger Zhang      Sep. 11,2014

## TABLE OF CONTENTS

|  |           |
|--|-----------|
| <b>1. SUMMARY OF MAXIMUM SAR VALUE .....</b>                         | <b>5</b>  |
| <b>2. GENERAL INFORMATION.....</b>                                   | <b>6</b>  |
| 2.1. EUT DESCRIPTION.....  | 6         |
| 2.2. TEST PROCEDURE .....  | 7         |
| 2.3. TEST ENVIRONMENT.....   | 7         |
| 2.4. TEST CONFIGURATION AND SETTING .....                            | 8         |
| <b>3. SAR MEASUREMENT SYSTEM.....</b>                                | <b>9</b>  |
| 3.1. SPECIFIC ABSORPTION RATE (SAR) .....                            | 9         |
| 3.2. SAR MEASUREMENT PROCEDURE .....                                 | 10        |
| 3.3. COMOSAR SYSTEM DESCRIPTION.....                                 | 11        |
| 3.4. COMOSAR E-FIELD PROBE .....                                     | 13        |
| 3.5. ISOTROPIC E-FIELD PROBE SPECIFICATION .....                     | 13        |
| 3.6. ROBOT.....  | 13        |
| 3.7. VIDEO POSITIONING SYSTEM .....                                  | 14        |
| 3.8. DEVICE HOLDER .....   | 14        |
| 3.9. SAM TWIN PHANTOM.....   | 15        |
| <b>4. TISSUE SIMULATING LIQUID .....</b>                             | <b>16</b> |
| 4.1. THE COMPOSITION OF THE TISSUE SIMULATING LIQUID.....            | 16        |
| 4.2. TISSUE CALIBRATION RESULT.....                                  | 17        |
| 4.3. TISSUE DIELECTRIC PARAMETERS FOR HEAD AND BODY PHANTOMS.....    | 18        |
| <b>5. SAR MEASUREMENT PROCEDURE .....</b>                            | <b>19</b> |
| 5.1. SAR SYSTEM VALIDATION PROCEDURES .....                          | 19        |
| 5.2. SAR SYSTEM VALIDATION.....                                      | 20        |
| <b>6. EUT TEST POSITION.....</b>                                     | <b>22</b> |
| 6.1. DEFINE TWO IMAGINARY LINES ON THE HANDSET.....                  | 22        |
| 6.2. CHEEK POSITION .....  | 23        |
| 6.3. TITLE POSITION .....  | 23        |
| 6.4. BODY WORN POSITION.....   | 24        |
| <b>7. SAR EXPOSURE LIMITS .....</b>                                  | <b>25</b> |
| <b>8. TEST EQUIPMENT LIST .....</b>                                  | <b>26</b> |
| <b>9. MEASUREMENT UNCERTAINTY .....</b>                              | <b>27</b> |
| <b>10. CONDUCTED POWER MEASUREMENT .....</b>                         | <b>28</b> |
| <b>11. TEST RESULTS .....</b>  | <b>30</b> |
| 11.1. SAR TEST RESULTS SUMMARY .....                                 | 30        |
| <b>APPENDIX A. SAR SYSTEM VALIDATION DATA .....</b>                  | <b>36</b> |
| <b>APPENDIX B. SAR MEASUREMENT DATA.....</b>                         | <b>46</b> |
| <b>APPENDIX C. TEST SETUP PHOTOGRAPHS &amp;EUT PHOTOGRAPHS .....</b> | <b>78</b> |
| <b>APPENDIX D. PROBE CALIBRATION DATA .....</b>                      | <b>88</b> |
| <b>APPENDIX E. DIPOLE CALIBRATION DATA.....</b>                      | <b>98</b> |

## 1. SUMMARY OF MAXIMUM SAR VALUE

The maximum results of Specific Absorption Rate (SAR) found during testing for EUT are as follows:

### Highest tested and scaled SAR Summary

| Exposure Position | Frequency Band | Highest Tested 1g-SAR(W/Kg) | Highest Scaled Maximum SAR(W/Kg) |
|-------------------|----------------|-----------------------------|----------------------------------|
| Head              | GSM 835        | 0.230                       | 0.309                            |
|                   | PCS 1900       | 0.406                       | 0.532                            |
| Body- worn        | GSM 835        | 0.561                       | 0.753                            |
|                   | PCS 1900       | 0.249                       | 0.326                            |

| Exposure Position | Test Mode | Highest Tested 1g-SAR(W/Kg) | Highest Scaled Maximum SAR(W/Kg) |
|-------------------|-----------|-----------------------------|----------------------------------|
| Body              | HOTSPOT   | 0.256                       | 0.268                            |

### Highest Simultaneous transmission SAR Summary

| Exposure Position | Frequency Band    | Highest Simultaneous SAR(W/Kg) |
|-------------------|-------------------|--------------------------------|
| Head              | GSM 835+WLAN      | 0.725                          |
|                   | PCS 1900+WLAN     | 0.948                          |
| Body- worn        | GSM 835+HOTSPOT   | 1.021                          |
|                   | PCS 1900+ HOTSPOT | 0.594                          |

This device is compliance with Specific Absorption Rate (SAR) for general population/uncontrolled exposure limits (1.6W/Kg) specified in FCC 47 CFR part 2 (2.1093) and ANSI/IEEE C95.1, and had been tested in accordance with measurement methods and procedures specified in IEEE 1528-2003 and the relevant KDB files like KDB 941225 D01 , KDB 941225 D03 ,KDB 865664 D02....etc.

## 2. GENERAL INFORMATION

### 2.1. EUT Description

| General Information                     |  |
|---|--|
| Product Designation                     | Sync Plus 3.5  |
| Test Model                              | X350   |
| Hardware Version                        | DR018_MB_V0.3  |
| Software Version                        | N/A  |
| Device Category                         | Portable   |
| RF Exposure Environment                 | Uncontrolled   |
| Antenna Type                            | Internal   |
| GSM and GPRS                            |  |
| Support Band                            | <input checked="" type="checkbox"/> GSM 850 <input checked="" type="checkbox"/> PCS 1900 (U.S. Bands)<br><input checked="" type="checkbox"/> GSM 900 <input checked="" type="checkbox"/> DCS 1800 (Non-U.S. Bands) |
| GPRS Type                               | Class B  |
| GPRS Class                              | Class 12(1Tx+4Rx, 2Tx+3Rx, 3Tx+2Rx, 4Tx+1Rx)   |
| TX Frequency Range                      | GSM 850 : 824.2~848.8MHz;<br>PCS 1900: 1850.2~1909.8MHz;   |
| RX Frequency Range                      | GSM 850 : 869~894MHz<br>PCS 1900: 1930~1990MHz   |
| Release Version                         | R99  |
| Type of modulation                      | GMSK for GSM/GPRS  |
| Antenna Gain                            | -1.0dBi  |
| Max. Average Power<br>(Max. Peak Power) | GSM850: 31.89dBm(32.52dBm- Peak Power)<br>PCS1900: 28.91dBm(29.63dBm-Peak Power)   |
| Bluetooth                               |  |
| Bluetooth Version                       | <input type="checkbox"/> V2.0 <input type="checkbox"/> V2.1 <input type="checkbox"/> V2.1+EDR <input checked="" type="checkbox"/> V3.0 <input type="checkbox"/> V3.0+HS <input checked="" type="checkbox"/> V4.0   |
| Operation Frequency                     | 2402~2480MHz   |
| Type of modulation                      | <input checked="" type="checkbox"/> GFSK <input checked="" type="checkbox"/> II/4-DQPSK <input checked="" type="checkbox"/> 8-DPSK   |
| Avg. Burst Power                        | 1.05dBm  |
| Antenna Gain                            | 0.8dBi   |

### EUT Description (Continue)

| <b>WIFI</b>   |  |
|---|--|
| WIFI Specification  | <input type="checkbox"/> 802.11a <input checked="" type="checkbox"/> 802.11b <input checked="" type="checkbox"/> 802.11g <input checked="" type="checkbox"/> 802.11n(20) <input checked="" type="checkbox"/> 802.11n(40) |
| Operation Frequency   | 2412~2462MHz   |
| Avg. Burst Power  | 11b:9.8dBm, 11g:7.79dBm, 11n(20):7.6dBm, 11n(40):4.83dBm   |
| Antenna Gain  | 0.8dBi   |
| <b>Accessories</b>  |  |
| Battery   | Brand name: plum<br>Model No. : PMB47<br>Voltage and Capacitance: 3.7 V & 1300mAh  |
| Adapter   | Brand name: plum<br>Model No. : PMC43<br>Input: AC 100-240V, 50/60Hz, 0.15A    Output: DC 5.0V, 500mA  |
| Earphone  | Brand name: N/A<br>Model No. : N/A   |
| Note:CMU200 can measure the average power and Peak power at the same time |  |
| Product   | Type   |
|   | <input checked="" type="checkbox"/> Production unit <input type="checkbox"/> Identical Prototype   |

### 2.2. Test Procedure

|   |   |
|---|---|
| 1 | Setup the EUT and simulators as shown on above.                     |
| 2 | Turn on the power of all equipment.                                 |
| 3 | EUT Communicate with 8960, and test them respectively at U.S. bands |

### 2.3. Test Environment

Ambient conditions in the laboratory:

| Items            | Required | Actual |
|------------------|----------|--------|
| Temperature (°C) | 18-25    | 21± 2  |
| Humidity (%RH)   | 30-70    | 55±2   |

## 2.4. Test Configuration and setting

The EUT is a model of GSM Portable Mobile Station (MS). It supports GSM/GPRS, BT, WIFI, and support hot spot mode.

For WWAN SAR testing, the device was controlled by using a base station emulator. Communication between the device and the emulator were established by air link. The distance between the EUT and the antenna is larger than 50cm, and the output power radiated from the emulator antenna is at least 30db smaller than the output power of EUT.

For WLAN testing, the EUT is configured with the WLAN continuous TX tool through engineering command.

### Antenna Location:

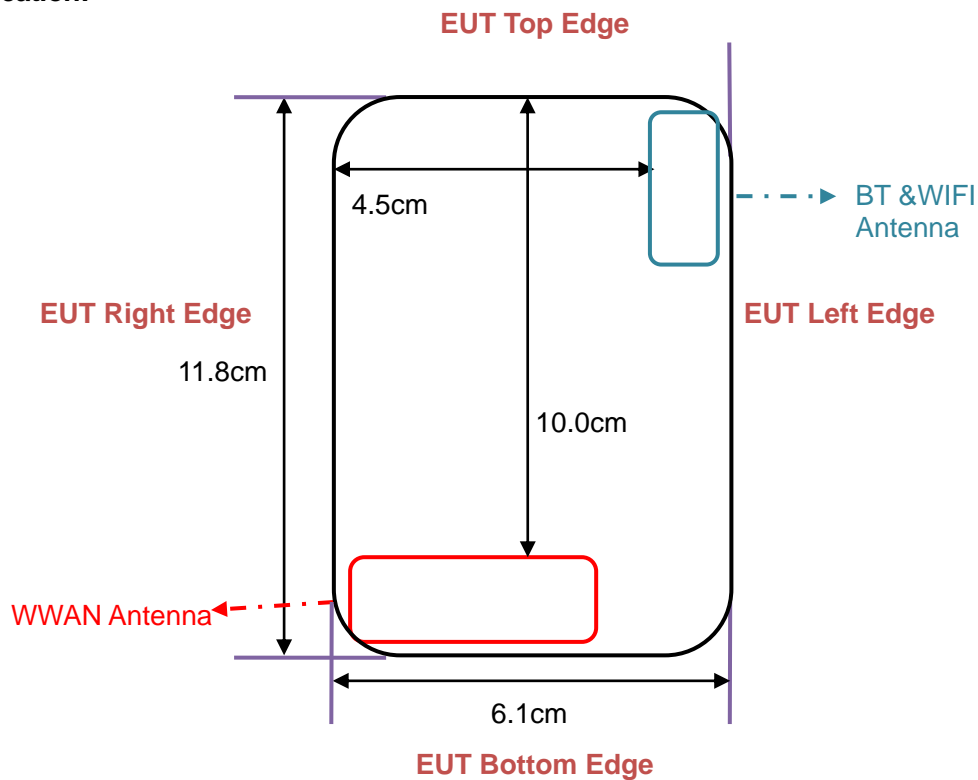

The separation distance for antenna to edge:

| Antenna | To Top Side(cm) | To Bottom Side(cm) | To Left Side(cm) | To Right Side(cm) |
|---------|-----------------|--------------------|------------------|-------------------|
| WWAN    | 10.0            | 0.1                | 1.3              | 0.1               |
| BT/WIFI | 0.2             | 9.2                | 0.1              | 4.5               |

The simultaneous transmission possibilities are listed as below:

| Simultaneous TX Combination | Configuration           | Head | Body | Hotspot |
|-----------------------------|-------------------------|------|------|---------|
| 1                           | GSM835(Voice)+WLAN/BT   | Yes  | Yes  | Yes     |
| 2                           | PCS 1900(Voice)+WLAN/BT | Yes  | Yes  | Yes     |



### 3. SAR MEASUREMENT SYSTEM

#### 3.1. Specific Absorption Rate (SAR)

SAR is related to the rate at which energy is absorbed per unit mass in object exposed to a radio field. The SAR distribution in a biological body is complicated and is usually carried out by experimental techniques or numerical modeling. The standard recommends limits for two tiers of groups, occupational/controlled and occupational/uncontrolled, based on a person's awareness and ability to exercise control over his or her exposure. In general, occupational/controlled exposure limits are higher than the limits for general population/uncontrolled.

The SAR definition is the time derivative (rate) of the incremental energy (dW) absorbed by (dissipated in) an incremental mass (dm) contained in a volume (dv) of given mass density ( $\rho$ ). The equation description is as below:

$$SAR = \frac{d}{dt} \left( \frac{dW}{dm} \right) = \frac{d}{dt} \left( \frac{dW}{\rho dV} \right)$$

SAR is expressed in units of Watts per kilogram (W/Kg)

SAR can be obtained using either of the following equations:

$$SAR = \frac{\sigma E^2}{\rho}$$

$$SAR = c_h \left. \frac{dT}{dt} \right|_{t=0}$$

Where

|          |  |
|----------|--|
| SAR      | is the specific absorption rate in watts per kilogram;                               |
| E        | is the r.m.s. value of the electric field strength in the tissue in volts per meter; |
| $\sigma$ | is the conductivity of the tissue in siemens per metre;                              |
| $\rho$   | is the density of the tissue in kilograms per cubic metre;                           |
| $c_h$    | is the heat capacity of the tissue in joules per kilogram and Kelvin;                |

$\left. \frac{dT}{dt} \right|_{t=0}$  is the initial time derivative of temperature in the tissue in kelvins per second

### **3.2. SAR Measurement Procedure**

The EUT is set to transmit at the required power in line with product specification, at each frequency relating to the LOW, MID, and HIGH channel settings.

Pre-scans are made on the device to establish the location for the transmitting antenna, using a large area scan in either air or tissue simulation fluid.

The EUT is placed against the Universal Phantom where the maximum area scan dimensions are larger than the physical size of the resonating antenna. When the scan size is not large enough to cover the peak SAR distribution, it is modified by either extending the area scan size in both the X and Y directions, or the device is shifted within the predefined area.

The area scan is then run to establish the peak SAR location (interpolated resolution set at  $1\text{mm}^2$ ) which is then used to orient the center of the zoom scan. The zoom scan is then executed and the 1g and 10g averages are derived from the zoom scan volume (interpolated resolution set at  $1\text{mm}^3$ ).

When multiple peak SAR location were found during the same configuration or test mode, Zoom scan shall performed on each peak SAR location, only the peak point with maximum SAR value will be reported for the configuration or test mode.

### 3.3. COMOSAR System Description

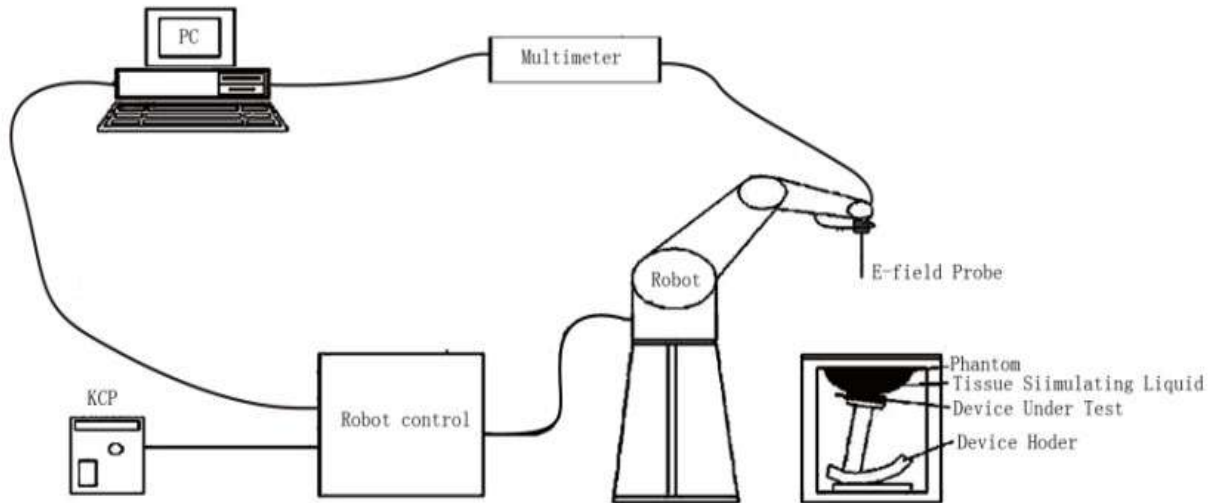

The COMOSAR system for performing compliance tests consists of the following items:

- The PC. It controls most of the bench devices and stores measurement data. A computer running WinXP and the Opensar software.
- The E-Field probe. The probe is a 3-axis system made of 3 distinct dipoles. Each dipole returns a voltage in function of the ambient electric field.
- The Keithley multimeter measures each probe dipole voltages.
- The SAM phantom simulates a human head. The measurement of the electric field is made inside the phantom.
- The liquids simulate the dielectric properties of the human head tissues.
- The network emulator controls the mobile phone under test.
- The validation dipoles are used to measure a reference SAR. They are used to periodically check the bench to make sure that there is no drift of the system characteristics over time.
- The phantom, the device holder and other accessories according to the targeted measurement.

#### 3.3.1. Applications

Predefined procedures and evaluations for automated compliance testing with all worldwide standards, e.g., IEEE 1528, IEC 62209-1, IEC 62209-2, EN 50360, EN 50383 and others.

### 3.3.2. Area Scans

Area scans are defined prior to the measurement process being executed with a user defined variable spacing between each measurement point (integral) allowing low uncertainty measurements to be conducted. Scans defined for FCC applications utilize a 10mm<sup>2</sup> step integral, with 1mm interpolation used to locate the peak SAR area used for zoom scan assessments.

When an Area Scan has measured all reachable points, it computes the field maxima found in the scanned area, within a range of the global maximum. The range (in dB) is specified in the standards for compliance testing. For example, a 2 dB range is required in IEEE 1528-2003, EN 50361 and IEC 62209 standards, whereby 3 dB is a requirement when compliance is assessed in accordance with the ARIB standard (Japan).

### 3.3.3. Zoom Scan (Cube Scan Averaging)

Zoom Scans are used to assess the peak spatial SAR values within a cubic averaging volume containing 1 g and 10 g of simulated tissue. A density of 1000 kg/m<sup>3</sup> is used to represent the head and body tissue density and not the phantom liquid density, in order to be consistent with the definition of the liquid dielectric properties, i.e. the side length of the 1 g cube is 10mm, with the side length of the 10 g cube 21,5mm.

The zoom scan integer steps can be user defined so as to reduce uncertainty, but normal practice for typical test applications utilize a physical step of 7x7x7 (5mmx5mmx5mm) providing a volume of 30mm in the X & Y axis, and 30mm in the Z axis.

### 3.3.4. Uncertainty of Inter-/Extrapolation and Averaging

In order to evaluate the uncertainty of the interpolation, extrapolation and averaged SAR calculation algorithms of the Post processor, COMOSAR allows the generation of measurement grids which are artificially predefined by analytically based test functions. Therefore, the grids of area scans and zoom scans can be filled with uncertainty test data, according to the SAR benchmark functions of IEEE 1528. The three analytical functions shown in equations as below are used to describe the possible range of the expected SAR distributions for the tested handsets. The field gradients are covered by the spatially flat distribution f1, the spatially steep distribution f3 and f2 accounts for H-field cancellation on the phantom/tissue surface.

$$f_1(x, y, z) = Ae^{-\frac{z}{2a}} \cos^2 \left( \frac{\pi \sqrt{x'^2 + y'^2}}{2 \cdot 5a} \right)$$

$$f_2(x, y, z) = Ae^{-\frac{z}{a}} \frac{a^2}{a^2 + x'^2} \left( 3 - e^{-\frac{2z}{a}} \right) \cos^2 \left( \frac{\pi y'}{2 \cdot 3a} \right)$$

$$f_3(x, y, z) = A \frac{a^2}{\frac{a^2}{4} + x'^2 + y'^2} \left( e^{-\frac{2z}{a}} + \frac{a^2}{2(a + 2z)^2} \right)$$

### 3.4. COMOSAR E-Field Probe

The SAR measurement is conducted with the dissymmetric probe manufactured by SATIMO. The probe is specially designed and calibrated for use in liquid with high permittivity. The dissymmetric probe has special calibration in liquid at different frequency. SATIMO conducts the probe calibration in compliance with international and national standards (e.g. IEEE 1528, EN62209-1, IEC 62209, etc.) under ISO17025. The calibration data are in Appendix D.

### 3.5. Isotropic E-Field Probe Specification

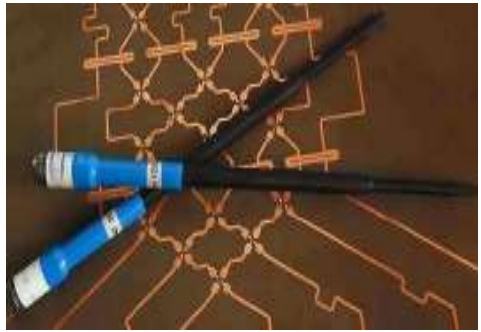
|                      |  |  |
|----------------------|--|--|
| <b>Model</b>         | SSE5   |  |
| <b>Manufacture</b>   | SATIMO   |  |
| <b>Frequency</b>     | 0.3GHz-3GHz<br>Linearity:±0.09dB(300MHz-3GHz)  |  |
| <b>Dynamic Range</b> | 0.01W/Kg-100W/Kg<br>Linearity:±0.09dB  |  |
| <b>Dimensions</b>    | Overall length:330mm<br>Length of individual dipoles:4.5mm<br>Maximum external diameter:8mm<br>Probe Tip external diameter:5mm<br>Distance between dipoles/ probe extremity:2.7mm                          |  |
| <b>Application</b>   | High precision dosimetric measurements in any exposure scenario (e.g., very strong gradient fields). Only probe which enables compliance testing for frequencies up to 3 GHz with precision of better 30%. |  |

### 3.6. Robot

|  |   |
|--|---|
| <p>The COMOSAR system uses the KUKA robot from SATIMO SA (France).For the 6-axis controller COMOSAR system, the KUKA robot controller version from SATIMO is used. The XL robot series have many features that are important for our application:</p> <ul style="list-style-type: none"> <li><input type="checkbox"/> High precision (repeatability 0.02 mm)</li> <li><input type="checkbox"/> High reliability (industrial design)</li> <li><input type="checkbox"/> Jerk-free straight movements</li> <li><input type="checkbox"/> Low ELF interference (the closed metallic construction shields against motor control fields)</li> <li><input type="checkbox"/> 6-axis controller</li> </ul> |  |
|--|---|

### 3.7. Video Positioning System

The video positioning system is used in OpenSAR to check the probe. Which is composed of a camera, LED, mirror and mechanical parts. The camera is piloted by the main computer with firewire link. During the process, the actual position of the probe tip with respect to the robot arm is measured, as well as the probe length and the horizontal probe offset. The software then corrects all movements, such that the robot coordinates are valid for the probe tip. The repeatability of this process is better than 0.1 mm. If a position has been taught with an aligned probe, the same position will be reached with another aligned probe within 0.1 mm, even if the other probe has different dimensions. During probe rotations, the probe tip will keep its actual position.

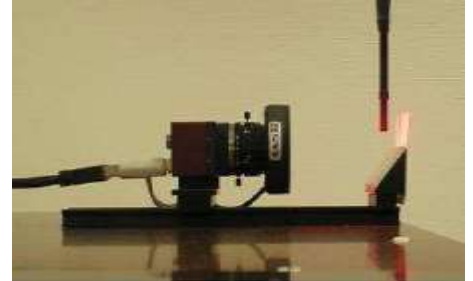

### 3.8. Device Holder

The COMOSAR device holder is designed to cope with different positions given in the standard. It has two scales for the device rotation (with respect to the body axis) and the device inclination (with respect to the line between the ear reference points). The rotation center for both scales is the ear reference point (EPR). Thus the device needs no repositioning when changing the angles. The COMOSAR device holder has been made out of low-loss POM material having the following dielectric parameters: relative permittivity  $\epsilon_r = 3$  and loss tangent  $\delta = 0.02$ . The amount of dielectric material has been reduced in the closest vicinity of the device, since measurements have suggested that the influence of the clamp on the test results could thus be lowered.

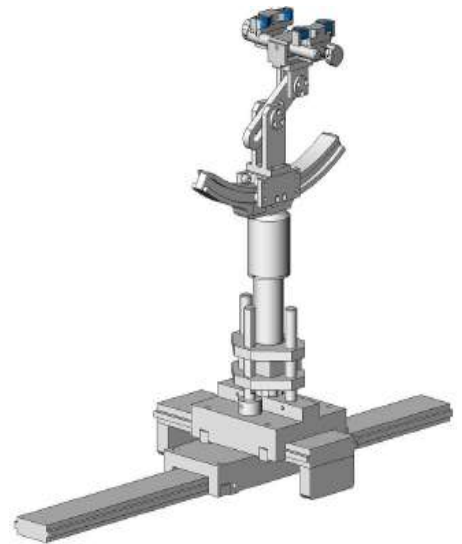

### 3.9. SAM Twin Phantom

The SAM twin phantom is a fiberglass shell phantom with 2mm shell thickness (except the ear region where shell thickness increases to 6mm). It has three measurement areas:

- Left head
- Right head
- Flat phantom



The bottom plate contains three pair of bolts for locking the device holder. The device holder positions are adjusted to the standard measurement positions in the three sections. A white cover is provided to tap the phantom during off-periods to prevent water evaporation and changes in the liquid parameters. On the phantom top, three reference markers are provided to identify the phantom position with respect to the robot.

## 4. TISSUE SIMULATING LIQUID

For SAR measurement of the field distribution inside the phantom, the phantom must be filled with homogeneous tissue simulating liquid to a depth of at least 15cm. For head SAR testing the liquid height from the ear reference point (ERP) of the phantom to the liquid top surface is larger than 15cm For body SAR testing, the liquid height from the center of the flat phantom to the liquid top surface is larger than 15cm. The nominal dielectric values of the tissue simulating liquids in the phantom and the tolerance of 5% are listed in 4.2

### 4.1. The composition of the tissue simulating liquid

| Ingredient       | 835MHz | 835MHz | 1900MHz | 1900MHz | 2450MHz |
|------------------|--------|--------|---------|---------|---------|
| (% Weight)       | Head   | Body   | Head    | Body    | Body    |
| <b>Water</b>     | 40.45  | 52.4   | 54.90   | 40.5    | 73.2    |
| <b>Salt</b>      | 1.42   | 1.40   | 0.18    | 0.50    | 0.04    |
| <b>Sugar</b>     | 57.6   | 45.0   | 0.00    | 58.0    | 0.00    |
| <b>HEC</b>       | 0.40   | 1.00   | 0.00    | 0.50    | 0.00    |
| <b>Preventol</b> | 0.10   | 0.20   | 0.00    | 0.50    | 0.00    |
| <b>DGBE</b>      | 0.00   | 0.00   | 44.92   | 0.00    | 26.7    |



## 4.2. Tissue Calibration Result

The dielectric parameters of the liquids were verified prior to the SAR evaluation using COMOSAR Dielectric Probe Kit and R&S Network Analyzer ZVL6.

| Tissue Stimulant Measurement for 835MHz |      |                                       |                                      |                                      |  |                  |              |
|---|------|---------------------------------------|--------------------------------------|--------------------------------------|--|------------------|--------------|
| Fr. (MHz)                               | Ch.  | Dielectric Parameters ( $\pm 5\%$ )   |                                      |                                      |  | Tissue Temp [°C] | Test time    |
|   |      | head                                  |                                      | body                                 |  |                  |              |
|   |      | $\epsilon_r$<br>41.5<br>39.425-43.575 | $\delta[s/m]$<br>0.90<br>0.855-0.945 | $\epsilon_r$<br>55.20<br>52.44-57.96 | $\delta[s/m]$<br>0.97<br>0.9215-1.0185 |                  |              |
| 835                                     | Low  | 41.43                                 | 0.91                                 | 55.01                                | 0.97                                   | 21               | Sep. 09,2014 |
| 835                                     | Mid  | 40.72                                 | 0.88                                 | 54.93                                | 0.95                                   | 21               | Sep. 09,2014 |
| 835                                     | High | 40.96                                 | 0.90                                 | 55.26                                | 0.98                                   | 21               | Sep. 09,2014 |

| Tissue Stimulant Measurement for 1900MHz |      |                                      |                                    |  |                                      |                  |              |
|--|------|--------------------------------------|------------------------------------|--|--------------------------------------|------------------|--------------|
| Fr. (MHz)                                | Ch.  | Dielectric Parameters ( $\pm 5\%$ )  |                                    |  |                                      | Tissue Temp [°C] | Test time    |
|  |      | head                                 |                                    | body                                   |                                      |                  |              |
|  |      | $\epsilon_r$<br>40.00<br>38.00-42.00 | $\delta[s/m]$<br>1.40<br>1.33-1.47 | $\epsilon_r$<br>53.30<br>50.635-55.965 | $\delta[s/m]$<br>1.52<br>1.444-1.596 |                  |              |
| 1900                                     | Low  | 39.49                                | 1.41                               | 53.77                                  | 1.50                                 | 21               | Sep. 09,2014 |
| 1900                                     | Mid  | 39.06                                | 1.38                               | 54.04                                  | 1.55                                 | 21               | Sep. 09,2014 |
| 1900                                     | High | 39.11                                | 1.42                               | 53.65                                  | 1.53                                 | 21               | Sep. 09,2014 |

| Tissue Stimulant Measurement for 2450MHz |      |                                       |  |  |  |                  |              |
|--|------|---------------------------------------|--|--|--|------------------|--------------|
| Fr. (MHz)                                | Ch.  | Dielectric Parameters ( $\pm 5\%$ )   |  |  |  | Tissue Temp [°C] | Test time    |
|  |      | body                                  |  |  |  |                  |              |
|  |      | $\epsilon_r$<br>52.7<br>50.065-55.335 |  | $\delta[s/m]$<br>1.95<br>1.8525-2.0475 |  |                  |              |
| 2450                                     | Low  | 53.15                                 |  | 1.89                                   |  | 21               | Sep. 09,2014 |
| 2450                                     | Mid  | 52.99                                 |  | 1.92                                   |  | 21               | Sep. 09,2014 |
| 2450                                     | High | 53.06                                 |  | 1.90                                   |  | 21               | Sep. 09,2014 |

### 4.3. Tissue Dielectric Parameters for Head and Body Phantoms

The head tissue dielectric parameters recommended by the IEEE SCC-34/SC-2 in P1528 have been incorporated in the following table. These head parameters are derived from planar layer models simulating the highest expected SAR for the dielectric properties and tissue thickness variations in a human head. Other head and body tissue parameters that have not been specified in P1528 are derived from the tissue dielectric parameters computed from the 4-Cole-Cole equations described in Reference [12] and extrapolated according to the head parameters specified in P1528.

| Target Frequency (MHz) | head         |                | body         |                |
|------------------------|--------------|----------------|--------------|----------------|
|                        | $\epsilon_r$ | $\sigma$ (S/m) | $\epsilon_r$ | $\sigma$ (S/m) |
| 300                    | 45.3         | 0.87           | 58.2         | 0.92           |
| 450                    | 43.5         | 0.87           | 56.7         | 0.94           |
| <b>835</b>             | <b>41.5</b>  | <b>0.90</b>    | <b>55.2</b>  | <b>0.97</b>    |
| 900                    | 41.5         | 0.97           | 55.0         | 1.05           |
| 915                    | 41.5         | 1.01           | 55.0         | 1.06           |
| 1450                   | 40.5         | 1.20           | 54.0         | 1.30           |
| 1610                   | 40.3         | 1.29           | 53.8         | 1.40           |
| <b>1800 – 2000</b>     | <b>40.0</b>  | <b>1.40</b>    | <b>53.3</b>  | <b>1.52</b>    |
| <b>2450</b>            | 39.2         | 1.80           | <b>52.7</b>  | <b>1.95</b>    |
| 3000                   | 38.5         | 2.40           | 52.0         | 2.73           |
| 5800                   | 35.3         | 5.27           | 48.2         | 6.00           |

( $\epsilon_r$  = relative permittivity,  $\sigma$  = conductivity and  $\rho = 1000$  kg/m<sup>3</sup>)

## 5. SAR MEASUREMENT PROCEDURE

### 5.1. SAR System Validation Procedures

Each SATIMO system is equipped with one or more system validation kits. These units, together with the predefined measurement procedures within the SATIMO software, enable the user to conduct the system performance check and system validation. System kit includes a dipole, and dipole device holder.

The system check verifies that the system operates within its specifications. It's performed daily or before every SAR measurement. The system check uses normal SAR measurement in the flat section of the phantom with a matched dipole at a specified distance. The system validation setup is shown as below.

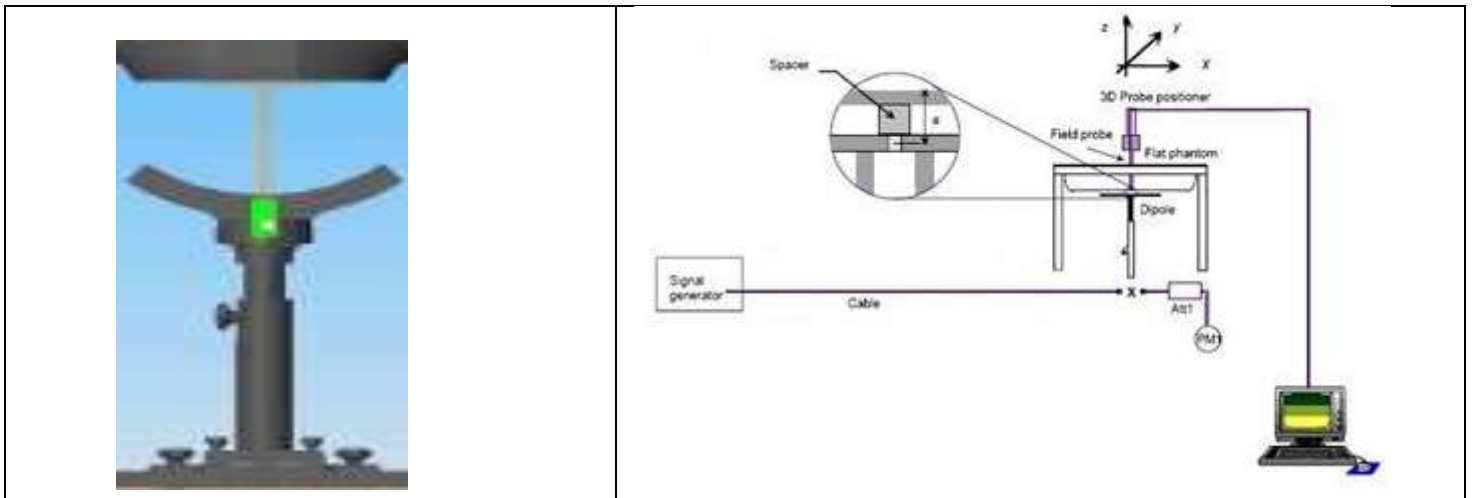

**5.2. SAR System Validation**  
**5.2.1. Validation Dipoles**

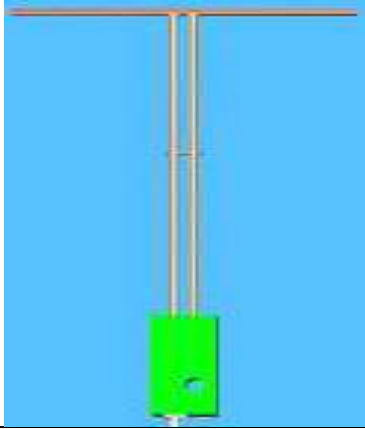

The dipoles used is based on the IEEE-1528 standard, and is complied with mechanical and electrical specifications in line with the requirements of both IEEE and FCC Supplement C. the table below provides details for the mechanical and electrical Specifications for the dipoles.

| Frequency   | L (mm) | h (mm) | d (mm) |
|-------------|--------|--------|--------|
| 835/900 MHz | 149.0  | 83.3   | 3.6    |
| 1900MHz     | 68     | 39.5   | 3.6    |
| 2450MHz     | 51.5   | 30.4   | 3.6    |

### 5.2.2. Validation Result

| System Performance Check at 835 MHz &1900MHz for Head         |                    |       |                                 |               |                    |       |                   |              |
|---|--------------------|-------|---------------------------------|---------------|--------------------|-------|-------------------|--------------|
| Validation Kit: SN 46/11DIP 0G900-185 & SN 46/11DIP 1G900-187 |                    |       |                                 |               |                    |       |                   |              |
| Frequency [MHz]   | Target Value(W/Kg) |       | Reference Result ( $\pm 10\%$ ) |               | Tested Value(W/Kg) |       | Tissue Temp. [°C] | Test time    |
|   | 1g                 | 10g   | 1g                              | 10g           | 1g                 | 10g   |                   |              |
| 835   | 10.70              | 6.72  | 9.63-11.77                      | 6.048-7.392   | 10.70              | 6.69  | 21                | Sep. 09,2014 |
| 1900  | 39.65              | 20.24 | 35.685-43.615                   | 18.216-22.264 | 39.12              | 20.18 | 21                | Sep. 09,2014 |

| System Performance Check at 835 MHz &1900MHz & 2450MHz for Body                      |                    |       |                                 |               |                    |       |                   |              |
|--|--------------------|-------|---------------------------------|---------------|--------------------|-------|-------------------|--------------|
| Validation Kit: SN 46/11DIP 0G900-185 & SN 46/11DIP 1G900-187 &SN 46/11DIP 2G450-189 |                    |       |                                 |               |                    |       |                   |              |
| Frequency [MHz]  | Target Value(W/Kg) |       | Reference Result ( $\pm 10\%$ ) |               | Tested Value(W/Kg) |       | Tissue Temp. [°C] | Test time    |
|  | 1g                 | 10g   | 1g                              | 10g           | 1g                 | 10g   |                   |              |
| 835  | 11.27              | 7.18  | 10.143-12.397                   | 6.462-7.898   | 10.99              | 6.83  | 21                | Sep. 09,2014 |
| 1900   | 40.74              | 21.43 | 36.666-44.814                   | 19.287-23.573 | 40.10              | 20.05 | 21                | Sep. 09,2014 |
| 2450   | 54.19              | 24.96 | 48.771-59.609                   | 22.464-27.456 | 49.87              | 23.66 | 21                | Sep. 09,2014 |

## 6. EUT TEST POSITION

This EUT was tested in **Right Cheek, Right Titled, Left Cheek, Left Titled, Front Face and Rear Face.**

### 6.1. Define Two Imaginary Lines on the Handset

(1)The vertical centerline passes through two points on the front side of the handset the midpoint of the width  $w_t$  of the handset at the level of the acoustic output, and the midpoint of the width  $w_b$  of the handset.

(2)The horizontal line is perpendicular to the vertical centerline and passes through the center of the acoustic output. The horizontal line is also tangential to the face of the handset at point A.

(3)The two lines intersect at point A. Note that for many handsets, point A coincides with the center of the acoustic output; however, the acoustic output may be located elsewhere on the horizontal line. Also note that the vertical centerline is not necessarily to the front face of the handset, especially for clamshell handsets, handsets with flip covers, and other irregularly shaped handsets.

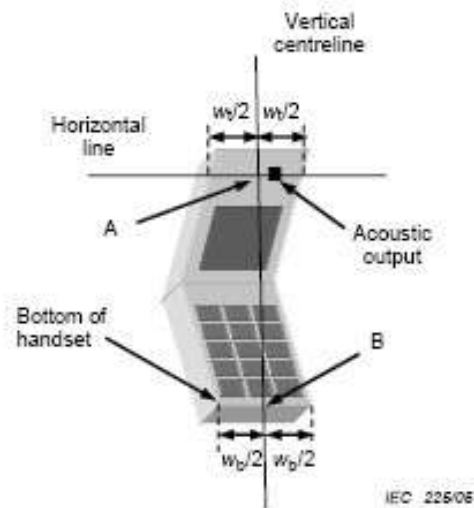
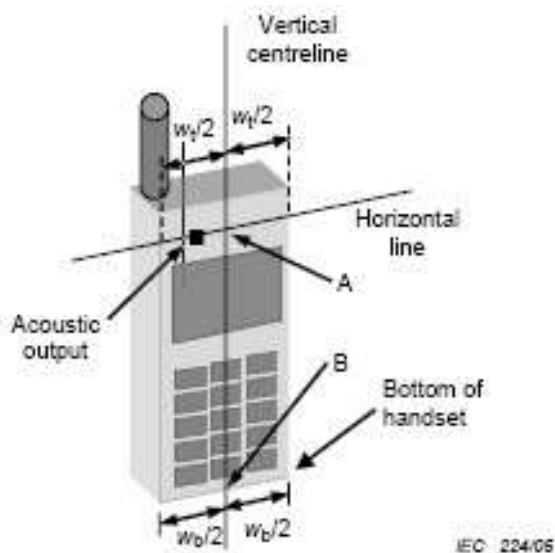

## 6.2. Cheek Position

- (1) To position the device with the vertical center line of the body of the device and the horizontal line crossing the center piece in a plane parallel to the sagittal plane of the phantom. While maintaining the device in this plane, align the vertical center line with the reference plane containing the ear and mouth reference point (M: Mouth, RE: Right Ear, and LE: Left Ear) and align the center of the ear piece with the line RE-LE.
- (2) To move the device towards the phantom with the ear piece aligned with the the line LE-RE until the phone touched the ear. While maintaining the device in the reference plane and maintaining the phone contact with ear, move the bottom of the phone until any point on the front side is in contact with the cheek of the phantom or until contact with the ear is lost



## 6.3. Title Position

- (1) To position the device in the “cheek” position described above.
- (2) While maintaining the device in the reference plane described above and pivoting against the ear, moves it outward away from the mouth by an angle of 15 degrees or until with the ear is lost.



#### 6.4. Body Worn Position

- (1) To position the EUT parallel to the phantom surface.
- (2) To adjust the EUT parallel to the flat phantom.
- (3) To adjust the distance between the EUT surface and the flat phantom to **10mm**.

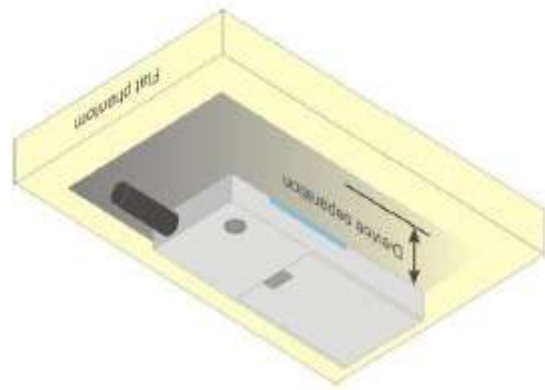
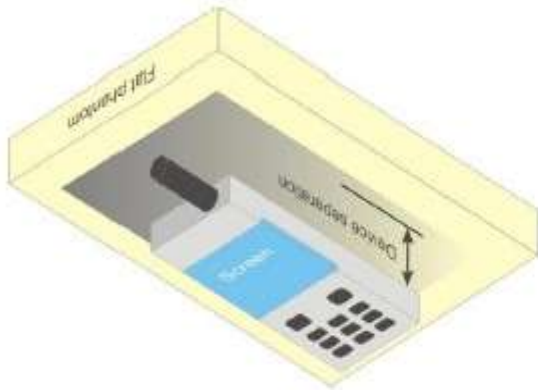



## 7. SAR EXPOSURE LIMITS

SAR assessments have been made in line with the requirements of IEEE-1528, FCC Supplement C, and comply with ANSI/IEEE C95.1-1992 "Uncontrolled Environments" limits. These limits apply to a location which is deemed as "Uncontrolled Environment" which can be described as a situation where the general public may be exposed to an RF source with no prior knowledge or control over their exposure.

### Limits for General Population/Uncontrolled Exposure (W/kg)

| Type Exposure                                       | Uncontrolled Environment Limit |
|---|--------------------------------|
| Spatial Peak SAR (1g cube tissue for brain or body) | 1.60 W/kg                      |

## 8. TEST EQUIPMENT LIST

| Equipment description | Manufacturer/ Model | Identification No.       | Current calibration date    | Next calibration date       |
|-----------------------|---------------------|--------------------------|-----------------------------|-----------------------------|
| SAR Probe             | SATIMO              | SN 22/12 EP159           | 01/12/2014                  | 01/11/2015                  |
| TISSUE Probe          | SATIMO              | SN 45/11 OCPG45          | 11/14/2013                  | 11/13/2015                  |
| Phantom               | SATIMO              | SN_4511_SAM90            | Validated. No cal required. | Validated. No cal required. |
| Liquid                | SATIMO              | -                        | Validated. No cal required. | Validated. No cal required. |
| Comm Tester           | R&S - CMU200        | 069Y7-158-13-712         | 02/17/2014                  | 02/16/2015                  |
| Comm Tester           | Agilent-8960        | GB46310822               | 02/17/2014                  | 02/16/2015                  |
| Multimeter            | Keithley 2000       | 1188656                  | 02/17/2014                  | 02/16/2015                  |
| Dipole                | SATIMO SID900       | SN46/11 DIP<br>0G900-185 | 11/14/2013                  | 11/13/2015                  |
| Dipole                | SATIMO SID1900      | SN46/11 DIP<br>1G900-187 | 11/14/2013                  | 11/13/2015                  |
| Dipole                | SATIMO SID2450      | SN46/11 DIP<br>2G450-189 | 11/14/2013                  | 11/13/2015                  |
| Signal Generator      | Agilent-E4438C      | MY44260051               | 02/23/2014                  | 02/22/2015                  |
| Power Sensor          | NRP-Z23             | US38261498               | 02/17/2014                  | 02/16/2015                  |
| SPECTRUM ANALYZER     | Agilent/E4440A      | MY44303916               | 10/22/2013                  | 10/21/2014                  |
| Network Analyzer      | Rhode & Schwarz ZVA | SN100132                 | 02/17/2014                  | 02/16/2015                  |

Note: Per KDB 865664 Dipole SAR Validation Verification, AGC Lab has adopted 3 years calibration intervals. On annual basis, every measurement dipole has been evaluated and is in compliance with the following criteria:

1. There is no physical damage on the dipole;
2. System validation with specific dipole is within 10% of calibrated value;
3. Return-loss is within 20% of calibrated measurement;
4. Impedance is within 5Ω of calibrated measurement.

## 9. MEASUREMENT UNCERTAINTY

| <b>SATIMO Uncertainty</b>   |         |     |             |                |                   |                   |                           |                           |              |
|---|---------|-----|-------------|----------------|-------------------|-------------------|---------------------------|---------------------------|--------------|
| Measurement uncertainty for 300MHz to 3GHz averaged over 1 gram / 10 gram.      |         |     |             |                |                   |                   |                           |                           |              |
| Error Description   | Sec     | Sec | Tol<br>(±%) | Prob.<br>Dist. | (Ci)<br>1g        | (Ci)<br>10g       | Std.<br>Unc.<br>(1g) (±%) | Std.<br>Unc.<br>(10g)(±%) | (Vi)<br>Veff |
| <b>Measurement System</b>   |         |     |             |                |                   |                   |                           |                           |              |
| Probe Calibration   | E.2.1   | 6   | N           | 1              | 1                 | 1                 | 6                         | 6                         | ∞            |
| Axial Isotropy  | E.2.2   | 3   | R           | $\sqrt{3}$     | $(1 - C_p)^{1/2}$ | $(1 - C_p)^{1/2}$ | 1.22474                   | 1.22474                   | ∞            |
| Hemispherical Isotropy  | E.2.2   | 5   | R           | $\sqrt{3}$     | $\sqrt{C_p}$      | $\sqrt{C_p}$      | 2.04124                   | 2.04124                   | ∞            |
| Boundary Effects  | E.2.3   | 1   | R           | $\sqrt{3}$     | 1                 | 1                 | 0.57735                   | 0.57735                   | ∞            |
| Linearity   | E.2.4   | 5   | R           | $\sqrt{3}$     | 1                 | 1                 | 2.88675                   | 2.88675                   | ∞            |
| System Detection Limits   | E.2.5   | 1   | R           | $\sqrt{3}$     | 1                 | 1                 | 0.57735                   | 0.57735                   | ∞            |
| Readout Electronics   | E.2.6   | 0.5 | N           | 1              | 1                 | 1                 | 0.5                       | 0.5                       | ∞            |
| Response Time   | E.2.7   | 0.2 | R           | $\sqrt{3}$     | 1                 | 1                 | 0.11547                   | 0.11547                   | ∞            |
| Integration Time  | E.2.8   | 2   | R           | $\sqrt{3}$     | 1                 | 1                 | 1.1547                    | 1.1547                    | ∞            |
| RF Ambient Noise  | E.6.1   | 3   | R           | $\sqrt{3}$     | 1                 | 1                 | 1.73205                   | 1.73205                   | ∞            |
| Probe Positioner Mechanical Tolerance   | E.6.2   | 2   | R           | $\sqrt{3}$     | 1                 | 1                 | 1.1547                    | 1.1547                    | ∞            |
| Probe Positioning with Respect to Phantom Shell                                 | E.6.3   | 1   | R           | $\sqrt{3}$     | 1                 | 1                 | 0.57735                   | 0.57735                   | ∞            |
| Extrapolation, interpolation and Integration Algorithms for Max. SAR Evaluation | E.5.2   | 1.5 | R           | $\sqrt{3}$     | 1                 | 1                 | 0.86603                   | 0.86603                   | ∞            |
| <b>Dipole</b>   |         |     |             |                |                   |                   |                           |                           |              |
| Device Positioning  | 8,E.4.2 | 1   | N           | $\sqrt{3}$     | 1                 | 1                 | 0.57735                   | 0.57735                   | N-1          |
| Power Drift   | 8.6.6.2 | 2   | R           | $\sqrt{3}$     | 1                 | 1                 | 1.1547                    | 1.1547                    | ∞            |
| <b>Phantom and Tissue Parameters</b>  |         |     |             |                |                   |                   |                           |                           |              |
| Phantom Uncertainty   | E.3.1   | 4   | R           | $\sqrt{3}$     | 1                 | 1                 | 2.3094                    | 2.3094                    | ∞            |
| Liquid Conductivity (target)  | E.3.2   | 5   | R           | $\sqrt{3}$     | 0.64              | 0.43              | 1.84752                   | 1.2413                    | ∞            |
| Liquid Conductivity (meas.)   | E.3.3   | 2.5 | N           | 1              | 0.64              | 0.43              | 1.6                       | 1.075                     | ∞            |
| Liquid Permittivity (target)  | E.3.2   | 3   | R           | $\sqrt{3}$     | 0.6               | 0.49              | 1.03923                   | 0.8487                    | ∞            |
| Liquid Permittivity (meas.)   | E.3.3   | 2.5 | N           | 1              | 0.6               | 0.49              | 1.5                       | 1.225                     | M            |
| Combined Standard Uncertainty   |         |     | RSS         |                |                   |                   | 8.09272                   | 7.9296                    |              |
| Expanded Uncertainty (95%CONFIDENCE INTERVAL)                                   |         |     | k           |                |                   |                   | 16.18544                  | 15.8592                   |              |

## 10. CONDUCTED POWER MEASUREMENT GSM BAND

| Mode                 | Frequency(MHz) | Avg. Burst Power(dBm) | Duty cycle Factor(dBm) | Frame Power(dBm) |
|----------------------|----------------|-----------------------|------------------------|------------------|
| Maximum Power <1>    |                |                       |                        |                  |
| GSM 835              | 824.2          | <b>31.89</b>          | -9                     | 22.89            |
|                      | 836.6          | 31.72                 | -9                     | 22.72            |
|                      | 848.8          | 31.66                 | -9                     | 22.66            |
| GPRS 835<br>(1 Slot) | 824.2          | 31.63                 | -9                     | 22.63            |
|                      | 836.6          | 31.48                 | -9                     | 22.48            |
|                      | 848.8          | 31.52                 | -9                     | 22.52            |
| GPRS 835<br>(2 Slot) | 824.2          | 28.88                 | -6                     | 22.88            |
|                      | 836.6          | 28.78                 | -6                     | 22.78            |
|                      | 848.8          | 28.62                 | -6                     | 22.62            |
| GPRS 835<br>(3 Slot) | 824.2          | 26.57                 | -4.26                  | 22.31            |
|                      | 836.6          | 26.53                 | -4.26                  | 22.27            |
|                      | 848.8          | 26.48                 | -4.26                  | 22.22            |
| GPRS 835<br>(4 Slot) | 824.2          | 25.64                 | -3                     | 22.64            |
|                      | 836.6          | 25.61                 | -3                     | 22.61            |
|                      | 848.8          | 25.47                 | -3                     | 22.47            |
| PCS1900              | 1850.2         | <b>28.91</b>          | -9                     | 19.91            |
|                      | 1880           | 28.83                 | -9                     | 19.83            |
|                      | 1909.8         | 28.78                 | -9                     | 19.78            |
| GPRS1900<br>(1 Slot) | 1850.2         | 28.75                 | -9                     | 19.75            |
|                      | 1880           | 28.68                 | -9                     | 19.68            |
|                      | 1909.8         | 28.47                 | -9                     | 19.47            |
| GPRS1900<br>(2 Slot) | 1850.2         | 25.83                 | -6                     | 19.83            |
|                      | 1880           | 25.68                 | -6                     | 19.68            |
|                      | 1909.8         | 25.59                 | -6                     | 19.59            |
| GPRS1900<br>(3 Slot) | 1850.2         | 23.64                 | -4.26                  | 19.38            |
|                      | 1880           | 23.56                 | -4.26                  | 19.3             |
|                      | 1909.8         | 23.51                 | -4.26                  | 19.25            |
| GPRS1900<br>(4 Slot) | 1850.2         | 22.67                 | -3                     | 19.67            |
|                      | 1880           | 22.55                 | -3                     | 19.55            |
|                      | 1909.8         | 22.43                 | -3                     | 19.43            |
| Maximum Power <2>    |                |                       |                        |                  |
| GSM 835              | 824.2          | 31.48                 | -9                     | 22.48            |
| PCS1900              | 1850.2         | 28.52                 | -9                     | 19.52            |

Note 1:

The Frame Power (Source-based time-averaged Power) is scaled the maximum burst average power based on time slots. The calculated methods are show as following:

Frame Power = Max burst power (1 Up Slot) – 9 dB

Frame Power = Max burst power (2 Up Slot) – 6 dB

Frame Power = Max burst power (3 Up Slot) -4.26dB

Frame Power = Max burst power (4 Up Slot) – 3 dB

**WIFI**

| Mode        | Data Rate (Mbps) | Channel | Frequency(MHz) | Avg. Burst Power(dBm) |
|-------------|------------------|---------|----------------|-----------------------|
| 802.11b     | 1                | 01      | 2412           | 9.37                  |
|             |                  | 06      | 2437           | <b>9.8</b>            |
|             |                  | 11      | 2462           | 9.31                  |
| 802.11g     | 6                | 01      | 2412           | 7.5                   |
|             |                  | 06      | 2437           | 7.79                  |
|             |                  | 11      | 2462           | 7.34                  |
| 802.11n(20) | 6.5              | 01      | 2412           | 7.36                  |
|             |                  | 06      | 2437           | 7.6                   |
|             |                  | 11      | 2462           | 7.21                  |
| 802.11n(40) | 13.5             | 03      | 2422           | 4.35                  |
|             |                  | 06      | 2437           | 4.83                  |
|             |                  | 09      | 2452           | 4.53                  |

**Bluetooth\_V3.0**

| Modulation     | Channel | Frequency(MHz) | Average Power (dBm) |
|----------------|---------|----------------|---------------------|
| GFSK           | 0       | 2402           | -0.05               |
|                | 39      | 2441           | 0.77                |
|                | 78      | 2480           | <b>1.05</b>         |
| $\pi/4$ -DQPSK | 0       | 2402           | -0.72               |
|                | 39      | 2441           | 0.04                |
|                | 78      | 2480           | 0.19                |
| 8-DPSK         | 0       | 2402           | -1.85               |
|                | 39      | 2441           | -0.81               |
|                | 78      | 2480           | -0.6                |

## 11. TEST RESULTS

### 11.1. SAR Test Results Summary

#### 11.1.1. Test position and configuration

Head SAR was performed with the device configured in the positions according to IEEE1528, and Body SAR was performed with the device 10mm from the phantom; Body SAR was also performed with the headset attached and without. The overall device length and width(11.8cm×6.1cm) are >9cm×5cm, Hotspot mode with a test separation distance of 10mm.

#### 11.1.2. Operation Mode

- According to KDB 447498 D01 v05r01 ,for each exposure position, if the highest 1-g SAR is  $\leq 0.8$  W/kg, testing for low and high channel is optional.
- Per KDB 865664 D01 v01r01,for each frequency band, if the measured SAR is  $\geq 0.8$ W/Kg, testing for repeated SAR measurement is required , that the highest measured SAR is only to be tested. When the SAR results are near the limit, the following procedures are required for each device to verify these types of SAR measurement related variation concerns by repeating the highest measured SAR configuration in each frequency band.
  - (1) When the original highest measured SAR is  $\geq 0.8$ W/Kg, repeat that measurement once.
  - (2) Perform a second repeated measurement only if the ratio of largest to smallest SAR for the original and first repeated measurements is  $> 1.20$  or when the original or repeated measurement is  $\geq 1.45$  W/Kg.
  - (3) Perform a third repeated measurement only if the original, first and second repeated measurement is  $\geq 1.5$  W/Kg and ratio of largest to smallest SAR for the original, first and second measurement is  $\geq 1.20$ .
- Body-worn exposure conditions are intended to voice call operations, therefore GSM voice call mode is selected to be test.
- According to KDB 648474 D04 v01r01,when the reported SAR for a body-worn accessory measured without a headset connected to the handset is  $\leq 1.2$ W/Kg, SAR testing with a headset connected is not required.
- According to 941225 D06, when the overall device length and width are >9cm×5cm, Hotspot mode with a test separation distance of 10mm. For device with form factors smaller than 9cm×5cm, Hotspot mode with a test separation distance of 5mm. Body SAR was also performed with the headset attached and without.
- According to 248227 D01, SAR is not required for 802.11g channels when the maximum average output power is less than 1/4dB higher than measured on the corresponding 802.11b channels.
- Maximum Scaling SAR in order to calculate the Maximum SAR values to test under the standard Peak Power, Calculation method is as follows:  
Maximum Scaling SAR =tested SAR (Max.) × [maximum turn-up power (mw)/ maximum measurement output power(mw) ]

### 11.1.3. Test Result

| SAR MEASUREMENT                        |       |     |           |                    |                            |                          |                          |                   |            |
|--|-------|-----|-----------|--------------------|----------------------------|--------------------------|--------------------------|-------------------|------------|
| Ambient Temperature (°C) : 21 ± 2      |       |     |           |                    | Relative Humidity (%) : 55 |                          |                          |                   |            |
| Liquid Temperature (°C) : 21 ± 2       |       |     |           |                    | Depth of Liquid (cm):>15   |                          |                          |                   |            |
| Product: Sync Plus 3.5                 |       |     |           |                    |                            |                          |                          |                   |            |
| Test Mode: GSM835 with GMSK modulation |       |     |           |                    |                            |                          |                          |                   |            |
| Position                               | Mode  | Ch. | Fr. (MHz) | Power Drift (<±5%) | SAR (1g) (W/kg)            | Max. Turn-up Power (dBm) | Meas. output Power (dBm) | Scaled SAR (W/Kg) | Limit W/kg |
| <b>SIM 1 Card</b>                      |       |     |           |                    |                            |                          |                          |                   |            |
| Left Cheek                             | voice | 190 | 836.6     | 0.25               | <b>0.230</b>               | 33.00                    | 31.72                    | <b>0.309</b>      | 1.6        |
| Left Tilt                              | voice | 190 | 836.6     | -1.02              | 0.194                      | 33.00                    | 31.72                    | 0.260             | 1.6        |
| Right Cheek                            | voice | 190 | 836.6     | -0.36              | 0.225                      | 33.00                    | 31.72                    | 0.302             | 1.6        |
| Right Tilt                             | voice | 190 | 836.6     | 0.47               | 0.177                      | 33.00                    | 31.72                    | 0.238             | 1.6        |
| Body back                              | voice | 190 | 836.6     | -0.25              | <b>0.561</b>               | 33.00                    | 31.72                    | <b>0.753</b>      | 1.6        |
| Body front                             | voice | 190 | 836.6     | 0.36               | 0.276                      | 33.00                    | 31.72                    | 0.371             | 1.6        |
| <b>SIM 2 Card</b>                      |       |     |           |                    |                            |                          |                          |                   |            |
| Left Cheek                             | voice | 190 | 836.6     | 0.17               | 0.218                      | 33.00                    | 31.72                    | 0.293             | 1.6        |

Note:

- When the 1-g SAR is ≤ 0.8 W/kg, testing for low and high channel is optional. Refer to KDB 941225.
- The test separation for body is 10mm of all above table.
- The worst mode is voice mode.

| SAR MEASUREMENT                         |       |     |           |                    |                            |                          |                          |                   |            |
|---|-------|-----|-----------|--------------------|----------------------------|--------------------------|--------------------------|-------------------|------------|
| Ambient Temperature (°C) : 21 ± 2       |       |     |           |                    | Relative Humidity (%) : 55 |                          |                          |                   |            |
| Liquid Temperature (°C) : 21 ± 2        |       |     |           |                    | Depth of Liquid (cm):>15   |                          |                          |                   |            |
| Product: Sync Plus 3.5                  |       |     |           |                    |                            |                          |                          |                   |            |
| Test Mode: PCS1900 with GMSK modulation |       |     |           |                    |                            |                          |                          |                   |            |
| Position                                | Mode  | Ch. | Fr. (MHz) | Power Drift (<±5%) | SAR (1g) (W/kg)            | Max. Turn-up Power (dBm) | Meas. output Power (dBm) | Scaled SAR (W/Kg) | Limit W/kg |
| <b>SIM 1 Card</b>                       |       |     |           |                    |                            |                          |                          |                   |            |
| Left Cheek                              | voice | 661 | 1880.0    | -0.47              | <b>0.406</b>               | 30.00                    | 28.83                    | <b>0.532</b>      | 1.6        |
| Left Tilt                               | voice | 661 | 1880.0    | 0.69               | 0.070                      | 30.00                    | 28.83                    | 0.092             | 1.6        |
| Right Cheek                             | voice | 661 | 1880.0    | -1.02              | 0.359                      | 30.00                    | 28.83                    | 0.470             | 1.6        |
| Right Tilt                              | voice | 661 | 1880.0    | 0.64               | 0.084                      | 30.00                    | 28.83                    | 0.110             | 1.6        |
| Body back                               | voice | 661 | 1880.0    | -0.78              | <b>0.249</b>               | 30.00                    | 28.83                    | <b>0.326</b>      | 1.6        |
| Body front                              | voice | 661 | 1880.0    | -0.25              | 0.195                      | 30.00                    | 28.83                    | 0.255             | 1.6        |
| <b>SIM 2 Card</b>                       |       |     |           |                    |                            |                          |                          |                   |            |
| Left Cheek                              | voice | 661 | 1880.0    | 0.31               | 0.404                      | 30.00                    | 28.83                    | 0.529             | 1.6        |

Note:

- When the 1-g SAR is ≤ 0.8 W/kg, testing for low and high channel is optional. Refer to KDB 941225.
- The test separation for body is 10mm of all above table.
- The worst mode is voice mode.

| SAR MEASUREMENT                   |      |     |           |                    |                           |                          |                          |                   |            |
|-----------------------------------|------|-----|-----------|--------------------|---------------------------|--------------------------|--------------------------|-------------------|------------|
| Ambient Temperature (°C) : 21 ± 2 |      |     |           |                    | Relative Humidity (%): 55 |                          |                          |                   |            |
| Liquid Temperature (°C) : 21 ± 2  |      |     |           |                    | Depth of Liquid (cm):>15  |                          |                          |                   |            |
| Product: PPNN                     |      |     |           |                    |                           |                          |                          |                   |            |
| Test Mode: Hotspot                |      |     |           |                    |                           |                          |                          |                   |            |
| Position                          | Mode | Ch. | Fr. (MHz) | Power Drift (<±5%) | SAR (1g) (W/kg)           | Max. Turn-up Power (dBm) | Meas. output Power (dBm) | Scaled SAR (W/Kg) | Limit W/kg |
| <b>SIM 1 Card</b>                 |      |     |           |                    |                           |                          |                          |                   |            |
| Body back                         | DTS  | 6   | 2437      | -0.15              | <b>0.256</b>              | 10.0                     | 9.8                      | <b>0.268</b>      | 1.6        |
| Body front                        | DTS  | 6   | 2437      | 0.63               | 0.170                     | 10.0                     | 9.8                      | 0.178             | 1.6        |

Note:

- According to KDB248227, SAR is not required for 802.11n HT20/HT40 channels when the maximum average output power is less than 1/4 dB higher than that measured on the corresponding 802.11a/b channels.
- All of above "DTS" means data transmitters.
- The test separation of all above table for body part is 10mm.



**Simultaneous Multi-band Transmission Evaluation:**  
**Application Simultaneous Transmission information:**

| NO | Simultaneous state              | Portable Handset |           |         | Note           |
|----|---------------------------------|------------------|-----------|---------|----------------|
|    |                                 | Head             | Body-worn | Hotspot |                |
| 1  | GSM(voice)+WLAN 2.4GHz (data)   | Yes              | Yes       | -       | -              |
| 2  | WCDMA(voice)+WLAN 2.4GHz (data) | -                | -         | -       | -              |
| 3  | GSM(voice)+Bluetooth(data)      | Yes              | Yes       | -       | -              |
| 4  | WCDMA(voice)+Bluetooth(data)    | -                | -         | -       | -              |
| 5  | GSM(voice)+WLAN 2.4GHz (data)   | -                | Yes       | Yes     | 2.4GHz Hotspot |
| 6  | WCDMA(voice)+WLAN 2.4GHz (data) | -                | -         | -       | -              |

NOTE:

1. WLAN and BT share the same antenna, and cannot transmit simultaneously.
2. Simultaneous with every transmitter must be the same test position.
3. Based upon KDB 447498 D01 v05, BT SAR is excluded as below table.
4. Based upon KDB 447498 D01 v05, for handsets the test separation distance is determined by the smallest distance between the outer surface of the device and the user; which is 0mm for head SAR AND 10mm for body-worn SAR.
5. If the test separation distance is <5mm, 5mm is used for excluded SAR calculation.
6. For minimum test separation distance  $\cong 50\text{mm}$ , Bluetooth standalone SAR is excluded according to  $[(\text{max. power of channel, including tune-up tolerance, mW}) / (\text{min. test separation distance, mm}) \cdot \sqrt{f \text{ (GHz)}} / x] \cong 3.0$  for 1-g SAR and  $\cong 7.5$  for 10-g extremity SAR
7. KDB 447498 / 4.3.2 (2) when standalone SAR test exclusion applies to an antenna that transmits simultaneously with other antennas, the standalone SAR must be estimated according to following to determine simultaneous transmission SAR test exclusion:
  - a)  $(\text{max. power of channel, including tune-up tolerance, mW}) / (\text{min. test separation distance, mm}) \cdot \sqrt{f \text{ (GHz)}} / x$  W/kg for test separation distances  $\leq 50$  mm; Where  $x = 7.5$  for 1-g SAR, and  $x = 18.75$  for 10-g SAR.
  - b) 0.4W/Kg for 1-g SAR and 1.0W/Kg for 10-g SAR, when the separation distance is  $>50\text{mm}$ .

| Estimated SAR |      | Maximum Average Power |       | Antenna to user (mm) | SAR exclusion threshold (mW) | SAR testing required (Yes/No) | Head (0mm gap) | Body (10mm gap) |
|---------------|------|-----------------------|-------|----------------------|------------------------------|-------------------------------|----------------|-----------------|
|               |      | dBm                   | mW    |                      |                              |                               |                |                 |
| BT            | Head | 2                     | 1.585 | 0                    | 10                           | NO                            | 0.067 W/kg     | 0.033 W/kg      |
|               | Body |                       |       | 10                   |                              |                               |                |                 |
| WIFI          | Head | 10                    | 10    | 0                    | 10                           | NO                            | 0.416 W/kg     | 0.208 W/kg      |
|               | Body |                       |       | 10                   |                              |                               |                |                 |

**Maximum test results (WWAN) with BT and WIFI SAR:**

**BT:** Head (0 cm gap): 0.067 W/kg and Body (1.0 cm gap): 0.033 W/kg  
**WIFI:** Head (0 cm gap): 0.416 W/kg and Body (1.0 cm gap): 0.208 W/kg  
**HOTSPOT:** Body (1.0 cm gap): 0.268 W/kg

**WIFI**

| Position                     | Max. WWAN SAR (W/Kg) | Max. WLAN SAR (W/Kg) | SAR Summation | Limit (W/kg) | SPLSR $\leq 0.04$ (Yes/No) |
|------------------------------|----------------------|----------------------|---------------|--------------|----------------------------|
| <b>GSM850+WLAN 2.4G-DTS</b>  |                      |                      |               |              |                            |
| Left Cheek                   | 0.309                | 0.416                | <b>0.725</b>  | 1.6          | No                         |
| Left Tilt                    | 0.260                | 0.416                | 0.676         | 1.6          | No                         |
| Right Cheek                  | 0.302                | 0.416                | 0.718         | 1.6          | No                         |
| Right Tilt                   | 0.238                | 0.416                | 0.654         | 1.6          | No                         |
| Body back                    | 0.753                | 0.208                | <b>0.961</b>  | 1.6          | No                         |
| Body front                   | 0.371                | 0.208                | 0.579         | 1.6          | No                         |
| <b>PCS1900+WLAN 2.4G-DTS</b> |                      |                      |               |              |                            |
| Left Cheek                   | 0.532                | 0.416                | <b>0.948</b>  | 1.6          | No                         |
| Left Tilt                    | 0.092                | 0.416                | 0.508         | 1.6          | No                         |
| Right Cheek                  | 0.470                | 0.416                | 0.886         | 1.6          | No                         |
| Right Tilt                   | 0.110                | 0.416                | 0.526         | 1.6          | No                         |
| Body back                    | 0.326                | 0.208                | <b>0.534</b>  | 1.6          | No                         |
| Body front                   | 0.255                | 0.208                | 0.463         | 1.6          | No                         |

**Note:**

- According to KDB 447498 D01 General RF Exposure Guidance v05, when the simultaneous transmission SAR is less than 1.6 W/Kg, SPLSR assessment is not required.
- SPLSR mean is "The SAR to Peak Location Separation Ratio "

**Hotspot**

| Position                        | Max. WWAN SAR (W/Kg) | Max. Hotspot SAR (W/Kg) | SAR Summation | Limit (W/kg) | SPLSR $\leq 0.04$ (Yes/No) |
|---------------------------------|----------------------|-------------------------|---------------|--------------|----------------------------|
| <b>GSM850+Hotspot 2.4G-DTS</b>  |                      |                         |               |              |                            |
| Body back                       | 0.753                | 0.268                   | <b>1.021</b>  | 1.6          | No                         |
| Body front                      | 0.371                | 0.178                   | 0.549         | 1.6          | No                         |
| <b>PCS1900+Hotspot 2.4G-DTS</b> |                      |                         |               |              |                            |
| Body back                       | 0.326                | 0.268                   | <b>0.594</b>  | 1.6          | No                         |
| Body front                      | 0.255                | 0.178                   | 0.433         | 1.6          | No                         |

**Note:**

- According to KDB 447498 D01 General RF Exposure Guidance v05, when the simultaneous transmission SAR is less than 1.6 W/Kg, SPLSR assessment is not required.
- SPLSR mean is "The SAR to Peak Location Separation Ratio "

**BT**

| Position                      | Max. WWAN SAR (W/Kg) | Estimated SAR (W/Kg) | SAR Summation | Limit (W/kg) | SPLSR $\leq 0.04$ (Yes/No) |
|-------------------------------|----------------------|----------------------|---------------|--------------|----------------------------|
| <b>GSM850+Bluetooth-DSS</b>   |                      |                      |               |              |                            |
| Left Cheek                    | 0.309                | 0.067                | <b>0.376</b>  | 1.6          | No                         |
| Left Tilt                     | 0.260                | 0.067                | 0.327         | 1.6          | No                         |
| Right Cheek                   | 0.302                | 0.067                | 0.369         | 1.6          | No                         |
| Right Tilt                    | 0.238                | 0.067                | 0.305         | 1.6          | No                         |
| Body back                     | 0.753                | 0.033                | <b>0.786</b>  | 1.6          | No                         |
| Body front                    | 0.371                | 0.033                | 0.404         | 1.6          | No                         |
| <b>PCS1900+ Bluetooth-DSS</b> |                      |                      |               |              |                            |
| Left Cheek                    | 0.532                | 0.067                | <b>0.599</b>  | 1.6          | No                         |
| Left Tilt                     | 0.092                | 0.067                | 0.159         | 1.6          | No                         |
| Right Cheek                   | 0.470                | 0.067                | 0.537         | 1.6          | No                         |
| Right Tilt                    | 0.110                | 0.067                | 0.177         | 1.6          | No                         |
| Body back                     | 0.326                | 0.033                | <b>0.359</b>  | 1.6          | No                         |
| Body front                    | 0.255                | 0.033                | 0.288         | 1.6          | No                         |

**Note:**

- According to KDB 447498 D01 General RF Exposure Guidance v05, when the Sum of the simultaneous transmission SAR is lesser than 1.6 W/Kg, SPLSR assessment is not required.
- SPLSR mean is "The SAR to Peak Location Ratio " .

## APPENDIX A. SAR SYSTEM VALIDATION DATA

Test Laboratory: AGC Lab

Date: Sep. 09,2014

System Check Head 835 MHz

DUT: Dipole 900 MHz Type: SID 900

Communication System CW; Communication System Band: D835 (835.0 MHz); Duty Cycle: 1:1; Conv.F=5.27

Frequency: 835 MHz; Medium parameters used:  $f = 835$  MHz;  $\sigma=0.88$  mho/m;  $\epsilon_r =40.72$ ;  $\rho= 1000$  kg/m<sup>3</sup> ;

Phantom section: Flat Section; Input Power=10dBm

Ambient temperature (°C): 21, Liquid temperature (°C): 21

SATIMO Configuration:

- Probe: SSE5; Calibrated: 01/12/2014; Serial No.:SN 22/12 EP159
- Sensor-Surface: 4mm (Mechanical Surface Detection)
- Phantom: Flat Phantom; Type: Elliptical Phantom
- Measurement SW: OpenSAR V4\_02\_01

Configuration/System Check GSM 835 Head/Area Scan: Measurement grid: dx=8mm,dy=8mm

Configuration/System Check GSM 835 Head/Zoom Scan: Measurement grid: dx=8mm,dy=8mm, dz=5mm

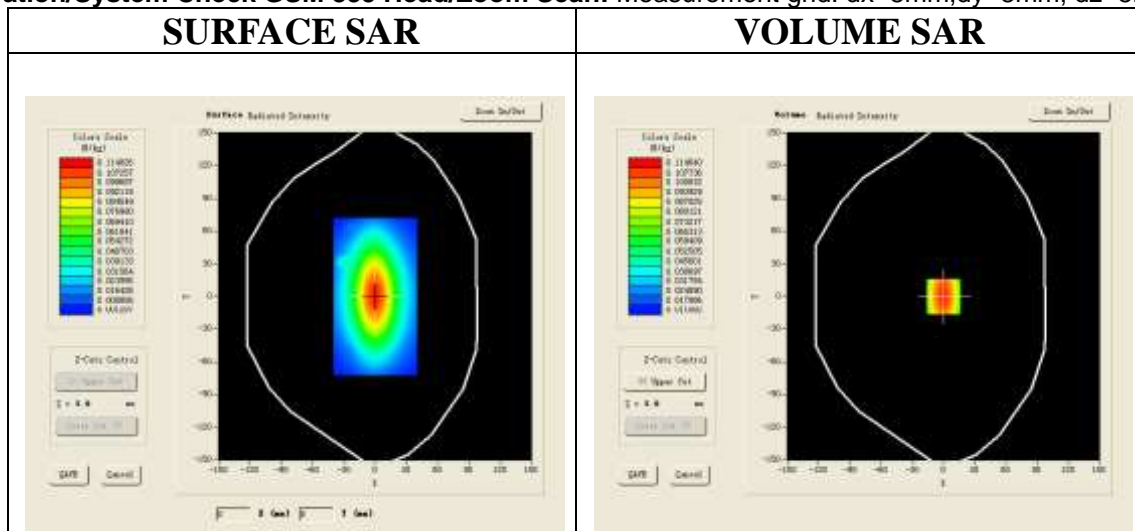

Maximum location: X=0.00, Y=0.00

|                       |          |
|-----------------------|----------|
| <b>SAR 10g (W/Kg)</b> | 0.066852 |
| <b>SAR 1g (W/Kg)</b>  | 0.107017 |

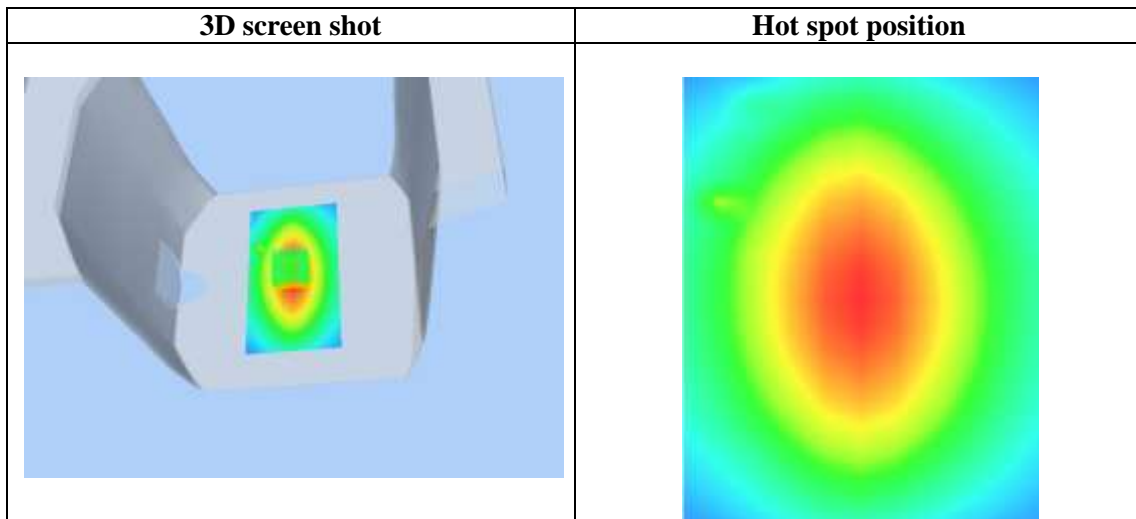
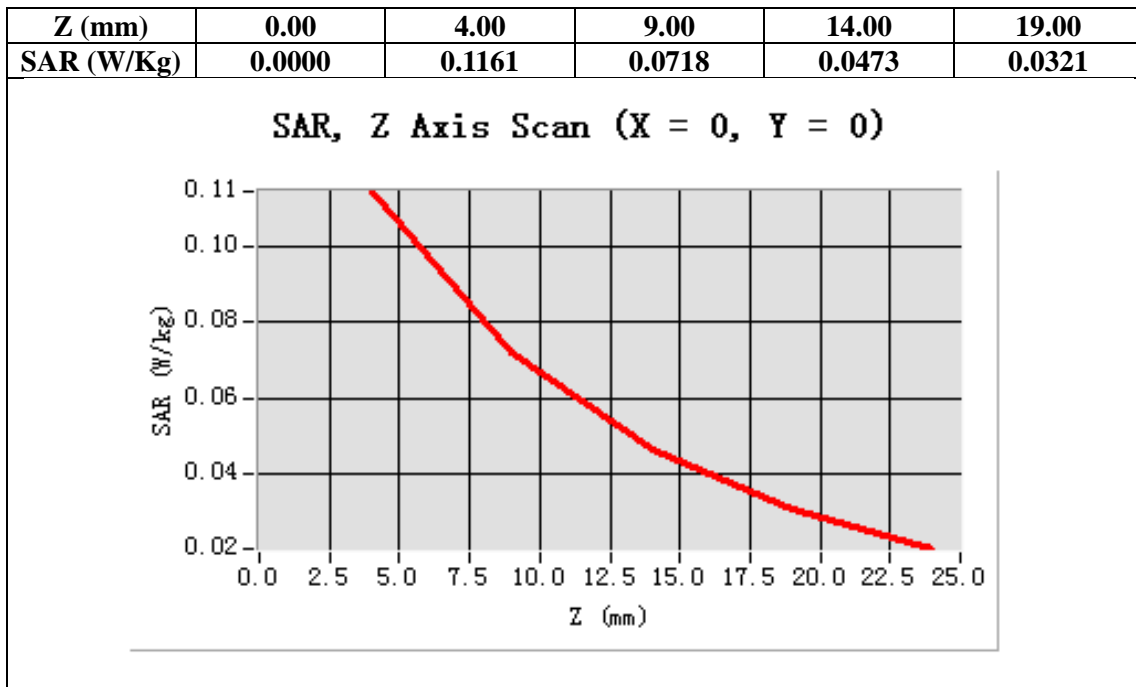

**Test Laboratory: AGC Lab**  
**System Check Body 835 MHz**  
**DUT: Dipole 900 MHz Type: SID 900**

**Date: Sep. 09,2014**

Communication System CW; Communication System Band: D835 (835.0 MHz); Duty Cycle: 1:1; Conv.F=5.48  
Frequency: 835 MHz; Medium parameters used:  $f = 835$  MHz;  $\sigma=0.95$  mho/m;  $\epsilon_r =54.93$ ;  $\rho= 1000$  kg/m<sup>3</sup> ;  
Phantom section: Flat Section; Input Power=10dBm  
Ambient temperature (°C): 21, Liquid temperature (°C): 21

SATIMO Configuration:

- Probe: SSE5; Calibrated: 01/12/2014; Serial No.:SN 22/12 EP159
- Sensor-Surface: 4mm (Mechanical Surface Detection)
- Phantom: Flat Phantom; Type: Elliptical Phantom
- Measurement SW: OpenSAR V4\_02\_01

**Configuration/System Check GSM 835 Body/Area Scan:** Measurement grid: dx=8mm,dy=8mm

**Configuration/System Check GSM 835 Body/Zoom Scan:** Measurement grid: dx=8mm,dy=8mm, dz=5mm

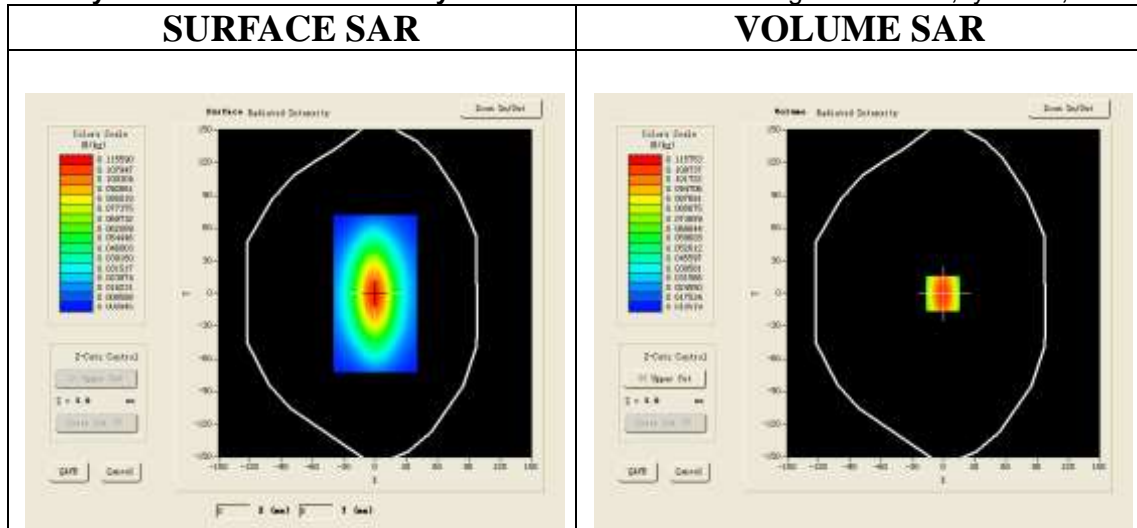

**Maximum location: X=-1.00, Y=0.00**

|                       |          |
|-----------------------|----------|
| <b>SAR 10g (W/Kg)</b> | 0.068325 |
| <b>SAR 1g (W/Kg)</b>  | 0.109912 |

| Z (mm)     | 0.00   | 4.00   | 9.00   | 14.00  | 19.00  |
|------------|--------|--------|--------|--------|--------|
| SAR (W/Kg) | 0.0000 | 0.1140 | 0.0738 | 0.0470 | 0.0293 |

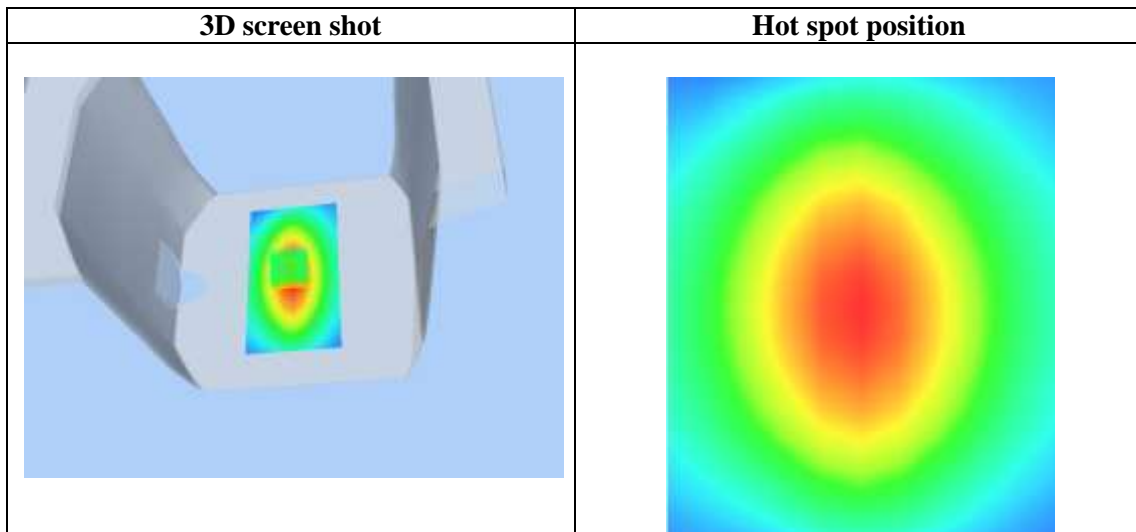
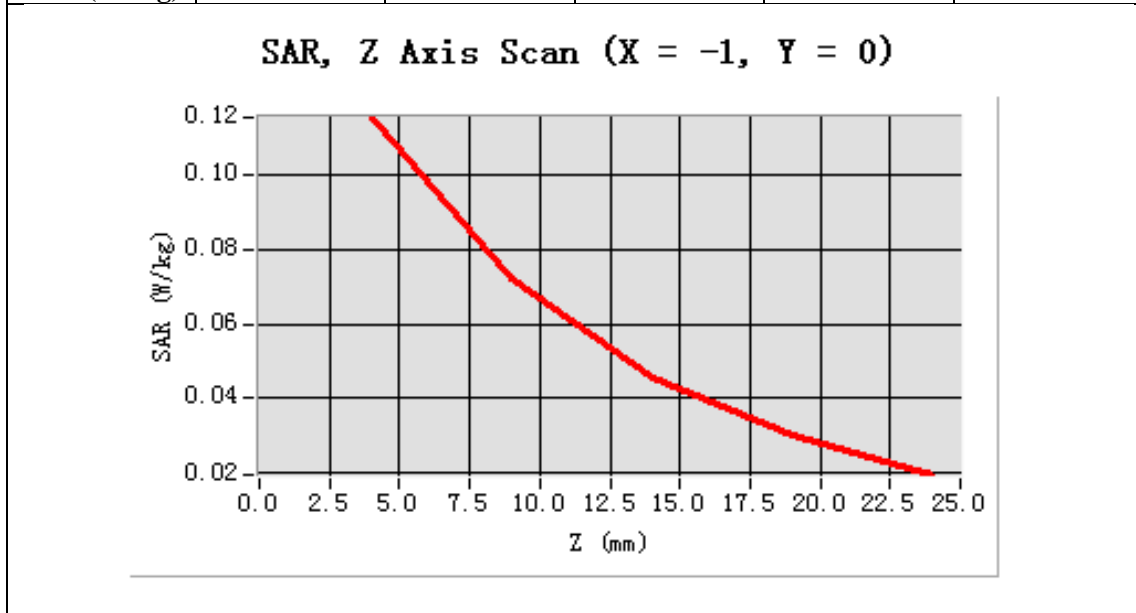

**Test Laboratory: AGC Lab**  
**System Check Head 1900MHz**

**Date: Sep. 09,2014**

**DUT: Dipole 1900 MHz; Type: SID 1900**

Communication System: CW; Communication System Band: D1900 (1900.0 MHz); Duty Cycle:1:1; Conv.F=4.51  
Frequency: 1900 MHz; Medium parameters used:  $f = 1900$  MHz;  $\sigma=1.38$  mho/m;  $\epsilon_r =39.06$ ;  $\rho= 1000$  kg/m<sup>3</sup> ;  
Phantom section: Flat Section; Input Power=10dBm  
Ambient temperature (°C): 21, Liquid temperature (°C): 21

SATIMO Configuration:

- Probe: SSE5; Calibrated: 01/12/2014; Serial No.:SN 22/12 EP159
- Sensor-Surface: 4mm (Mechanical Surface Detection)
- Phantom: Flat Phantom; Type: Elliptical Phantom
- Measurement SW: OpenSAR V4\_02\_01

**Configuration/System Check PCS1900 Head/Area Scan:** Measurement grid: dx=8mm, dy=8mm

**Configuration/System Check PCS1900 Head/Zoom Scan:** Measurement grid: dx=8mm,dy=8mm, dz=5mm

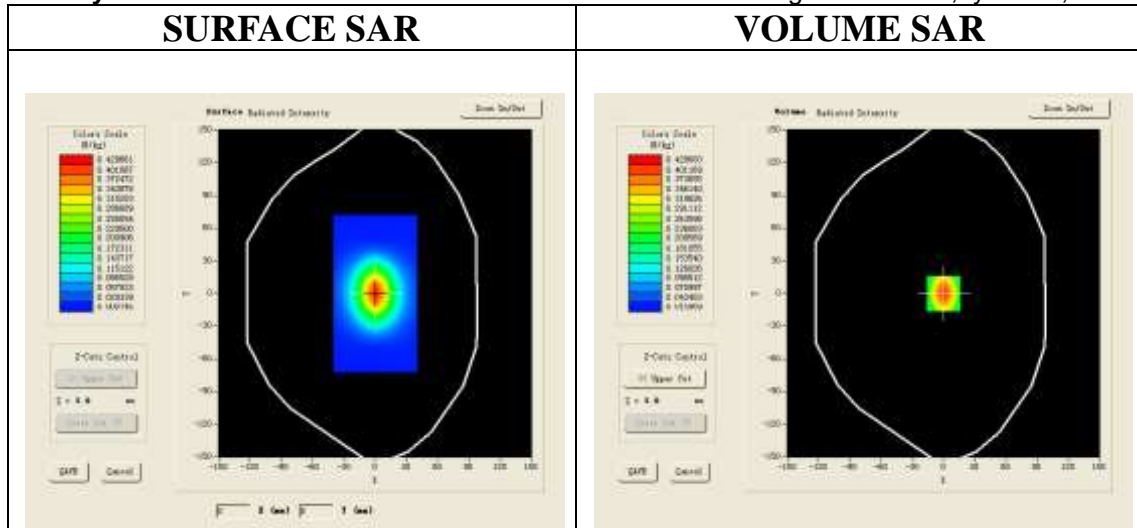

**Maximum location: X=0.00, Y=0.00**

|                       |          |
|-----------------------|----------|
| <b>SAR 10g (W/Kg)</b> | 0.201814 |
| <b>SAR 1g (W/Kg)</b>  | 0.391173 |



| Z (mm)     | 0.00   | 4.00   | 9.00   | 14.00  | 19.00  |
|------------|--------|--------|--------|--------|--------|
| SAR (W/Kg) | 0.0000 | 0.4286 | 0.2462 | 0.1379 | 0.0848 |

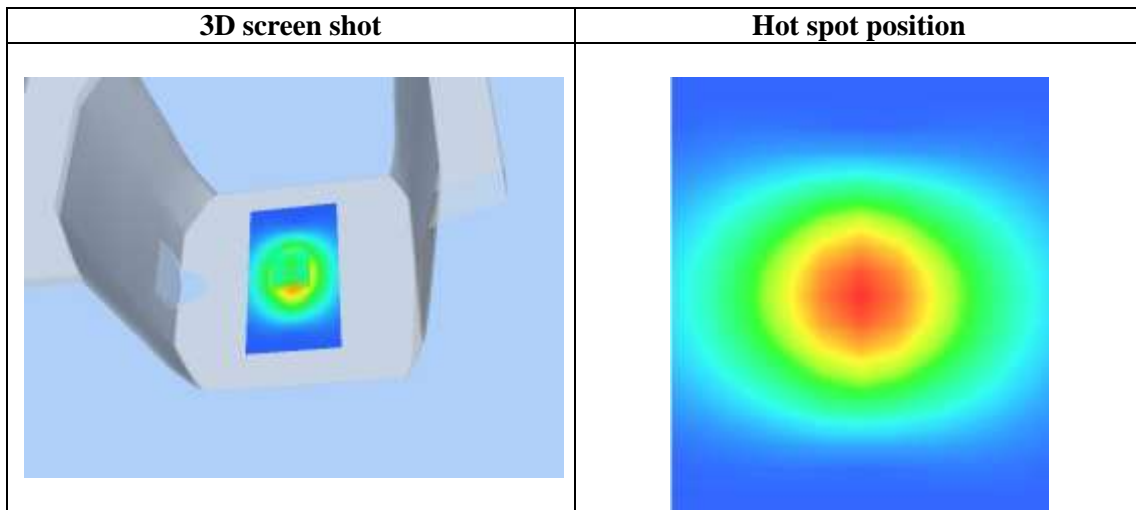
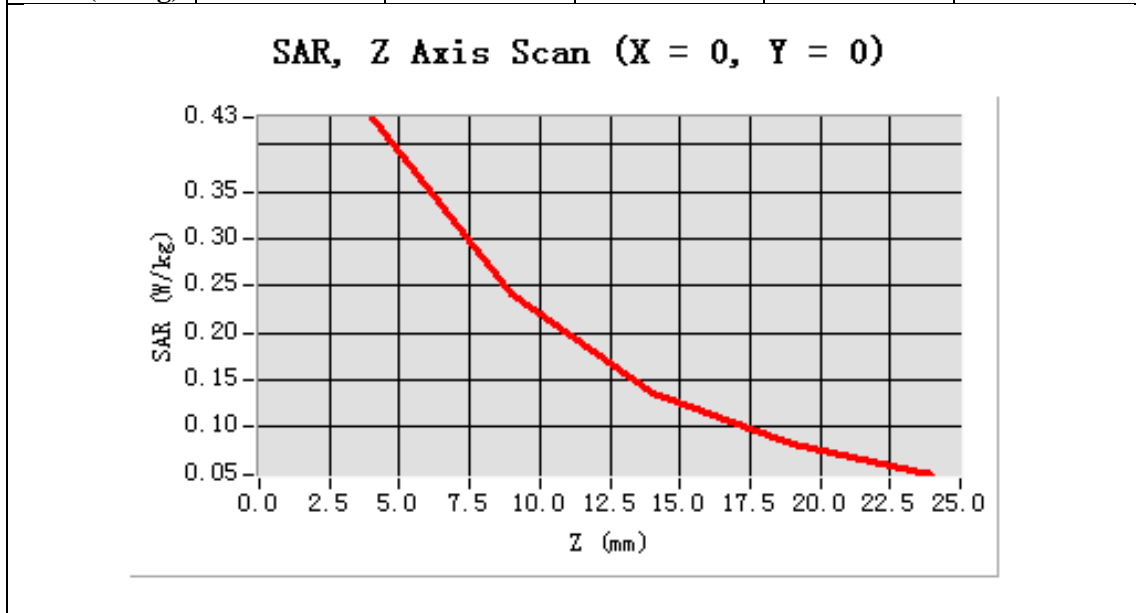

**Test Laboratory: AGC Lab**  
**System Check Body 1900MHz**  
**DUT: Dipole 1900 MHz; Type: SID 1900**

**Date: Sep. 09,2014**

Communication System: CW; Communication System Band: D1900 (1900.0 MHz); Duty Cycle:1:1; Conv.F=4.45  
Frequency: 1900 MHz; Medium parameters used:  $f = 1900$  MHz;  $\sigma=1.55$  mho/m;  $\epsilon_r =54.04$ ;  $\rho= 1000$  kg/m<sup>3</sup> ;  
Phantom section: Flat Section; Input Power=10dBm  
Ambient temperature (°C): 21, Liquid temperature (°C): 21

SATIMO Configuration:

- Probe: SSE5; Calibrated: 01/12/2014; Serial No.:SN 22/12 EP159
- Sensor-Surface: 4mm (Mechanical Surface Detection)
- Phantom: Flat Phantom; Type: Elliptical Phantom
- Measurement SW: OpenSAR V4\_02\_01

**Configuration/System Check PCS1900 Body/Area Scan:** Measurement grid: dx=8mm, dy=8mm

**Configuration/System Check PCS1900 Body/Zoom Scan:** Measurement grid: dx=8mm,dy=8mm, dz=5mm

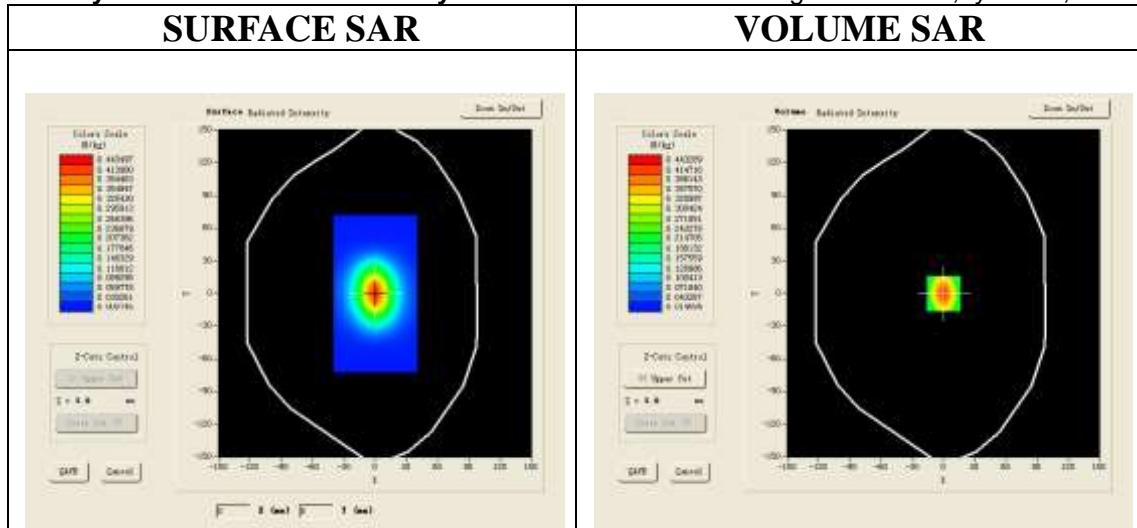

**Maximum location: X=0.00, Y=0.00**

|                       |          |
|-----------------------|----------|
| <b>SAR 10g (W/Kg)</b> | 0.200530 |
| <b>SAR 1g (W/Kg)</b>  | 0.401040 |

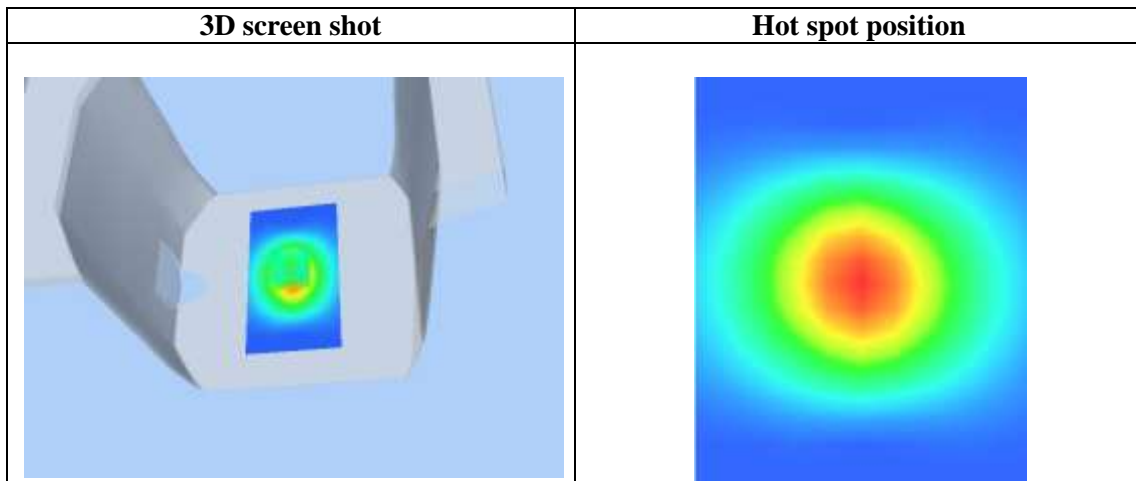
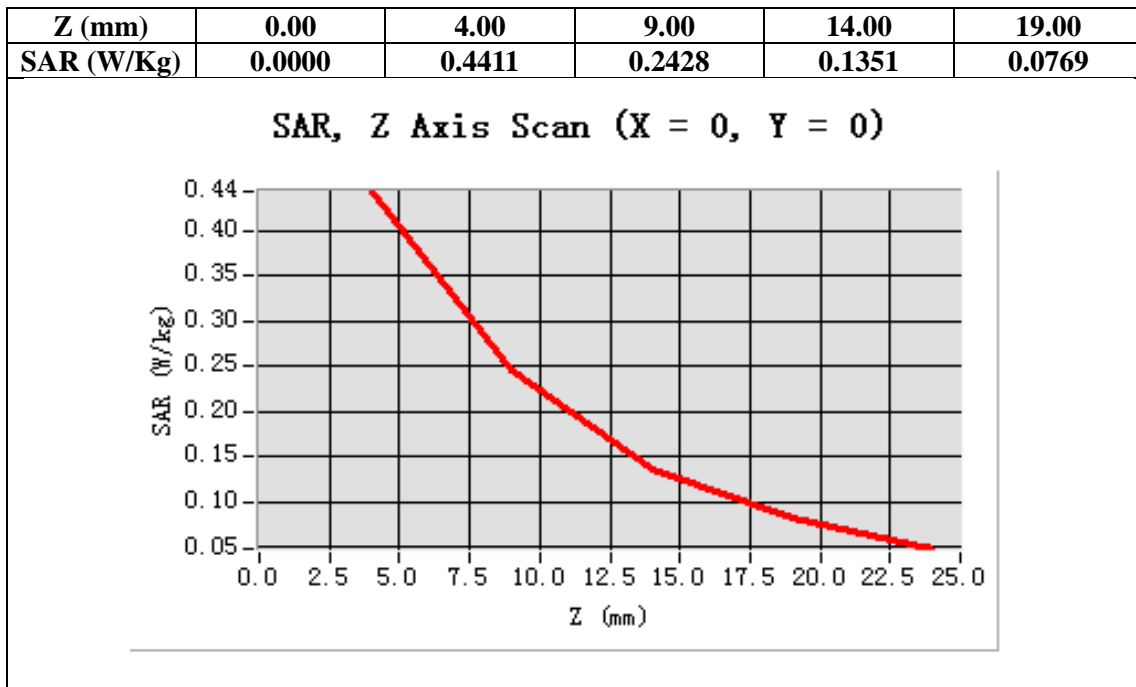

**Test Laboratory: AGC Lab**  
**System Check Body 2450 MHz**  
**DUT: Dipole 2450 MHz Type: SID 2450**

**Date: Sep. 09,2014**

Communication System: CW; Communication System Band: D2450 (2450.0 MHz); Duty Cycle: 1:1; Conv.F=4.31  
Frequency: 2450 MHz; Medium parameters used:  $f = 2450$  MHz;  $\sigma = \delta G$  mho/m;  $\epsilon_r = \epsilon_r G$ ;  $\rho = 1000$  kg/m<sup>3</sup> ;  
Phantom section: Flat Section; Input Power=10dBm  
Ambient temperature (°C): 21, Liquid temperature (°C): 21

SATIMO Configuration:

- Probe: SSE5; Calibrated: 01/12/2014; Serial No.:SN 22/12 EP159
- Sensor-Surface: 4mm (Mechanical Surface Detection)
- Phantom: Flat Phantom; Type: Elliptical Phantom
- Measurement SW: OpenSAR V4\_02\_01

**Configuration/System Check 2450 MHz Body/Area Scan:** Measurement grid: dx=8mm,dy=8mm

**Configuration/System Check 2450 MHz Body/Zoom Scan:** Measurement grid: dx=8mm,dy=8mm, dz=5mm

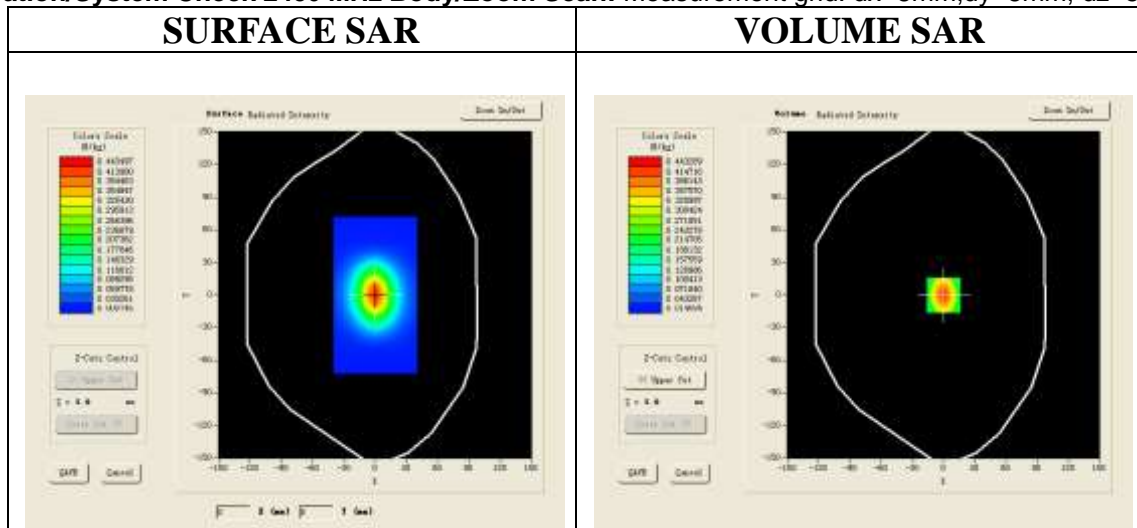

**Maximum location: X=0.00, Y=0.00**

|                       |          |
|-----------------------|----------|
| <b>SAR 10g (W/Kg)</b> | 0.236689 |
| <b>SAR 1g (W/Kg)</b>  | 0.498789 |

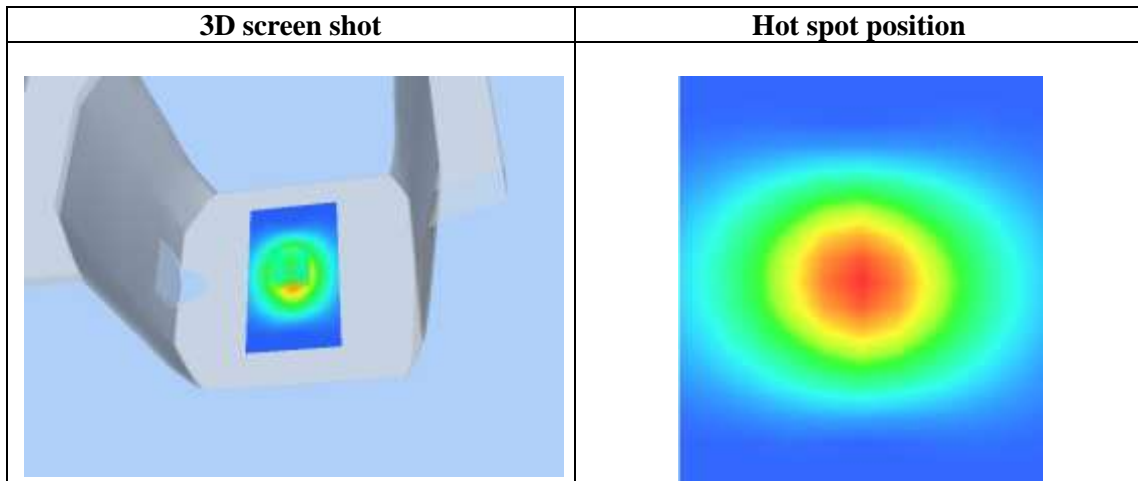
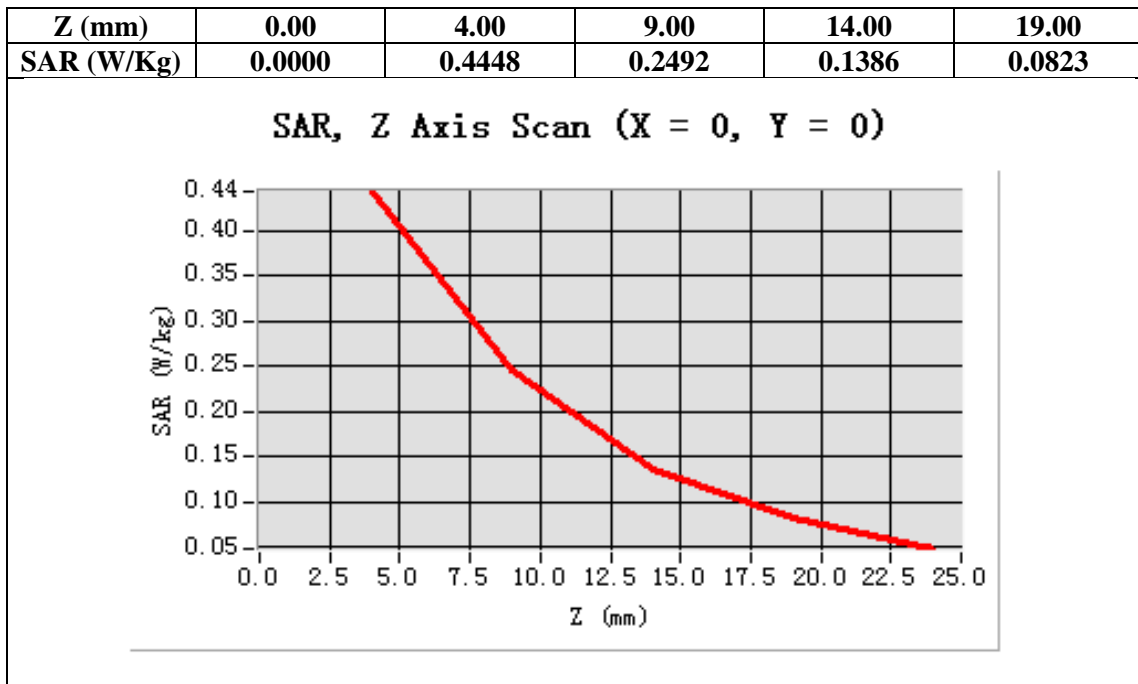

## APPENDIX B. SAR MEASUREMENT DATA

Test Laboratory: AGC Lab

Date: Sep. 09,2014

GSM 835 Mid-Touch-Left <SIM 1>

DUT: Sync Plus 3.5; Type: X350

Communication System: Generic GSM; Communication System Band: GSM 835; Duty Cycle: 1:8.3; Conv.F=5.27  
Frequency: 836.6 MHz; Medium parameters used:  $f = 835$  MHz;  $\sigma=0.88$  mho/m;  $\epsilon_r=40.72$ ;  $\rho= 1000$  kg/m<sup>3</sup> ;  
Phantom section: Left Section  
Ambient temperature (°C): 21.0, Liquid temperature (°C): 21.0

SATIMO Configuration:

- Probe: SSE5; Calibrated: 01/12/2014; Serial No.:SN 22/12 EP159
- Sensor-Surface: 4mm (Mechanical Surface Detection)
- Phantom: Flat Phantom; Type: Elliptical Phantom
- Measurement SW: OpenSAR V4\_02\_01

Configuration/GSM 835 Mid-Touch-Left/Area Scan: Measurement grid: dx=8mm, dy=8mm

Configuration/GSM 835 Mid-Touch-Left/Zoom Scan: Measurement grid: dx=8mm,dy=8mm, dz=5mm

|                        |                                      |
|------------------------|--------------------------------------|
| <b>Area Scan</b>       | sam_direct_droit2_surf8mm.txt        |
| <b>ZoomScan</b>        | 5x5x7,dx=8mm dy=8mm dz=5mm,Very fast |
| <b>Phantom</b>         | Left head                            |
| <b>Device Position</b> | Cheek                                |
| <b>Band</b>            | GSM 835                              |
| <b>Channels</b>        | Middle                               |
| <b>Signal</b>          | TDMA (Crest factor: 8.0)             |

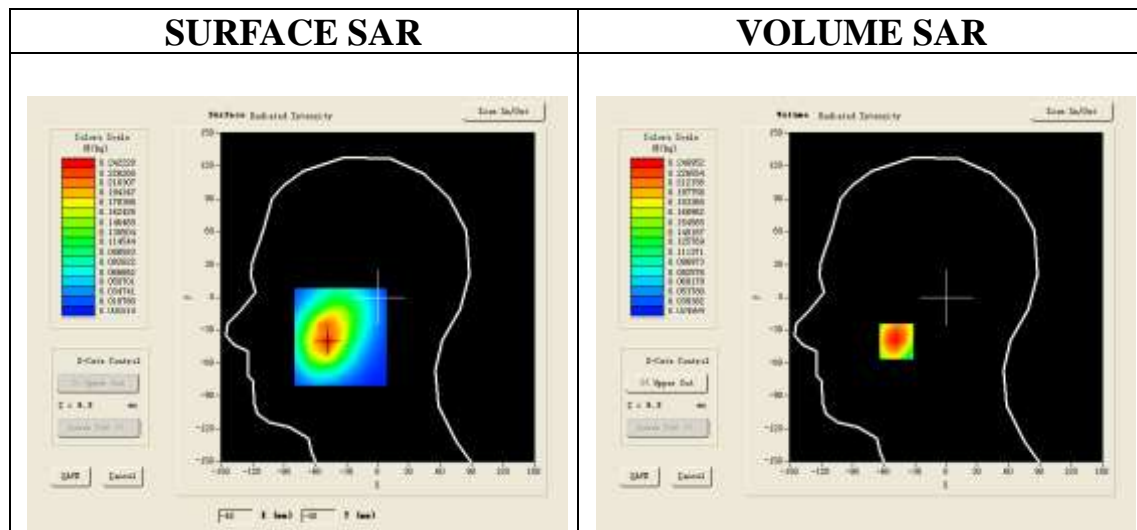

**Maximum location: X=-48.00, Y=-40.00**

|                       |          |
|-----------------------|----------|
| <b>SAR 10g (W/Kg)</b> | 0.157011 |
| <b>SAR 1g (W/Kg)</b>  | 0.230455 |

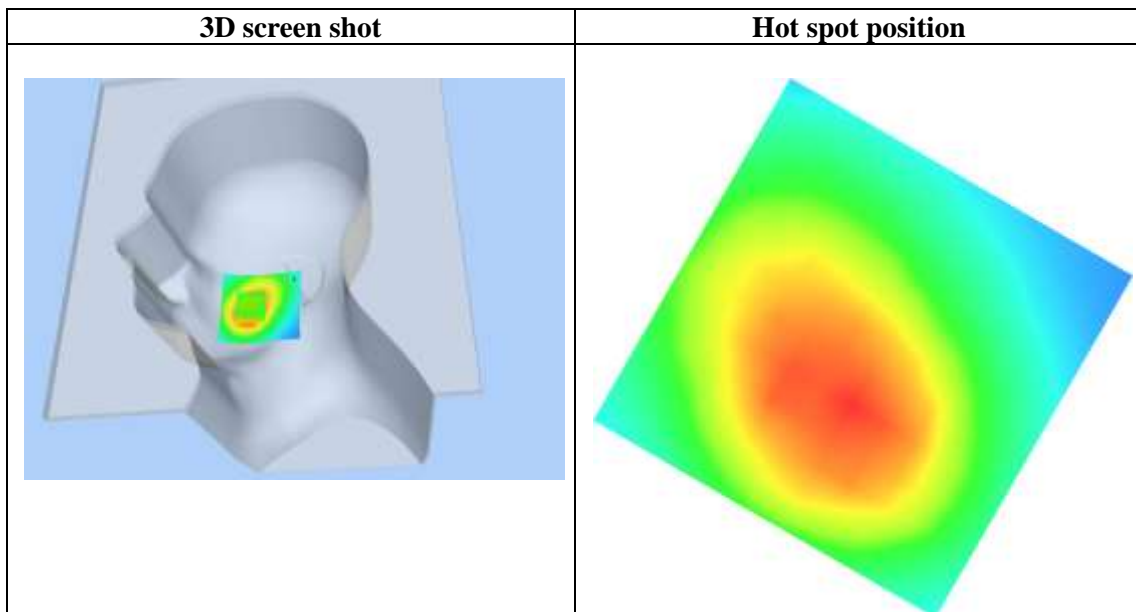
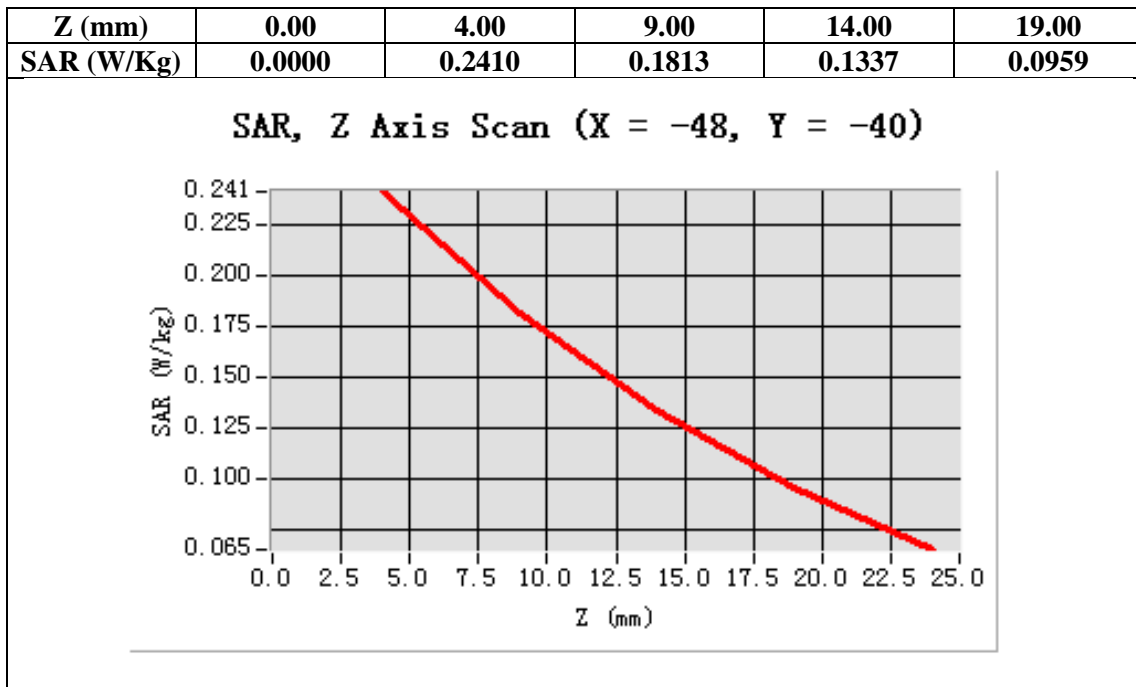

Test Laboratory: AGC Lab  
GSM 835 Mid-Tilt-Left <SIM 1>  
DUT: Sync Plus 3.5; Type: X350

Date: Sep. 09,2014

Communication System: Generic GSM; Communication System Band: GSM 835; Duty Cycle: 1:8.3; Conv.F=5.27;  
Frequency: 836.6 MHz; Medium parameters used:  $f = 835$  MHz;  $\sigma = 0.88$  mho/m;  $\epsilon_r = 40.72$ ;  $\rho = 1000$  kg/m<sup>3</sup> ;  
Phantom section: Left Section  
Ambient temperature (°C): 21.0, Liquid temperature(°C): 21.0

SATIMO Configuration:

- Probe: SSE5; Calibrated: 01/12/2014; Serial No.:SN 22/12 EP159
- Sensor-Surface: 4mm (Mechanical Surface Detection)
- Phantom: Flat Phantom; Type: Elliptical Phantom
- Measurement SW: OpenSAR V4\_02\_01

Configuration/GSM 835 Mid-Tilt-Left/Area Scan: Measurement grid: dx=8mm, dy=8mm

Configuration/GSM 835 Mid-Tilt-Left/Zoom Scan: Measurement grid: dx=8mm, dy=8mm,dz=5mm;

|                        |                                      |
|------------------------|--------------------------------------|
| <b>Area Scan</b>       | sam_direct_droit2_surf8mm.txt        |
| <b>ZoomScan</b>        | 5x5x7,dx=8mm dy=8mm dz=5mm,Very fast |
| <b>Phantom</b>         | Left head                            |
| <b>Device Position</b> | Tilt                                 |
| <b>Band</b>            | GSM 835                              |
| <b>Channels</b>        | Middle                               |
| <b>Signal</b>          | TDMA (Crest factor: 8.0)             |

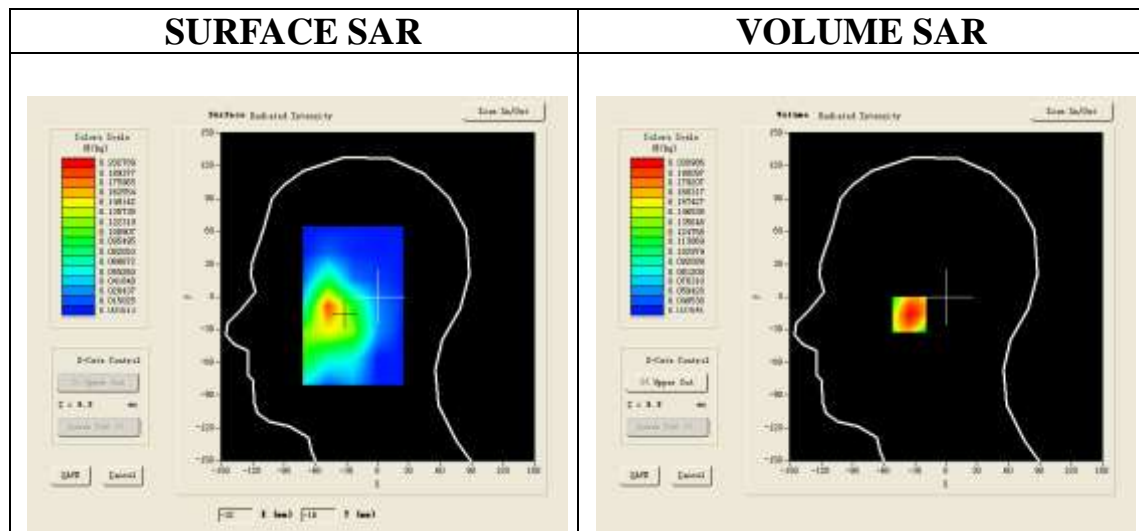

**Maximum location: X=-33.00, Y=-16.00**

|                       |          |
|-----------------------|----------|
| <b>SAR 10g (W/Kg)</b> | 0.143660 |
| <b>SAR 1g (W/Kg)</b>  | 0.193772 |



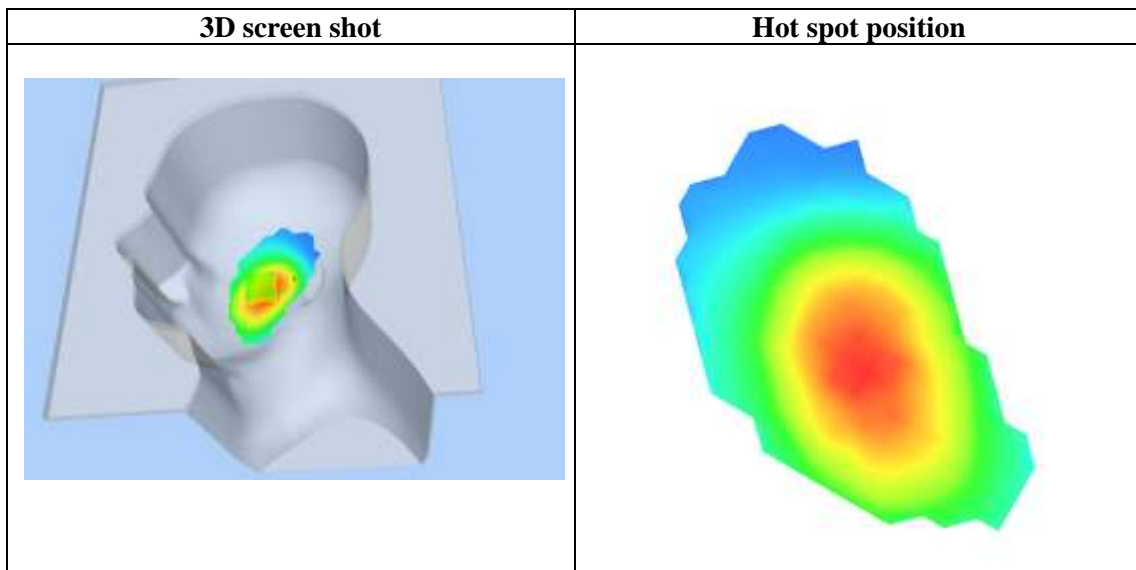
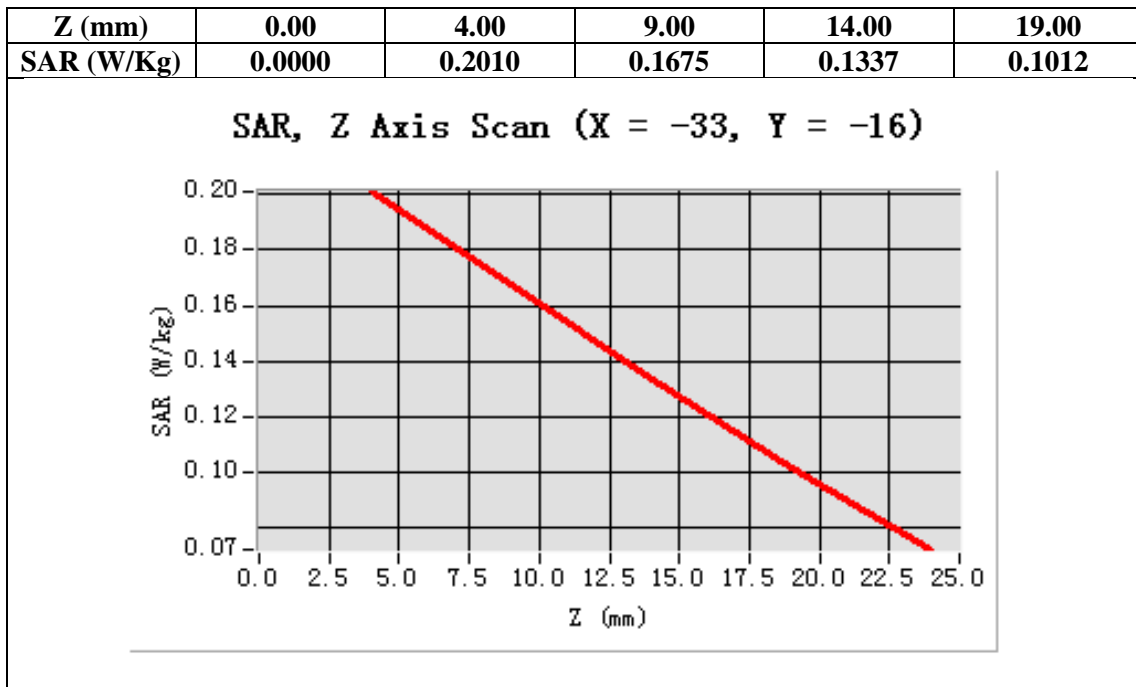

Test Laboratory: AGC Lab  
GSM 835 Mid- Touch-Right <SIM 1>  
DUT: Sync Plus 3.5; Type: X350

Date: Sep. 09,2014

Communication System: Generic GSM; Communication System Band: GSM 835; Duty Cycle: 1:8.3; Conv.F=5.27;  
Frequency: 836.6 MHz; Medium parameters used:  $f = 835$  MHz;  $\sigma = 0.88$  mho/m;  $\epsilon_r = 40.72$ ;  $\rho = 1000$  kg/m<sup>3</sup> ;  
Phantom section: Right Section  
Ambient temperature (°C): 21.0, Liquid temperature (°C): 21.0

SATIMO Configuration:

- Probe: SSE5; Calibrated: 01/12/2014; Serial No.:SN 22/12 EP159
- Sensor-Surface: 4mm (Mechanical Surface Detection)
- Phantom: Flat Phantom; Type: Elliptical Phantom
- Measurement SW: OpenSAR V4\_02\_01

Configuration/GSM 835 Mid-Touch-Right/Area Scan: Measurement grid: dx=8mm, dy=8mm

Configuration/GSM 835 Mid-Touch-Right/Zoom Scan: Measurement grid: dx=8mm,dy=8mm, dz=5mm;

|                 |                                      |
|-----------------|--------------------------------------|
| Area Scan       | sam_direct_droit2_surf8mm.txt        |
| ZoomScan        | 5x5x7,dx=8mm dy=8mm dz=5mm,Very fast |
| Phantom         | Right head                           |
| Device Position | Cheek                                |
| Band            | GSM 835                              |
| Channels        | Middle                               |
| Signal          | TDMA (Crest factor: 8.0)             |

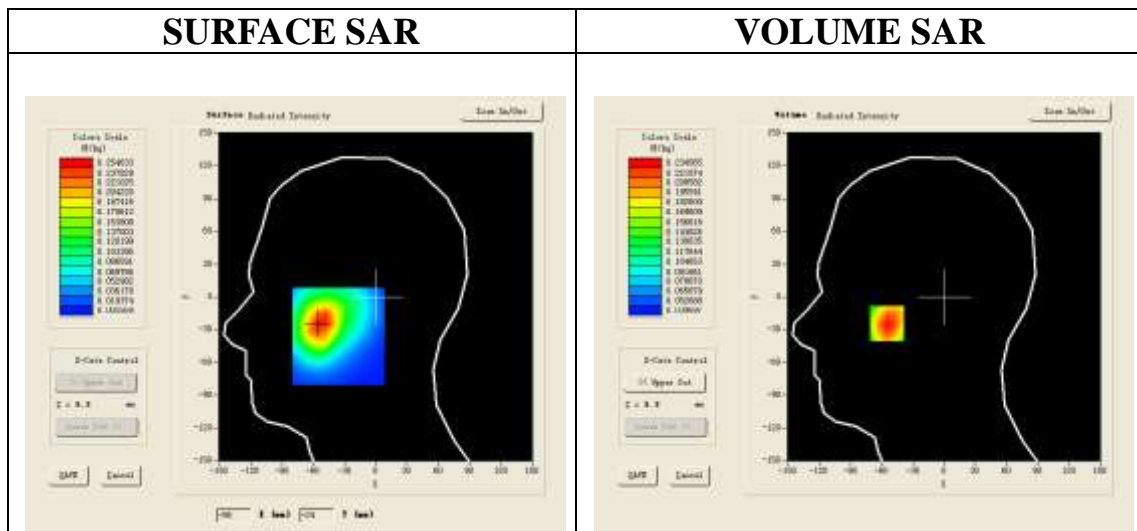

Maximum location: X=-55.00, Y=-24.00

|                |          |
|----------------|----------|
| SAR 10g (W/Kg) | 0.162259 |
| SAR 1g (W/Kg)  | 0.225223 |

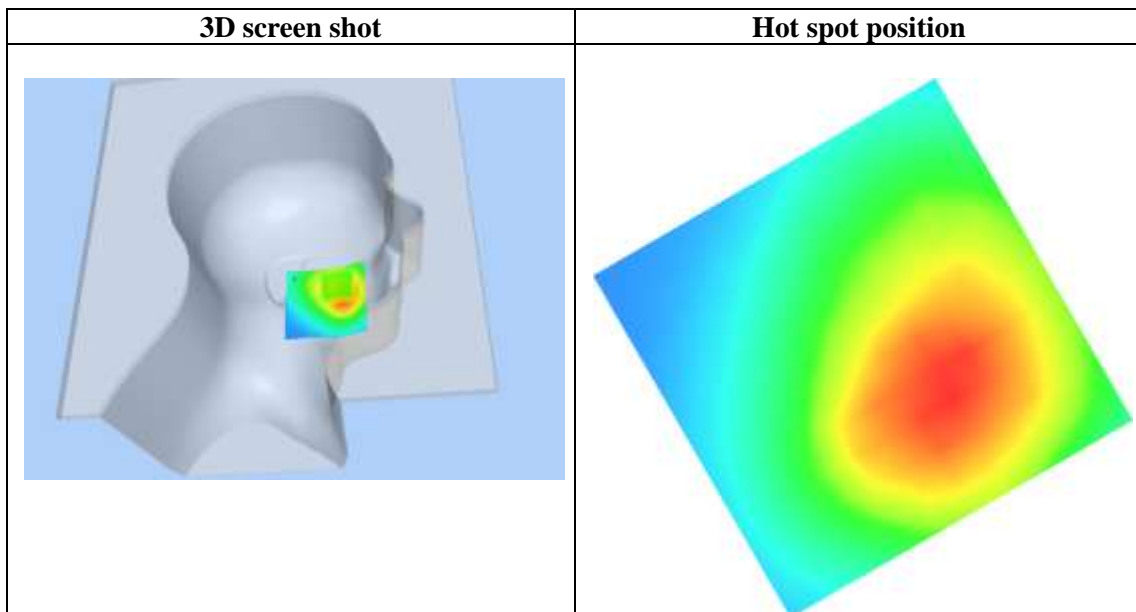
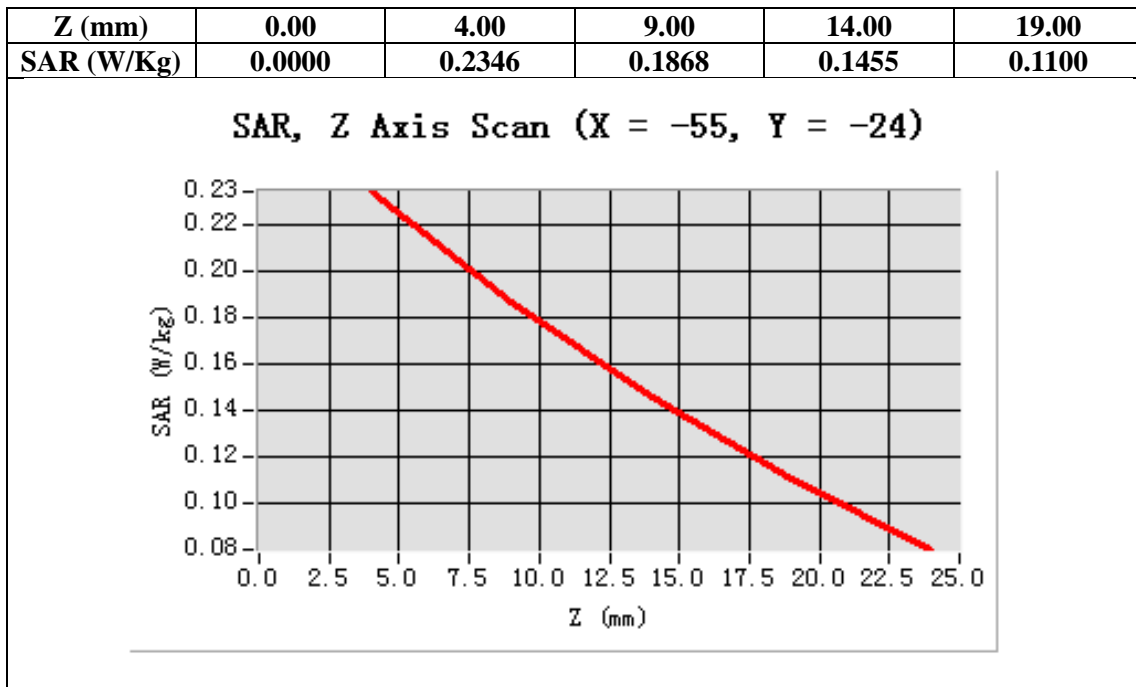

Test Laboratory: AGC Lab  
GSM 835 Mid-Tilt-Right <SIM 1>  
DUT: Sync Plus 3.5; Type: X350

Date: Sep. 09,2014

Communication System: Generic GSM; Communication System Band: GSM 835; Duty Cycle: 1:8.3; Conv.F=5.27;  
Frequency: 836.6 MHz; Medium parameters used:  $f = 835$  MHz;  $\sigma = 0.88$  mho/m;  $\epsilon_r = 40.72$ ;  $\rho = 1000$  kg/m<sup>3</sup> ;  
Phantom section: Right Section  
Ambient temperature (°C): 21.0, Liquid temperature (°C): 21.0

SATIMO Configuration:

- Probe: SSE5; Calibrated: 01/12/2014; Serial No.:SN 22/12 EP159
- Sensor-Surface: 4mm (Mechanical Surface Detection)
- Phantom: Flat Phantom; Type: Elliptical Phantom
- Measurement SW: OpenSAR V4\_02\_01

Configuration/GSM 835 Mid-Tilt-Right/Area Scan: Measurement grid: dx=8mm, dy=8mm  
Configuration/GSM 835 Mid-Tilt-Right/Zoom Scan: Measurement grid: dx=8mm,dy=8mm, dz=5mm;

|                 |                                      |
|-----------------|--------------------------------------|
| Area Scan       | sam_direct_droit2_surf8mm.txt        |
| Zoom Scan       | 5x5x7,dx=8mm dy=8mm dz=5mm,Very fast |
| Phantom         | Right head                           |
| Device Position | Tilt                                 |
| Band            | GSM 835                              |
| Channels        | Middle                               |
| Signal          | TDMA (Crest factor: 8.0)             |

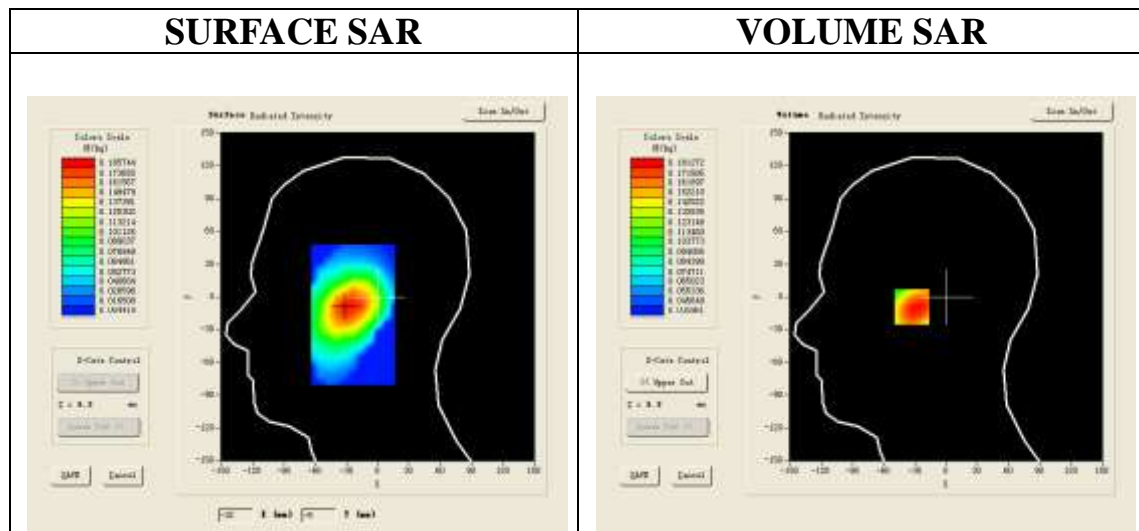

**Maximum location: X=-31.00, Y=-9.00**

|                       |          |
|-----------------------|----------|
| <b>SAR 10g (W/Kg)</b> | 0.134450 |
| <b>SAR 1g (W/Kg)</b>  | 0.177261 |

| Z (mm)     | 0.00   | 4.00   | 9.00   | 14.00  | 19.00  |
|------------|--------|--------|--------|--------|--------|
| SAR (W/Kg) | 0.0000 | 0.1801 | 0.1548 | 0.1257 | 0.0955 |

**SAR, Z Axis Scan (X = -31, Y = -9)**

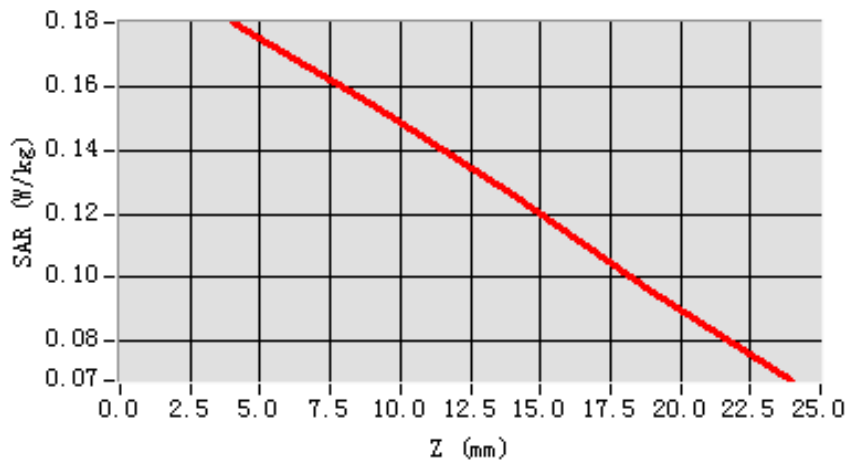

**3D screen shot**

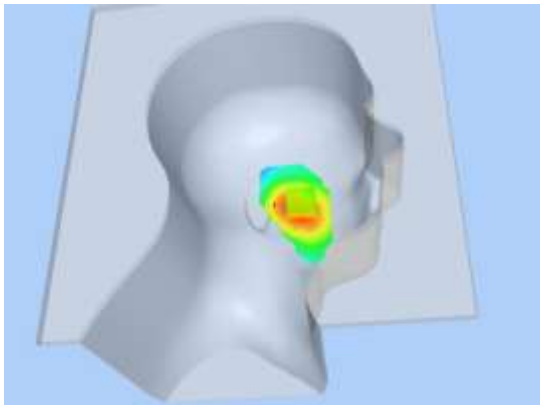

**Hot spot position**

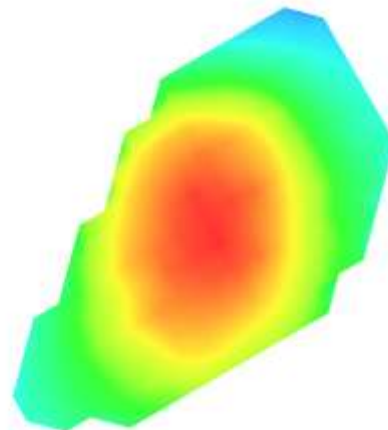

Test Laboratory: AGC Lab  
GSM 835 Mid-Touch-Left <SIM 2>  
DUT: Sync Plus 3.5; Type: X350

Date: Sep. 09,2014

Communication System: Generic GSM; Communication System Band: GSM 835; Duty Cycle: 1:8.3; Conv.F=5.27  
Frequency: 836.6 MHz; Medium parameters used:  $f = 835$  MHz;  $\sigma = 0.88$  mho/m;  $\epsilon_r = 40.72$ ;  $\rho = 1000$  kg/m<sup>3</sup> ;  
Phantom section: Left Section  
Ambient temperature (°C): 21.0, Liquid temperature (°C): 21.0

SATIMO Configuration:

- Probe: SSE5; Calibrated: 01/12/2014; Serial No.:SN 22/12 EP159
- Sensor-Surface: 4mm (Mechanical Surface Detection)
- Phantom: Flat Phantom; Type: Elliptical Phantom
- Measurement SW: OpenSAR V4\_02\_01

Configuration/GSM 835 Mid-Touch-Left/Area Scan: Measurement grid: dx=8mm, dy=8mm  
Configuration/GSM 835 Mid-Touch-Left/Zoom Scan: Measurement grid: dx=8mm,dy=8mm, dz=5mm

|                 |                                      |
|-----------------|--------------------------------------|
| Area Scan       | sam_direct_droit2_surf8mm.txt        |
| ZoomScan        | 5x5x7,dx=8mm dy=8mm dz=5mm,Very fast |
| Phantom         | Left head                            |
| Device Position | Cheek                                |
| Band            | GSM 835                              |
| Channels        | Middle                               |
| Signal          | TDMA (Crest factor: 8.0)             |

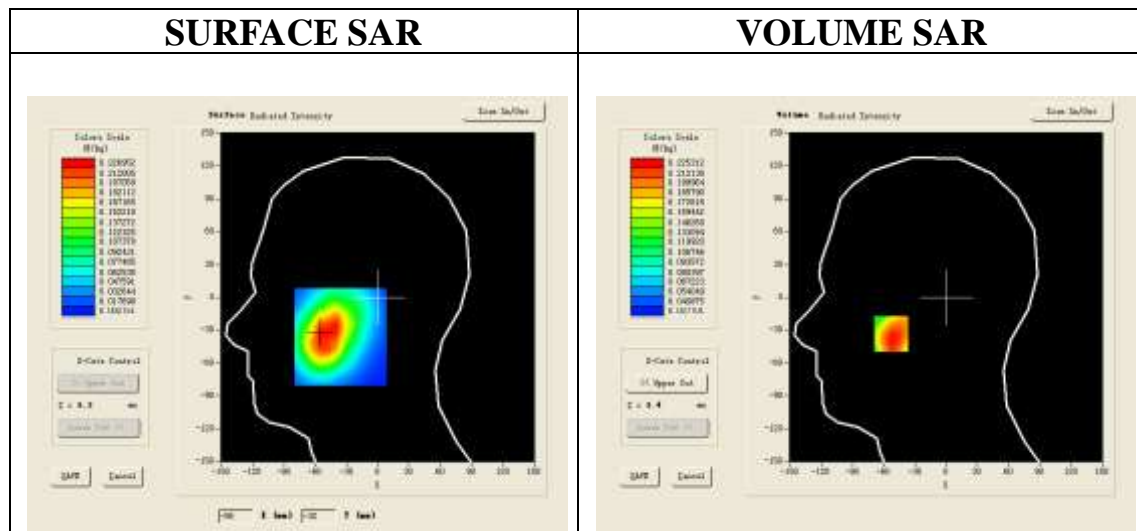

Maximum location: X=-53.00, Y=-33.00

|                |          |
|----------------|----------|
| SAR 10g (W/Kg) | 0.155717 |
| SAR 1g (W/Kg)  | 0.217667 |

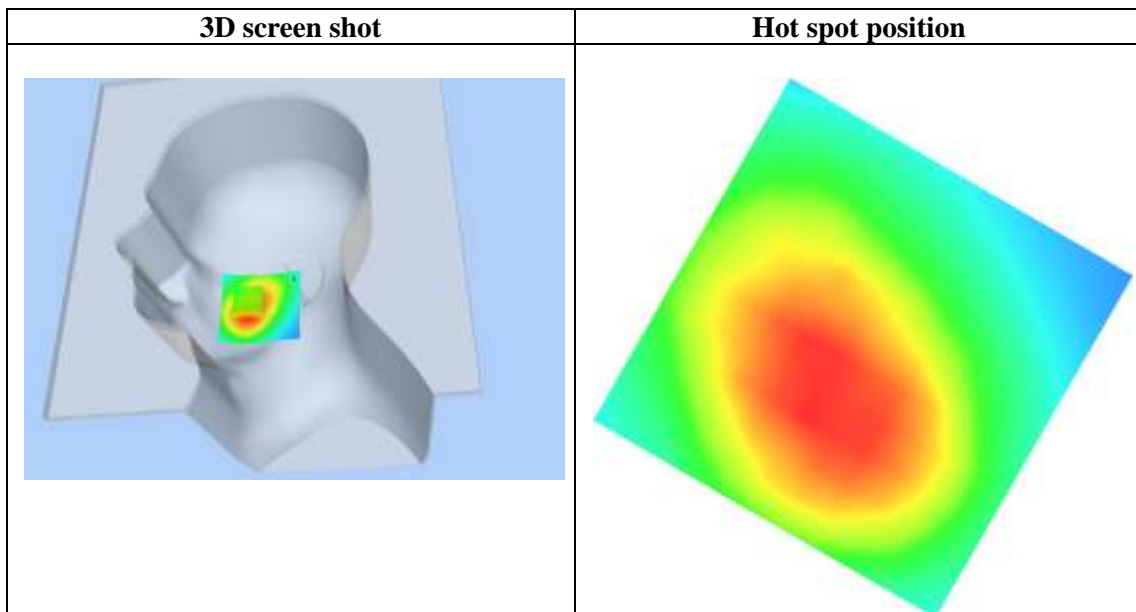
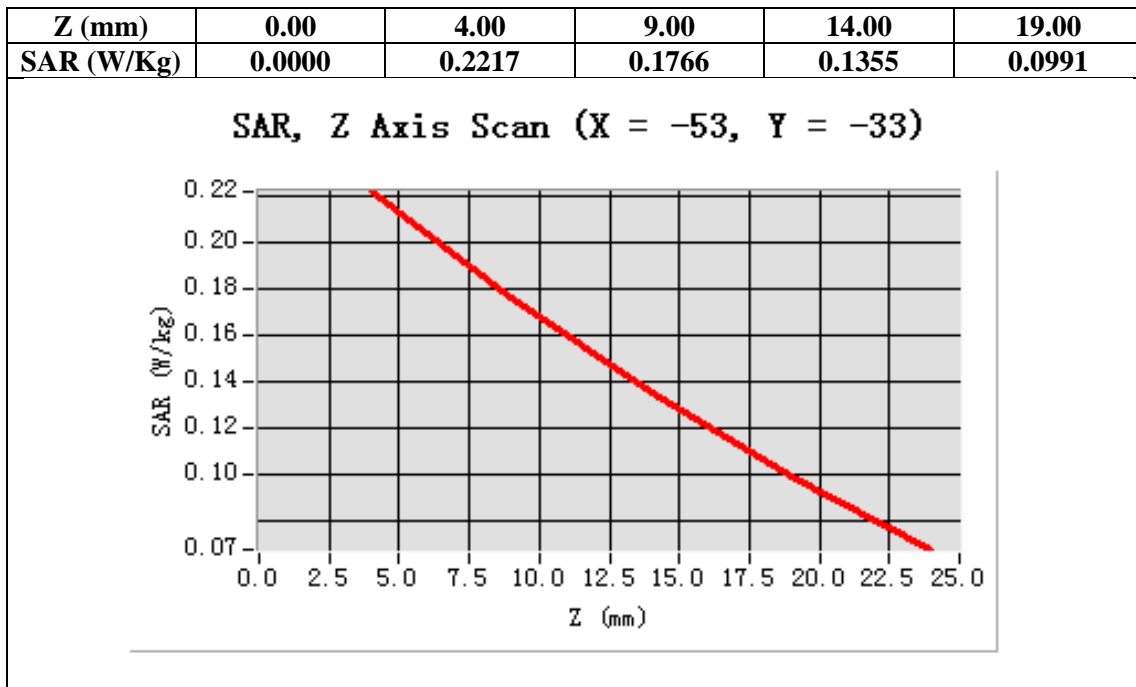

Test Laboratory: AGC Lab  
GSM 835 Mid- Body- Back <SIM 1>  
DUT: Sync Plus 3.5; Type: X350

Date: Sep. 09,2014

Communication System: Generic GSM; Communication System Band: GSM 835; Duty Cycle: 1:8.3; Conv.F=5.48;  
Frequency: 836.6 MHz; Medium parameters used:  $f = 835$  MHz;  $\sigma = 0.95$  mho/m;  $\epsilon_r = 54.93$ ;  $\rho = 1000$  kg/m<sup>3</sup> ;  
Phantom section: Flat Section  
Ambient temperature (°C): 21.0, Liquid temperature (°C): 21.0

SATIMO Configuration:

- Probe: SSE5; Calibrated: 01/12/2014; Serial No.:SN 22/12 EP159
- Sensor-Surface: 4mm (Mechanical Surface Detection)
- Phantom: Flat Phantom; Type: Elliptical Phantom
- Measurement SW: OpenSAR V4\_02\_01

Configuration/GSM 835 Mid-Body-Back/Area Scan: Measurement grid: dx=8mm, dy=8mm  
Configuration/GSM 835 Mid-Body-Back/Zoom Scan: Measurement grid: dx=8mm,dy=8mm, dz=5mm;

|                 |                                      |
|-----------------|--------------------------------------|
| Area Scan       | surf_sam_plan.txt                    |
| ZoomScan        | 5x5x7,dx=8mm dy=8mm dz=5mm,Very fast |
| Phantom         | Validation plane                     |
| Device Position | Body Back                            |
| Band            | GSM 835                              |
| Channels        | Middle                               |
| Signal          | TDMA (Crest factor: 8.0)             |

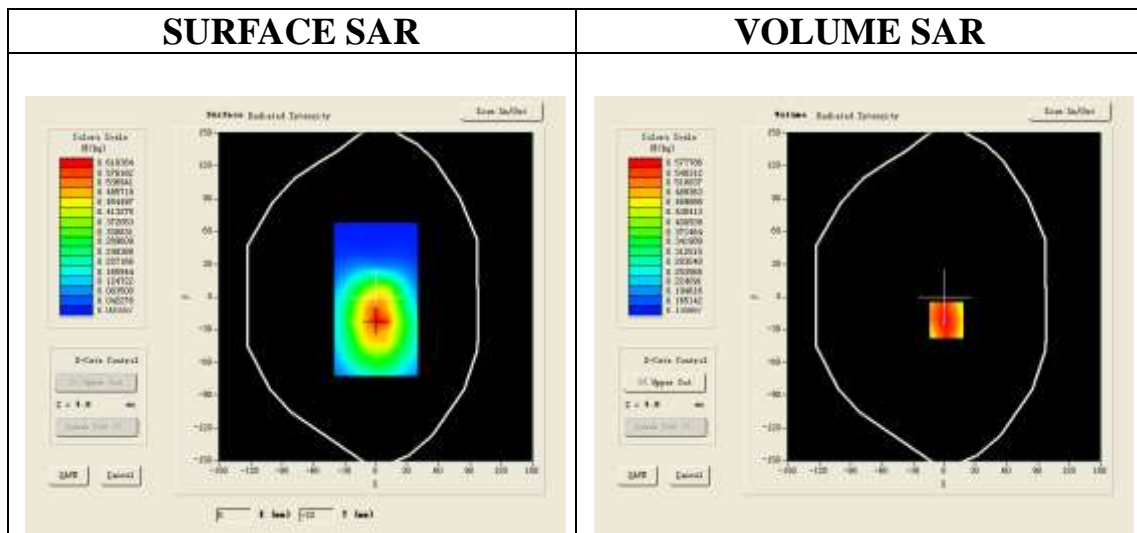

Maximum location: X=2.00, Y=-21.00

|                |          |
|----------------|----------|
| SAR 10g (W/Kg) | 0.421216 |
| SAR 1g (W/Kg)  | 0.561213 |



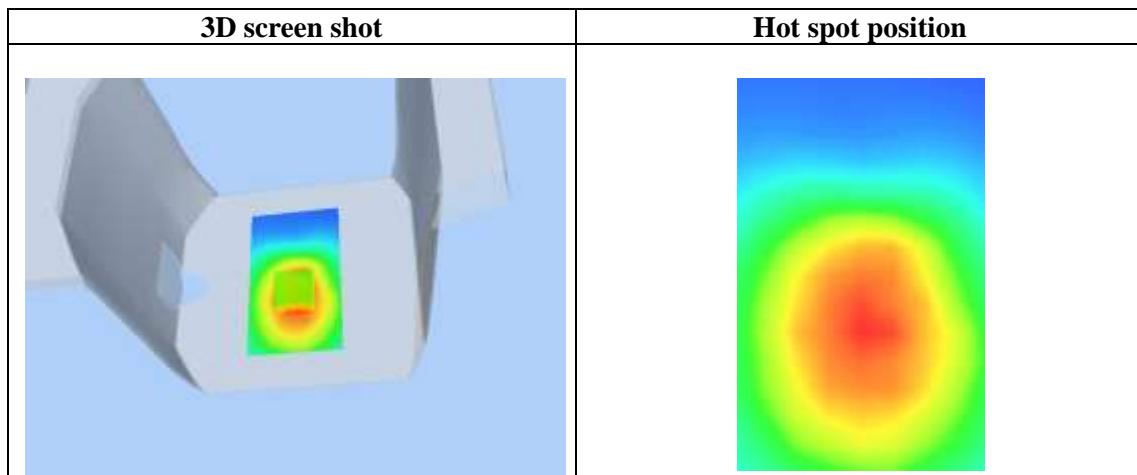
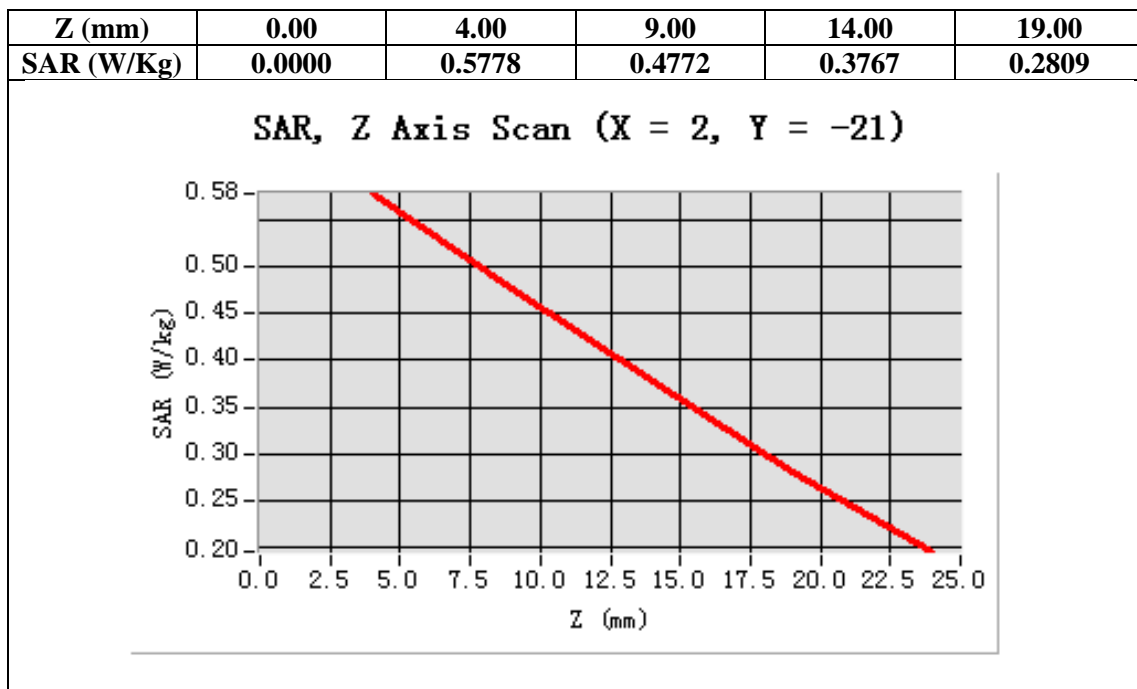

Test Laboratory: AGC Lab  
GSM 835 Mid- Body- Front (MS) <SIM 1>  
DUT: Sync Plus 3.5; Type: X350

Date: Sep. 09,2014

Communication System: Generic GSM; Communication System Band: GSM 835; Duty Cycle: 1:8.3; Conv.F=5.48;  
Frequency: 836.6 MHz; Medium parameters used: f = 835 MHz;  $\sigma = 0.95\text{mho/m}$ ;  $\epsilon_r = 54.93$ ;  $\rho = 1000\text{ kg/m}^3$  ;  
Phantom section: Flat Section  
Ambient temperature ( $^{\circ}\text{C}$ ): 21.0, Liquid temperature ( $^{\circ}\text{C}$ ): 21.0

SATIMO Configuration:

- Probe: SSE5; Calibrated: 01/12/2014; Serial No.:SN 22/12 EP159
- Sensor-Surface: 4mm (Mechanical Surface Detection)
- Phantom: Flat Phantom; Type: Elliptical Phantom
- Measurement SW: OpenSAR V4\_02\_01

Configuration/GSM 835 Mid-Body- Front /Area Scan: Measurement grid: dx=8mm, dy=8mm

Configuration/GSM 835 Mid-Body- Front Zoom Scan: Measurement grid: dx=8mm,dy=8mm, dz=5mm;

|                 |                                      |
|-----------------|--------------------------------------|
| Area Scan       | surf_sam_plan.txt                    |
| ZoomScan        | 5x5x7,dx=8mm dy=8mm dz=5mm,Very fast |
| Phantom         | Validation plane                     |
| Device Position | Body Front                           |
| Band            | GSM 835                              |
| Channels        | Middle                               |
| Signal          | TDMA (Crest factor: 8.0)             |

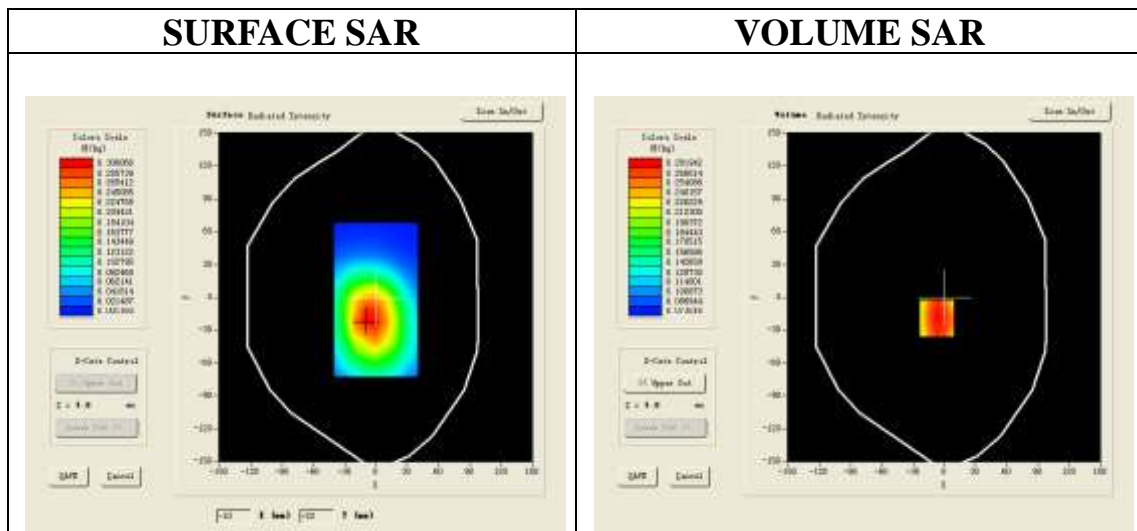

Maximum location: X=-7.00, Y=-19.00

|                |          |
|----------------|----------|
| SAR 10g (W/Kg) | 0.211276 |
| SAR 1g (W/Kg)  | 0.276391 |

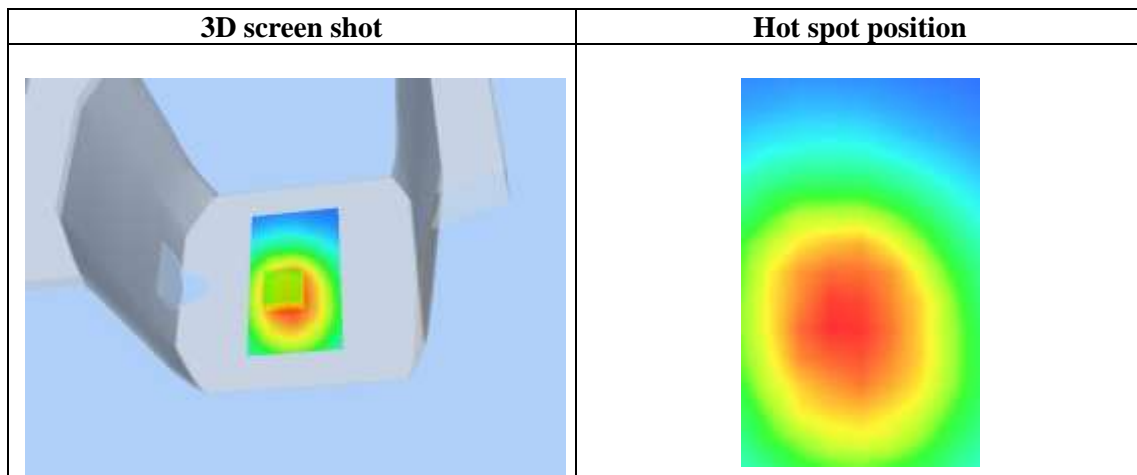
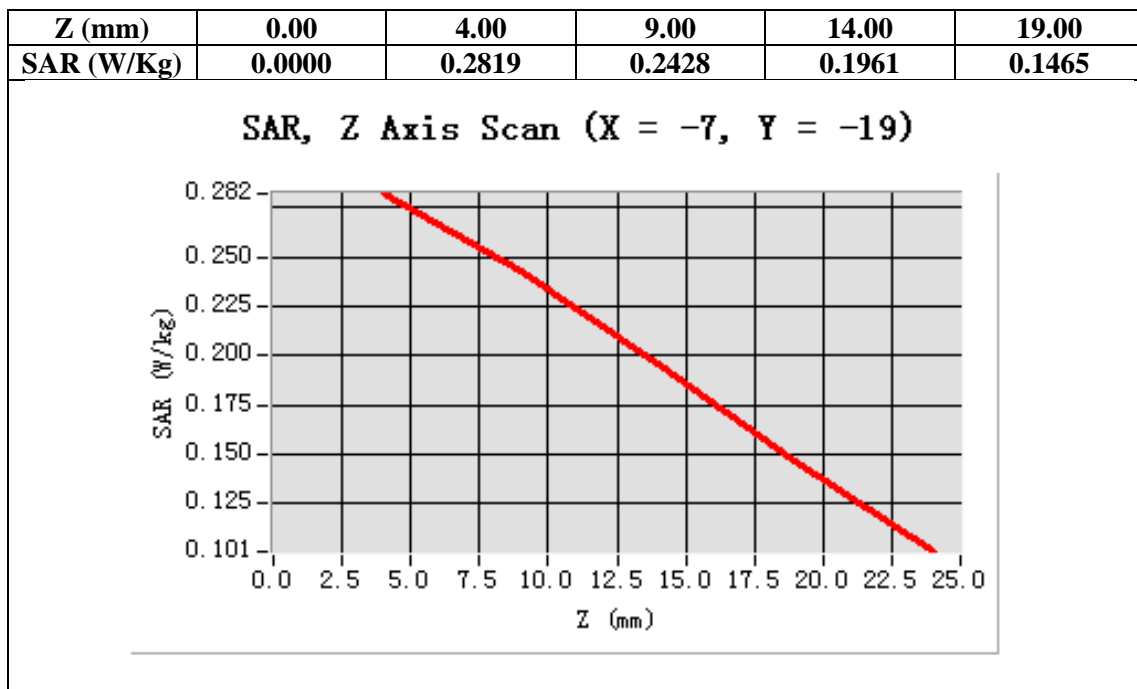

Test Laboratory: AGC Lab  
PCS 1900 Mid-Touch- Left <SIM 1>  
DUT: Sync Plus 3.5; Type: X350

Date: Sep. 09,2014

Communication System: Generic GSM; Communication System Band: PCS 1900; Duty Cycle: 1:8.3; Conv.F=4.51;  
Frequency: 1880 MHz; Medium parameters used:  $f = 1900$  MHz;  $\sigma = 1.38$  mho/m;  $\epsilon_r = 39.06$ ;  $\rho = 1000$  kg/m<sup>3</sup> ;  
Phantom section: Left Section  
Ambient temperature (°C): 21.0, Liquid temperature (°C): 21.0

SATIMO Configuration:

- Probe: SSE5; Calibrated: 01/12/2014; Serial No.:SN 22/12 EP159
- Sensor-Surface: 4mm (Mechanical Surface Detection)
- Phantom: Flat Phantom; Type: Elliptical Phantom
- Measurement SW: OpenSAR V4\_02\_01

Configuration/PCS1900 Mid-Touch-Left/Area Scan: Measurement grid: dx=8mm, dy=8mm  
Configuration/PCS1900 Mid-Touch-Left/Zoom Scan: Measurement grid: dx=8mm,dy=8mm, dz=5mm;

|                 |                                      |
|-----------------|--------------------------------------|
| Area Scan       | sam_direct_droit2_surf8mm.txt        |
| ZoomScan        | 5x5x7,dx=8mm dy=8mm dz=5mm,Very fast |
| Phantom         | Left head                            |
| Device Position | Cheek                                |
| Band            | PCS 1900                             |
| Channels        | Middle                               |
| Signal          | TDMA (Crest factor: 8.0)             |

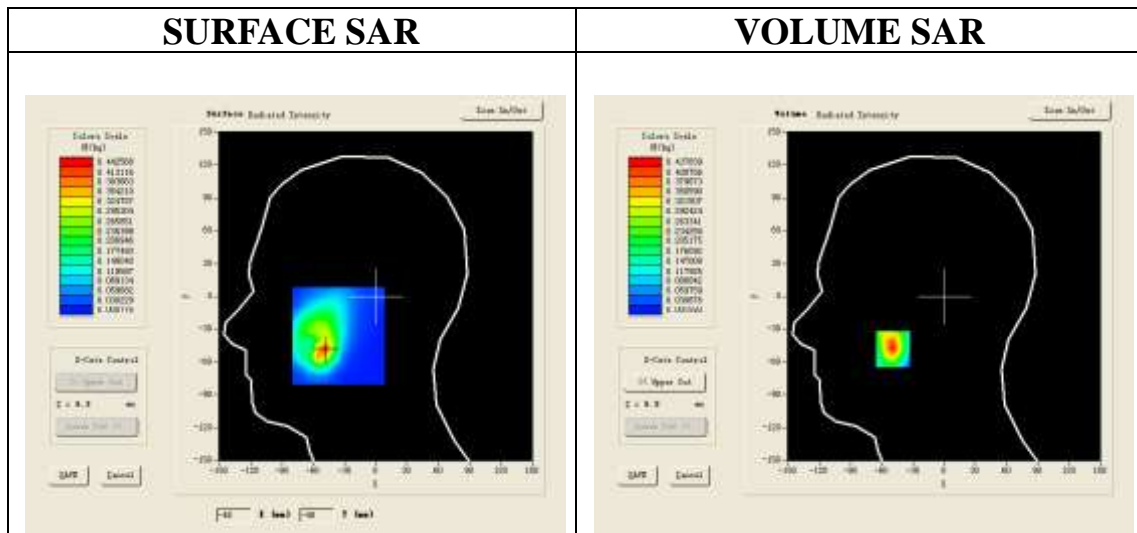

Maximum location: X=-49.00, Y=-48.00

|                |          |
|----------------|----------|
| SAR 10g (W/Kg) | 0.192260 |
| SAR 1g (W/Kg)  | 0.406040 |

| Z (mm)     | 0.00   | 4.00   | 9.00   | 14.00  | 19.00  |
|------------|--------|--------|--------|--------|--------|
| SAR (W/Kg) | 0.0000 | 0.4378 | 0.2126 | 0.1040 | 0.0561 |

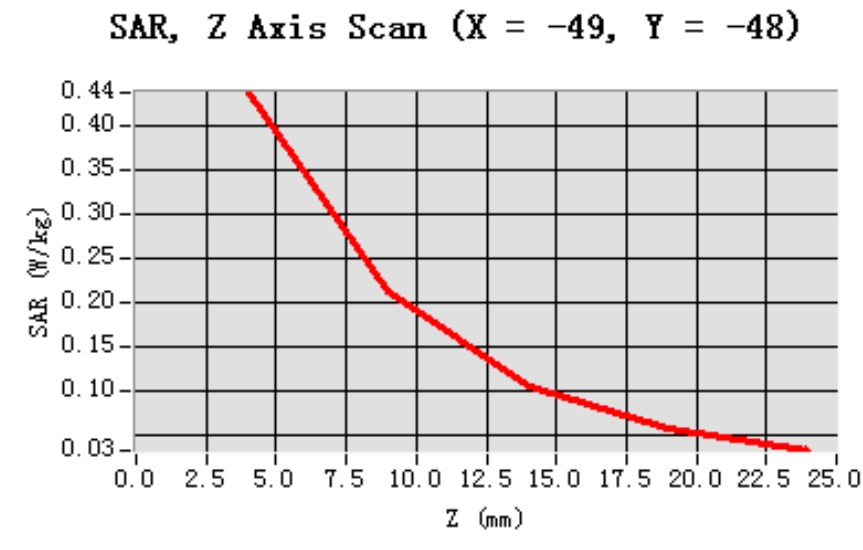

| 3D screen shot  | Hot spot position  |
|---|--|
| <p>A 3D rendering of a human head model. A small rectangular area on the face is highlighted with a color gradient from blue to red, indicating the location of the hot spot.</p> | <p>A 2D heatmap visualization of the hot spot. The color scale ranges from blue (low SAR) to red (high SAR), showing a central region of high intensity (red) surrounded by lower intensity regions (yellow, green, cyan).</p> |

Test Laboratory: AGC Lab  
PCS 1900 Mid-Tilt-Left <SIM 1>  
DUT: Sync Plus 3.5; Type: X350

Date: Sep. 09,2014

Communication System: Generic GSM; Communication System Band: PCS 1900; Duty Cycle: 1:8.3; Conv.F=4.51;  
Frequency: 1880 MHz; Medium parameters used:  $f = 1900$  MHz;  $\sigma = 1.38$  mho/m;  $\epsilon_r = 39.06$ ;  $\rho = 1000$  kg/m<sup>3</sup> ;  
Phantom section: Left Section  
Ambient temperature (°C): 21.0, Liquid temperature (°C): 21.0

SATIMO Configuration:

- Probe: SSE5; Calibrated: 01/12/2014; Serial No.:SN 22/12 EP159
- Sensor-Surface: 4mm (Mechanical Surface Detection)
- Phantom: Flat Phantom; Type: Elliptical Phantom
- Measurement SW: OpenSAR V4\_02\_01

Configuration/PCS1900 Mid-Tilt-Left/Area Scan: Measurement grid: dx=8mm, dy=8mm  
Configuration/PCS1900 Mid-Tilt-Left/Zoom Scan: Measurement grid: dx=8mm, dy=8mm,dz=5mm;

|                 |                                      |
|-----------------|--------------------------------------|
| Area Scan       | sam_direct_droit2_surf8mm.txt        |
| ZoomScan        | 5x5x7,dx=8mm dy=8mm dz=5mm,Very fast |
| Phantom         | Left head                            |
| Device Position | Tilt                                 |
| Band            | PCS 1900                             |
| Channels        | Middle                               |
| Signal          | TDMA (Crest factor: 8.0)             |

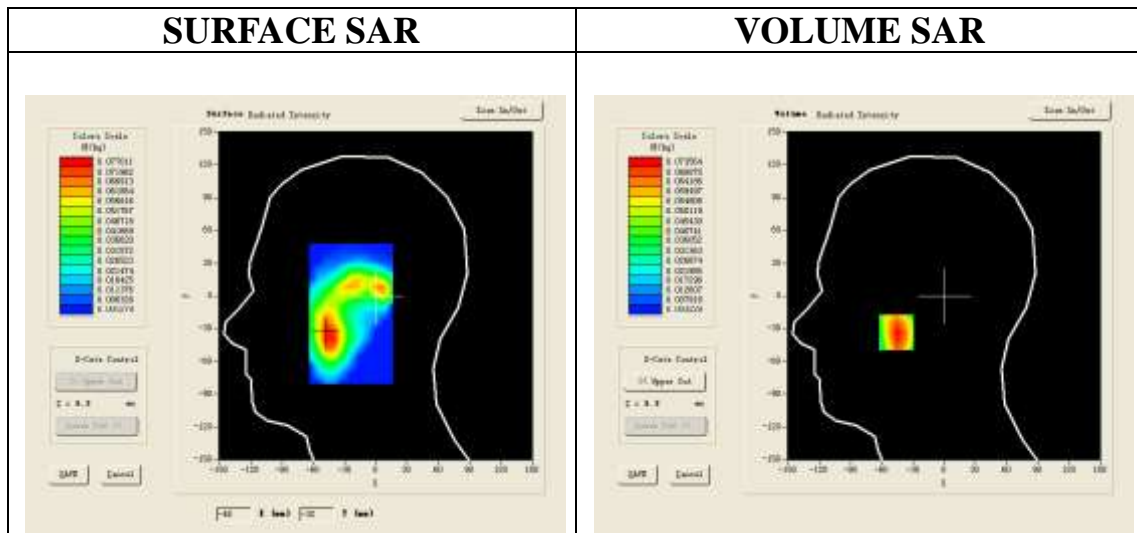

Maximum location: X=-46.00, Y=-33.00

|                |          |
|----------------|----------|
| SAR 10g (W/Kg) | 0.040490 |
| SAR 1g (W/Kg)  | 0.069797 |

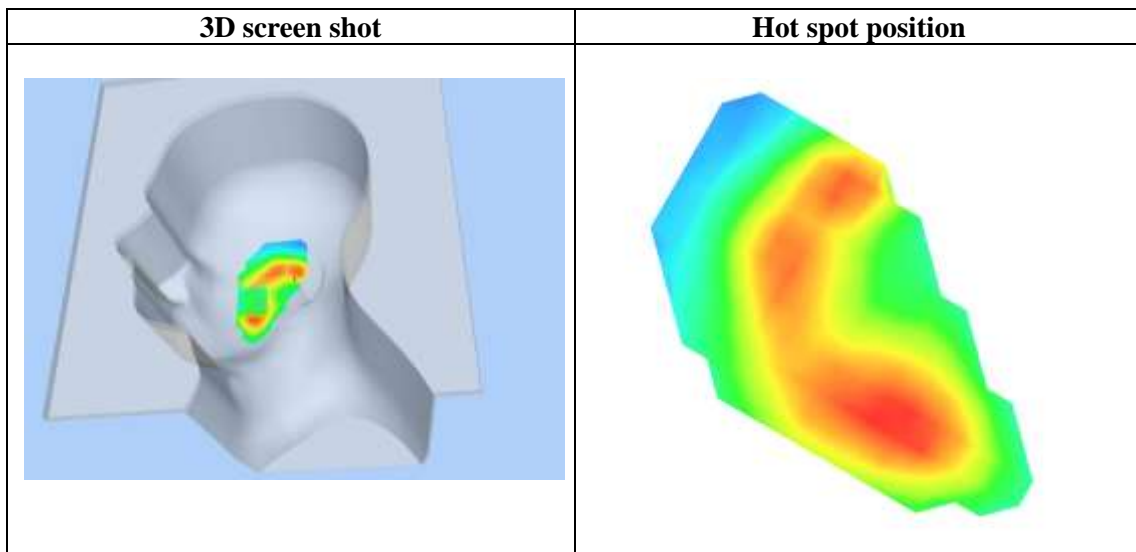
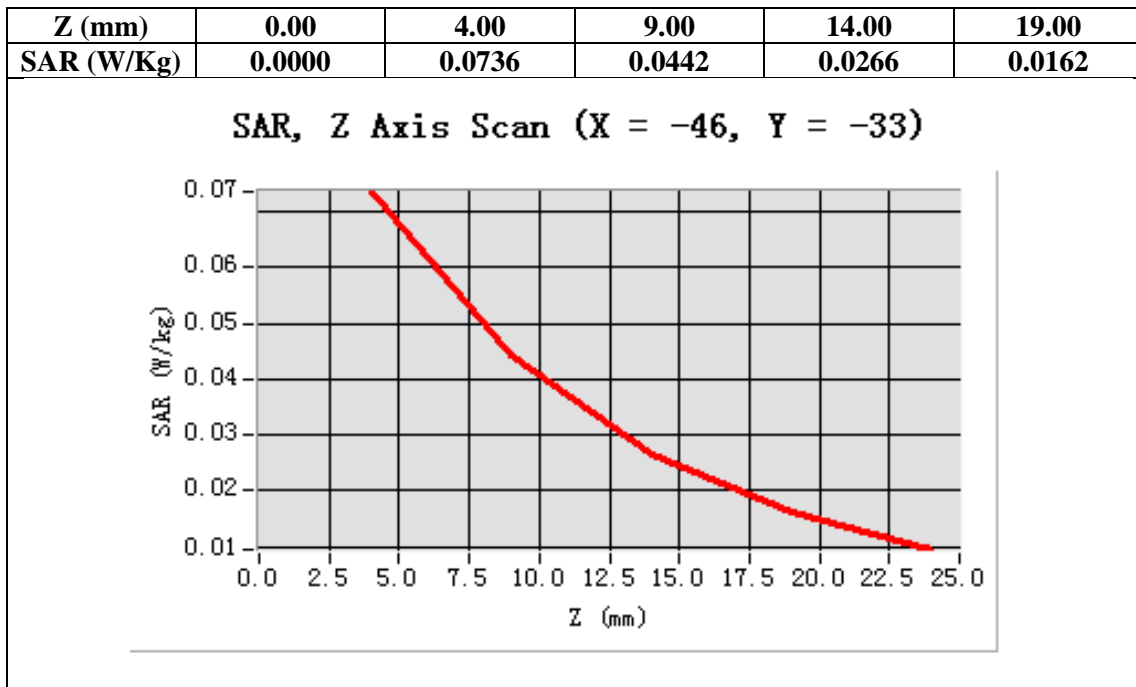

Test Laboratory: AGC Lab  
PCS 1900 Mid-Touch-Right <SIM 1>  
DUT: Sync Plus 3.5; Type: X350

Date: Sep. 09,2014

Communication System: Generic GSM; Communication System Band: PCS 1900; Duty Cycle: 1:8.3; Conv.F=4.51;  
Frequency: 1880 MHz; Medium parameters used:  $f = 1900$  MHz;  $\sigma = 1.38$  mho/m;  $\epsilon_r = 39.06$ ;  $\rho = 1000$  kg/m<sup>3</sup> ;  
Phantom section: Right Section  
Ambient temperature (°C): 21.0, Liquid temperature (°C): 21.0

SATIMO Configuration:

- Probe: SSE5; Calibrated: 01/12/2014; Serial No.:SN 22/12 EP159
- Sensor-Surface: 4mm (Mechanical Surface Detection)
- Phantom: Flat Phantom; Type: Elliptical Phantom
- Measurement SW: OpenSAR V4\_02\_01

Configuration/PCS1900 Mid-Touch-Right/Area Scan: Measurement grid: dx=8mm, dy=8mm

Configuration/PCS1900 Mid-Touch-Right/Zoom Scan: Measurement grid: dx=8mm,dy=8mm, dz=5mm;

|                        |                                      |
|------------------------|--------------------------------------|
| <b>Area Scan</b>       | sam_direct_droit2_surf8mm.txt        |
| <b>ZoomScan</b>        | 5x5x7,dx=8mm dy=8mm dz=5mm,Very fast |
| <b>Phantom</b>         | Right head                           |
| <b>Device Position</b> | Cheek                                |
| <b>Band</b>            | PCS 1900                             |
| <b>Channels</b>        | Middle                               |
| <b>Signal</b>          | TDMA (Crest factor: 8.0)             |

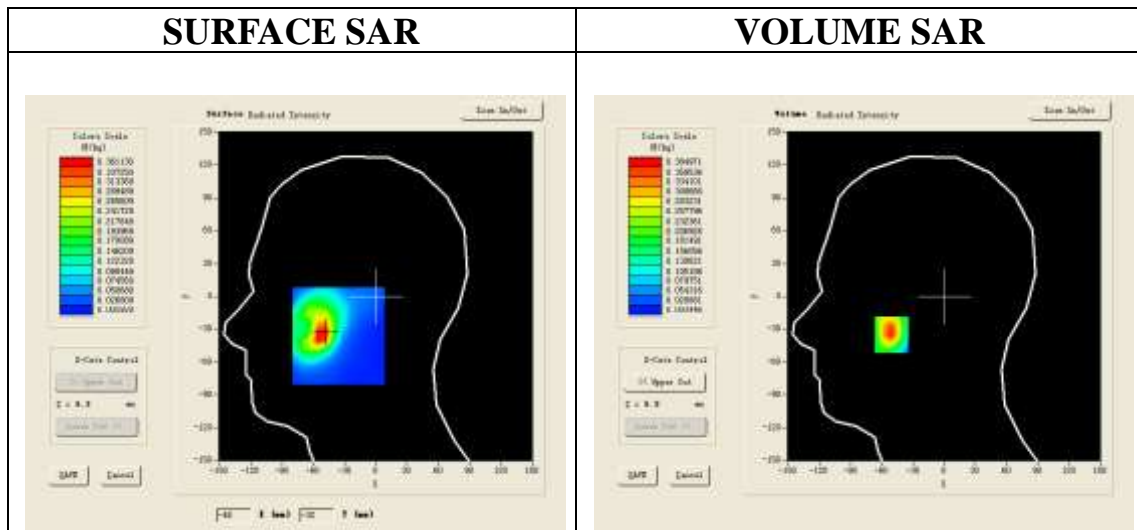

**Maximum location: X=-51.00, Y=-35.00**

|                       |          |
|-----------------------|----------|
| <b>SAR 10g (W/Kg)</b> | 0.189525 |
| <b>SAR 1g (W/Kg)</b>  | 0.358855 |



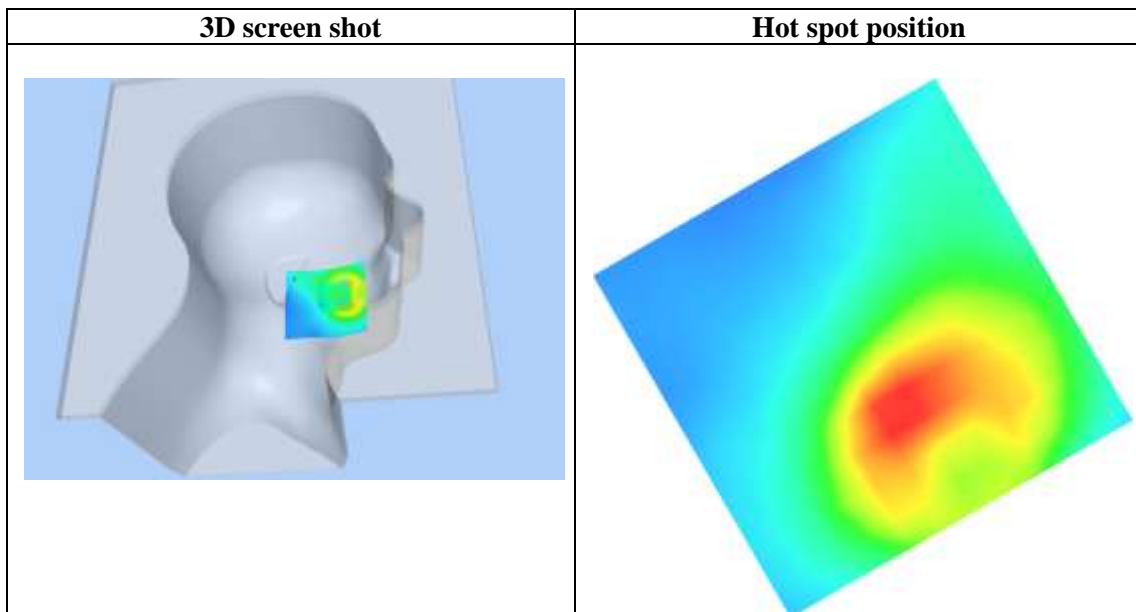
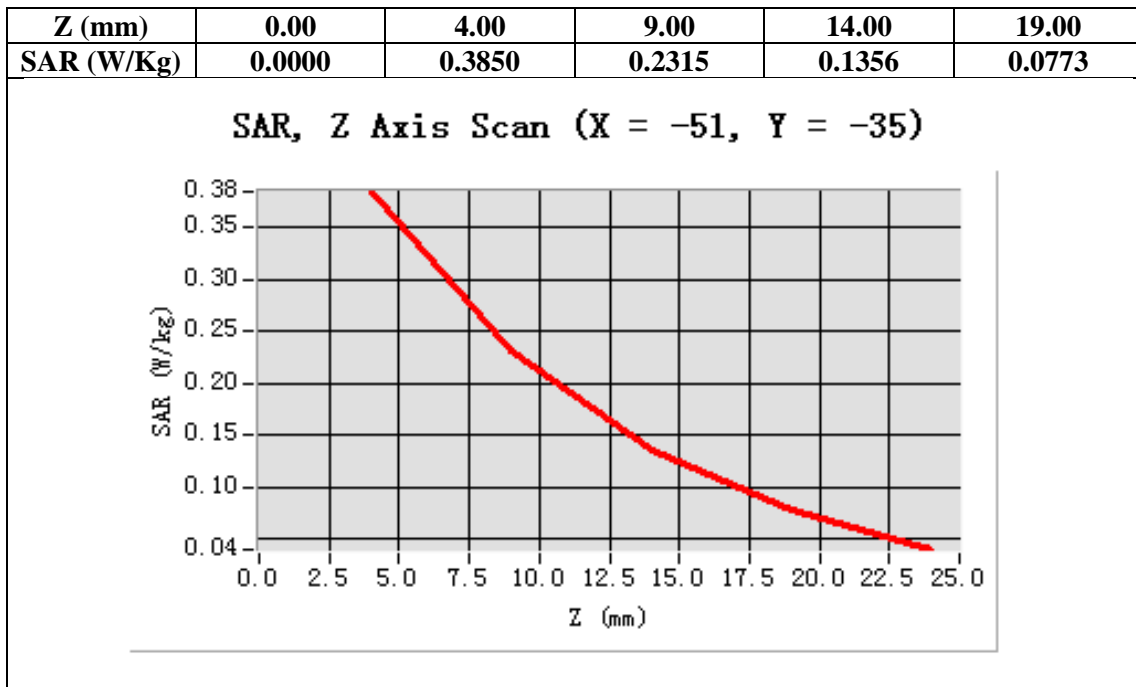

Test Laboratory: AGC Lab  
PCS 1900 Mid-Tilt-Right <SIM 1>  
DUT: Sync Plus 3.5; Type: X350

Date: Sep. 09,2014

Communication System: Generic GSM; Communication System Band: PCS 1900; Duty Cycle: 1:8.3; Conv.F=4.51;  
Frequency: 1880 MHz; Medium parameters used:  $f = 1900$  MHz;  $\sigma = 1.38$  mho/m;  $\epsilon_r = 39.06$ ;  $\rho = 1000$  kg/m<sup>3</sup> ;  
Phantom section: Right Section  
Ambient temperature (°C): 21.0, Liquid temperature (°C): 21.0

SATIMO Configuration:

- Probe: SSE5; Calibrated: 01/12/2014; Serial No.:SN 22/12 EP159
- Sensor-Surface: 4mm (Mechanical Surface Detection)
- Phantom: Flat Phantom; Type: Elliptical Phantom
- Measurement SW: OpenSAR V4\_02\_01

Configuration/PCS1900 Mid-Tilt-Right/Area Scan: Measurement grid: dx=8mm, dy=8mm  
Configuration/PCS1900 Mid-Tilt-Right/Zoom Scan: Measurement grid: dx=8mm,dy=8mm, dz=5mm;

|                        |                                      |
|------------------------|--------------------------------------|
| <b>Area Scan</b>       | sam_direct_droit2_surf8mm.txt        |
| <b>ZoomScan</b>        | 5x5x7,dx=8mm dy=8mm dz=5mm,Very fast |
| <b>Phantom</b>         | Right head                           |
| <b>Device Position</b> | Tilt                                 |
| <b>Band</b>            | PCS 1900                             |
| <b>Channels</b>        | Middle                               |
| <b>Signal</b>          | TDMA (Crest factor: 8.0)             |

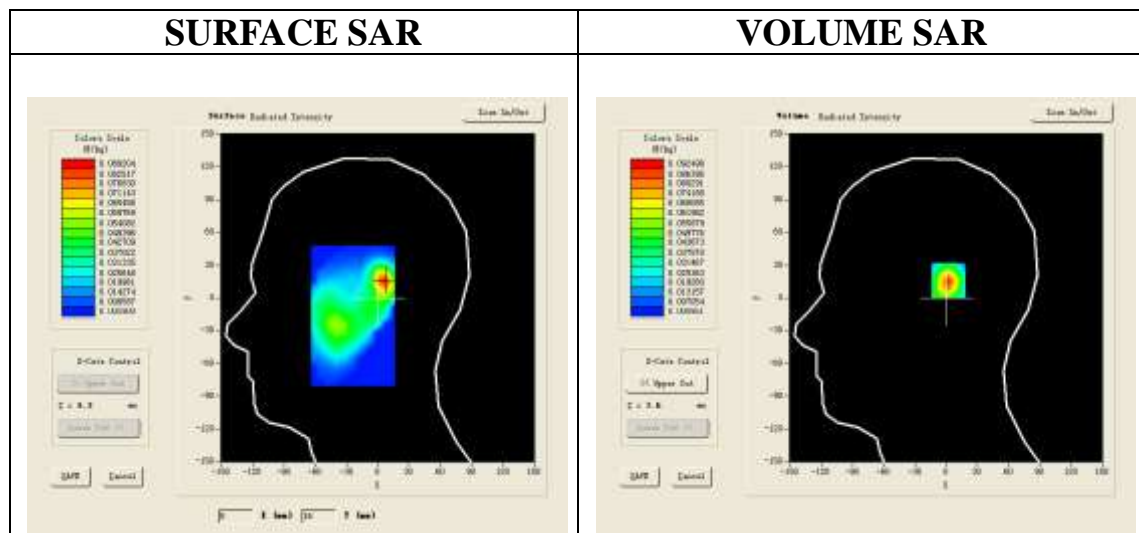

**Maximum location: X=6.00, Y=16.00**

|                       |          |
|-----------------------|----------|
| <b>SAR 10g (W/Kg)</b> | 0.043019 |
| <b>SAR 1g (W/Kg)</b>  | 0.084485 |

| Z (mm)     | 0.00   | 4.00   | 9.00   | 14.00  | 19.00  |
|------------|--------|--------|--------|--------|--------|
| SAR (W/Kg) | 0.0000 | 0.0925 | 0.0556 | 0.0328 | 0.0191 |

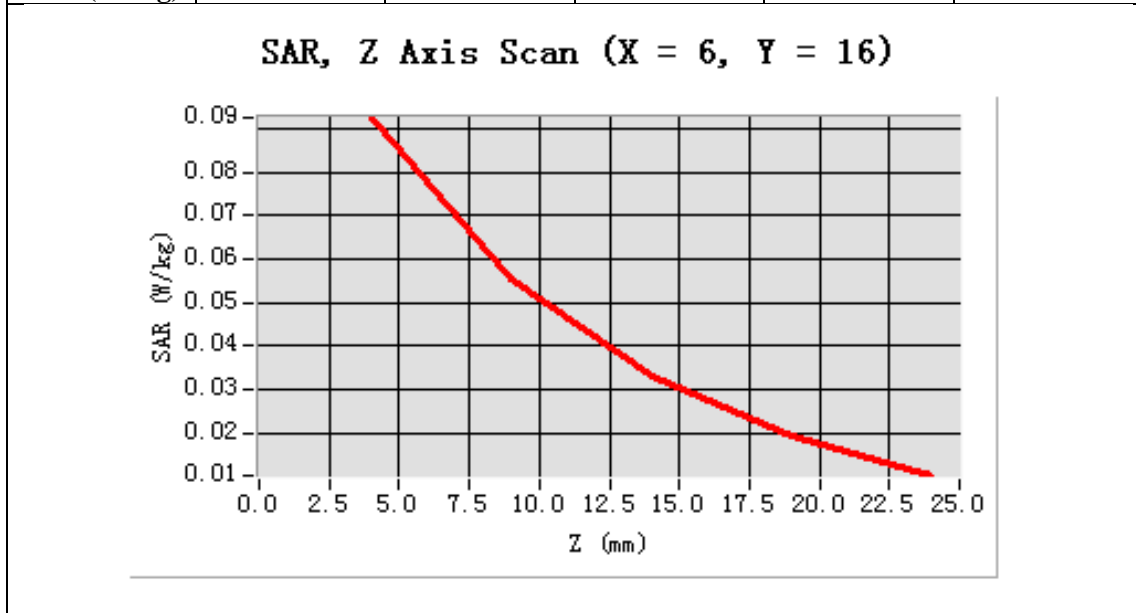

| 3D screen shot   | Hot spot position  |
|--|--|
| <p>A 3D rendering of a human head model in profile, facing right. A color-coded hot spot is visible on the ear area, with red and yellow indicating higher SAR values, transitioning to green and cyan for lower values.</p> | <p>A 3D visualization of the hot spot position, showing two distinct areas of high SAR (red and yellow) on the head model, indicating the locations of maximum exposure.</p> |

Test Laboratory: AGC Lab  
PCS 1900 Mid-Touch-Left <SIM 2>  
DUT: Sync Plus 3.5; Type: X350

Date: Sep. 09,2014

Communication System: Generic GSM; Communication System Band: PCS 1900; Duty Cycle: 1:8.3; Conv.F=4.51;  
Frequency: 1880 MHz; Medium parameters used:  $f = 1900$  MHz;  $\sigma = 1.38$  mho/m;  $\epsilon_r = 39.06$ ;  $\rho = 1000$  kg/m<sup>3</sup> ;  
Phantom section: Left Section  
Ambient temperature (°C): 21.0, Liquid temperature (°C): 21.0

SATIMO Configuration:

- Probe: SSE5; Calibrated: 01/12/2014; Serial No.:SN 22/12 EP159
- Sensor-Surface: 4mm (Mechanical Surface Detection)
- Phantom: Flat Phantom; Type: Elliptical Phantom
- Measurement SW: OpenSAR V4\_02\_01

Configuration/PCS1900 Mid-Touch-Left/Area Scan: Measurement grid: dx=8mm, dy=8mm  
Configuration/PCS1900 Mid-Touch-Left/Zoom Scan: Measurement grid: dx=8mm,dy=8mm, dz=5mm;

|                 |                                      |
|-----------------|--------------------------------------|
| Area Scan       | sam_direct_droit2_surf8mm.txt        |
| ZoomScan        | 5x5x7,dx=8mm dy=8mm dz=5mm,Very fast |
| Phantom         | Left head                            |
| Device Position | Cheek                                |
| Band            | PCS 1900                             |
| Channels        | Middle                               |
| Signal          | TDMA (Crest factor: 8.0)             |

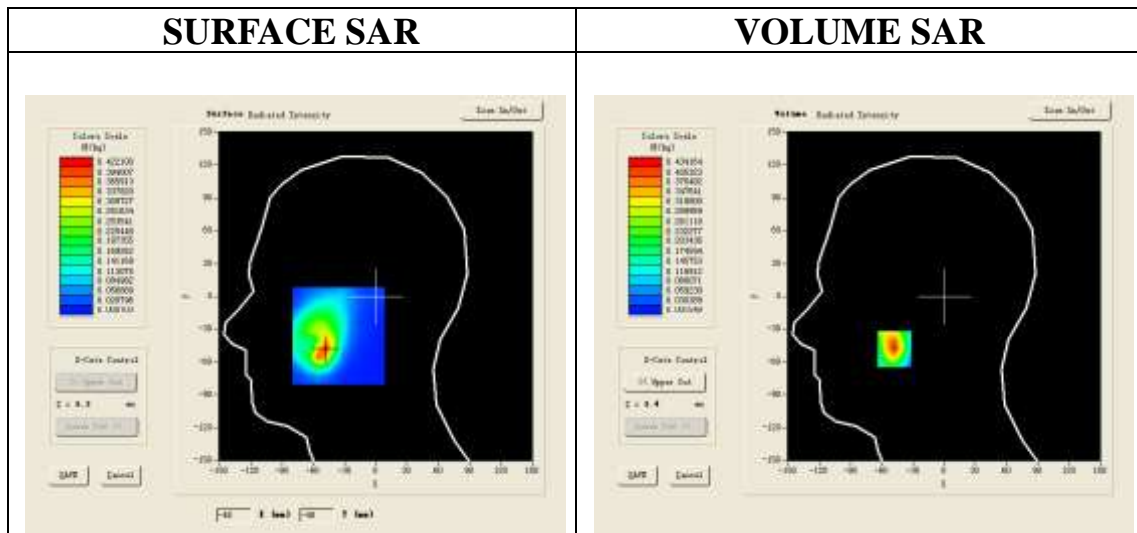

Maximum location: X=-48.00, Y=-48.00

|                |          |
|----------------|----------|
| SAR 10g (W/Kg) | 0.196541 |
| SAR 1g (W/Kg)  | 0.403635 |

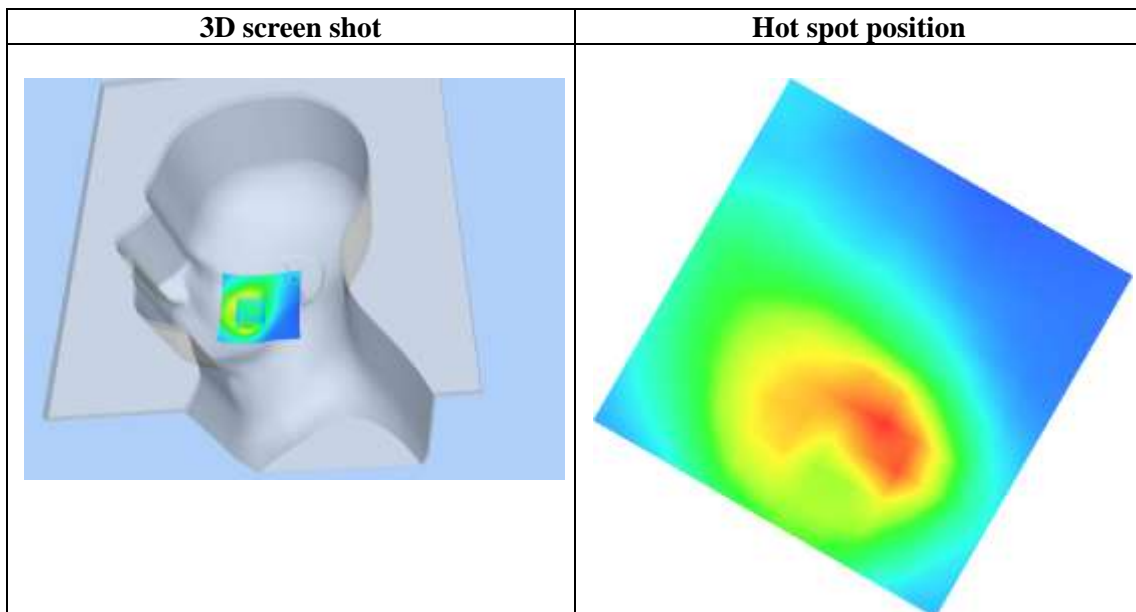
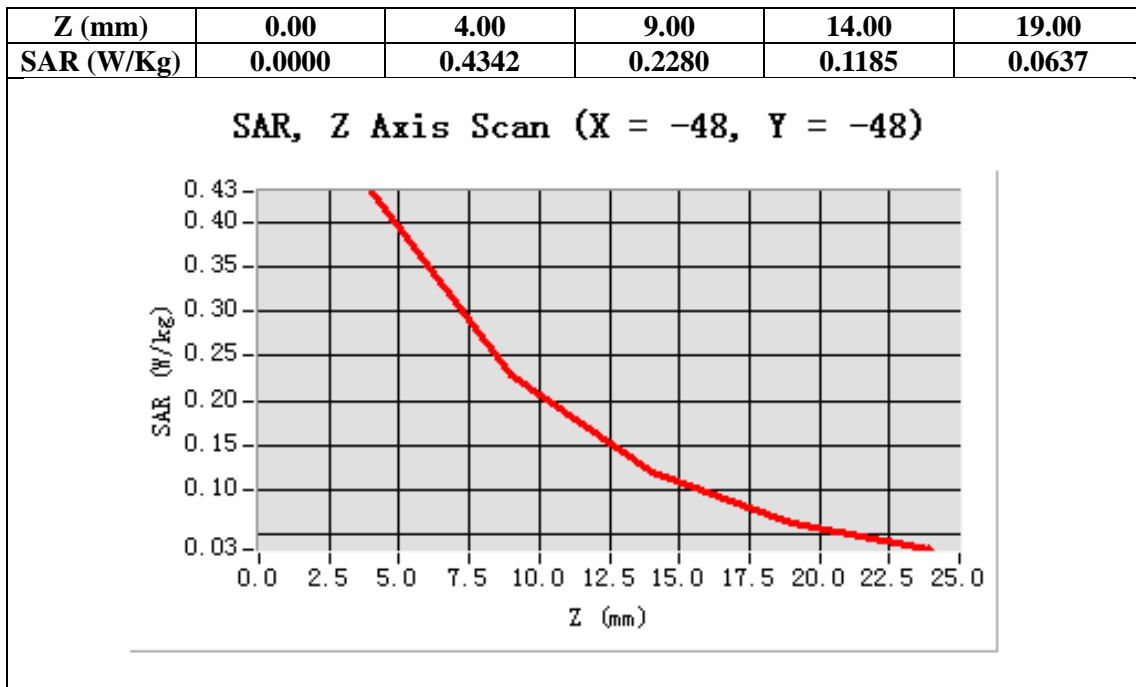

Test Laboratory: AGC Lab  
PCS 1900 Mid-Body-Back <SIM 1>  
DUT: Sync Plus 3.5; Type: X350

Date: Sep. 09,2014

Communication System: Generic GSM; Communication System Band: PCS 1900; Duty Cycle: 1:8.3; Conv.F=4.45;  
Frequency: 1880 MHz; Medium parameters used:  $f = 1900$  MHz;  $\sigma = 1.55$  mho/m;  $\epsilon_r = 54.04$ ;  $\rho = 1000$  kg/m<sup>3</sup> ;  
Phantom section: Flat Section  
Ambient temperature (°C): 21.0, Liquid temperature (°C): 21.0

SATIMO Configuration:

- Probe: SSE5; Calibrated: 01/12/2014; Serial No.:SN 22/12 EP159
- Sensor-Surface: 4mm (Mechanical Surface Detection)
- Phantom: Flat Phantom; Type: Elliptical Phantom
- Measurement SW: OpenSAR V4\_02\_01

Configuration/PCS1900 Mid-Body-Back/Area Scan: Measurement grid: dx=8mm, dy=8mm  
Configuration/PCS1900 Mid-Body-Back/Zoom Scan: Measurement grid: dx=8mm,dy=8mm, dz=5mm;

|                 |                                      |
|-----------------|--------------------------------------|
| Area Scan       | surf_sam_plan.txt                    |
| ZoomScan        | 5x5x7,dx=8mm dy=8mm dz=5mm,Very fast |
| Phantom         | Validation plane                     |
| Device Position | Body Back                            |
| Band            | PCS 1900                             |
| Channels        | Middle                               |
| Signal          | TDMA (Crest factor: 8.0)             |

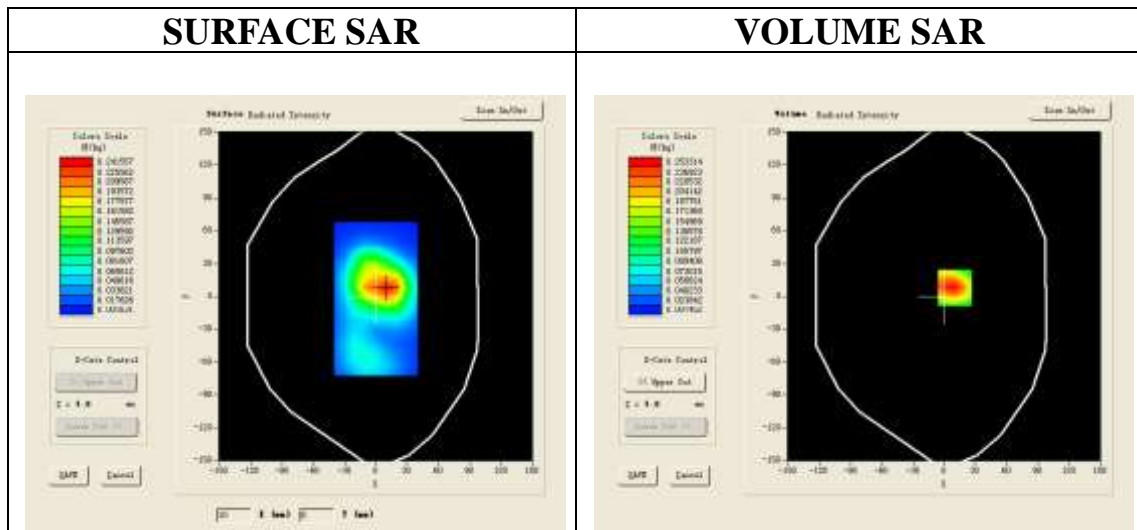

Maximum location: X=10.00, Y=8.00

|                |          |
|----------------|----------|
| SAR 10g (W/Kg) | 0.131851 |
| SAR 1g (W/Kg)  | 0.249264 |

| Z (mm)     | 0.00   | 4.00   | 9.00   | 14.00  | 19.00  |
|------------|--------|--------|--------|--------|--------|
| SAR (W/Kg) | 0.0000 | 0.2533 | 0.1248 | 0.0620 | 0.0339 |

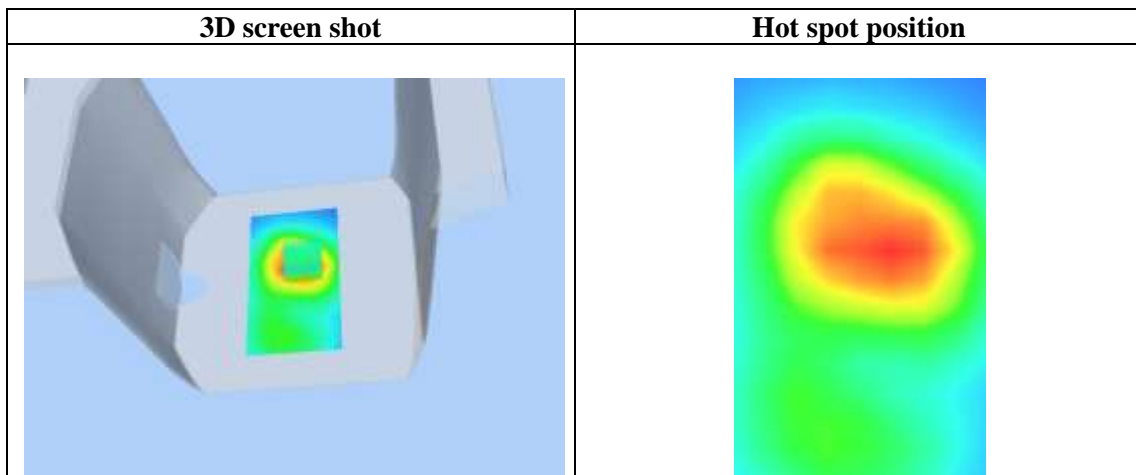
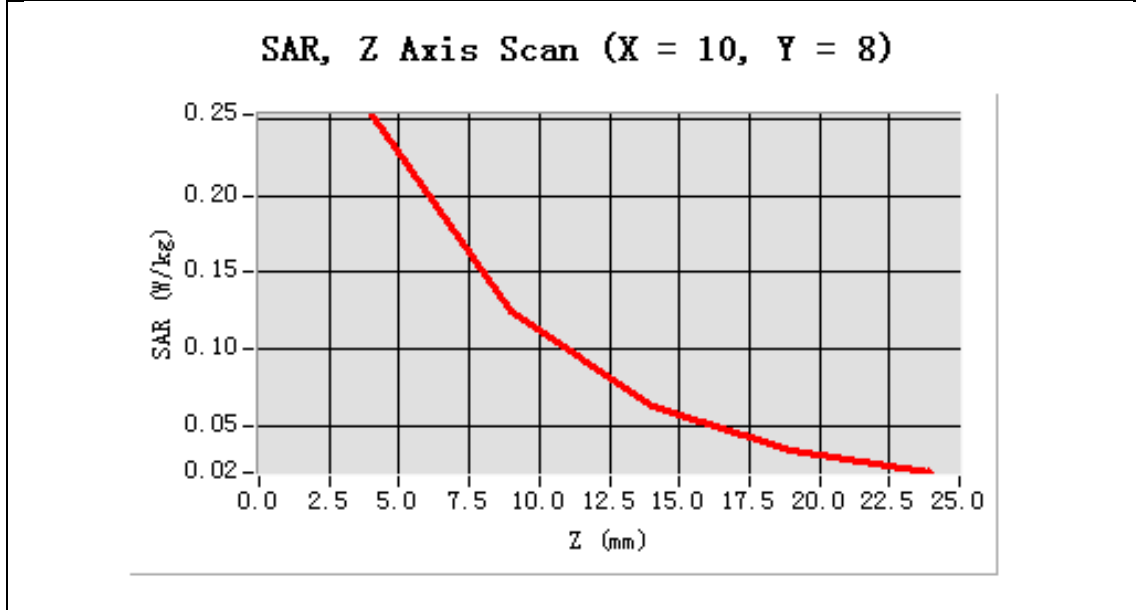

Test Laboratory: AGC Lab  
PCS 1900 Mid-Body -Front (MS) <SIM 1>  
DUT: Sync Plus 3.5; Type: X350

Date: Sep. 09,2014

Communication System: Generic GSM; Communication System Band: PCS 1900; Duty Cycle: 1:8.3; Conv.F=4.45;  
Frequency: 1880 MHz; Medium parameters used:  $f = 1900$  MHz;  $\sigma = 1.55$  mho/m;  $\epsilon_r = 54.04$ ;  $\rho = 1000$  kg/m<sup>3</sup> ;  
Phantom section: Flat Section  
Ambient temperature (°C): 21.0, Liquid temperature (°C): 21.0

SATIMO Configuration:

- Probe: SSE5; Calibrated: 01/12/2014; Serial No.:SN 22/12 EP159
- Sensor-Surface: 4mm (Mechanical Surface Detection)
- Phantom: Flat Phantom; Type: Elliptical Phantom
- Measurement SW: OpenSAR V4\_02\_01

Configuration/PCS1900 Mid-Body- Front /Area Scan: Measurement grid: dx=8mm, dy=8mm

Configuration/PCS1900 Mid-Body- Front /Zoom Scan: Measurement grid: dx=8mm,dy=8mm, dz=5mm;

|                 |                                      |
|-----------------|--------------------------------------|
| Area Scan       | surf_sam_plan.txt                    |
| ZoomScan        | 5x5x7,dx=8mm dy=8mm dz=5mm,Very fast |
| Phantom         | Validation plane                     |
| Device Position | Body Front                           |
| Band            | PCS 1900                             |
| Channels        | Middle                               |
| Signal          | TDMA (Crest factor: 8.0)             |

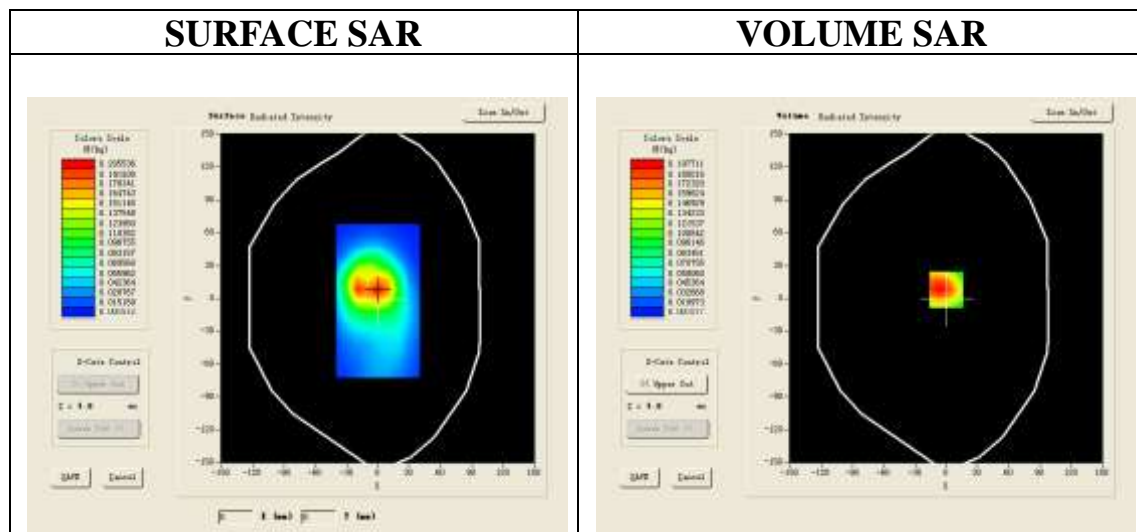

**Maximum location: X=0.00, Y=8.00**

|                       |          |
|-----------------------|----------|
| <b>SAR 10g (W/Kg)</b> | 0.107585 |
| <b>SAR 1g (W/Kg)</b>  | 0.195289 |



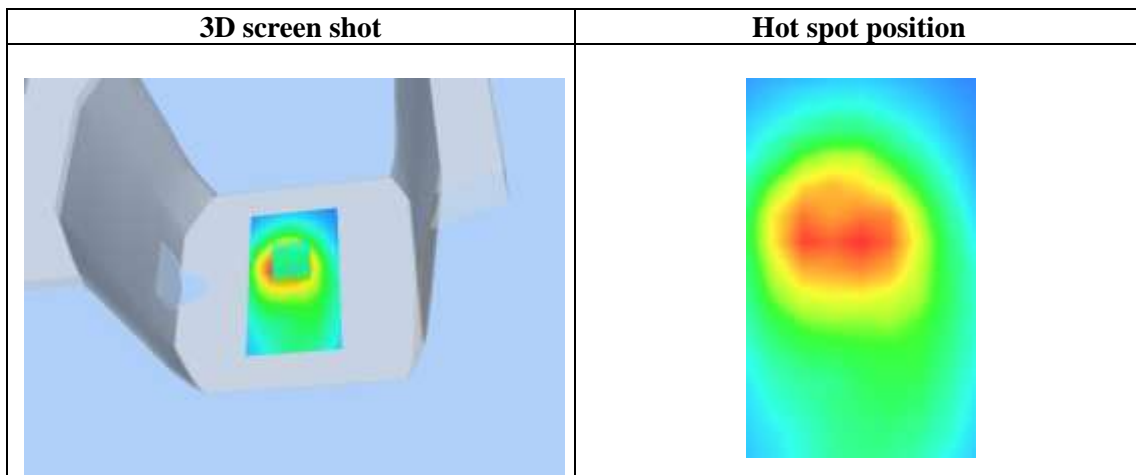
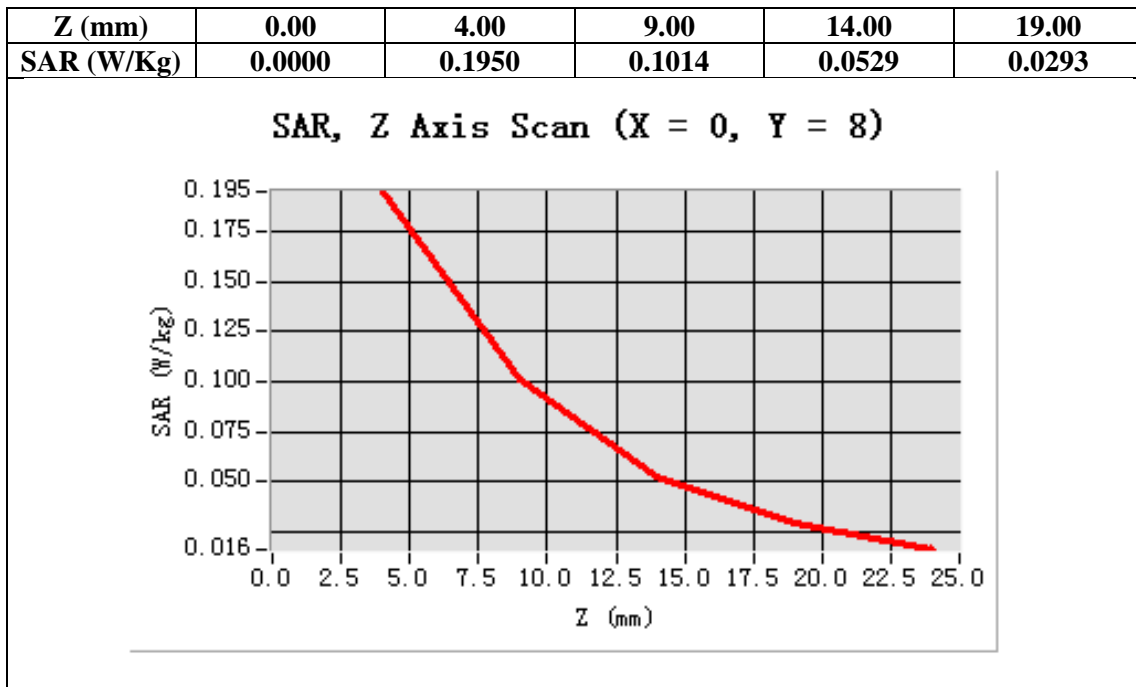

**HOTSPOT MODE**

Test Laboratory: AGC Lab  
Hotspot Mid-Body-Worn- Back (DTS)  
DUT: PPNN; Type: MMNN

Date: Sep. 09,2014

Communication System: Wi-Fi; Communication System Band: Hotspot; Duty Cycle: 1:1; Conv.F=4.31;  
Frequency: 2437 MHz; Medium parameters used:  $f = 2450$  MHz;  $\sigma=1.92$ mho/m;  $\epsilon_r =52.99$ ;  $\rho= 1000$  kg/m<sup>3</sup> ;  
Phantom section: Flat Section  
Ambient temperature (°C):21, Liquid temperature (°C):21

SATIMO Configuration:

- Probe: SSE5; Calibrated: 01/12/2014; Serial No.:SN 22/12 EP159
- Sensor-Surface: 4mm (Mechanical Surface Detection)
- Phantom: Flat Phantom; Type: Elliptical Phantom
- Measurement SW: OpenSAR V4\_02\_01

Configuration/Hotspot Mid- Body- Back /Area Scan: Measurement grid: dx=8mm, dy=8mm  
Configuration/Hotspot Mid- Body- Back /Zoom Scan: Measurement grid: dx=8mm,dy=8mm, dz=5mm;

|                 |                                      |
|-----------------|--------------------------------------|
| Area Scan       | surf_sam_plan.txt                    |
| ZoomScan        | 5x5x7,dx=8mm dy=8mm dz=5mm,Very fast |
| Phantom         | Validation plane                     |
| Device Position | Body Back                            |
| Band            | 2450MHz                              |
| Channels        | Middle                               |
| Signal          | Crest factor: 1.0                    |

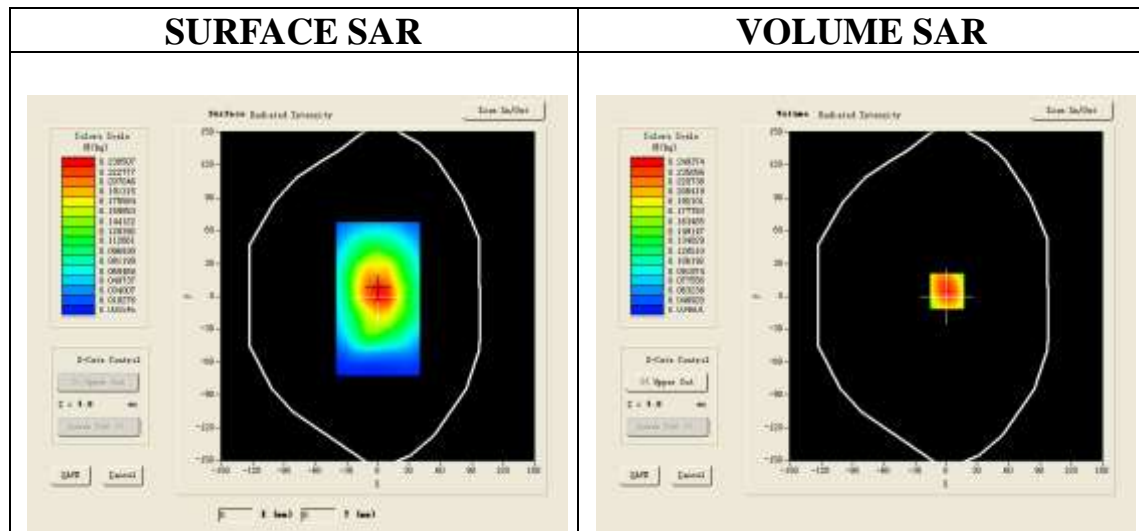

Maximum location: X=1.00, Y=5.00

|                |          |
|----------------|----------|
| SAR 10g (W/Kg) | 0.161529 |
| SAR 1g (W/Kg)  | 0.256247 |

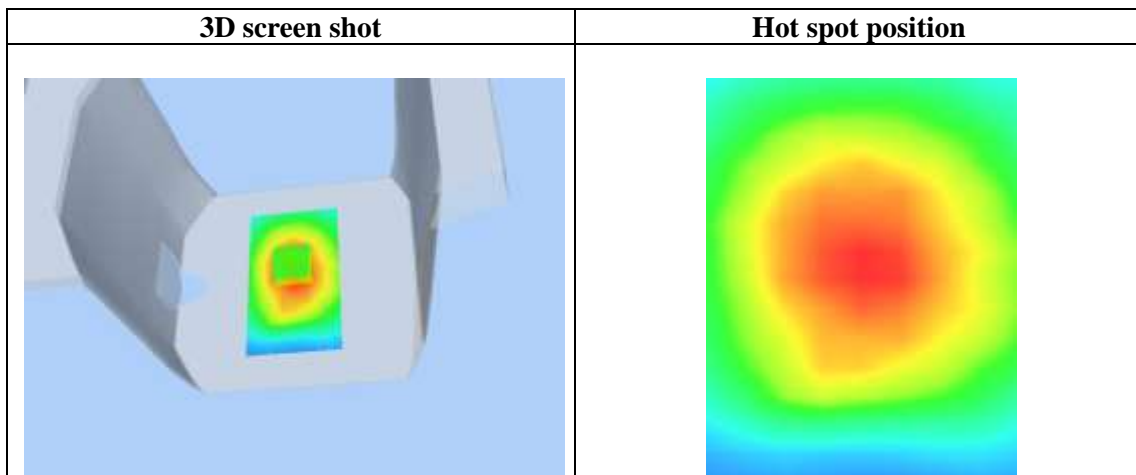
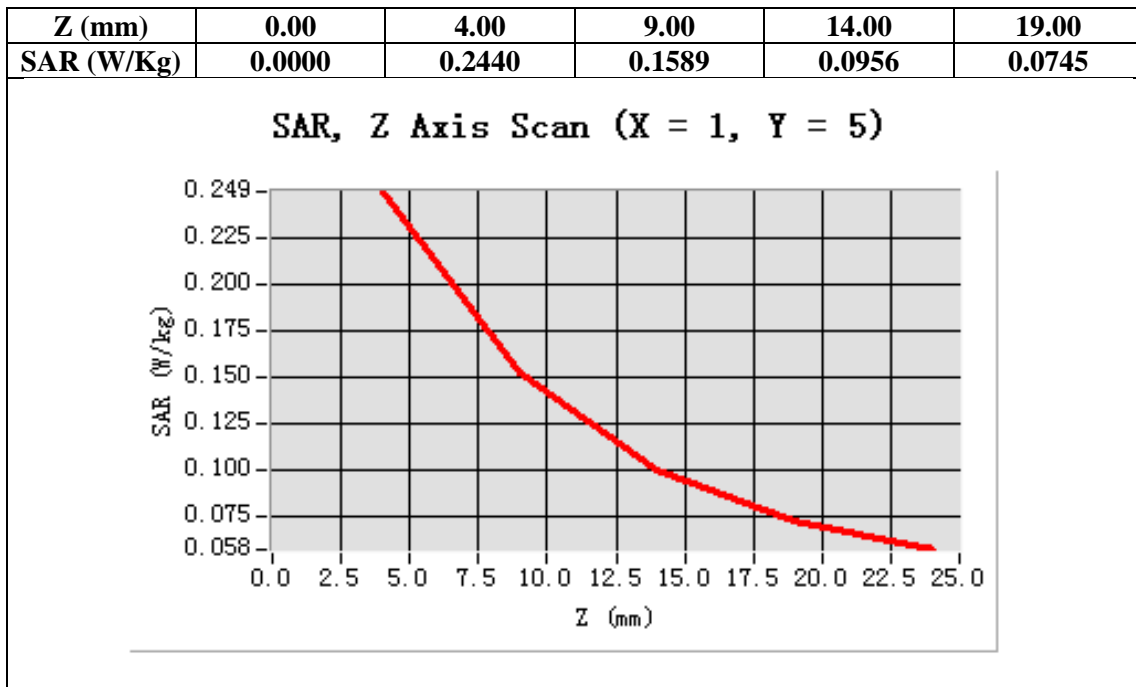

Test Laboratory: AGC Lab  
Hotspot Mid-Body -Front (DTS)  
DUT: PPNN; Type: MMNN

Date: Sep. 09,2014

Communication System: Wi-Fi; Communication System Band: Hotspot; Duty Cycle: 1:1; Conv.F=4.31;  
Frequency: 2437 MHz; Medium parameters used:  $f = 2450$  MHz;  $\sigma=1.92$ mho/m;  $\epsilon_r =52.99$ ;  $\rho= 1000$  kg/m<sup>3</sup> ;  
Phantom section: Flat Section  
Ambient temperature (°C):21, Liquid temperature (°C):21

SATIMO Configuration:

- Probe: SSE5; Calibrated: 01/12/2014; Serial No.:SN 22/12 EP159
- Sensor-Surface: 4mm (Mechanical Surface Detection)
- Phantom: Flat Phantom; Type: Elliptical Phantom
- Measurement SW: OpenSAR V4\_02\_01

Configuration/Hotspot Mid-Body- Front /Area Scan: Measurement grid: dx=8mm, dy=8mm  
Configuration/Hotspot Mid-Body- Front /Zoom Scan: Measurement grid: dx=8mm,dy=8mm, dz=5mm;

|                 |                                      |
|-----------------|--------------------------------------|
| Area Scan       | surf_sam_plan.txt                    |
| ZoomScan        | 5x5x7,dx=8mm dy=8mm dz=5mm,Very fast |
| Phantom         | Validation plane                     |
| Device Position | Body Front                           |
| Band            | 2450MHz                              |
| Channels        | Middle                               |
| Signal          | Crest factor: 1.0                    |

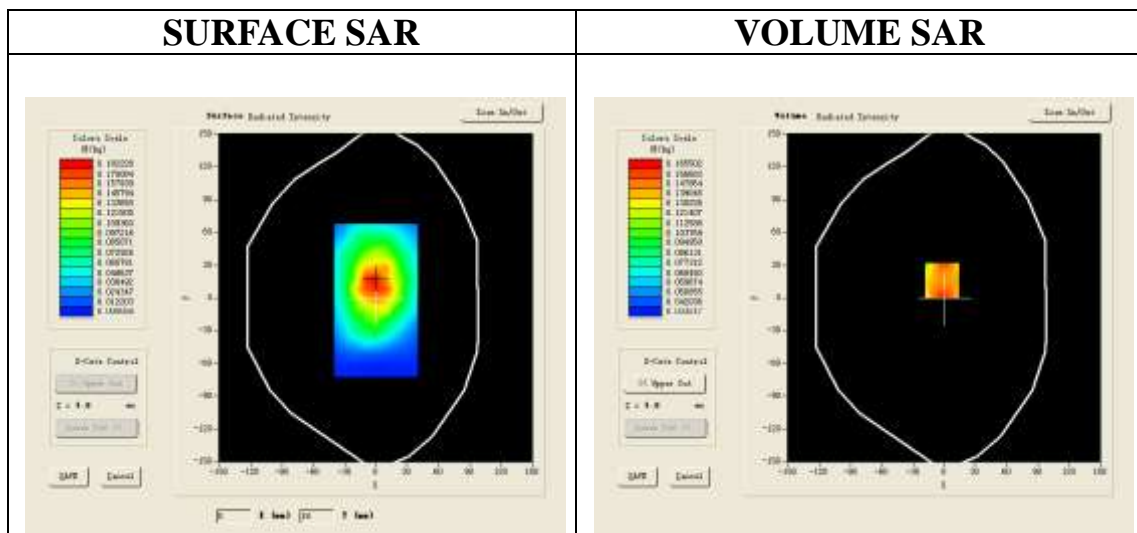

Maximum location: X=-2.00, Y=16.00

|                |          |
|----------------|----------|
| SAR 10g (W/Kg) | 0.126285 |
| SAR 1g (W/Kg)  | 0.169647 |

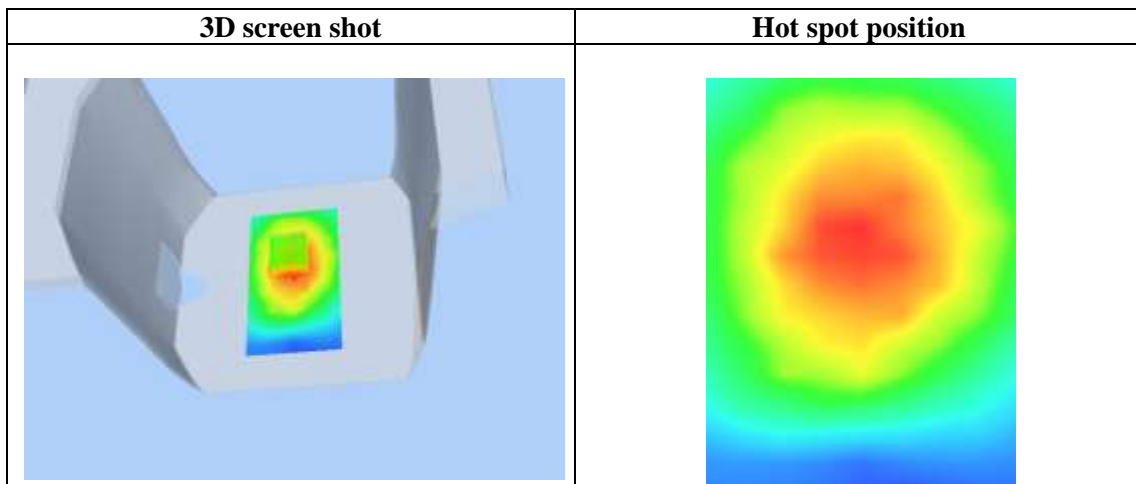
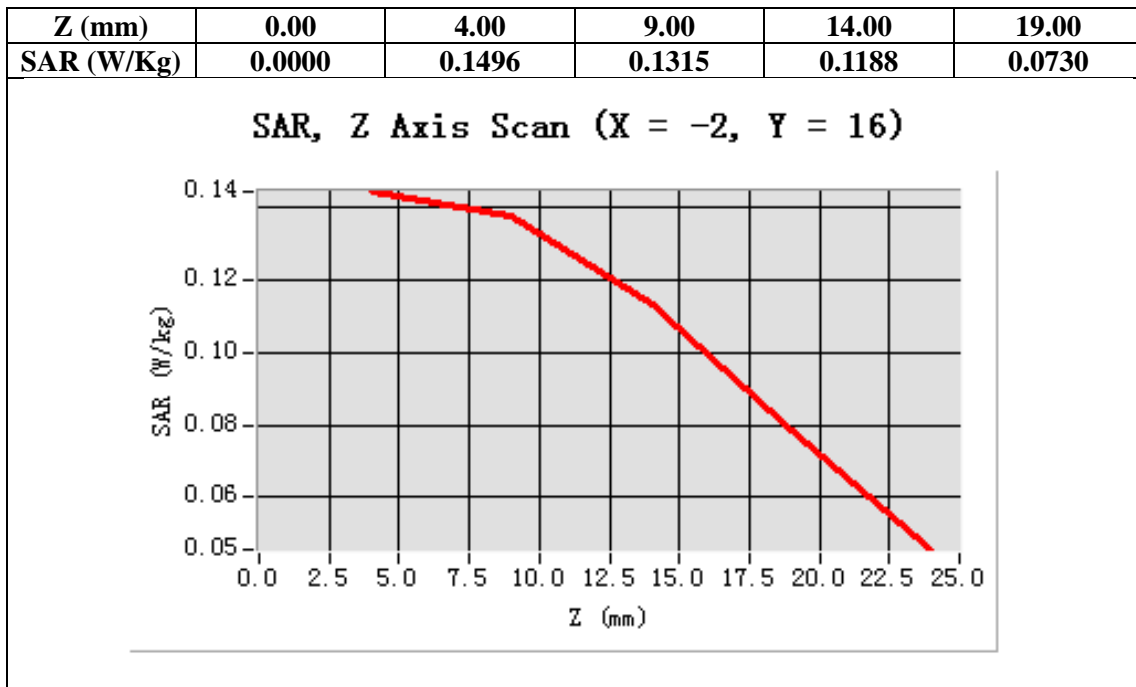

## APPENDIX C. TEST SETUP PHOTOGRAPHS & EUT PHOTOGRAPHS

### Test Setup Photographs

LEFT-CHECK TOUCH



LEFT-TILT 15°

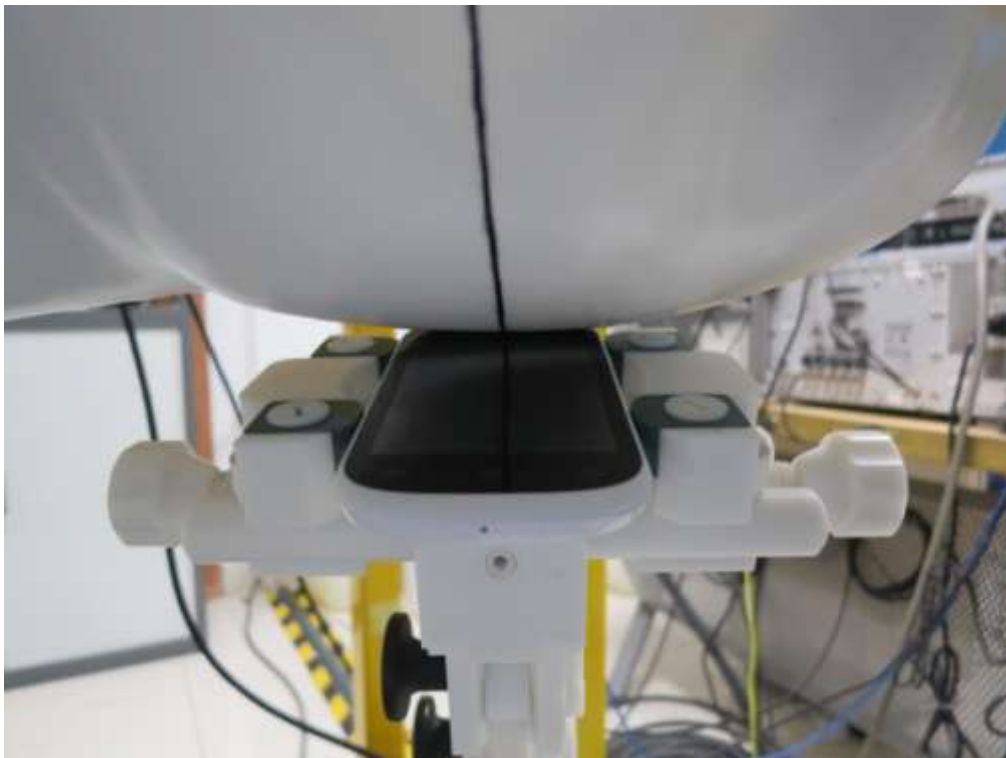

RIGHT-CHECK TOUCH



RIGHT-TILT 15°



Body Back 10mm

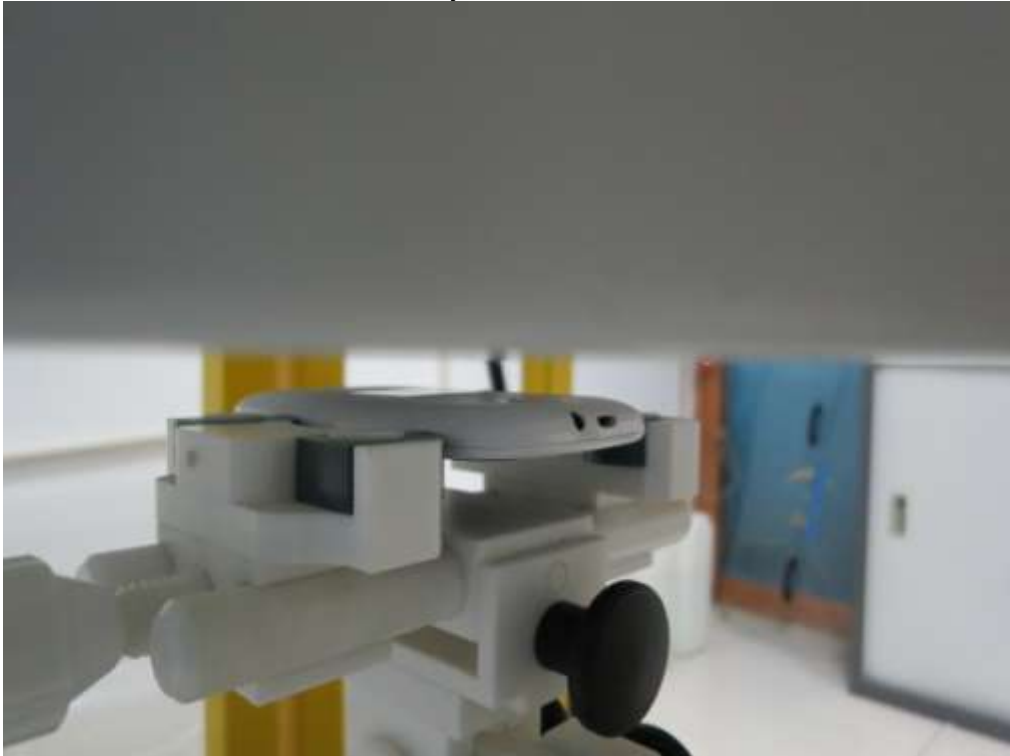

Body Front 10mm





### DEPTH OF THE LIQUID IN THE PHANTOM—ZOOM IN

Note : The position used in the measurement were according to IEEE 1528-2003



**EUT PHOTOGRAPHS**  
All VIEW OF EUT



TOP VIEW OF EUT



BOTTOM VIEW OF EUT



FRONT VIEW OF EUT



BACK VIEW OF EUT



LEFT VIEW OF EUT



RIGHT VIEW OF EUT



OPEN VIEW OF EUT-1



OPEN VIEW OF EUT-2



OPEN VIEW OF EUT-3



INTERNAL VIEW OF EUT-1



INTERNAL VIEW OF EUT-2



## APPENDIX D. PROBE CALIBRATION DATA



### COMOSAR E-Field Probe Calibration Report

Ref : ACR.351.1.14.SATU.A

**ATTESTATION OF GLOBAL COMPLIANCE CO.  
LTD.**

**1&2F, NO.2 BUILDING, HUAFENG NO.1 INDUSTRIAL  
PARK, GUSHU COMMUNITY XIXIANG STREET  
BAOAN DISTRICT, SHENZHEN, P.R. CHINA  
SATIMO COMOSAR DOSIMETRIC E-FIELD PROBE**

**SERIAL NO.: SN 22/12 EP159**

**Calibrated at SATIMO US  
2105 Barrett Park Dr. - Kennesaw, GA 30144**



**01/12/14**

*Summary:*

This document presents the method and results from an accredited COMOSAR Dosimetric E-Field Probe calibration performed in SATIMO USA using the CALISAR / CALIBAIR test bench, for use with a SATIMO COMOSAR system only. All calibration results are traceable to national metrology institutions.





|                      | <i>Name</i>   | <i>Function</i> | <i>Date</i> | <i>Signature</i>     |
|----------------------|---------------|-----------------|-------------|----------------------|
| <i>Prepared by :</i> | Jérôme LUC    | Product Manager | 1/12/2014   | <i>JL</i>            |
| <i>Checked by :</i>  | Jérôme LUC    | Product Manager | 1/12/2014   | <i>JL</i>            |
| <i>Approved by :</i> | Kim RUTKOWSKI | Quality Manager | 1/12/2014   | <i>Kim Rutkowski</i> |

|                       | <i>Customer Name</i>                               |
|-----------------------|--|
| <i>Distribution :</i> | ATTESTATION<br>OF GLOBAL<br>COMPLIANCE<br>CO. LTD. |

| <i>Issue</i> | <i>Date</i> | <i>Modifications</i> |
|--------------|-------------|----------------------|
| A            | 1/12/2014   | Initial release      |
|              |             |                      |
|              |             |                      |
|              |             |                      |



## TABLE OF CONTENTS

|     |                                       |    |
|-----|---------------------------------------|----|
| 1   | Device Under Test .....               | 4  |
| 2   | Product Description.....              | 4  |
| 2.1 | General Information .....             | 4  |
| 3   | Measurement Method.....               | 4  |
| 3.1 | Linearity .....                       | 4  |
| 3.2 | Sensitivity .....                     | 5  |
| 3.3 | Lower Detection Limit .....           | 5  |
| 3.4 | Isotropy.....                         | 5  |
| 3.5 | Boundary Effect .....                 | 5  |
| 4   | Measurement Uncertainty .....         | 5  |
| 5   | Calibration Measurement Results ..... | 6  |
| 5.1 | Sensitivity in air .....              | 6  |
| 5.2 | Linearity .....                       | 7  |
| 5.3 | Sensitivity in liquid .....           | 7  |
| 5.4 | Isotropy.....                         | 8  |
| 6   | List of Equipment .....               | 10 |



**1 DEVICE UNDER TEST**

| Device Under Test                        |   |
|--|---|
| Device Type                              | COMOSAR DOSIMETRIC E FIELD PROBE  |
| Manufacturer                             | Satimo  |
| Model                                    | SSE5  |
| Serial Number                            | SN 22/12 EP159  |
| Product Condition (new / used)           | used  |
| Frequency Range of Probe                 | 0.3 GHz-3GHz  |
| Resistance of Three Dipoles at Connector | Dipole 1: R1=0.230 MΩ<br>Dipole 2: R2=0.226 MΩ<br>Dipole 3: R3=0.231 MΩ |

A yearly calibration interval is recommended.

**2 PRODUCT DESCRIPTION**

**2.1 GENERAL INFORMATION**

Satimo’s COMOSAR E field Probes are built in accordance to the IEEE 1528, OET 65 Bulletin C and CEI/IEC 62209 standards.



**Figure 1 – Satimo COMOSAR Dosimetric E field Dipole**

|  |        |
|--|--------|
| Probe Length                               | 330 mm |
| Length of Individual Dipoles               | 4.5 mm |
| Maximum external diameter                  | 8 mm   |
| Probe Tip External Diameter                | 5 mm   |
| Distance between dipoles / probe extremity | 2.7 mm |

**3 MEASUREMENT METHOD**

The IEEE 1528, OET 65 Bulletin C, CENELEC EN50361 and CEI/IEC 62209 standards provide recommended practices for the probe calibrations, including the performance characteristics of interest and methods by which to assess their affect. All calibrations / measurements performed meet the fore mentioned standards.

**3.1 LINEARITY**

The evaluation of the linearity was done in free space using the waveguide, performing a power sweep to cover the SAR range 0.01W/kg to 100W/kg.



3.2 SENSITIVITY

The sensitivity factors of the three dipoles were determined using a two step calibration method (air and tissue simulating liquid) using waveguides as outlined in the standards.

3.3 LOWER DETECTION LIMIT

The lower detection limit was assessed using the same measurement set up as used for the linearity measurement. The required lower detection limit is 10 mW/kg.

3.4 ISOTROPY

The axial isotropy was evaluated by exposing the probe to a reference wave from a standard dipole with the dipole mounted under the flat phantom in the test configuration suggested for system validations and checks. The probe was rotated along its main axis from 0 - 360 degrees in 15 degree steps. The hemispherical isotropy is determined by inserting the probe in a thin plastic box filled with tissue-equivalent liquid, with the plastic box illuminated with the fields from a half wave dipole. The dipole is rotated about its axis (0°–180°) in 15° increments. At each step the probe is rotated about its axis (0°–360°).

3.5 BOUNDARY EFFECT

The boundary effect is defined as the deviation between the SAR measured data and the expected exponential decay in the liquid when the probe is oriented normal to the interface. To evaluate this effect, the liquid filled flat phantom is exposed to fields from either a reference dipole or waveguide. With the probe normal to the phantom surface, the peak spatial average SAR is measured and compared to the analytical value at the surface.

4 MEASUREMENT UNCERTAINTY

The guidelines outlined in the IEEE 1528, OET 65 Bulletin C, CENELEC EN50361 and CEI/IEC 62209 standards were followed to generate the measurement uncertainty associated with an E-field probe calibration using the waveguide technique. All uncertainties listed below represent an expanded uncertainty expressed at approximately the 95% confidence level using a coverage factor of k=2, traceable to the Internationally Accepted Guides to Measurement Uncertainty.

| Uncertainty analysis of the probe calibration in waveguide |                       |                          |            |    |                          |
|--|-----------------------|--------------------------|------------|----|--------------------------|
| ERROR SOURCES  | Uncertainty value (%) | Probability Distribution | Divisor    | ci | Standard Uncertainty (%) |
| Incident or forward power                                  | 3.00%                 | Rectangular              | $\sqrt{3}$ | 1  | 1.732%                   |
| Reflected power  | 3.00%                 | Rectangular              | $\sqrt{3}$ | 1  | 1.732%                   |
| Liquid conductivity  | 5.00%                 | Rectangular              | $\sqrt{3}$ | 1  | 2.887%                   |
| Liquid permittivity  | 4.00%                 | Rectangular              | $\sqrt{3}$ | 1  | 2.309%                   |
| Field homogeneity  | 3.00%                 | Rectangular              | $\sqrt{3}$ | 1  | 1.732%                   |
| Field probe positioning                                    | 5.00%                 | Rectangular              | $\sqrt{3}$ | 1  | 2.887%                   |
| Field probe linearity                                      | 3.00%                 | Rectangular              | $\sqrt{3}$ | 1  | 1.732%                   |



|   |  |  |  |  |         |
|---|--|--|--|--|---------|
| Combined standard uncertainty                       |  |  |  |  | 5.831%  |
| Expanded uncertainty<br>95 % confidence level k = 2 |  |  |  |  | 11.662% |

## 5 CALIBRATION MEASUREMENT RESULTS

| Calibration Parameters |       |
|------------------------|-------|
| Liquid Temperature     | 21 °C |
| Lab Temperature        | 21 °C |
| Lab Humidity           | 45 %  |

### 5.1 SENSITIVITY IN AIR

| Normx dipole<br>1 ( $\mu\text{V}/(\text{V}/\text{m})^2$ ) | Normy dipole<br>2 ( $\mu\text{V}/(\text{V}/\text{m})^2$ ) | Normz dipole<br>3 ( $\mu\text{V}/(\text{V}/\text{m})^2$ ) |
|---|---|---|
| 5.41  | 4.68  | 5.48  |

| DCP dipole 1<br>(mV) | DCP dipole 2<br>(mV) | DCP dipole 3<br>(mV) |
|----------------------|----------------------|----------------------|
| 102                  | 99                   | 95                   |

Calibration curves  $e_i=f(V)$  ( $i=1,2,3$ ) allow to obtain H-field value using the formula:

$$E = \sqrt{E_1^2 + E_2^2 + E_3^2}$$

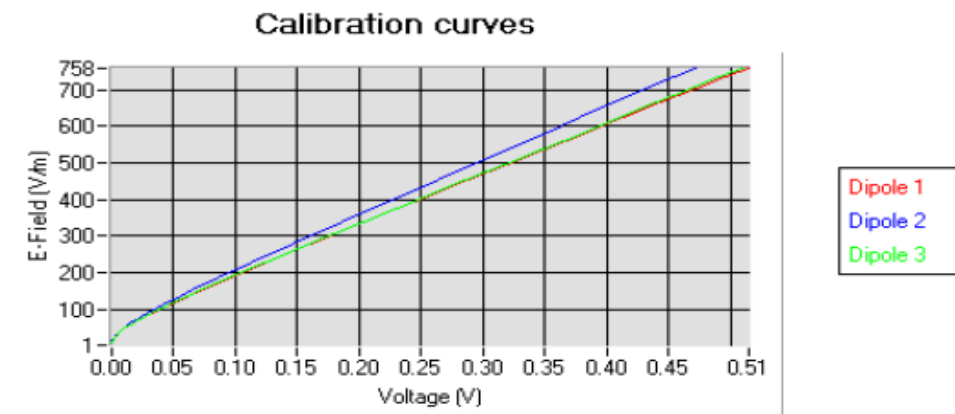



5.2 LINEARITY

Linearity

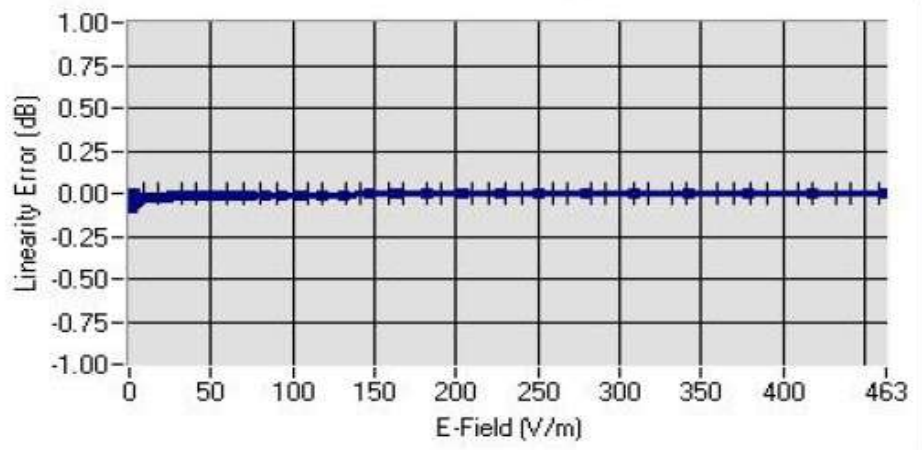

Linearity:  $\pm 1.97\%$  ( $\pm 0.09\text{dB}$ )

5.3 SENSITIVITY IN LIQUID

| Liquid | Frequency (MHz +/- 100MHz)* | Permittivity | Epsilon (S/m) | ConvF |
|--------|-----------------------------|--------------|---------------|-------|
| HL300  | 300                         | 45.27        | 0.85          | 4.60  |
| BL300  | 300                         | 58.01        | 0.94          | 4.68  |
| HL450  | 450                         | 42.87        | 0.89          | 4.71  |
| BL450  | 450                         | 56.37        | 0.93          | 4.83  |
| HL850  | 835                         | 41.12        | 0.91          | 5.27  |
| BL850  | 835                         | 55.03        | 0.97          | 5.48  |
| HL900  | 900                         | 40.77        | 0.98          | 5.20  |
| BL900  | 900                         | 55.49        | 1.04          | 5.28  |
| HL1800 | 1750                        | 39.22        | 1.38          | 4.58  |
| BL1800 | 1750                        | 53.27        | 1.51          | 4.71  |
| HL1900 | 1880                        | 39.54        | 1.41          | 4.51  |
| BL1900 | 1880                        | 52.88        | 1.55          | 4.45  |
| HL2000 | 1950                        | 38.97        | 1.45          | 4.31  |
| BL2000 | 1950                        | 52.01        | 1.58          | 4.33  |
| HL2450 | 2450                        | 39.17        | 1.85          | 4.42  |
| BL2450 | 2450                        | 52.47        | 1.99          | 4.31  |

LOWER DETECTION LIMIT: 9mW/kg



#### 5.4 ISOTROPY

##### HL900 MHz

- Axial isotropy: 0.04 dB
- Hemispherical isotropy: 0.08 dB

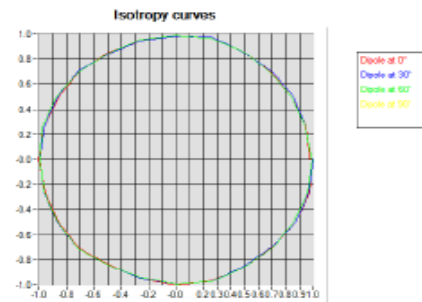

##### HL1800 MHz

- Axial isotropy: 0.07 dB
- Hemispherical isotropy: 0.12 dB

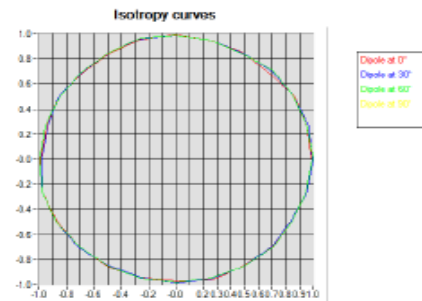



**HL2450 MHz**

- Axial isotropy: 0.09 dB
- Hemispherical isotropy: 0.14 dB

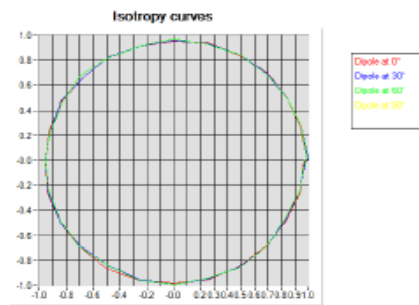





**6 LIST OF EQUIPMENT**

| Equipment Summary Sheet       |                      |                    |   |   |
|-------------------------------|----------------------|--------------------|---|---|
| Equipment Description         | Manufacturer / Model | Identification No. | Current Calibration Date                      | Next Calibration Date                         |
| Flat Phantom                  | Satimo               | SN-20/09-SAM71     | Validated. No cal required.                   | Validated. No cal required.                   |
| COMOSAR Test Bench            | Version 3            | NA                 | Validated. No cal required.                   | Validated. No cal required.                   |
| Network Analyzer              | Rhode & Schwarz ZVA  | SN100132           | 02/2013                                       | 02/2016                                       |
| Reference Probe               | Satimo               | EP 94 SN 37/08     | Characterized prior to test. No cal required. | Characterized prior to test. No cal required. |
| Multimeter                    | Keithley 2000        | 1188656            | 11/2013                                       | 11/2016                                       |
| Signal Generator              | Agilent E4438C       | MY49070581         | 12/2013                                       | 12/2016                                       |
| Amplifier                     | Aethercomm           | SN 046             | Characterized prior to test. No cal required. | Characterized prior to test. No cal required. |
| Power Meter                   | HP E4418A            | US38261498         | 11/2013                                       | 11/2016                                       |
| Power Sensor                  | HP ECP-E26A          | US37181460         | 11/2013                                       | 11/2016                                       |
| Directional Coupler           | Narda 4216-20        | 01386              | Characterized prior to test. No cal required. | Characterized prior to test. No cal required. |
| Waveguide                     | Mega Industries      | 069Y7-158-13-712   | Validated. No cal required.                   | Validated. No cal required.                   |
| Waveguide Transition          | Mega Industries      | 069Y7-158-13-701   | Validated. No cal required.                   | Validated. No cal required.                   |
| Waveguide Termination         | Mega Industries      | 069Y7-158-13-701   | Validated. No cal required.                   | Validated. No cal required.                   |
| Temperature / Humidity Sensor | Control Company      | 11-661-9           | 3/2012  | 3/2014  |

## APPENDIX E. DIPOLE CALIBRATION DATA



### SAR Reference Dipole Calibration Report

Ref: ACR.318.5.13.SATU.A

#### **ATTESTATION OF GLOBAL COMPLIANCE CO. LTD.**

**1&2F, NO.2 BUILDING, HUAFENG NO.1 INDUSTRIAL  
PARK, GUSHU COMMUNITY XIXIANG STREET  
BAOAN DISTRICT, SHENZHEN, P.R. CHINA**

**SATIMO COMOSAR REFERENCE DIPOLE**

**FREQUENCY: 900 MHZ**

**SERIAL NO.: SN 46/11 DIP 0G900-185**

**Calibrated at SATIMO US**

**2105 Barrett Park Dr. - Kennesaw, GA 30144**



**11/14/13**

#### *Summary:*

This document presents the method and results from an accredited SAR reference dipole calibration performed in SATIMO USA using the COMOSAR test bench. All calibration results are traceable to national metrology institutions.



|                      | <i>Name</i>   | <i>Function</i> | <i>Date</i> | <i>Signature</i>     |
|----------------------|---------------|-----------------|-------------|----------------------|
| <i>Prepared by :</i> | Jérôme LUC    | Product Manager | 11/14/2013  | <i>JSS</i>           |
| <i>Checked by :</i>  | Jérôme LUC    | Product Manager | 11/14/2013  | <i>JSS</i>           |
| <i>Approved by :</i> | Kim RUTKOWSKI | Quality Manager | 11/14/2013  | <i>Kim Rutkowski</i> |

|                       | <i>Customer Name</i>                               |
|-----------------------|--|
| <i>Distribution :</i> | ATTESTATION<br>OF GLOBAL<br>COMPLIANCE<br>CO. LTD. |

| <i>Issue</i> | <i>Date</i> | <i>Modifications</i> |
|--------------|-------------|----------------------|
| A            | 11/14/2013  | Initial release      |
|              |             |                      |
|              |             |                      |



## TABLE OF CONTENTS

|     |                                      |    |
|-----|--------------------------------------|----|
| 1   | Introduction.....                    | 4  |
| 2   | Device Under Test.....               | 4  |
| 3   | Product Description.....             | 4  |
| 3.1 | General Information.....             | 4  |
| 4   | Measurement Method.....              | 5  |
| 4.1 | Return Loss Requirements.....        | 5  |
| 4.2 | Mechanical Requirements.....         | 5  |
| 5   | Measurement Uncertainty.....         | 5  |
| 5.1 | Return Loss.....                     | 5  |
| 5.2 | Dimension Measurement.....           | 5  |
| 5.3 | Validation Measurement.....          | 5  |
| 6   | Calibration Measurement Results..... | 6  |
| 6.1 | Return Loss and Impedance.....       | 6  |
| 6.2 | Mechanical Dimensions.....           | 6  |
| 7   | Validation measurement.....          | 7  |
| 7.1 | Measurement Condition.....           | 7  |
| 7.2 | Head Liquid Measurement.....         | 7  |
| 7.3 | Measurement Result.....              | 8  |
| 7.4 | Body Measurement Result.....         | 9  |
| 8   | List of Equipment.....               | 10 |



## 1 INTRODUCTION

This document contains a summary of the requirements set forth by the IEEE 1528, OET 65 Bulletin C and CEI/IEC 62209 standards for reference dipoles used for SAR measurement system validations and the measurements that were performed to verify that the product complies with the fore mentioned standards.

## 2 DEVICE UNDER TEST

| Device Under Test              |                                  |
|--------------------------------|----------------------------------|
| Device Type                    | COMOSAR 900 MHz REFERENCE DIPOLE |
| Manufacturer                   | Satimo                           |
| Model                          | SID900                           |
| Serial Number                  | SN 46/11 DIP 0G900-185           |
| Product Condition (new / used) | Used                             |

A yearly calibration interval is recommended.

## 3 PRODUCT DESCRIPTION

### 3.1 GENERAL INFORMATION

Satimo's COMOSAR Validation Dipoles are built in accordance to the IEEE 1528, OET 65 Bulletin C and CEI/IEC 62209 standards. The product is designed for use with the COMOSAR test bench only.



**Figure 1** – Satimo COMOSAR Validation Dipole



#### 4 MEASUREMENT METHOD

The IEEE 1528, OET 65 Bulletin C and CEI/IEC 62209 standards provide requirements for reference dipoles used for system validation measurements. The following measurements were performed to verify that the product complies with the fore mentioned standards.

##### 4.1 RETURN LOSS REQUIREMENTS

The dipole used for SAR system validation measurements and checks must have a return loss of -20 dB or better. The return loss measurement shall be performed against a liquid filled flat phantom, with the phantom constructed as outlined in the fore mentioned standards.

##### 4.2 MECHANICAL REQUIREMENTS

The IEEE Std. 1528 and CEI/IEC 62209 standards specify the mechanical components and dimensions of the validation dipoles, with the dimensions frequency and phantom shell thickness dependent. The COMOSAR test bench employs a 2 mm phantom shell thickness therefore the dipoles sold for use with the COMOSAR test bench comply with the requirements set forth for a 2 mm phantom shell thickness.

#### 5 MEASUREMENT UNCERTAINTY

All uncertainties listed below represent an expanded uncertainty expressed at approximately the 95% confidence level using a coverage factor of  $k=2$ , traceable to the Internationally Accepted Guides to Measurement Uncertainty.

##### 5.1 RETURN LOSS

The following uncertainties apply to the return loss measurement:

| Frequency band | Expanded Uncertainty on Return Loss |
|----------------|-------------------------------------|
| 400-6000MHz    | 0.1 dB                              |

##### 5.2 DIMENSION MEASUREMENT

The following uncertainties apply to the dimension measurements:

| Length (mm) | Expanded Uncertainty on Length |
|-------------|--------------------------------|
| 3 - 300     | 0.05 mm                        |

##### 5.3 VALIDATION MEASUREMENT

The guidelines outlined in the IEEE 1528, OET 65 Bulletin C, CENELEC EN50361 and CEI/IEC 62209 standards were followed to generate the measurement uncertainty for validation measurements.

| Scan Volume | Expanded Uncertainty |
|-------------|----------------------|
| 1 g         | 20.3 %               |
| 10 g        | 20.1 %               |

Page: 5/10

*This document shall not be reproduced, except in full or in part, without the written approval of SATIMO. The information contained herein is to be used only for the purpose for which it is submitted and is not to be released in whole or part without written approval of SATIMO.*



## 6 CALIBRATION MEASUREMENT RESULTS

### 6.1 RETURN LOSS AND IMPEDANCE

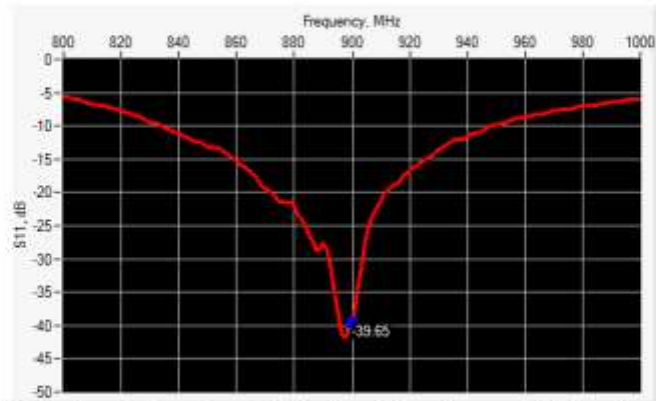

| Frequency (MHz) | Return Loss (dB) | Requirement (dB) | Impedance                      |
|-----------------|------------------|------------------|--------------------------------|
| 900             | -39.65           | -20              | 50.5 $\Omega$ - 1.1 j $\Omega$ |

### 6.2 MECHANICAL DIMENSIONS

| Frequency MHz | L mm            |          | h mm            |          | d mm           |          |
|---------------|-----------------|----------|-----------------|----------|----------------|----------|
|               | required        | measured | required        | measured | required       | measured |
| 300           | 420.0 $\pm$ 1 % |          | 250.0 $\pm$ 1 % |          | 6.35 $\pm$ 1 % |          |
| 450           | 290.0 $\pm$ 1 % |          | 166.7 $\pm$ 1 % |          | 6.35 $\pm$ 1 % |          |
| 750           | 176.0 $\pm$ 1 % |          | 100.0 $\pm$ 1 % |          | 6.35 $\pm$ 1 % |          |
| 835           | 161.0 $\pm$ 1 % |          | 89.8 $\pm$ 1 %  |          | 3.6 $\pm$ 1 %  |          |
| 900           | 149.0 $\pm$ 1 % | PASS     | 83.3 $\pm$ 1 %  | PASS     | 3.6 $\pm$ 1 %  | PASS     |
| 1450          | 89.1 $\pm$ 1 %  |          | 51.7 $\pm$ 1 %  |          | 3.6 $\pm$ 1 %  |          |
| 1500          | 80.5 $\pm$ 1 %  |          | 50.0 $\pm$ 1 %  |          | 3.6 $\pm$ 1 %  |          |
| 1640          | 79.0 $\pm$ 1 %  |          | 45.7 $\pm$ 1 %  |          | 3.6 $\pm$ 1 %  |          |
| 1750          | 75.2 $\pm$ 1 %  |          | 42.9 $\pm$ 1 %  |          | 3.6 $\pm$ 1 %  |          |
| 1800          | 72.0 $\pm$ 1 %  |          | 41.7 $\pm$ 1 %  |          | 3.6 $\pm$ 1 %  |          |
| 1900          | 68.0 $\pm$ 1 %  |          | 39.5 $\pm$ 1 %  |          | 3.6 $\pm$ 1 %  |          |
| 1950          | 66.3 $\pm$ 1 %  |          | 38.5 $\pm$ 1 %  |          | 3.6 $\pm$ 1 %  |          |
| 2000          | 64.5 $\pm$ 1 %  |          | 37.5 $\pm$ 1 %  |          | 3.6 $\pm$ 1 %  |          |
| 2100          | 61.0 $\pm$ 1 %  |          | 35.7 $\pm$ 1 %  |          | 3.6 $\pm$ 1 %  |          |
| 2300          | 55.5 $\pm$ 1 %  |          | 32.6 $\pm$ 1 %  |          | 3.6 $\pm$ 1 %  |          |
| 2450          | 51.5 $\pm$ 1 %  |          | 30.4 $\pm$ 1 %  |          | 3.6 $\pm$ 1 %  |          |
| 2600          | 48.5 $\pm$ 1 %  |          | 28.8 $\pm$ 1 %  |          | 3.6 $\pm$ 1 %  |          |
| 3000          | 41.5 $\pm$ 1 %  |          | 25.0 $\pm$ 1 %  |          | 3.6 $\pm$ 1 %  |          |
| 3500          | 37.0 $\pm$ 1 %  |          | 26.4 $\pm$ 1 %  |          | 3.6 $\pm$ 1 %  |          |
| 3700          | 34.7 $\pm$ 1 %  |          | 26.4 $\pm$ 1 %  |          | 3.6 $\pm$ 1 %  |          |



## 7 VALIDATION MEASUREMENT

The IEEE Std. 1528, OET 65 Bulletin C and CEI/IEC 62209 standards state that the system validation measurements must be performed using a reference dipole meeting the fore mentioned return loss and mechanical dimension requirements. The validation measurement must be performed against a liquid filled flat phantom, with the phantom constructed as outlined in the fore mentioned standards. Per the standards, the dipole shall be positioned below the bottom of the phantom, with the dipole length centered and parallel to the longest dimension of the flat phantom, with the top surface of the dipole at the described distance from the bottom surface of the phantom.

### 7.1 MEASUREMENT CONDITION

|   |   |
|---|---|
| Software                                  | OPENSAR V4  |
| Phantom                                   | SN 20/09 SAM71  |
| Probe                                     | SN 18/11 EP3122   |
| Liquid                                    | Head Liquid Values: $\epsilon_p$ : 41.8 $\sigma$ : 0.96 |
| Distance between dipole center and liquid | 15.0 mm   |
| Area scan resolution                      | $dx=8mm/dy=8mm$   |
| Zoon Scan Resolution                      | $dx=8mm/dy=8m/dz=5mm$                                   |
| Frequency                                 | 900 MHz   |
| Input power                               | 20 dBm  |
| Liquid Temperature                        | 21 °C   |
| Lab Temperature                           | 21 °C   |
| Lab Humidity                              | 45 %  |

### 7.2 HEAD LIQUID MEASUREMENT

| Frequency<br>MHz | Relative permittivity ( $\epsilon_r$ ) |          | Conductivity ( $\sigma$ ) S/m |          |
|------------------|--|----------|-------------------------------|----------|
|                  | required                               | measured | required                      | measured |
| 300              | 45.3 ± 5 %                             |          | 0.87 ± 5 %                    |          |
| 450              | 43.5 ± 5 %                             |          | 0.87 ± 5 %                    |          |
| 750              | 41.9 ± 5 %                             |          | 0.89 ± 5 %                    |          |
| 835              | 41.5 ± 5 %                             |          | 0.90 ± 5 %                    |          |
| 900              | 41.5 ± 5 %                             | PASS     | 0.97 ± 5 %                    | PASS     |
| 1450             | 40.5 ± 5 %                             |          | 1.20 ± 5 %                    |          |
| 1500             | 40.4 ± 5 %                             |          | 1.23 ± 5 %                    |          |
| 1640             | 40.2 ± 5 %                             |          | 1.31 ± 5 %                    |          |
| 1750             | 40.1 ± 5 %                             |          | 1.37 ± 5 %                    |          |
| 1800             | 40.0 ± 5 %                             |          | 1.40 ± 5 %                    |          |
| 1900             | 40.0 ± 5 %                             |          | 1.40 ± 5 %                    |          |
| 1950             | 40.0 ± 5 %                             |          | 1.40 ± 5 %                    |          |
| 2000             | 40.0 ± 5 %                             |          | 1.40 ± 5 %                    |          |
| 2100             | 39.8 ± 5 %                             |          | 1.49 ± 5 %                    |          |
| 2300             | 39.5 ± 5 %                             |          | 1.67 ± 5 %                    |          |
| 2450             | 39.2 ± 5 %                             |          | 1.80 ± 5 %                    |          |
| 2600             | 39.0 ± 5 %                             |          | 1.96 ± 5 %                    |          |
| 3000             | 38.5 ± 5 %                             |          | 2.40 ± 5 %                    |          |
| 3500             | 37.9 ± 5 %                             |          | 2.91 ± 5 %                    |          |

Page: 7/10

*This document shall not be reproduced, except in full or in part, without the written approval of SATIMO. The information contained herein is to be used only for the purpose for which it is submitted and is not to be released in whole or part without written approval of SATIMO.*





**7.3 MEASUREMENT RESULT**

The IEEE Std. 1528 and CEI/IEC 62209 standards state that the system validation measurements should produce the SAR values shown below (for phantom thickness of 2 mm), within the uncertainty for the system validation. All SAR values are normalized to 1 W forward power. In bracket, the measured SAR is given with the used input power.

| Frequency<br>MHz | 1 g SAR (W/kg/W) |              | 10 g SAR (W/kg/W) |             |
|------------------|------------------|--------------|-------------------|-------------|
|                  | required         | measured     | required          | measured    |
| 300              | 2.85             |              | 1.94              |             |
| 450              | 4.58             |              | 3.06              |             |
| 750              | 8.49             |              | 5.55              |             |
| 835              | 9.56             |              | 6.22              |             |
| 900              | 10.9             | 10.70 [1.07] | 6.99              | 6.72 [0.67] |
| 1450             | 29               |              | 16                |             |
| 1500             | 30.5             |              | 16.8              |             |
| 1640             | 34.2             |              | 18.4              |             |
| 1750             | 36.4             |              | 19.3              |             |
| 1800             | 38.4             |              | 20.1              |             |
| 1900             | 39.7             |              | 20.5              |             |
| 1950             | 40.5             |              | 20.9              |             |
| 2000             | 41.1             |              | 21.1              |             |
| 2100             | 43.6             |              | 21.9              |             |
| 2300             | 48.7             |              | 23.3              |             |
| 2450             | 52.4             |              | 24                |             |
| 2600             | 55.3             |              | 24.6              |             |
| 3000             | 63.8             |              | 25.7              |             |
| 3500             | 67.1             |              | 25                |             |

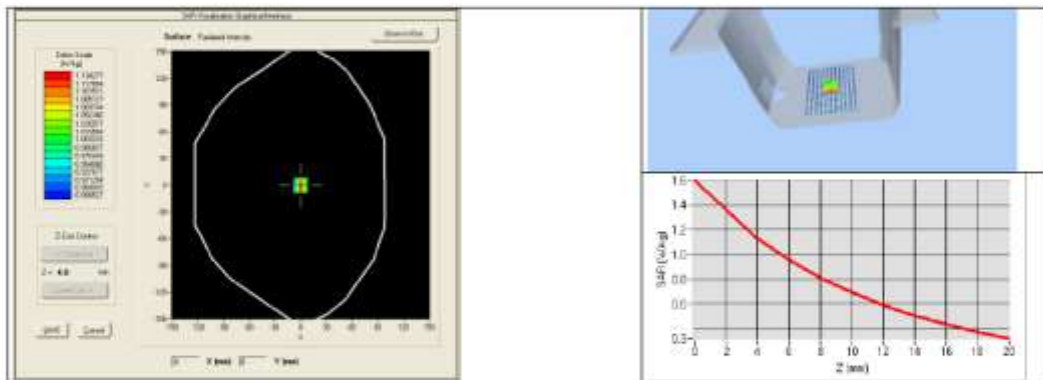



7.4 BODY MEASUREMENT RESULT

|   |  |
|---|--|
| Software                                  | OPENSAR V4   |
| Phantom                                   | SN 20/09 SAM71   |
| Probe                                     | SN 18/11 EPG122  |
| Liquid                                    | Body Liquid Values: $\epsilon_{ps}$ : 56.0 $\sigma$ : 1.04 |
| Distance between dipole center and liquid | 15.0 mm  |
| Area scan resolution                      | $dx=8mm/dy=8mm$  |
| Zoon Scan Resolution                      | $dx=8mm/dy=8mm/dz=5mm$                                     |
| Frequency                                 | 900 MHz  |
| Input power                               | 20 dBm   |
| Liquid Temperature                        | 21 °C  |
| Lab Temperature                           | 21 °C  |
| Lab Humidity                              | 45 %   |

| Frequency<br>MHz | 1 g SAR (W/kg/W) | 10 g SAR (W/kg/W) |
|------------------|------------------|-------------------|
|                  | measured         | measured          |
| 900              | 11.27 (1.13)     | 7.18 (0.72)       |

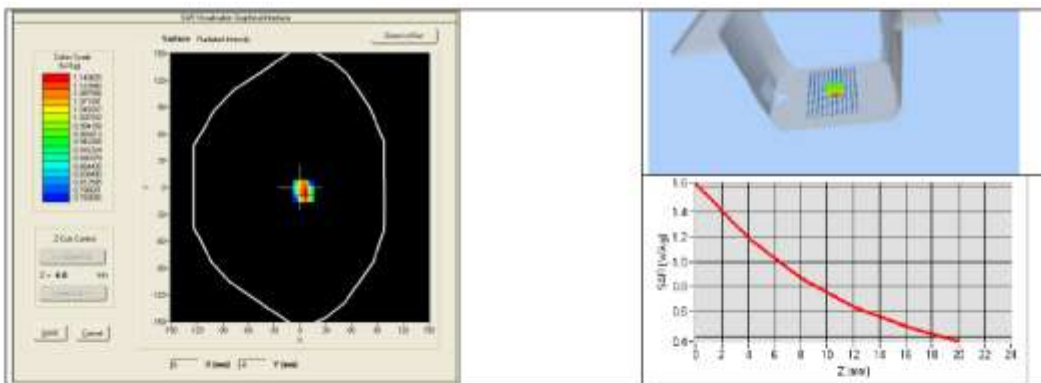



**8 LIST OF EQUIPMENT**

| Equipment Summary Sheet         |                      |                    |   |   |
|---------------------------------|----------------------|--------------------|---|---|
| Equipment Description           | Manufacturer / Model | Identification No. | Current Calibration Date                      | Next Calibration Date                         |
| SAM Phantom                     | Satimo               | SN-20/09-SAM71     | Validated. No cal required.                   | Validated. No cal required.                   |
| CÓMÓ SAR Test Bench             | Version 3            | NA                 | Validated. No cal required.                   | Validated. No cal required.                   |
| Network Analyzer                | Rhode & Schwarz ZVA  | SN100132           | 02/2013                                       | 02/2016                                       |
| Calipers                        | Camera               | CALIPER-01         | 12/2010                                       | 12/2013                                       |
| Reference Probe                 | Satimo               | EPG122 SN 18/11    | Characterized prior to test. No cal required. | Characterized prior to test. No cal required. |
| Multimeter                      | Keithley 2000        | 1188656            | 11/2010                                       | 11/2013                                       |
| Signal Generator                | Agilent E4438C       | MY49070581         | 12/2010                                       | 12/2013                                       |
| Amplifier                       | Aethercomm           | SN 046             | Characterized prior to test. No cal required. | Characterized prior to test. No cal required. |
| Power Meter                     | HP E4418A            | US38261498         | 11/2010                                       | 11/2013                                       |
| Power Sensor                    | HP ECP-E26A          | US37181460         | 11/2010                                       | 11/2013                                       |
| Directional Coupler             | Narda 4216-20        | 01386              | Characterized prior to test. No cal required. | Characterized prior to test. No cal required. |
| Temperature and Humidity Sensor | Control Company      | 11-661-9           | 3/2012  | 3/2014  |



## SAR Reference Dipole Calibration Report

Ref: ACR.318.7.13.SATU.A

### **ATTESTATION OF GLOBAL COMPLIANCE CO. LTD.**

**1&2F, NO.2 BUILDING, HUAFENG NO.1 INDUSTRIAL  
PARK, GUSHU COMMUNITY XIXIANG STREET  
BAOAN DISTRICT, SHENZHEN, P.R. CHINA  
SATIMO COMOSAR REFERENCE DIPOLE  
FREQUENCY: 1900 MHZ  
SERIAL NO.: SN 46/11 DIP 1G900-187**

**Calibrated at SATIMO US  
2105 Barrett Park Dr. - Kennesaw, GA 30144**



**11/14/13**

#### *Summary:*

This document presents the method and results from an accredited SAR reference dipole calibration performed in SATIMO USA using the COMOSAR test bench. All calibration results are traceable to national metrology institutions.



|                      | <i>Name</i>   | <i>Function</i> | <i>Date</i> | <i>Signature</i>     |
|----------------------|---------------|-----------------|-------------|----------------------|
| <i>Prepared by :</i> | Jérôme LUC    | Product Manager | 11/14/2013  | <i>JS</i>            |
| <i>Checked by :</i>  | Jérôme LUC    | Product Manager | 11/14/2013  | <i>JS</i>            |
| <i>Approved by :</i> | Kim RUTKOWSKI | Quality Manager | 11/14/2013  | <i>Kim Rutkowski</i> |

|                       | <i>Customer Name</i>                               |
|-----------------------|--|
| <i>Distribution :</i> | ATTESTATION<br>OF GLOBAL<br>COMPLIANCE<br>CO. LTD. |

| <i>Issue</i> | <i>Date</i> | <i>Modifications</i> |
|--------------|-------------|----------------------|
| A            | 11/14/2013  | Initial release      |
|              |             |                      |
|              |             |                      |
|              |             |                      |



**TABLE OF CONTENTS**

|     |                                      |    |
|-----|--------------------------------------|----|
| 1   | Introduction.....                    | 4  |
| 2   | Device Under Test.....               | 4  |
| 3   | Product Description.....             | 4  |
| 3.1 | General Information.....             | 4  |
| 4   | Measurement Method.....              | 5  |
| 4.1 | Return Loss Requirements.....        | 5  |
| 4.2 | Mechanical Requirements.....         | 5  |
| 5   | Measurement Uncertainty.....         | 5  |
| 5.1 | Return Loss.....                     | 5  |
| 5.2 | Dimension Measurement.....           | 5  |
| 5.3 | Validation Measurement.....          | 5  |
| 6   | Calibration Measurement Results..... | 6  |
| 6.1 | Return Loss and Impedance.....       | 6  |
| 6.2 | Mechanical Dimensions.....           | 6  |
| 7   | Validation measurement.....          | 7  |
| 7.1 | Measurement Condition.....           | 7  |
| 7.2 | Head Liquid Measurement.....         | 7  |
| 7.3 | Measurement Result.....              | 8  |
| 7.4 | Body Measurement Result.....         | 9  |
| 8   | List of Equipment.....               | 10 |



## 1 INTRODUCTION

This document contains a summary of the requirements set forth by the IEEE 1528, OET 65 Bulletin C and CEI/IEC 62209 standards for reference dipoles used for SAR measurement system validations and the measurements that were performed to verify that the product complies with the fore mentioned standards.

## 2 DEVICE UNDER TEST

| Device Under Test              |                                   |
|--------------------------------|-----------------------------------|
| Device Type                    | COMOSAR 1900 MHz REFERENCE DIPOLE |
| Manufacturer                   | Satimo                            |
| Model                          | SID1900                           |
| Serial Number                  | SN 46/11 DIP 1G900-187            |
| Product Condition (new / used) | Used                              |

A yearly calibration interval is recommended.

## 3 PRODUCT DESCRIPTION

### 3.1 GENERAL INFORMATION

Satimo's COMOSAR Validation Dipoles are built in accordance to the IEEE 1528, OET 65 Bulletin C and CEI/IEC 62209 standards. The product is designed for use with the COMOSAR test bench only.



**Figure 1** – Satimo COMOSAR Validation Dipole



#### 4 MEASUREMENT METHOD

The IEEE 1528, OET 65 Bulletin C and CEI/IEC 62209 standards provide requirements for reference dipoles used for system validation measurements. The following measurements were performed to verify that the product complies with the fore mentioned standards.

##### 4.1 RETURN LOSS REQUIREMENTS

The dipole used for SAR system validation measurements and checks must have a return loss of -20 dB or better. The return loss measurement shall be performed against a liquid filled flat phantom, with the phantom constructed as outlined in the fore mentioned standards.

##### 4.2 MECHANICAL REQUIREMENTS

The IEEE Std. 1528 and CEI/IEC 62209 standards specify the mechanical components and dimensions of the validation dipoles, with the dimensions frequency and phantom shell thickness dependent. The COMOSAR test bench employs a 2 mm phantom shell thickness therefore the dipoles sold for use with the COMOSAR test bench comply with the requirements set forth for a 2 mm phantom shell thickness.

#### 5 MEASUREMENT UNCERTAINTY

All uncertainties listed below represent an expanded uncertainty expressed at approximately the 95% confidence level using a coverage factor of k=2, traceable to the Internationally Accepted Guides to Measurement Uncertainty.

##### 5.1 RETURN LOSS

The following uncertainties apply to the return loss measurement:

| Frequency band | Expanded Uncertainty on Return Loss |
|----------------|-------------------------------------|
| 400-6000MHz    | 0.1 dB                              |

##### 5.2 DIMENSION MEASUREMENT

The following uncertainties apply to the dimension measurements:

| Length (mm) | Expanded Uncertainty on Length |
|-------------|--------------------------------|
| 3 - 300     | 0.05 mm                        |

##### 5.3 VALIDATION MEASUREMENT

The guidelines outlined in the IEEE 1528, OET 65 Bulletin C, CENELEC EN50361 and CEI/IEC 62209 standards were followed to generate the measurement uncertainty for validation measurements.

| Scan Volume | Expanded Uncertainty |
|-------------|----------------------|
| 1 g         | 20.3 %               |
| 10 g        | 20.1 %               |





## 6 CALIBRATION MEASUREMENT RESULTS

### 6.1 RETURN LOSS AND IMPEDANCE

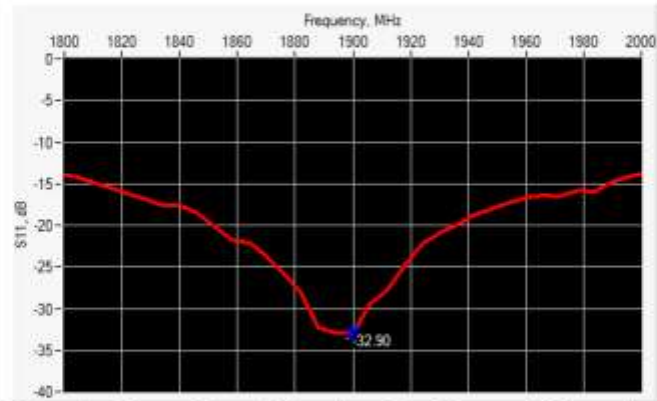

| Frequency (MHz) | Return Loss (dB) | Requirement (dB) | Impedance                      |
|-----------------|------------------|------------------|--------------------------------|
| 1900            | -32.90           | -20              | 48.9 $\Omega$ + 2.3 j $\Omega$ |

### 6.2 MECHANICAL DIMENSIONS

| Frequency MHz | L mm            |          | h mm            |          | d mm           |          |
|---------------|-----------------|----------|-----------------|----------|----------------|----------|
|               | required        | measured | required        | measured | required       | measured |
| 300           | 420.0 $\pm$ 1 % |          | 250.0 $\pm$ 1 % |          | 6.35 $\pm$ 1 % |          |
| 450           | 290.0 $\pm$ 1 % |          | 166.7 $\pm$ 1 % |          | 6.35 $\pm$ 1 % |          |
| 750           | 176.0 $\pm$ 1 % |          | 100.0 $\pm$ 1 % |          | 6.35 $\pm$ 1 % |          |
| 835           | 161.0 $\pm$ 1 % |          | 89.0 $\pm$ 1 %  |          | 3.6 $\pm$ 1 %  |          |
| 900           | 149.0 $\pm$ 1 % |          | 89.3 $\pm$ 1 %  |          | 3.6 $\pm$ 1 %  |          |
| 1450          | 89.1 $\pm$ 1 %  |          | 51.7 $\pm$ 1 %  |          | 3.6 $\pm$ 1 %  |          |
| 1500          | 80.5 $\pm$ 1 %  |          | 50.0 $\pm$ 1 %  |          | 3.6 $\pm$ 1 %  |          |
| 1640          | 79.0 $\pm$ 1 %  |          | 45.7 $\pm$ 1 %  |          | 3.6 $\pm$ 1 %  |          |
| 1750          | 75.2 $\pm$ 1 %  |          | 42.9 $\pm$ 1 %  |          | 3.6 $\pm$ 1 %  |          |
| 1800          | 72.0 $\pm$ 1 %  |          | 41.7 $\pm$ 1 %  |          | 3.6 $\pm$ 1 %  |          |
| 1900          | 68.0 $\pm$ 1 %  | PASS     | 39.5 $\pm$ 1 %  | PASS     | 3.6 $\pm$ 1 %  | PASS     |
| 1950          | 66.3 $\pm$ 1 %  |          | 38.5 $\pm$ 1 %  |          | 3.6 $\pm$ 1 %  |          |
| 2000          | 64.5 $\pm$ 1 %  |          | 37.5 $\pm$ 1 %  |          | 3.6 $\pm$ 1 %  |          |
| 2100          | 61.0 $\pm$ 1 %  |          | 35.7 $\pm$ 1 %  |          | 3.6 $\pm$ 1 %  |          |
| 2300          | 55.5 $\pm$ 1 %  |          | 32.6 $\pm$ 1 %  |          | 3.6 $\pm$ 1 %  |          |
| 2450          | 51.5 $\pm$ 1 %  |          | 30.4 $\pm$ 1 %  |          | 3.6 $\pm$ 1 %  |          |
| 2600          | 48.5 $\pm$ 1 %  |          | 28.8 $\pm$ 1 %  |          | 3.6 $\pm$ 1 %  |          |
| 3000          | 41.5 $\pm$ 1 %  |          | 25.0 $\pm$ 1 %  |          | 3.6 $\pm$ 1 %  |          |
| 3500          | 37.0 $\pm$ 1 %  |          | 26.4 $\pm$ 1 %  |          | 3.6 $\pm$ 1 %  |          |
| 3700          | 34.7 $\pm$ 1 %  |          | 26.4 $\pm$ 1 %  |          | 3.6 $\pm$ 1 %  |          |



## 7 VALIDATION MEASUREMENT

The IEEE Std. 1528, OET 65 Bulletin C and CEI/IEC 62209 standards state that the system validation measurements must be performed using a reference dipole meeting the fore mentioned return loss and mechanical dimension requirements. The validation measurement must be performed against a liquid filled flat phantom, with the phantom constructed as outlined in the fore mentioned standards. Per the standards, the dipole shall be positioned below the bottom of the phantom, with the dipole length centered and parallel to the longest dimension of the flat phantom, with the top surface of the dipole at the described distance from the bottom surface of the phantom.

### 7.1 MEASUREMENT CONDITION

|   |  |
|---|--|
| Software                                  | OPENSAR V4   |
| Phantom                                   | SN 20/09 SAM71   |
| Probe                                     | SN 18/11 EPG122  |
| Liquid                                    | Head Liquid Values: $\epsilon_p'$ : 39.8 $\sigma$ : 1.43 |
| Distance between dipole center and liquid | 10.0 mm  |
| Area scan resolution                      | $dx=8mm/dy=8mm$  |
| Zoon Scan Resolution                      | $dx=8mm/dy=8m/dz=5mm$                                    |
| Frequency                                 | 1900 MHz   |
| Input power                               | 20 dBm   |
| Liquid Temperature                        | 21 °C  |
| Lab Temperature                           | 21 °C  |
| Lab Humidity                              | 45 %   |

### 7.2 HEAD LIQUID MEASUREMENT

| Frequency<br>MHz | Relative permittivity ( $\epsilon_p'$ ) |          | Conductivity ( $\sigma$ ) S/m |          |
|------------------|---|----------|-------------------------------|----------|
|                  | required                                | measured | required                      | measured |
| 300              | 45.3 ±5 %                               |          | 0.87 ±5 %                     |          |
| 450              | 43.5 ±5 %                               |          | 0.87 ±5 %                     |          |
| 750              | 41.9 ±5 %                               |          | 0.89 ±5 %                     |          |
| 835              | 41.5 ±5 %                               |          | 0.90 ±5 %                     |          |
| 900              | 41.5 ±5 %                               |          | 0.97 ±5 %                     |          |
| 1450             | 40.5 ±5 %                               |          | 1.20 ±5 %                     |          |
| 1500             | 40.4 ±5 %                               |          | 1.23 ±5 %                     |          |
| 1640             | 40.2 ±5 %                               |          | 1.31 ±5 %                     |          |
| 1750             | 40.1 ±5 %                               |          | 1.37 ±5 %                     |          |
| 1800             | 40.0 ±5 %                               |          | 1.40 ±5 %                     |          |
| 1900             | 40.0 ±5 %                               | PASS     | 1.40 ±5 %                     | PASS     |
| 1950             | 40.0 ±5 %                               |          | 1.40 ±5 %                     |          |
| 2000             | 40.0 ±5 %                               |          | 1.40 ±5 %                     |          |
| 2100             | 39.8 ±5 %                               |          | 1.49 ±5 %                     |          |
| 2300             | 39.5 ±5 %                               |          | 1.67 ±5 %                     |          |
| 2450             | 39.2 ±5 %                               |          | 1.80 ±5 %                     |          |
| 2600             | 39.0 ±5 %                               |          | 1.96 ±5 %                     |          |
| 3000             | 38.5 ±5 %                               |          | 2.40 ±5 %                     |          |
| 3500             | 37.9 ±5 %                               |          | 2.91 ±5 %                     |          |

Page: 7/10

*This document shall not be reproduced, except in full or in part, without the written approval of SATIMO. The information contained herein is to be used only for the purpose for which it is submitted and is not to be released in whole or part without written approval of SATIMO.*



### 7.3 MEASUREMENT RESULT

The IEEE Std. 1528 and CEI/IEC 62209 standards state that the system validation measurements should produce the SAR values shown below (for phantom thickness of 2 mm), within the uncertainty for the system validation. All SAR values are normalized to 1 W forward power. In bracket, the measured SAR is given with the used input power.

| Frequency<br>MHz | 1 g SAR (W/kg/W) |              | 10 g SAR (W/kg/W) |              |
|------------------|------------------|--------------|-------------------|--------------|
|                  | required         | measured     | required          | measured     |
| 300              | 2.85             |              | 1.94              |              |
| 450              | 4.58             |              | 3.06              |              |
| 750              | 8.49             |              | 5.55              |              |
| 835              | 9.56             |              | 6.22              |              |
| 900              | 10.9             |              | 6.99              |              |
| 1450             | 29               |              | 16                |              |
| 1500             | 30.5             |              | 16.8              |              |
| 1640             | 34.2             |              | 18.4              |              |
| 1750             | 36.4             |              | 19.3              |              |
| 1800             | 38.4             |              | 20.1              |              |
| 1900             | 39.7             | 39.65 (3.96) | 20.5              | 20.24 (2.02) |
| 1950             | 40.5             |              | 20.9              |              |
| 2000             | 41.1             |              | 21.1              |              |
| 2100             | 43.6             |              | 21.9              |              |
| 2300             | 48.7             |              | 23.3              |              |
| 2450             | 52.4             |              | 24                |              |
| 2600             | 55.3             |              | 24.6              |              |
| 3000             | 63.8             |              | 25.7              |              |
| 3500             | 67.1             |              | 25                |              |

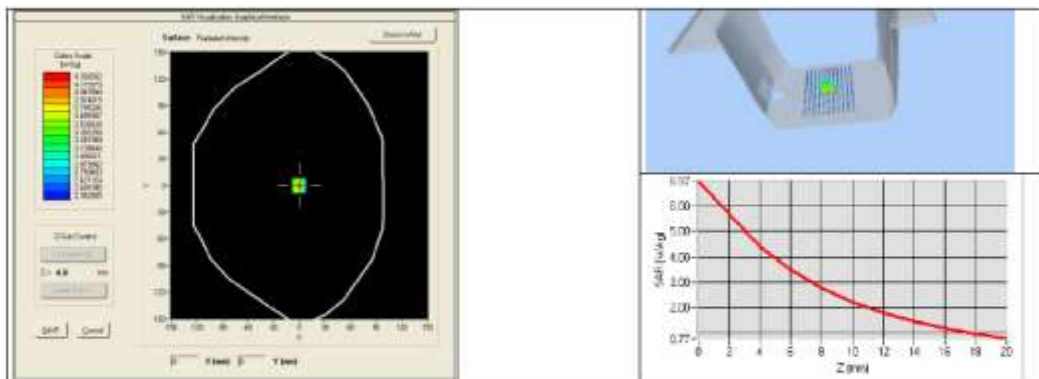



7.4 BODY MEASUREMENT RESULT

|   |  |
|---|--|
| Software                                  | OPENSAR V4   |
| Phantom                                   | SN 20/09 SAM71   |
| Probe                                     | SN 18/11 EPG122  |
| Liquid                                    | Body Liquid Values: $\epsilon_p' : 52.5$ $\sigma : 1.50$ |
| Distance between dipole center and liquid | 10.0 mm  |
| Area scan resolution                      | $dx=8mm/dy=8mm$  |
| Zoon Scan Resolution                      | $dx=8mm/dy=8m/dz=5mm$                                    |
| Frequency                                 | 1900 MHz   |
| Input power                               | 20 dBm   |
| Liquid Temperature                        | 21 °C  |
| Lab Temperature                           | 21 °C  |
| Lab Humidity                              | 45 %   |

| Frequency<br>MHz | 1 g SAR (W/kg/W) | 10 g SAR (W/kg/W) |
|------------------|------------------|-------------------|
|                  | measured         | measured          |
| 1900             | 40.74 (4.07)     | 21.43 (2.14)      |

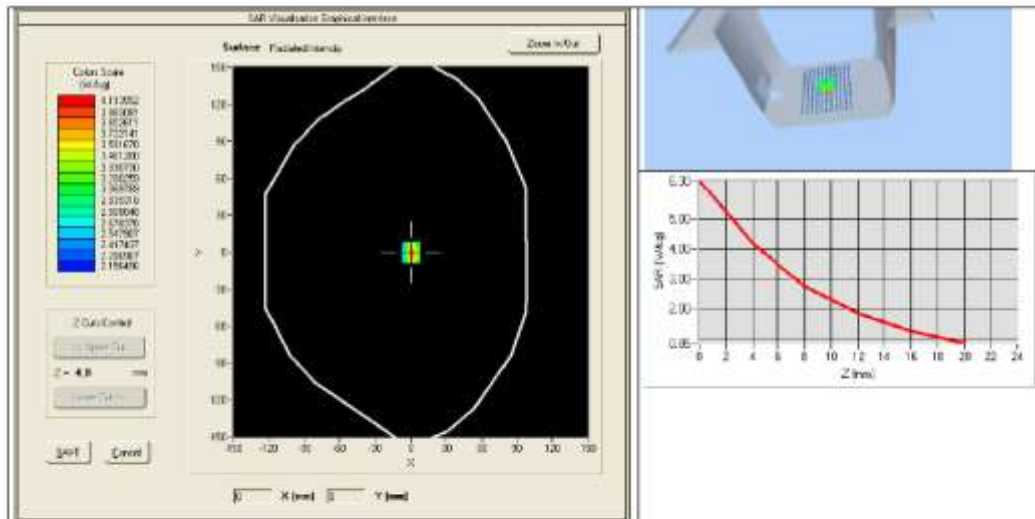



**8 LIST OF EQUIPMENT**

| Equipment Summary Sheet         |                      |                    |   |   |
|---------------------------------|----------------------|--------------------|---|---|
| Equipment Description           | Manufacturer / Model | Identification No. | Current Calibration Date                      | Next Calibration Date                         |
| SAM Phantom                     | Satimo               | SN-20/09-SAM71     | Validated. No cal required.                   | Validated. No cal required.                   |
| COMOSAR Test Bench              | Version 3            | NA                 | Validated. No cal required.                   | Validated. No cal required.                   |
| Network Analyzer                | Rhode & Schwarz ZVA  | SN100132           | 02/2013                                       | 02/2016                                       |
| Calipers                        | Carrera              | CALIPER-01         | 12/2010                                       | 12/2013                                       |
| Reference Probe                 | Satimo               | EPG122 SN 18/11    | Characterized prior to test. No cal required. | Characterized prior to test. No cal required. |
| Multimeter                      | Keithley 2000        | 1188656            | 11/2010                                       | 11/2013                                       |
| Signal Generator                | Agilent E4438C       | MY49070581         | 12/2010                                       | 12/2013                                       |
| Amplifier                       | Aethercomm           | SN 046             | Characterized prior to test. No cal required. | Characterized prior to test. No cal required. |
| Power Meter                     | HP E4418A            | US38261498         | 11/2010                                       | 11/2013                                       |
| Power Sensor                    | HP ECP-E26A          | US37181460         | 11/2010                                       | 11/2013                                       |
| Directional Coupler             | Narda 4216-20        | 01386              | Characterized prior to test. No cal required. | Characterized prior to test. No cal required. |
| Temperature and Humidity Sensor | Control Company      | 11-661-9           | 3/2012  | 3/2014  |



## SAR Reference Dipole Calibration Report

Ref: ACR.318.9.13.SATU.A

### **ATTESTATION OF GLOBAL COMPLIANCE CO. LTD.**

**1&2F, NO.2 BUILDING, HUA FENG NO.1 INDUSTRIAL  
PARK, GUSHU COMMUNITY XIXIANG STREET  
BAOAN DISTRICT, SHENZHEN, P.R. CHINA  
SATIMO COMOSAR REFERENCE DIPOLE  
FREQUENCY: 2450 MHZ  
SERIAL NO.: SN 46/11 DIP 2G450-189**

**Calibrated at SATIMO US  
2105 Barrett Park Dr. - Kennesaw, GA 30144**



**11/14/13**

#### *Summary:*

This document presents the method and results from an accredited SAR reference dipole calibration performed in SATIMO USA using the COMOSAR test bench. All calibration results are traceable to national metrology institutions.



|                      | <i>Name</i>   | <i>Function</i> | <i>Date</i> | <i>Signature</i>     |
|----------------------|---------------|-----------------|-------------|----------------------|
| <i>Prepared by :</i> | Jérôme LUC    | Product Manager | 11/14/2013  | <i>JS</i>            |
| <i>Checked by :</i>  | Jérôme LUC    | Product Manager | 11/14/2013  | <i>JS</i>            |
| <i>Approved by :</i> | Kim RUTKOWSKI | Quality Manager | 11/14/2013  | <i>Kim Rutkowski</i> |

|                       | <i>Customer Name</i>                               |
|-----------------------|--|
| <i>Distribution :</i> | ATTESTATION<br>OF GLOBAL<br>COMPLIANCE<br>CO. LTD. |

| <i>Issue</i> | <i>Date</i> | <i>Modifications</i> |
|--------------|-------------|----------------------|
| A            | 11/14/2013  | Initial release      |
|              |             |                      |
|              |             |                      |



**TABLE OF CONTENTS**

|     |                                      |    |
|-----|--------------------------------------|----|
| 1   | Introduction.....                    | 4  |
| 2   | Device Under Test .....              | 4  |
| 3   | Product Description .....            | 4  |
| 3.1 | General Information .....            | 4  |
| 4   | Measurement Method .....             | 5  |
| 4.1 | Return Loss Requirements .....       | 5  |
| 4.2 | Mechanical Requirements .....        | 5  |
| 5   | Measurement Uncertainty.....         | 5  |
| 5.1 | Return Loss .....                    | 5  |
| 5.2 | Dimension Measurement .....          | 5  |
| 5.3 | Validation Measurement .....         | 5  |
| 6   | Calibration Measurement Results..... | 6  |
| 6.1 | Return Loss and Impedance .....      | 6  |
| 6.2 | Mechanical Dimensions .....          | 6  |
| 7   | Validation measurement .....         | 7  |
| 7.1 | Measurement Condition .....          | 7  |
| 7.2 | Head Liquid Measurement .....        | 7  |
| 7.3 | Measurement Result .....             | 8  |
| 7.4 | Body Measurement Result .....        | 9  |
| 8   | List of Equipment .....              | 10 |





## 1 INTRODUCTION

This document contains a summary of the requirements set forth by the IEEE 1528, OET 65 Bulletin C and CEI/IEC 62209 standards for reference dipoles used for SAR measurement system validations and the measurements that were performed to verify that the product complies with the fore mentioned standards.

## 2 DEVICE UNDER TEST

| Device Under Test              |                                   |
|--------------------------------|-----------------------------------|
| Device Type                    | COMOSAR 2450 MHz REFERENCE DIPOLE |
| Manufacturer                   | Satimo                            |
| Model                          | SID2450                           |
| Serial Number                  | SN 46/11 DIP 2G450-189            |
| Product Condition (new / used) | Used                              |

A yearly calibration interval is recommended.

## 3 PRODUCT DESCRIPTION

### 3.1 GENERAL INFORMATION

Satimo's COMOSAR Validation Dipoles are built in accordance to the IEEE 1528, OET 65 Bulletin C and CEI/IEC 62209 standards. The product is designed for use with the COMOSAR test bench only.



**Figure 1** – Satimo COMOSAR Validation Dipole



#### 4 MEASUREMENT METHOD

The IEEE 1528, OET 65 Bulletin C and CEI/IEC 62209 standards provide requirements for reference dipoles used for system validation measurements. The following measurements were performed to verify that the product complies with the fore mentioned standards.

##### 4.1 RETURN LOSS REQUIREMENTS

The dipole used for SAR system validation measurements and checks must have a return loss of -20 dB or better. The return loss measurement shall be performed against a liquid filled flat phantom, with the phantom constructed as outlined in the fore mentioned standards.

##### 4.2 MECHANICAL REQUIREMENTS

The IEEE Std. 1528 and CEI/IEC 62209 standards specify the mechanical components and dimensions of the validation dipoles, with the dimensions frequency and phantom shell thickness dependent. The COMOSAR test bench employs a 2 mm phantom shell thickness therefore the dipoles sold for use with the COMOSAR test bench comply with the requirements set forth for a 2 mm phantom shell thickness.

#### 5 MEASUREMENT UNCERTAINTY

All uncertainties listed below represent an expanded uncertainty expressed at approximately the 95% confidence level using a coverage factor of  $k=2$ , traceable to the Internationally Accepted Guides to Measurement Uncertainty.

##### 5.1 RETURN LOSS

The following uncertainties apply to the return loss measurement:

| Frequency band | Expanded Uncertainty on Return Loss |
|----------------|-------------------------------------|
| 400-6000MHz    | 0.1 dB                              |

##### 5.2 DIMENSION MEASUREMENT

The following uncertainties apply to the dimension measurements:

| Length (mm) | Expanded Uncertainty on Length |
|-------------|--------------------------------|
| 3 - 300     | 0.05 mm                        |

##### 5.3 VALIDATION MEASUREMENT

The guidelines outlined in the IEEE 1528, OET 65 Bulletin C, CENELEC EN50361 and CEI/IEC 62209 standards were followed to generate the measurement uncertainty for validation measurements.

| Scan Volume | Expanded Uncertainty |
|-------------|----------------------|
| 1 g         | 20.3 %               |
| 10 g        | 20.1 %               |



## 6 CALIBRATION MEASUREMENT RESULTS

### 6.1 RETURN LOSS AND IMPEDANCE

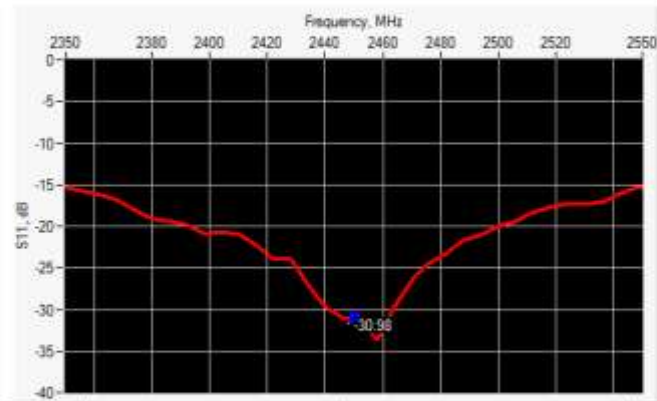

| Frequency (MHz) | Return Loss (dB) | Requirement (dB) | Impedance                   |
|-----------------|------------------|------------------|-----------------------------|
| 2450            | -30.98           | -20              | $47.3 \Omega + 0.1 j\Omega$ |

### 6.2 MECHANICAL DIMENSIONS

| Frequency MHz | L mm        |          | h mm        |          | d mm       |          |
|---------------|-------------|----------|-------------|----------|------------|----------|
|               | required    | measured | required    | measured | required   | measured |
| 300           | 420.0 ± 1 % |          | 250.0 ± 1 % |          | 6.35 ± 1 % |          |
| 450           | 290.0 ± 1 % |          | 166.7 ± 1 % |          | 6.35 ± 1 % |          |
| 750           | 176.0 ± 1 % |          | 100.0 ± 1 % |          | 6.35 ± 1 % |          |
| 835           | 161.0 ± 1 % |          | 89.8 ± 1 %  |          | 3.6 ± 1 %  |          |
| 900           | 149.0 ± 1 % |          | 83.3 ± 1 %  |          | 3.6 ± 1 %  |          |
| 1450          | 89.1 ± 1 %  |          | 51.7 ± 1 %  |          | 3.6 ± 1 %  |          |
| 1500          | 80.5 ± 1 %  |          | 50.0 ± 1 %  |          | 3.6 ± 1 %  |          |
| 1640          | 79.0 ± 1 %  |          | 45.7 ± 1 %  |          | 3.6 ± 1 %  |          |
| 1750          | 75.2 ± 1 %  |          | 42.9 ± 1 %  |          | 3.6 ± 1 %  |          |
| 1800          | 72.0 ± 1 %  |          | 41.7 ± 1 %  |          | 3.6 ± 1 %  |          |
| 1900          | 68.0 ± 1 %  |          | 39.5 ± 1 %  |          | 3.6 ± 1 %  |          |
| 1950          | 66.3 ± 1 %  |          | 38.5 ± 1 %  |          | 3.6 ± 1 %  |          |
| 2000          | 64.5 ± 1 %  |          | 37.5 ± 1 %  |          | 3.6 ± 1 %  |          |
| 2100          | 61.0 ± 1 %  |          | 35.7 ± 1 %  |          | 3.6 ± 1 %  |          |
| 2300          | 55.5 ± 1 %  |          | 32.6 ± 1 %  |          | 3.6 ± 1 %  |          |
| 2450          | 51.5 ± 1 %  | PASS     | 30.4 ± 1 %  | PASS     | 3.6 ± 1 %  | PASS     |
| 2600          | 48.5 ± 1 %  |          | 28.8 ± 1 %  |          | 3.6 ± 1 %  |          |
| 3000          | 41.5 ± 1 %  |          | 25.0 ± 1 %  |          | 3.6 ± 1 %  |          |
| 3500          | 37.0 ± 1 %  |          | 26.4 ± 1 %  |          | 3.6 ± 1 %  |          |
| 3700          | 34.7 ± 1 %  |          | 26.4 ± 1 %  |          | 3.6 ± 1 %  |          |



## 7 VALIDATION MEASUREMENT

The IEEE Std. 1528, OET 65 Bulletin C and CE/IEC 62209 standards state that the system validation measurements must be performed using a reference dipole meeting the fore mentioned return loss and mechanical dimension requirements. The validation measurement must be performed against a liquid filled flat phantom, with the phantom constructed as outlined in the fore mentioned standards. Per the standards, the dipole shall be positioned below the bottom of the phantom, with the dipole length centered and parallel to the longest dimension of the flat phantom, with the top surface of the dipole at the described distance from the bottom surface of the phantom.

### 7.1 MEASUREMENT CONDITION

|   |  |
|---|--|
| Software                                  | OPENSAR V4   |
| Phantom                                   | SN 20/09 SAM71   |
| Probe                                     | SN 18/11 EPG122  |
| Liquid                                    | Head Liquid Values: $\epsilon_r' = 38.6$ $\sigma = 1.82$ |
| Distance between dipole center and liquid | 10.0 mm  |
| Area scan resolution                      | $dx=8mm/dy=8mm$  |
| Zoon Scan Resolution                      | $dx=8mm/dy=8m/dz=5mm$                                    |
| Frequency                                 | 2450 MHz   |
| Input power                               | 20 dBm   |
| Liquid Temperature                        | 21 °C  |
| Lab Temperature                           | 21 °C  |
| Lab Humidity                              | 45 %   |

### 7.2 HEAD LIQUID MEASUREMENT

| Frequency<br>MHz | Relative permittivity ( $\epsilon_r'$ ) |          | Conductivity ( $\sigma$ ) S/m |          |
|------------------|---|----------|-------------------------------|----------|
|                  | required                                | measured | required                      | measured |
| 300              | 45.3 ±5 %                               |          | 0.87 ±5 %                     |          |
| 450              | 43.5 ±5 %                               |          | 0.87 ±5 %                     |          |
| 750              | 41.9 ±5 %                               |          | 0.89 ±5 %                     |          |
| 825              | 41.5 ±5 %                               |          | 0.90 ±5 %                     |          |
| 900              | 41.5 ±5 %                               |          | 0.97 ±5 %                     |          |
| 1450             | 40.5 ±5 %                               |          | 1.20 ±5 %                     |          |
| 1500             | 40.4 ±5 %                               |          | 1.23 ±5 %                     |          |
| 1640             | 40.2 ±5 %                               |          | 1.31 ±5 %                     |          |
| 1750             | 40.1 ±5 %                               |          | 1.37 ±5 %                     |          |
| 1800             | 40.0 ±5 %                               |          | 1.40 ±5 %                     |          |
| 1900             | 40.0 ±5 %                               |          | 1.40 ±5 %                     |          |
| 1950             | 40.0 ±5 %                               |          | 1.40 ±5 %                     |          |
| 2000             | 40.0 ±5 %                               |          | 1.40 ±5 %                     |          |
| 2100             | 39.8 ±5 %                               |          | 1.49 ±5 %                     |          |
| 2300             | 39.5 ±5 %                               |          | 1.67 ±5 %                     |          |
| 2450             | 39.2 ±5 %                               | PASS     | 1.80 ±5 %                     | PASS     |
| 2600             | 39.0 ±5 %                               |          | 1.96 ±5 %                     |          |
| 3000             | 38.5 ±5 %                               |          | 2.40 ±5 %                     |          |
| 3500             | 37.9 ±5 %                               |          | 2.91 ±5 %                     |          |

Page: 7/10

*This document shall not be reproduced, except in full or in part, without the written approval of SATIMO.  
The information contained herein is to be used only for the purpose for which it is submitted and is not to be released in whole or part without written approval of SATIMO.*



7.3 MEASUREMENT RESULT

The IEEE Std. 1528 and CEI/IEC 62209 standards state that the system validation measurements should produce the SAR values shown below (for phantom thickness of 2 mm), within the uncertainty for the system validation. All SAR values are normalized to 1 W forward power. In bracket, the measured SAR is given with the used input power.

| Frequency<br>MHz | 1 g SAR (W/kg/W) |              | 10 g SAR (W/kg/W) |              |
|------------------|------------------|--------------|-------------------|--------------|
|                  | required         | measured     | required          | measured     |
| 300              | 2.85             |              | 1.94              |              |
| 450              | 4.50             |              | 3.06              |              |
| 750              | 8.49             |              | 5.55              |              |
| 835              | 9.56             |              | 6.22              |              |
| 900              | 10.9             |              | 6.99              |              |
| 1450             | 29               |              | 16                |              |
| 1500             | 30.5             |              | 16.8              |              |
| 1640             | 34.2             |              | 18.4              |              |
| 1750             | 36.4             |              | 19.3              |              |
| 1800             | 38.4             |              | 20.1              |              |
| 1900             | 39.7             |              | 20.5              |              |
| 1950             | 40.5             |              | 20.9              |              |
| 2000             | 41.1             |              | 21.1              |              |
| 2100             | 43.6             |              | 21.9              |              |
| 2300             | 48.7             |              | 23.3              |              |
| 2450             | 52.4             | 54.40 (5.44) | 24                | 23.75 (2.38) |
| 2600             | 55.3             |              | 24.6              |              |
| 3000             | 63.8             |              | 25.7              |              |
| 3500             | 67.1             |              | 25                |              |

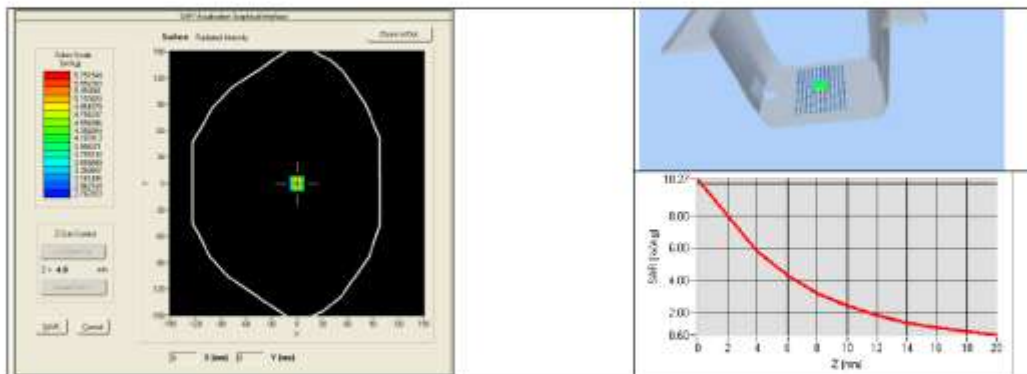



7.4 BODY MEASUREMENT RESULT

|   |  |
|---|--|
| Software                                  | OPENSAR V4   |
| Phantom                                   | SN 20/09 SAM71   |
| Probe                                     | SN 18/11 EPG122  |
| Liquid                                    | Body Liquid Values: $\epsilon_p' : 52.0$ $\sigma : 1.94$ |
| Distance between dipole center and liquid | 10.0 mm  |
| Area scan resolution                      | $dx=8mm/dy=8mm$  |
| Zoon Scan Resolution                      | $dx=8mm/dy=8m/dz=5mm$                                    |
| Frequency                                 | 2450 MHz   |
| Input power                               | 20 dBm   |
| Liquid Temperature                        | 21 °C  |
| Lab Temperature                           | 21 °C  |
| Lab Humidity                              | 45 %   |

| Frequency<br>MHz | 1 g SAR (W/kg/W) | 10 g SAR (W/kg/W) |
|------------------|------------------|-------------------|
|                  | measured         | measured          |
| 2450             | 54.19 (5.42)     | 24.96 (2.50)      |

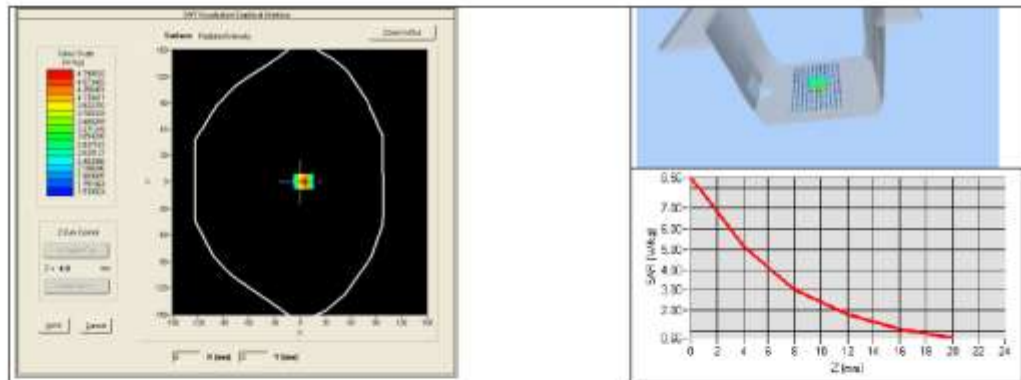



8 LIST OF EQUIPMENT

| Equipment Summary Sheet         |                      |                    |   |   |
|---------------------------------|----------------------|--------------------|---|---|
| Equipment Description           | Manufacturer / Model | Identification No. | Current Calibration Date                      | Next Calibration Date                         |
| SAM Phantom                     | Satimo               | SN-20/09-SAM71     | Validated. No cal required.                   | Validated. No cal required.                   |
| COMOSAR Test Bench              | Version 3            | NA                 | Validated. No cal required.                   | Validated. No cal required.                   |
| Network Analyzer                | Rhode & Schwarz ZVA  | SN100132           | 02/2013                                       | 02/2016                                       |
| Calipers                        | Carrera              | CALIPER-01         | 12/2010                                       | 12/2013                                       |
| Reference Probe                 | Satimo               | EPG122 SN 18/11    | Characterized prior to test. No cal required. | Characterized prior to test. No cal required. |
| Multimeter                      | Keithley 2000        | 1188656            | 11/2010                                       | 11/2013                                       |
| Signal Generator                | Agilent E4438C       | MY49070581         | 12/2010                                       | 12/2013                                       |
| Amplifier                       | Aethercomm           | SN 046             | Characterized prior to test. No cal required. | Characterized prior to test. No cal required. |
| Power Meter                     | HP E4418A            | US38261498         | 11/2010                                       | 11/2013                                       |
| Power Sensor                    | HP ECP-E26A          | US37181460         | 11/2010                                       | 11/2013                                       |
| Directional Coupler             | Narda 4216-20        | 01386              | Characterized prior to test. No cal required. | Characterized prior to test. No cal required. |
| Temperature and Humidity Sensor | Control Company      | 11-661-9           | 3/2012  | 3/2014  |