



FCC Test Report

Report No.: AGC00529130602FE03

FCC ID : Y7WPLUMX200
APPLICATION PURPOSE : Original Equipment
PRODUCT DESIGNATION : Glow Mobile Phone
BRAND NAME : plum
MODEL NAME : X200
CLIENT : CLC Hong Kong Limited
DATE OF ISSUE : July 03,2013
STANDARD(S) : FCC Part 15 Rules
REPORT VERSION : V1.0

Attestation of Global Compliance (Shenzhen) Co., Ltd



CAUTION:

This report shall not be reproduced except in full without the written permission of the test laboratory and shall not be quoted out of context.

Report Revise Record

Report Version	Revise Time	Issued Date	Valid Version	Notes
V1.0	/	July 03,2013	Valid	Original Report

TABLE OF CONTENTS

1. VERIFICATION OF CONFORMITY	5
2. GENERAL INFORMATION	6
2.1. PRODUCT DESCRIPTION.....	6
2.2. TABLE OF CARRIER FREQUENCIES.....	6
2.3. RECEIVER INPUT BANDWIDTH	7
2.4. EXAMPLE OF A HOPPING SEQUENCY IN DATA MODE	7
2.5. EQUALLY AVERAGE USE OF FREQUENCIES AND BEHAVIOUR	7
2.6. RELATED SUBMITTAL(S) / GRANT (S).....	8
2.7. TEST METHODOLOGY.....	8
2.8. SPECIAL ACCESSORIES	8
2.9. EQUIPMENT MODIFICATIONS	8
3. MEASUREMENT UNCERTAINTY.....	9
4. DESCRIPTION OF TEST MODES.....	9
5. SYSTEM TEST CONFIGURATION	10
5.1. CONFIGURATION OF EUT SYSTEM	10
5.2. EQUIPMENT USED IN EUT SYSTEM	10
5.3. SUMMARY OF TEST RESULTS	10
6. TEST FACILITY	11
7. PEAK OUTPUT POWER	12
7.1. MEASUREMENT PROCEDURE	12
7.2. TEST SET-UP (BLOCK DIAGRAM OF CONFIGURATION).....	12
7.3. LIMITS AND MEASUREMENT RESULT	13
8. 20DB BANDWIDTH.....	14
8.1. MEASUREMENT PROCEDURE	14
8.2. TEST SET-UP (BLOCK DIAGRAM OF CONFIGURATION).....	14
8.3. LIMITS AND MEASUREMENT RESULTS.....	14
9. CONDUCTED SPURIOUS EMISSION	21
9.1. MEASUREMENT PROCEDURE	21
9.2. TEST SET-UP (BLOCK DIAGRAM OF CONFIGURATION).....	21
9.3. MEASUREMENT EQUIPMENT USED.....	21
9.4. LIMITS AND MEASUREMENT RESULT	21
10. RADIATED EMISSION	25
10.1. MEASUREMENT PROCEDURE	25
10.2. TEST SETUP.....	27

10.3. TEST RESULT	28
11. BAND EDGE EMISSION	32
11.1. MEASUREMENT PROCEDURE	32
11.2. TEST SET-UP	32
11.3. TEST RESULT	33
12. NUMBER OF HOPPING FREQUENCY.....	37
12.1. MEASUREMENT PROCEDURE	37
12.2. TEST SETUP (BLOCK DIAGRAM OF CONFIGURATION).....	37
12.3. MEASUREMENT EQUIPMENT USED.....	37
12.4. LIMITS AND MEASUREMENT RESULT	37
13. TIME OF OCCUPANCY (DWELL TIME).....	38
13.1. MEASUREMENT PROCEDURE	38
13.2. TEST SETUP (BLOCK DIAGRAM OF CONFIGURATION).....	38
13.3. MEASUREMENT EQUIPMENT USED.....	38
13.4. LIMITS AND MEASUREMENT RESULT	38
14. FREQUENCY SEPARATION	41
14.1. MEASUREMENT PROCEDURE	41
14.2. TEST SETUP (BLOCK DIAGRAM OF CONFIGURATION).....	41
14.3. MEASUREMENT EQUIPMENT USED.....	41
14.4. LIMITS AND MEASUREMENT RESULT	41
15. FCC LINE CONDUCTED EMISSION TEST	42
15.1. LIMITS OF LINE CONDUCTED EMISSION TEST.....	42
15.2. BLOCK DIAGRAM OF LINE CONDUCTED EMISSION TEST	42
15.3. PRELIMINARY PROCEDURE OF LINE CONDUCTED EMISSION TEST	43
15.4. FINAL PROCEDURE OF LINE CONDUCTED EMISSION TEST	43
15.5. TEST RESULT OF LINE CONDUCTED EMISSION TEST	44
APPENDIX A: PHOTOGRAPHS OF TEST SETUP	46
APPENDIX B: PHOTOGRAPHS OF EUT	47

1. VERIFICATION OF CONFORMITY

Applicant	CLC Hong Kong Limited
Address	2209, Concordia Plaza, North Tower, No.1 Science Museum Road, Tsim Sha Tsui East, Kowloon, Hong Kong
Manufacturer	CLC Technology Co., Ltd.
Address	Room 6G, Block C, NEO Building, Chegongmiao, Futian District, Shenzhen, P.R.China
Product Designation	Glow Mobile Phone
Brand Name	plum
Test Model	X200
Date of test	June 24, 2013 to July 01, 2013
Deviation	None
Condition of Test Sample	Normal
Report Template	AGCRT-US-BR/RF (2013-03-01)

We hereby certify that:

The above equipment was tested by Attestation of Global Compliance (Shenzhen) Co., Ltd. The test data, data evaluation, test procedures, and equipment configurations shown in this report were made in accordance with the procedures given in ANSI C63.4 (2003) and the energy emitted by the sample EUT tested as described in this report is in compliance with radiated emission limits of FCC Rules Part 15.247.

Prepared By

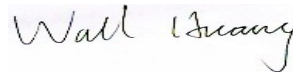

Wall Huang July 03,2013

Checked By



Forrest Lei July 03,2013

Authorized By



Solger Zhang July 03,2013

2. GENERAL INFORMATION

2.1. PRODUCT DESCRIPTION

The EUT is “Glow Mobile Phone” designed as a “Communication Device”. It is designed by way of utilizing the FHSS technology to achieve the system operation.

A major technical description of EUT is described as following

Operation Frequency	2.402 GHz to 2.480GHz
RF Output Power	4.23dBm(Max)
Bluetooth Version	V 2.1+ EDR
Modulation	GFSK, π /4-DQPSK, 8DPSK
Number of channels	79
Hardware Version	C913_V1.02_PCB
Software Version	N/A
Antenna Designation	Integrated Antenna
Antenna Gain	1.0dBi
Power Supply	DC3.7V by Battery

2.2. TABLE OF CARRIER FREQUENCIES

Frequency Band	Channel Number	Frequency
2400~2483.5MHZ	0	2402MHZ
	1	2403MHZ
	:	:
	38	2440 MHZ
	39	2441 MHZ
	40	2442 MHZ
	:	:
	77	2479 MHZ
	78	2480 MHZ

2.3. RECEIVER INPUT BANDWIDTH

The input bandwidth of the receiver is 1.3MHz. In every connection one Bluetooth device is the master and the other one is slave. The master determines the hopping sequence. The slave follows this sequence. Both devices shift between RX and TX time slot according to the clock of the master. Additionally the type of connection (e.g. single or multislotted packet) is set up at the beginning of the connection. The master adapts its hopping frequency and its TX/RX timing according to the packet type of the connection. Also the slave of the connection will use these settings.

Repeating of a packet has no influence on the hopping sequence. The hopping sequence generated by the master of the connection will be followed in any case. That means, a repeated packet will not be sent on the same frequency, it is sent on the next frequency of the hopping sequence.

2.4. EXAMPLE OF A HOPPING SEQUENCE IN DATA MODE

Example of a 79 hopping sequence in data mode:

40,21,44,23,42,53,46,55,48,33,52,35,50,65,54,67
 56,37,60,39,58,69,62,71,64,25,68,27,66,57,70,59
 72,29,76,31,74,61,78,63,01,41,05,43,03,73,07,75
 09,45,13,47,11,77,15,00,64,49,66,53,68,02,70,06
 01, 51, 03, 55, 05, 04

2.5. EQUALLY AVERAGE USE OF FREQUENCIES AND BEHAVIOUR

The generation of the hopping sequence in connection mode depends essentially on two input values:

1. LAP/UAP of the master of the connection.
2. Internal master clock

The LAP (lower address part) are the 24 LSB's of the 48 BD_ADDRESS. The BD_ADDRESS is an unambiguous number of every Bluetooth unit. The UAP (upper address part) are the 24 MSB's of the 48 BD_ADDRESS.

The internal clock of a Bluetooth unit is derived from a free running clock which is never adjusted and is never turned off. For synchronization with other units only offsets are used. It has no relation to the time of the day. Its resolution is at least half the RX/TX slot length of 312.5µs. The clock has a cycle of about one day (23h30). In most cases it is implemented as a 28-bit counter. For the deriving of the hopping sequence the entire LAP (24 bits), 4 LSB's (4 bits) (Input 1) and the 27 MSB's of the clock (Input 2) are used. With these input values different mathematical procedures (permutations, additions, XOR-operations) are performed to generate the sequence. This will be done at the beginning of every new transmission.

Regarding short transmissions the Bluetooth system has the following behavior:

The first connection between the two devices is established, a hopping sequence was generated. For transmitting the wanted data the complete hopping sequence was not used. The connection ended.

The second connection will be established. A new hopping sequence is generated. Due to the fact the Bluetooth clock has a different value, because the period between the two transmissions is longer (and it cannot be shorter) than the minimum resolution of the clock (312.5µs). The hopping sequence will always differ from the first one.

2.6. RELATED SUBMITTAL(S) / GRANT (S)

This submittal(s) (test report) is intended for **FCC ID: Y7WPLUMX200** filing to comply with Section 15.247 of the FCC Part 15, Subpart C Rules.

2.7. TEST METHODOLOGY

Both conducted and radiated testing was performed according to the procedures in ANSI C63.4 (2003).

Radiated testing was performed at an antenna to EUT distance 3 meters.

2.8. SPECIAL ACCESSORIES

Refer to section 5.2.

2.9. EQUIPMENT MODIFICATIONS

Not available for this EUT intended for grant.

3. MEASUREMENT UNCERTAINTY

Conducted measurement: +/- 2.75dB

Radiated measurement: +/- 3.2dB

4. DESCRIPTION OF TEST MODES

NO.	TEST MODE DESCRIPTION
1	Low channel TX
2	Middle channel TX
3	High channel TX
4	Normal Hopping

Note:

1. All the test modes can be supply by battery and adapter, only the result of the worst case was recorded in the report, if no other cases.

2. For Radiated Emission, 3axis were chosen for testing for each applicable mode.

5. SYSTEM TEST CONFIGURATION

5.1. CONFIGURATION OF EUT SYSTEM

Configuration:

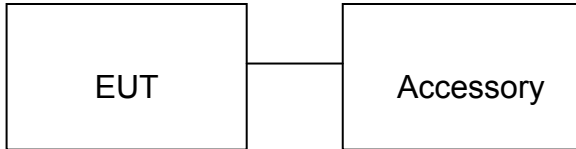

5.2. EQUIPMENT USED IN EUT SYSTEM

Item	Equipment	Model No.	ID or Specification	Remark
1	Glow Mobile Phone	X200	FCC ID: Y7WPLUMX200	EUT
2	Adapter	PMC03	DC5.0V /500mA	Accessory
3	Battery	PMB34	DC3.7V/ 1400 mAh	Accessory
4	Earphone	N/A	N/A	Accessory
5	USB Cable	X200	N/A	Accessory

5.3. SUMMARY OF TEST RESULTS

FCC RULES	DESCRIPTION OF TEST	RESULT
§15.247	Peak Output Power	Compliant
§15.247	20 dB Bandwidth	Compliant
§15.247	Spurious Emission	Compliant
§15.209	Radiated Emission	Compliant
§15.247	Band Edges	Compliant
§15.207	Conduction Emission	Compliant
§15.247	Number of Hopping Frequency	Compliant
§15.247	Time of Occupancy	Compliant
§15.247	Frequency Separation	Compliant

6. TEST FACILITY

Site	Attestation of Global Compliance (Shenzhen) Co., Ltd
Location	2/F., Building 2, No.1-No.4, Chaxi Sanwei Technical Industrial Park, Gushu, Xixiang, Bao'an District, Shenzhen, Guangdong, China
Description	The test site is constructed and calibrated to meet the FCC requirements in documents ANSI C63.4:2003.

ALL TEST EQUIPMENT LIST

Description	Manufacturer	Model	S/N	Cal. Date	Cal. Due
Power Probe	R&S	NRP-Z23	100323	07/18/2012	07/17/2013
RF attenuator	N/A	RFA20db	68	N/A	N/A
Spectrum Analyzer	Agilent	E4440A	US41421290	07/18/2012	07/17/2013
Amplifier	EM	EM30180	0607030	02/28/2013	02/27/2014
Horn Antenna	EM	EM-AH-10180	67	04/21/2013	04/20/2014
Horn Antenna	A.H. Systems Inc.	SAS-574	--	06/08/2013	06/07/2014
EMI Test Receiver	Rohde & Schwarz	ESCI	100694	07/18/2012	07/17/2013
Biological Antenna	A.H. Systems Inc.	SAS-521-4	26	06/08/2013	06/07/2014
Loop Antenna	Daze	ZN30900N	SEL0097	07/18/2012	07/17/2013
Isolation Transformer	LETEAC	LTBK	--	07/18/2012	07/17/2013

7. PEAK OUTPUT POWER

7.1. MEASUREMENT PROCEDURE

For peak power test:

1. The EUT was placed on a turn table which is 0.8m above ground plane.
2. Connect EUT RF output port to the Spectrum Analyzer through an RF attenuator
3. Set the EUT Work on the top, middle and the bottom operation frequency individually.
4. Set the RBW greater than 6DB bandwidth of emission.
5. Record the maximum power from the Spectrum Analyzer.

For average power test:

1. The EUT was placed on a table which is 0.8m above ground plane.
2. Connect EUT RF output port to power probe through an RF attenuator.
3. Connect the power probe to the PC.
4. Set the EUT Work on the top, the middle and the bottom operation frequency individually.
5. Record the maximum power from the software.
6. The maximum peak power shall be less 1 Watt (30dBm).

Note : The EUT was tested according to KDB 558074 for compliance to FCC 47CFR 15.247 requirements.

7.2. TEST SET-UP (BLOCK DIAGRAM OF CONFIGURATION)

PEAK POWER TEST SETUP

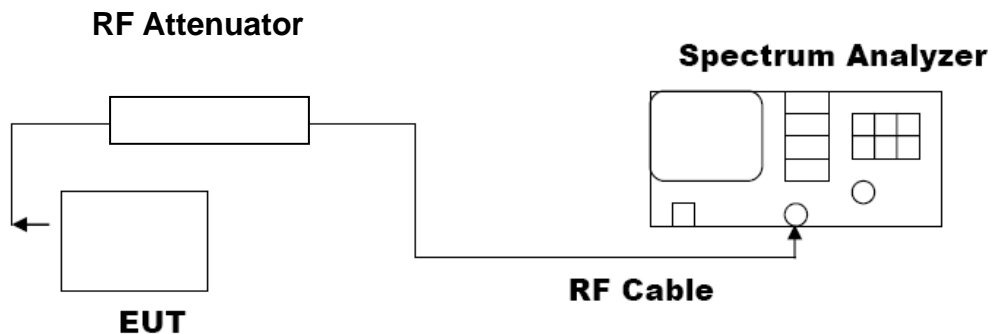

AVERAGE POWER SETUP

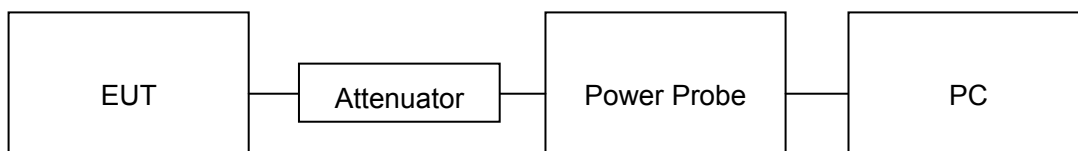

7.3. LIMITS AND MEASUREMENT RESULT

PEAK OUTPUT POWER MEASUREMENT RESULT FOR GFSK MODULATION				
Frequency (GHz)	Average Power (dBm)	Peak Power (dBm)	Applicable Limits (dBm)	Pass or Fail
2.402	2.27	4.23	30	Pass
2.441	2.19	4.15	30	Pass
2.480	2.11	4.06	30	Pass

PEAK OUTPUT POWER MEASUREMENT RESULT FOR $\pi/4$-DQPSK MODULATION				
Frequency (GHz)	Average Power (dBm)	Peak Power (dBm)	Applicable Limits (dBm)	Pass or Fail
2.402	1.88	3.85	30	Pass
2.441	1.79	3.74	30	Pass
2.480	1.71	3.66	30	Pass

PEAK OUTPUT POWER MEASUREMENT RESULT FOR 8-DPSK MODULATION				
Frequency (GHz)	Average Power (dBm)	Peak Power (dBm)	Applicable Limits (dBm)	Pass or Fail
2.402	1.17	3.12	30	Pass
2.441	1.13	3.08	30	Pass
2.480	1.06	3.02	30	Pass

8. 20DB BANDWIDTH

8.1. MEASUREMENT PROCEDURE

1. The EUT was placed on a turn table which is 0.8m above ground plane.
2. Connect EUT RF output port to the Spectrum Analyzer through an RF attenuator
3. Set the EUT Work on the top, the middle and the bottom operation frequency individually.
4. Set Span = approximately 2 to 3 times the 20 dB bandwidth, centered on a hopping channel
RBW \geq 1% of the 20 dB bandwidth, VBW \geq RBW; Sweep = auto; Detector function = peak
5. Set SPA Trace 1 Max hold, then View.

8.2. TEST SET-UP (BLOCK DIAGRAM OF CONFIGURATION)

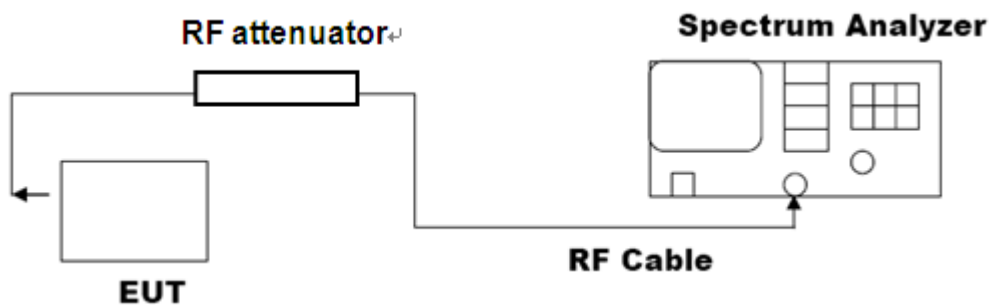

8.3. LIMITS AND MEASUREMENT RESULTS

BLUETOOTH 1MBPS LIMITS AND MEASUREMENT RESULT			
Applicable Limits	Measurement Result		
	Test Data (MHz)		Criteria
N/A	Low Channel	0.743	PASS
	Middle Channel	0.743	PASS
	High Channel	0.732	PASS

TEST PLOT OF BANDWIDTH FOR LOW CHANNEL

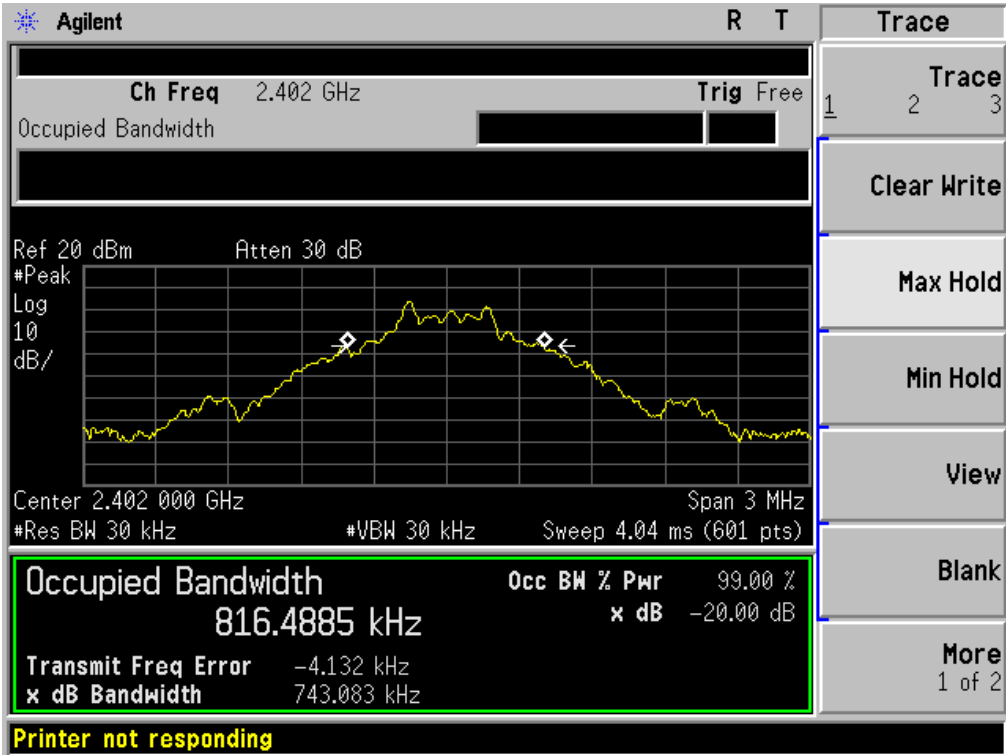

TEST PLOT OF BANDWIDTH FOR MIDDLE CHANNEL

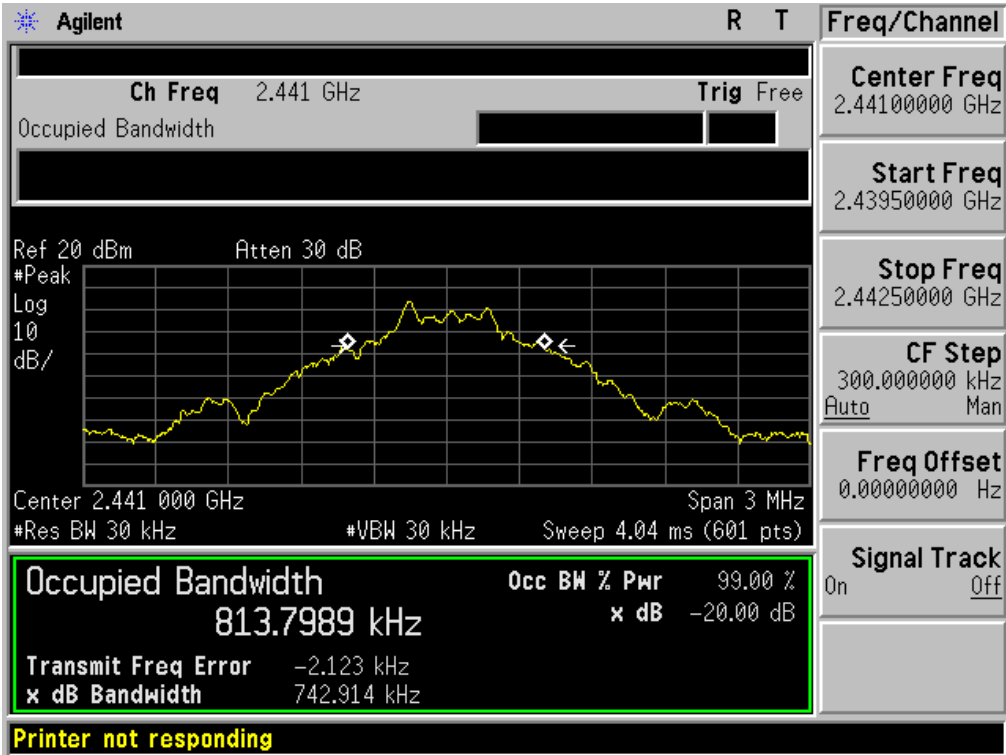

TEST PLOT OF BANDWIDTH FOR HIGH CHANNEL

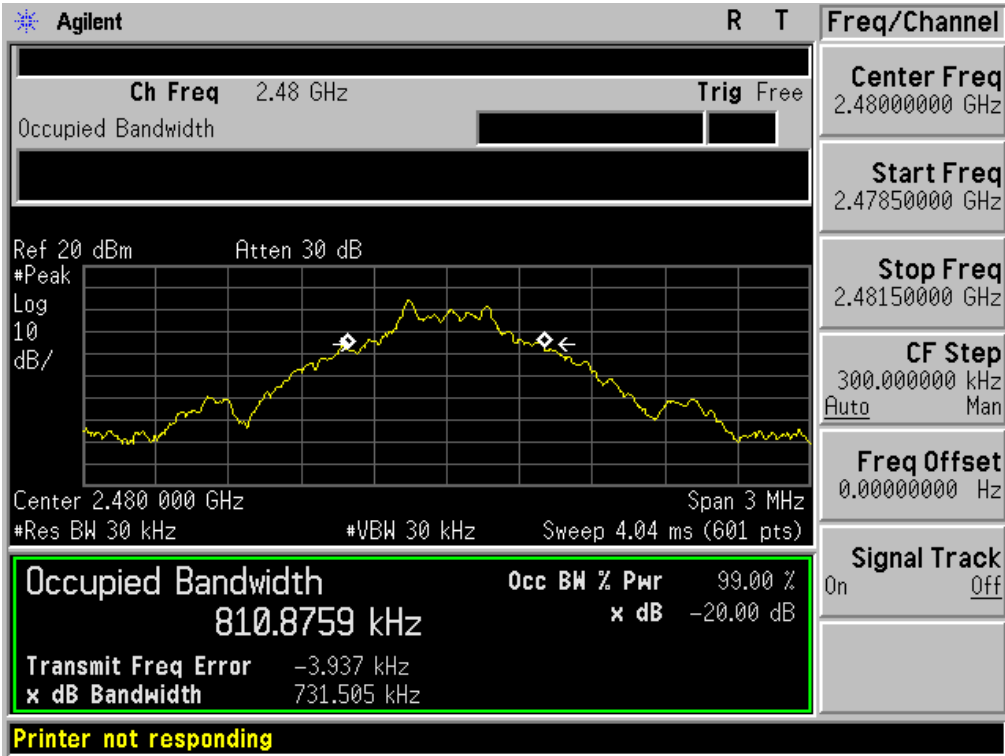

BLUETOOTH 2MBPS LIMITS AND MEASUREMENT RESULT			
Applicable Limits	Measurement Result		
	Test Data (MHz)		Criteria
N/A	Low Channel	1.116	PASS
	Middle Channel	1.116	PASS
	High Channel	1.116	PASS

TEST PLOT OF BANDWIDTH FOR LOW CHANNEL

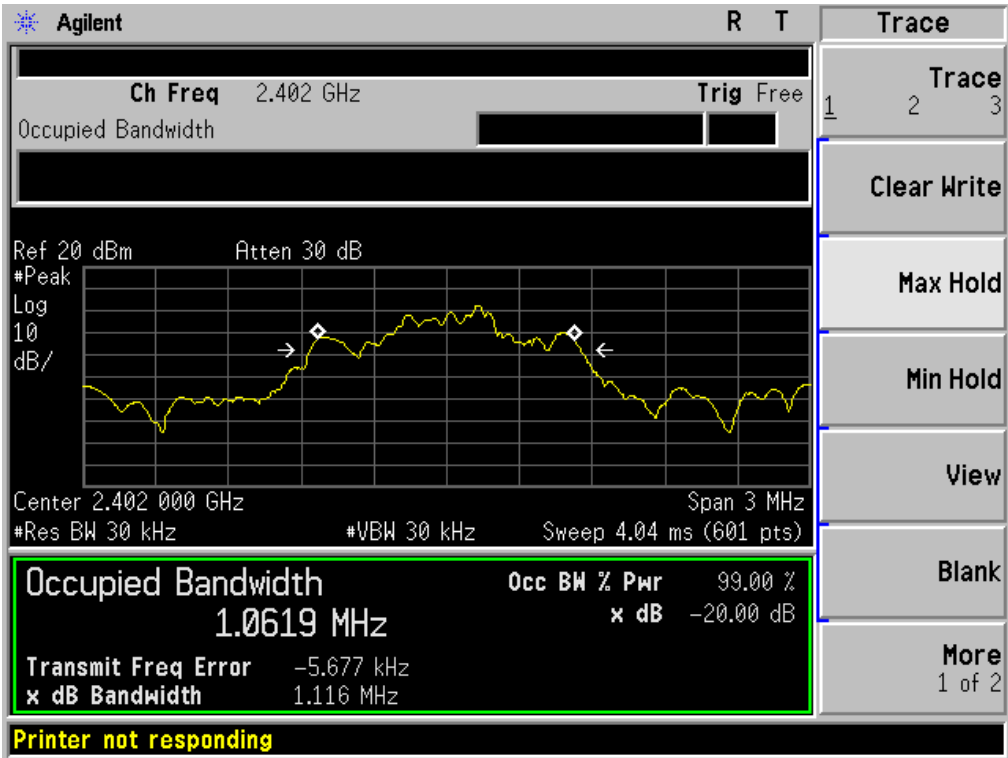

TEST PLOT OF BANDWIDTH FOR MIDDLE CHANNEL

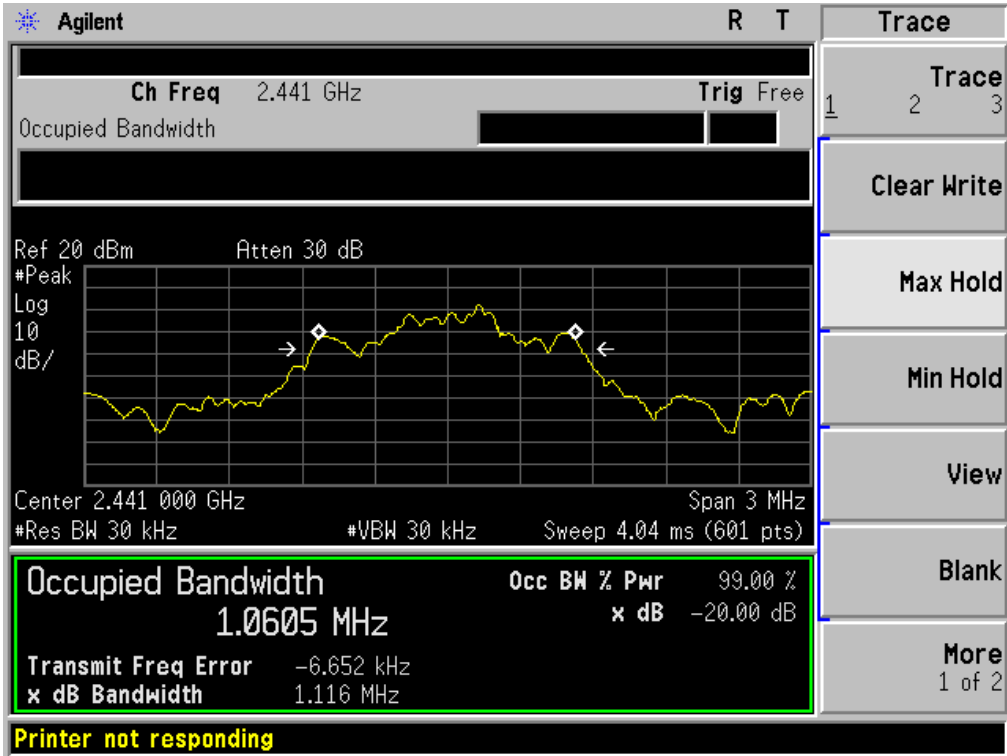

TEST PLOT OF BANDWIDTH FOR HIGH CHANNEL

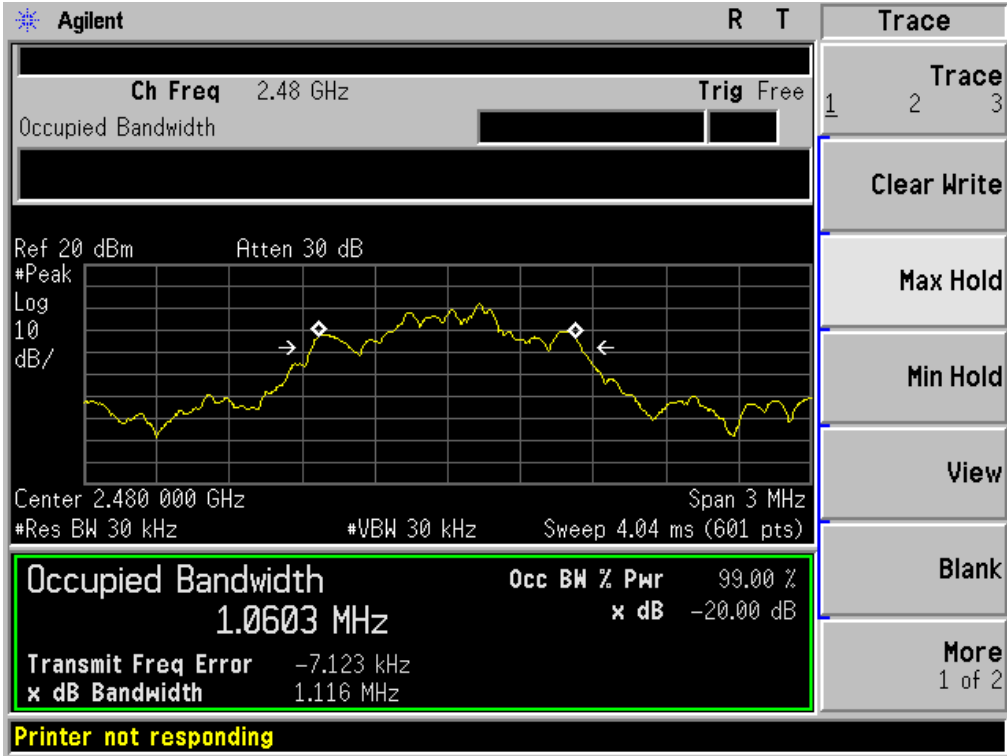

BLUETOOTH 3MBPS LIMITS AND MEASUREMENT RESULT			
Applicable Limits	Measurement Result		
	Test Data (MHz)		Criteria
N/A	Low Channel	1.144	PASS
	Middle Channel	1.149	PASS
	High Channel	1.153	PASS

TEST PLOT OF BANDWIDTH FOR LOW CHANNEL

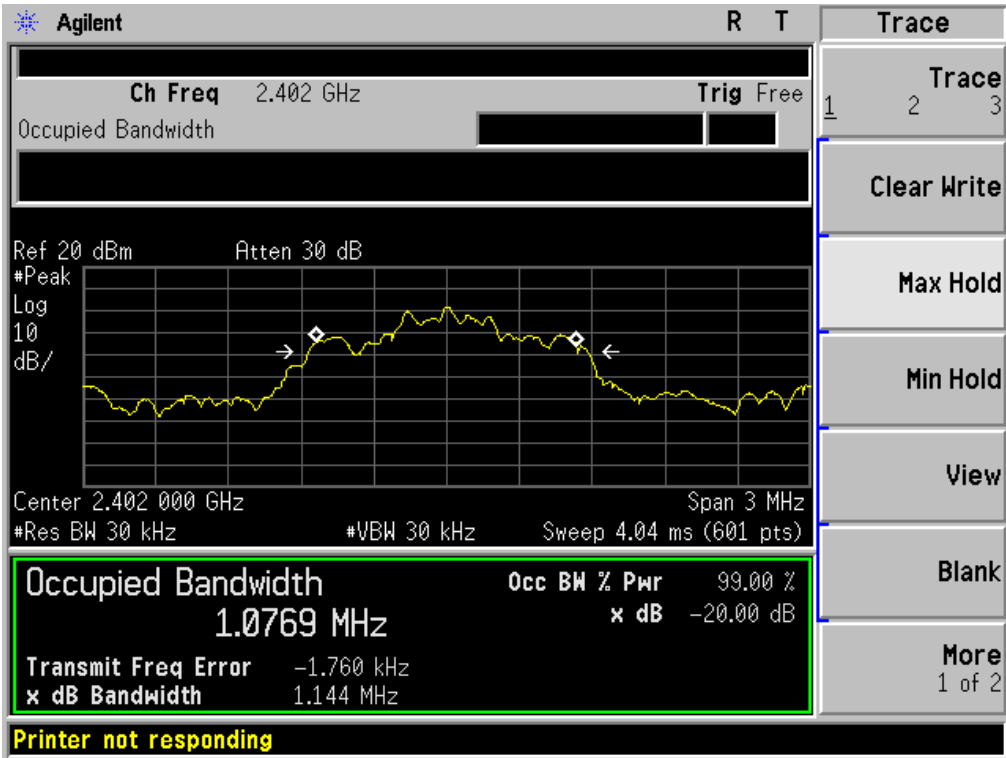

TEST PLOT OF BANDWIDTH FOR MIDDLE CHANNEL

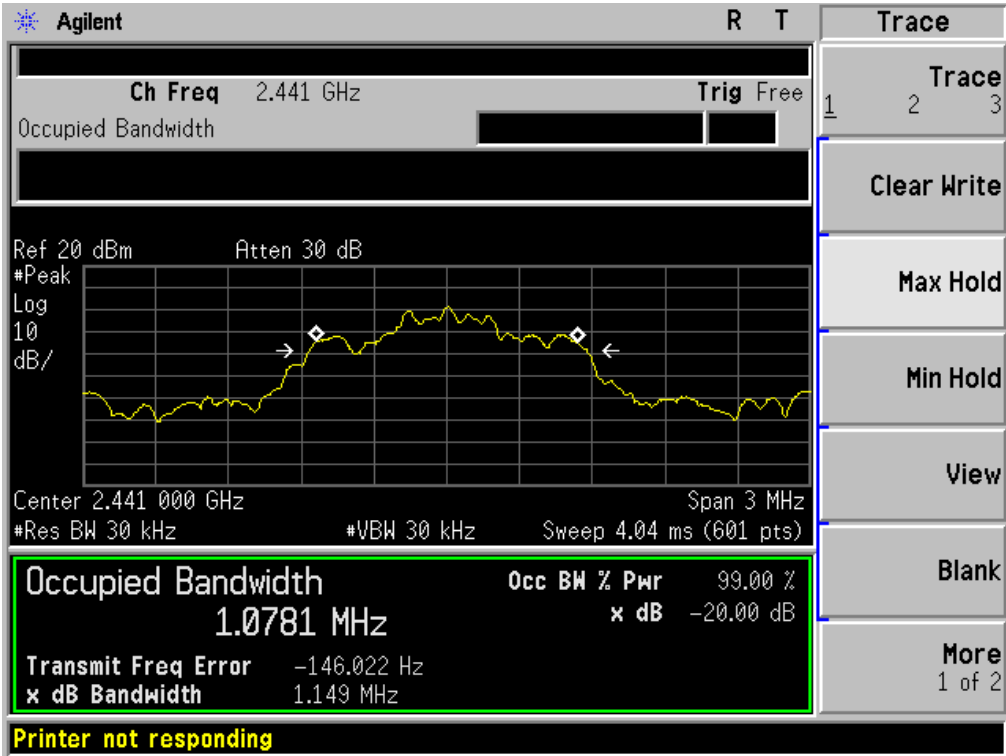

TEST PLOT OF BANDWIDTH FOR HIGH CHANNEL

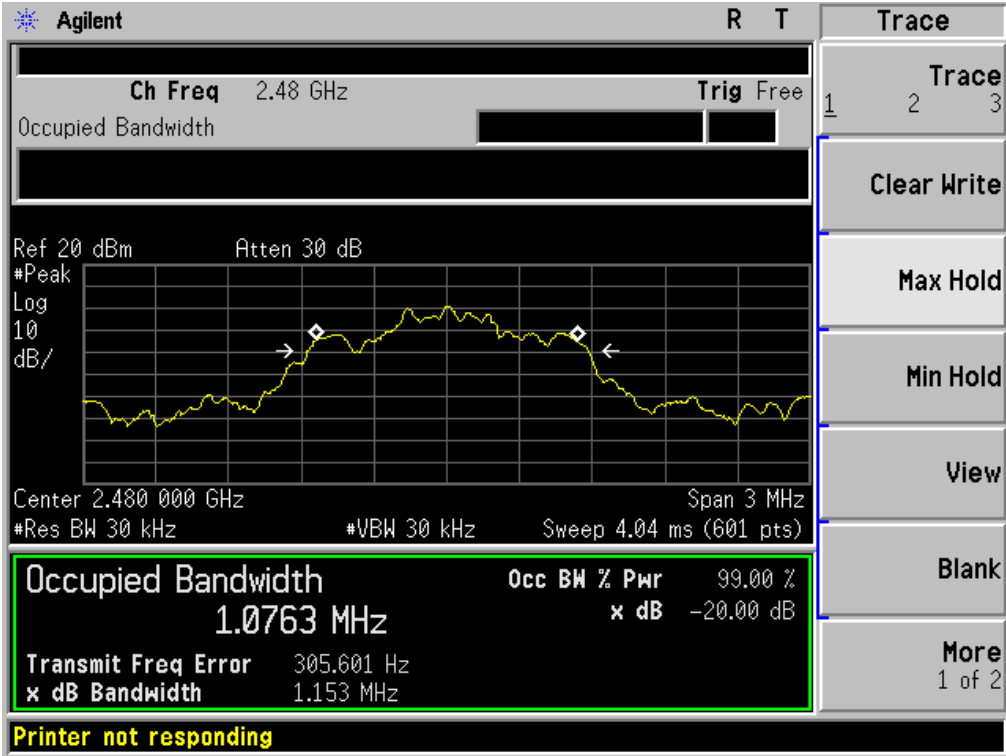

9. CONDUCTED SPURIOUS EMISSION

9.1. MEASUREMENT PROCEDURE

1. The EUT was placed on a turn table which is 0.8m above ground plane.
2. Connect EUT RF output port to the Spectrum Analyzer through an RF attenuator
3. Set the EUT Work on the top, the Middle and the bottom operation frequency individually.
4. Set the Span = wide enough to capture the peak level of the in-band emission and all spurious emissions from the lowest frequency generated in the EUT up through the 10th harmonic.
RBW = 100 kHz; VBW \geq RBW; Sweep = auto; Detector function = peak.
5. Set SPA Trace 1 Max hold, then View.

9.2. TEST SET-UP (BLOCK DIAGRAM OF CONFIGURATION)

The same as described in section 8.2

9.3. MEASUREMENT EQUIPMENT USED

The same as described in section 6

9.4. LIMITS AND MEASUREMENT RESULT

LIMITS AND MEASUREMENT RESULT		
Applicable Limits	Measurement Result	
	Test Data	Criteria
In any 100 KHz Bandwidth Outside the frequency band in which the spread spectrum intentional radiator is operating, the radio frequency power that is produce by the intentional radiator shall be at least 20 dB below that in 100KHz bandwidth within the band that contains the highest level of the desired power. In addition, radiation emissions which fall in the restricted bands, as defined in §15.205(a), must also comply with the radiated emission limits specified in§15.209(a)	At least -20dBc than the limit Specified on the BOTTOM Channel	PASS
	At least -20dBc than the limit Specified on the TOP Channel	PASS

TEST PLOT OF OUT OF BAND EMISSIONS WITH THE WORST CASE
 OF GFSK MODULATION IN LOW CHANNEL

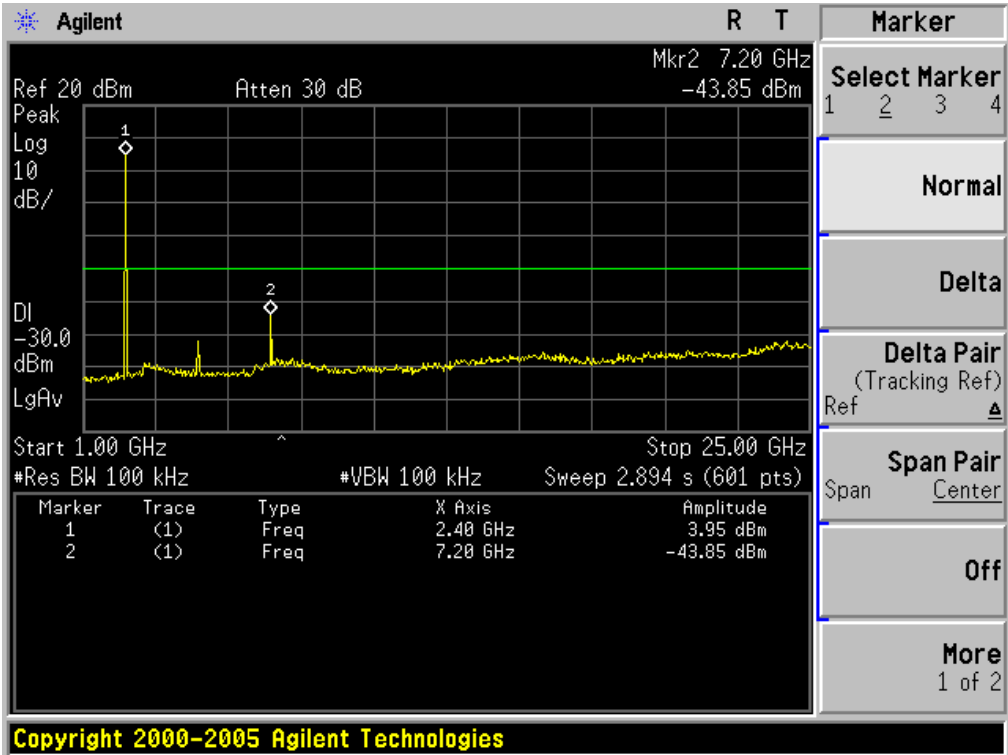
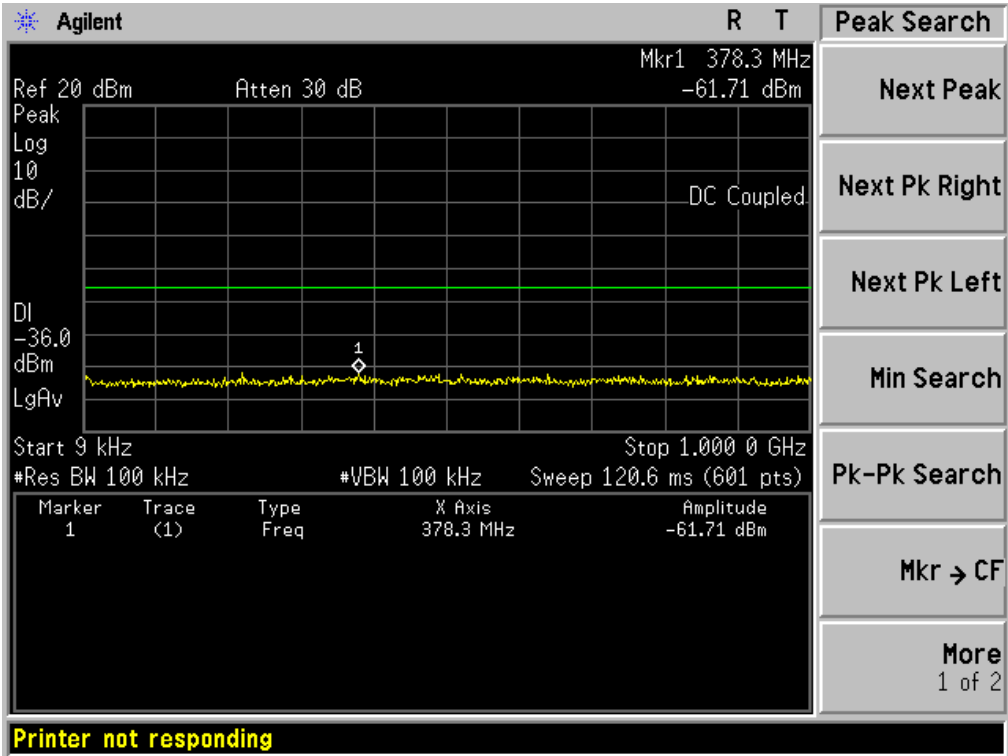

TEST PLOT OF OUT OF BAND EMISSIONS
 OF GFSK MODULATION IN MIDDLE CHANNEL

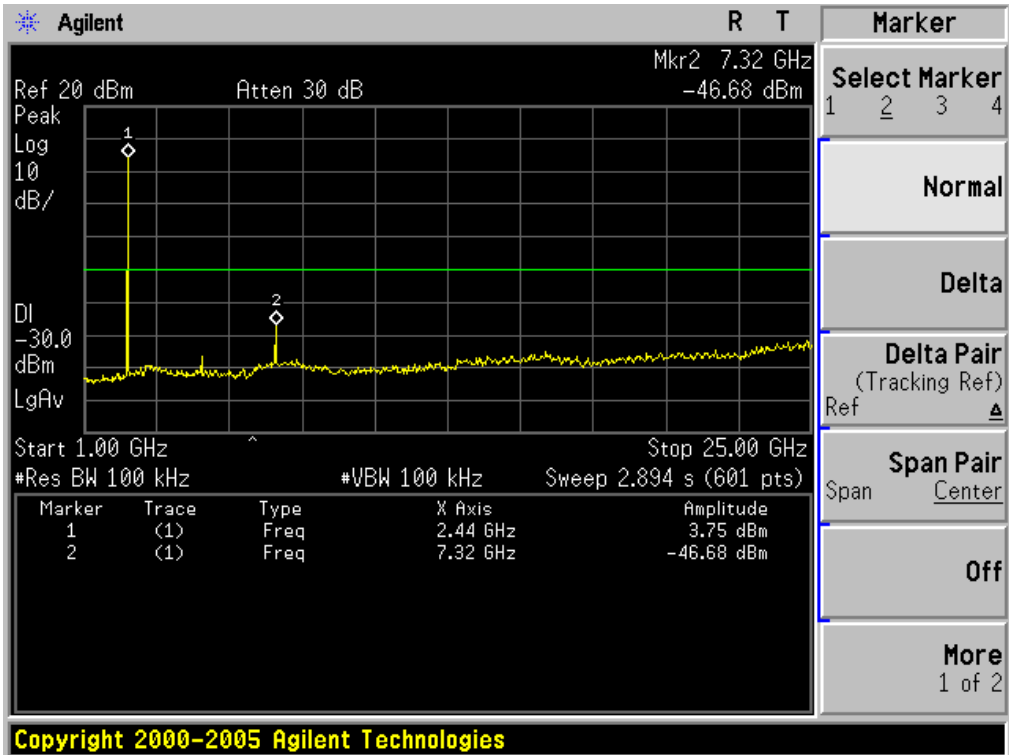
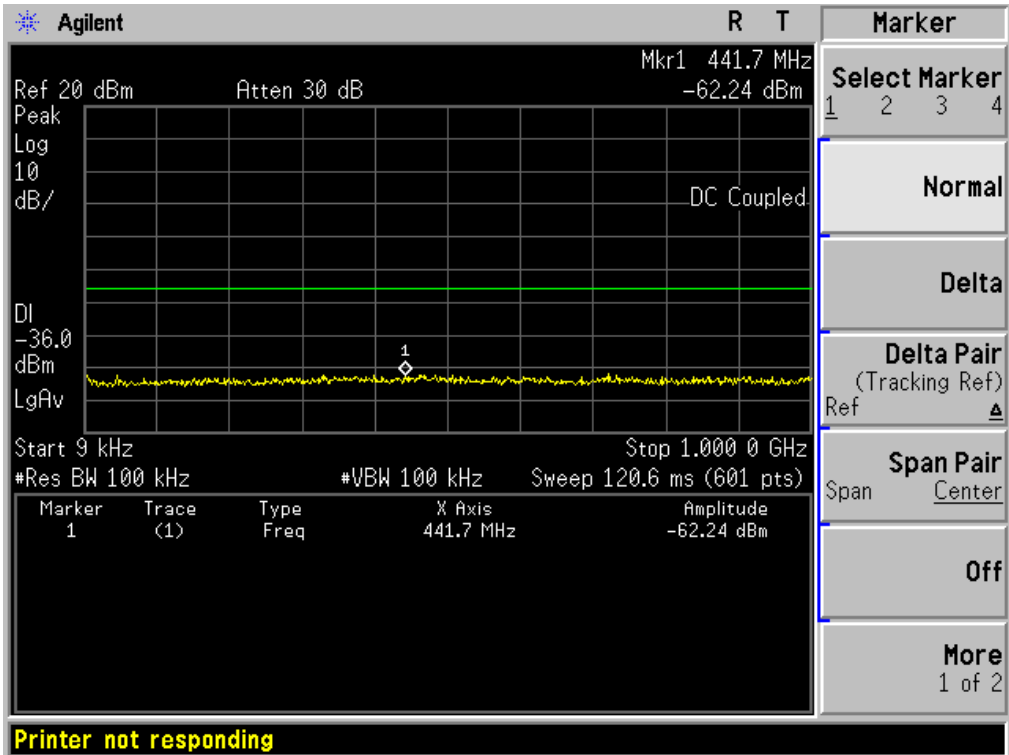

TEST PLOT OF OUT OF BAND EMISSIONS
 OF GFSK MODULATION IN HIGH CHANNEL

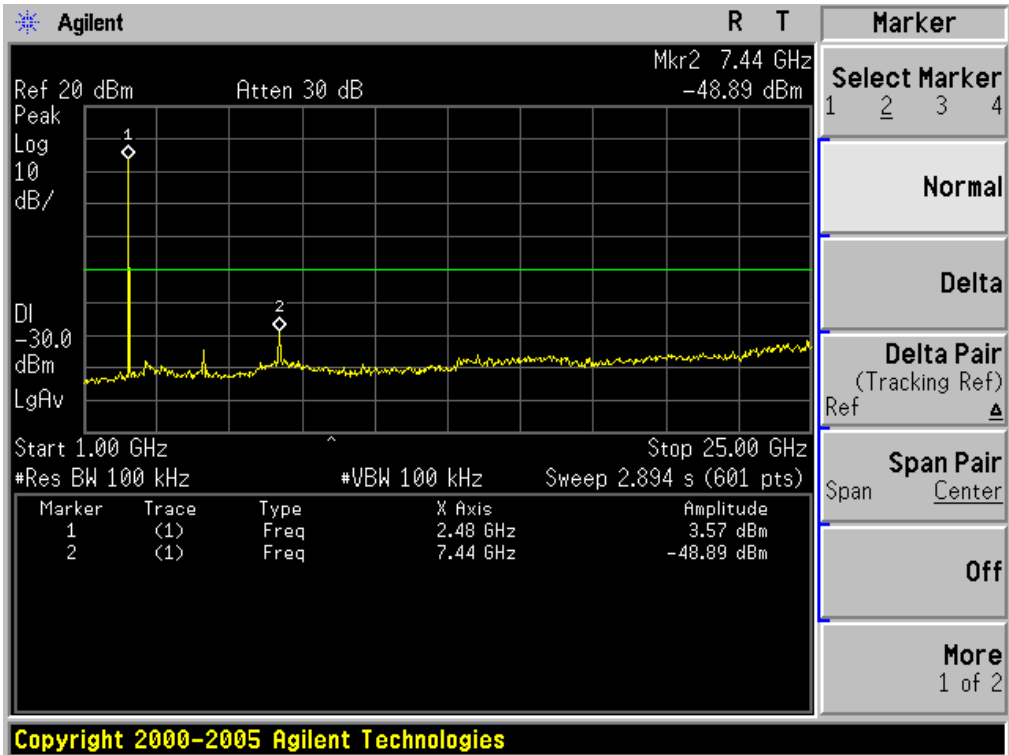
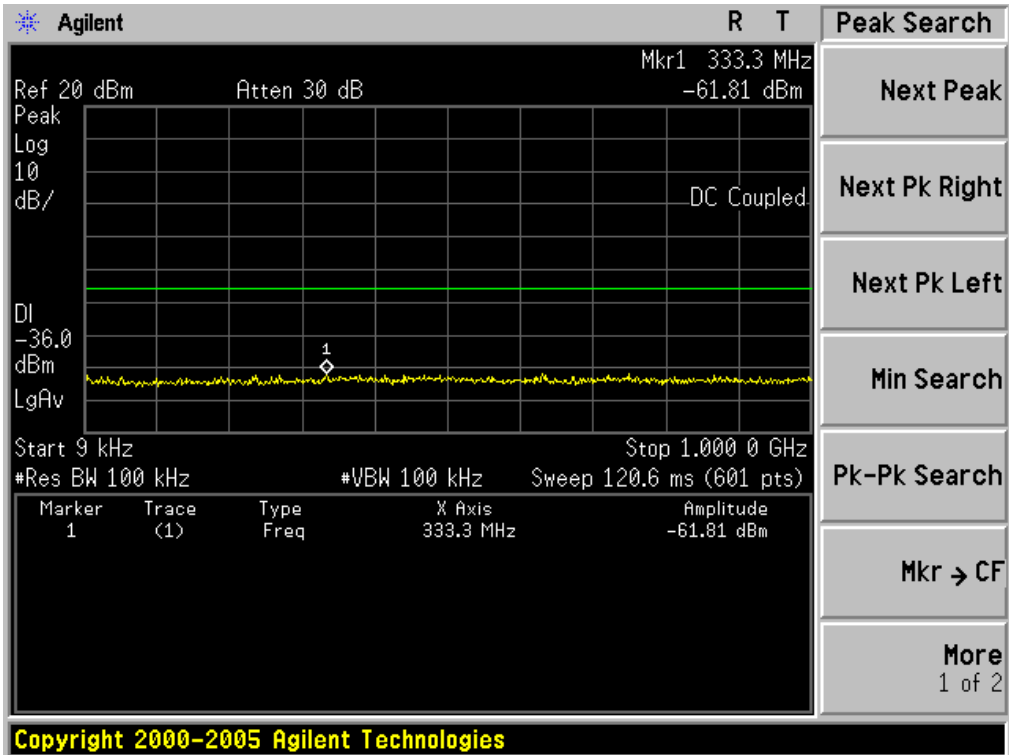

10. RADIATED EMISSION

10.1. MEASUREMENT PROCEDURE

1. Configure the EUT according to ANSI C63.4. The EUT was placed on the top of the turntable 0.8 meter above ground. The phase center of the receiving antenna mounted on the top of a height-variable antenna tower was placed 3 meters far away from the turntable.
2. Power on the EUT and all the supporting units. The turntable was rotated by 360 degrees to determine the position of the highest radiation.
3. The height of the broadband receiving antenna was varied between one meter and four meters above ground to find the maximum emissions field strength of both horizontal and vertical polarization.
4. For each suspected emissions, the antenna tower was scan (from 1 M to 4 M) and then the turntable was rotated (from 0 degree to 360 degrees) to find the maximum reading.
5. Set the test-receiver system to Peak or CISPR quasi-peak Detect Function with specified bandwidth under Maximum Hold Mode.
6. For emissions above 1GHz, use 1MHz VBW and RBW for peak reading. Then 1MHz RBW and 10Hz VBW for average reading in spectrum analyzer.
7. When the radiated emissions limits are expressed in terms of the average value of the emissions, and pulsed operation is employed, the measurement field strength shall be determined by averaging over one complete pulse train, including blanking intervals, as long as the pulse train does not exceed 0.1 seconds. As an alternative (provided the transmitter operates for longer than 0.1 seconds) or in cases where the pulse train exceeds 0.1 seconds, the measured field strength shall be determined from the average absolute voltage during a 0.1 second interval during which the field strength is at its maximum values.
8. If the emissions level of the EUT in peak mode was 3 dB lower than the average limit specified, then testing will be stopped and peak values of EUT will be reported, otherwise, the emissions which do not have 3 dB margin will be repeated one by one using the quasi-peak method for below 1GHz.
9. For testing above 1GHz, the emissions level of the EUT in peak mode was lower than average limit (that means the emissions level in peak mode also complies with the limit in average mode), then testing will be stopped and peak values of EUT will be reported, otherwise, the emissions will be measured in average mode again and reported.
10. In case the emission is lower than 30MHz, loop antenna has to be used for measurement and the recorded data should be QP measured by receiver. High - Low scan is not required in this case.

The following table is the setting of spectrum analyzer and receiver.

Spectrum Parameter	Setting
Start ~Stop Frequency	9KHz~150KHz/RB 200Hz for QP
Start ~Stop Frequency	150KHz~30MHz/RB 9KHz for QP
Start ~Stop Frequency	30MHz~1000MHz/RB 120KHz for QP
Start ~Stop Frequency	1GHz~26.5GHz 1MHz/1MHz for Peak, 1MHz/10Hz for Average

Receiver Parameter	Setting
Start ~Stop Frequency	9KHz~150KHz/RB 200Hz for QP
Start ~Stop Frequency	150KHz~30MHz/RB 9KHz for QP
Start ~Stop Frequency	30MHz~1000MHz/RB 120KHz for QP

10.2. TEST SETUP

RADIATED EMISSION TEST SETUP BELOW 30MHz

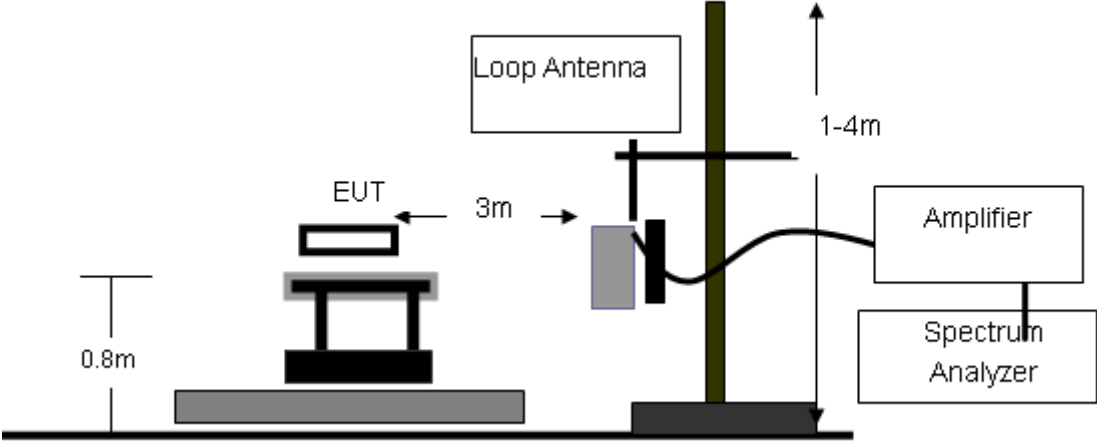

RADIATED EMISSION TEST SETUP 30MHz-1000MHz

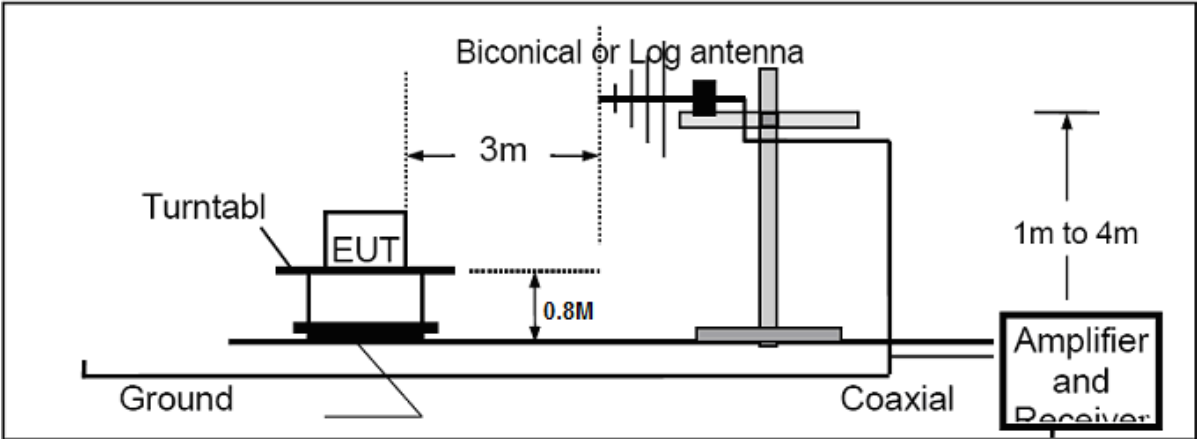

RADIATED EMISSION TEST SETUP ABOVE 1000MHz

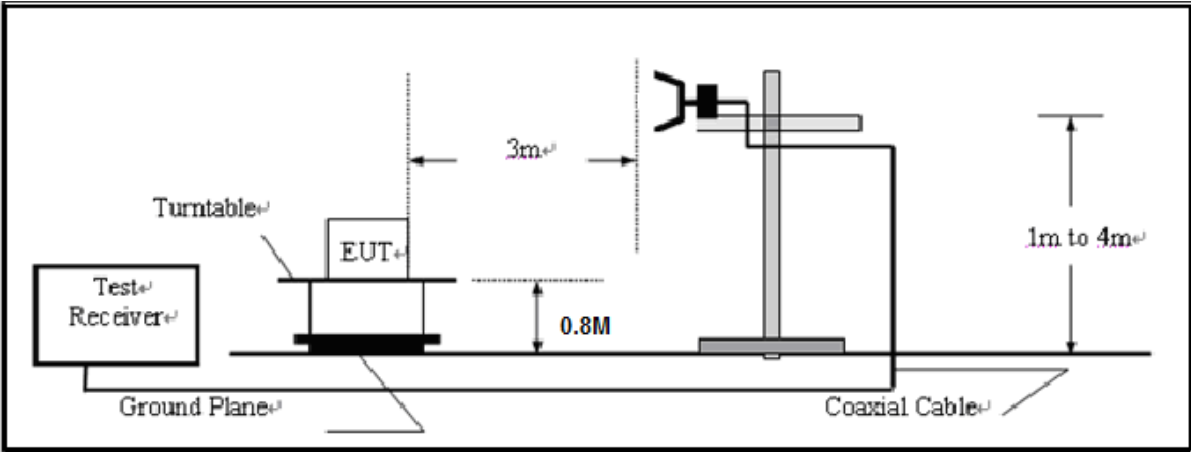

RADIATED EMISSION ABOVE 1GHZ (1-10th Harmonics) -Vertical

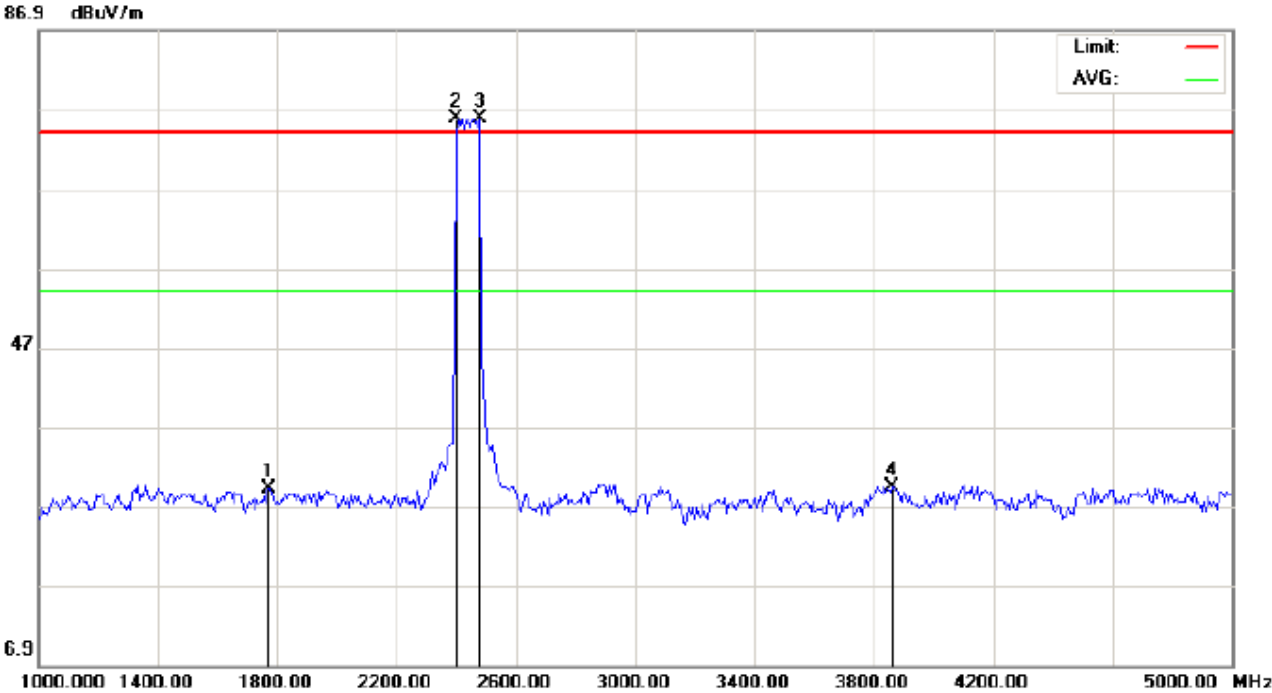

Site: site #1
 Limit: FCC Class B 3M Radiation above 1GHZ(PK)
 EUT: Glow Mobile Phone
 M/N: X200
 Mode: Normal Hopping
 Note:

Polarization: *Vertical*
 Power:
 Distance: 3m

Temperature: 26
 Humidity: 60 %

No.	Mk	Freq.	Reading	Factor	Measurement	Limit	Over	Detector	Antenna	Table	Comment
		MHz	dBuV	dB/m	dBuV/m	dBuV/m	dB		Height	Degree	
1		1773.333	39.48	-10.22	29.26	74.00	-44.74	peak	cm	degree	
2	*	2402.000	84.21	-8.39	75.82	74.00	1.82	peak			
3	X	2480.000	83.89	-8.08	75.81	74.00	1.81	peak			
4		3860.000	36.65	-7.25	29.40	74.00	-44.60	peak			

RESULT: PASS

Note: 5~25GHz at least have 20dB margin. No recording in the test report.

Factor=Antenna Factor+ Cable loss-Amplifier gain, Margin=Measurement-Limit.

11. BAND EDGE EMISSION

11.1. MEASUREMENT PROCEDURE

1. Set the EUT Work on the top, the bottom operation frequency individually.
2. Set SPA Start or Stop Frequency = Operation Frequency, $RBW \geq 1\% \text{span}$, $VBW \geq RBW$
3. The band edges was measured and recorded.

11.2. TEST SET-UP

Radiated same as 10.2

11.3. TEST RESULT

TEST PLOT OF BAND EDGE FOR LOW CHANNEL (3Mbps)-Horizontal

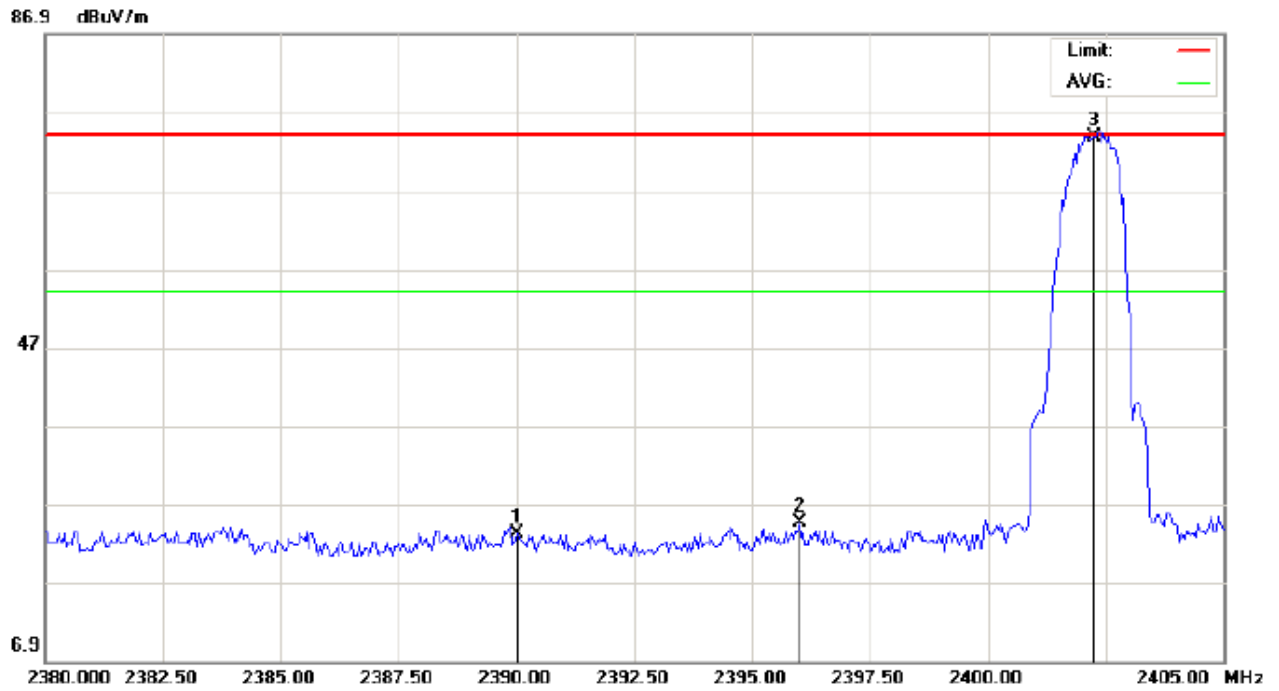

Site: site #1 Polarization: *Horizontal* Temperature: 26
Limit: FCC Class B 3M Radiation above 1GHZ(PK) Power: Humidity: 60 %
EUT: Glow Mobile Phone Distance: 3m
M/N: X200
Mode: Low Channel TX
Note:

No.	Mk	Freq.	Reading	Factor	Measurement	Limit	Over	Detector	Antenna Height	Table Degree	Comment
		MHz	dBuV	dB/m	dBuV/m	dBuV/m	dB		cm	degree	
1		2390.000	31.68	-8.44	23.24	74.00	-50.76	peak			
2		2396.000	32.99	-8.42	24.57	74.00	-49.43	peak			
3	*	2402.240	82.17	-8.39	73.78	74.00	-0.22	peak			

RESULT: PASS

TEST PLOT OF BAND EDGE FOR LOW CHANNEL (3Mbps)-Vertical

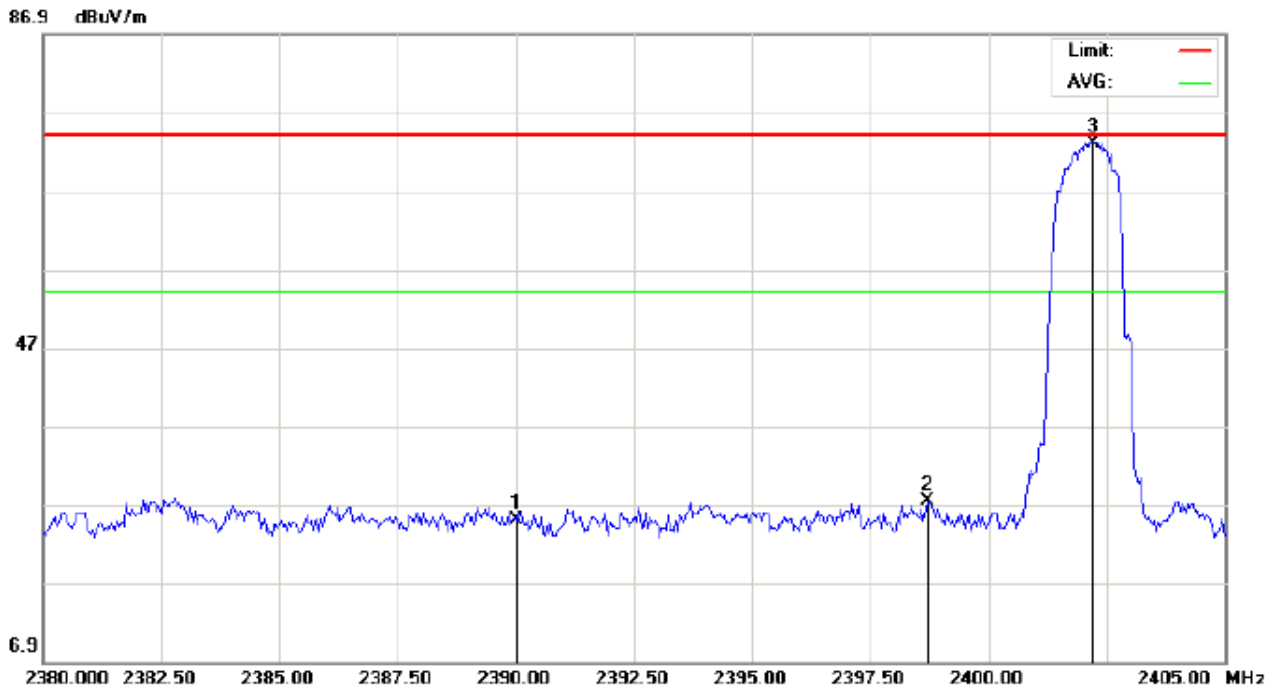

Site: site #1 Polarization: *Vertical* Temperature: 26
Limit: FCC Class B 3M Radiation above 1GHZ(PK) Power: Humidity: 60 %
EUT: Glow Mobile Phone Distance: 3m
M/N: X200
Mode: Low Channel TX
Note:

No.	Mk	Freq.	Reading	Factor	Measurement	Limit	Over	Detector	Antenna Height	Table Degree	Comment
		MHz	dBuV	dB/m	dBuV/m	dBuV/m	dB		cm	degree	
1		2390.000	33.49	-8.44	25.05	74.00	-48.95	peak			
2		2398.708	35.83	-8.41	27.42	74.00	-46.58	peak			
3	*	2402.230	81.34	-8.39	72.95	74.00	-1.05	peak			

RESULT: PASS

TEST PLOT OF BAND EDGE FOR HIGH CHANNEL (3Mbps)-Horizontal

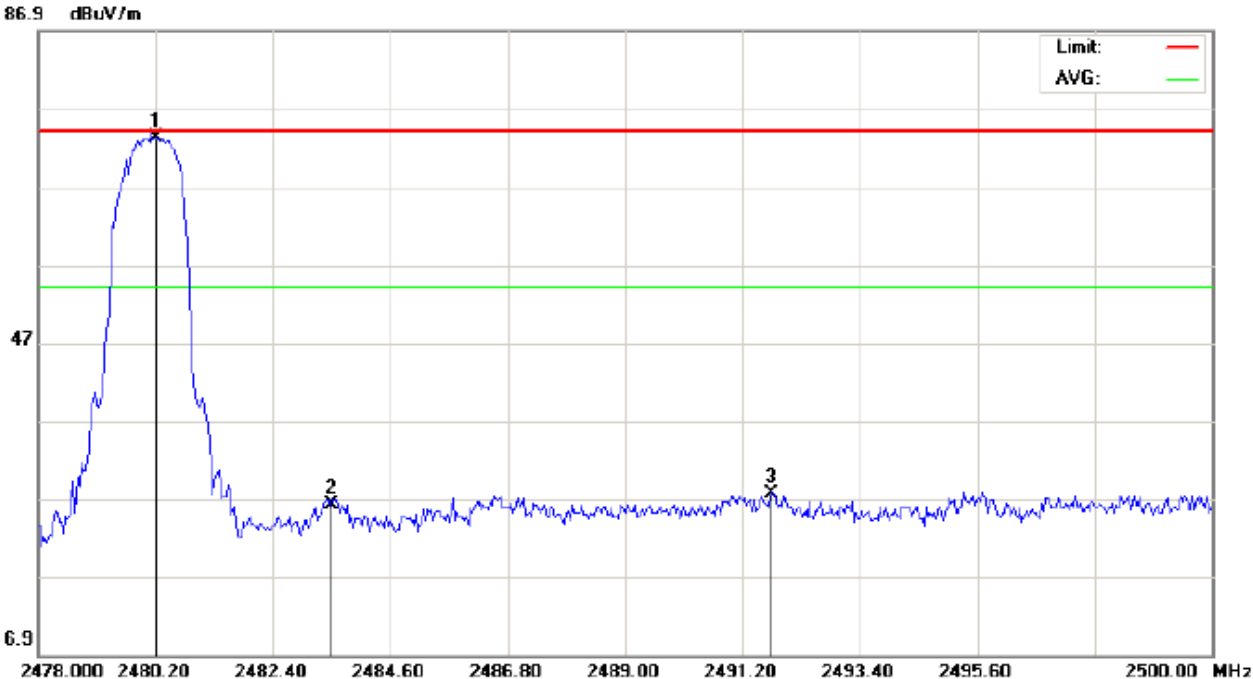

Site: site #1 Polarization: *Horizontal* Temperature: 26
Limit: FCC Class B 3M Radiation above 1GHZ(PK) Power: Humidity: 60 %
EUT: Glow Mobile Phone Distance: 3m
M/N: X200
Mode: High Channel TX
Note:

No.	Mk	Freq.	Reading	Factor	Measurement	Limit	Over	Detector	Antenna	Table	Comment
		MHz	dBuV	dB/m	dBuV/m	dBuV/m	dB		Height	Degree	
1	*	2480.210	81.23	-8.08	73.15	74.00	-0.85	peak			
2		2483.500	34.24	-8.07	26.17	74.00	-47.83	peak			
3		2491.750	35.73	-8.03	27.70	74.00	-46.30	peak			

RESULT: PASS

TEST PLOT OF BAND EDGE FOR HIGH CHANNEL (3Mbps)-Vertical

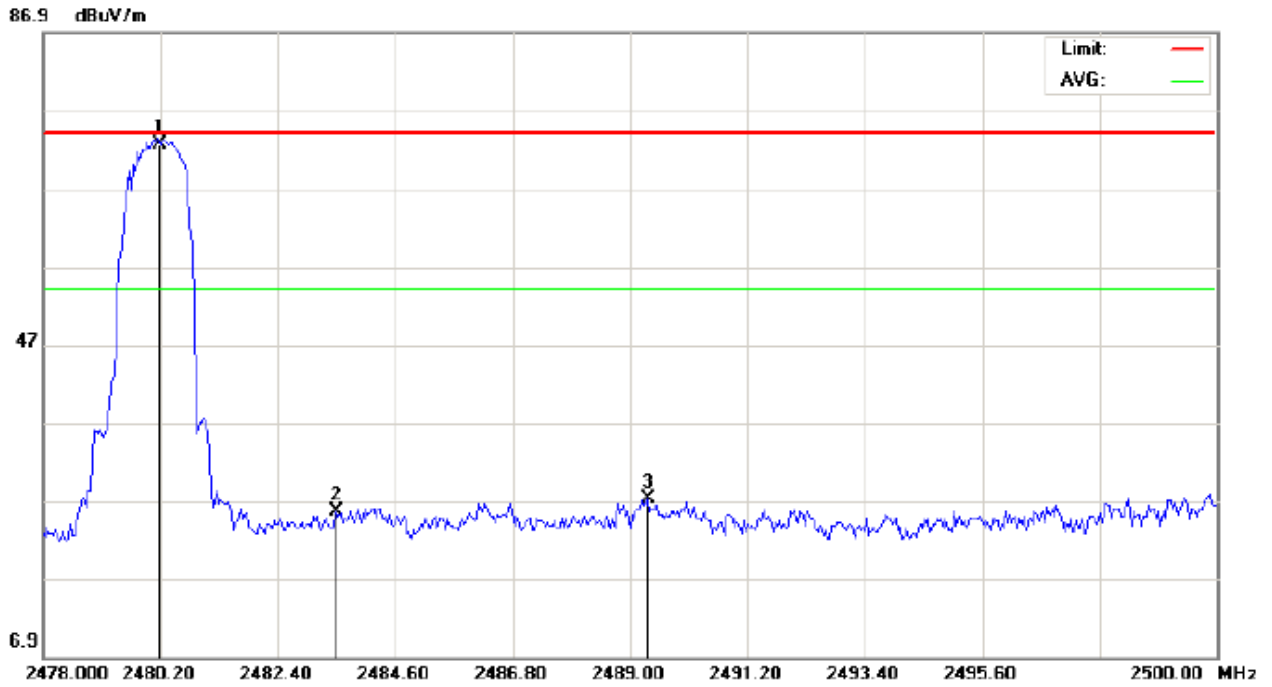

Site: site #1	Polarization: <i>Vertical</i>	Temperature: 26
Limit: FCC Class B 3M Radiation above 1GHZ(PK)	Power:	Humidity: 60 %
EUT: Glow Mobile Phone	Distance: 3m	
M/N: X200		
Mode: High Channel TX		
Note:		

No.	Mk	Freq.	Reading	Factor	Measurement	Limit	Over	Detector	Antenna Height	Table Degree	Comment
		MHz	dBuV	dB/m	dBuV/m	dBuV/m	dB		cm	degree	
1	*	2480.180	80.60	-8.08	72.52	74.00	-1.48	peak			
2		2483.500	33.61	-8.07	25.54	74.00	-48.46	peak			
3		2489.330	35.19	-8.04	27.15	74.00	-46.85	peak			

RESULT: PASS

12. NUMBER OF HOPPING FREQUENCY

12.1. MEASUREMENT PROCEDURE

1. Place the EUT on the table and set it in transmitting mode.
2. Remove the antenna from the EUT and then connect a low RF cable from the antenna port to the spectrum analyzer.
3. Set the spectrum analyzer Start = 2.4GHz Stop = 2.4835GHz
4. Set the Spectrum Analyzer as RBW>=1%span, VBW>=RBW.

12.2. TEST SETUP (BLOCK DIAGRAM OF CONFIGURATION)

Same as described in section 8.2

12.3. MEASUREMENT EQUIPMENT USED

The same as described in section 6

12.4. LIMITS AND MEASUREMENT RESULT

TOTAL NO. OF HOPPING CHANNEL	LIMIT (NO. OF CH)	MEASUREMENT (NO. OF CH)	RESULT
	>=15	79	PASS

TEST PLOT FOR NO. OF TOTAL CHANNELS

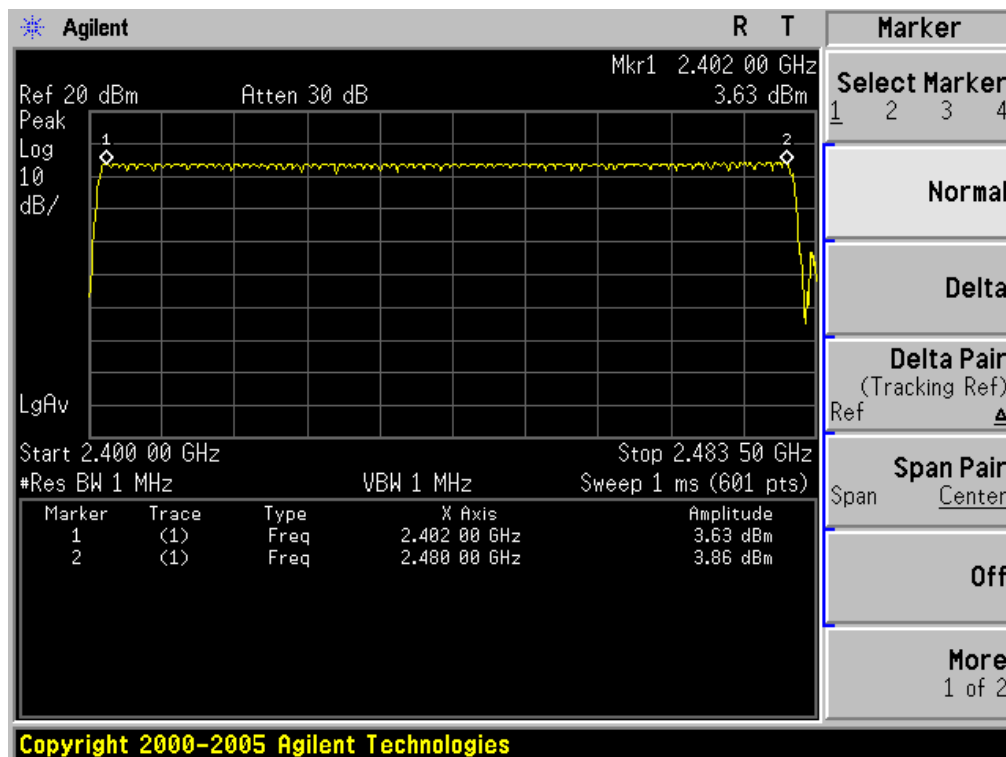

13. TIME OF OCCUPANCY (DWELL TIME)

13.1. MEASUREMENT PROCEDURE

1. Place the EUT on the table and set it in transmitting mode
2. Remove the antenna from the EUT and then connect a low RF cable from the antenna port to the spectrum analyzer.
3. Set Span = zero span, centered on a hopping channel
4. Set the spectrum analyzer as RBW=1MHz, VBW>=RBW, Span = 0 Hz

13.2. TEST SETUP (BLOCK DIAGRAM OF CONFIGURATION)

Same as described in section 8.2

13.3. MEASUREMENT EQUIPMENT USED

The same as described in section 6

13.4. LIMITS AND MEASUREMENT RESULT

The Worst Case (3Mbps)

Channel	Time of Pulse for DH5 (ms)	Period Time (s)	Sweep Time (ms)	Limit (ms)
Low	2.875	31.6	306.67	400
Middle	2.891	31.6	308.37	400
High	2.973	31.6	317.12	400

Low Channel Time

$$2.875 * (1600/6) / 79 * 31.6 = 306.67 \text{ms}$$

Middle Channel Time

$$2.891 * (1600/6) / 79 * 31.6 = 308.37 \text{ms}$$

High Channel Time

$$2.973 * (1600/6) / 79 * 31.6 = 317.12 \text{ms}$$

TEST PLOT OF LOW CHANNEL

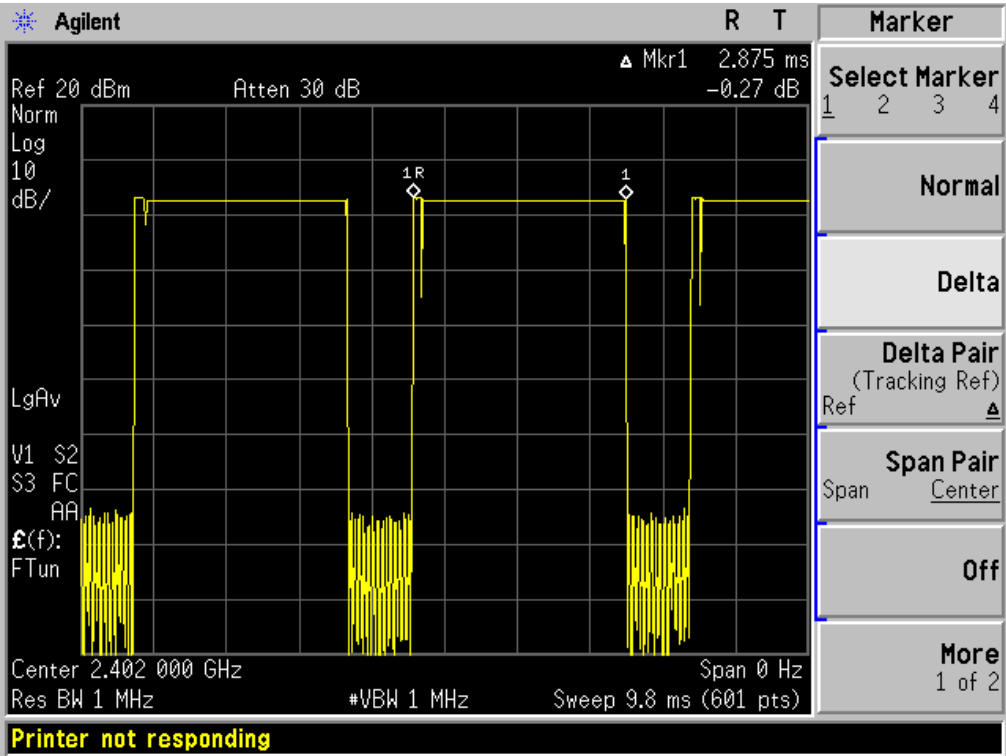

TEST PLOT OF MIDDLE CHANNEL

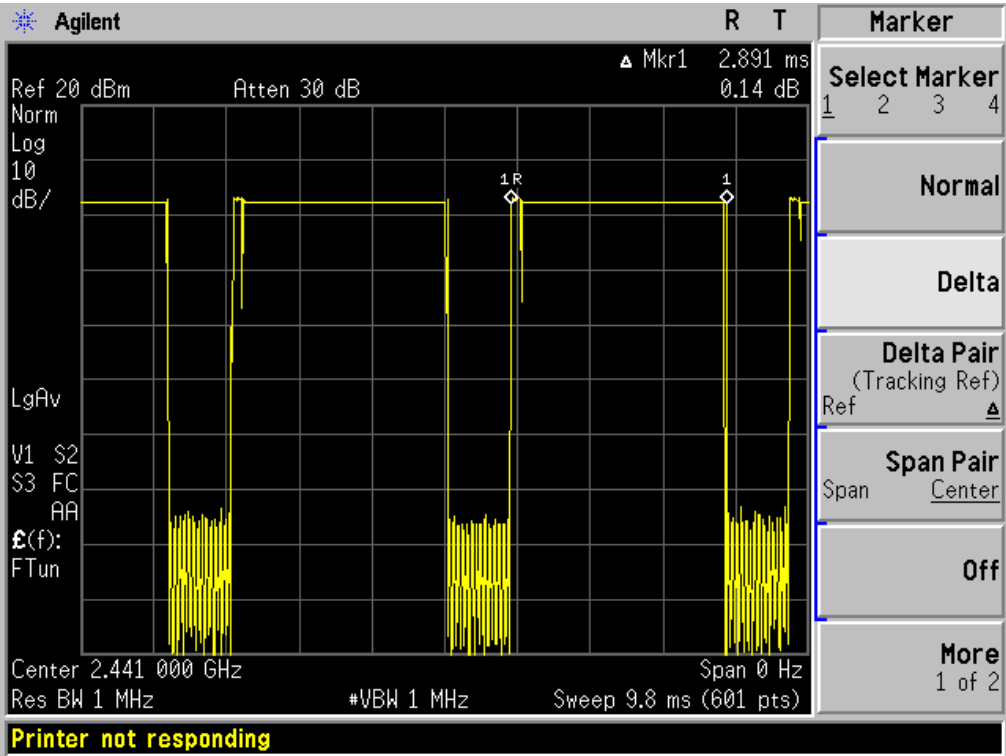

TEST PLOT OF HIGH CHANNEL

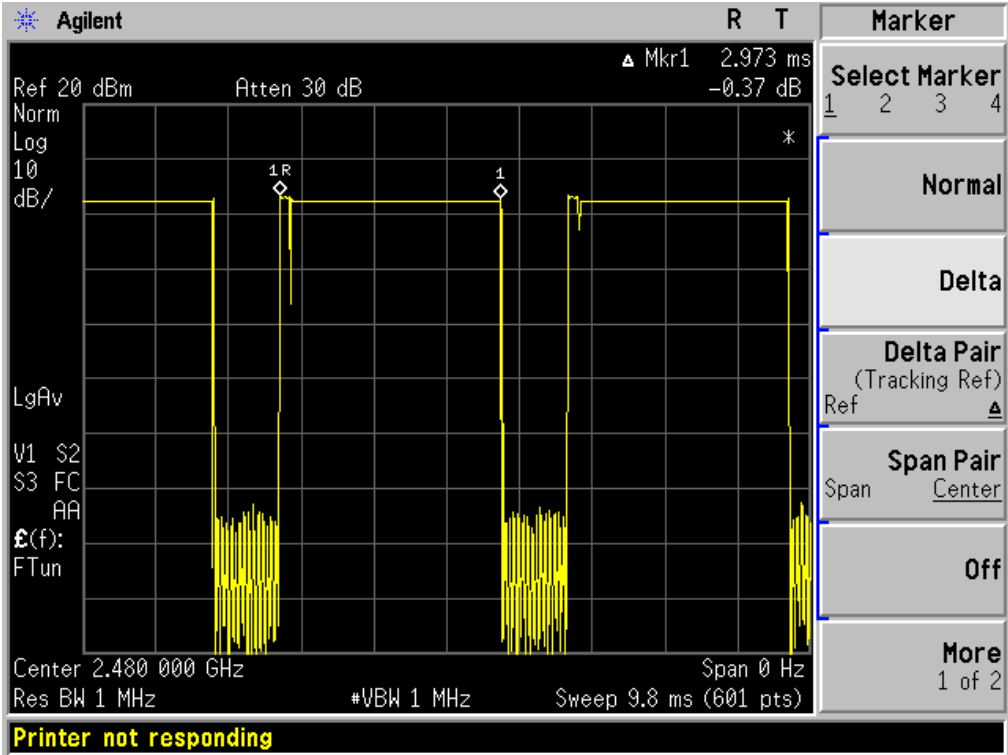

14. FREQUENCY SEPARATION

14.1. MEASUREMENT PROCEDURE

1. Place the EUT on the table and set it in transmitting mode
2. Remove the antenna from the EUT and then connect a low RF cable from the antenna port to the spectrum analyzer
3. Set Span = wide enough to capture the peaks of two adjacent channels Resolution (or IF) Bandwidth (RBW) \geq 1% of the span Video (or Average) Bandwidth (VBW) \geq RBW; Sweep = auto; Detector function = peak; Trace = max hold

14.2. TEST SETUP (BLOCK DIAGRAM OF CONFIGURATION)

Same as described in section 6.2

14.3. MEASUREMENT EQUIPMENT USED

The same as described in section 6.3

14.4. LIMITS AND MEASUREMENT RESULT

CHANNEL	CHANNEL SEPARATION	LIMIT	RESULT
	KHz	KHz	
CH00-CH01	1000	\geq 25 KHz or 2/3 20 dB BW	Pass

TEST PLOT FOR FREQUENCY SEPARATION (3Mbps)

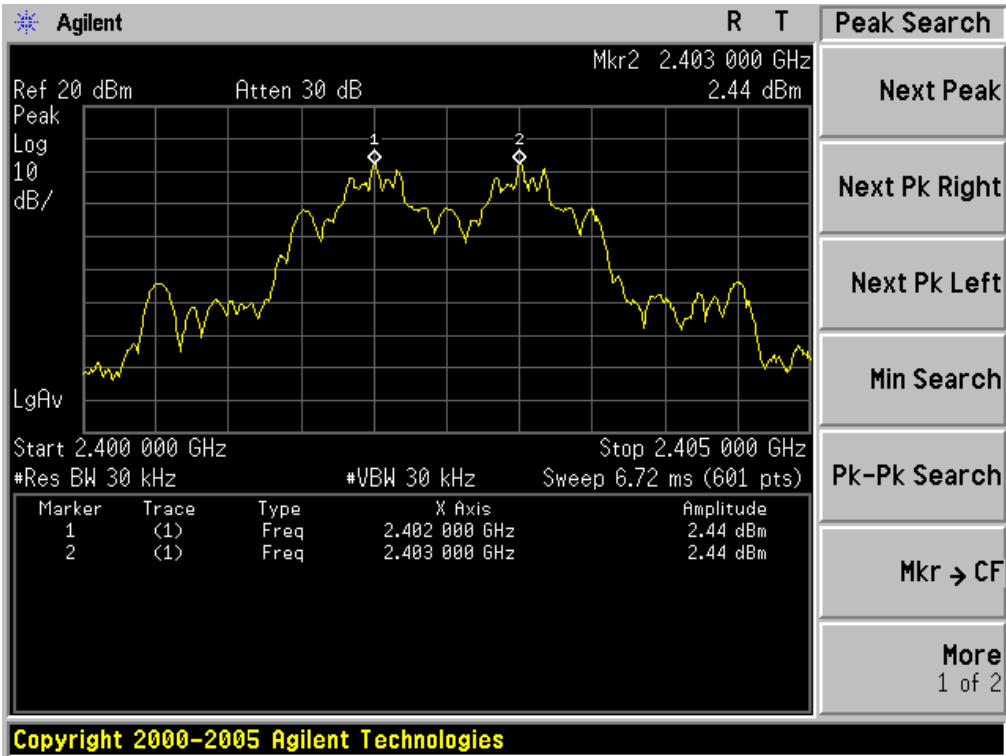

15. FCC LINE CONDUCTED EMISSION TEST

15.1. LIMITS OF LINE CONDUCTED EMISSION TEST

Frequency	Maximum RF Line Voltage	
	Q.P.(dBuV)	Average(dBuV)
150kHz~500kHz	66-56	56-46
500kHz~5MHz	56	46
5MHz~30MHz	60	50

Note:

1. The lower limit shall apply at the transition frequency.
2. The limit decreases linearly with the logarithm of the frequency in the range 0.15 MHz to 0.50 MHz.

15.2. BLOCK DIAGRAM OF LINE CONDUCTED EMISSION TEST

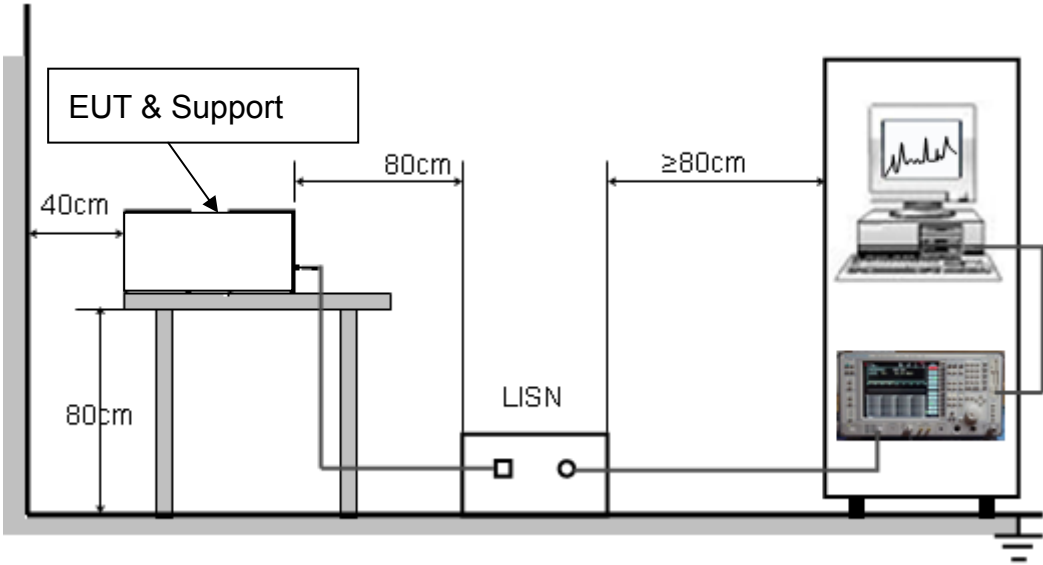

15.3. PRELIMINARY PROCEDURE OF LINE CONDUCTED EMISSION TEST

1. The equipment was set up as per the test configuration to simulate typical actual usage per the user's manual. When the EUT is a tabletop system, a wooden table with a height of 0.8 meters is used and is placed on the ground plane as per ANSI C63.4 (see Test Facility for the dimensions of the ground plane used). When the EUT is a floor-standing equipment, it is placed on the ground plane which has a 3-12 mm non-conductive covering to insulate the EUT from the ground plane.
2. Support equipment, if needed, was placed as per ANSI C63.4.
3. All I/O cables were positioned to simulate typical actual usage as per ANSI C63.4.
4. All support equipments received AC120V/60Hz power from a LISN, if any.
5. The EUT received power by adapter which received 120V/60Hz power by a LISN..
6. The test program was started. Emissions were measured on each current carrying line of the EUT using a spectrum Analyzer / Receiver connected to the LISN powering the EUT. The LISN has two monitoring points: Line 1 (Hot Side) and Line 2 (Neutral Side). Two scans were taken: one with Line 1 connected to Analyzer / Receiver and Line 2 connected to a 50 ohm load; the second scan had Line 1 connected to a 50 ohm load and Line 2 connected to the Analyzer / Receiver.
7. Analyzer / Receiver scanned from 150 kHz to 30MHz for emissions in each of the test modes.
8. During the above scans, the emissions were maximized by cable manipulation.
9. The test mode(s) were scanned during the preliminary test.

Then, the EUT configuration and cable configuration of the above highest emission level were recorded for reference of final testing.

15.4. FINAL PROCEDURE OF LINE CONDUCTED EMISSION TEST

1. EUT and support equipment was set up on the test bench as per step 2 of the preliminary test.
2. A scan was taken on both power lines, Line 1 and Line 2, recording at least the six highest emissions. Emission frequency and amplitude were recorded into a computer in which correction factors were used to calculate the emission level and compare reading to the applicable limit. If EUT emission level was less -2dB to the A.V. limit in Peak mode, then the emission signal was re-checked using Q.P and Average detector.
3. The test data of the worst case condition(s) was reported on the Summary Data page.

15.5. TEST RESULT OF LINE CONDUCTED EMISSION TEST

Line Conducted Emission Test Line 1-L

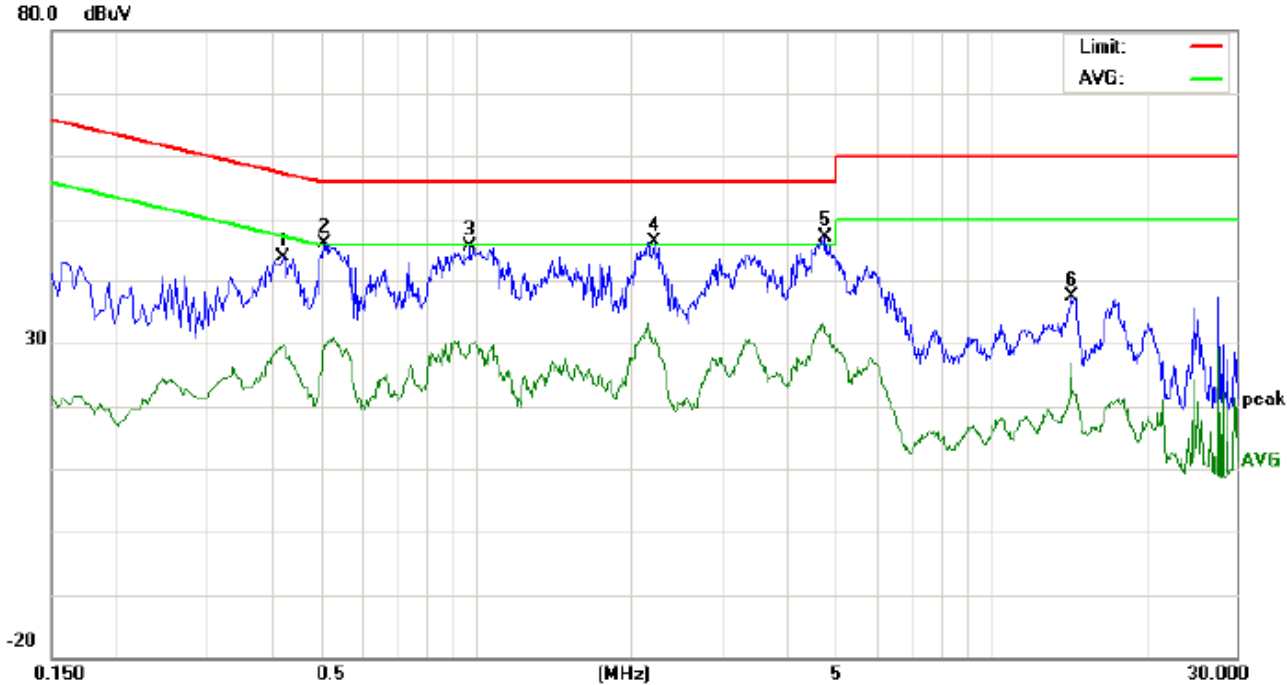

Site: Conduction Phase: **L1** Temperature: 26
 Limit: FCC Class B Conduction(QP) Power: Humidity: 60 %
 EUT: Glow Mobile Phone
 M/N: X200
 Mode: Normal Hopping
 Note:

No.	Freq. (MHz)	Reading_Level (dBuV)			Correct Factor (dB)	Measurement (dBuV)			Limit (dBuV)		Margin (dB)		P/F	Comment
		Peak	QP	AVG		Peak	QP	AVG	QP	AVG	QP	AVG		
1	0.4219	33.56		19.31	10.35	43.91		29.66	57.41	47.41	-13.50	-17.75	P	
2	0.5100	35.61		19.27	10.39	46.00		29.66	56.00	46.00	-10.00	-16.34	P	
3	0.9779	35.25		19.17	10.38	45.63		29.55	56.00	46.00	-10.37	-16.45	P	
4	2.2259	36.11		20.64	10.31	46.42		30.95	56.00	46.00	-9.58	-15.05	P	
5	4.7857	37.01		21.60	10.23	47.24		31.83	56.00	46.00	-8.76	-14.17	P	
6	14.3178	27.17		16.66	10.12	37.29		26.78	60.00	50.00	-22.71	-23.22	P	

Line Conducted Emission Test Line 2-N

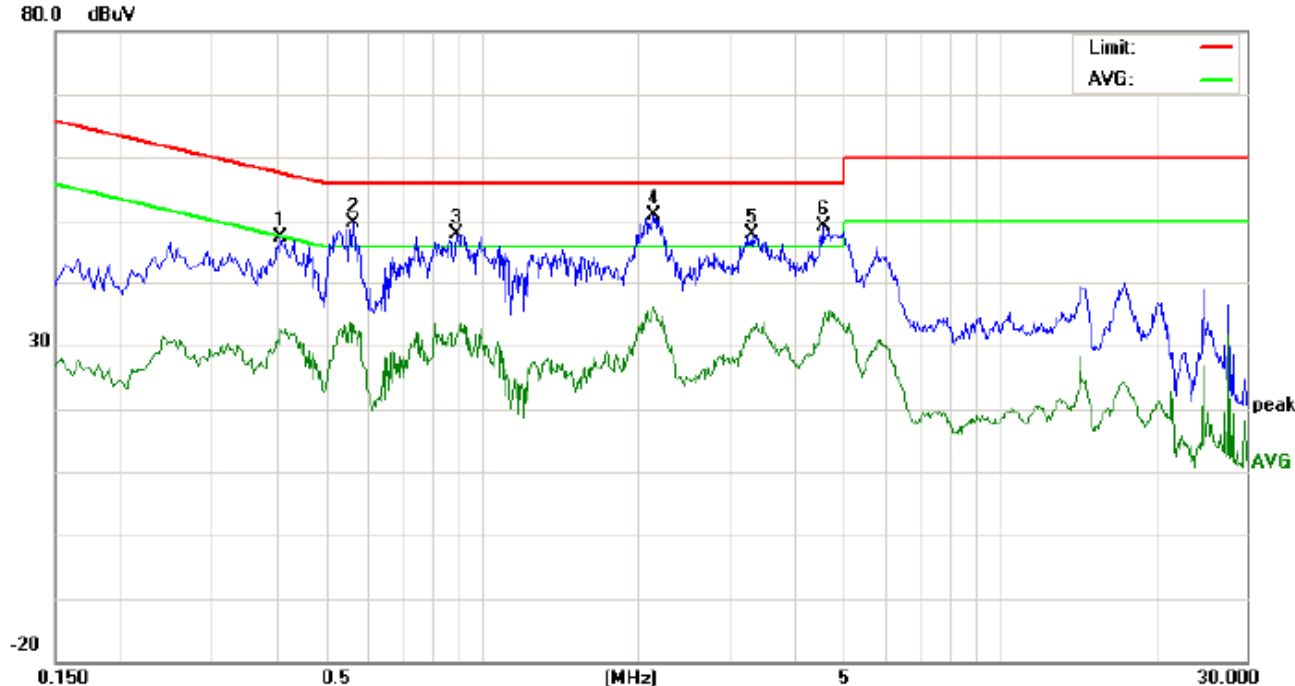

Site: Conduction Phase: **N** Temperature: 26
 Limit: FCC Class B Conduction(QP) Power: Humidity: 60 %
 EUT: Glow Mobile Phone
 M/N: X200
 Mode: Normal Hopping
 Note:

No.	Freq. (MHz)	Reading_Level (dBuV)			Correct Factor (dB)	Measurement (dBuV)			Limit (dBuV)		Margin (dB)		P/F	Comment
		Peak	QP	AVG		Peak	QP	AVG	QP	AVG	QP	AVG		
1	0.4099	36.94		22.23	10.34	47.28		32.57	57.65	47.65	-10.37	-15.08	P	
2	0.5658	39.19		22.84	10.34	49.53		33.18	56.00	46.00	-6.47	-12.82	P	
3	0.8900	37.40		21.56	10.40	47.80		31.96	56.00	46.00	-8.20	-14.04	P	
4	2.1538	40.66		25.79	10.28	50.94		36.07	56.00	46.00	-5.06	-9.93	P	
5	3.3380	37.46		21.95	10.52	47.98		32.47	56.00	46.00	-8.02	-13.53	P	
6	4.5658	38.84		23.70	10.21	49.05		33.91	56.00	46.00	-6.95	-12.09	P	

APPENDIX A: PHOTOGRAPHS OF TEST SETUP
FCC LINE CONDUCTED EMISSION TEST SETUP



FCC RADIATED EMISSION TEST SETUP

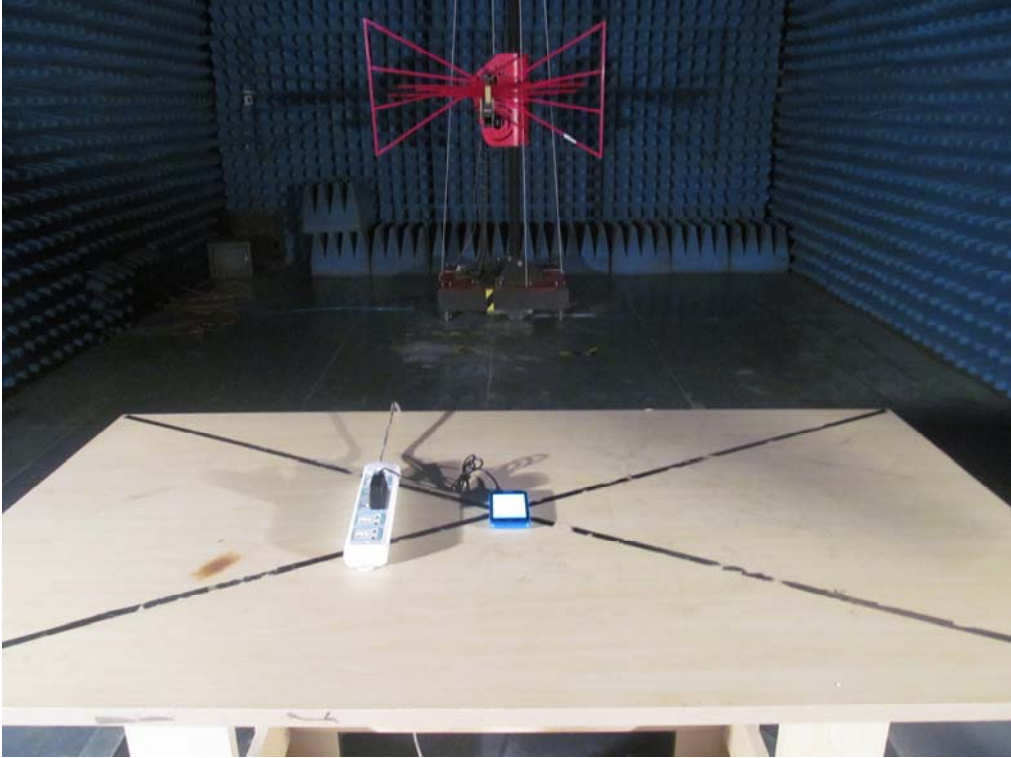

APPENDIX B: PHOTOGRAPHS OF EUT
TOTAL VIEW OF EUT



TOP VIEW OF EUT



BOTTOM VIEW OF EUT



FRONT VIEW OF EUT



BACK VIEW OF EUT



LEFT VIEW OF EUT



RIGHT VIEW OF EUT



OPEN VIEW OF EUT-1

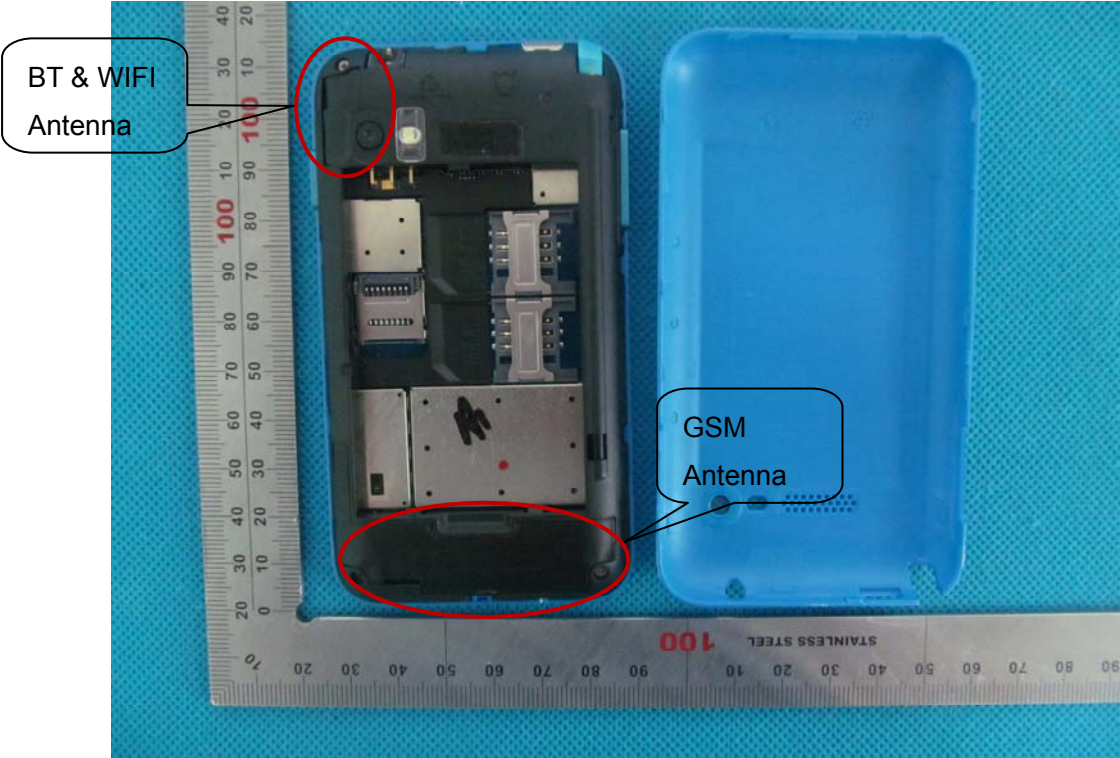

OPEN VIEW OF EUT-2

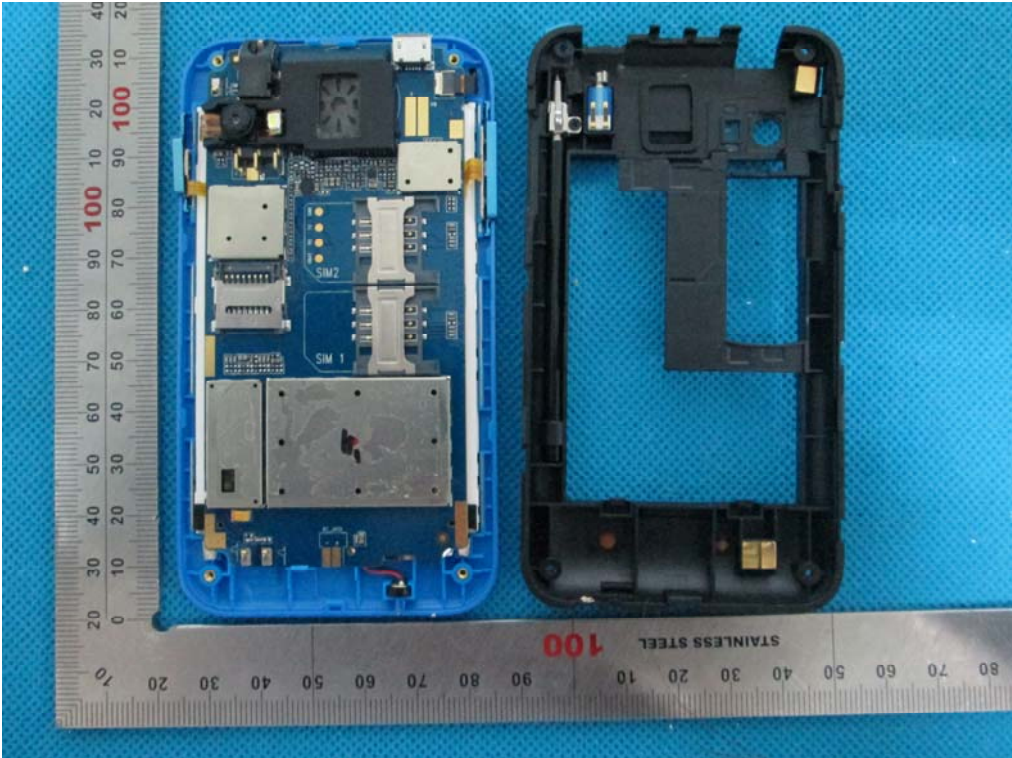

OPEN VIEW OF EUT-3



INTERNAL VIEW OF EUT-1

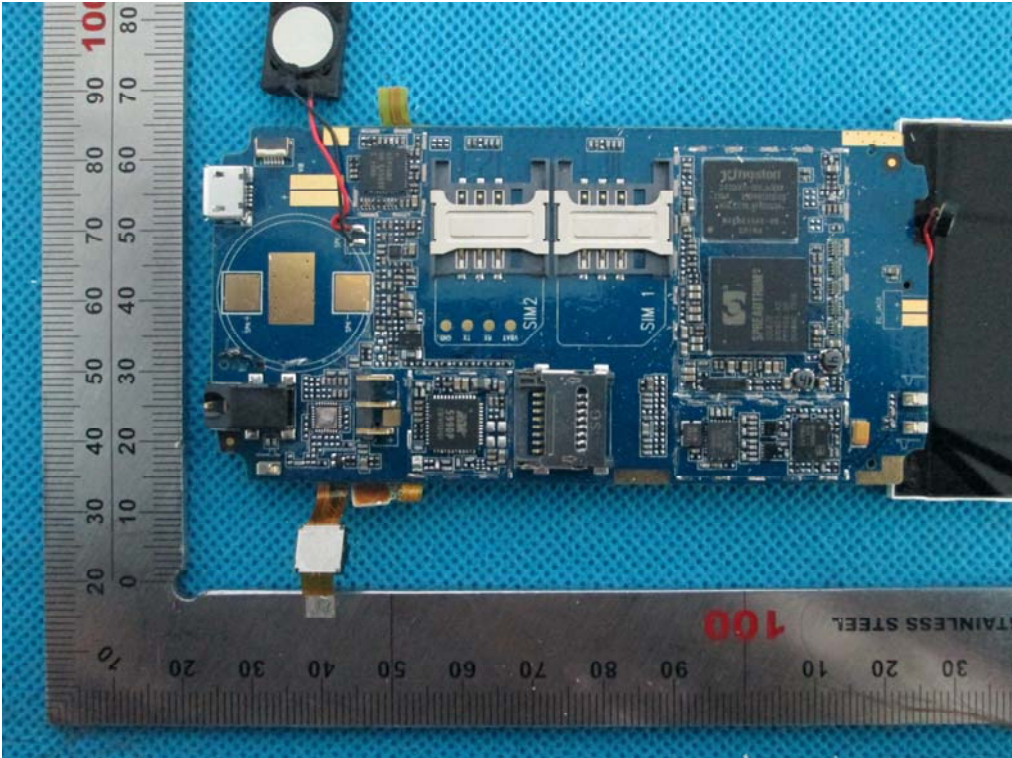

INTERNAL VIEW OF EUT-2

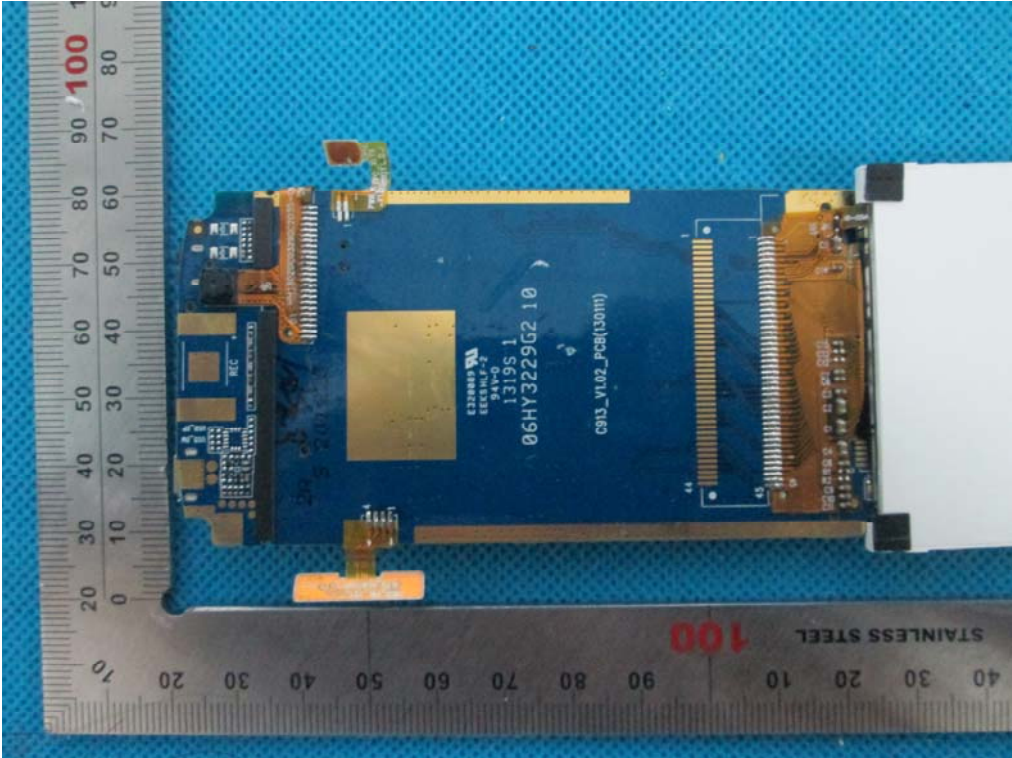

----END OF REPORT----