



SAR Test Report

Report No.: AGC00529130602FH01

FCC ID : Y7WPLUMX200
PRODUCT DESIGNATION : Glow Mobile Phone
APPLICATION PURPOSE : Original Equipment
BRAND NAME : plum
MODEL NAME : X200
CLIENT : CLC Hong Kong Limited
DATE OF ISSUE : Jun.29, 2013
STANDARD(S) : FCC Oet65 Supplement C June 2001
: IEEE Std. 1528-2003
: 47CFR § 2.1093
REPORT VERSION : V1.0

Attestation of Global Compliance (Shenzhen) Co., Ltd.



CAUTION:

This report shall not be reproduced except in full without the written permission of the test laboratory and shall not be quoted out of context.

Report Revise Record

Report Version	Revise Time	Issued Date	Valid Version	Notes
V1.0	/	Jun.29, 2013	Valid	Original Report

<h1>Test Report Certification</h1>	
Applicant Name	CLC Hong Kong Limited
Applicant Address	2209, Concordia Plaza, North Tower, No.1 Science Museum Road, Tsim Sha Tsui East, Kowloon, Hong Kong
Manufacturer Name	CLC Technology Co., Ltd.
Manufacturer Address	Room 6G, Block C, NEO Building, Chegongmiao, Futian District, Shenzhen, P.R.China
Product Designation	Glow Mobile Phone
Brand Name	plum
Model Name	X200
Different Description	N/A
EUT Voltage	DC3.7V by battery
Applicable Standard	FCC Oet65 Supplement C June 2001 IEEE Std. 1528-2003 47CFR § 2.1093
Test Date	Jun.28, 2013
Test Results	MAX SAR MEASUREMENT(1g) Head: 0.857 W/Kg Body: 0.706 W/Kg (Maximum Scaling SAR = 0.971 W/Kg) simultaneous transmission: 1.267 W/Kg
Performed Location	Attestation of Global Compliance(Shenzhen) Co., Ltd.
	2 F, Building 2, No.1-No.4, Chaxi Sanwei Technical Industrial Park, Gushu, Xixiang Street, Bao'an District, Shenzhen, China
Report Template	AGCRT-US-2.5G2/SAR (2013-03-01)

Documented By 
Vivi Zeng Jun.29, 2013

Checked By 
Angela Li Jun.29, 2013

Authorized By 
Solger Zhang Jun.29, 2013

TABLE OF CONTENTS

1. GENERAL INFORMATION	5
1.1. EUT DESCRIPTION	5
1.2. TEST PROCEDURE	7
1.3. TEST ENVIRONMENT	7
2. SAR MEASUREMENT SYSTEM	8
2.1. COMOSAR SYSTEM DESCRIPTION	8
2.2. COMOSAR E-FIELD PROBE	10
2.3. ROBOT	10
2.4. VIDEO POSITIONING SYSTEM	11
2.5. DEVICE HOLDER	11
2.6. SAM TWIN PHANTOM	12
3. TISSUE SIMULATING LIQUID	13
3.1. THE COMPOSITION OF THE TISSUE SIMULATING LIQUID	13
3.2. TISSUE CALIBRATION RESULT	14
3.3. TISSUE DIELECTRIC PARAMETERS FOR HEAD AND BODY PHANTOMS	15
4. SAR MEASUREMENT PROCEDURE	16
4.1. SAR SYSTEM VALIDATION	16
4.2. SAR MEASUREMENT PROCEDURE	18
5. SAR EXPOSURE LIMITS	19
6. TEST EQUIPMENT LIST	20
7. MEASUREMENT UNCERTAINTY	21
8. CONDUCTED POWER MEASUREMENT	22
9. TEST RESULTS	23
9.1. SAR TEST RESULTS SUMMARY	23
APPENDIX A. SAR SYSTEM VALIDATION DATA	31
APPENDIX B. SAR MEASUREMENT DATA	35
APPENDIX C. TEST SETUP PHOTOGRAPHS & EUT PHOTOGRAPHS	87
APPENDIX D. PROBE CALIBRATION DATA	98
APPENDIX E. DIPOLE CALIBRATION DATA	108

1. General Information

1.1. EUT Description

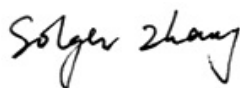
General Information	
Product Designation	Glow Mobile Phone
Test Model	X200
Hardware Version	C913_V1.02_PCB
Software Version	N/A
Device Category	Portable
RF Exposure Environment	Uncontrolled
Antenna Type	Internal
GSM and GPRS	
Support Band	<input checked="" type="checkbox"/> GSM 850 <input checked="" type="checkbox"/> PCS 1900 (U.S. Bands) <input checked="" type="checkbox"/> GSM 900 <input checked="" type="checkbox"/> DCS 1800 (Non-U.S. Bands)
GPRS Type	Class B
GPRS Class	Class 8,10 ,12(1Tx+4Rx, 2Tx+3Rx, 3Tx+2Rx, 4Tx+1Rx)
TX Frequency Range	GSM 850 : 824.2~848.8MHz; PCS 1900: 1850.2~1909.8MHz;
RX Frequency Range	GSM 850 : 869~894MHz PCS 1900: 1930~1990MHz
Release Version	R99
Type of modulation	GMSK for GSM/GPRS
Antenna Gain	1.0dBi
Max. Output Power (Avg. Burst Power)	GSM850: 32.47dBm(31.50dBm- Avg. Burst Power) PCS1900: 29.49dBm(28.43dBm- Avg. Burst Power)
Max. Output Power (Radiated)	GSM850: 30.43dBm- ERP PCS1900: 28.26dBm- EIRP
Bluetooth	
Bluetooth Version	<input type="checkbox"/> V2.0 <input type="checkbox"/> V2.1 <input checked="" type="checkbox"/> V2.1+EDR <input type="checkbox"/> V3.0 <input type="checkbox"/> V3.0+EDR <input type="checkbox"/> V4.0
Operation Frequency	2402~2480MHz
Type of modulation	<input checked="" type="checkbox"/> GFSK <input checked="" type="checkbox"/> π/4-DQPSK <input checked="" type="checkbox"/> 8-DPSK

Avg. Burst Power	2.27dBm
Antenna Gain	1.0dBi
WIFI	
WIFI Specification	<input type="checkbox"/> 802.11a <input checked="" type="checkbox"/> 802.11b <input checked="" type="checkbox"/> 802.11g <input checked="" type="checkbox"/> 802.11n(20) <input type="checkbox"/> 802.11n(40)
Operation Frequency	2412~2462MHz
Avg. Burst Power	11b: 9.96dBm, 11g: 9.37dBm, 11n(20): 8.99dBm
Antenna Gain	1.0dBi
Accessories	
Battery	Brand name: plum Model No. : PMB34 Voltage and Capacitance: 3.7 V & 1400mAh
Adapter	Brand name: plum Model No. : PMC03 Input: AC 100-240V, 50/60Hz, 0.15A Output: DC 5V, 500mA
Earphone	Brand name: plum Model No. : X200

Note:

1. The EUT is a model of GSM Portable Mobile Station (MS). It supports GSM/GPRS, BT, WIFI and don't support hot spot mode.
2. The sample used for testing is end product.

1.2. Test Procedure

1	Setup the EUT and simulators as shown on above.
2	Turn on the power of all equipment.
3	EUT Communicate with CMU 200, and test them respectively at U.S. bands

1.3. Test Environment

Ambient conditions in the laboratory:

Items	Required	Actual
Temperature (°C)	18-25	21± 2
Humidity (%RH)	30-70	55±2

2. SAR Measurement System

2.1. COMOSAR System Description

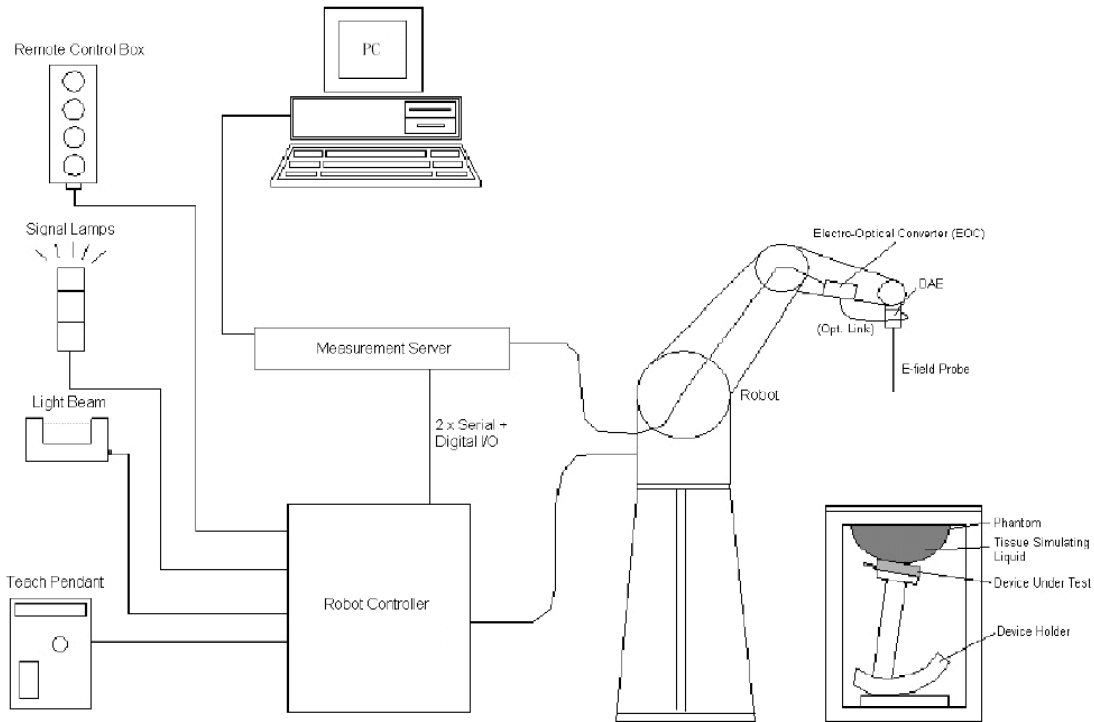

The COMOSAR system for performing compliance tests consists of the following items:

A standard high precision 6-axis robot with controller, teach pendant and software.

An arm extension for accommodating the data acquisition electronics (DAE).

A data acquisition electronics (DAE) which performs the signal amplification, signal multiplexing, AD-conversion, offset measurements, mechanical surface detection, collision detection, etc. The unit is battery powered with standard or rechargeable batteries. The signal is optically transmitted to the EOC.

The Electro-optical converter (EOC) performs the conversion from optical to electrical signals for the digital Communicate Mobile to the DAE. To use optical surface detection, a special version of the EOC is required. The EOC signal is transmitted to the measurement server.

The Light Beam used is for probe alignment. This improves the (absolute) accuracy of the probe positioning.

A computer running WinXP and the Opensar software.

Remote control and teach pendant as well as additional circuitry for robot safety such as warning lamps, etc.

The phantom, the device holder and other accessories according to the targeted measurement.

2.1.1. Applications

Predefined procedures and evaluations for automated compliance testing with all worldwide standards, e.g., IEEE 1528, OET 65, IEC 62209-1, IEC 62209-2, EN 50360, EN 50383 and others.

2.1.2. Area Scans

Area scans are defined prior to the measurement process being executed with a user defined variable spacing between each measurement point (integral) allowing low uncertainty measurements to be conducted. Scans defined for FCC applications utilize a 10mm² step integral, with 1mm interpolation used to locate the peak SAR area used for zoom scan assessments.

When an Area Scan has measured all reachable points, it computes the field maxima found in the scanned area, within a range of the global maximum. The range (in dB) is specified in the standards for compliance testing. For example, a 2 dB range is required in IEEE 1528-2003, EN 50361 and IEC 62209 standards, whereby 3 dB is a requirement when compliance is assessed in accordance with the ARIB standard (Japan).

2.1.3. Zoom Scan (Cube Scan Averaging)

Zoom Scans are used to assess the peak spatial SAR values within a cubic averaging volume containing 1 g and 10 g of simulated tissue. A density of 1000 kg/m³ is used to represent the head and body tissue density and not the phantom liquid density, in order to be consistent with the definition of the liquid dielectric properties, i.e. the side length of the 1 g cube is 10mm, with the side length of the 10 g cube 21,5mm.

The zoom scan integer steps can be user defined so as to reduce uncertainty, but normal practice for typical test applications utilize a physical step of 7x7x7 (5mmx5mmx5mm) providing a volume of 30mm in the X & Y axis, and 30mm in the Z axis.

2.1.4. Uncertainty of Inter-/Extrapolation and Averaging

In order to evaluate the uncertainty of the interpolation, extrapolation and averaged SAR calculation algorithms of the Post processor, COMOSAR allows the generation of measurement grids which are artificially predefined by analytically based test functions. Therefore, the grids of area scans and zoom scans can be filled with uncertainty test data, according to the SAR benchmark functions of IEEE 1528. The three analytical functions shown in equations as below are used to describe the possible range of the expected SAR distributions for the tested handsets. The field gradients are covered by the spatially flat distribution f1, the spatially steep distribution f3 and f2 accounts for H-field cancellation on the phantom/tissue surface.

$$f_1(x, y, z) = A e^{-\frac{z}{2a}} \cos^2 \left(\frac{\pi \sqrt{x'^2 + y'^2}}{2 \cdot 5a} \right)$$

$$f_2(x, y, z) = A e^{-\frac{z}{a}} \frac{a^2}{a^2 + x'^2} \left(3 - e^{-\frac{2z}{a}} \right) \cos^2 \left(\frac{\pi y'}{2 \cdot 3a} \right)$$

$$f_3(x, y, z) = A \frac{a^2}{\frac{a^2}{4} + x'^2 + y'^2} \left(e^{-\frac{2z}{a}} + \frac{a^2}{2(a + 2z)^2} \right)$$

2.2. COMOSAR E-Field Probe

The SAR measurement is conducted with the dissymmetric probe manufactured by SATIMO.

The probe is specially designed and calibrated for use in liquid with high permittivity. The dissymmetric probe has special calibration in liquid at different frequency.

SATIMO conducts the probe calibration in compliance with international and national standards (e.g. IEEE 1528, EN62209-1, IEC 62209, etc.) Under ISO17025. The calibration data are in Appendix D.

2.2.1. Isotropic E-Field Probe Specification

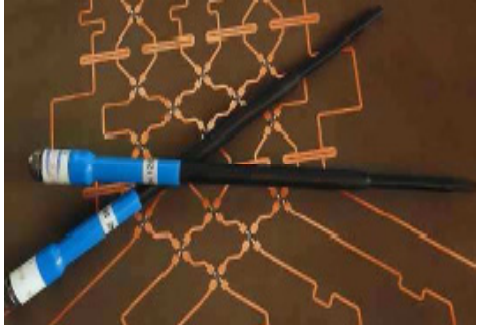
Model	EP165	
Manufacture	SATIMO	
Frequency	0.03GHz-3 GHz Linearity:±0.2dB(30 MHz-3 GHz)	
Dynamic Range	0.01W/Kg-100W/Kg Linearity:±0.2dB	
Dimensions	Overall length:330mm Length of individual dipoles:4.5mm Maximum external diameter:8mm Probe Tip external diameter:5mm Distance between dipoles/ probe extremity:2.7mm	
Application	High precision dosimetric measurements in any exposure scenario (e.g., very strong gradient fields). Only probe which enables compliance testing for frequencies up to 3 GHz with precision of better 30%.	

2.3. Robot

The COMOSAR system uses the KUKA robot from SATIMO SA (France).For the 6-axis controller COMOSAR system, the KUKA robot controller version from SATIMO is used.

The XL robot series have many features that are important for our application:

- High precision (repeatability 0.02 mm)
- High reliability (industrial design)
- Jerk-free straight movements
- Low ELF interference (the closed metallic construction shields against motor control fields)
- 6-axis controller



2.4. Video Positioning System

The video positioning system is used in OpenSAR to check the probe. Which is composed of a camera, LED, mirror and mechanical parts. The camera is piloted by the main computer with firewire link.

During the process, the actual position of the probe tip with respect to the robot arm is measured, as well as the probe length and the horizontal probe offset. The software then corrects all movements, such that the robot coordinates are valid for the probe tip.

The repeatability of this process is better than 0.1 mm. If a position has been taught with an aligned probe, the same position will be reached with another aligned probe within 0.1 mm, even if the other probe has different dimensions. During probe rotations, the probe tip will keep its actual position.

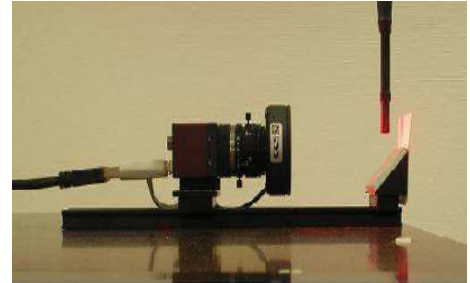

2.5. Device Holder

The COMOSAR device holder is designed to cope with different positions given in the standard. It has two scales for the device rotation (with respect to the body axis) and the device inclination (with respect to the line between the ear reference points). The rotation center for both scales is the ear reference point (EPR).

Thus the device needs no repositioning when changing the angles.

The COMOSAR device holder has been made out of low-loss POM material having the following dielectric parameters: relative permittivity $\epsilon_r = 3$ and loss tangent $\delta = 0.02$. The amount of dielectric material has been reduced in the closest vicinity of the device, since measurements have suggested that the influence of the clamp on the test results could thus be lowered.

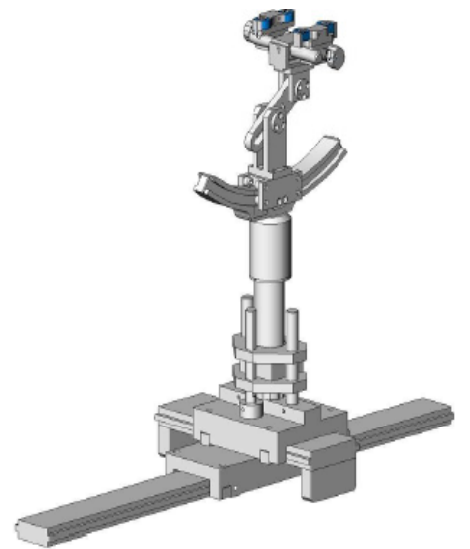

2.6. SAM Twin Phantom

The SAM twin phantom is a fiberglass shell phantom with 2mm shell thickness (except the ear region where shell thickness increases to 6mm). It has three measurement areas:

- Left head
- Right head
- Flat phantom



The bottom plate contains three pair of bolts for locking the device holder. The device holder positions are adjusted to the standard measurement positions in the three sections. A white cover is provided to tap the phantom during off-periods to prevent water evaporation and changes in the liquid parameters. On the phantom top, three reference markers are provided to identify the phantom position with respect to the robot.

3. Tissue Simulating Liquid

3.1. The composition of the tissue simulating liquid

Ingredient	850MHz	850MHz	1900MHz	1900MHz
(% Weight)	Head	Body	Head	Body
Water	40.45	52.4	54.90	40.5
Salt	1.42	1.40	0.18	0.50
Sugar	57.6	45.0	0.00	58.0
HEC	0.40	1.00	0.00	0.50
Preventol	0.10	0.20	0.00	0.50
DGBE	0.00	0.00	44.92	0.00

3.2. Tissue Calibration Result

The dielectric parameters of the liquids were verified prior to the SAR evaluation using COMOSAR Dielectric Probe Kit and R&S Network Analyzer ZVL6 .

Tissue Stimulant Measurement for GSM 850					
Frequency (MHz)	Parts	Description	Dielectric Parameters		Tissue Temp [°C]
850MHz	Head	Reference result ±5% window	ϵ_r 41.50 39.425-43.575	δ [s/m] 0.90 0.855-0.945	N/A
		Jun.28, 2013	42.16	0.94	21
850MHz	Body	Reference result ±5% window	ϵ_r 55.20 52.44-57.96	δ [s/m] 0.97 0.9215-1.0185	N/A
		Jun.28, 2013	53.62	0.96	21

Tissue Stimulant Measurement for PCS 1900					
Frequency (MHz)	Parts	Description	Dielectric Parameters		Tissue Temp [°C]
1900MHz	Head	Reference result ±5% window	ϵ_r 40.00 38.00-42.00	δ [s/m] 1.40 1.33-1.47	N/A
		Jun.28, 2013	39.84	1.39	21
1900MHz	Body	Reference result ±5% window	ϵ_r 53.30 50.635-55.965	δ [s/m] 1.52 1.444-1.596	N/A
		Jun.28, 2013	54.57	1.49	21

3.3. Tissue Dielectric Parameters for Head and Body Phantoms

The head tissue dielectric parameters recommended by the IEEE SCC-34/SC-2 in P1528 have been incorporated in the following table. These head parameters are derived from planar layer models simulating the highest expected SAR for the dielectric properties and tissue thickness variations in a human head. Other head and body tissue parameters that have not been specified in P1528 are derived from the tissue dielectric parameters computed from the 4-Cole-Cole equations described in Reference [12] and extrapolated according to the head parameters specified in P1528.

Target Frequency (MHz)	head		body	
	ϵ_r	σ (S/m)	ϵ_r	σ (S/m)
300	45.3	0.87	58.2	0.92
450	43.5	0.87	56.7	0.94
850	41.5	0.90	55.2	0.97
900	41.5	0.97	55.0	1.05
915	41.5	1.01	55.0	1.06
1450	40.5	1.20	54.0	1.30
1610	40.3	1.29	53.8	1.40
1800 – 2000	40.0	1.40	53.3	1.52
2450	39.2	1.80	52.7	1.95
3000	38.5	2.40	52.0	2.73
5800	35.3	5.27	48.2	6.00

(ϵ_r = relative permittivity, σ = conductivity and $\rho = 1000$ kg/m³)

4. SAR Measurement Procedure

4.1. SAR System Validation

4.1.1. Validation Dipoles

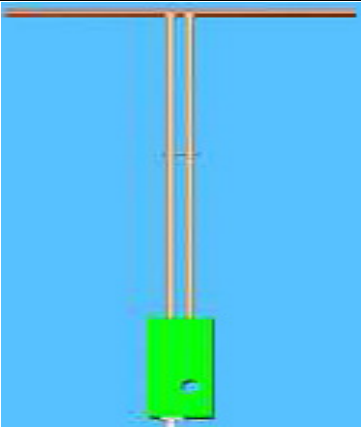
	<p>The dipoles used is based on the IEEE-1528 standard, and is complied with mechanical and electrical specifications in line with the requirements of both IEEE and FCC Supplement C. the table below provides details for the mechanical and electrical Specifications for the dipoles.</p>
---	---

Frequency	L (mm)	h (mm)	d (mm)
900 MHz	149.0	83.3	3.6
1900MHz	68	39.5	3.6

4.1.2. Validation Result

System Performance Check at 850 MHz &1900MHz for Head				
Validation Kit: SN 46/11DIP 0G900-185				
Frequency [MHz]	Description	SAR [w/kg] 1g	SAR [w/kg] 10g	Tissue Temp.[°C]
850 MHz	Reference result ± 10% window	10.9 9.81 to 11.99	6.99 6.29 to 7.69	N/A
	Jun.28, 2013	10.63	6.78	21.0
Validation Kit: SN 46/11DIP 1G900-187				
Frequency [MHz]	Description	SAR [w/kg] 1g	SAR [w/kg] 10g	Tissue Temp.[°C]
1900 MHz	Reference result ± 10% window	39.7 35.73 to 43.67	20.5 18.45 to 22.55	N/A
	Jun.28, 2013	40.37	20.79	21.0
Note: All SAR values are normalized to 1W forward power.				

4.2. SAR Measurement Procedure

The COMOSAR calculates SAR using the following equation,

$$SAR = \frac{\sigma |E|^2}{\rho}$$

σ : represents the simulated tissue conductivity

ρ : represents the tissue density

The EUT is set to transmit at the required power in line with product specification, at each frequency relating to the LOW, MID, and HIGH channel settings.

Pre-scans are made on the device to establish the location for the transmitting antenna, using a large area scan in either air or tissue simulation fluid.

The EUT is placed against the Universal Phantom where the maximum area scan dimensions are larger than the physical size of the resonating antenna. When the scan size is not large enough to cover the peak SAR distribution, it is modified by either extending the area scan size in both the X and Y directions, or the device is shifted within the predefined area.

The area scan is then run to establish the peak SAR location (interpolated resolution set at 1mm^2) which is then used to orient the center of the zoom scan. The zoom scan is then executed and the 1g and 10g averages are derived from the zoom scan volume (interpolated resolution set at 1mm^3).

When multiple peak SAR location were found during the same configuration or test mode, Zoom scan shall performed on each peak SAR location, only the peak point with maximum SAR value will be reported for the configuration or test mode.

5. SAR Exposure Limits

SAR assessments have been made in line with the requirements of IEEE-1528, FCC Supplement C, and comply with ANSI/IEEE C95.1-1992 “Uncontrolled Environments” limits. These limits apply to a location which is deemed as “Uncontrolled Environment” which can be described as a situation where the general public may be exposed to an RF source with no prior knowledge or control over their exposure.

Limits for General Population/Uncontrolled Exposure (W/kg)

Type Exposure	Uncontrolled Environment Limit
Spatial Peak SAR (1g cube tissue for brain or body)	1.60 W/kg

6. Test Equipment List

Equipment description	Manufacturer/ Model	Identification No.	Current calibration date	Next calibration date
SAR Probe	SATIMO	SN 04/13 EP165	01/31/2013	01/30/2014
Phantom	SATIMO	SN_4511_SAM90	Validated. No cal required.	Validated. No cal required.
Liquid	SATIMO	-	Validated. No cal required.	Validated. No cal required.
Comm Tester	R&S - CMU200	069Y7-158-13-712	02/28/2013	02/27/2014
Comm Tester	Agilent-8960	GB46310822	10/22/2012	10/21/2013
Multimeter	Keithley 2000	1188656	02/28/2013	02/27/2014
Dipole	SATIMO SID900	SN46/11 DIP 0G900-185	12/09/2011	12/08/2013
Dipole	SATIMO SID1900	SN46/11 DIP 1G900-187	12/09/2011	12/08/2013
Amplifier	Aethercomm	SN 046	12/08/2012	12/07/2013
Signal Generator	Agilent-E4421B	MY43351603	05/13/2013	05/12/2014
Power Probe	NRP-Z23	US38261498	02/28/2013	02/27/2014
SPECTRUM ANALYZER	Agilent	E4440A	07/18/2012	07/17/2013
Power Attenuator	BED	DLA-5W	07/18/2012	07/17/2013
Network Analyzer	Rhode & Schwarz ZVA	SN100132	02/28/2013	02/27/2014

Note: Per KDB 50824 Dipole SAR Validation Verification, AGC Lab has adopted 3 years calibration intervals. On annual basis, every measurement dipole has been evaluated and is in compliance with the following criteria:

1. There is no physical damage on the dipole;
2. System validation with specific dipole is within 10% of calibrated value;
3. Return-loss is within 20% of calibrated measurement;
4. Impedance is within 5Ω of calibrated measurement.

7. Measurement Uncertainty

SATIMO Uncertainty									
Measurement uncertainty for 30 MHz to 3 GHz averaged over 1 gram / 10 gram.									
Error Description	Sec	Tol (±%)	Prob. Dist.	Div.	(Ci) 1g	(Ci) 10g	Std. Unc. (1g) (±%)	Std. Unc. (10g)(±%)	(Vi) Veff
Measurement System									
Probe Calibration	E.2.1	6	N	1	1	1	6	6	∞
Axial Isotropy	E.2.2	3	R	$\sqrt{3}$	$(1-c_p)^{1/2}$	$(1-c_p)^{1/2}$	1.22474	1.22474	∞
Hemispherical Isotropy	E.2.2	5	R	$\sqrt{3}$	$\sqrt{c_p}$	$\sqrt{c_p}$	2.04124	2.04124	∞
Boundary Effects	E.2.3	1	R	$\sqrt{3}$	1	1	0.57735	0.57735	∞
Linearity	E.2.4	5	R	$\sqrt{3}$	1	1	2.88675	2.88675	∞
System Detection Limits	E.2.5	1	R	$\sqrt{3}$	1	1	0.57735	0.57735	∞
Readout Electronics	E.2.6	0.5	N	1	1	1	0.5	0.5	∞
Response Time	E.2.7	0.2	R	$\sqrt{3}$	1	1	0.11547	0.11547	∞
Integration Time	E.2.8	2	R	$\sqrt{3}$	1	1	1.1547	1.1547	∞
RF Ambient Noise	E.6.1	3	R	$\sqrt{3}$	1	1	1.73205	1.73205	∞
Probe Positioner Mechanical Tolerance	E.6.2	2	R	$\sqrt{3}$	1	1	1.1547	1.1547	∞
Probe Positioning with Respect to Phantom Shell	E.6..3	1	R	$\sqrt{3}$	1	1	0.57735	0.57735	∞
Extrapolation,interpolation and Integration Algorithms for Max. SAR Evaluation	E.5.2	1.5	R	$\sqrt{3}$	1	1	0.86603	0.86603	∞
Dipole									
Device Positioning	8,E.4.2	1	N	$\sqrt{3}$	1	1	0.57735	0.57735	N-1
Power Drift	8.6.6.2	2	R	$\sqrt{3}$	1	1	1.1547	1.1547	∞
Phantom and Tissue Parameters									
Phantom Uncertainty	E.3.1	4	R	$\sqrt{3}$	1	1	2.3094	2.3094	∞
Liquid Conductivity (target)	E.3.2	5	R	$\sqrt{3}$	0.64	0.43	1.84752	1.2413	∞
Liquid Conductivity (meas.)	E.3.3	2.5	N	1	0.64	0.43	1.6	1.075	∞
Liquid Permittivity (target)	E.3.2	3	R	$\sqrt{3}$	0.6	0.49	1.03923	0.8487	∞
Liquid Permittivity (meas.)	E.3.3	2.5	N	1	0.6	0.49	1.5	1.225	M
Combined Standard Uncertainty			RSS				8.09272	7.9296	
Expanded Uncertainty (95%CONFIDENCE INTERVAL)			k				16.18544	15.8592	

8. Conducted Power Measurement

Mode	Frequency(MHz)	Peak Power(dBm)	Avg. Burst Power(dBm)	Duty cycle Factor(dBm)	Frame Power(dBm)
Maximum Power <1>					
GSM 850	824.2	32.47	31.50	-9	22.50
	836.6	32.42	31.36	-9	22.36
	848.8	32.37	31.42	-9	22.42
GPRS 850 (1 Slot)	824.2	32.42	31.16	-9	22.16
	836.6	32.38	31.07	-9	22.07
	848.8	32.35	31.06	-9	22.06
GPRS 850 (2 Slot)	824.2	29.55	28.43	-6	22.43
	836.6	29.52	28.43	-6	22.43
	848.8	29.46	28.35	-6	22.35
GPRS 850 (3 Slot)	824.2	27.42	26.41	-4.26	22.15
	836.6	27.37	26.42	-4.26	22.16
	848.8	27.35	26.36	-4.26	22.10
GPRS 850 (4 Slot)	824.2	26.54	25.43	-3	22.43
	836.6	26.53	25.38	-3	22.38
	848.8	26.45	25.35	-3	22.35
PCS1900	1850.2	29.49	28.43	-9	19.43
	1880	29.44	28.37	-9	19.37
	1909.8	29.37	28.29	-9	19.29
GPRS1900 (1 Slot)	1850.2	29.44	28.22	-9	19.22
	1880	29.42	28.18	-9	19.18
	1909.8	29.31	28.15	-9	19.15
GPRS1900 (2 Slot)	1850.2	26.37	25.36	-6	19.36
	1880	26.33	25.35	-6	19.35
	1909.8	26.28	25.30	-6	19.30
GPRS1900 (3 Slot)	1850.2	25.12	24.23	-4.26	19.97
	1880	25.08	24.19	-4.26	19.93
	1909.8	25.05	24.16	-4.26	19.90
GPRS1900 (4 Slot)	1850.2	23.52	22.37	-3	19.37
	1880	23.46	22.35	-3	19.35
	1909.8	23.45	22.33	-3	19.33
Maximum Power <2>					
GSM 850	824.2	32.37	31.42	-9	22.42
PCS1900	1850.2	29.44	28.35	-9	19.35

Note 1:

The Frame Power (Source-based time-averaged Power) is scaled the maximum burst average power based on time slots. The calculated methods are show as following:

Frame Power = Max burst power (1 Up Slot) – 9 dB

Frame Power = Max burst power (2 Up Slot) – 6 dB

Frame Power = Max burst power (3 Up Slot) -4.26dB

Frame Power = Max burst power (4 Up Slot) – 3 dB

9. Test Results

9.1. SAR Test Results Summary

9.1.1. Test position and configuration

Head SAR was performed with the device configured in the positions according to IEEE1528, and Body SAR was performed with the device 5mm from the phantom. Body SAR was also performed with the headset attached and without.

9.1.2. Operation Mode

- According to KDB 447498 D01 v05r01 ,for each exposure position, if the highest 1-g SAR is ≤ 0.8 W/kg, testing for low and high channel is optional.
- Per KDB 865664 D01 v01r01,for each frequency band, if the measured SAR is ≥ 0.8 W/Kg, testing for repeated SAR measurement is required .
- Body-worn exposure conditions are intended to voice call operations, therefore GSM voice call mode is selected to be test.

9.1.3. Test Result

SAR MEASUREMENT								
Ambient Temperature (°C) : 21 ± 2						Relative Humidity (%): 55		
Liquid Temperature (°C) : 21 ± 2						Depth of Liquid (cm):>15		
Product: Glow Mobile Phone								
Test Mode: GSM850 with GMSK modulation								
Configuration			Antenna Position	Frequency		Power Drift ($\pm 5\%$)	SAR (1g) (W/kg)	Limit (W/kg)
SIM	Position	Status		channel	MHz			
<1>	Left Head	Cheek	Fixed	128	824.2	--	--	--
				190	836.6	-2.24	0.366	1.6
				251	848.8	--	--	--
		Tilted	Fixed	128	824.2	--	--	--
				190	836.6	1.41	0.349	1.6
				251	848.8	--	--	--
	Right Head	Cheek	Fixed	128	824.2	--	--	--
				190	836.6	-0.35	0.385	1.6
				251	848.8	--	--	--
		Tilted	Fixed	128	824.2	--	--	--
				190	836.6	-2.54	0.346	1.6
				251	848.8	--	--	--
<2>	Right	Cheek	Fixed	190	836.6	0.24	0.373	1.6

Note: when the 1-g SAR is ≤ 0.8 W/kg, testing for low and high channel is optional. refer to KDB 941225.

SAR MEASUREMENT								
Ambient Temperature (°C) : 21 ± 2						Relative Humidity (%): 55		
Liquid Temperature (°C) : 21 ± 2						Depth of Liquid (cm):>15		
Product: Glow Mobile Phone								
Test Mode: GSM850 with GMSK modulation								
Configuration			Antenna Position	Frequency		Power Drift (<±5%)	SAR (1g) (W/kg)	Limit (W/kg)
SIM	Position	Status		channel	MHz			
<1>	Body back	MS	Fixed	128	824.2	--	--	--
				190	836.6	-0.25	0.706	1.6
				251	848.8	--	--	--
		GPRS 2 TS	Fixed	128	824.2	--	--	--
				190	836.6	-1.42	0.482	1.6
				251	848.8	--	--	--
		GPRS 3 TS	Fixed	128	824.2	--	--	--
				190	836.6	0.63	0.500	1.6
				251	848.8	--	--	--
		GPRS 4 TS	Fixed	128	824.2	--	--	--
				190	836.6	-1.34	0.474	1.6
				251	848.8	--	--	--
	Body Front	MS	Fixed	128	824.2	--	--	--
				190	836.6	0.87	0.382	1.6
				251	848.8	--	--	--
	Body back	MS with Earphone	Fixed	128	824.2	--	--	--
				190	836.6	-0.34	0.511	1.6
				251	848.8	--	--	--

Note: when the 1-g SAR is ≤ 0.8 W/kg, testing for low and high channel is optional. refer to KDB 941225.

SAR MEASUREMENT								
Ambient Temperature (°C) : 21 ± 2						Relative Humidity (%): 55		
Liquid Temperature (°C) : 21 ± 2						Depth of Liquid (cm):>15		
Product: Glow Mobile Phone								
Test Mode: PCS1900 with GMSK modulation								
Configuration			Antenna Position	Frequency		Power Drift (<±5%)	SAR (1g) (W/kg)	Limit (W/kg)
SIM	Position	Status		channel	MHz			
<1>	Left Head	Cheek	Fixed	512	1850.2	0.63	0.616	1.6
				661	1880.0	-1.14	0.857	1.6
				810	1909.8	0.33	0.563	1.6
		Tilted	Fixed	512	1850.2	--	--	--
				661	1880.0	-0.36	0.111	1.6
				810	1909.8	--	--	--
	Right Head	Cheek	Fixed	512	1850.2	--	--	--
				661	1880.0	-1.84	0.430	1.6
				810	1909.8	--	--	--
		Tilted	Fixed	512	1850.2	--	--	--
				661	1880.0	-0.16	0.415	1.6
				810	1909.8	--	--	--
<2>	Left	Cheek	Fixed	661	1880.0	-1.76	0.831	1.6

Note: when the 1-g SAR is ≤ 0.8 W/kg, testing for low and high channel is optional. refer to KDB 941225.

SAR MEASUREMENT								
Ambient Temperature (°C) : 21 ± 2						Relative Humidity (%): 55		
Liquid Temperature (°C) : 21 ± 2						Depth of Liquid (cm):>15		
Product: Glow Mobile Phone								
Test Mode: PCS1900 with GMSK modulation								
Configuration			Antenna Position	Frequency		Power Drift (<±5%)	SAR (1g) (W/kg)	Limit (W/kg)
SIM	Position	Status		channel	MHz			
<1>	Body Back	MS	Fixed	512	1850.2	--	--	--
				661	1880.0	0.63	0.299	1.6
				810	1909.8	--	--	--
		GPRS 2 TS	Fixed	512	1850.2	--	--	--
				661	1880.0	1.24	0.189	1.6
				810	1909.8	--	--	--
		GPRS 3 TS	Fixed	512	1850.2	--	--	--
				661	1880.0	0.64	0.184	1.6
				810	1909.8	--	--	--
		GPRS 4 TS	Fixed	512	1850.2	--	--	--
				661	1880.0	1.36	0.174	1.6
				810	1909.8	--	--	--
	Body front	MS	Fixed	512	1850.2	--	--	--
				661	1880.0	1.97	0.183	1.6
				810	1909.8	--	--	--
	Body Back	MS with Earphone	Fixed	512	1850.2	--	--	--
				661	1880.0	0.34	0.287	1.6
				810	1909.8	--	--	--

Note: when the 1-g SAR is ≤ 0.8 W/kg, testing for low and high channel is optional. refer to KDB 941225.

Repeated SAR								
Ambient Temperature (°C) : 21 ± 2						Relative Humidity (%): 55		
Liquid Temperature (°C) : 21 ± 2						Depth of Liquid (cm):>15		
Product: Glow Mobile Phone								
Test Mode: PCS1900 with GMSK modulation								
Configuration			Antenna Position	Frequency		Power Drift (<±5%)	SAR (1g) (W/kg)	Limit (W/kg)
SIM	Position	Status		channel	MHz			
<1>	Left Head	Cheek	Fixed	512	1850.2	--	--	--
				661	1880.0	-0.26	0.832	1.6
				810	1909.8	--	--	--
<2>	Left	Cheek	Fixed	661	1880.0	-0.62	0.801	1.6
NOTE: DUE TO THE maximum SAR is <1.45W/Kg, there is only test once repeated SAR.								

Simultaneous Multi-band Transmission Evaluation:
Application Simultaneous Transmission information:

Position	Simultaneous state
Head	1.WWAN(voice)+WLAN 2.4GHz band
	2.WWAN(voice)+Bluetooth
Body	4. WWAN(voice)+WLAN 2.4GHz band
	5. WWAN(voice)+Bluetooth

NOTE:

1. WLAN and BT share the same antenna, and cannot transmit simultaneously.
2. Simultaneous with every transmitter must be the same test position.
3. Based upon KDB 447498 D01 v05, BT SAR is excluded as below table.
4. Based upon KDB 447498 D01 v05,for handsets the test separation distance is determined by the smallest distance between the outer surface of the device and the user; which is 0mm for head SAR AND 5mm for body-worn SAR.
5. If the test separation distance is <5mm, 5mm is used for excluded SAR calculation.
6. For minimum test separation distance $\leq 50\text{mm}$,Bluetooth standalone SAR is excluded according to $[(\text{max. power of channel, including tune-up tolerance, mW}) / (\text{min. test separation distance, mm}) \cdot \sqrt{f \text{ (GHz)}} / x] \leq 3.0$ for 1-g SAR and ≤ 7.5 for 10-g extremity SAR
7. KDB 447498 / 4.3.2 (2) when standalone SAR test exclusion applies to an antenna that transmits simultaneously with other antennas, the standalone SAR must be estimated according to following to determine simultaneous transmission SAR test exclusion:
 - a) $(\text{max. power of channel, including tune-up tolerance, mW}) / (\text{min. test separation distance, mm}) \cdot \sqrt{f \text{ (GHz)}} / x$ W/kg for test separation distances ≤ 50 mm; Where $x = 7.5$ for 1-g SAR, and $x = 18.75$ for 10-g SAR.
 - b) 0.4W/Kg for 1-g SAR and 1.0W/Kg for 10-g SAR, when the separation distance is >50mm.

		Maximum Average Power		Antenna to user (mm)	SAR exclusion threshold (mW)	SAR testing required (Yes/No)	Head (0mm gap)	Body (5mm gap)
		dBm	mW					
BT	Head	2.27	2.270	5	10	NO	0.3210 W/kg	0.3210 W/kg
	Body			5	10	NO		
WIFI	Head	9.96	9.908	5	10	NO	0.4100 W/kg	0.4100 W/kg
	Body			5	10	NO		

Maximum test results (WWAN) with BT and WIFI Simultaneous Transmission SAR:

BT: Head (0 cm gap): 0.3210 W/kg and Body (0.5 cm gap): 0.3210 W/kg
WIFI: Head (0 cm gap): 0.4100 W/kg and Body (0.5 cm gap): 0.4100 W/kg

Head (WWAN (voice) +BT): $0.857 \text{ W/kg} + 0.3210 \text{ W/kg} = 1.178 \text{ W/kg}$
Body (WWAN (voice) +BT): $0.706 \text{ W/kg} + 0.3210 \text{ W/kg} = 1.027 \text{ W/kg}$
Head (WWAN (voice) +WLAN): $0.857 \text{ W/kg} + 0.4100 \text{ W/kg} = 1.267 \text{ W/kg}$
Body (WWAN (voice) +WLAN): $0.706 \text{ W/kg} + 0.4100 \text{ W/kg} = 1.116 \text{ W/kg}$

Appendix A. SAR System Validation Data

Test Laboratory: AGC Lab

Date: Jun.28, 2013

System Check Head 850 MHz

DUT: Dipole 900 MHz Type: SID 900

Communication System CW; Communication System Band: D850 (850.0 MHz); Duty Cycle: 1:1; Conv.F=5.30

Frequency: 850 MHz; Medium parameters used: $f = 850$ MHz; $\sigma=0.94$ mho/m; $\epsilon_r = 42.16$; $\rho = 1000$ kg/m³ ;

Phantom section: Flat Section; Input Power=10dBm

Ambient temperature (°C): 21, Liquid temperature (°C): 21

SATIMO Configuration:

Probe: EP165; Calibrated: 01/31/2013

- Sensor-Surface: 4mm (Mechanical Surface Detection)
- Phantom: Flat Phantom; Type: Elliptical Phantom
- Measurement SW: OpenSAR V4_02_01

Configuration/System Check GSM 850 Head/Area Scan: Measurement grid: dx=8mm,dy=8mm

Configuration/System Check GSM 850 Head/Zoom Scan: Measurement grid: dx=8mm, dy=8mm, dz=5mm

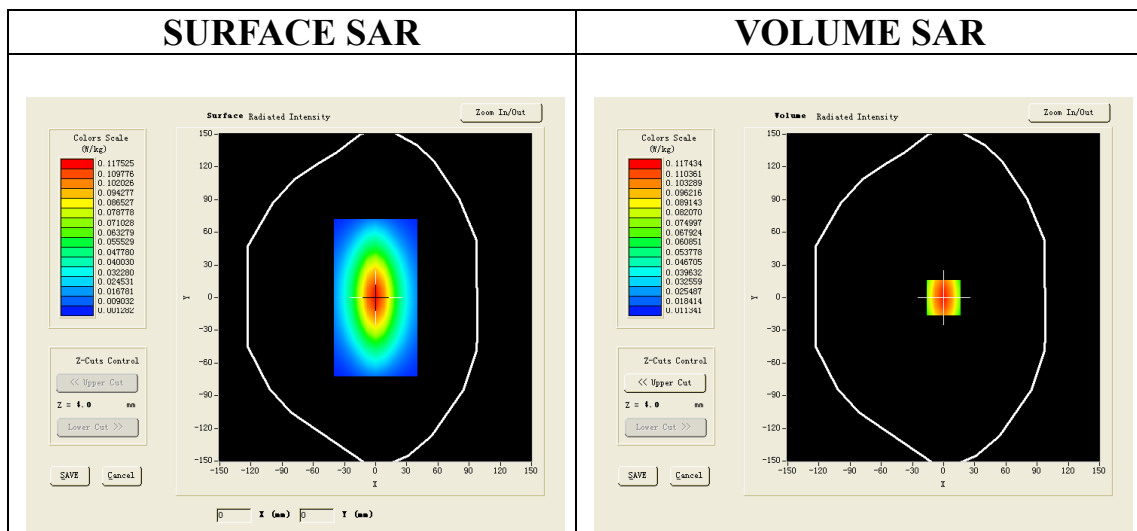

Maximum location: X=0.00, Y=0.00

SAR 10g (W/Kg)	0.067845
SAR 1g (W/Kg)	0.106348

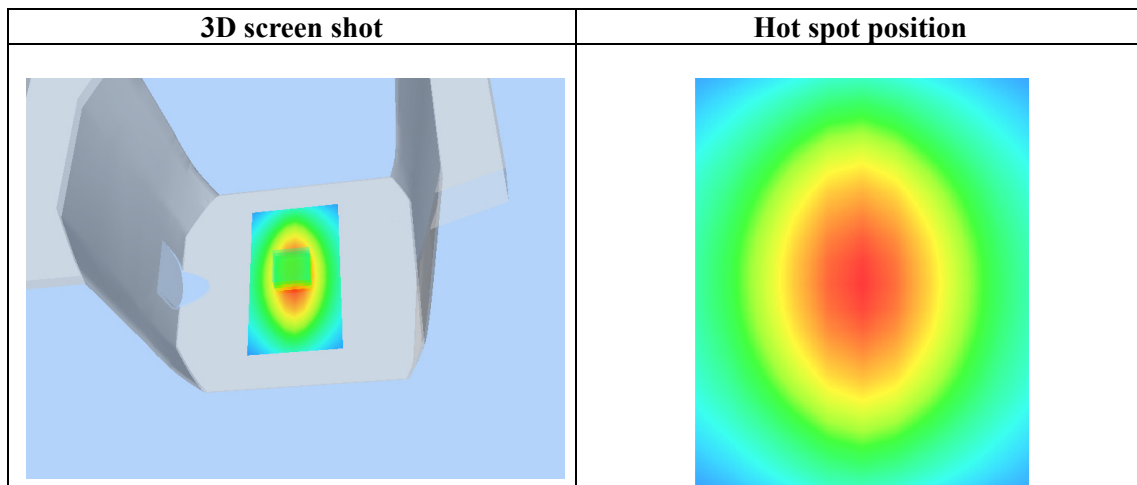
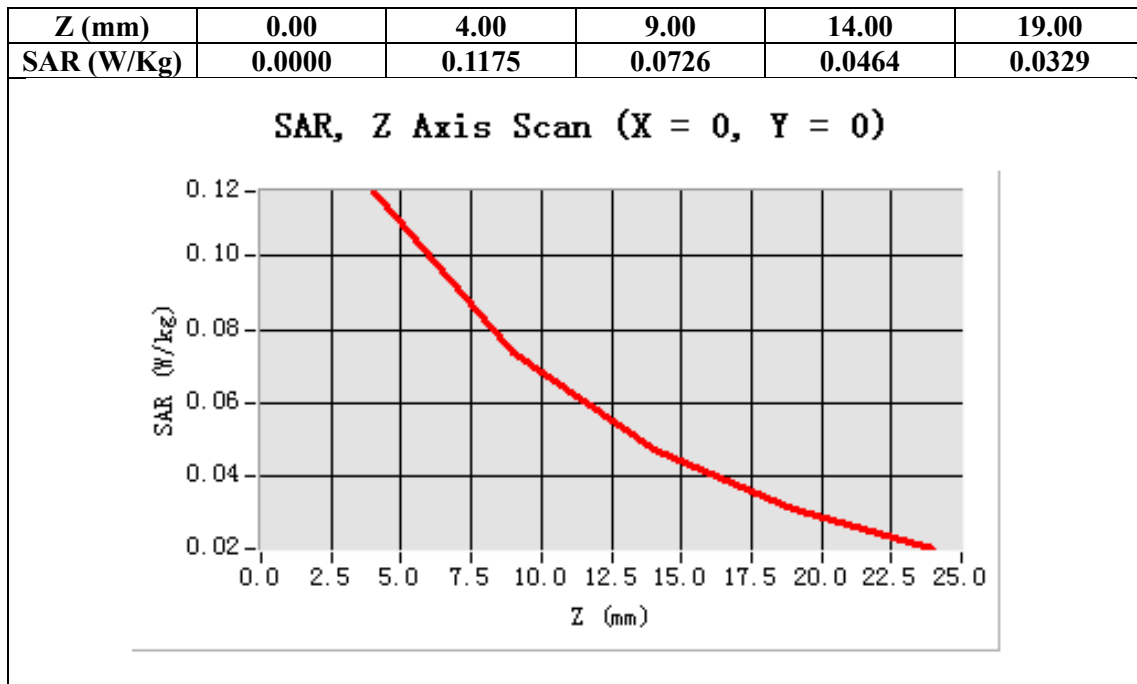

Test Laboratory: AGC Lab
System Check Head 1900MHz

Date: Jun.28, 2013

DUT: Dipole 1900 MHz; Type: SID 1900

Communication System: CW; Communication System Band: D1900 (1900.0 MHz); Duty Cycle:1:1; Conv.F=4.72
Frequency: 1900 MHz; Medium parameters used: $f = 1900$ MHz; $\sigma = 1.39$ mho/m; $\epsilon_r = 39.84$; $\rho = 1000$ kg/m³ ;
Phantom section: Flat Section; Input Power=10dBm
Ambient temperature (°C): 21, Liquid temperature (°C): 21

SATIMO Configuration:

Probe: EP165; Calibrated: 01/31/2013

- Sensor-Surface: 4mm (Mechanical Surface Detection)
- Phantom: Flat Phantom; Type: Elliptical Phantom
- Measurement SW: OpenSAR V4_02_01

Configuration/System Check PCS1900 Head/Area Scan: Measurement grid: dx=8mm, dy=8mm

Configuration/System Check PCS1900 Head/Zoom Scan: Measurement grid: dx=8mm, dy=8mm, dz=5mm

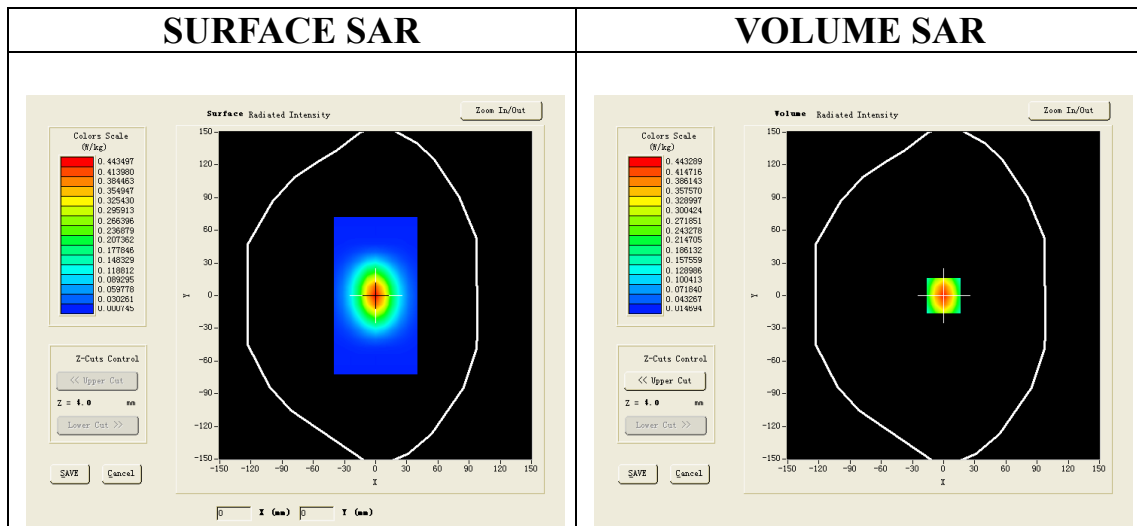

Maximum location: X=0.00, Y=0.00

SAR 10g (W/Kg)	0.207854
SAR 1g (W/Kg)	0.403697

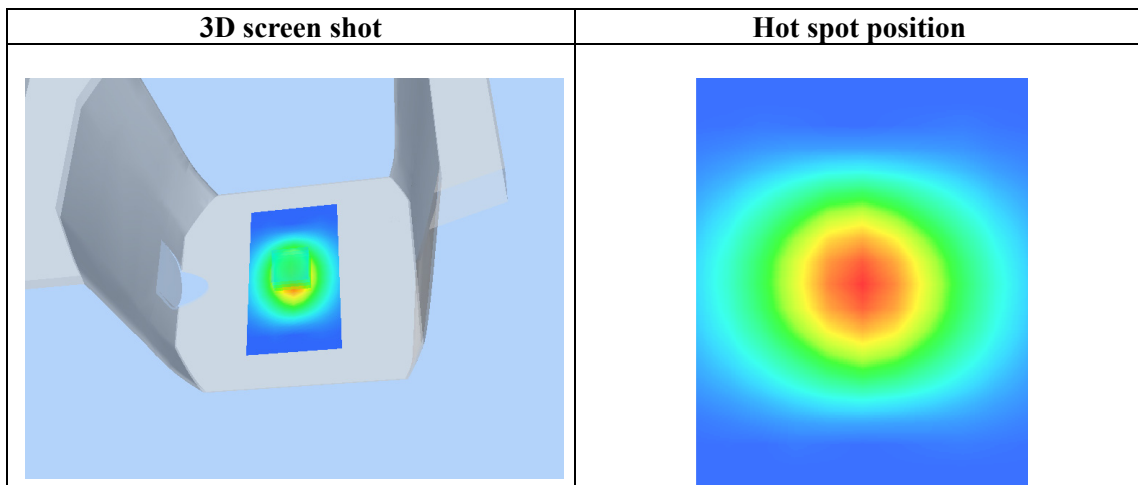
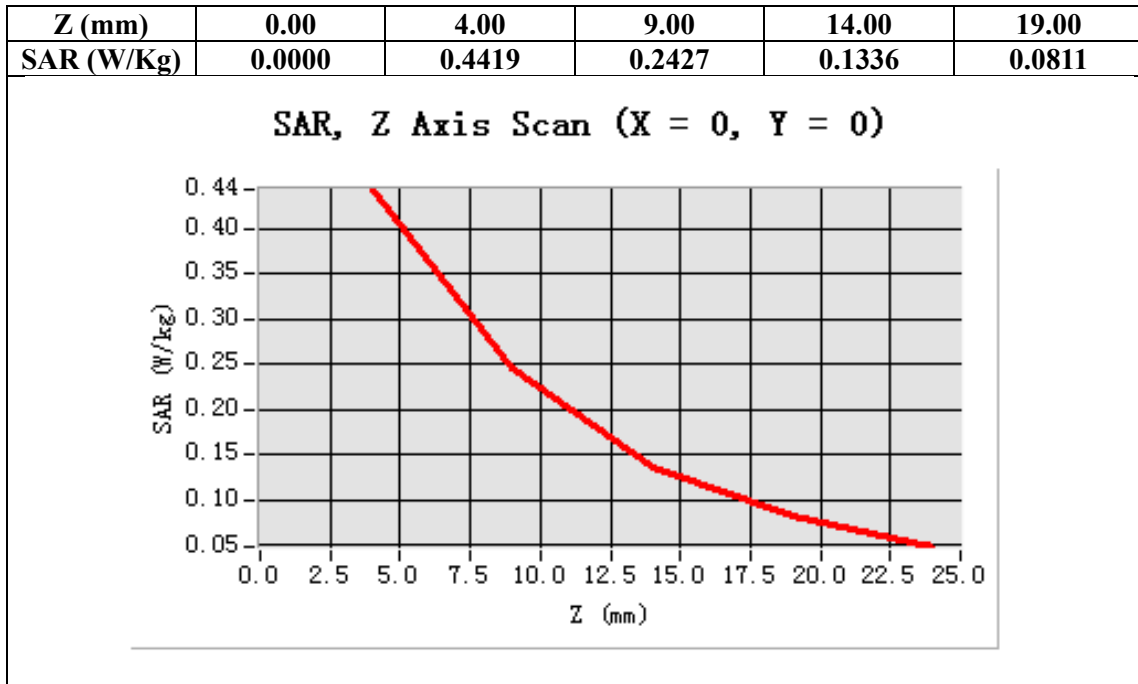

Appendix B. SAR measurement Data

Test Laboratory: AGC Lab
GSM 850 Mid-Touch-Left <SIM 1>

Date: Jun.28, 2013

DUT: Glow Mobile Phone; Type: X200

Communication System: Generic GSM; Communication System Band: GSM 850; Duty Cycle: 1:8.3; Conv.F=5.30
Frequency: 836.6 MHz; Medium parameters used: $f = 850$ MHz; $\sigma=0.94$ mho/m; $\epsilon_r = 42.16$; $\rho = 1000$ kg/m³ ;
Phantom section: Left Section
Ambient temperature (°C): 21.0, Liquid temperature (°C): 21.0

SATIMO Configuration:

Probe: EP165; Calibrated: 01/31/2013

- Sensor-Surface: 4mm (Mechanical Surface Detection)
- Phantom: Flat Phantom; Type: Elliptical Phantom
- Measurement SW: OpenSAR V4_02_01

Configuration/GSM 850 Mid-Touch-Left/Area Scan (6x8x1): Measurement grid: dx=20mm, dy=20mm
Configuration/GSM 850 Mid-Touch-Left/Zoom Scan (5x5x7)/Cube 0: Measurement grid: dx=8mm, dy=8mm, dz=5mm

Area Scan	sam_direct_droit2_surf8mm.txt
ZoomScan	5x5x7,dx=8mm dy=8mm dz=5mm,Very fast
Phantom	Left head
Device Position	Cheek
Band	GSM 850
Channels	Middle
Signal	TDMA (Crest factor: 8.0)

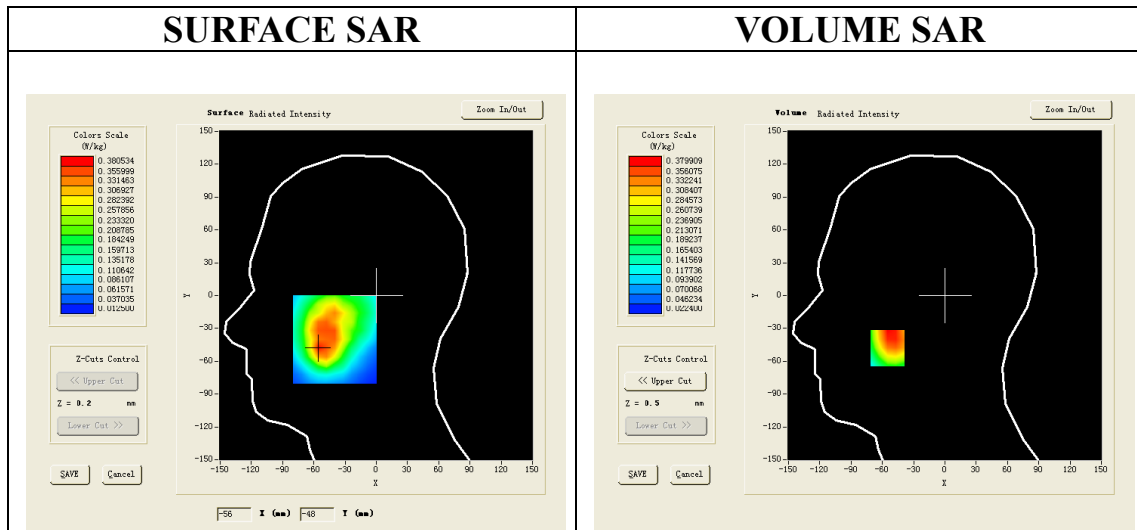

Maximum location: X=-55.00, Y=-48.00

SAR 10g (W/Kg)	0.234647
SAR 1g (W/Kg)	0.366068

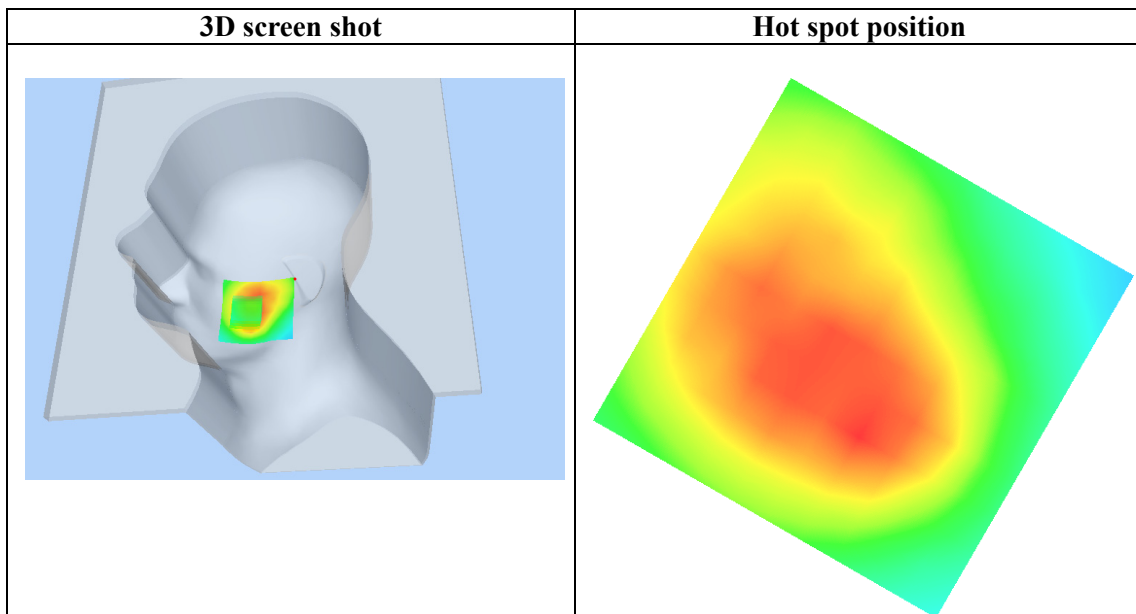
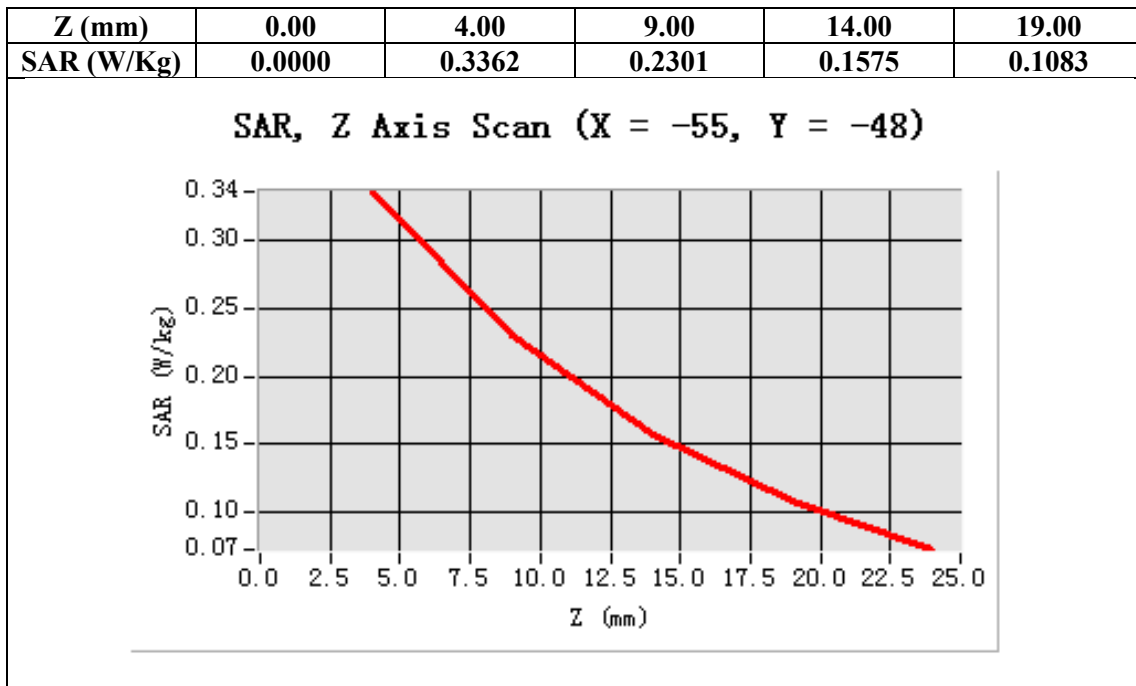

Test Laboratory: AGC Lab
GSM 850 Mid-Tilt-Left <SIM 1>
DUT: Glow Mobile Phone; Type: X200

Date: Jun.28, 2013

Communication System: Generic GSM; Communication System Band: GSM 850; Duty Cycle: 1:8.3; Conv.F=5.30;
Frequency: 836.6 MHz; Medium parameters used: $f = 850$ MHz; $\sigma = 0.94$ mho/m; $\epsilon_r = 42.16$; $\rho = 1000$ kg/m³ ;
Phantom section: Left Section
Ambient temperature (°C): 21.0, Liquid temperature(°C): 21.0

SATIMO Configuration:

Probe: EP165; Calibrated: 01/31/2013

- Sensor-Surface: 4mm (Mechanical Surface Detection)
- Phantom: Flat Phantom; Type: Elliptical Phantom
- Measurement SW: OpenSAR V4_02_01

Configuration/GSM 850 Mid-Tilt-Left/Area Scan (6x8x1): Measurement grid: dx=20mm, dy=20mm

Configuration/GSM 850 Mid-Tilt-Left/Zoom Scan (5x5x7)/Cube 0: Measurement grid: dx=8mm, dy=8mm,dz=5mm;

Area Scan	sam_direct_droit2_surf8mm.txt
ZoomScan	5x5x7,dx=8mm dy=8mm dz=5mm,Very fast
Phantom	Left head
Device Position	Tilt
Band	GSM 850
Channels	Middle
Signal	TDMA (Crest factor: 8.0)

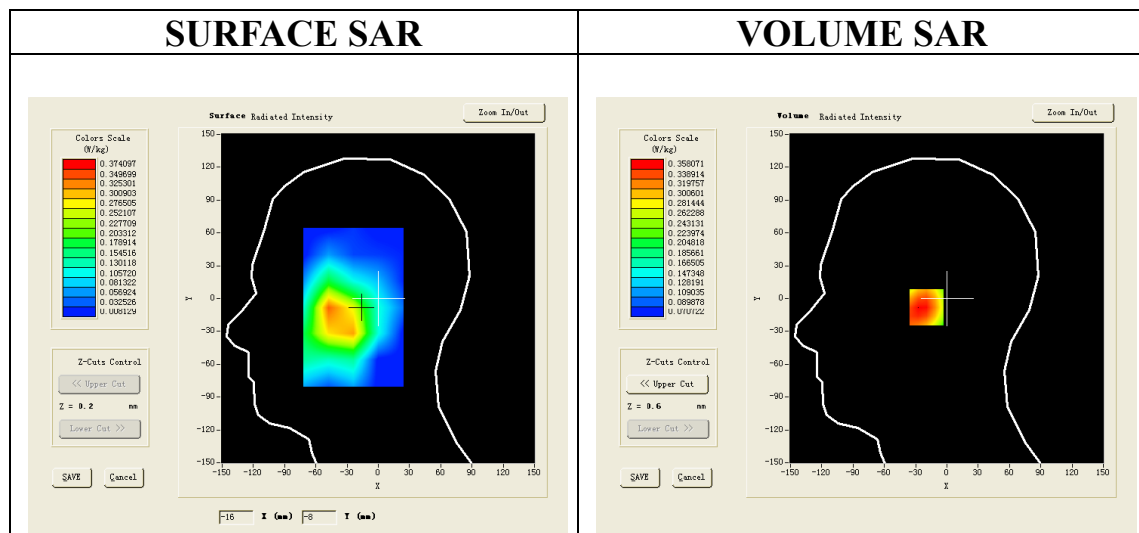

Maximum location: X=-16.00, Y=-8.00

SAR 10g (W/Kg)	0.256116
SAR 1g (W/Kg)	0.349093

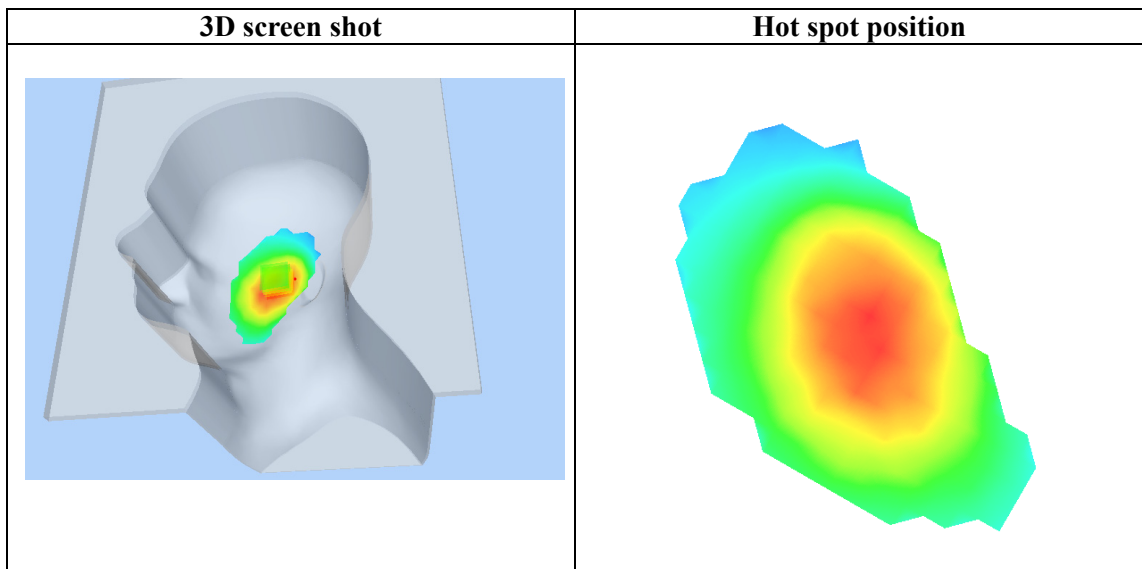
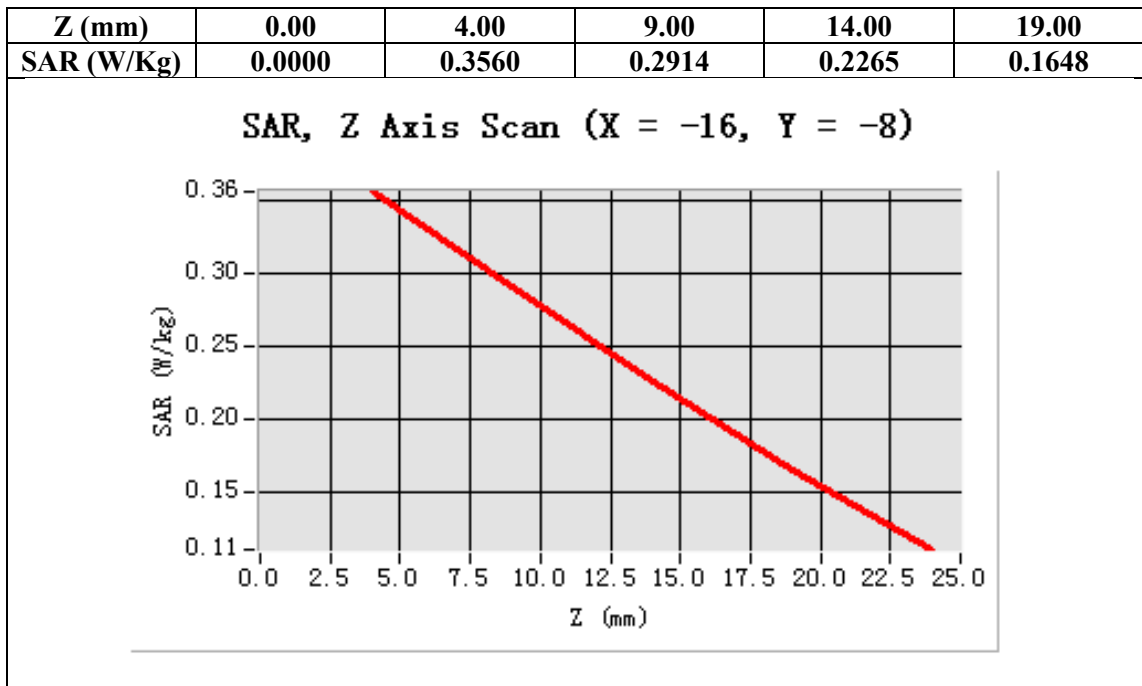

Test Laboratory: AGC Lab
GSM 850 Mid- Touch-Right <SIM 1>
DUT: Glow Mobile Phone; Type: X200

Date: Jun.28, 2013

Communication System: Generic GSM; Communication System Band: GSM 850; Duty Cycle: 1:8.3; Conv.F=5.30;
Frequency: 836.6 MHz; Medium parameters used: $f = 850$ MHz; $\sigma = 0.94$ mho/m; $\epsilon_r = 42.16$; $\rho = 1000$ kg/m³ ;
Phantom section: Right Section
Ambient temperature (°C): 21.0, Liquid temperature (°C): 21.0

SATIMO Configuration:

Probe: EP165; Calibrated: 01/31/2013

- Sensor-Surface: 4mm (Mechanical Surface Detection)
- Phantom: Flat Phantom; Type: Elliptical Phantom
- Measurement SW: OpenSAR V4_02_01

Configuration/GSM 850 Mid-Touch-Right/Area Scan: Measurement grid: dx=20mm, dy=20mm

Configuration/GSM 850 Mid-Touch-Right/Zoom Scan: Measurement grid: dx=8mm, dy=8mm, dz=5mm;

Area Scan	sam_direct_droit2_surf8mm.txt
ZoomScan	5x5x7,dx=8mm dy=8mm dz=5mm,Very fast
Phantom	Right head
Device Position	Cheek
Band	GSM 850
Channels	Middle
Signal	TDMA (Crest factor: 8.0)

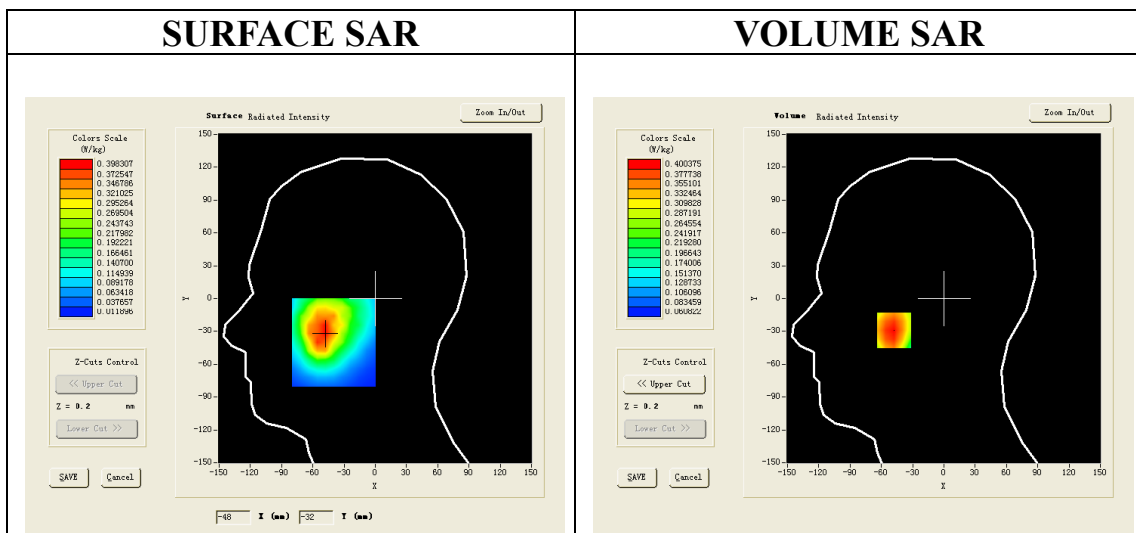

Maximum location: X=-48.00, Y=-29.00

SAR 10g (W/Kg)	0.269871
SAR 1g (W/Kg)	0.385354

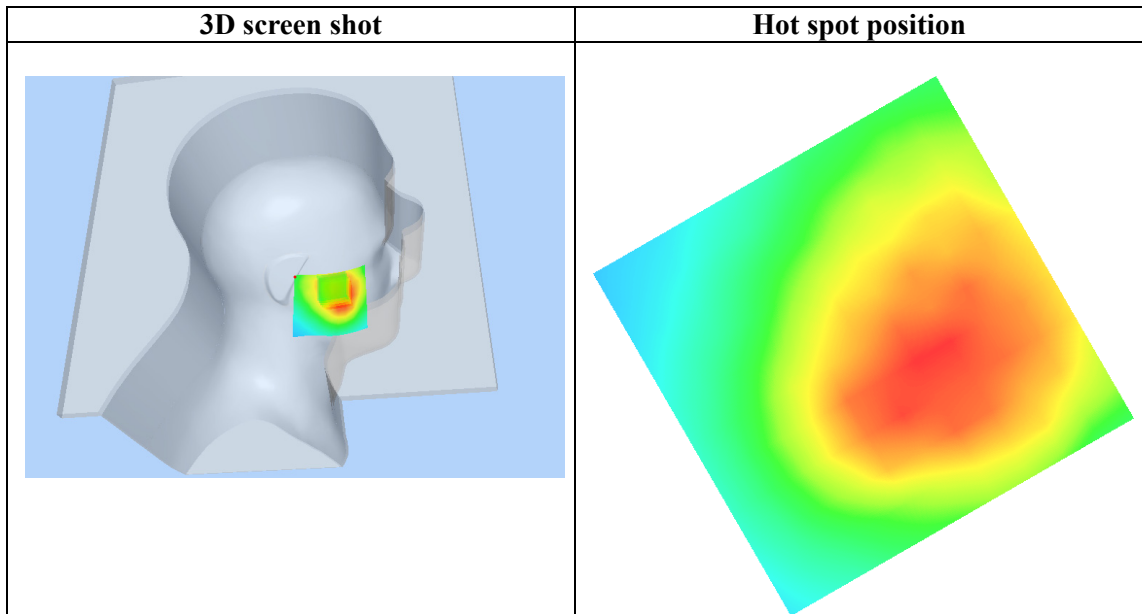
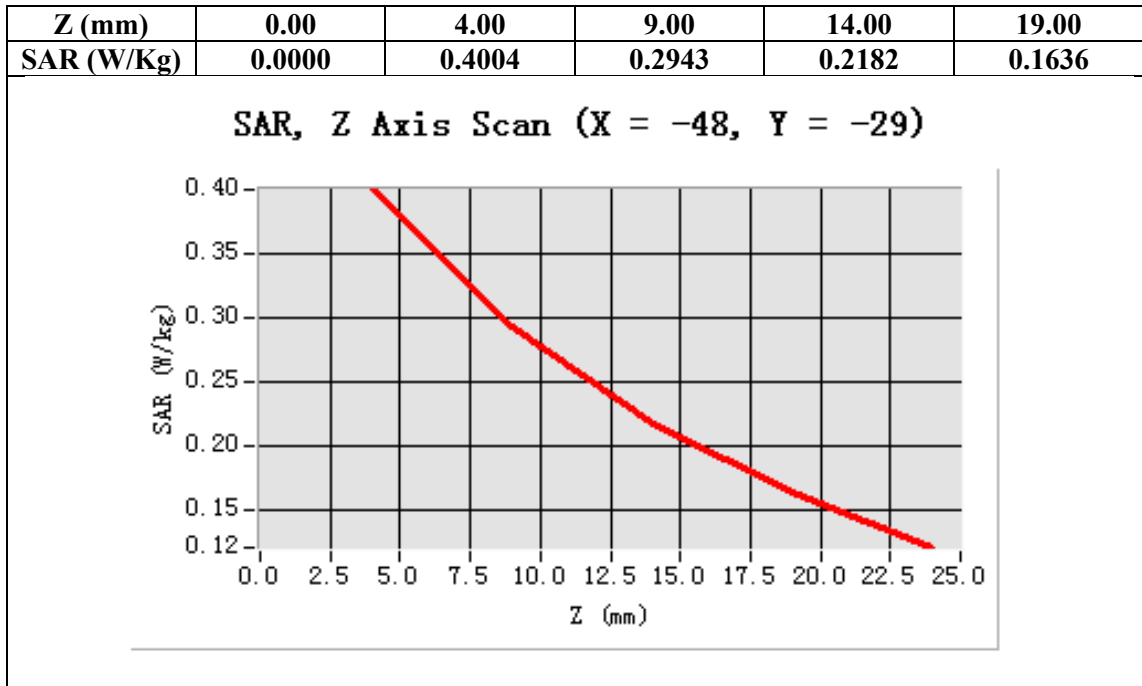

Test Laboratory: AGC Lab
GSM 850 Mid-Tilt-Right <SIM 1>
DUT: Glow Mobile Phone; Type: X200

Date: Jun.28, 2013

Communication System: Generic GSM; Communication System Band: GSM 850; Duty Cycle: 1:8.3; Conv.F=5.30;
Frequency: 836.6 MHz; Medium parameters used: $f = 850$ MHz; $\sigma = 0.94$ mho/m; $\epsilon_r = 42.16$; $\rho = 1000$ kg/m³ ;
Phantom section: Right Section
Ambient temperature (°C): 21.0, Liquid temperature (°C): 21.0

SATIMO Configuration:

Probe: EP165; Calibrated: 01/31/2013

- Sensor-Surface: 4mm (Mechanical Surface Detection)
- Phantom: Flat Phantom; Type: Elliptical Phantom
- Measurement SW: OpenSAR V4_02_01

Configuration/GSM 850 Mid-Tilt-Right/Area Scan: Measurement grid: dx=20mm, dy=20mm

Configuration/GSM 850 Mid-Tilt-Right/Zoom Scan: Measurement grid: dx=8mm, dy=8mm, dz=5mm;

Area Scan	sam_direct_droit2_surf8mm.txt
Zoom Scan	5x5x7,dx=8mm dy=8mm dz=5mm,Very fast
Phantom	Right head
Device Position	Tilt
Band	GSM 850
Channels	Middle
Signal	TDMA (Crest factor: 8.0)

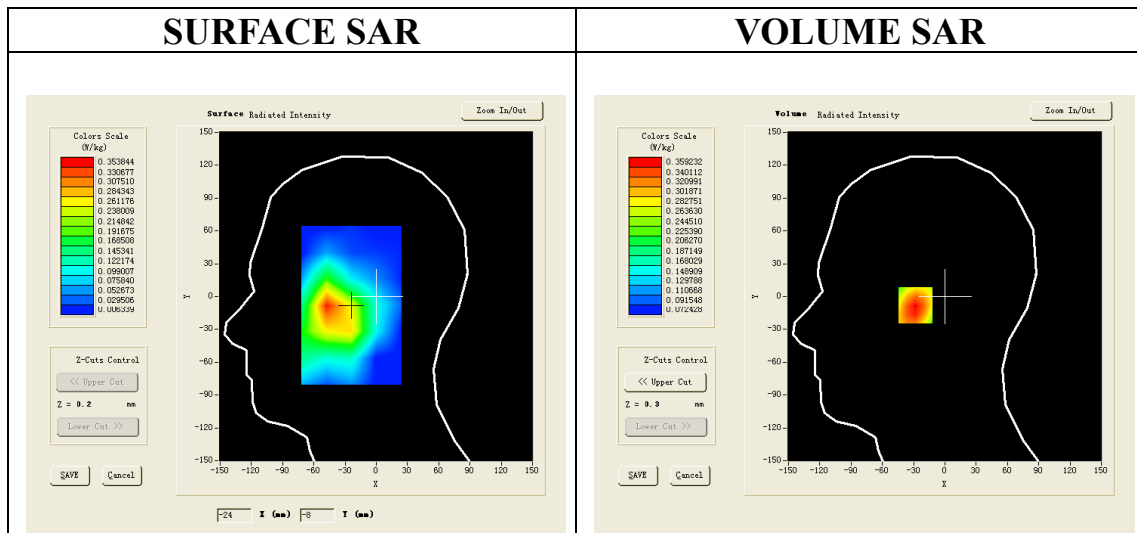

Maximum location: X=-25.00, Y=-8.00

SAR 10g (W/Kg)	0.241670
SAR 1g (W/Kg)	0.345811

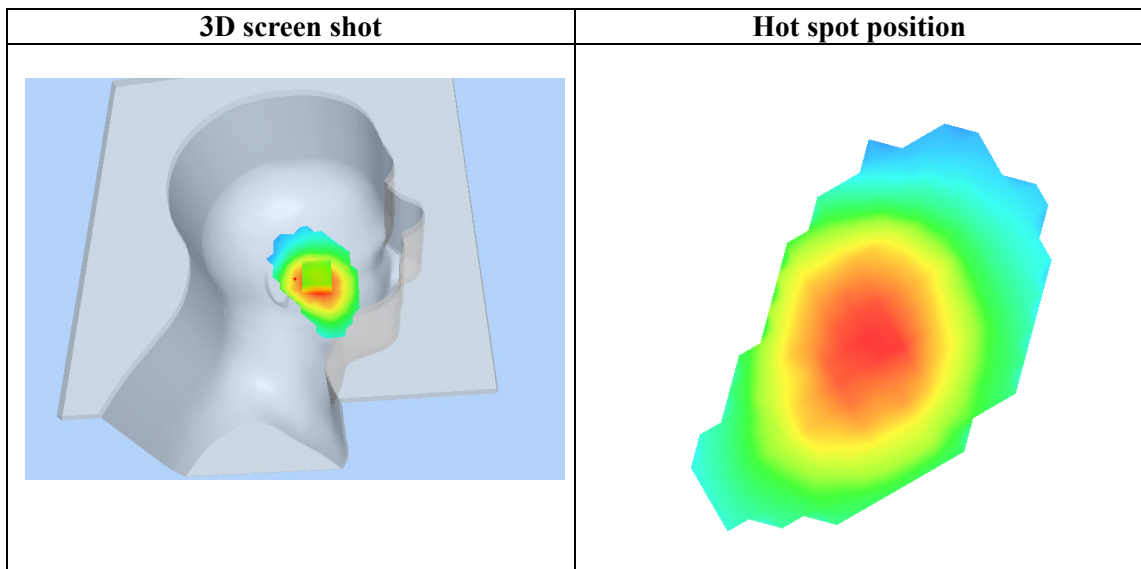
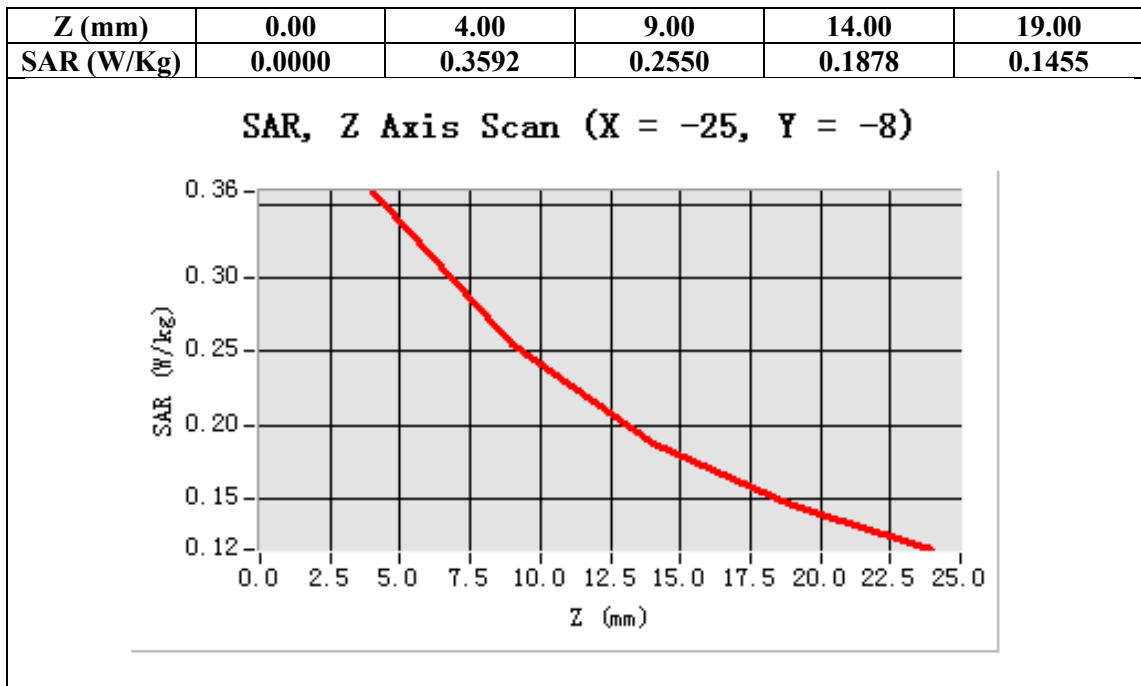

Test Laboratory: AGC Lab
GSM 850 Mid-Touch-Right <SIM 2>
DUT: Glow Mobile Phone; Type: X200

Date: Jun.28, 2013

Communication System: Generic GSM; Communication System Band: GSM 850; Duty Cycle: 1:8.3; Conv.F=5.30
Frequency: 836.6 MHz; Medium parameters used: $f = 850$ MHz; $\sigma = 0.94$ mho/m; $\epsilon_r = 42.16$; $\rho = 1000$ kg/m³ ;
Phantom section: Right Section
Ambient temperature (°C): 21.0, Liquid temperature (°C): 21.0

SATIMO Configuration:

Probe: EP165; Calibrated: 01/31/2013

- Sensor-Surface: 4mm (Mechanical Surface Detection)
- Phantom: Flat Phantom; Type: Elliptical Phantom
- Measurement SW: OpenSAR V4_02_01

Configuration/GSM 850 Mid-Touch-Right/Area Scan (6x8x1): Measurement grid: dx=20mm, dy=20mm
Configuration/GSM 850 Mid-Touch-Right/Zoom Scan (5x5x7)/Cube 0: Measurement grid: dx=8mm, dy=8mm, dz=5mm

Area Scan	sam_direct_droit2_surf8mm.txt
ZoomScan	5x5x7,dx=8mm dy=8mm dz=5mm,Very fast
Phantom	Right head
Device Position	Cheek
Band	GSM 850
Channels	Middle
Signal	TDMA (Crest factor: 8.0)

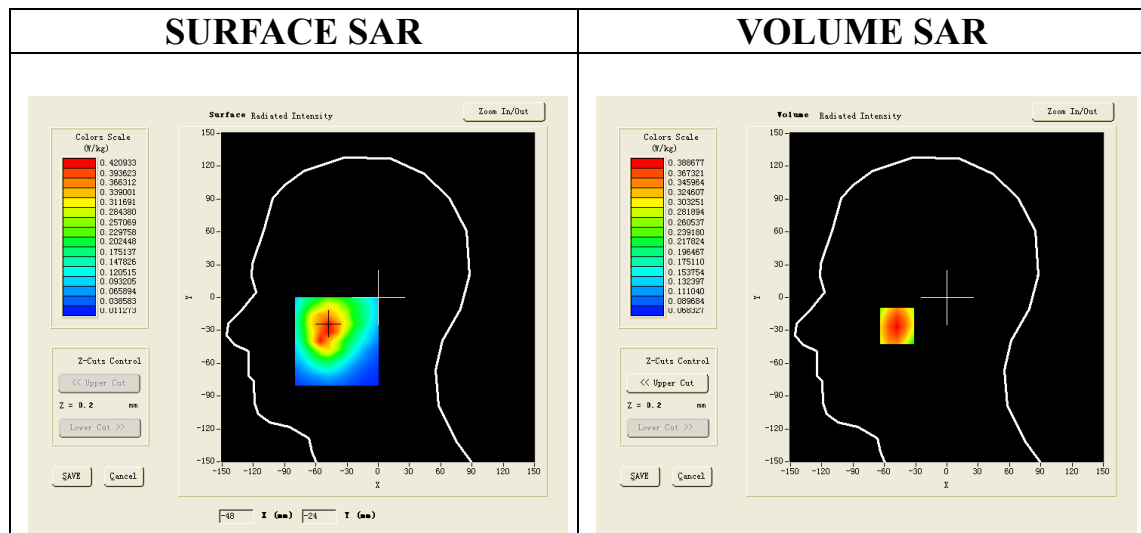

Maximum location: X=-48.00, Y=-26.00

SAR 10g (W/Kg)	0.272831
SAR 1g (W/Kg)	0.373441

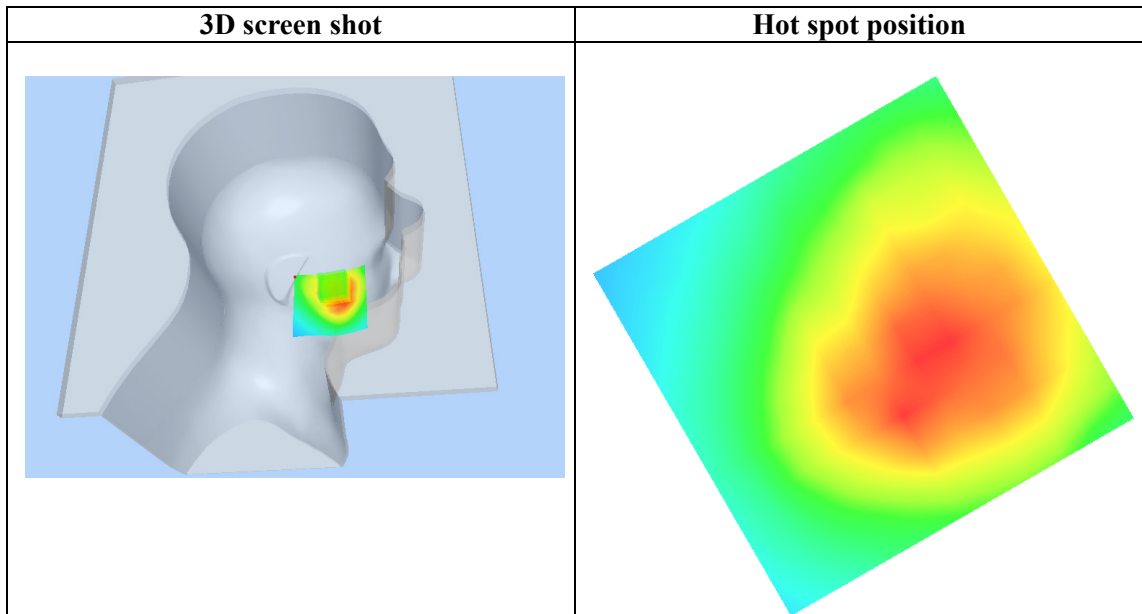
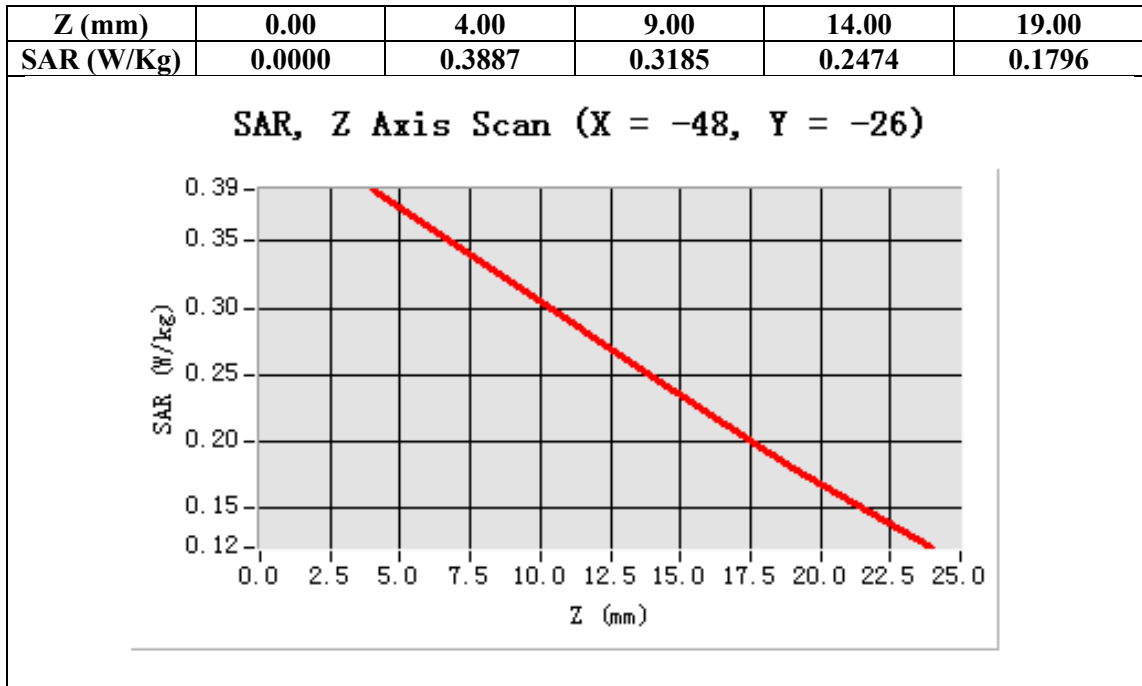

Test Laboratory: AGC Lab
GSM 850 Mid- Body- Back <SIM 1>
DUT: Glow Mobile Phone; Type: X200

Date: Jun.28, 2013

Communication System: Generic GSM; Communication System Band: GSM 850; Duty Cycle: 1:8.3; Conv.F=5.46;
Frequency: 836.6 MHz; Medium parameters used: $f = 850$ MHz; $\sigma = 0.96$ mho/m; $\epsilon_r = 53.62$; $\rho = 1000$ kg/m³ ;
Phantom section: Flat Section
Ambient temperature (°C): 21.0, Liquid temperature (°C): 21.0

SATIMO Configuration:

Probe: EP165; Calibrated: 01/31/2013

- Sensor-Surface: 4mm (Mechanical Surface Detection)
- Phantom: Flat Phantom; Type: Elliptical Phantom
- Measurement SW: OpenSAR V4_02_01

Configuration/GSM 850 Mid-Body-Back/Area Scan (6x8x1): Measurement grid: dx=20mm, dy=20mm
Configuration/GSM 850 Mid-Body-Back/Zoom Scan (5x5x7)/Cube 0: Measurement grid: dx=8mm, dy=8mm, dz=5mm;

Area Scan	surf_sam_plan.txt
ZoomScan	5x5x7,dx=8mm dy=8mm dz=5mm,Very fast
Phantom	Validation plane
Device Position	Body Back
Band	GSM 850
Channels	Middle
Signal	TDMA (Crest factor: 8.0)

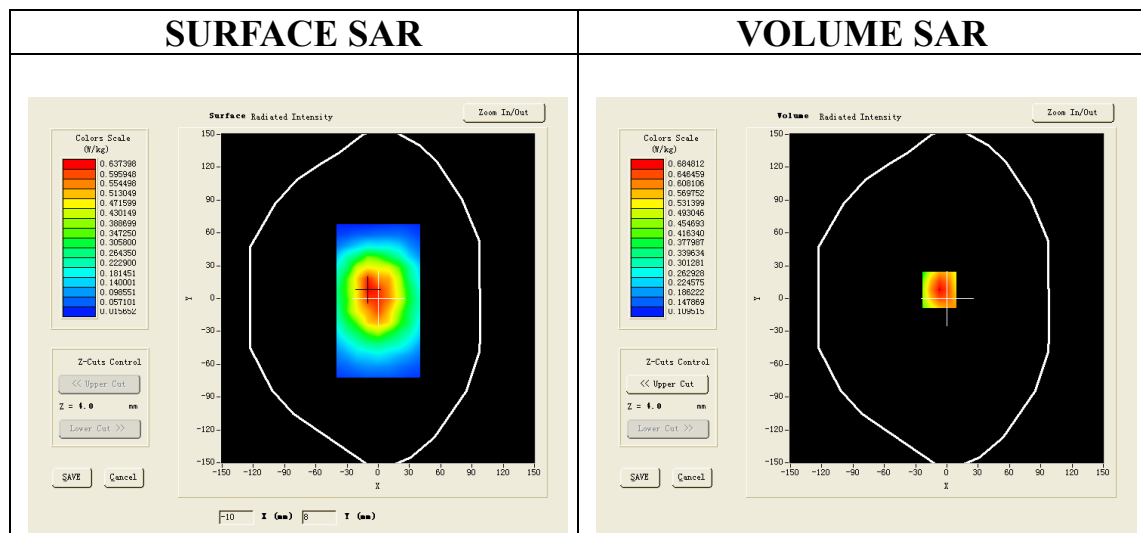

Maximum location: X=-7.00, Y=8.00

SAR 10g (W/Kg)	0.476544
SAR 1g (W/Kg)	0.705875

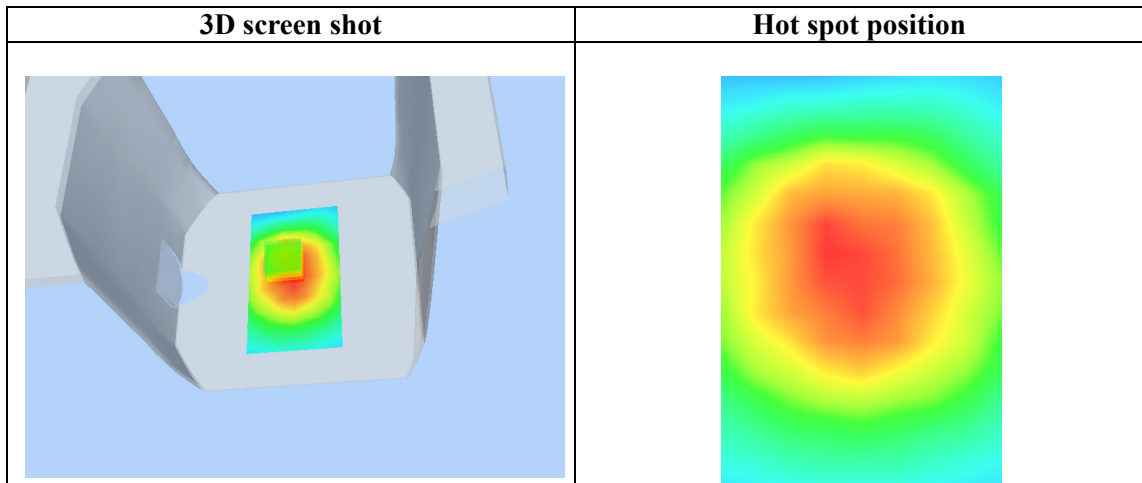
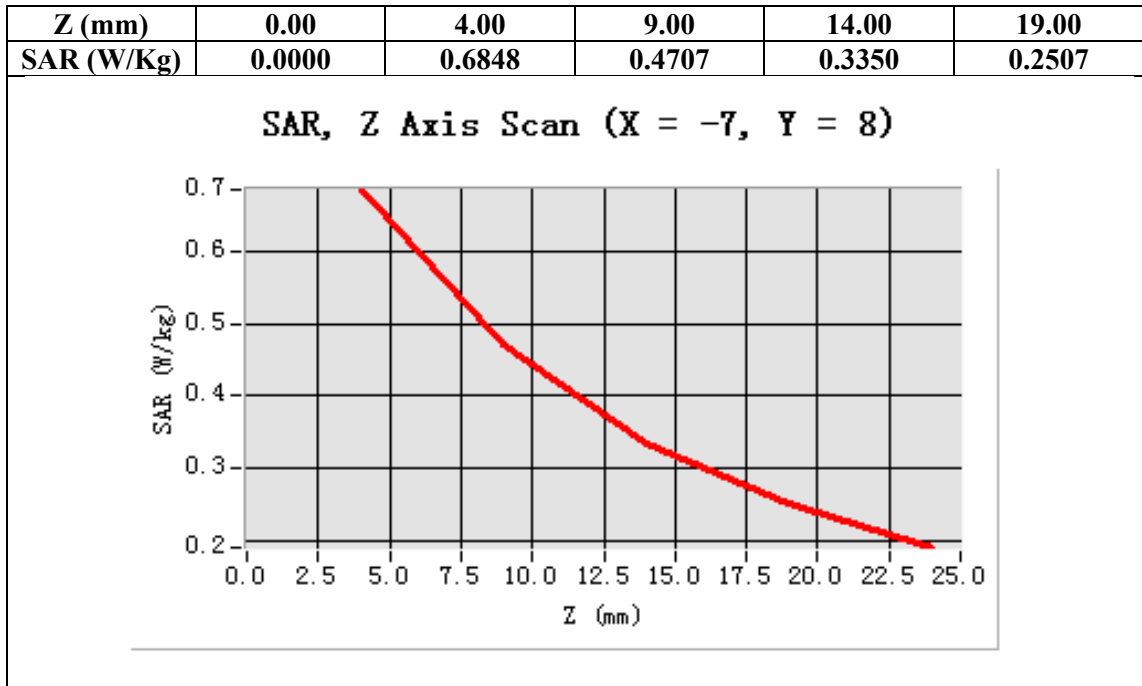

Test Laboratory: AGC Lab
GPRS 850 Mid- Body - Back (2up) <SIM 1>
DUT: Glow Mobile Phone; Type: X200

Date: Jun.28, 2013

Communication System: GPRS -2 Slot; Communication System Band: GSM850; Duty Cycle: 1:4.2; Conv.F=5.46;
Frequency: 836.6 MHz; Medium parameters used: $f = 850$ MHz; $\sigma = 0.96$ mho/m; $\epsilon = 53.62$; $\rho = 1000$ kg/m³ ;
Phantom section: Flat Section
Ambient temperature (°C): 21.0, Liquid temperature (°C): 21.0

SATIMO Configuration:

Probe: EP165; Calibrated: 01/31/2013

- Sensor-Surface: 4mm (Mechanical Surface Detection)
- Phantom: Flat Phantom; Type: Elliptical Phantom
- Measurement SW: OpenSAR V4_02_01

Configuration/GPRS 850 Mid-Body-Back/Area Scan (6x8x1): Measurement grid: dx=20mm, dy=20mm
Configuration/GPRS 850 Mid-Body-Back/Zoom Scan (5x5x7)/Cube 0: Measurement grid: dx=8mm, dy=8mm, dz=5mm;

Area Scan	surf_sam_plan.txt
ZoomScan	5x5x7,dx=8mm dy=8mm dz=5mm,Very fast
Phantom	Validation plane
Device Position	Body Back
Band	GSM 850
Channels	Middle
Signal	TDMA (Crest factor: 4.0)

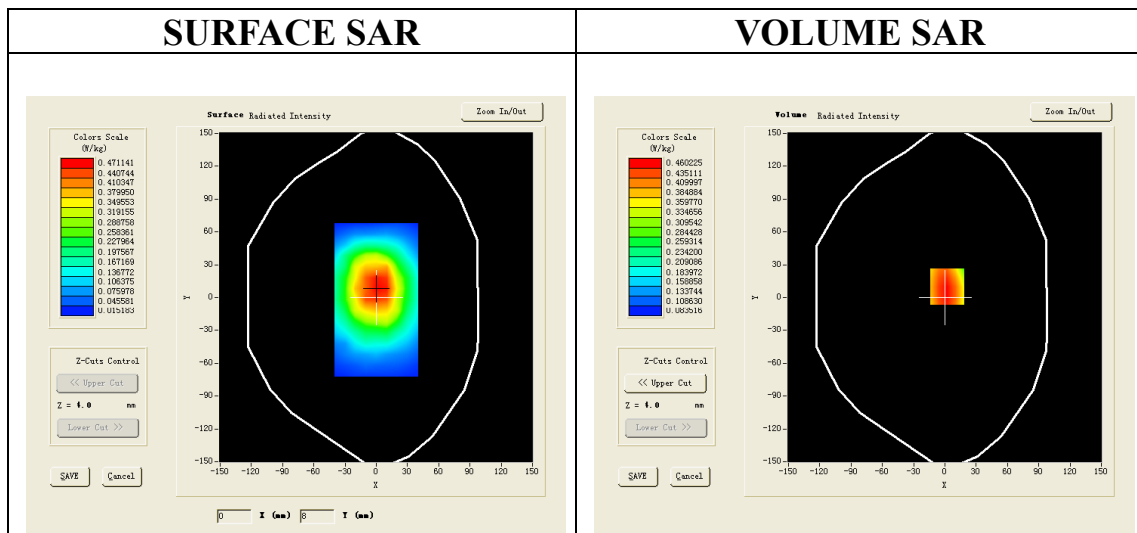

Maximum location: X=2.00, Y=10.00

SAR 10g (W/Kg)	0.346798
SAR 1g (W/Kg)	0.481977

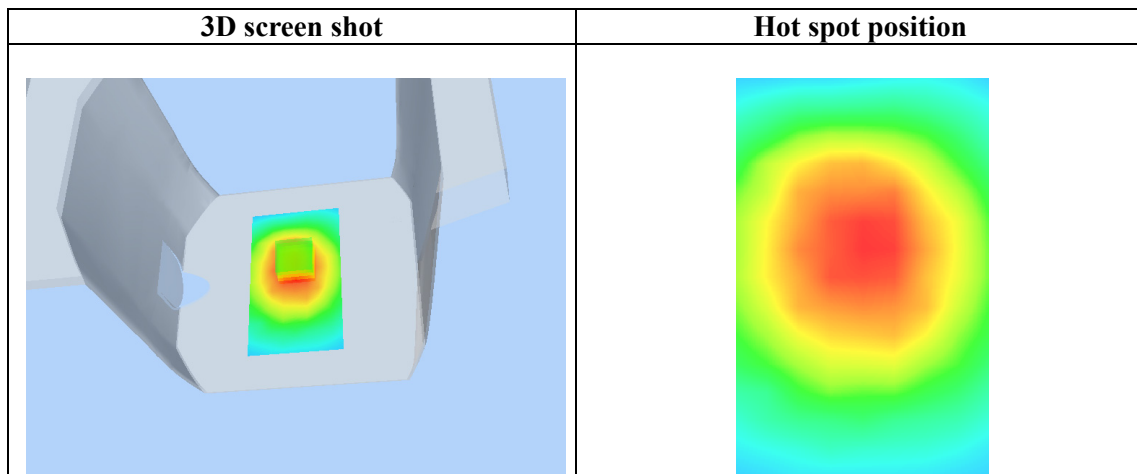
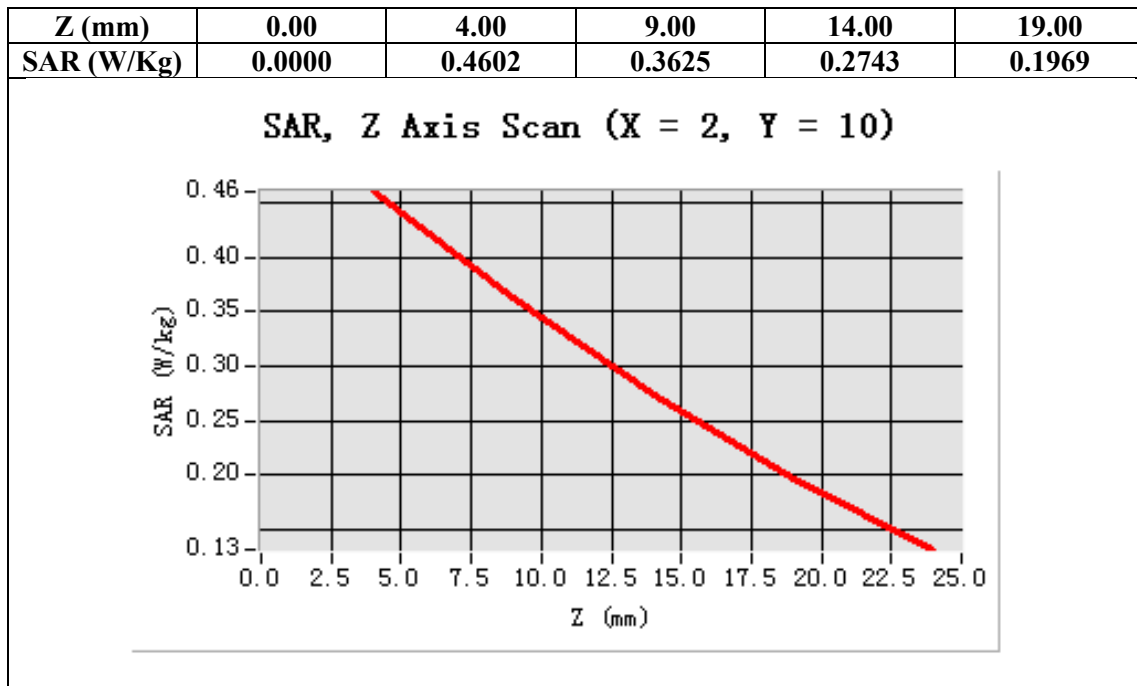

Test Laboratory: AGC Lab
GPRS 850 Mid-Body-back (3up) <SIM 1>
DUT: Glow Mobile Phone; Type: X200

Date: Jun.28, 2013

Communication System: GPRS -3 Slot; Communication System Band: GSM 850; Duty Cycle: 1:2.8; Conv.F=5.46;
Frequency: 836.6 MHz; Medium parameters used: $f = 850$ MHz; $\sigma = 0.96$ mho/m; $\epsilon_r = 53.62$; $\rho = 1000$ kg/m³ ;
Phantom section: Flat Section
Ambient temperature (°C): 21.0, Liquid temperature (°C): 21.0

SATIMO Configuration:

Probe: EP165; Calibrated: 01/31/2013

- Sensor-Surface: 4mm (Mechanical Surface Detection)
- Phantom: Flat Phantom; Type: Elliptical Phantom
- Measurement SW: OpenSAR V4_02_01

Configuration/GPRS 850 Mid-Body-Back/Area Scan (6x8x1): Measurement grid: dx=20mm, dy=20mm
Configuration/GPRS 850 Mid-Body-Back/Zoom Scan (5x5x7)/Cube 0: Measurement grid: dx=8mm, dy=8mm, dz=5mm;

Area Scan	surf_sam_plan.txt
ZoomScan	5x5x7,dx=8mm dy=8mm dz=5mm,Very fast
Phantom	Validation plane
Device Position	Body Back
Band	GSM 850
Channels	Middle
Signal	TDMA (Crest factor:2.7)

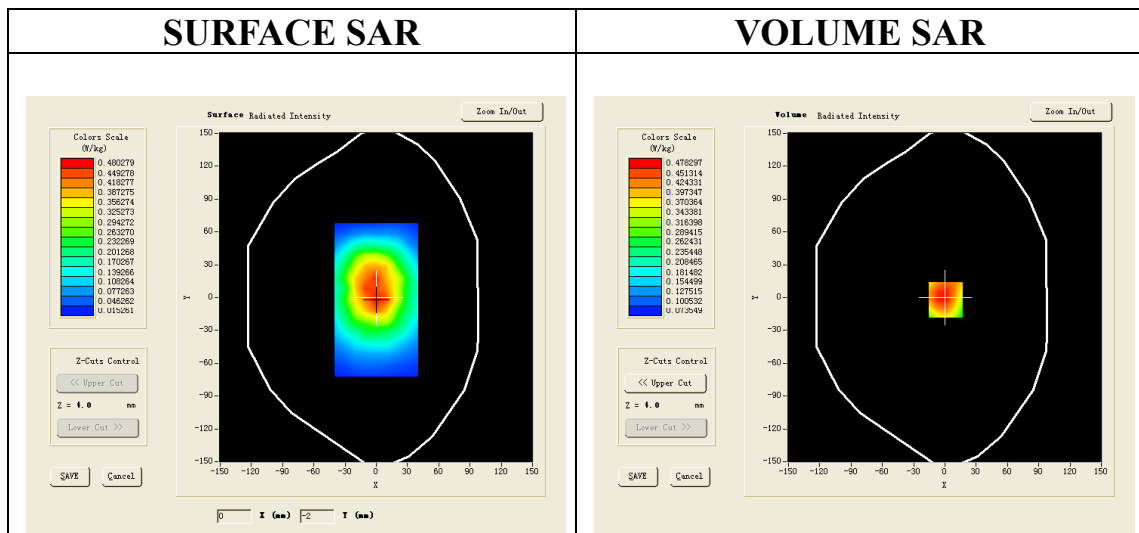

Maximum location: X=1.00, Y=-2.00

SAR 10g (W/Kg)	0.334081
SAR 1g (W/Kg)	0.500485

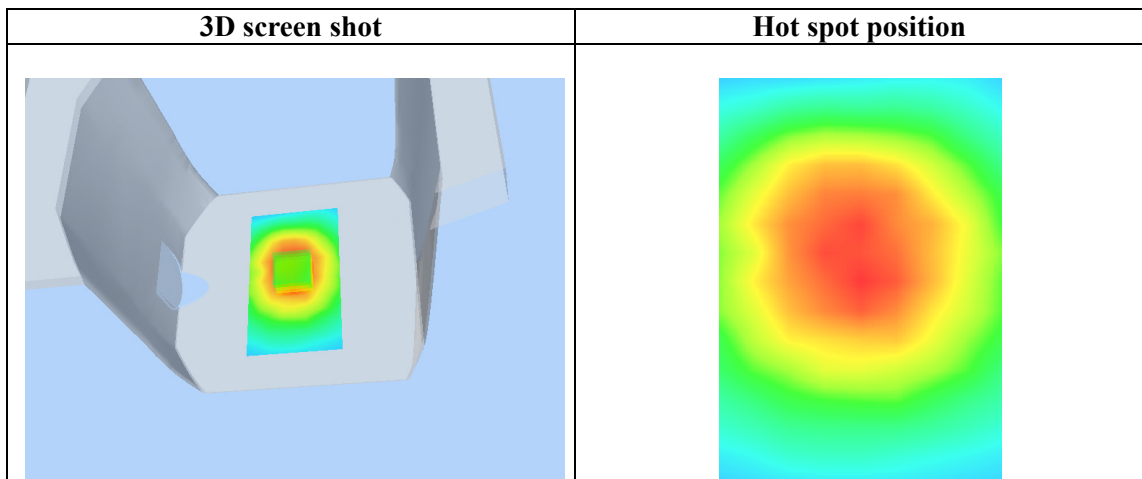
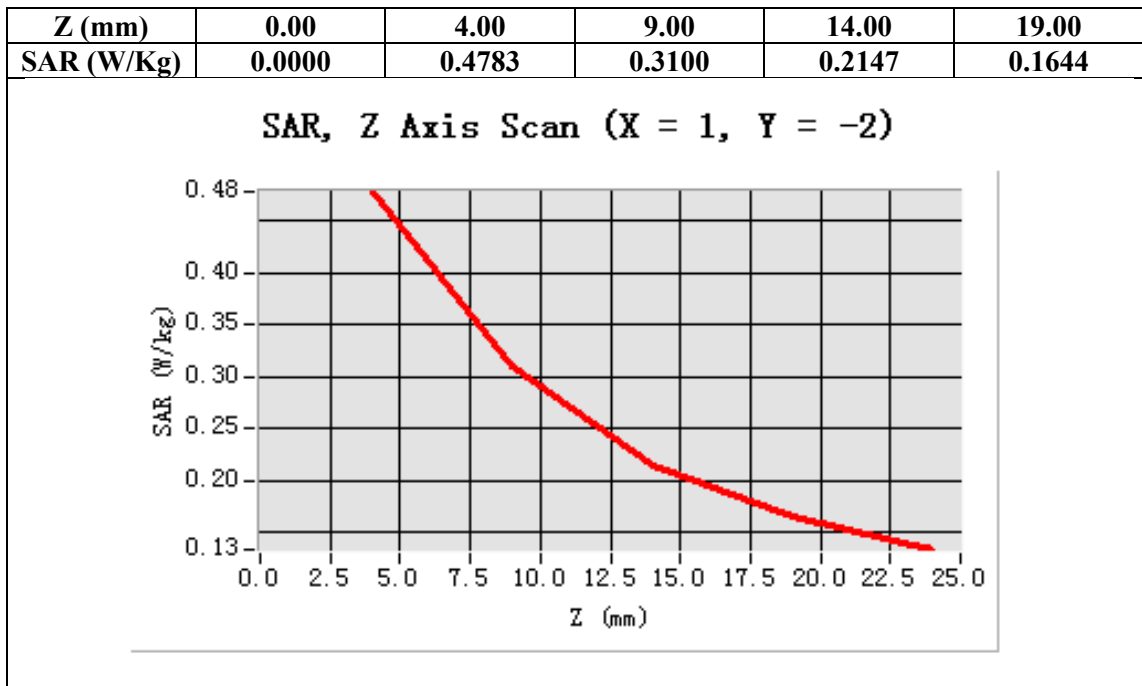

Test Laboratory: AGC Lab
GPRS 850 Mid- Body-Back (4up) <SIM 1>
DUT: Glow Mobile Phone; Type: X200

Date: Jun.28, 2013

Communication System: GPRS -4 Slot; Communication System Band: GSM 850; Duty Cycle: 1:2.1; Conv.F=5.46
;Frequency: 836.6 MHz; Medium parameters used: $f = 850$ MHz; $\sigma = 0.96$ mho/m; $\epsilon_r = 53.62$; $\rho = 1000$ kg/m³ ;
Phantom section: Flat Section
Ambient temperature (°C): 21.0, Liquid temperature (°C): 21.0

SATIMO Configuration:

Probe: EP165; Calibrated: 01/31/2013

- Sensor-Surface: 4mm (Mechanical Surface Detection)
- Phantom: Flat Phantom; Type: Elliptical Phantom
- Measurement SW: OpenSAR V4_02_01

Configuration/GPRS 850 Mid-Body-Back/Area Scan: Measurement grid: dx=20mm, dy=20mm

Configuration/GPRS 850 Mid-Body-Back/Zoom Scan: Measurement grid: dx=8mm, dy=8mm, dz=5mm;

Area Scan	surf_sam_plan.txt
ZoomScan	5x5x7,dx=8mm dy=8mm dz=5mm,Very fast
Phantom	Validation plane
Device Position	Body Back
Band	GSM 850
Channels	Middle
Signal	TDMA (Crest factor: 2.0)

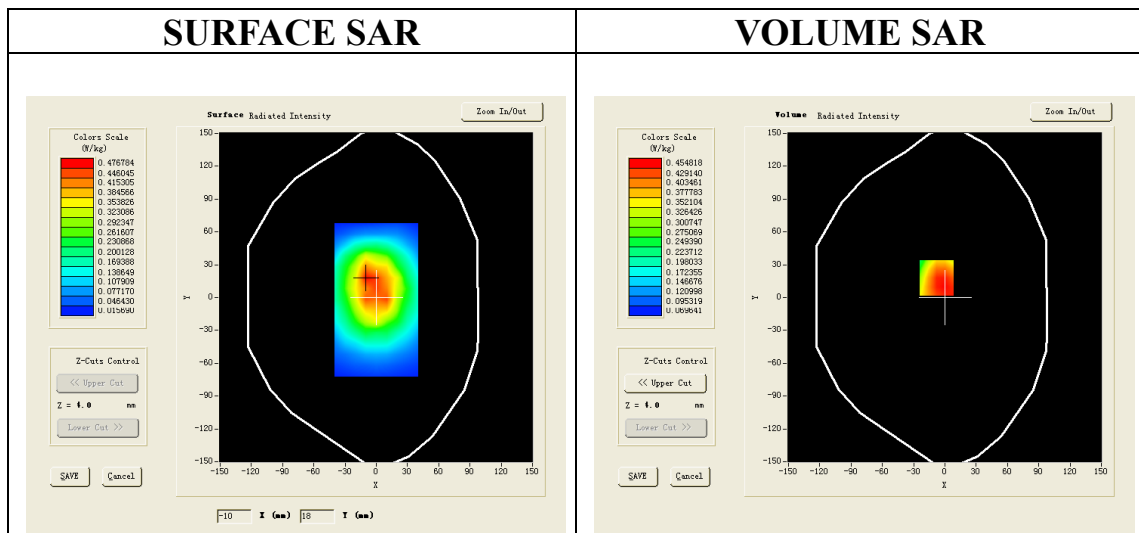

Maximum location: X=-8.00, Y=18.00

SAR 10g (W/Kg)	0.341264
SAR 1g (W/Kg)	0.474078

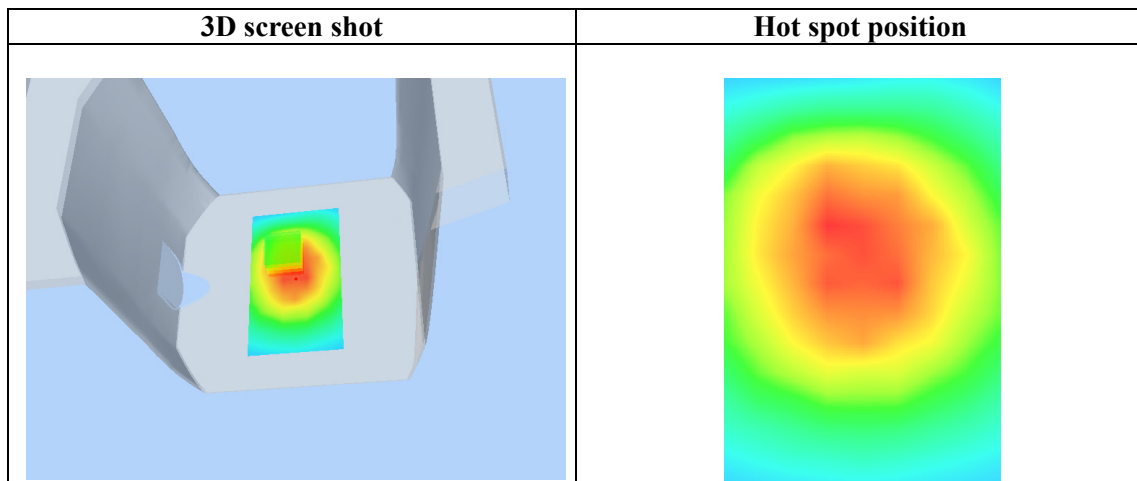
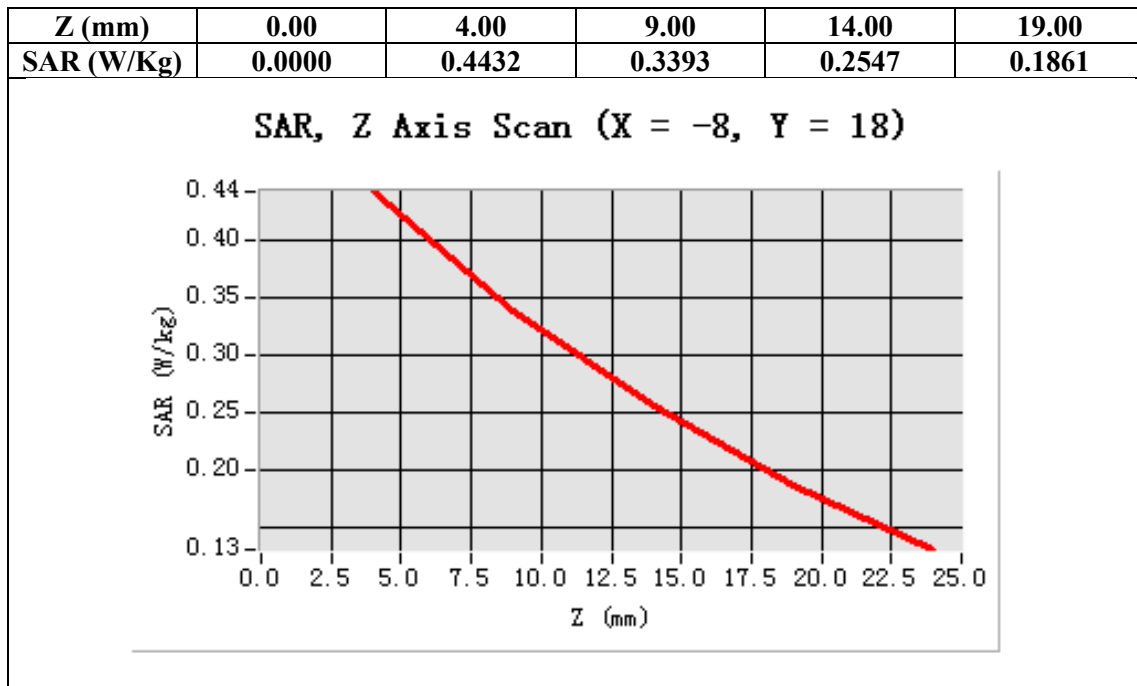

Test Laboratory: AGC Lab
GSM 850 Mid- Body- Front (MS) <SIM 1>
DUT: Glow Mobile Phone; Type: X200

Date: Jun.28, 2013

Communication System: Generic GSM; Communication System Band: GSM 850; Duty Cycle: 1:8.3; Conv.F=5.46;
Frequency: 836.6 MHz; Medium parameters used: $f = 850$ MHz; $\sigma = 0.96$ mho/m; $\epsilon_r = 53.62$; $\rho = 1000$ kg/m³ ;
Phantom section: Flat Section
Ambient temperature (°C): 21.0, Liquid temperature (°C): 21.0

SATIMO Configuration:

Probe: EP165; Calibrated: 01/31/2013

- Sensor-Surface: 4mm (Mechanical Surface Detection)
- Phantom: Flat Phantom; Type: Elliptical Phantom
- Measurement SW: OpenSAR V4_02_01

Configuration/GSM 850 Mid-Body- Front /Area Scan (6x8x1): Measurement grid: dx=20mm, dy=20mm
Configuration/GSM 850 Mid-Body- Front Zoom Scan (5x5x7)/Cube 0: Measurement grid: dx=8mm, dy=8mm, dz=5mm;

Area Scan	surf_sam_plan.txt
ZoomScan	5x5x7,dx=8mm dy=8mm dz=5mm,Very fast
Phantom	Validation plane
Device Position	Body Front
Band	GSM 850
Channels	Middle
Signal	TDMA (Crest factor: 8.0)

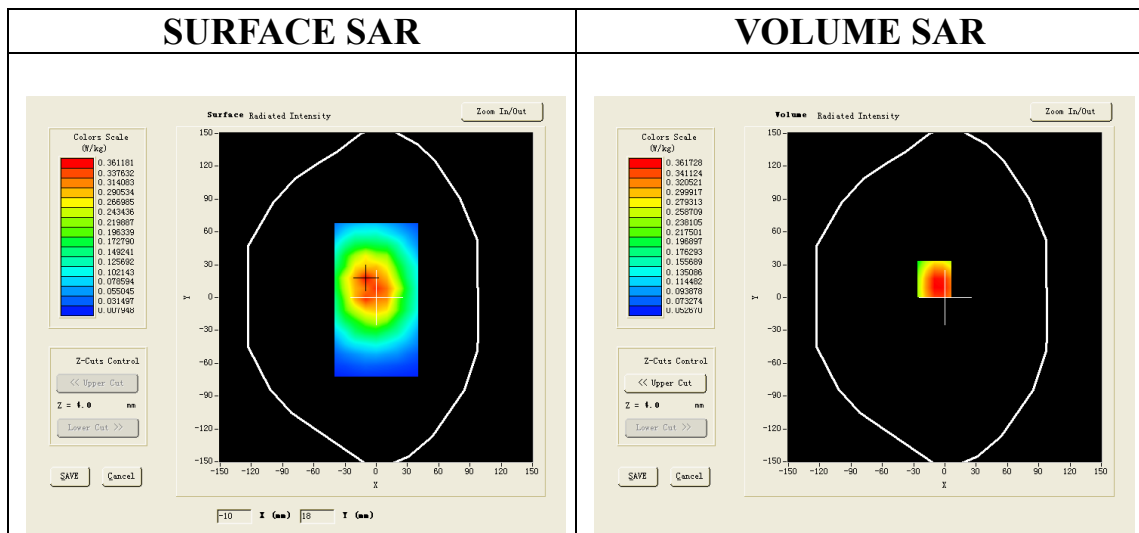

Maximum location: X=-10.00, Y=17.00

SAR 10g (W/Kg)	0.255484
SAR 1g (W/Kg)	0.381840

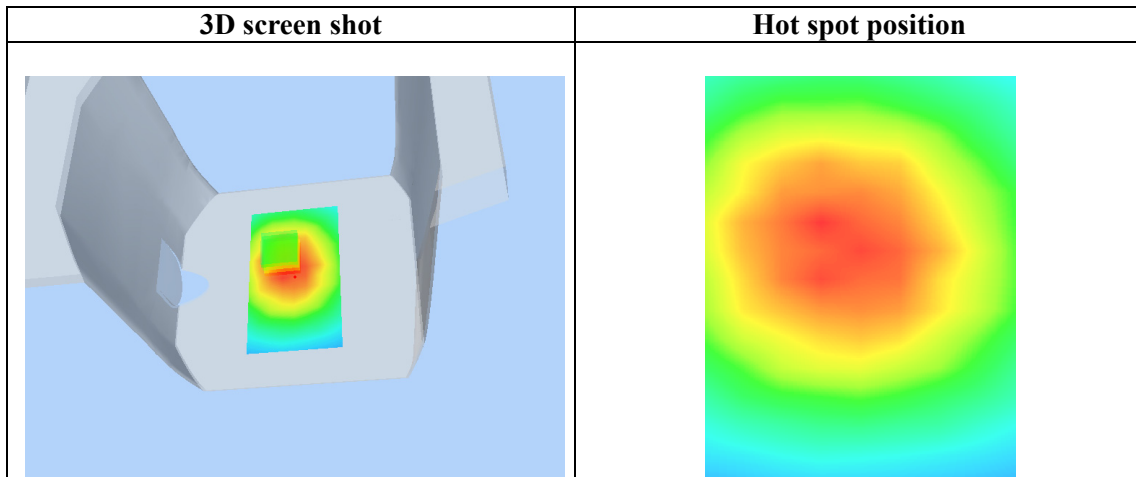
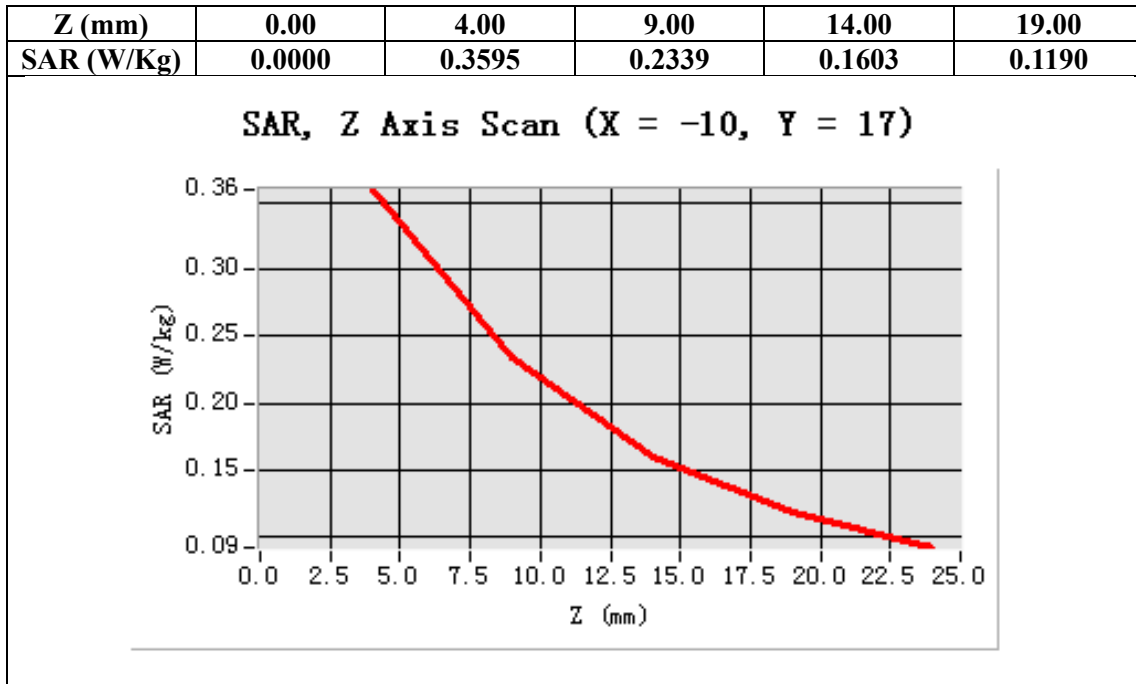

Test Laboratory: AGC Lab
GSM 850 Mid- Body- Back (MS) –with earphone <SIM 1>
DUT: Glow Mobile Phone; Type: X200

Date: Jun.28, 2013

Communication System: Generic GSM; Communication System Band: GSM 850; Duty Cycle: 1:8.3; Conv.F=5.46;
Frequency: 836.6 MHz; Medium parameters used: $f = 850$ MHz; $\sigma = 0.96$ mho/m; $\epsilon_r = 53.62$; $\rho = 1000$ kg/m³ ;
Phantom section: Flat Section
Ambient temperature (°C): 21.0, Liquid temperature (°C): 21.0

SATIMO Configuration:

Probe: EP165; Calibrated: 01/31/2013

- Sensor-Surface: 4mm (Mechanical Surface Detection)
- Phantom: Flat Phantom; Type: Elliptical Phantom
- Measurement SW: OpenSAR V4_02_01

Configuration/GSM 850 Mid-Body-Back/Area Scan (6x8x1): Measurement grid: dx=20mm, dy=20mm
Configuration/GSM 850 Mid-Body-Back/Zoom Scan (5x5x7)/Cube 0: Measurement grid: dx=8mm, dy=8mm, dz=5mm;

Area Scan	surf_sam_plan.txt
ZoomScan	5x5x7,dx=8mm dy=8mm dz=5mm,Very fast
Phantom	Validation plane
Device Position	Body Back
Band	GSM 850
Channels	Middle
Signal	TDMA (Crest factor: 8.0)

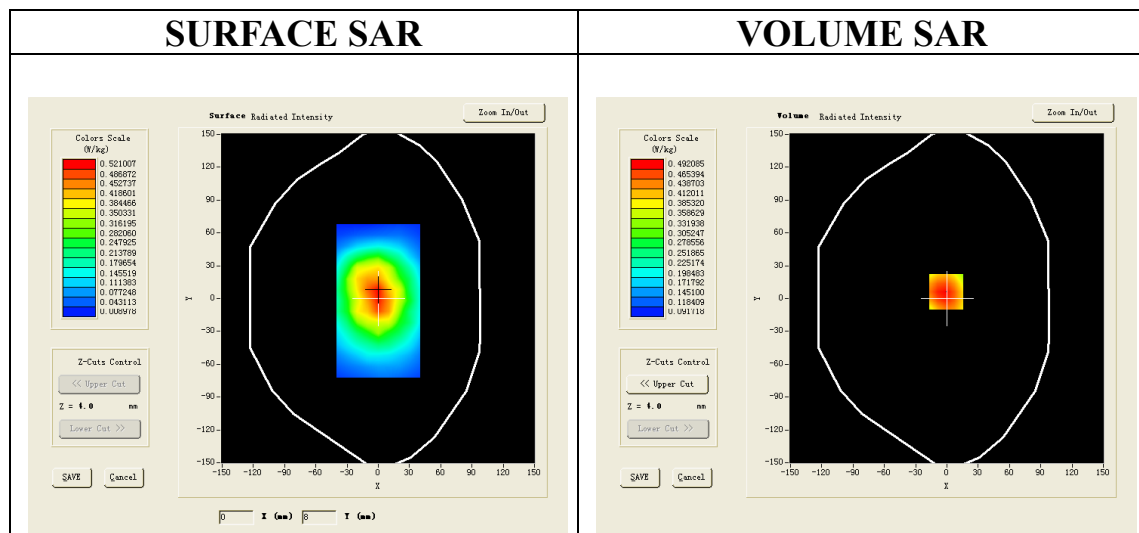

Maximum location: X=-1.00, Y=6.00

SAR 10g (W/Kg)	0.349800
SAR 1g (W/Kg)	0.511368

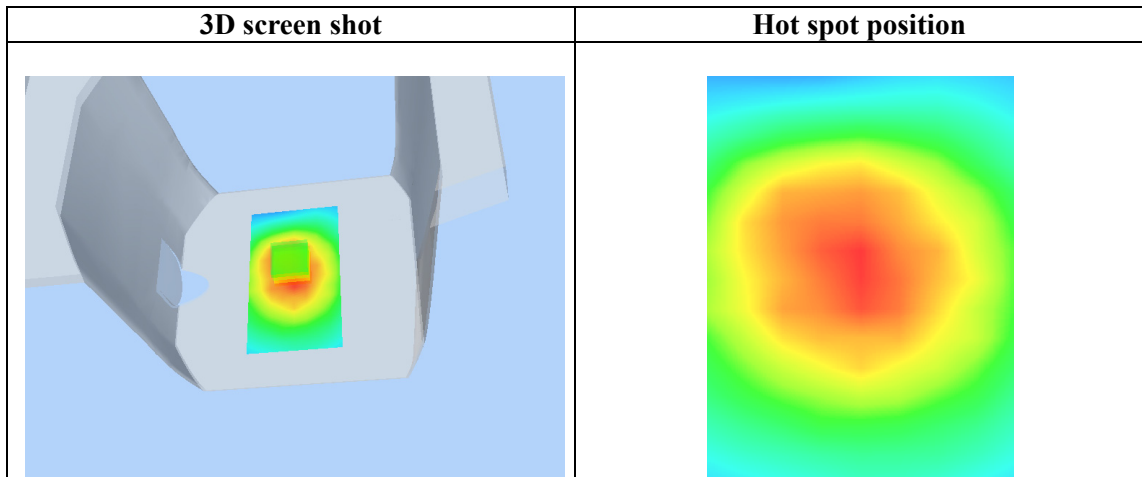
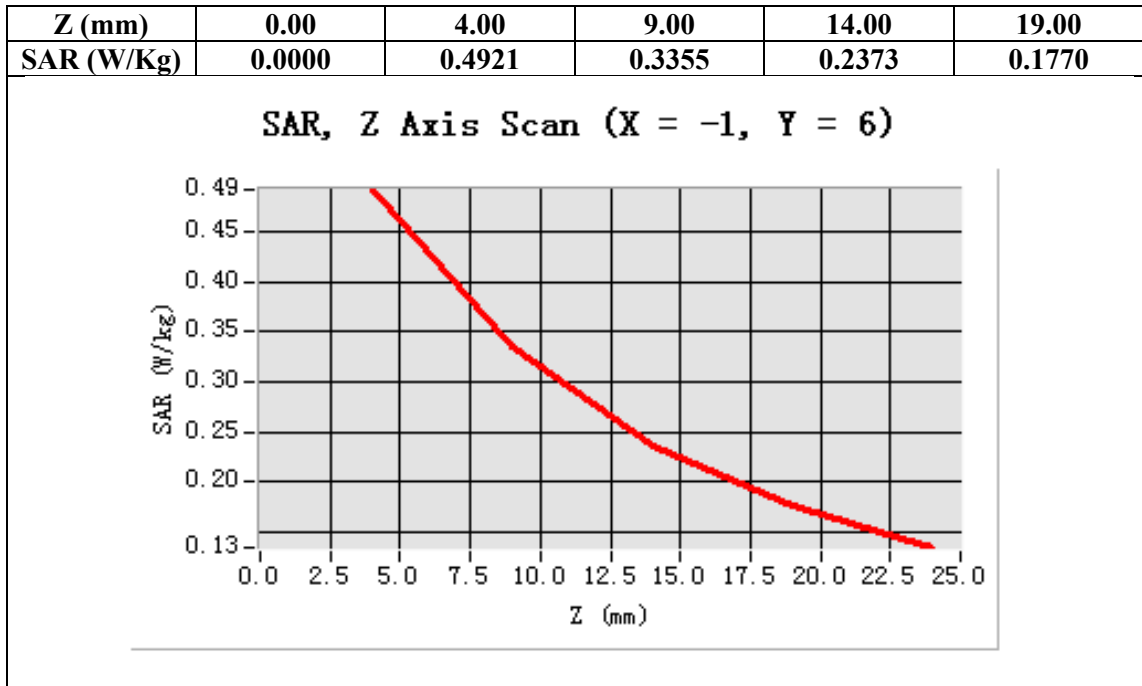

Test Laboratory: AGC Lab
PCS 1900 Low-Touch- Left <SIM 1>
DUT: Glow Mobile Phone; Type: X200

Date: Jun.28, 2013

Communication System: Generic GSM; Communication System Band: PCS 1900; Duty Cycle: 1:8.3; Conv.F=4.72;
Frequency: 1850.2 MHz; Medium parameters used: $f = 1900$ MHz; $\sigma = 1.39$ mho/m; $\epsilon_r = 39.84$; $\rho = 1000$ kg/m³ ;
Phantom section: Left Section
Ambient temperature (°C): 21.0, Liquid temperature (°C): 21.0

SATIMO Configuration:

Probe: EP165; Calibrated: 01/31/2013

- Sensor-Surface: 4mm (Mechanical Surface Detection)
- Phantom: Flat Phantom; Type: Elliptical Phantom
- Measurement SW: OpenSAR V4_02_01

Configuration/PCS1900 Low-Touch-Left/Area Scan: Measurement grid: dx=20mm, dy=20mm

Configuration/PCS1900 Low-Touch-Left/Zoom Scan: Measurement grid: dx=8mm, dy=8mm, dz=5mm;

Area Scan	sam_direct_droit2_surf8mm.txt
ZoomScan	5x5x7,dx=8mm dy=8mm dz=5mm,Very fast
Phantom	Left head
Device Position	Cheek
Band	PCS 1900
Channels	Low
Signal	TDMA (Crest factor: 8.0)

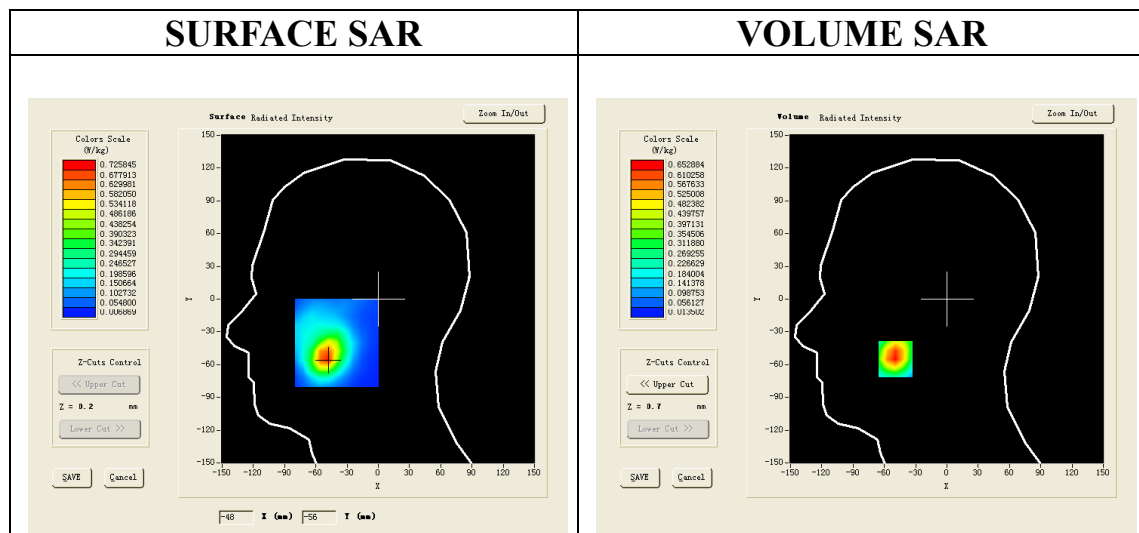

Maximum location: X=-49.00, Y=-55.00

SAR 10g (W/Kg)	0.338327
SAR 1g (W/Kg)	0.616252

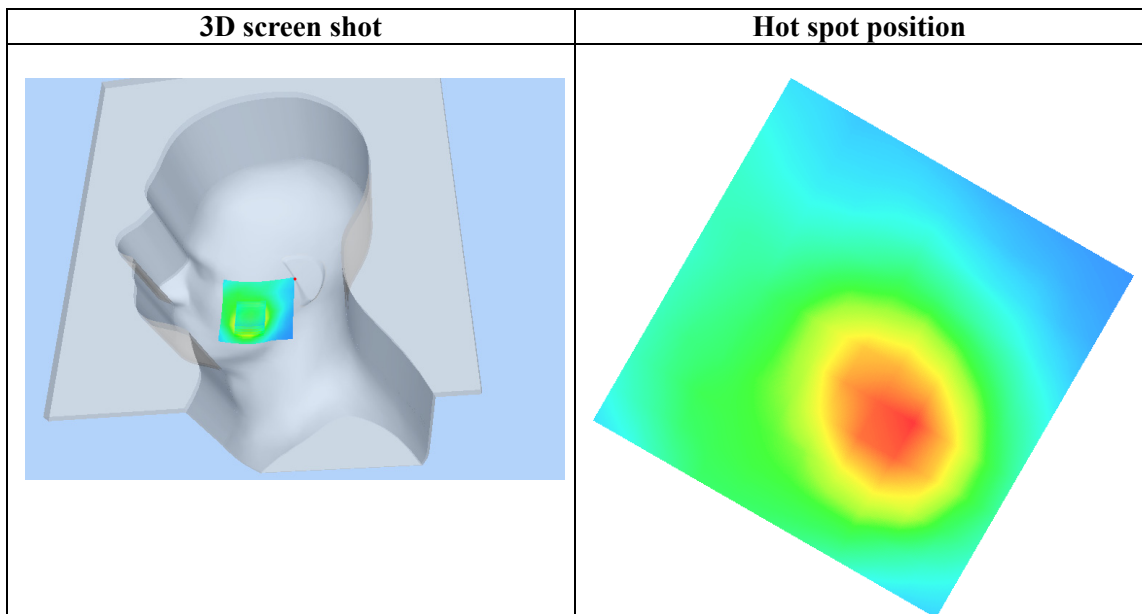
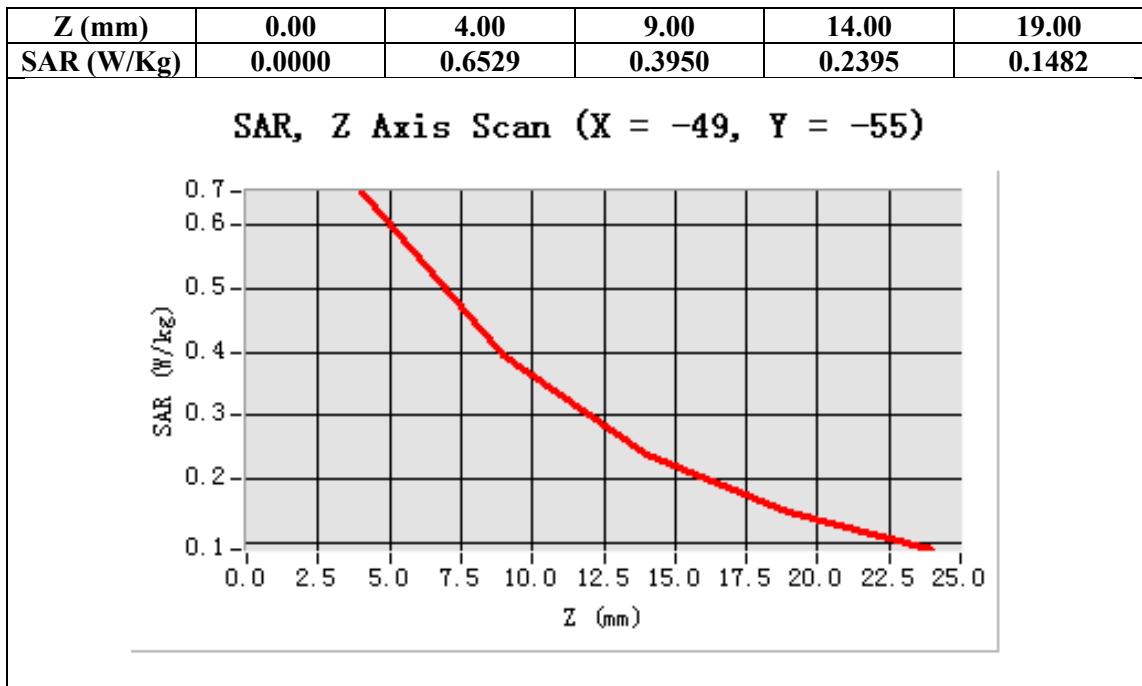

Test Laboratory: AGC Lab
PCS 1900 Mid-Touch- Left <SIM 1>
DUT: Glow Mobile Phone; Type: X200

Date: Jun.28, 2013

Communication System: Generic GSM; Communication System Band: PCS 1900; Duty Cycle: 1:8.3; Conv.F=4.72;
Frequency: 1880 MHz; Medium parameters used: $f = 1900$ MHz; $\sigma = 1.39$ mho/m; $\epsilon_r = 39.84$; $\rho = 1000$ kg/m³ ;
Phantom section: Left Section
Ambient temperature (°C): 21.0, Liquid temperature (°C): 21.0

SATIMO Configuration:

Probe: EP165; Calibrated: 01/31/2013

- Sensor-Surface: 4mm (Mechanical Surface Detection)
- Phantom: Flat Phantom; Type: Elliptical Phantom
- Measurement SW: OpenSAR V4_02_01

Configuration/PCS1900 Mid-Touch-Left/Area Scan: Measurement grid: dx=20mm, dy=20mm
Configuration/PCS1900 Mid-Touch-Left/Zoom Scan: Measurement grid: dx=8mm, dy=8mm, dz=5mm;

Area Scan	sam_direct_droit2_surf8mm.txt
ZoomScan	5x5x7,dx=8mm dy=8mm dz=5mm,Very fast
Phantom	Left head
Device Position	Cheek
Band	PCS 1900
Channels	Middle
Signal	TDMA (Crest factor: 8.0)

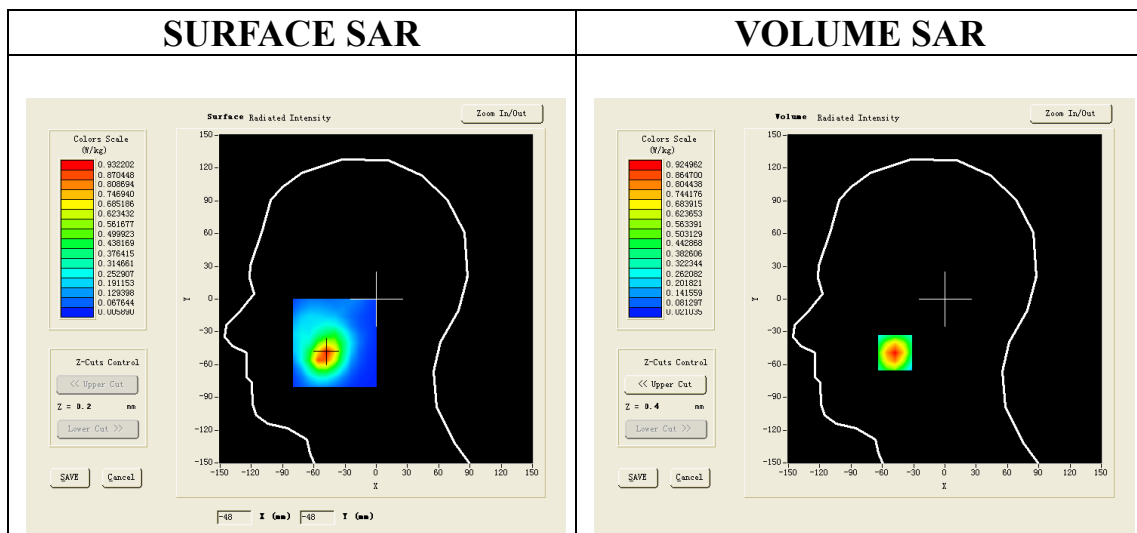

Maximum location: X=-48.00, Y=-49.00

SAR 10g (W/Kg)	0.462807
SAR 1g (W/Kg)	0.856780

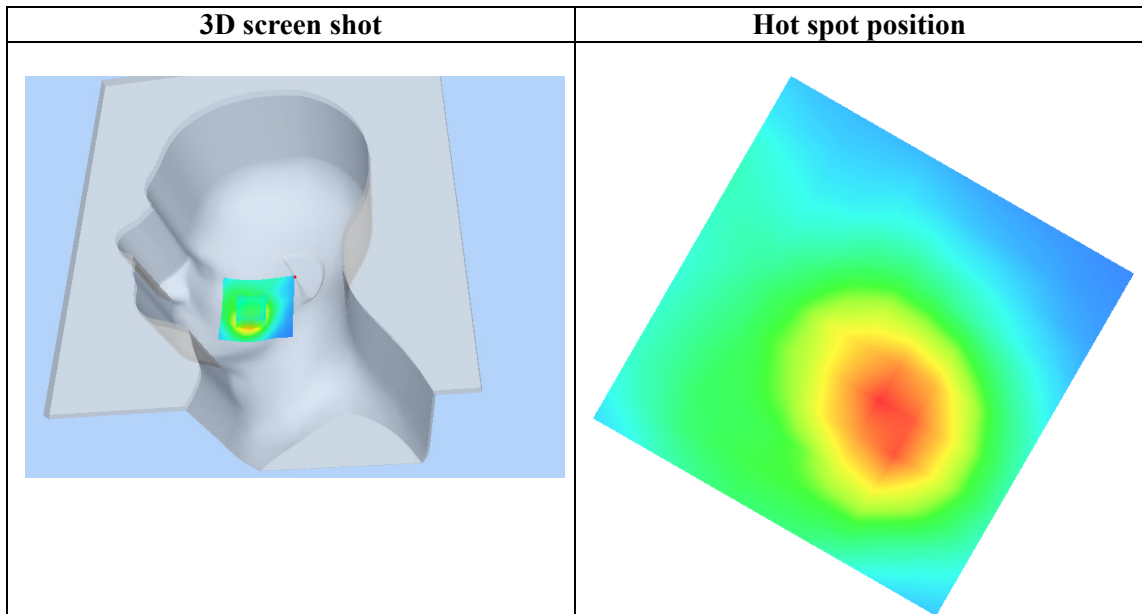
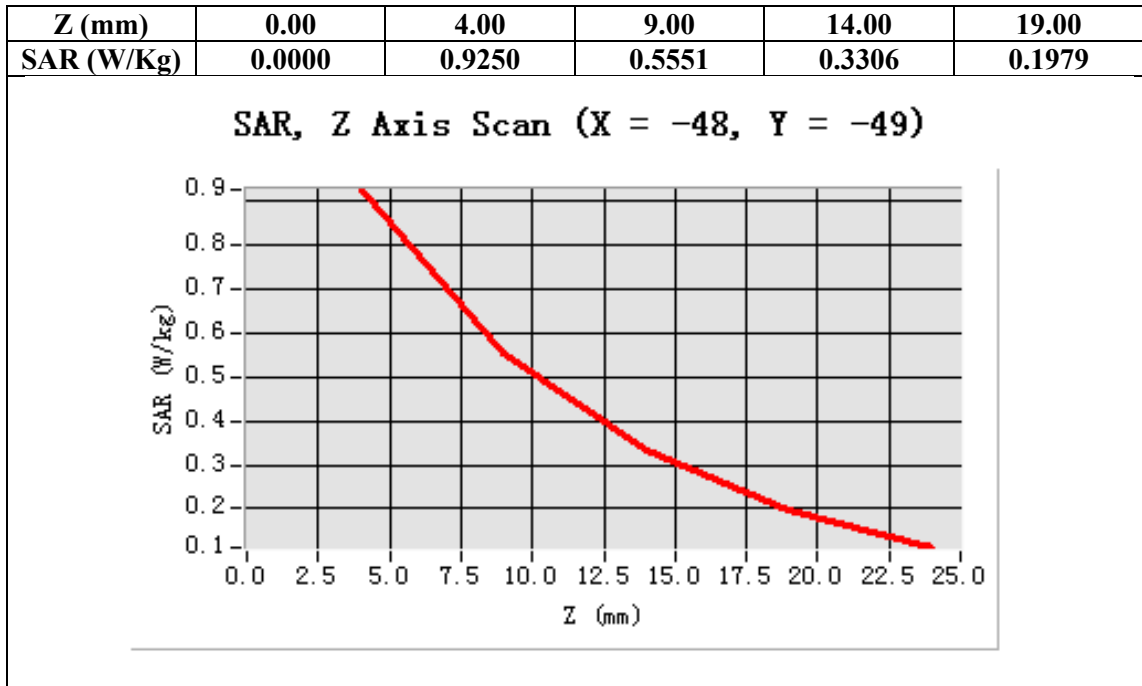

Test Laboratory: AGC Lab
PCS 1900 High-Touch- Left <SIM 1>
DUT: Glow Mobile Phone; Type: X200

Date: Jun.28, 2013

Communication System: Generic GSM; Communication System Band: PCS 1900; Duty Cycle: 1:8.3; Conv.F=4.72;
Frequency: 1909.8 MHz; Medium parameters used: $f = 1900$ MHz; $\sigma = 1.39$ mho/m; $\epsilon_r = 39.84$; $\rho = 1000$ kg/m³ ;
Phantom section: Left Section
Ambient temperature (°C): 21.0, Liquid temperature (°C): 21.0

SATIMO Configuration:

Probe: EP165; Calibrated: 01/31/2013

- Sensor-Surface: 4mm (Mechanical Surface Detection)
- Phantom: Flat Phantom; Type: Elliptical Phantom
- Measurement SW: OpenSAR V4_02_01

Configuration/PCS1900 High-Touch-Left/Area Scan: Measurement grid: dx=20mm, dy=20mm

Configuration/PCS1900 High-Touch-Left/Zoom Scan: Measurement grid: dx=8mm, dy=8mm, dz=5mm;

Area Scan	sam_direct_droit2_surf8mm.txt
ZoomScan	5x5x7,dx=8mm dy=8mm dz=5mm,Very fast
Phantom	Left head
Device Position	Cheek
Band	PCS 1900
Channels	High
Signal	TDMA (Crest factor: 8.0)

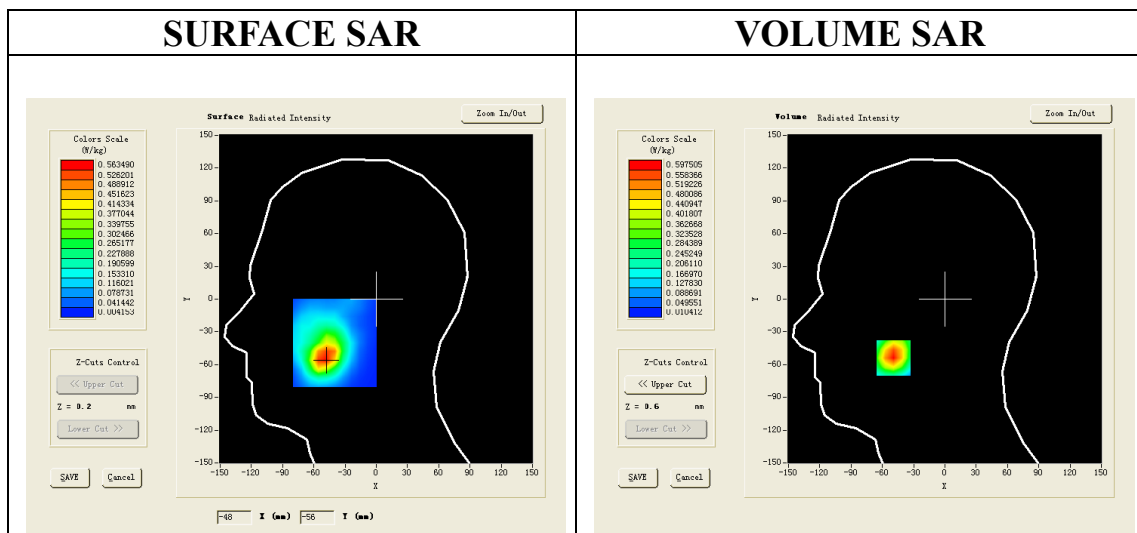

Maximum location: X=-49.00, Y=-54.00

SAR 10g (W/Kg)	0.291499
SAR 1g (W/Kg)	0.562636

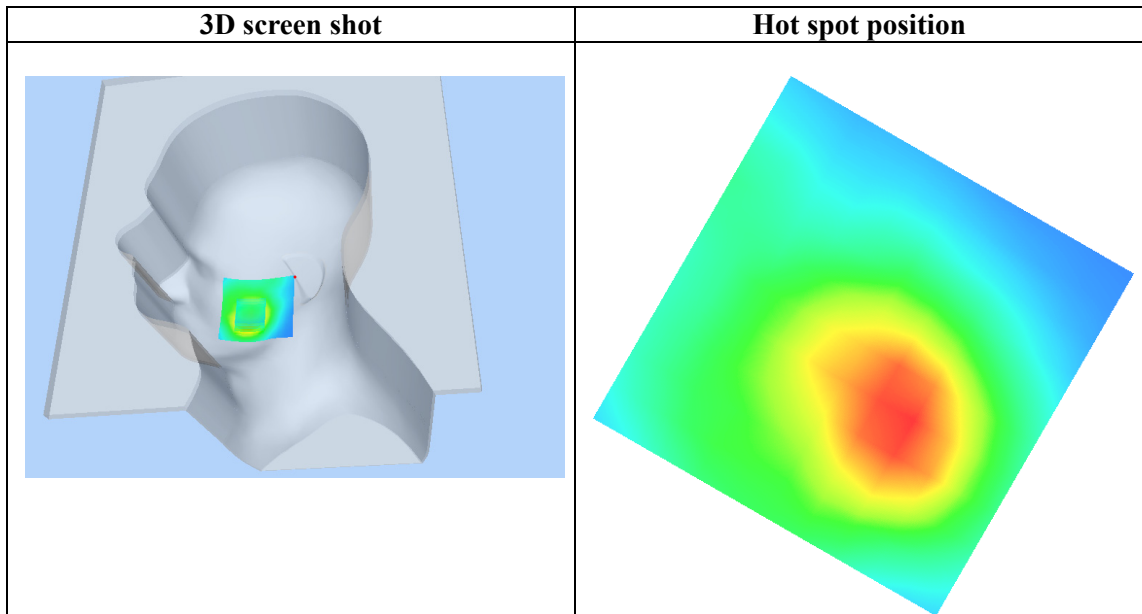
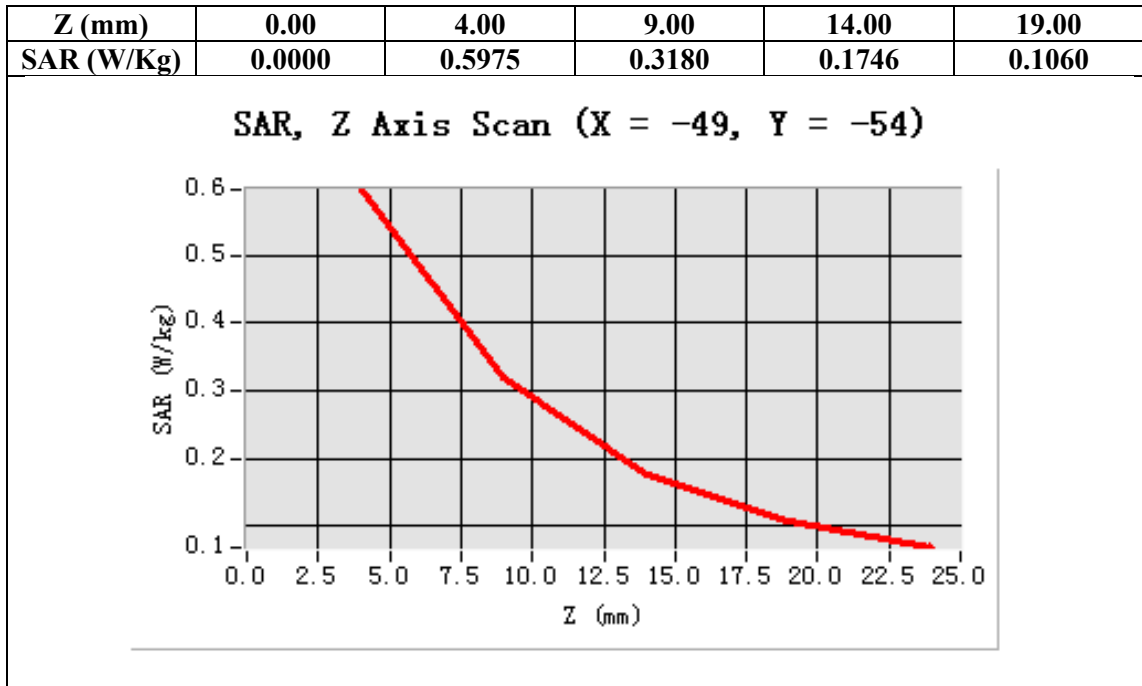

Test Laboratory: AGC Lab
PCS 1900 Mid-Tilt-Left <SIM 1>
DUT: Glow Mobile Phone; Type: X200

Date: Jun.28, 2013

Communication System: Generic GSM; Communication System Band: PCS 1900; Duty Cycle: 1:8.3; Conv.F=4.72;
Frequency: 1880 MHz; Medium parameters used: $f = 1900$ MHz; $\sigma = 1.39$ mho/m; $\epsilon_r = 39.84$; $\rho = 1000$ kg/m³ ;
Phantom section: Left Section
Ambient temperature (°C): 21.0, Liquid temperature (°C): 21.0

SATIMO Configuration:

- Probe: EP165; Calibrated: 01/31/2013
- Sensor-Surface: 4mm (Mechanical Surface Detection)
- Phantom: Flat Phantom; Type: Elliptical Phantom
- Measurement SW: OpenSAR V4_02_01

Configuration/PCS1900 Mid-Tilt-Left/Area Scan: Measurement grid: dx=20mm, dy=20mm
Configuration/PCS1900 Mid-Tilt-Left/Zoom Scan: Measurement grid: dx=8mm, dy=8mm,dz=5mm;

Area Scan	sam_direct_droit2_surf8mm.txt
ZoomScan	5x5x7,dx=8mm dy=8mm dz=5mm,Very fast
Phantom	Left head
Device Position	Tilt
Band	PCS 1900
Channels	Middle
Signal	TDMA (Crest factor: 8.0)

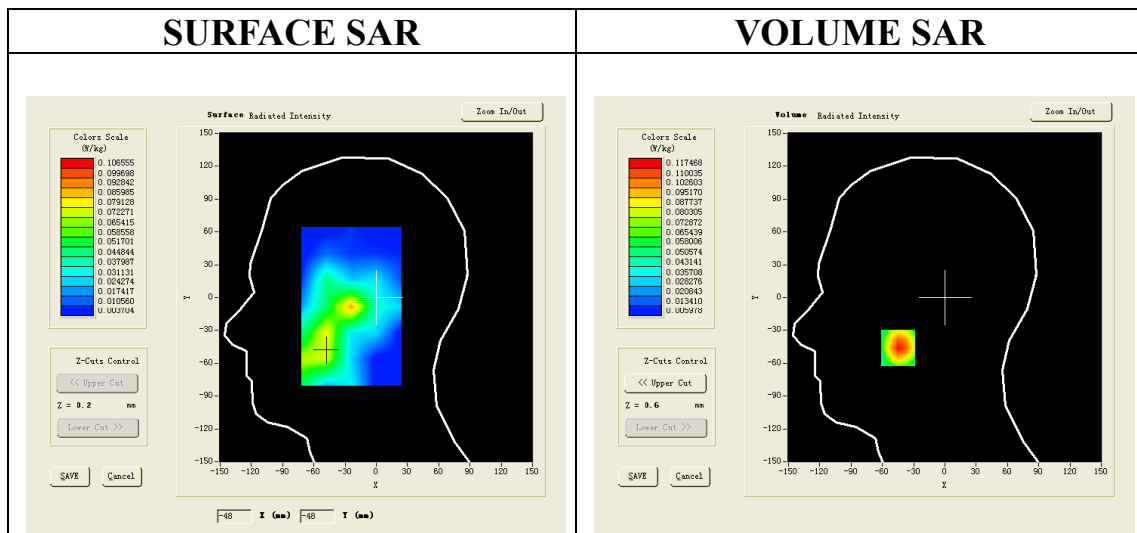

Maximum location: X=-45.00, Y=-46.00

SAR 10g (W/Kg)	0.064406
SAR 1g (W/Kg)	0.110889

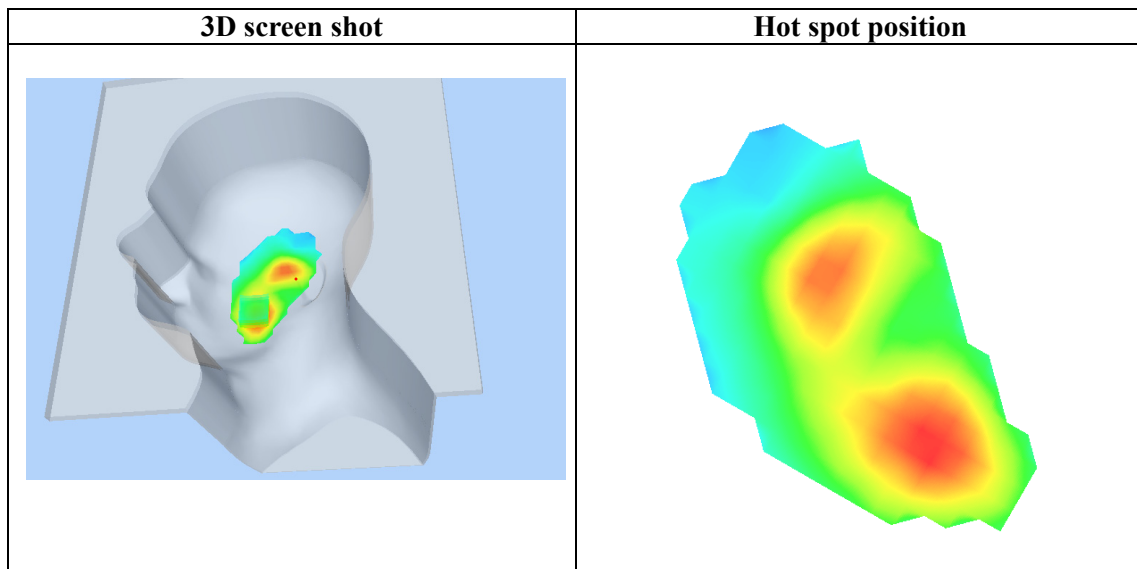
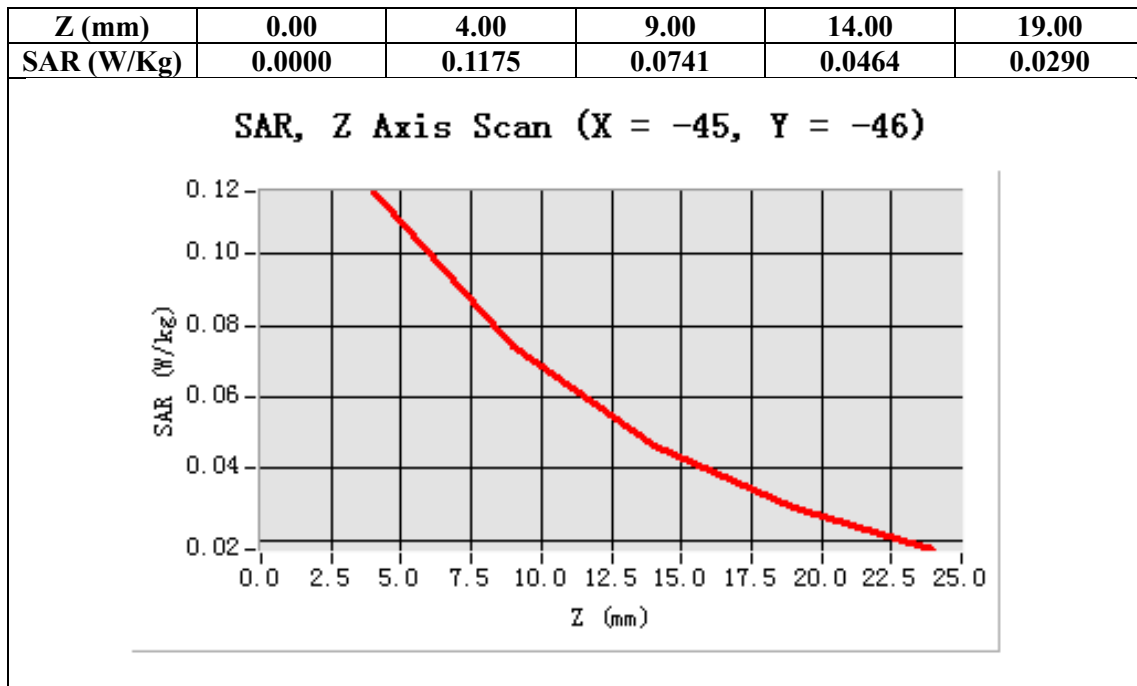

Test Laboratory: AGC Lab
PCS 1900 Mid-Touch-Right <SIM 1>
DUT: Glow Mobile Phone; Type: X200

Date: Jun.28, 2013

Communication System: Generic GSM; Communication System Band: PCS 1900; Duty Cycle: 1:8.3; Conv.F=4.72;
Frequency: 1880 MHz; Medium parameters used: $f = 1900$ MHz; $\sigma = 1.39$ mho/m; $\epsilon_r = 39.84$; $\rho = 1000$ kg/m³ ;
Phantom section: Right Section
Ambient temperature (°C): 21.0, Liquid temperature (°C): 21.0

SATIMO Configuration:

Probe: EP165; Calibrated: 01/31/2013

- Sensor-Surface: 4mm (Mechanical Surface Detection)
- Phantom: Flat Phantom; Type: Elliptical Phantom
- Measurement SW: OpenSAR V4_02_01

Configuration/PCS1900 Mid-Touch-Right/Area Scan: Measurement grid: dx=20mm, dy=20mm
Configuration/PCS1900 Mid-Touch-Right/Zoom Scan: Measurement grid: dx=8mm, dy=8mm, dz=5mm;

Area Scan	sam_direct_droit2_surf8mm.txt
ZoomScan	5x5x7,dx=8mm dy=8mm dz=5mm,Very fast
Phantom	Right head
Device Position	Cheek
Band	PCS 1900
Channels	Middle
Signal	TDMA (Crest factor: 8.0)

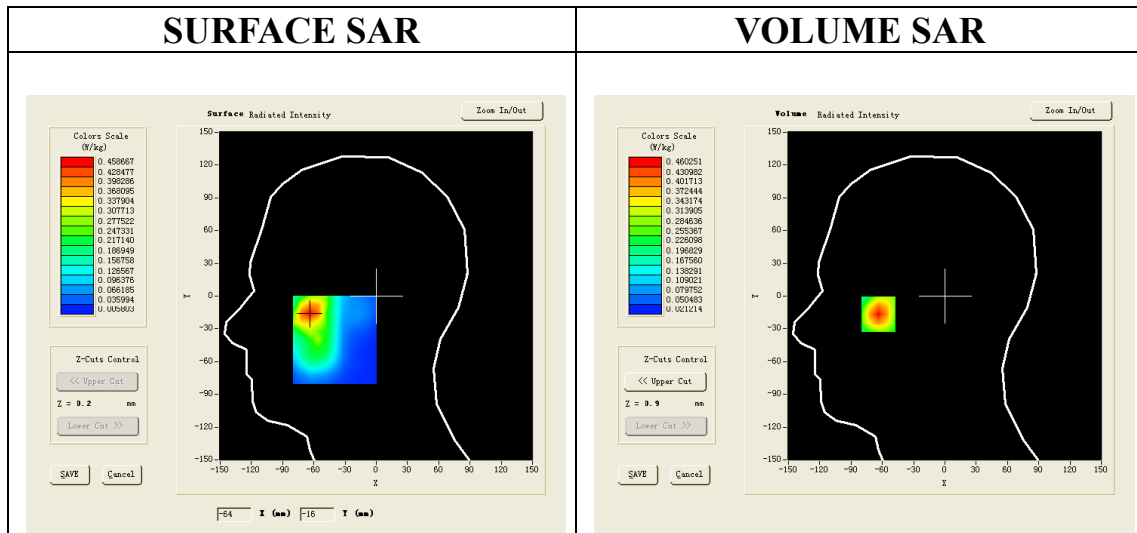

Maximum location: X=-64.00, Y=-16.00

SAR 10g (W/Kg)	0.244923
SAR 1g (W/Kg)	0.429789

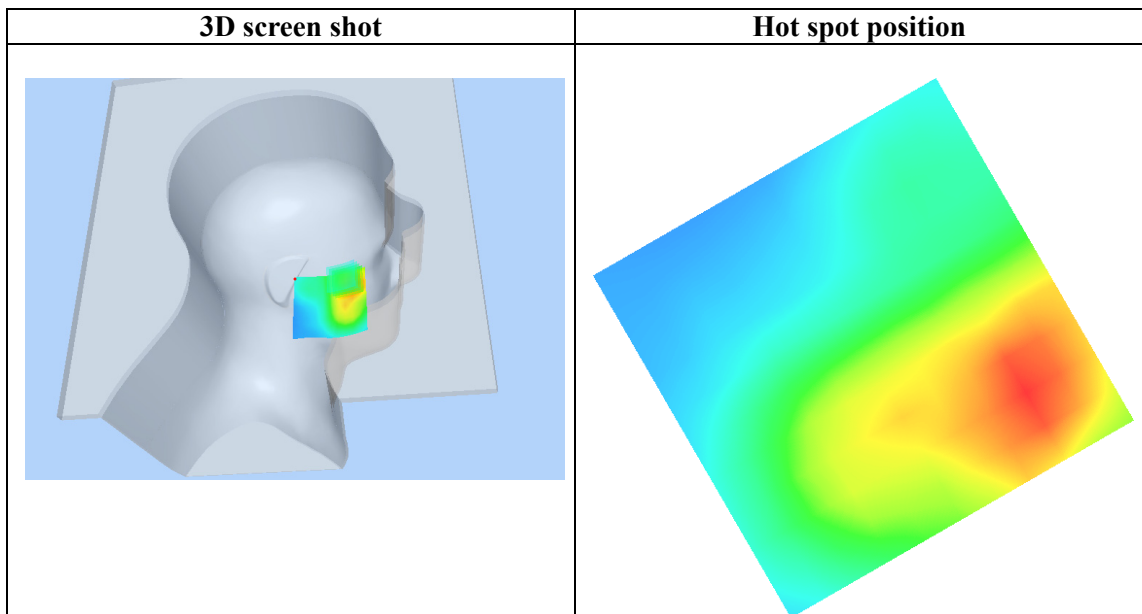
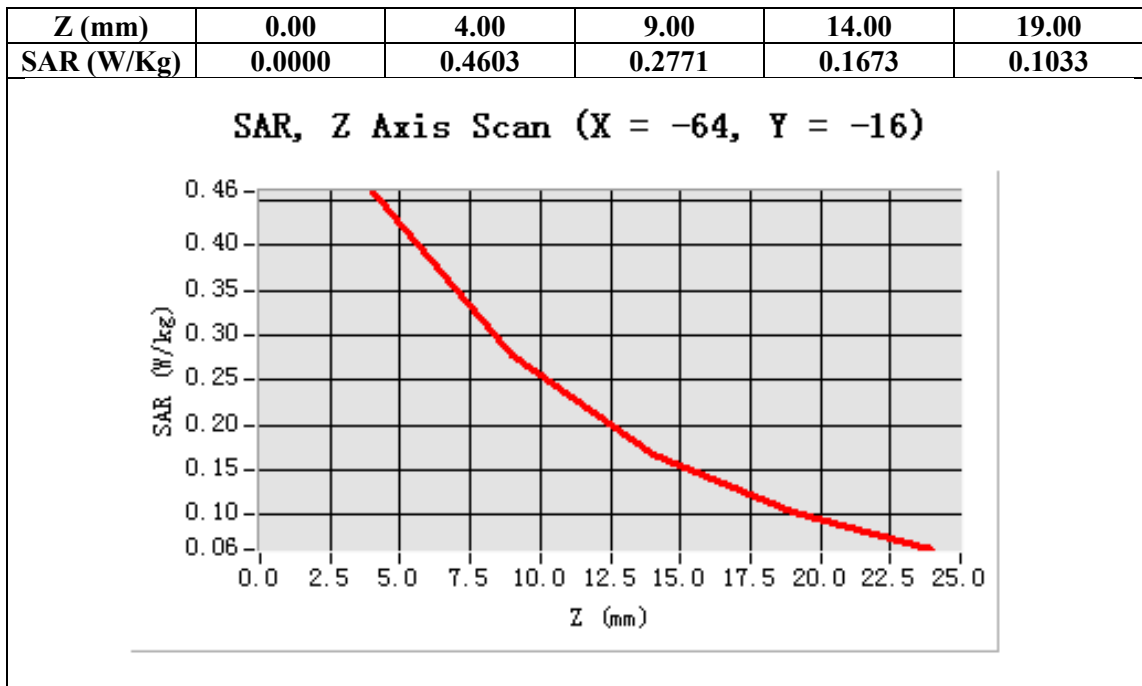

Test Laboratory: AGC Lab
PCS 1900 Mid-Tilt-Right <SIM 1>
DUT: Glow Mobile Phone; Type: X200

Date: Jun.28, 2013

Communication System: Generic GSM; Communication System Band: PCS 1900; Duty Cycle: 1:8.3; Conv.F=4.72;
Frequency: 1880 MHz; Medium parameters used: $f = 1900$ MHz; $\sigma = 1.39$ mho/m; $\epsilon_r = 39.84$; $\rho = 1000$ kg/m³ ;
Phantom section: Right Section
Ambient temperature (°C): 21.0, Liquid temperature (°C): 21.0

SATIMO Configuration:

- Probe: EP165; Calibrated: 01/31/2013
- Sensor-Surface: 4mm (Mechanical Surface Detection)
- Phantom: Flat Phantom; Type: Elliptical Phantom
- Measurement SW: OpenSAR V4_02_01

Configuration/PCS1900 Mid-Tilt-Right/Area Scan: Measurement grid: dx=20mm, dy=20mm
Configuration/PCS1900 Mid-Tilt-Right/Zoom Scan: Measurement grid: dx=8mm, dy=8mm, dz=5mm;

Area Scan	sam_direct_droit2_surf8mm.txt
ZoomScan	5x5x7,dx=8mm dy=8mm dz=5mm,Very fast
Phantom	Right head
Device Position	Tilt
Band	PCS 1900
Channels	Middle
Signal	TDMA (Crest factor: 8.0)

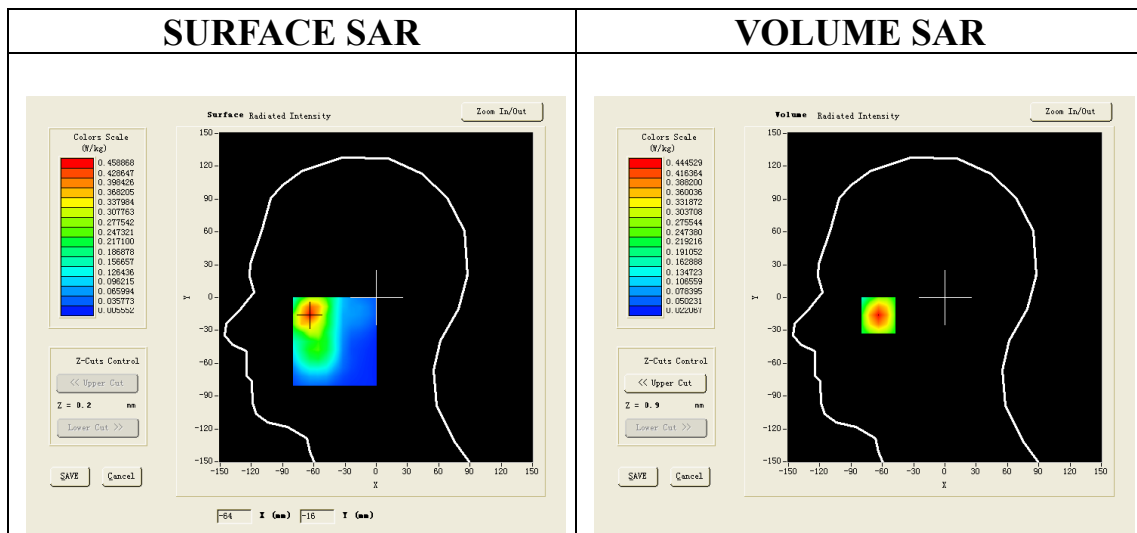

Maximum location: X=-64.00, Y=-15.00

SAR 10g (W/Kg)	0.242262
SAR 1g (W/Kg)	0.414932

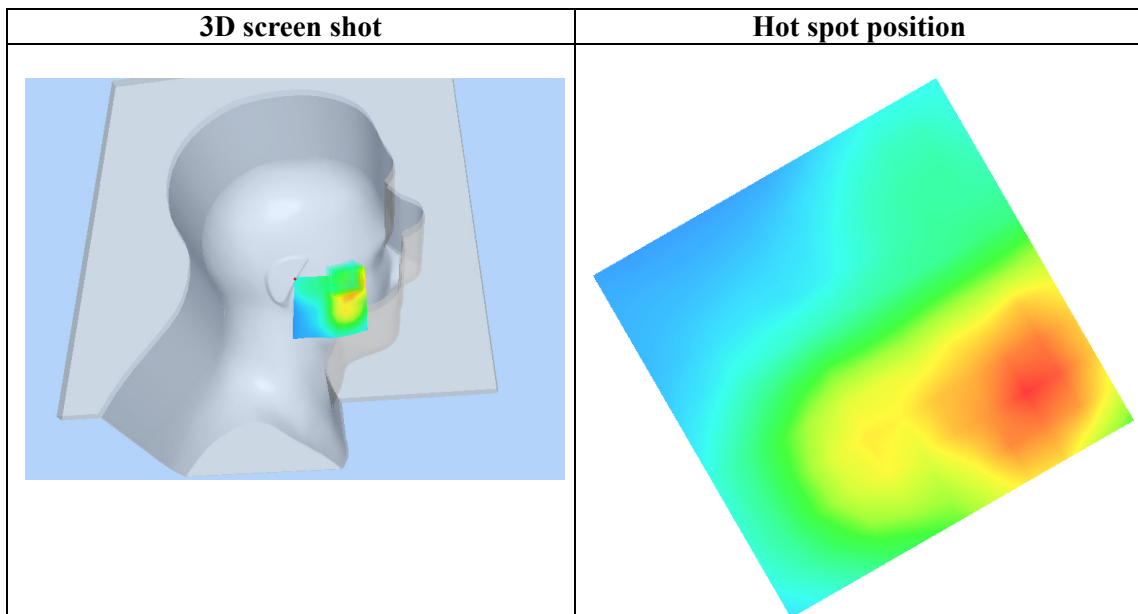
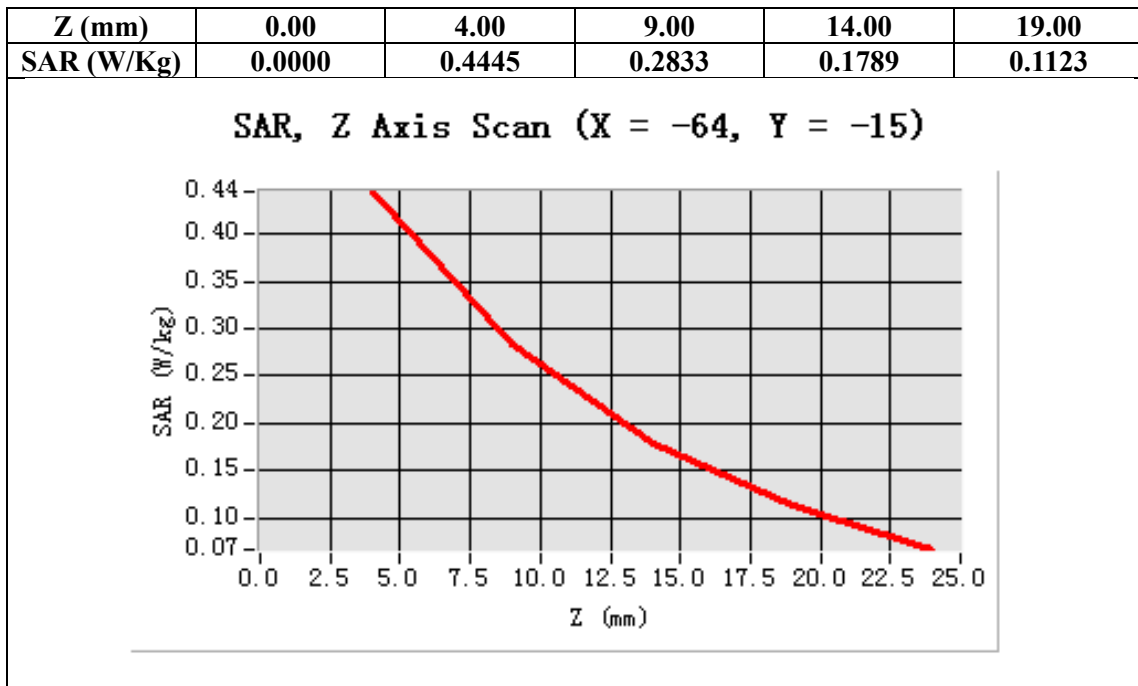

Test Laboratory: AGC Lab
PCS 1900 Mid-Touch-Left <SIM 2>
DUT: Glow Mobile Phone; Type: X200

Date: Jun.28, 2013

Communication System: Generic GSM; Communication System Band: PCS 1900; Duty Cycle: 1:8.3; Conv.F=4.72;
Frequency: 1880 MHz; Medium parameters used: $f = 1900$ MHz; $\sigma = 1.39$ mho/m; $\epsilon_r = 39.84$; $\rho = 1000$ kg/m³ ;
Phantom section: Left Section
Ambient temperature (°C): 21.0, Liquid temperature (°C): 21.0

SATIMO Configuration:

Probe: EP165; Calibrated: 01/31/2013

- Sensor-Surface: 4mm (Mechanical Surface Detection)
- Phantom: Flat Phantom; Type: Elliptical Phantom
- Measurement SW: OpenSAR V4_02_01

Configuration/PCS1900 Mid-Touch-Left/Area Scan: Measurement grid: dx=20mm, dy=20mm
Configuration/PCS1900 Mid-Touch-Left/Zoom Scan: Measurement grid: dx=8mm, dy=8mm, dz=5mm;

Area Scan	sam_direct_droit2_surf8mm.txt
ZoomScan	5x5x7,dx=8mm dy=8mm dz=5mm,Very fast
Phantom	Left head
Device Position	Cheek
Band	PCS 1900
Channels	Middle
Signal	TDMA (Crest factor: 8.0)

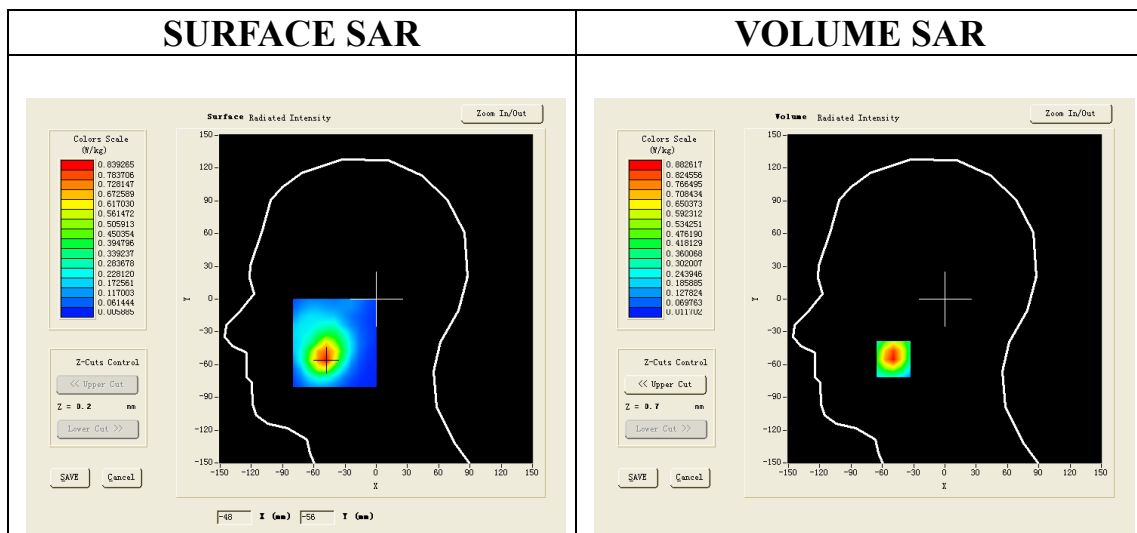

Maximum location: X=-49.00, Y=-55.00

SAR 10g (W/Kg)	0.429580
SAR 1g (W/Kg)	0.831165

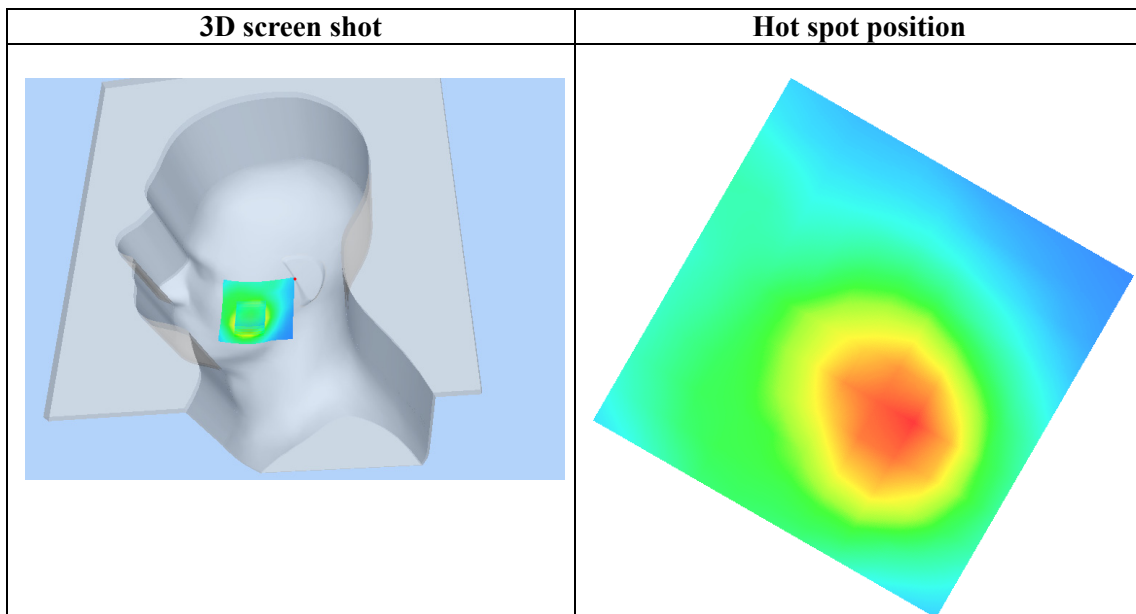
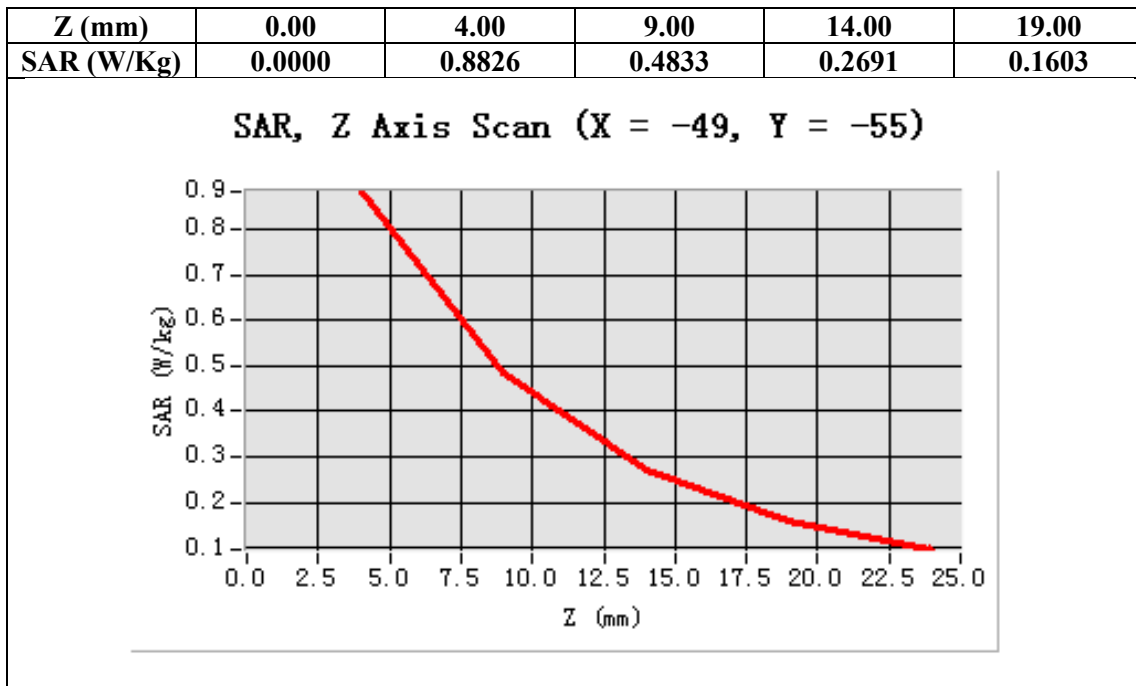

Test Laboratory: AGC Lab
PCS 1900 Mid-Body-Back <SIM 1>
DUT: Glow Mobile Phone; Type: X200

Date: Jun.28, 2013

Communication System: Generic GSM; Communication System Band: PCS 1900; Duty Cycle: 1:8.3; Conv.F=4.84;
Frequency: 1880 MHz; Medium parameters used: $f = 1900$ MHz; $\sigma = 1.49$ mho/m; $\epsilon_r = 54.57$; $\rho = 1000$ kg/m³ ;
Phantom section: Flat Section
Ambient temperature (°C): 21.0, Liquid temperature (°C): 21.0

SATIMO Configuration:

Probe: EP165; Calibrated: 01/31/2013

- Sensor-Surface: 4mm (Mechanical Surface Detection)
- Phantom: Flat Phantom; Type: Elliptical Phantom
- Measurement SW: OpenSAR V4_02_01

Configuration/PCS1900 Mid-Body-Back/Area Scan: Measurement grid: dx=20mm, dy=20mm

Configuration/PCS1900 Mid-Body-Back/Zoom Scan: Measurement grid: dx=8mm, dy=8mm, dz=5mm;

Area Scan	surf_sam_plan.txt
ZoomScan	5x5x7,dx=8mm dy=8mm dz=5mm,Very fast
Phantom	Validation plane
Device Position	Body Back
Band	PCS 1900
Channels	Middle
Signal	TDMA (Crest factor: 8.0)

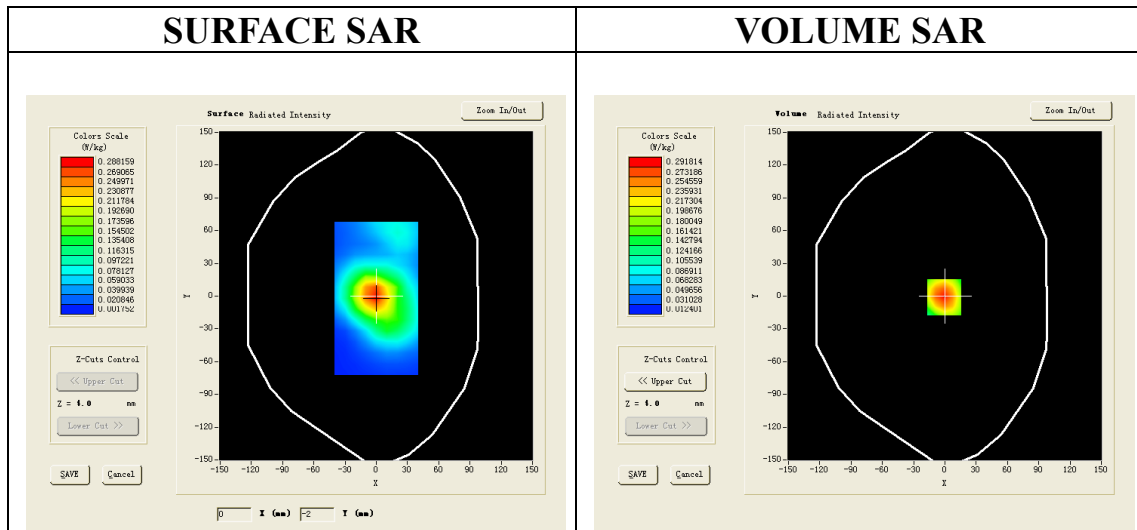

Maximum location: X=-1.00, Y=-1.00

SAR 10g (W/Kg)	0.166854
SAR 1g (W/Kg)	0.298904

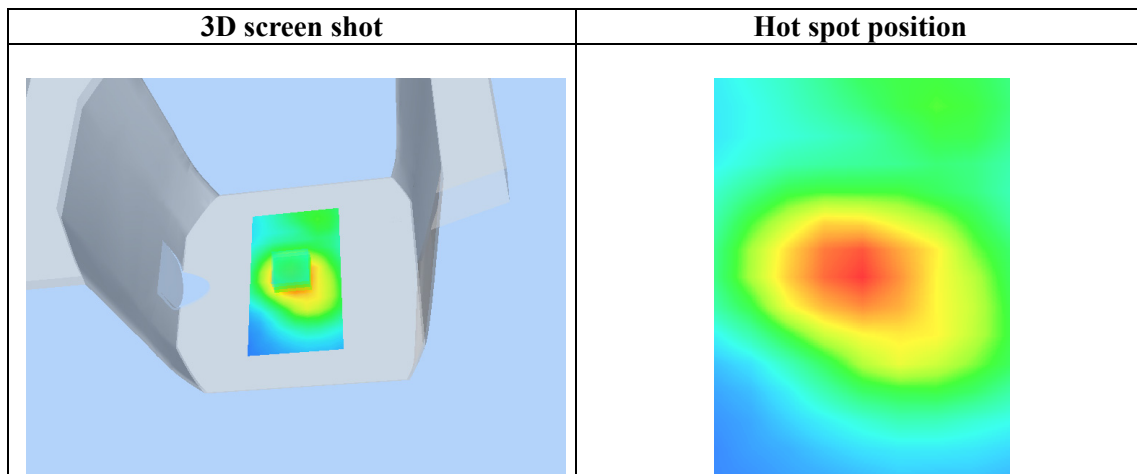
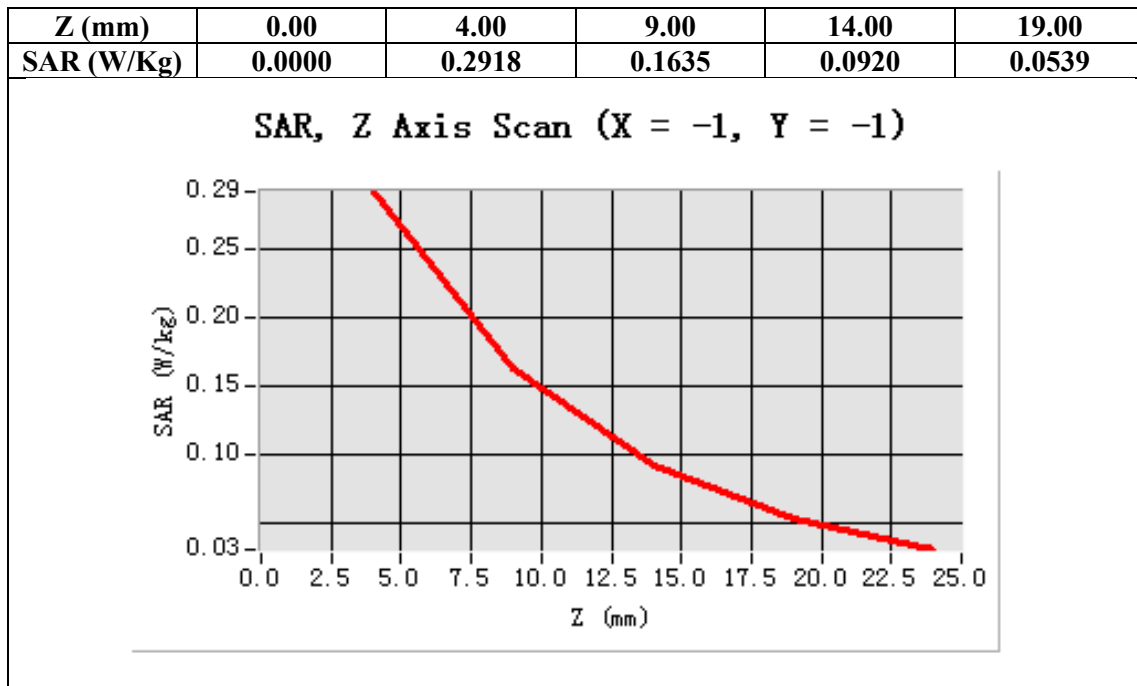

Test Laboratory: AGC Lab
GPRS 1900 Mid-Body-Back (2up) <SIM 1>
DUT: Glow Mobile Phone; Type: X200

Date: Jun.28, 2013

Communication System: GPRS-2 Slot; Communication System Band: PCS1900; Duty Cycle: 1:4.2 ; Conv.F=4.84;
Frequency: 1880 MHz; Medium parameters used: $f = 1900$ MHz; $\sigma=1.49$ mho/m; $\epsilon_r = 54.57$; $\rho = 1000$ kg/m³ ;
Phantom section: Flat Section
Ambient temperature (°C): 21.0, Liquid temperature (°C): 21.0

SATIMO Configuration:

Probe: EP165; Calibrated: 01/31/2013

- Sensor-Surface: 4mm (Mechanical Surface Detection)
- Phantom: Flat Phantom; Type: Elliptical Phantom
- Measurement SW: OpenSAR V4_02_01

Configuration/GPRS1900 Mid-Body-Back/Area Scan: Measurement grid: dx=20mm, dy=20mm
Configuration/GPRS1900 Mid-Body-Back/Zoom Scan: Measurement grid: dx=8mm, dy=8mm, dz=5m;

Area Scan	surf_sam_plan.txt
ZoomScan	5x5x7,dx=8mm dy=8mm dz=5mm,Very fast
Phantom	Validation plane
Device Position	Body Back
Band	PCS 1900
Channels	Middle
Signal	TDMA (Crest factor: 4.0)

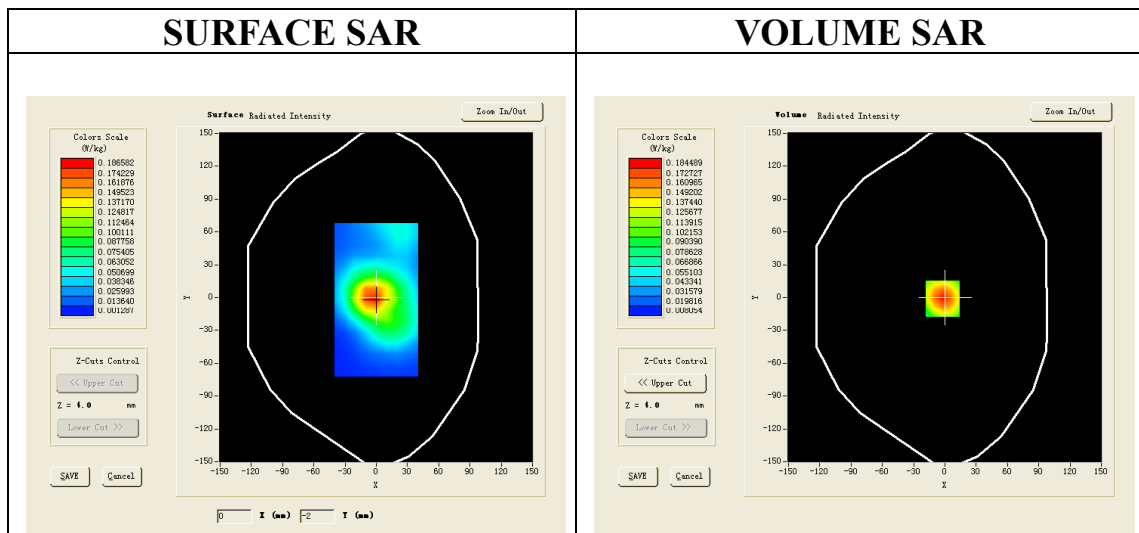

Maximum location: X=-2.00, Y=-1.00

SAR 10g (W/Kg)	0.104387
SAR 1g (W/Kg)	0.189004

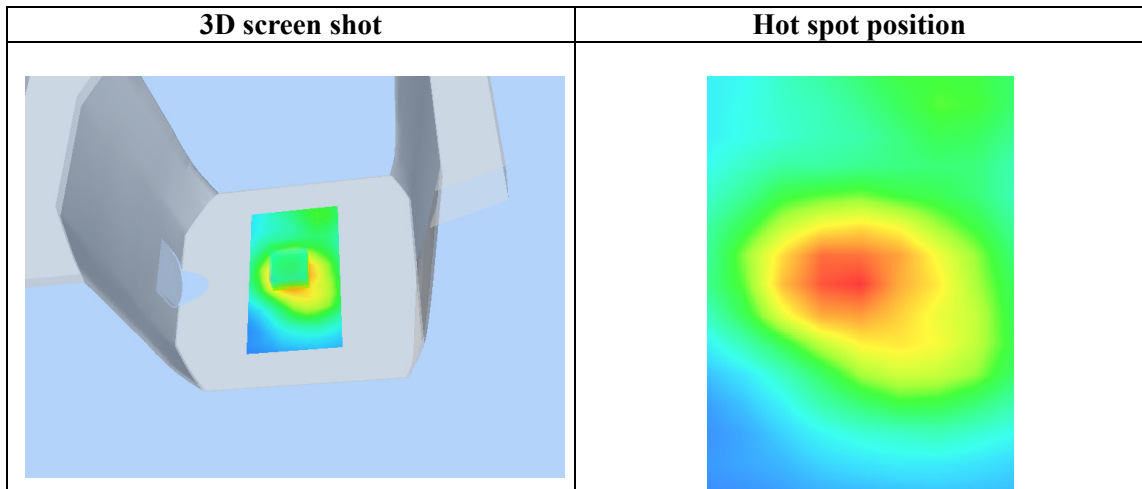
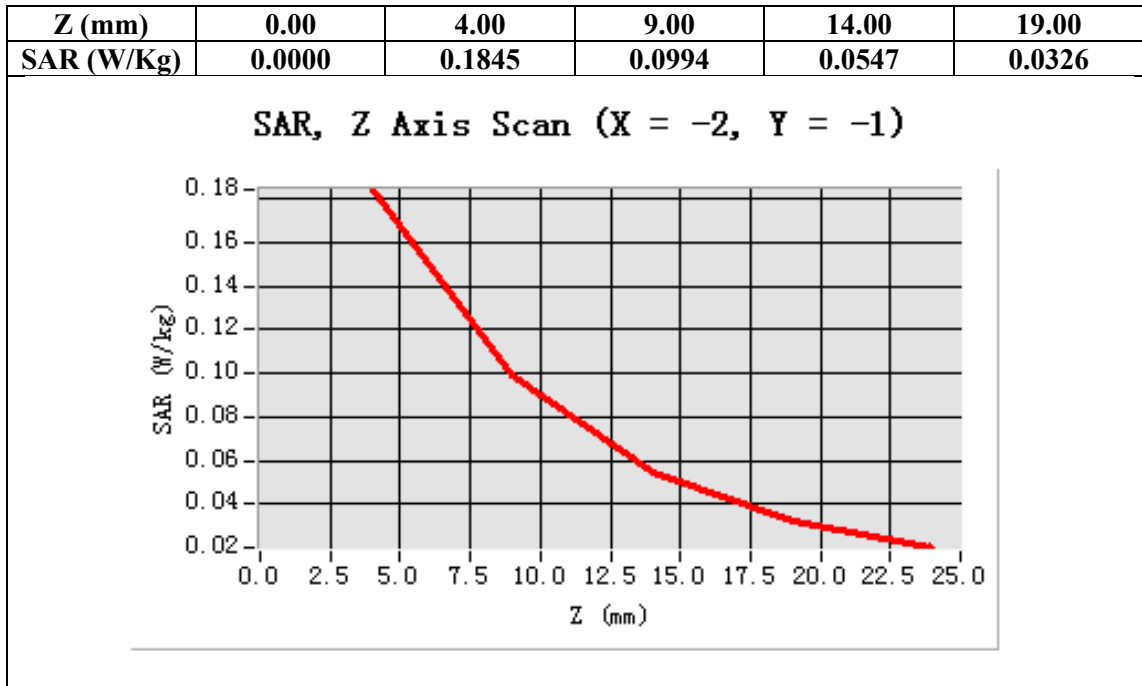

Test Laboratory: AGC Lab
GPRS 1900 Mid-Body-Back (3up) <SIM 1>
DUT: Glow Mobile Phone; Type: X200

Date: Jun.28, 2013

Communication System: GPRS-3 Slot; Communication System Band: PCS 1900; Duty Cycle:1:2.8 ; Conv.F=4.84;
Frequency: 1880 MHz; Medium parameters used: $f = 1900$ MHz; $\sigma = 1.49$ mho/m; $\epsilon_r = 54.57$ $\rho = 1000$ kg/m³ ;
Phantom section: Flat Section
Ambient temperature (°C): 21.0, Liquid temperature (°C): 21.0

SATIMO Configuration:

Probe: EP165; Calibrated: 01/31/2013

- Sensor-Surface: 4mm (Mechanical Surface Detection)
- Phantom: Flat Phantom; Type: Elliptical Phantom
- Measurement SW: OpenSAR V4_02_01

Configuration/GPRS1900 Mid-Body-Back/Area Scan: Measurement grid: dx=20mm, dy=20mm
Configuration/GPRS1900 Mid-Body-Back/Zoom Scan: Measurement grid: dx=8mm, dy=8mm, dz=5mm;

Area Scan	surf_sam_plan.txt
ZoomScan	5x5x7,dx=8mm dy=8mm dz=5mm,Very fast
Phantom	Validation plane
Device Position	Body Back
Band	PCS 1900
Channels	Middle
Signal	TDMA (Crest factor: 2.7)

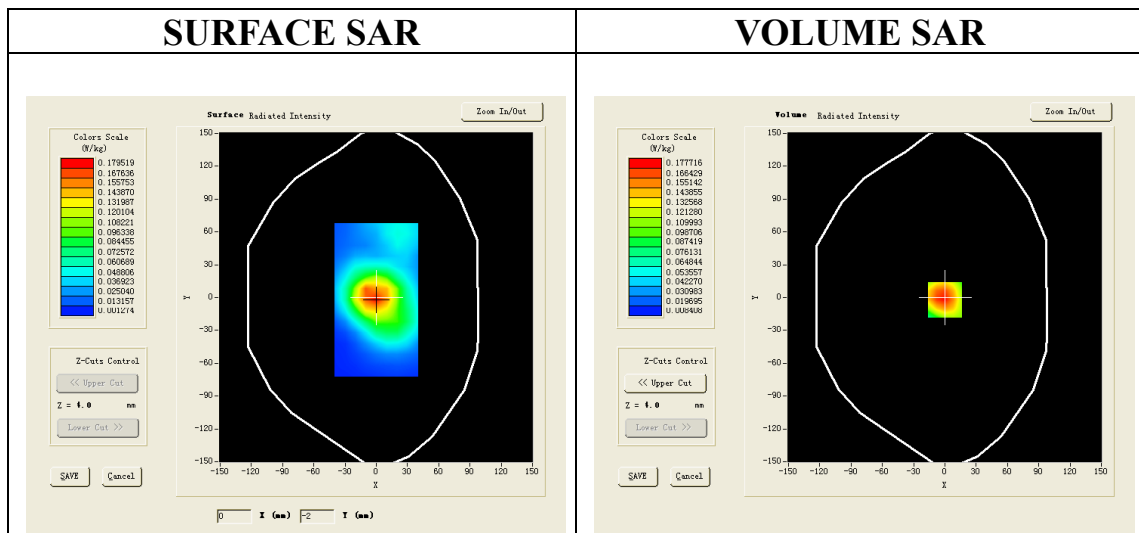

Maximum location: X=0.00, Y=-2.00

SAR 10g (W/Kg)	0.105354
SAR 1g (W/Kg)	0.183557

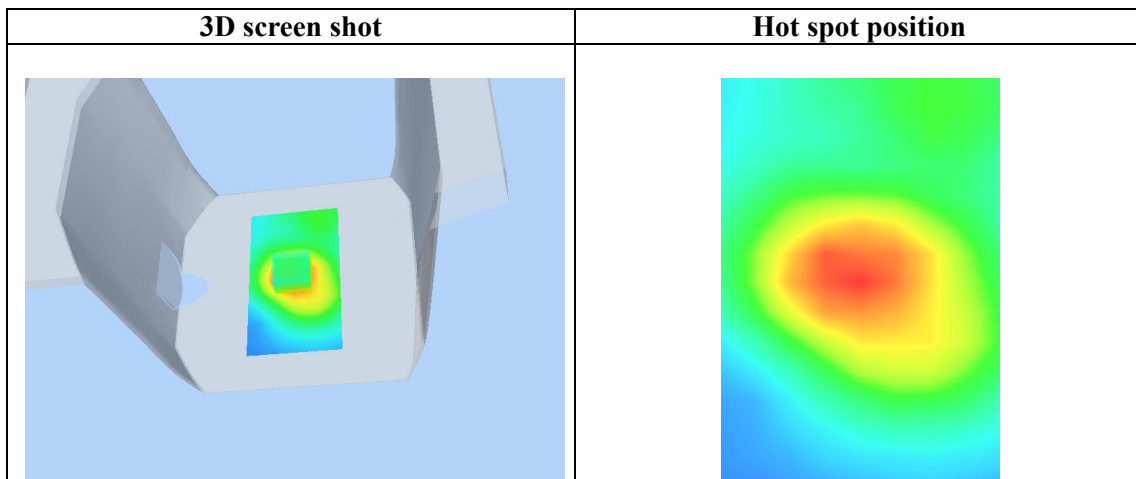
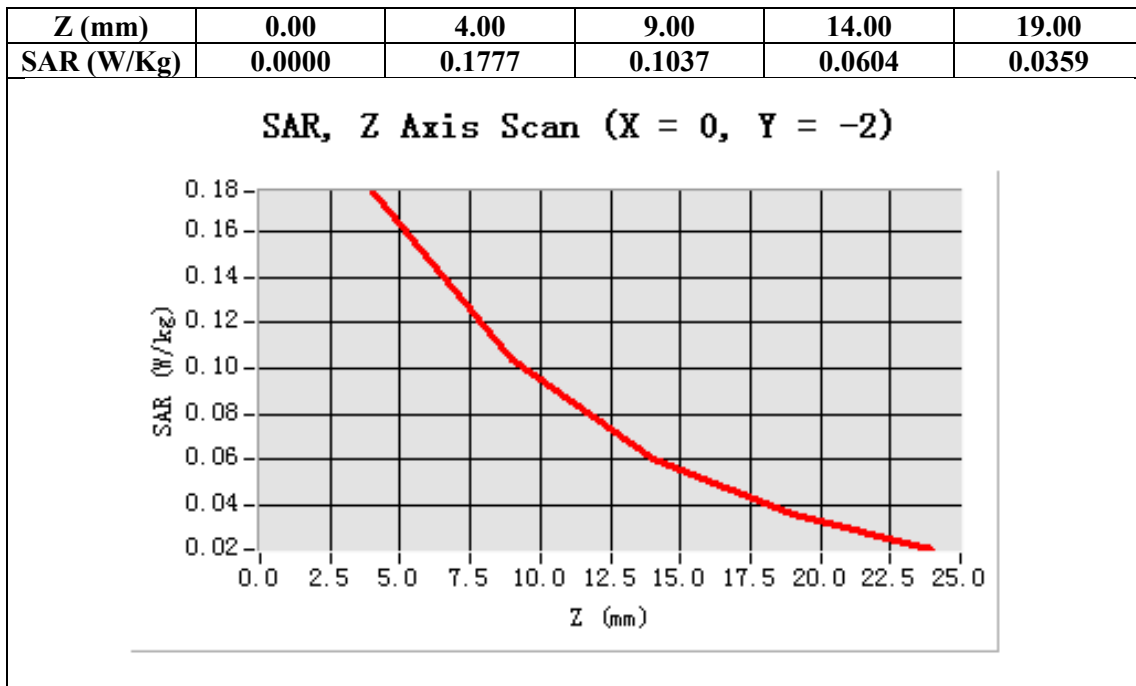

Test Laboratory: AGC Lab
GPRS 1900 Mid-Body- Back (4up) <SIM 1>
DUT: Glow Mobile Phone; Type: X200

Date: Jun.28, 2013

Communication System: GPRS-4 Slot; Communication System Band: PCS 1900; Duty Cycle: 1:2.1; Conv.F=4.84;
Frequency: 1880 MHz; Medium parameters used: $f = 1900$ MHz; $\sigma = 1.49$ mho/m; $\epsilon_r = 54.57$; $\rho = 1000$ kg/m³ ;
Phantom section: Flat Section
Ambient temperature (°C): 21.0, Liquid temperature (°C): 21.0

SATIMO Configuration:

Probe: EP165; Calibrated: 01/31/2013

- Sensor-Surface: 4mm (Mechanical Surface Detection)
- Phantom: Flat Phantom; Type: Elliptical Phantom
- Measurement SW: OpenSAR V4_02_01

Configuration/GPRS1900 Mid-Body-Back/Area Scan: Measurement grid: dx=20mm, dy=20mm
Configuration/GPRS1900 Mid-Body-Back/Zoom Scan: Measurement grid: dx=8mm, dy=8mm, dz=5mm;

Area Scan	surf_sam_plan.txt
ZoomScan	5x5x7,dx=8mm dy=8mm dz=5mm,Very fast
Phantom	Validation plane
Device Position	Body Back
Band	PCS 1900
Channels	Middle
Signal	TDMA (Crest factor: 2.0)

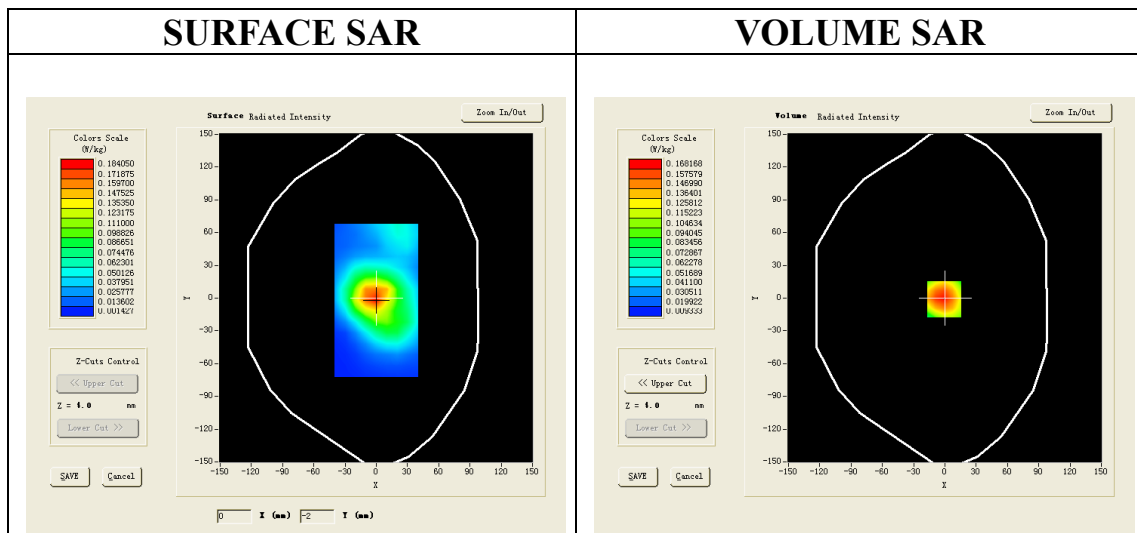

Maximum location: X=-1.00, Y=-1.00

SAR 10g (W/Kg)	0.100103
SAR 1g (W/Kg)	0.173942

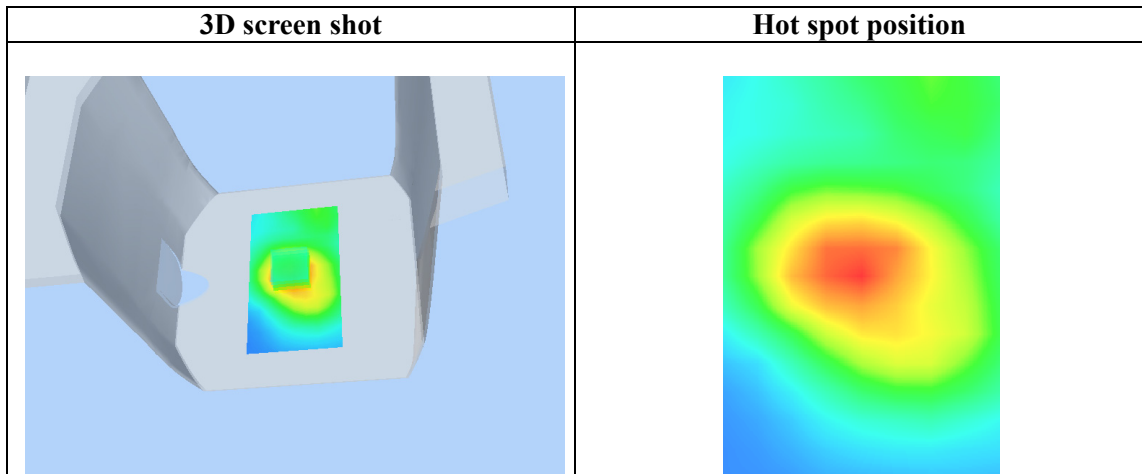
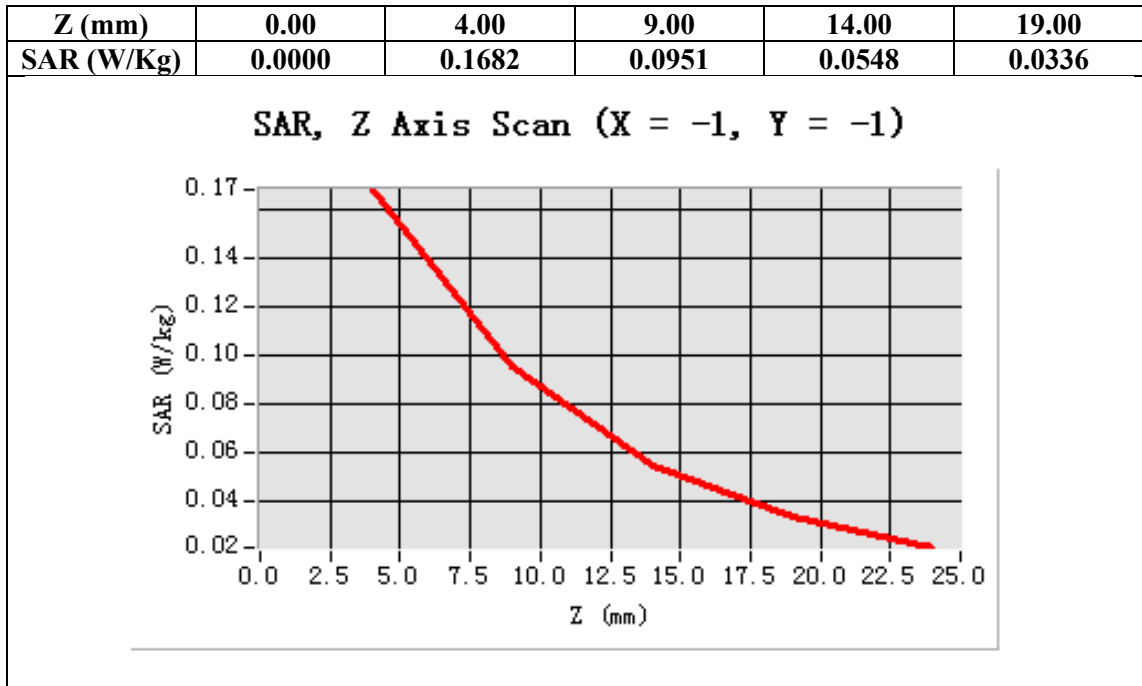

Test Laboratory: AGC Lab
PCS 1900 Mid-Body -Front (MS) <SIM 1>
DUT: Glow Mobile Phone; Type: X200

Date: Jun.28, 2013

Communication System: Generic GSM; Communication System Band: PCS 1900; Duty Cycle: 1:8.3; Conv.F=4.84;
Frequency: 1880 MHz; Medium parameters used: $f = 1900$ MHz; $\sigma = 1.49$ mho/m; $\epsilon_r = 54.57$; $\rho = 1000$ kg/m³ ;
Phantom section: Flat Section
Ambient temperature (°C): 21.0, Liquid temperature (°C): 21.0

SATIMO Configuration:

Probe: EP165; Calibrated: 01/31/2013

- Sensor-Surface: 4mm (Mechanical Surface Detection)
- Phantom: Flat Phantom; Type: Elliptical Phantom
- Measurement SW: OpenSAR V4_02_01

Configuration/PCS1900 Mid-Body- Front /Area Scan: Measurement grid: dx=20mm, dy=20mm
Configuration/PCS1900 Mid-Body- Front /Zoom Scan: Measurement grid: dx=8mm, dy=8mm, dz=5mm;

Area Scan	surf_sam_plan.txt
ZoomScan	5x5x7,dx=8mm dy=8mm dz=5mm,Very fast
Phantom	Validation plane
Device Position	Body Front
Band	PCS 1900
Channels	Middle
Signal	TDMA (Crest factor: 8.0)

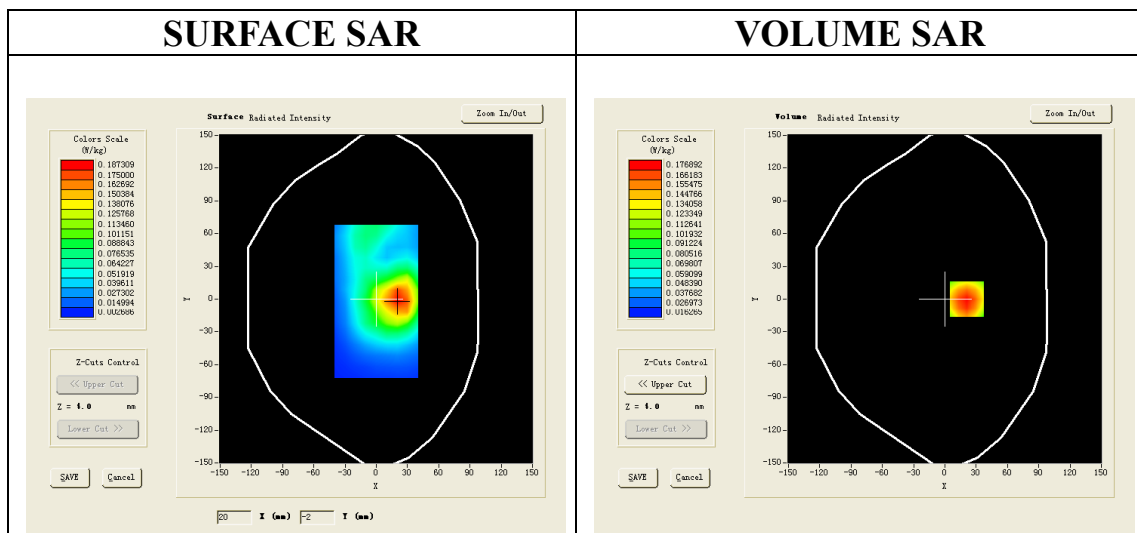

Maximum location: X=21.00, Y=0.00

SAR 10g (W/Kg)	0.113949
SAR 1g (W/Kg)	0.183042

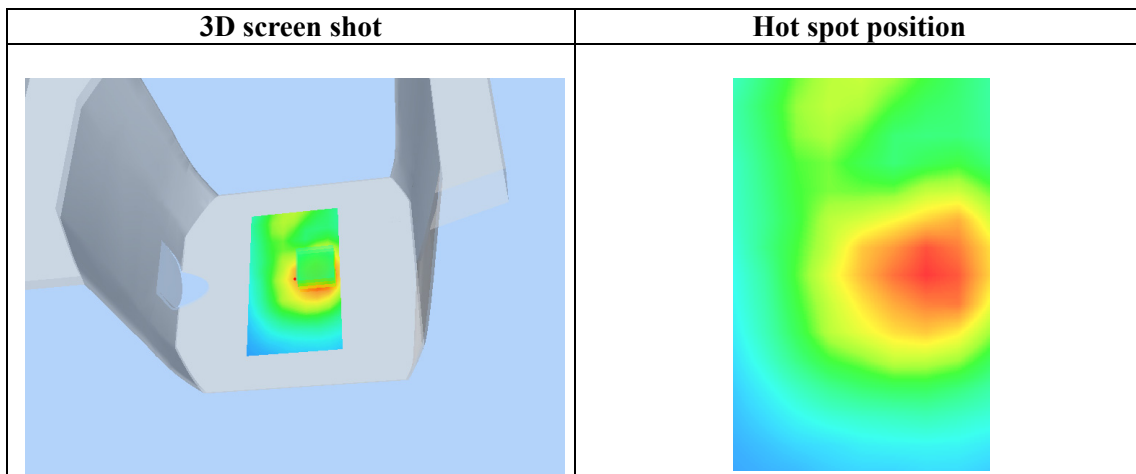
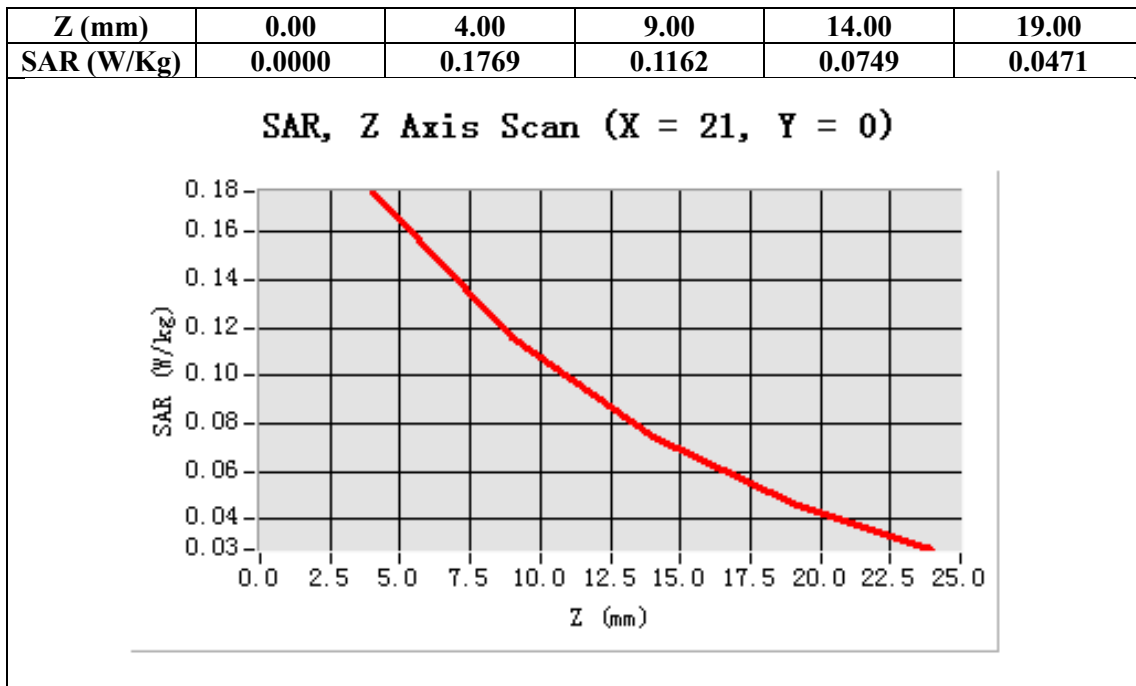

Test Laboratory: AGC Lab
PCS 1900 Mid-Body- Back (MS) –with earphone <SIM 1>
DUT: Glow Mobile Phone; Type: X200

Date: Jun.28, 2013

Communication System: Generic GSM; Communication System Band: PCS 1900; Duty Cycle: 1:8.3; Conv.F=4.84;
Frequency: 1880 MHz; Medium parameters used: $f = 1900$ MHz; $\sigma = 1.49$ mho/m; $\epsilon_r = 54.57$; $\rho = 1000$ kg/m³ ;
Phantom section: Flat Section
Ambient temperature (°C): 21.0, Liquid temperature (°C): 21.0

SATIMO Configuration:

Probe: EP165; Calibrated: 01/31/2013

- Sensor-Surface: 4mm (Mechanical Surface Detection)
- Phantom: Flat Phantom; Type: Elliptical Phantom
- Measurement SW: OpenSAR V4_02_01

Configuration/PCS1900 Mid-Body-Back/Area Scan: Measurement grid: dx=20mm, dy=20mm
Configuration/PCS1900 Mid-Body-Back/Zoom Scan: Measurement grid: dx=8mm, dy=8mm, dz=5mm;

Area Scan	surf_sam_plan.txt
ZoomScan	5x5x7,dx=8mm dy=8mm dz=5mm,Very fast
Phantom	Validation plane
Device Position	Body Back
Band	PCS 1900
Channels	Middle
Signal	TDMA (Crest factor: 8.0)

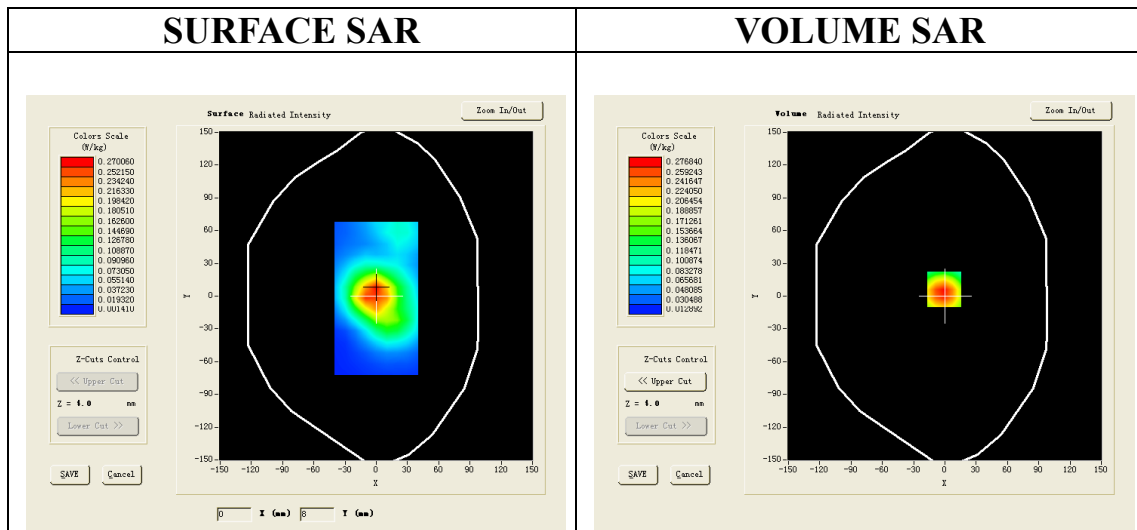

Maximum location: X=-1.00, Y=6.00

SAR 10g (W/Kg)	0.167046
SAR 1g (W/Kg)	0.287262

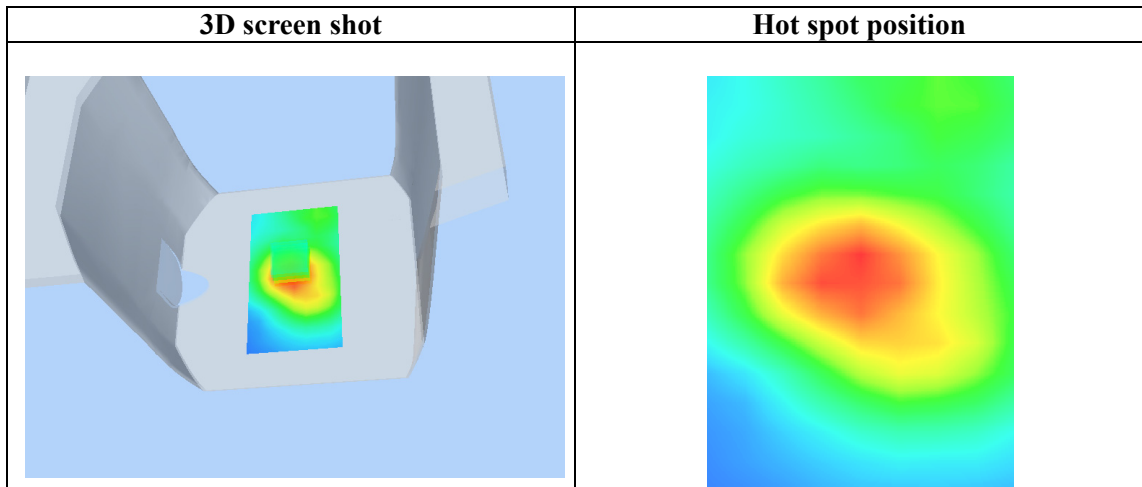
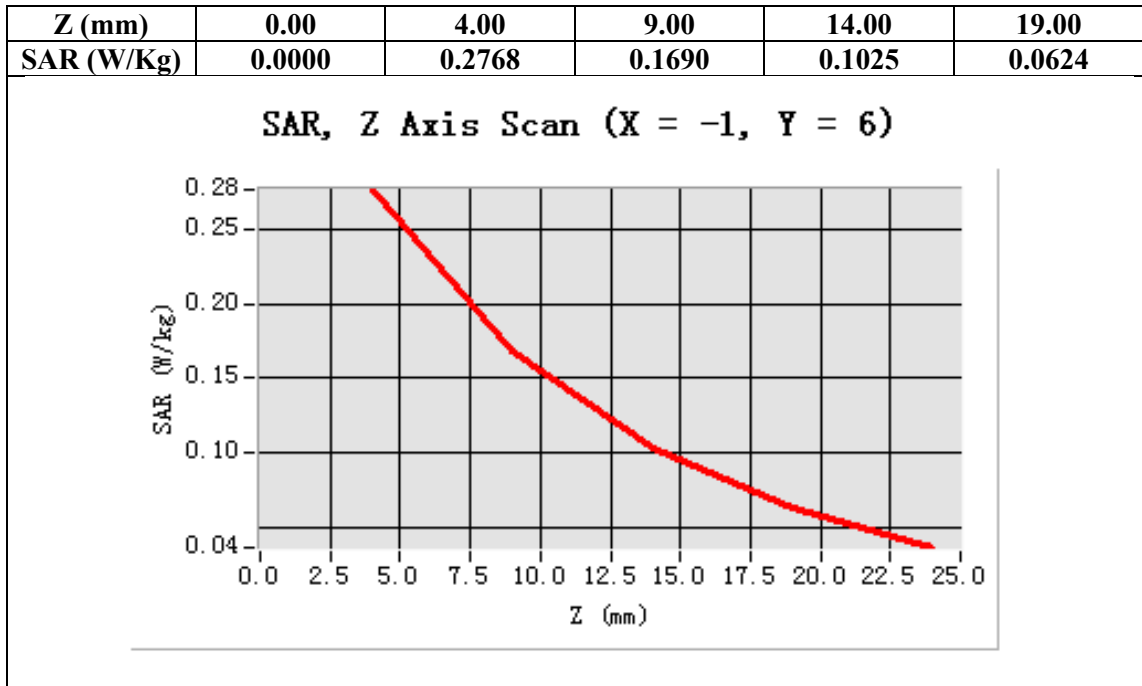

Test Laboratory: AGC Lab
PCS 1900 Mid-Touch- Left <SIM 1>
DUT: Glow Mobile Phone; Type: X200

Date: Jun.28, 2013

Communication System: Generic GSM; Communication System Band: PCS 1900; Duty Cycle: 1:8.3; Conv.F=4.72;
Frequency: 1880 MHz; Medium parameters used: $f = 1900$ MHz; $\sigma = 1.39$ mho/m; $\epsilon_r = 39.84$; $\rho = 1000$ kg/m³ ;
Phantom section: Left Section
Ambient temperature (°C): 21.0, Liquid temperature (°C): 21.0

SATIMO Configuration:

Probe: EP165; Calibrated: 01/31/2013

- Sensor-Surface: 4mm (Mechanical Surface Detection)
- Phantom: Flat Phantom; Type: Elliptical Phantom
- Measurement SW: OpenSAR V4_02_01

Configuration/PCS1900 Mid-Touch-Left/Area Scan: Measurement grid: dx=20mm, dy=20mm
Configuration/PCS1900 Mid-Touch-Left/Zoom Scan: Measurement grid: dx=8mm, dy=8mm, dz=5mm;

Area Scan	sam_direct_droit2_surf8mm.txt
ZoomScan	5x5x7,dx=8mm dy=8mm dz=5mm,Very fast
Phantom	Left head
Device Position	Cheek
Band	PCS 1900
Channels	Middle
Signal	TDMA (Crest factor: 8.0)

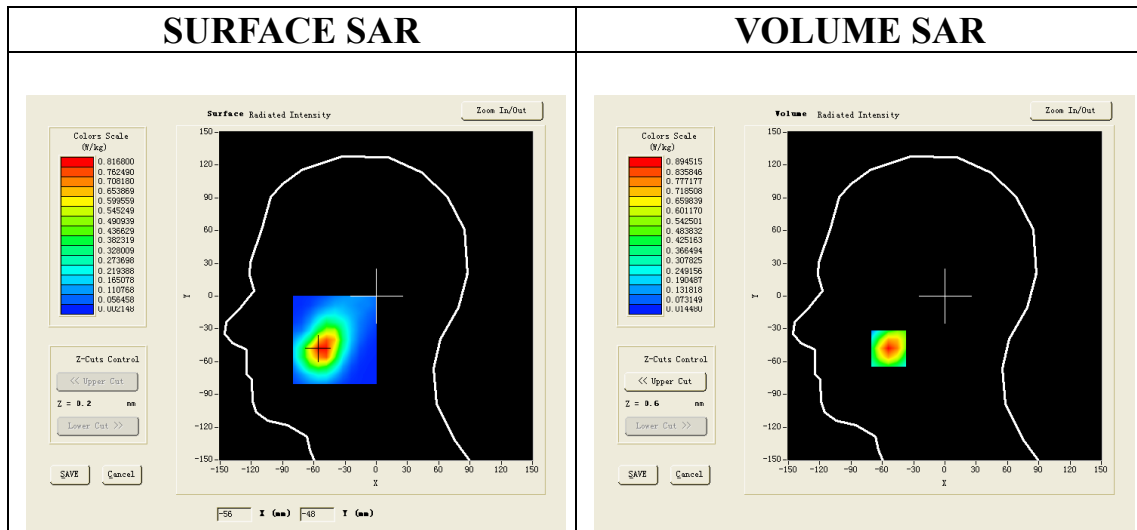

Maximum location: X=-54.00, Y=-48.00

SAR 10g (W/Kg)	0.456529
SAR 1g (W/Kg)	0.832159

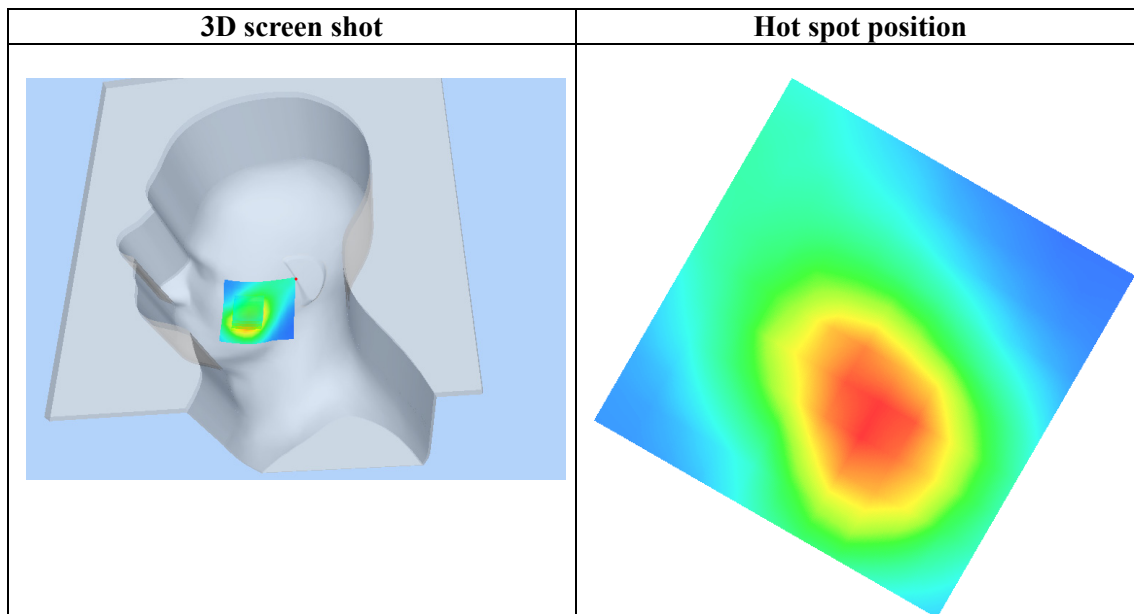
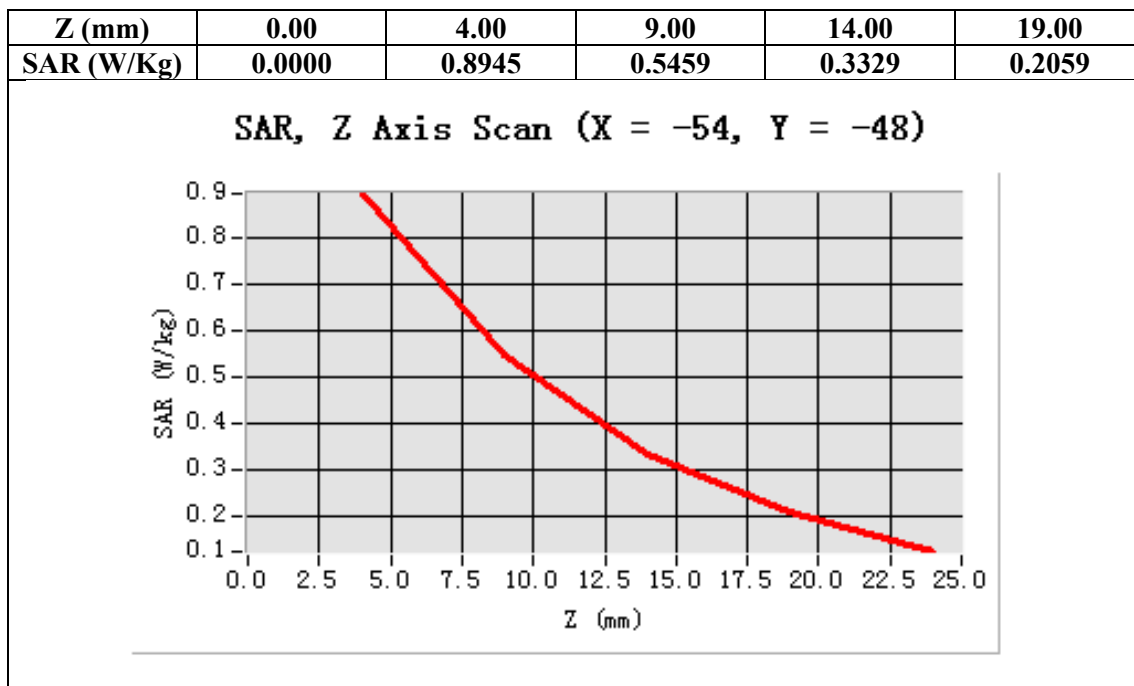

Test Laboratory: AGC Lab
PCS 1900 Mid-Touch-Left <SIM 2>
DUT: Glow Mobile Phone; Type: X200

Date: Jun.28, 2013

Communication System: Generic GSM; Communication System Band: PCS 1900; Duty Cycle: 1:8.3; Conv.F=4.72;
Frequency: 1880 MHz; Medium parameters used: $f = 1900$ MHz; $\sigma = 1.39$ mho/m; $\epsilon_r = 39.84$; $\rho = 1000$ kg/m³ ;
Phantom section: Left Section
Ambient temperature (°C): 21.0, Liquid temperature (°C): 21.0

SATIMO Configuration:

Probe: EP165; Calibrated: 01/31/2013

- Sensor-Surface: 4mm (Mechanical Surface Detection)
- Phantom: Flat Phantom; Type: Elliptical Phantom
- Measurement SW: OpenSAR V4_02_01

Configuration/PCS1900 Mid-Touch-Left/Area Scan: Measurement grid: dx=20mm, dy=20mm
Configuration/PCS1900 Mid-Touch-Left/Zoom Scan: Measurement grid: dx=8mm, dy=8mm, dz=5mm;

Area Scan	sam_direct_droit2_surf8mm.txt
ZoomScan	5x5x7,dx=8mm dy=8mm dz=5mm,Very fast
Phantom	Left head
Device Position	Cheek
Band	PCS 1900
Channels	Middle
Signal	TDMA (Crest factor: 8.0)

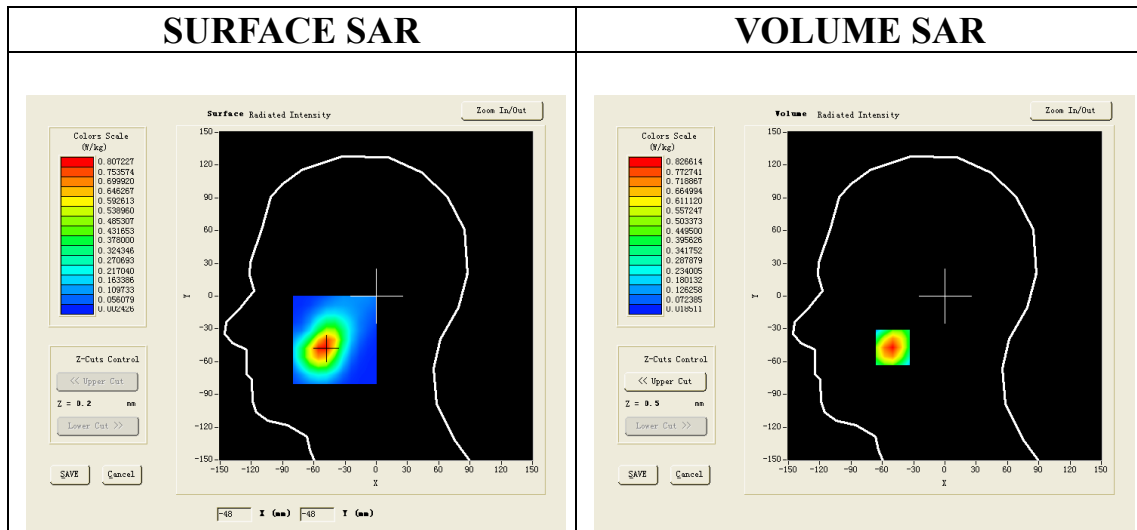

Maximum location: X=-50.00, Y=-47.00

SAR 10g (W/Kg)	0.436359
SAR 1g (W/Kg)	0.801368

