

#

SAR Test Report

Report No.:AGC20J120301S1

FCC ID : Y7WPLUMS107
Product Designation : Tingle
Brand Name : plum
Model Name : S107
Client : CLC Technology Co. Ltd
Date of Issue : Apr.16,2012
STANDARD(S) : FCC Oet65 Supplement C June 2001
: IEEE Std. 1528-2003,47CFR § 2.1093

Attestation of Global Compliance Co., Ltd.

CAUTION: This report shall not be reproduced except in full without the written permission of the test laboratory and shall not be quoted out of context.

Test Report Certification

Applicant Name	: CLC Technology Co. Ltd
Applicant Address	: 907 Hart Avenue Plaza, 5-9A Hart Avenue, Tsim Sha Tsui, Kowloon, Hong Kong
Manufacturer Name	: CLC Technology Co. Ltd
Manufacturer Address	: Room 303, Block 31, Longtang Industrial Zone, Longtang Community Minzhi Street, Bao'an District, Shenzhen, China
Product Designation	: Tingle
Brand Name	: plum
Model Name	: S107
EUT Voltage	: DC3.7V(Supply by battery)
Applicable Standard	: FCC Oet65 Supplement C June 2001 IEEE Std. 1528-2003,47CFR § 2.1093
Test Date	: Apr.14,2012
Test Results	: MAX SAR MEASUREMENT(1g) Head:0.360 W/Kg (Scaling SAR = 0.447 W/Kg) Body:0.430 W/Kg
Performed Location	: Attestation of Global Compliance (Shenzhen) Co., Ltd. 2F, No.2 Building, Huafeng No.1 Technical Industrial Park, Sanwei, Xixiang, Bao'an District, Shenzhen, China



 Tested By Angela Li Apr.16,2012



 Checked By Forrest Lei Apr.16,2012



 Authorized By Solger Zhang Apr.16,2012

TABLE OF CONTENTS

1. GENERAL INFORMATION.....	3
1.1. EUT DESCRIPTION.....	3
GMSK FOR GSM/GPRS.....	3
1.2. TEST PROCEDURE	4
1.3. TEST ENVIRONMENT	4
2. SAR MEASUREMENT SYSTEM.....	5
2.1. COMOSAR SYSTEM DESCRIPTION	5
2.2. COMOSAR E-FIELD PROBE	7
2.3 ROBOT	7
2.4. VIDEO POSITIONING SYSTEM	8
2.5. DEVICE HOLDER	8
2.6. SAM TWIN PHANTOM	9
3. TISSUE SIMULATING LIQUID	10
3.1. THE COMPOSITION OF THE TISSUE SIMULATING LIQUID	10
3.2. TISSUE CALIBRATION RESULT	10
3.3. TISSUE DIELECTRIC PARAMETERS FOR HEAD AND BODY PHANTOMS	11
4. SAR MEASUREMENT PROCEDURE	11
4.1. SAR SYSTEM VALIDATION	12
4.2. SAR MEASUREMENT PROCEDURE.....	14
5. SAR EXPOSURE LIMITS.....	15
6. TEST EQUIPMENT LIST	16
7. MEASUREMENT UNCERTAINTY	17
8. CONDUCTED POWER MEASUREMENT	18
9. TEST RESULTS.....	19
9.1. SAR TEST RESULTS SUMMARY.....	19
APPENDIX A. SAR SYSTEM VALIDATION DATA.....	24
APPENDIX B. SAR MEASUREMENT DATA	28
APPENDIX C. TEST SETUP PHOTOGRAPHS &EUT PHOTOGRAPS	94
APPENDIX D. PROBE CALIBRATION DATA	101
APPENDIX E. DIPOLE CALIBRATION DATA.....	117

1. General Information

1.1. EUT Description

General Information	
Product Designation	Tingle
Test Model	S107
Hardware Version	Z318_MB_PCB_V5.0_110617
Software Version	Z318B1_V10_KX_SAM116_MUL_120223
Device Category	Portable
RF Exposure Environment	Uncontrolled
Antenna Type	Internal
GSM and GPRS	
Support Band	<input checked="" type="checkbox"/> GSM 850 <input checked="" type="checkbox"/> PCS 1900 (U.S. Bands) <input checked="" type="checkbox"/> GSM 900 <input checked="" type="checkbox"/> DCS 1800 (Non-U.S. Bands)
GPRS Type	Class B
GPRS Class	Class 8,10 12(1Tx+4Rx, 2Tx+3Rx,3Tx+2Rx, 4Tx+1Rx))
TX Frequency Range	GSM 850: 824.2~848.8MHz PCS 1900: 1850.2~1909.8MHz
RX Frequency Range	GSM 850: 869~894MHz PCS 1900: 1930~1990MHz
Release Version	R99
Type of modulation	GMSK for GSM/GPRS
Antenna Gain	1.0dBi
Max. Output Power (Avg. Burst Power)	GSM850: 31.84 dBm (32.87dBm Peak Power) PCS1900:29.74 dBm (29.83 dBm Peak Power)
Max. Output Power (Radiated)	GSM850: 30.87 dBm- ERP PCS1900: 28.33 dBm- EIRP
Bluetooth	
Bluetooth Frequency	2402~2480MHz
Type of modulation	<input checked="" type="checkbox"/> GFSK <input checked="" type="checkbox"/> π/4-DQPSK <input checked="" type="checkbox"/> 8-DPSK
Data Rate	<input checked="" type="checkbox"/> 1Mbps <input checked="" type="checkbox"/> 2Mbps <input checked="" type="checkbox"/> 3Mbps

Antenna Gain	0.8dBi
Accessories	
Battery	Brand name: plum Model No. : S107 Voltage and Capacitance: DC 3.7V/1000mAh
Adapter	Brand name: plum Model No. : S107 Input&Output: 110-240 V, 0.15A, 50-60 Hz / 5 V,500MA, 5
Earphone	Brand name: plum Model No. : S107

Note: The sample used for testing is end product.

1.2. Test Procedure

1	Setup the EUT and simulators as shown on above.
2	Turn on the power of all equipment.
3	EUT communicate with CMU 200, and test them respectively at GSM 850 & PCS1900 bands#

1.3. Test Environment

Ambient conditions in the laboratory:

Items	Required	Actual
Temperature (°C)	18-25	21± 2
Humidity (%RH)	30-70	55±2

2. SAR Measurement System

2.1. COMOSAR System Description

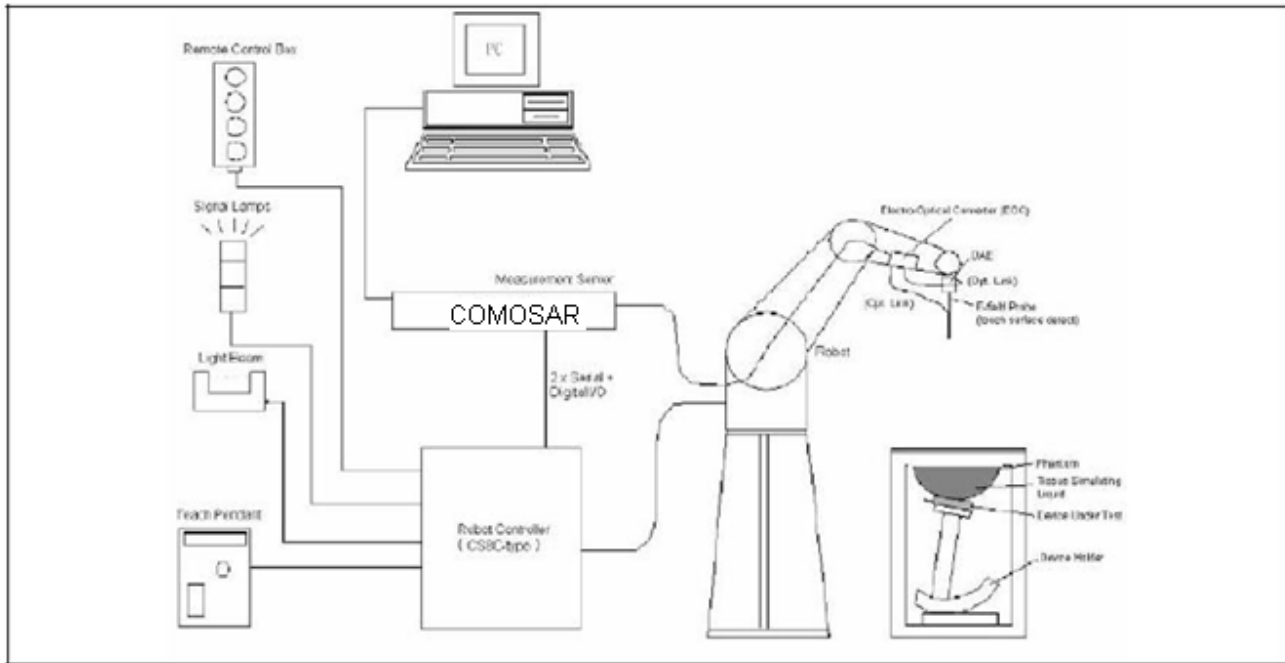

The COMOSAR system for performing compliance tests consists of the following items:

A standard high precision 6-axis robot with controller, teach pendant and software.

An arm extension for accommodating the data acquisition electronics (DAE).

A data acquisition electronics (DAE) which performs the signal amplification, signal multiplexing, AD-conversion, offset measurements, mechanical surface detection, collision detection, etc. The unit is battery powered with standard or rechargeable batteries. The signal is optically transmitted to the EOC.

The Electro-optical converter (EOC) performs the conversion from optical to electrical signals for the digital communication to the DAE. To use optical surface detection, a special version of the EOC is required. The EOC signal is transmitted to the measurement server.

The Light Beam used is for probe alignment. This improves the (absolute) accuracy of the probe positioning.

A computer running WinXP and the Opensar software.

Remote control and teach pendant as well as additional circuitry for robot safety such as warning lamps, etc.

The phantom, the device holder and other accessories according to the targeted measurement.

2.1.1. Applications

Predefined procedures and evaluations for automated compliance testing with all worldwide standards, e.g., IEEE 1528, OET 65, IEC 62209-1, IEC 62209-2, EN 50360, EN 50383 and others.

2.1.2. Area Scans

Area scans are defined prior to the measurement process being executed with a user defined variable spacing between each measurement point (integral) allowing low uncertainty measurements to be conducted. Scans defined for FCC applications utilize a 10mm² step integral, with 1mm interpolation used to locate the peak SAR area used for zoom scan assessments.

When an Area Scan has measured all reachable points, it computes the field maxima found in the scanned area, within a range of the global maximum. The range (in dB) is specified in the standards for compliance testing. For example, a 2 dB range is required in IEEE 1528-2003, EN 50361 and IEC 62209 standards, whereby 3 dB is a requirement when compliance is assessed in accordance with the ARIB standard (Japan).

2.1.3. Zoom Scan (Cube Scan Averaging)

Zoom Scans are used to assess the peak spatial SAR values within a cubic averaging volume containing 1 g and 10 g of simulated tissue. A density of 1000 kg/m³ is used to represent the head and body tissue density and not the phantom liquid density, in order to be consistent with the definition of the liquid dielectric properties, i.e. the side length of the 1 g cube is 10mm, with the side length of the 10 g cube 21,5mm.

The zoom scan integer steps can be user defined so as to reduce uncertainty, but normal practice for typical test applications utilize a physical step of 7x7x7 (5mmx5mmx5mm) providing a volume of 30mm in the X & Y axis, and 30mm in the Z axis.

2.1.4. Uncertainty of Inter-/Extrapolation and Averaging

In order to evaluate the uncertainty of the interpolation, extrapolation and averaged SAR calculation algorithms of the Post processor, COMOSAR allows the generation of measurement grids which are artificially predefined by analytically based test functions. Therefore, the grids of area scans and zoom scans can be filled with uncertainty test data, according to the SAR benchmark functions of IEEE 1528. The three analytical functions shown in equations as below are used to describe the possible range of the expected SAR distributions for the tested handsets. The field gradients are covered by the spatially flat distribution f1, the spatially steep distribution f3 and f2 accounts for H-field cancellation on the phantom/tissue surface.

$$f_1(x, y, z) = A e^{-\frac{z}{2a}} \cos^2 \left(\frac{\pi \sqrt{x'^2 + y'^2}}{2 \cdot 5a} \right)$$

$$f_2(x, y, z) = A e^{-\frac{z}{a}} \frac{a^2}{a^2 + x'^2} \left(3 - e^{-\frac{2z}{a}} \right) \cos^2 \left(\frac{\pi y'}{2 \cdot 3a} \right)$$

$$f_3(x, y, z) = A \frac{a^2}{\frac{a^2}{4} + x'^2 + y'^2} \left(e^{-\frac{2z}{a}} + \frac{a^2}{2(a + 2z)^2} \right)$$

2.2. COMOSAR E-Field Probe

The SAR measurement is conducted with the dissymmetric probe manufactured by SPEAG. The probe is specially designed and calibrated for use in liquid with high permittivity. The dissymmetric probe has special calibration in liquid at different frequency. SPEAG conducts the probe calibration in compliance with international and national standards (e.g. IEEE 1528, EN62209-1, IEC 62209, etc.) Under ISO17025. The calibration data are in Appendix D.

2.2.1. Isotropic E-Field Probe Specification

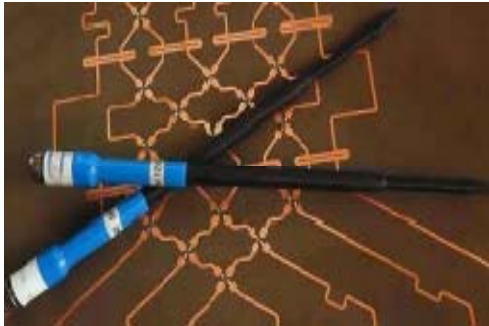
Model	SSE5	
Manufacture	Satimo	
frequency	0.3 GHz-3 GHz Linearity:±0.2dB(300 MHz-3 GHz)	
Dynamic Range	0.01W/Kg-100W/Kg Linearity:±0.2dB	
Dimensions	Overall length:330mm Length of individual dipoles:4.5mm Maximum external diameter:8mm Probe Tip external diameter:5mm Distance between dipoles/ probe extremity:2.7mm	
Application	High precision dosimetric measurements in any exposure scenario (e.g., very strong gradient fields). Only probe which enables compliance testing for frequencies up to 3 GHz with precision of better 30%.	

2.3 Robot

The COMOSAR system uses the high precision robots TX90 XL type out of the newer series from Satimo SA (France).For the 6-axis controller COMOSAR system, the KUKA robot controller version from Satimo is used. The XL robot series have many features that are important for our application:

- High precision (repeatability 0.02 mm)
- High reliability (industrial design)
- Jerk-free straight movements
- Low ELF interference (the closed metallic construction shields against motor control fields)
- 6-axis controller

#

#



2.4. Video Positioning System

The video positioning system is used in OpenSAR to check the probe. Which is composed of a camera, LED, mirror and mechanical parts. The camera is piloted by the main computer with firewire link.

During the process, the actual position of the probe tip with respect to the robot arm is measured, as well as the probe length and the horizontal probe offset. The software then corrects all movements, such that the robot coordinates are valid for the probe tip.

The repeatability of this process is better than 0.1 mm. If a position has been taught with an aligned probe, the same position will be reached with another aligned probe within 0.1 mm, even if the other probe has different dimensions. During probe rotations, the probe tip will keep its actual position.

#

#



#

#

#

2.5. Device Holder

The COMOSAR device holder is designed to cope with different positions given in the standard. It has two scales for the device rotation (with respect to the body axis) and the device inclination (with respect to the line between the ear reference points). The rotation center for both scales is the ear reference point (EPR).

Thus the device needs no repositioning when changing the angles.

The COMOSAR device holder has been made out of low-loss POM material having the following dielectric parameters: relative permittivity $\epsilon_r = 3$ and loss tangent $\delta = 0.02$. The amount of dielectric material has been reduced in the closest vicinity of the device, since measurements have suggested that the influence of the clamp on the test results could thus be lowered.

##

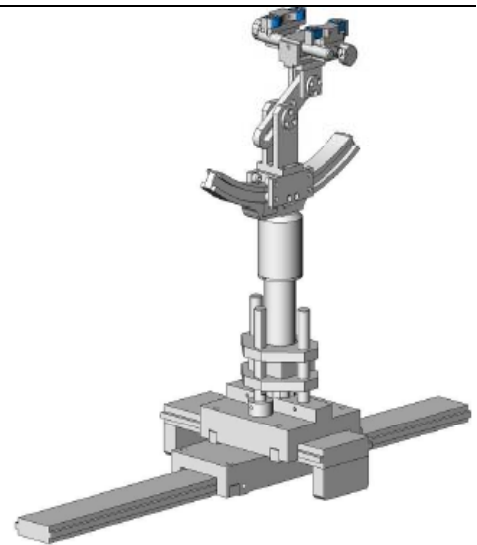

2.6. SAM Twin Phantom

The SAM twin phantom is a fiberglass shell phantom with 2mm shell thickness (except the ear region where shell thickness increases to 6mm). It has three measurement areas:

- Left head
- Right head
- Flat phantom

#



The bottom plate contains three pair of bolts for locking the device holder. The device holder positions are adjusted to the standard measurement positions in the three sections. A white cover is provided to tap the phantom during off-periods to prevent water evaporation and changes in the liquid parameters. On the phantom top, three reference markers are provided to identify the phantom position with respect to the robot.

3. Tissue Simulating Liquid

3.1. The composition of the tissue simulating liquid

Ingredient	835MHz	835MHz	1900MHz	1900MHz
(% Weight)	Head	Body	Head	Body
Water	40.45	52.4	54.90	40.5
Salt	1.45	1.40	0.18	0.50
Sugar	57.6	45.0	0.00	58.0
HEC	0.40	1.00	0.00	0.50
Preventol	0.10	0.20	0.00	0.50
DGBE	0.00	0.00	44.92	0.00

3.2. Tissue Calibration Result

The dielectric parameters of the liquids were verified prior to the SAR evaluation using COMOSAR Dielectric Probe Kit and R&S Network Analyzer ZVL6 .

Head Tissue Stimulant Measurement				
Frequency (MHz)	Description	Dielectric Parameters		Tissue Temp [°C]
835MHz	Reference result ±5% window	ϵ_r 41.50 39.43-43.58	δ [s/m] 0.90 0.86-0.95	N/A
	Apr.14,2012	42.99	0.90	21

Body Tissue Stimulant Measurement				
Frequency (MHz)	Description	Dielectric Parameters		Tissue Temp [°C]
835MHz	Reference result ±5% window	ϵ_r 55.20 52.44-57.96	δ [s/m] 0.97 0.92-1.02	N/A
	Apr.14,2012	53.46	0.94	21

Head Tissue Stimulant Measurement				
Frequency (MHz)	Description	Dielectric Parameters		Tissue Temp [°C]
1900MHz	Reference result ±5% window	ϵ_r 40.00 38.00-42.00	$\bar{\sigma}$ [s/m] 1.40 1.33-1.47	N/A
	Apr.14,2012	40.17	1.41	21

Body Tissue Stimulant Measurement				
Frequency (MHz)	Description	Dielectric Parameters		Tissue Temp [°C]
1900MHz	Reference result ±5% window	ϵ_r 53.30 50.64-55.97	$\bar{\sigma}$ [s/m] 1.52 1.44-1.60	N/A
	Apr.14,2012	53.27	1.49	21

3.3. Tissue Dielectric Parameters for Head and Body Phantoms

The head tissue dielectric parameters recommended by the IEEE SCC-34/SC-2 in P1528 have been incorporated in the following table. These head parameters are derived from planar layer models simulating the highest expected SAR for the dielectric properties and tissue thickness variations in a human head. Other head and body tissue parameters that have not been specified in P1528 are derived from the tissue dielectric parameters computed from the 4-Cole-Cole equations described in Reference [12] and extrapolated according to the head parameters specified in P1528.

Target Frequency (MHz)	head		body	
	ϵ_r	σ (S/m)	ϵ_r	σ (S/m)
300	45.3	0.87	58.2	0.92
450	43.5	0.87	56.7	0.94
835	41.5	0.90	55.2	0.97
900	41.5	0.97	55.0	1.05
915	41.5	0.98	55.0	1.06
1450	40.5	1.20	54.0	1.30
1610	40.3	1.29	53.8	1.40
1800 – 2000	40.0	1.40	53.3	1.52
2450	39.2	1.80	52.7	1.95
3000	38.5	2.40	52.0	2.73
5800	35.3	5.27	48.2	6.00

(ϵ_r = relative permittivity, σ = conductivity and $\rho = 1000 \text{ kg/m}^3$)

4. SAR Measurement Procedure

4.1. SAR System Validation

4.1.1. Validation Dipoles

#

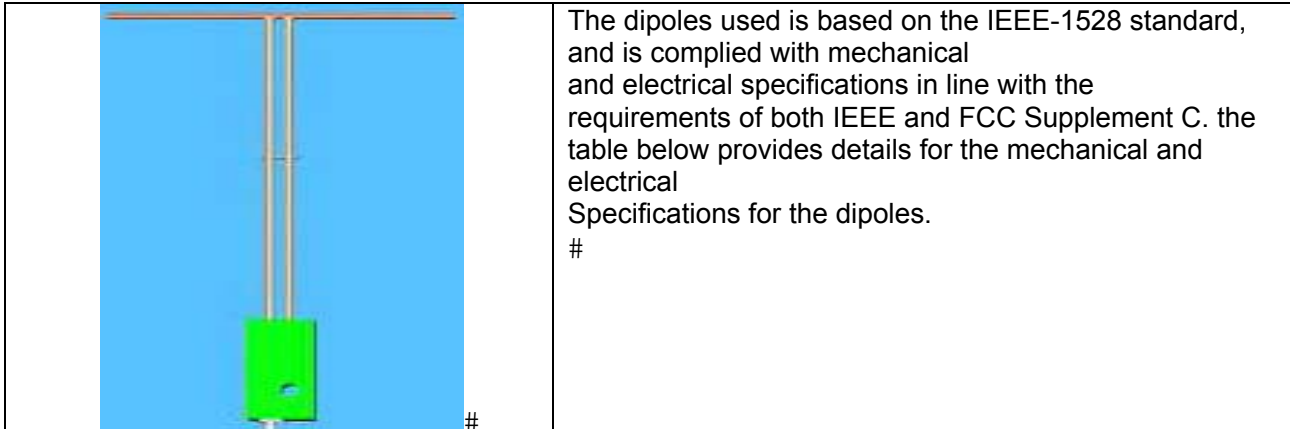

The dipoles used is based on the IEEE-1528 standard, and is complied with mechanical and electrical specifications in line with the requirements of both IEEE and FCC Supplement C. the table below provides details for the mechanical and electrical Specifications for the dipoles.

#

#

#

Frequency	L (mm)	h (mm)	d (mm)
900 MHz	149.0	83.3	3.6
1900MHz	68	39.5	3.6

4.1.2. Validation Result

System Performance Check at 835 MHz &1900MHz for Head				
Validation Kit: SN 46/11DIP 0G900-185				
Frequency [MHz]	Description	SAR [w/kg] 1g	SAR [w/kg] 10g	Tissue Temp.[°C]
900 MHz	Reference result ± 10% window	10.9 9.81 to 11.99	6.99 6.29 to 7.69	N/A
	Apr.14,2012	9.86	6.84	21.0
Validation Kit: SN 46/11DIP 1G900-187				
Frequency [MHz]	Description	SAR [w/kg] 1g	SAR [w/kg] 10g	Tissue Temp.[°C]
1900 MHz	Reference result ± 10% window	39.7 35.73 to 43.67	20.5 18.45 to 22.55	N/A
	Apr.14,2012	39	19.9	21.0
Note: All SAR values are normalized to 1W forward power.				

4.2. SAR Measurement Procedure

The COMOSAR calculates SAR using the following equation,

$$SAR = \frac{\sigma |E|^2}{\rho}$$

σ : represents the simulated tissue conductivity

ρ : represents the tissue density

The EUT is set to transmit at the required power in line with product specification, at each frequency relating to the LOW, MID, and HIGH channel settings.

Pre-scans are made on the device to establish the location for the transmitting antenna, using a large area scan in either air or tissue simulation fluid.

The EUT is placed against the Universal Phantom where the maximum area scan dimensions are larger than the physical size of the resonating antenna. When the scan size is not large enough to cover the peak SAR distribution, it is modified by either extending the area scan size in both the X and Y directions, or the device is shifted within the predefined area.

The area scan is then run to establish the peak SAR location (interpolated resolution set at 1mm²) which is then used to orient the center of the zoom scan. The zoom scan is then executed and the 1g and 10g averages are derived from the zoom scan volume (interpolated resolution set at 1mm³).

When multiple peak SAR locations were found during the same configuration or test mode, Zoom scan shall performed on each peak SAR location, only the peak point with maximum SAR value will be reported for the configuration or test mode.

5. SAR Exposure Limits

SAR assessments have been made in line with the requirements of IEEE-1528, FCC Supplement C, and comply with ANSI/IEEE C95.1-1992 “Uncontrolled Environments” limits. These limits apply to a location which is deemed as “Uncontrolled Environment” which can be described as a situation where the general public may be exposed to an RF source with no prior knowledge or control over their exposure.

Limits for General Population/Uncontrolled Exposure (W/kg)

Type Exposure	Uncontrolled Environment Limit
Spatial Peak SAR (1g cube tissue for brain or body)	1.60 W/kg
Spatial Average SAR (whole body)	0.08 W/kg
Spatial Peak SAR (10g for hands, feet, ankles and wrist)	4.00 W/kg

#

6. Test Equipment List

Equipment description	Manufacturer/Model	Identification No.	Current calibration date	Next calibration date
SAR Probe	Satimo	SN_3511_EP132	12/09/2011	12/08/2012
Phantom	Satimo	SN_4511_SAM90	Validated. No cal required.	Validated. No cal required.
Liquid	Satimo	-	Validated. No cal required.	Validated. No cal required.
Comm Tester	R&S - CMU200	069Y7-158-13-712	12/09/2011	12/08/2012
Multimeter	Keithley 2000	1188656	12/09/2011	12/08/2012
Dipole	Satimo SID900	SN46/11 DIP 0G900-185	12/09/2011	12/08/2014
Dipole	Satimo SID1900	SN46/11 DIP 1G900-187	12/09/2011	12/08/2014
Amplifier	Aethercomm	SN 046	12/09/2011	12/08/2012
Power Meter	HP E4418A	US38261498	03/30/2012	03/29/2013
Network Analyzer	Rhode & Schwarz ZVA	SN100132	02/07/2012	02/06/2013

Note: Per KDB 50824 Dipole SAR Validation Verification, AGC Lab has adopted 3 years calibration intervals. On annual basis, every measurement dipole has been evaluated and is in compliance with the following criteria:

1. There is no physical damage on the dipole;
2. System validation with specific dipole is within 10% of calibrated value;
3. Return-loss is within 20% of calibrated measurement;
4. Impedance is within 5Ω of calibrated measurement.

7. Measurement Uncertainty

Satimo Uncertainty									
Measurement uncertainty for 300 MHz to 3 GHz averaged over 1 gram / 10 gram.									
Error Description	Sec	Tol (±%)	Prob. Dist.	Div.	(Ci) 1g	(Ci) 10g	Std. Unc. (1g) (±%)	Std. Unc. (10g)(±%)	(Vi) Veff
Measurement System									
Probe Calibration	E.2.1	6	N	1	1	1	6	6	∞
Axial Isotropy	E.2.2	3	R	$\sqrt{3}$	$(1-c_D)^{1/2}$	$(1-c_D)^{1/2}$	1.22474	1.22474	∞
Hemispherical Isotropy	E.2.2	5	R	$\sqrt{3}$	$\sqrt{C_p}$	$\sqrt{C_p}$	2.04124	2.04124	∞
Boundary Effects	E.2.3	1	R	$\sqrt{3}$	1	1	0.57735	0.57735	∞
Linearity	E.2.4	5	R	$\sqrt{3}$	1	1	2.88675	2.88675	∞
System Detection Limits	E.2.5	1	R	$\sqrt{3}$	1	1	0.57735	0.57735	∞
Readout Electronics	E.2.6	0.5	N	1	1	1	0.5	0.5	∞
Response Time	E.2.7	0.2	R	$\sqrt{3}$	1	1	0.11547	0.11547	∞
Integration Time	E.2.8	2	R	$\sqrt{3}$	1	1	1.1547	1.1547	∞
RF Ambient Noise	E.6.1	3	R	$\sqrt{3}$	1	1	1.73205	1.73205	∞
Probe Positioner Mechanical Tolerance	E.6.2	2	R	$\sqrt{3}$	1	1	1.1547	1.1547	∞
Probe Positioning with Respect to Phantom Shell	E.6.3	1	R	$\sqrt{3}$	1	1	0.57735	0.57735	∞
Extrapolation, interpolation and Integration Algorithms for Max. SAR Evaluation	E.5.2	1.5	R	$\sqrt{3}$	1	1	0.86603	0.86603	∞
Dipole									
Device Positioning	8,E.4.2	1	N	$\sqrt{3}$	1	1	0.57735	0.57735	N-1
Power Drift	8.6.6.2	2	R	$\sqrt{3}$	1	1	1.1547	1.1547	∞
Phantom and Tissue Parameters									
Phantom Uncertainty	E.3.1	4	R	$\sqrt{3}$	1	1	2.3094	2.3094	∞
Liquid Conductivity (target)	E.3.2	5	R	$\sqrt{3}$	0.64	0.43	1.84752	1.2413	∞
Liquid Conductivity (meas.)	E.3.3	2.5	N	1	0.64	0.43	1.6	1.075	∞
Liquid Permittivity (target)	E.3.2	3	R	$\sqrt{3}$	0.6	0.49	1.03923	0.8487	∞
Liquid Permittivity (meas.)	E.3.3	2.5	N	1	0.6	0.49	1.5	1.225	M
Combined Standard Uncertainty			RSS				8.09272	7.9296	
Expanded Uncertainty (95%CONFIDENCE INTERVAL)			k				16.18544	15.8594	

8. Conducted Power Measurement

Mode	Frequency(MHz)	Peak Power	Avg. Burst Power	Duty cycle Factor(dB)	Frame Power(dBm)
Maximum Power					
GSM 850	824.2	32.75	31.67	-9	22.67
	836.6	32.80	31.79	-9	22.79
	848.8	32.87	31.84	-9	22.84
GPRS850 (1 Slot)	824.2	32.73	31.64	-9	22.64
	836.6	32.81	31.71	-9	22.71
	848.8	32.83	31.75	-9	22.75
GPRS850 (2 Slot)	824.2	29.64	28.56	-6	22.56
	836.6	29.7	28.61	-6	22.61
	848.8	29.74	28.64	-6	22.64
GPRS850 (3 Slot)	824.2	27.85	26.57	-4.26	22.32
	836.6	27.96	26.61	-4.26	22.36
	848.8	28.07	26.66	-4.26	22.41
GPRS850 (4 Slot)	824.2	26.57	25.57	-3	22.57
	836.6	26.63	25.62	-3	22.62
	848.8	26.67	25.68	-3	22.68
PCS1900	1850.2	29.74	29.69	-9	20.69
	1880	29.78	29.71	-9	20.71
	1909.8	29.83	29.74	-9	20.74
GPRS1900 (1 Slot)	1850.2	29.68	29.64	-9	20.64
	1880	29.71	29.66	-9	20.66
	1909.8	29.74	29.69	-9	20.69
GPRS1900 (2 Slot)	1850.2	26.67	25.58	-6	19.58
	1880	26.72	25.64	-6	19.64
	1909.8	26.76	25.69	-6	19.69
GPRS1900 (3 Slot)	1850.2	25.04	24.32	-4.26	20.07
	1880	25.09	24.37	-4.26	20.12
	1909.8	25.13	24.4	-4.26	20.15
GPRS1900 (4 Slot)	1850.2	23.71	22.81	-3	19.81
	1880	23.76	22.86	-3	19.86
	1909.8	23.8	22.91	-3	19.91
GSM 850 <SIM 2>	824.2	--	--	--	--
	836.6	32.80	31.83	-9	22.83
	848.8	--	--	--	--
PCS1900 <SIM 2>	1850.2	--	--	--	--
	1880	29.81	29.71	-9	20.71
	1909.8	--	--	--	--

Note 1:

The Frame Power (Source-based time-averaged Power) is scaled the maximum burst average power based on time slots. The calculated methods are show as following:

Frame Power = Max burst power (1 Up Slot) – 9 dB

Frame Power = Max burst power (2 Up Slot) – 6 dB

Frame Power = Max burst power (3 Up Slot) – 4.26 dB

Frame Power = Max burst power (4 Up Slot) – 3 d

9. Test Results

9.1. SAR Test Results Summary

9.1.1. Test position and configuration

Head SAR was performed with the device configured in the positions according to IEEE1528, and Body SAR was performed with the device 15mm from the phantom. Body SAR was also performed with the headset attached and without.

9.1.2. Body SAR with Headset

Testing with the headset was performed at the position and channels that resulted in the highest body SAR. This testing was performed with GPRS transmitting with 2/3/4 uplink timeslots. This operation mode represents the maximum SAR situation, when downloading data via GPRS and listening to music by headset. SAR without the headset attached was significantly higher than with the headset, and also was verified several times and confirmed, so the final test data shown were the worst case without headset. In the Body SAR test result table, body-worn means display of device down, body-front means display of device up.

9.1.3. Operation Mode

This is a multi-slot class 12 device capable of 4 uplink timeslots. During the head SAR test, the device was transmitting with maximum 1 uplink timeslot; during the body SAR test, it was transmitting with maximum 4 uplink timeslots. Additionally, this device doesn't support dual transfer mode (DTM), and SIM <1> can't transmit with SIM <2> simultaneously.

9.1.4. Co-located SAR

According to KDB 447498 and KDB 648474, due to the Max peak power for Bluetooth is less than Pref and the Maximum SAR for GSM part 1.2W/Kg, thus, regardless the closest separation distance between the GSM antenna and Bluetooth Antenna, stand-alone SAR and simultaneous transmission SAR is not required.

Other reference document: KDB 941225.

9.1.5. Test Result

SAR MEASUREMENT									
Ambient Temperature (°C) : 21 ± 2						Relative Humidity (%): 55			
Liquid Temperature (°C) : 21 ± 2						Depth of Liquid (cm):>15			
Product: TINGLE									
Test Mode: GSM850 with GMSK modulation									
Configuration			Antenna Position	Frequency		Frame Power (dBm)	Power Drift (<±0.2 dB)	SAR (1g) (W/kg)	Limit (W/kg)
SIM	Position	Status		channel	MHz				
<1>	Left Head	Cheek	Fixed	128	824.2	22.67	--	--	1.6
				190	836.6	22.79	-0.04	0.161	1.6
				251	848.8	22.84	--		1.6
		Tilted		128	824.2	22.67	--		1.6
				190	836.6	22.79	-0.01	0.214	1.6
				251	848.8	22.84	--		1.6
	Right Head	Cheek	Fixed	128	824.2	22.67	--		1.6
				190	836.6	22.79	-0.02	0.251	1.6
				251	848.8	22.84	--		1.6
		Tilted		128	824.2	22.67	--		1.6
				190	836.6	22.79	-0.02	0.179	1.6
				251	848.8	22.84	--		1.6
<2>	Right	Cheek	Fixed	190	836.6	22.83	-0.02	0.179	1.6

Note: when the 1-g SAR is ≤ 0.8 W/kg, testing for low and high channel is optional. refer to KDB 941225.

#

#

#

SAR MEASUREMENT									
Ambient Temperature (°C) : 21 ± 2						Relative Humidity (%): 55			
Liquid Temperature (°C) : 21 ± 2						Depth of Liquid (cm):>15			
Product: TINGLE									
Test Mode: GSM850 with GMSK modulation									
Configuration			Antenna Position	Frequency		Frame Power (dBm)	Power Drift (<±0.2 dB)	SAR (1g) (W/kg)	Limit (W/kg)
SIM	Position	Status		channel	MHz				
<1>	Body Front	MS	Fixed	128	824.2	22.67	--	--	1.6
				190	836.6	22.79	0.02	0.301	1.6
				251	848.8	22.84	--		1.6
		GPRS 2 TS	Fixed	128	824.2	22.56	--		1.6
				190	836.6	22.61	-0.01	0.430	1.6
				251	848.8	22.64	--		1.6
		GPRS 3 TS	Fixed	128	824.2	22.32	--		1.6
				190	836.6	22.36	-0.03	0.161	1.6
				251	848.8	22.41	--		1.6
		GPRS 4 TS	Fixed	128	824.2	22.57	--		1.6
				190	836.6	22.62	-0.04	0.145	1.6
				251	848.8	22.68	--		1.6
	Body Back	GPRS 2 TS	Fixed	128	824.2	22.56	--		1.6
				190	836.6	22.61	-0.06	0.104	1.6
				251	848.8	22.64	--		1.6
		GPRS 2 TS with Earphone	Fixed	128	824.2	22.56	--		1.6
				190	836.6	22.61	-0.05	0.121	1.6
				251	848.8	22.64	--	--	1.6
<2>	--	--	--	--	--	--	--	--	

Note: when the 1-g SAR is ≤ 0.8 W/kg, testing for low and high channel is optional. refer to KDB 941225.

#

#

SAR MEASUREMENT									
Ambient Temperature (°C) : 21 ± 2						Relative Humidity (%): 55			
Liquid Temperature (°C) : 21 ± 2						Depth of Liquid (cm):>15			
Product: TINGLE									
Test Mode: PCS1900 with GMSK modulation									
Configuration			Antenna Position	Frequency		Frame Power (dBm)	Power Drift (<±0.2 dB)	SAR (1g) (W/kg)	Limit (W/kg)
SIM	Position	Status		channel	MHz				
<1>	Left Head	Cheek	Fixed	512	1850.2	20.69	--	--	1.6
				661	1880.0	20.71	0.03	0.295	1.6
				810	1909.8	20.74	--		1.6
		Tilted	Fixed	512	1850.2	20.69	--		1.6
				661	1880.0	20.71	-0.02	0.310	1.6
				810	1909.8	20.74	--		1.6
	Right Head	Cheek	Fixed	512	1850.2	20.69	--		1.6
				661	1880.0	20.71	0.04	0.293	1.6
				810	1909.8	20.74	--		1.6
		Tilted	Fixed	512	1850.2	20.69	--		1.6
				661	1880.0	20.71	-0.01	0.360	1.6
				810	1909.8	20.74	--		1.6
<2>	Right	Title	Fixed	661	1880.0	20.71	-0.05	0.279	1.6

Note: when the 1-g SAR is ≤ 0.8 W/kg, testing for low and high channel is optional. refer to KDB 941225.

#

#

SAR MEASUREMENT									
Ambient Temperature (°C) : 21 ± 2						Relative Humidity (%): 55			
Liquid Temperature (°C) : 21 ± 2						Depth of Liquid (cm):>15			
Product: TINGLE									
Test Mode: PCS1900 with GMSK modulation									
Configuration			Antenna Position	Frequency		Frame Power (dBm)	Power Drift (<±0.2 dB)	SAR (1g) (W/kg)	Limit (W/kg)
SIM	Position	Status		channel	MHz				
<1>	Body Front	MS	Fixed	512	1850.2	20.69	--	--	1.6
				661	1880.0	20.71	0.03	0.278	1.6
				810	1909.8	20.74	--		1.6
		GPRS 2 TS	Fixed	512	1850.2	25.58	--		1.6
				661	1880.0	25.64	-0.01	0.173	1.6
				810	1909.8	25.69	--		1.6
		GPRS 3 TS	Fixed	512	1850.2	24.32	--		1.6
				661	1880.0	24.37	0.03	0.163	1.6
				810	1909.8	24.4	--		1.6
		GPRS 4 TS	Fixed	512	1850.2	22.81	--		1.6
				661	1880.0	22.86	0.02	0.164	1.6
				810	1909.8	22.91	--		1.6
	Body Back	MS	Fixed	512	1850.2	20.69	--		1.6
				661	1880.0	20.71	0.07	0.177	1.6
				810	1909.8	20.74	--		1.6
		MS with Earphone	Fixed	512	1850.2	20.69	--		1.6
				661	1880.0	20.71	0.05	0.186	1.6
				810	1909.8	20.74	--		1.6
<2>	--	--	--	--	--	--	--	--	

Note: when the 1-g SAR is ≤ 0.8 W/kg, testing for low and high channel is optional. refer to KDB 941225.

#

Appendix A. SAR System Validation Data#

Test Laboratory: AGC Lab

Date:APR.14,2012

System Check Head 900 MHz

DUT: Dipole 900 MHz Type: SID 900

Communication System: CW; Communication System Band: D850(850.0 MHz); Duty Cycle: 1:1; ConvF=6.79

Frequency: 850 MHz; Medium parameters used: $f = 850$ MHz; $\sigma = 0.90$ mho/m; $\epsilon_r = 42.99$; $\rho = 1000$ kg/m³ ;

Phantom section: Flat Section ; Input Power=17dBm

Ambient temperature (°C): 21, Liquid temperature (°C): 21

Satimo Configuration:

Probe:SSE5; Calibrated: 12/09/2011

- Sensor-Surface: 4mm (Mechanical Surface Detection)
- Phantom: SAM1; Type: SAM
- Measurement SW: OpenSAR V4_02_01

Configuration/System Check GSM850 Head/Area Scan: Measurement grid: dx=8mm,
dy=8mm

Configuration/System Check GSM850 Head/Zoom Scan : Measurement grid: dx=8mm,
dy=8mm, dz=5mm

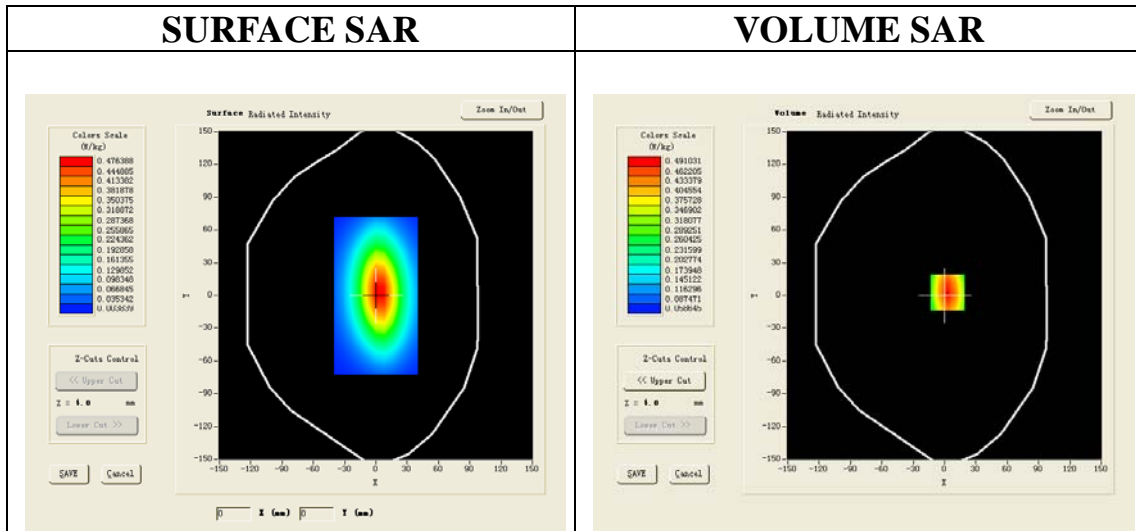

Maximum location: X=3.00, Y=3.00

SAR 10g (W/Kg)	0.341813
SAR 1g (W/Kg)	0.465279

Z (mm)	0.00	4.00	9.00	14.00	19.00
SAR (W/Kg)	0.0000	0.4930	0.3320	0.2287	0.1625

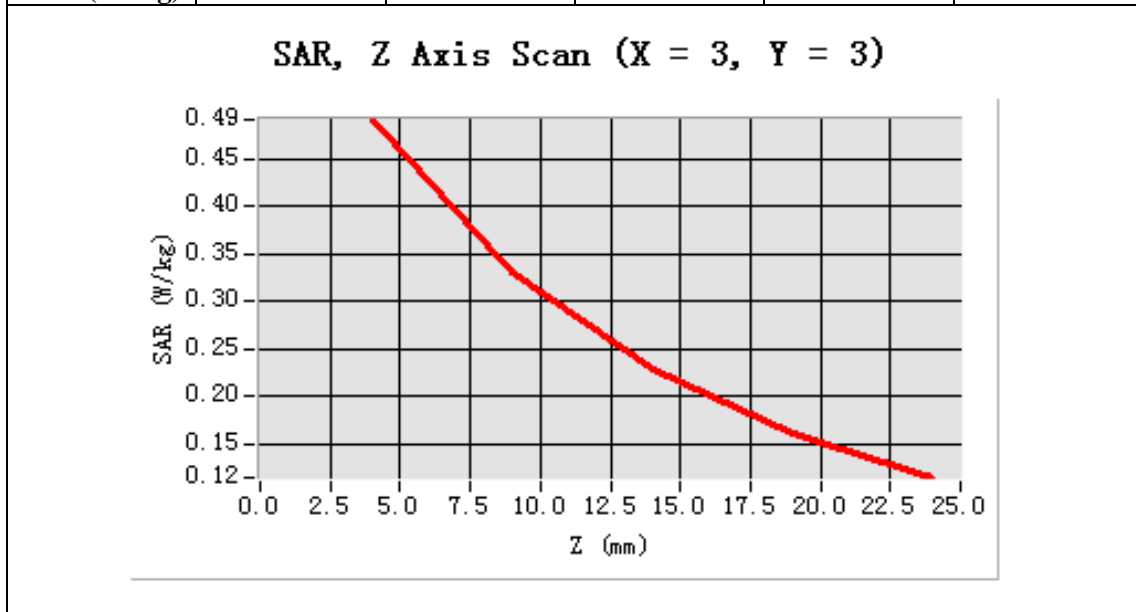

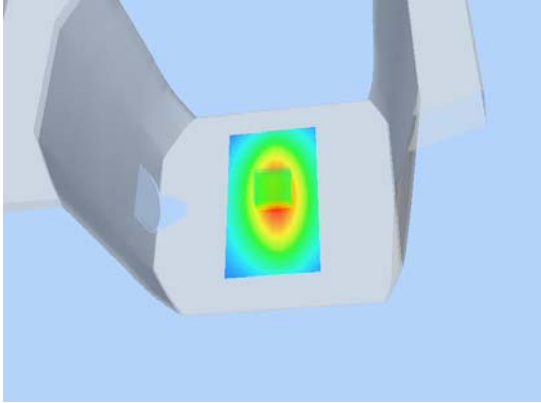
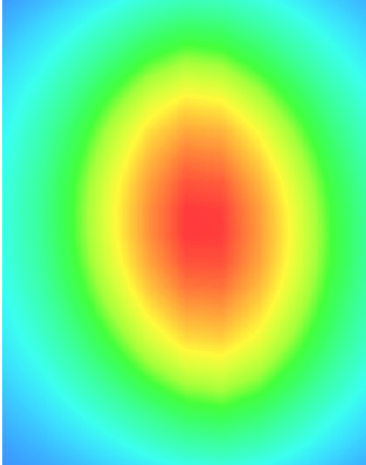
3D screen shot	Hot spot position
 A 3D perspective view of a grey, rectangular device. A small, rectangular area on the front face of the device is highlighted with a color gradient, indicating a hot spot. The gradient transitions from red in the center to yellow, green, and finally blue at the edges.	 A close-up, 2D view of the hot spot area. It shows a circular region with a color gradient from red in the center, through yellow and green, to blue at the outer edge, representing the intensity of the hot spot.

Test Laboratory: AGC Lab

Date: APR.14,2012

System Check Head 1900MHz#

DUT: Dipole 1900 MHz ; Type: SID 1900

Communication System: CW; Communication System Band: D1900 (1900.0 MHz); Duty Cycle:1:1;ConvF=6.42

Frequency: 1900 MHz; Medium parameters used: $f = 1900$ MHz; $\sigma = 1.41$ mho/m; $\epsilon_r = 40.17$; $\rho = 1000$ kg/m³ ;

Phantom section: Flat Section ; Input Power=17dBm

Ambient temperature (°C): 21, Liquid temperature (°C): 21

Satimo Configuration:

Probe:SSE5; Calibrated: 12/09/2011

- Sensor-Surface: 4mm (Mechanical Surface Detection)
- Phantom: SAM1; Type: SAM
- Measurement SW: OpenSAR V4_02_01

Configuration/System Check PCS1900 Head/Area Scan: Measurement grid: dx=8mm,
dy=8mm

Configuration/System Check PCS1900 Head/Zoom Scan: Measurement grid: dx=8mm,
dy=8mm, dz=5mm

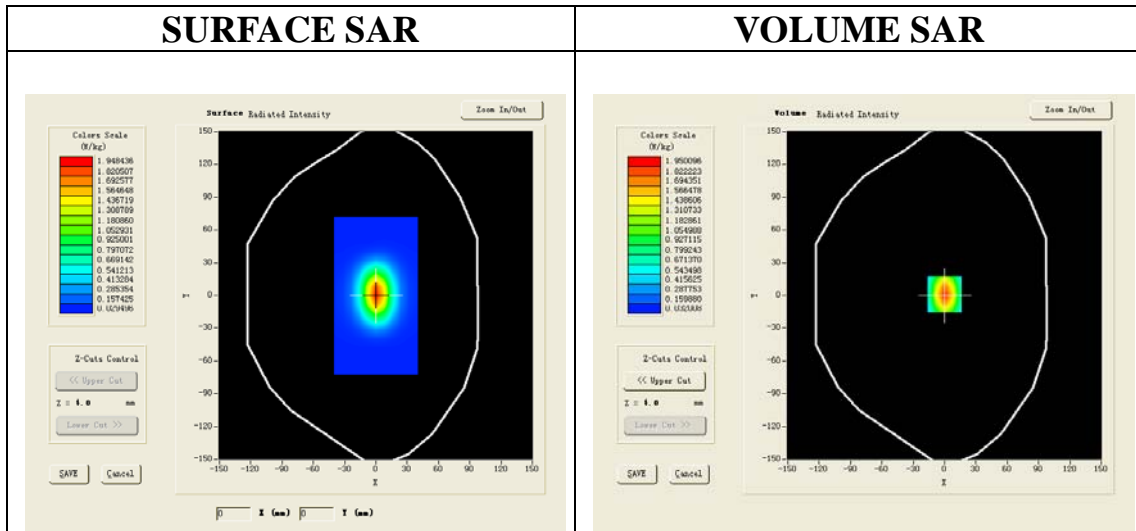

Maximum location: X=0.00, Y=1.00

SAR 10g (W/Kg)	0.994637
SAR 1g (W/Kg)	1.803422

Z (mm)	0.00	4.00	9.00	14.00	19.00
SAR (W/Kg)	0.0000	1.9501	1.0025	0.5225	0.2965

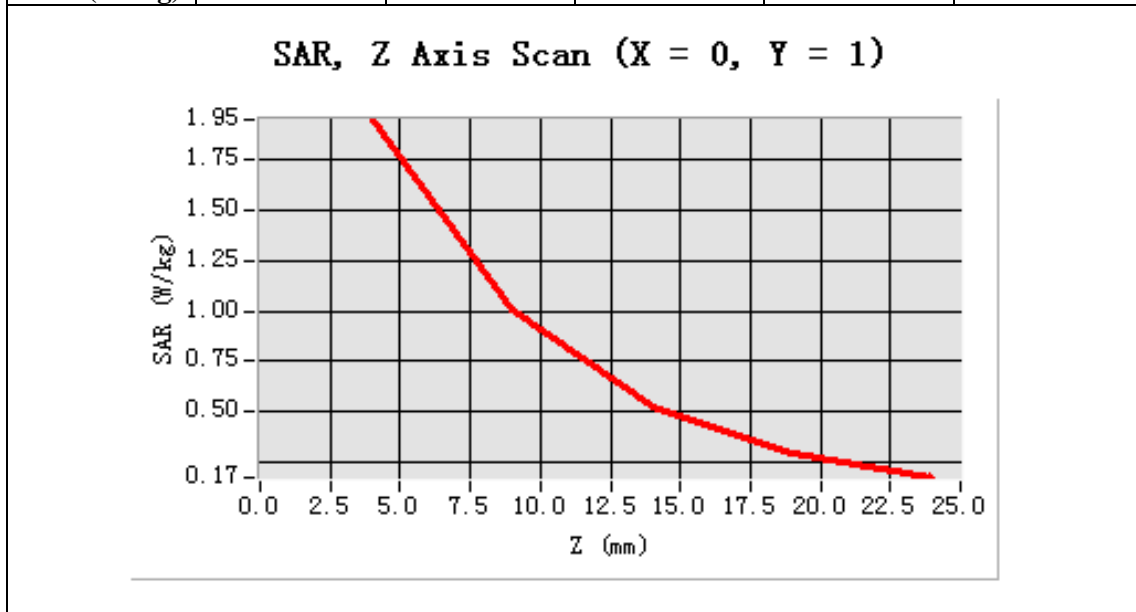

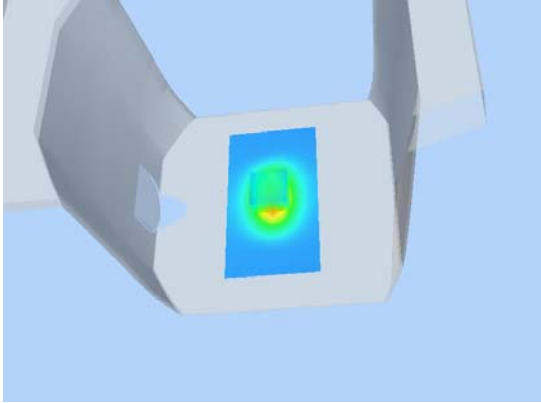
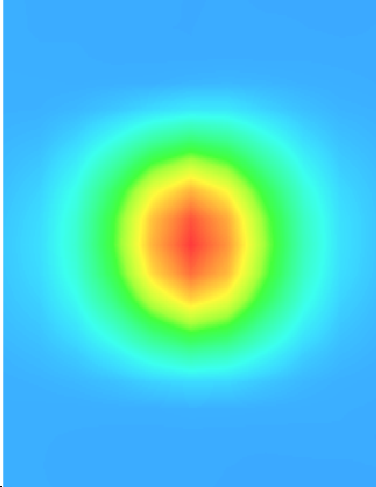
3D screen shot	Hot spot position
 A 3D perspective view of a grey, rectangular device. A small, circular area on the front face of the device is highlighted with a color gradient from blue to red, indicating a hot spot. The device is set against a light blue background.	 A 2D heatmap showing the hot spot position. The heatmap is circular and centered, with a color gradient from blue (low intensity) to red (high intensity). The red core is surrounded by yellow, green, and cyan rings, all set against a blue background.

Appendix B. SAR measurement Data

Test Laboratory: AGC Lab
GSM 850 Middle-touch-Left <SIM 1>#
DUT:TINGLE; Type: S107

Date:APR.14,2012

Communication System: Generic GSM; Communication System Band: GSM 850; DutyCycle:1: 8; Conv.F=6.79
Frequency: 836.6 MHz; Medium parameters used: $f = 835$ MHz; $\sigma = 0.90$ mho/m; $\epsilon_r = 42.99$;
 $\rho = 1000$ kg/m³ ; Phantom section: Left Section
Ambient temperature (°C): 21, Liquid temperature (°C): 21

Satimo Configuration:

- Probe:SSE5; Calibrated: 12/09/2011
- Sensor-Surface: 4mm (Mechanical Surface Detection)
- Phantom: SAM1; Type: SAM
- Measurement SW: OpenSAR V4_02_01

Configuration/GSM850 Mid Touch-Left/Area Scan (6x8x1): Measurement grid: dx=20mm, dy=20mm

Configuration/GSM850 Mid Touch-Left/Zoom Scan (5x5x7)/Cube 0: Measurement grid: dx=8mm, dy=8mm, dz=5mm

Area Scan	sam_direct_droit2_surf8mm.txt
ZoomScan	5x5x7,dx=8mm dy=8mm dz=5mm,Very fast
Phantom	Left head
Device Position	Cheek
Band	GSM850
Channels	Middle
Signal	TDMA (Crest factor: 8.0)

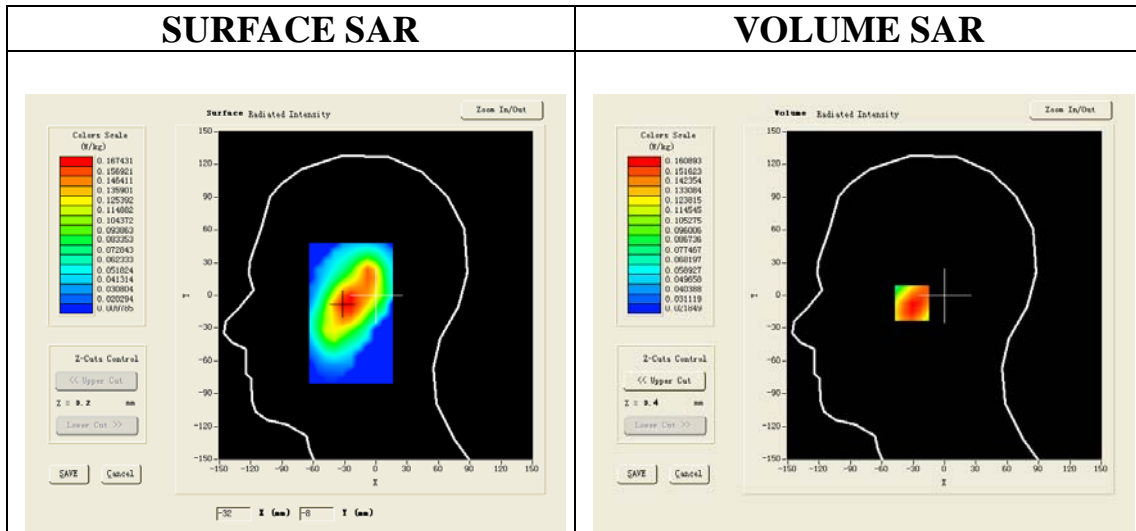

Maximum location: X=-29.00, Y=-7.00

SAR 10g (W/Kg)	0.111394
SAR 1g (W/Kg)	0.155696

Z (mm)	0.00	4.00	9.00	14.00	19.00
SAR (W/Kg)	0.0000	0.1609	0.1216	0.0922	0.0702

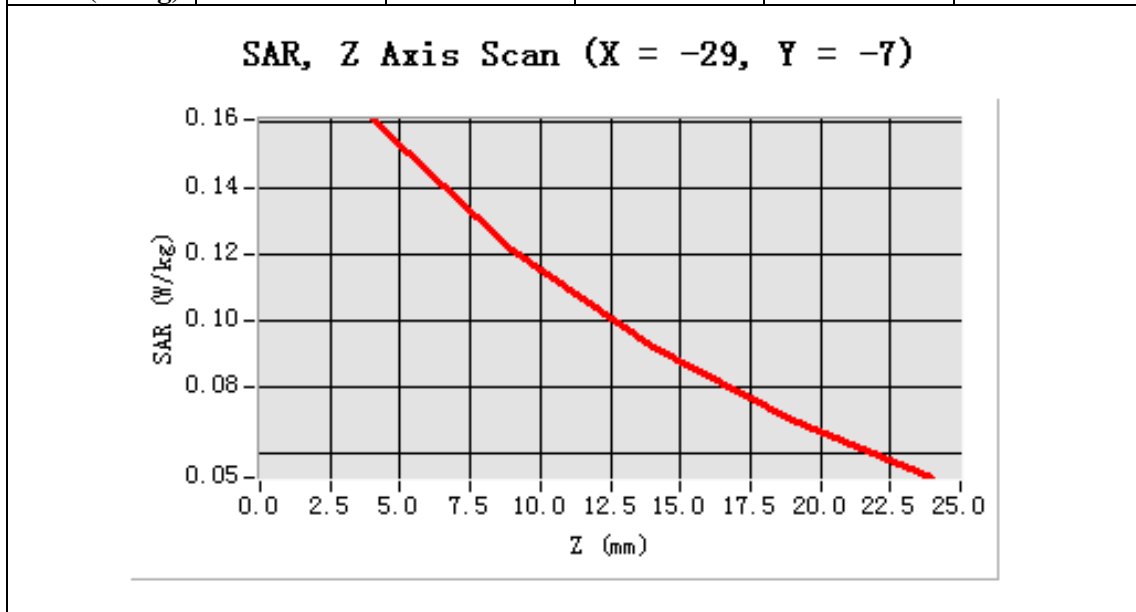

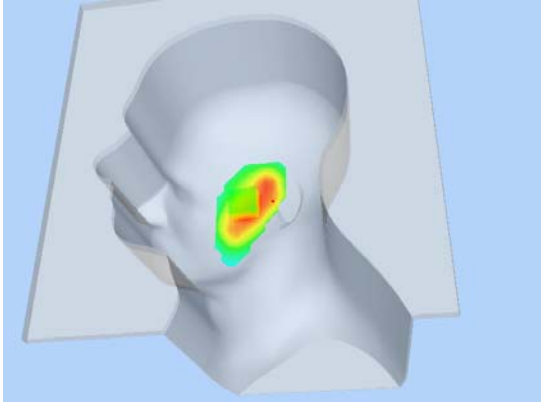
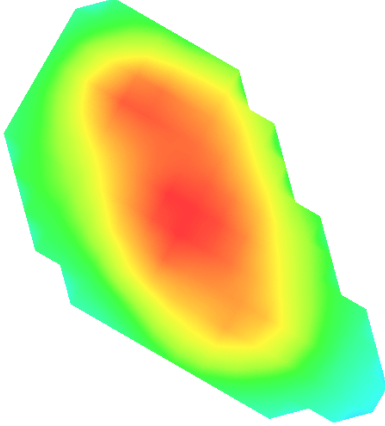
3D screen shot	Hot spot position
 A 3D rendering of a human head model in profile, facing left. The head is light blue. A hot spot is visible on the side of the head, near the ear, colored in a gradient from green to red. The hot spot is located on the side of the head, near the ear.	 A 2D diagram showing the hot spot position. It is a color-coded area with a central red region, transitioning through yellow and green to cyan at the edges. The shape is roughly oval and irregular, representing the hot spot's location and intensity.

Test Laboratory: AGC Lab
GSM 850 Mid Tilt-left <SIM 1>#
DUT:TINGLE; Type: S107

Date:APR.14,2012

Communication System: Generic GSM; Communication System Band: GSM 850; DutyCycle:1: 8; Conv.F=6.79
Frequency: 836.6 MHz; Medium parameters used: $f = 835$ MHz; $\sigma = 0.90$ mho/m; $\epsilon_r = 42.99$;
 $\rho = 1000$ kg/m³ ; Phantom section: Left Section
Ambient temperature (°C): 21, Liquid temperature (°C): 21

Satimo Configuration:

- Probe:SSE5; Calibrated: 12/09/2011
- Sensor-Surface: 4mm (Mechanical Surface Detection)
- Phantom: SAM1; Type: SAM
- Measurement SW: OpenSAR V4_02_01

Configuration/GSM850 Mid Tilt-Left/Area Scan (6x8x1): Measurement grid: dx=20mm, dy=20mm

Configuration/GSM850 Mid Tilt-Left/Zoom Scan (5x5x7)/Cube 0: Measurement grid: dx=8mm, dy=8mm, dz=5mm;

Area Scan	sam_direct_droit2_surf8mm.txt
ZoomScan	5x5x7,dx=8mm dy=8mm dz=5mm,Very fast
Phantom	Left head
Device Position	Tilt
Band	GSM850
Channels	Middle
Signal	TDMA (Crest factor: 8.0)

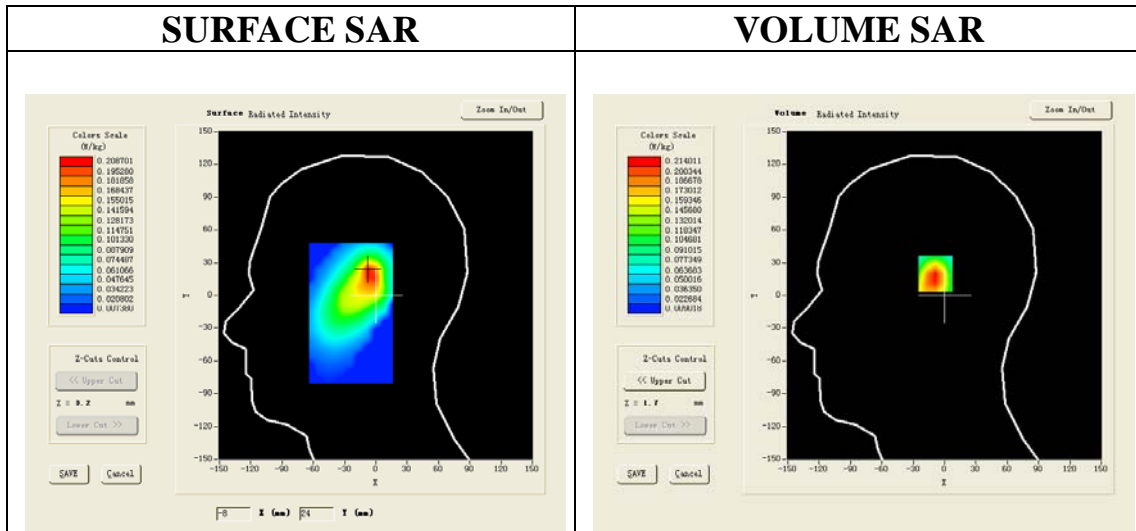

Maximum location: X=-6.00, Y=21.00

SAR 10g (W/Kg)	0.115289
SAR 1g (W/Kg)	0.204789

Z (mm)	0.00	4.00	9.00	14.00	19.00
SAR (W/Kg)	0.0000	0.2140	0.1219	0.0726	0.0477

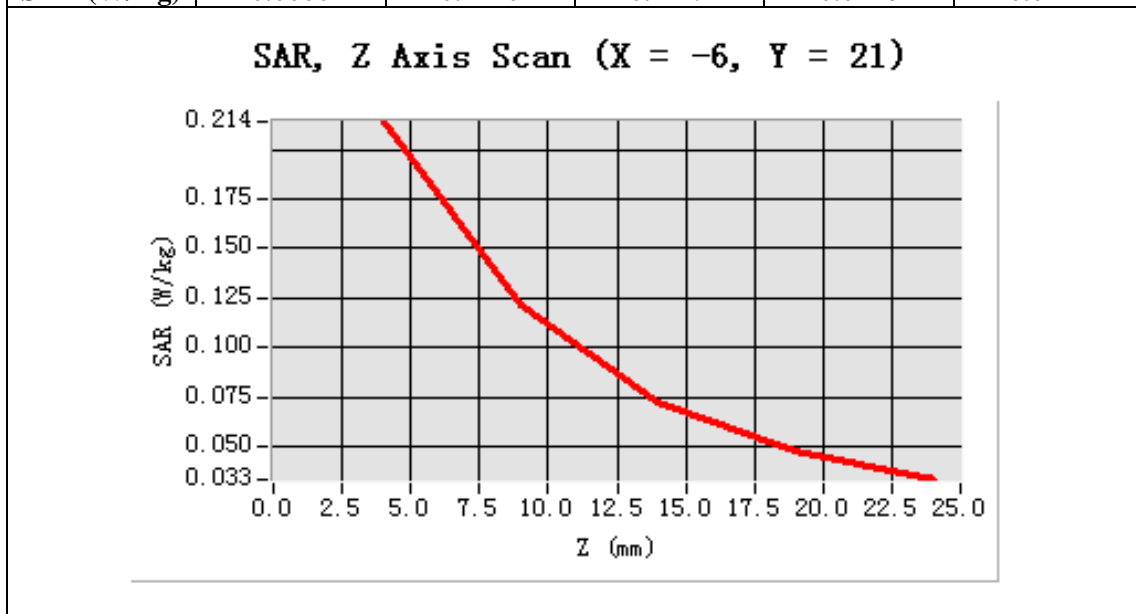

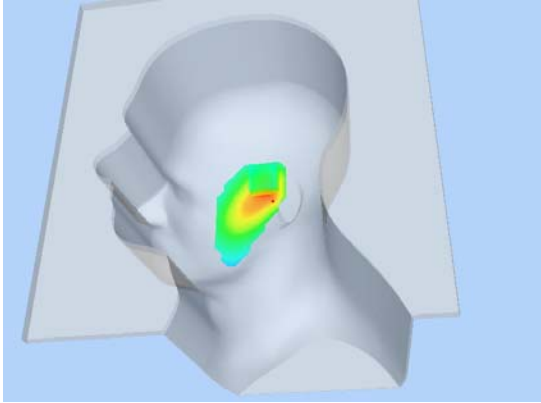
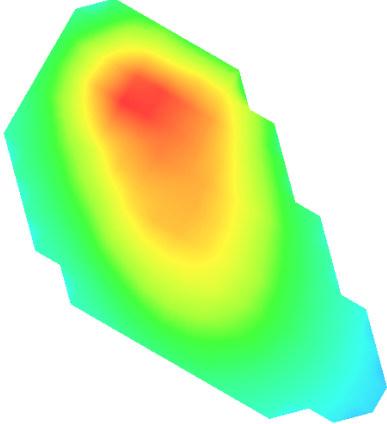
3D screen shot	Hot spot position
 A 3D rendered image of a human head model in profile, facing left. A localized area on the ear is highlighted with a color gradient from blue to red, indicating a hot spot. The rest of the head is rendered in a light grey color.	 A close-up view of the hot spot area. It shows a color gradient from red (highest intensity) in the center, transitioning through yellow and green to blue (lowest intensity) at the edges. The shape is roughly oval and irregular.

Test Laboratory: AGC Lab
GSM 850 Middle touch-Right <SIM 1>#
DUT:TINGLE; Type: S107

Date:APR.14,2012

Communication System: Generic GSM; Communication System Band: GSM 850; DutyCycle:1: 8; Conv.F=6.79
Frequency: 836.6 MHz; Medium parameters used: $f = 835$ MHz; $\sigma = 0.90$ mho/m; $\epsilon_r = 42.99$;
 $\rho = 1000$ kg/m³ ; Phantom section: Right Section
Ambient temperature (°C): 21, Liquid temperature (°C): 21

Satimo Configuration:

- Probe:SSE5; Calibrated: 12/09/2011
- Sensor-Surface: 4mm (Mechanical Surface Detection)
- Phantom: SAM1; Type: SAM
- Measurement SW: OpenSAR V4_02_01

Configuration/GSM850 Mid Touch-Right/Area Scan: Measurement grid: dx=20mm, dy=20mm

Configuration/GSM850 Mid Touch-Right/Zoom Scan: Measurement grid: dx=8mm,
dy=8mm, dz=5mm;

Area Scan	sam_direct_droit2_surf8mm.txt
ZoomScan	5x5x7,dx=8mm dy=8mm dz=5mm,Very fast
Phantom	Right head
Device Position	Cheek
Band	GSM850
Channels	Middle
Signal	TDMA (Crest factor: 8.0)

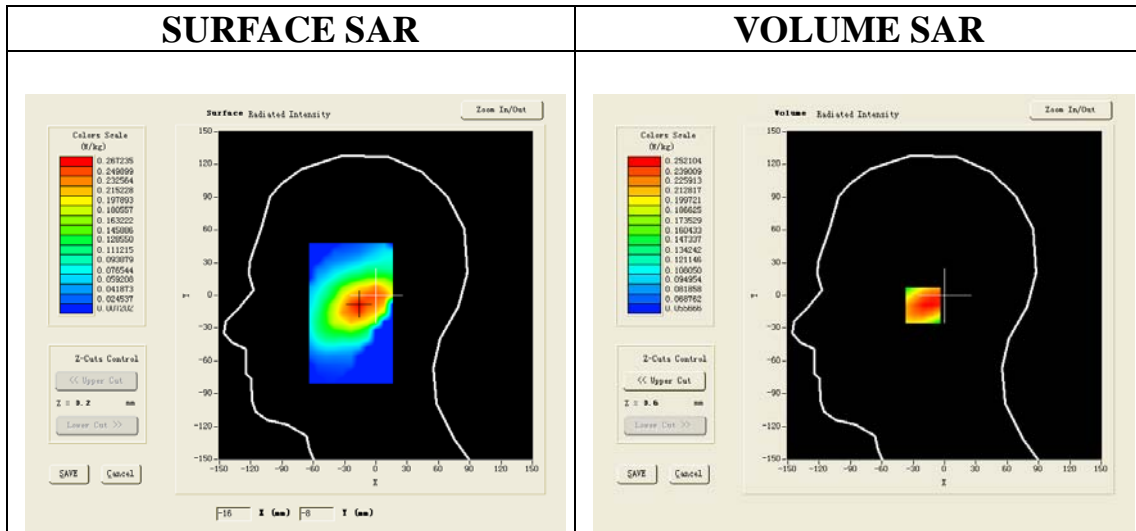

Maximum location: X=-17.00, Y=-9.00

SAR 10g (W/Kg)	0.182431
SAR 1g (W/Kg)	0.244151

Z (mm)	0.00	4.00	9.00	14.00	19.00
SAR (W/Kg)	0.0000	0.2509	0.1987	0.1569	0.1235

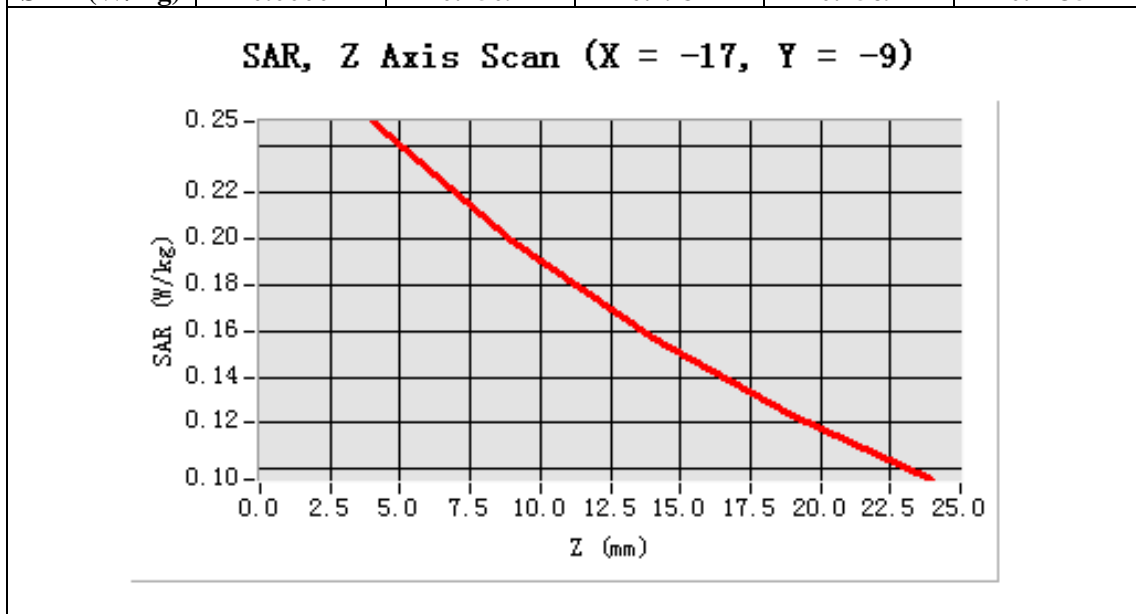

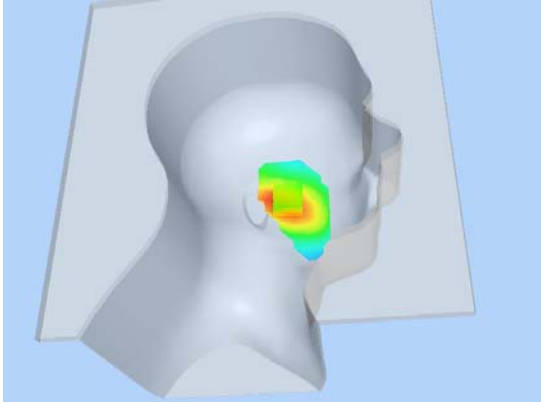
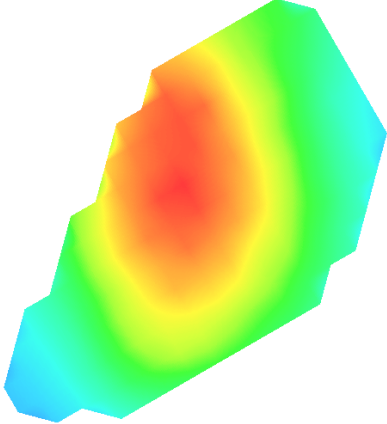
3D screen shot	Hot spot position
 A 3D rendered image of a human head model in profile, facing right. The head is light gray. A colorful hot spot is visible on the ear area, with a red center transitioning through yellow and green to blue at the edges. The background is a light blue gradient.	 A close-up view of the hot spot position. It is a 2D-like projection of the hot spot area, showing a color gradient from red in the center, transitioning through yellow and green to blue at the edges. The shape is irregular, roughly triangular with a jagged edge.

Test Laboratory: AGC Lab
GSM 850 Mid-tilt-Right <SIM 1>#
DUT:TINGLE; Type: S107

Date:APR.14,2012

Communication System: Generic GSM; Communication System Band: GSM 850; DutyCycle:1: 8; Conv.F=6.79
Frequency: 836.6 MHz; Medium parameters used: $f = 835$ MHz; $\sigma = 0.90$ mho/m; $\epsilon_r = 42.99$;
 $\rho = 1000$ kg/m³ ; Phantom section:Right Section
Ambient temperature (°C): 21, Liquid temperature (°C): 21

Satimo Configuration:

- Probe:SSE5; Calibrated: 12/09/2011
- Sensor-Surface: 4mm (Mechanical Surface Detection)
- Phantom: SAM1; Type: SAM
- Measurement SW: OpenSAR V4_02_01

Configuration/GSM850 Mid Tilt-Right/Area Scan: Measurement grid: dx=20mm, dy=20mm

Configuration/GSM850 Mid Tilt-Right/Zoom Scan: Measurement grid: dx=8mm,
dy=8mm, dz=5mm;

Area Scan	sam_direct_droit2_surf8mm.txt
Zoom Scan	5x5x7,dx=8mm dy=8mm dz=5mm,Very fast
Phantom	Right head
Device Position	Tilt
Band	GSM850
Channels	Middle
Signal	TDMA (Crest factor: 8.0)

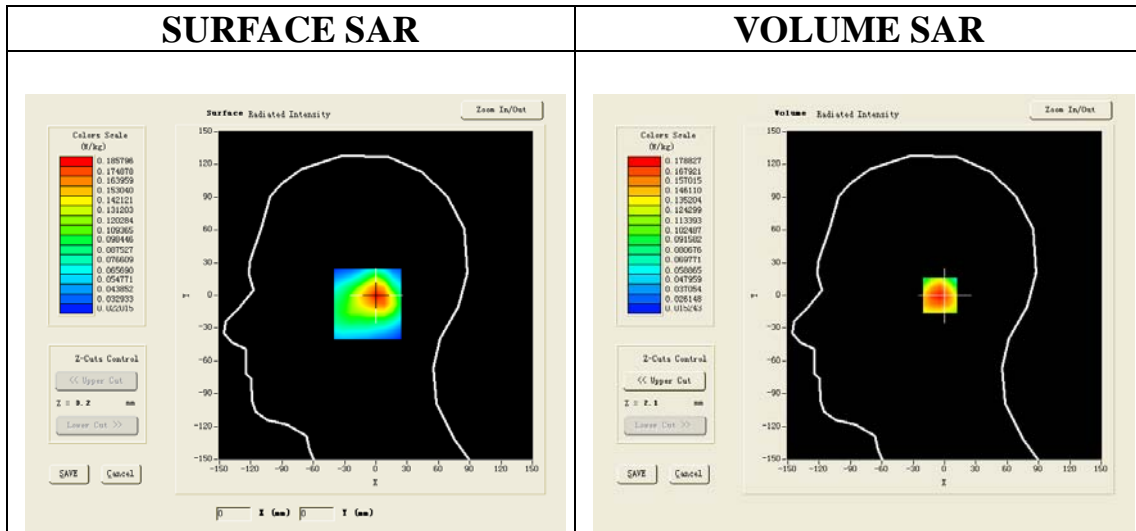

Maximum location: X=0.00, Y=0.00

SAR 10g (W/Kg)	0.115917
SAR 1g (W/Kg)	0.170051

Z (mm)	0.00	4.00	9.00	14.00	19.00
SAR (W/Kg)	0.0000	0.1788	0.1363	0.1012	0.0723

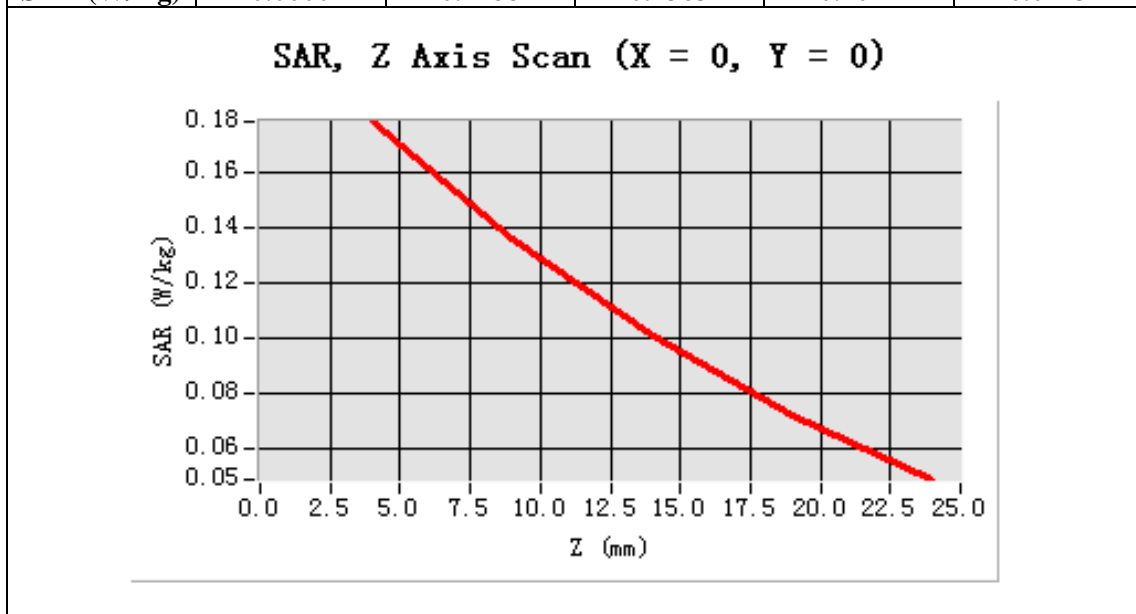

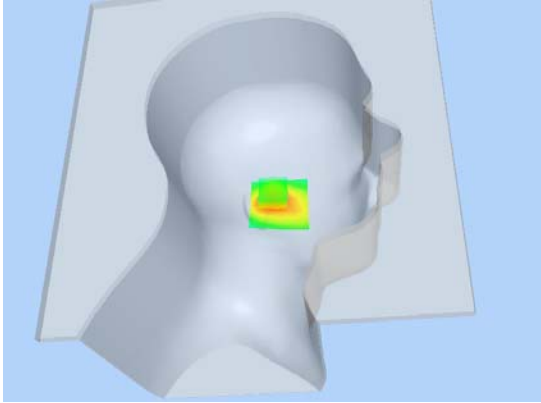
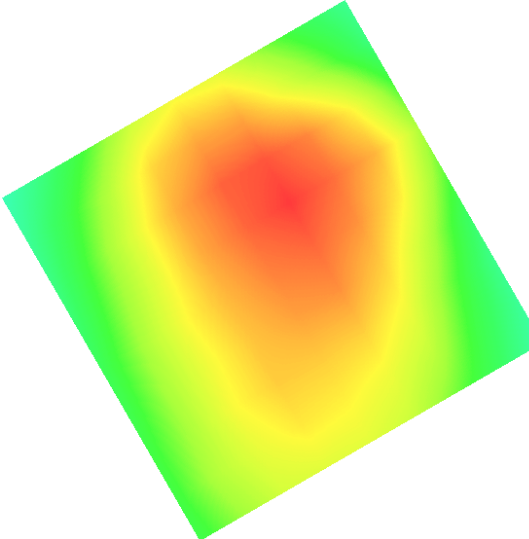
3D screen shot	Hot spot position
 A 3D rendering of a grey mannequin head in profile, facing right. A small, localized area on the ear is highlighted with a color gradient from green to red, indicating a hot spot. The background is a light blue gradient.	 A 2D heatmap representing the hot spot position. It features a central red area that transitions through orange and yellow to a green outer boundary. The heatmap is tilted at an angle, matching the orientation of the hot spot in the 3D view.

Test Laboratory: AGC Lab
GSM 850 Middle touch-Right<SIM 2>#
DUT:TINGLE; Type: S107

Date:APR.14,2012

Communication System: Generic GSM; Communication System Band: GSM 850; DutyCycle:1: 8; Conv.F=6.79
Frequency: 836.6 MHz; Medium parameters used: $f = 835$ MHz; $\sigma = 0.90$ mho/m; $\epsilon_r = 42.99$;
 $\rho = 1000$ kg/m³ ; Phantom section: Left Section
Ambient temperature (°C): 21, Liquid temperature (°C): 21

Satimo Configuration:

- Probe:SSE5; Calibrated: 12/09/2011
- Sensor-Surface: 4mm (Mechanical Surface Detection)
- Phantom: SAM1; Type: SAM
- Measurement SW: OpenSAR V4_02_01

Configuration/GSM850 Mid Touch-Right/Area Scan: Measurement grid: dx=20mm, dy=20mm

Configuration/GSM850 Mid Touch-Right/Zoom Scan: Measurement grid: dx=8mm,
dy=8mm, dz=5mm;

Area Scan	sam_direct_droit2_surf8mm.txt
ZoomScan	5x5x7,dx=8mm dy=8mm dz=5mm,Very fast
Phantom	Right head
Device Position	Cheek
Band	GSM850
Channels	Middle
Signal	TDMA (Crest factor: 8.0)

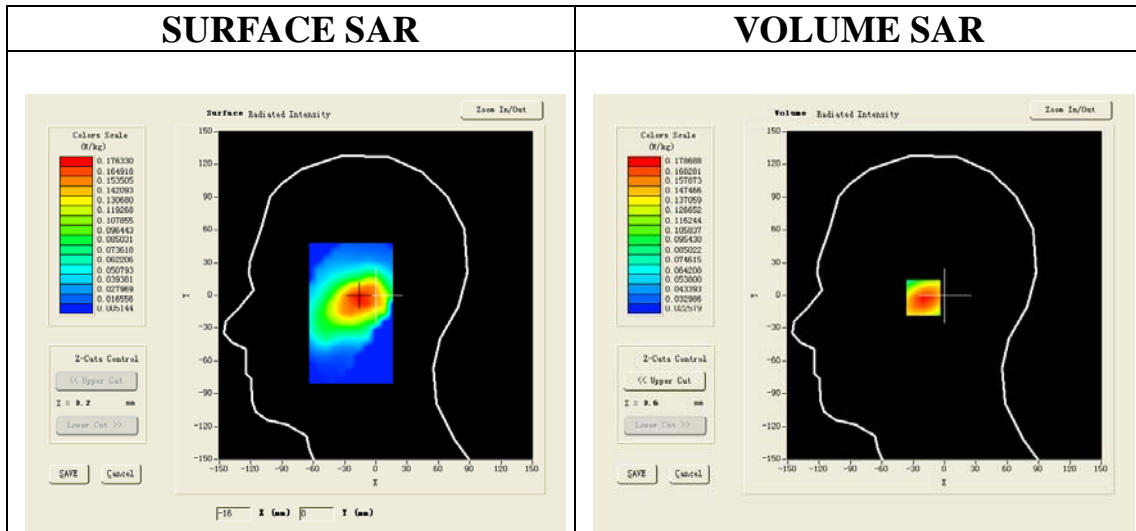

Maximum location: X=-17.00, Y=-2.00

SAR 10g (W/Kg)	0.120577
SAR 1g (W/Kg)	0.171423

Z (mm)	0.00	4.00	9.00	14.00	19.00
SAR (W/Kg)	0.0000	0.1787	0.1389	0.1057	0.0783

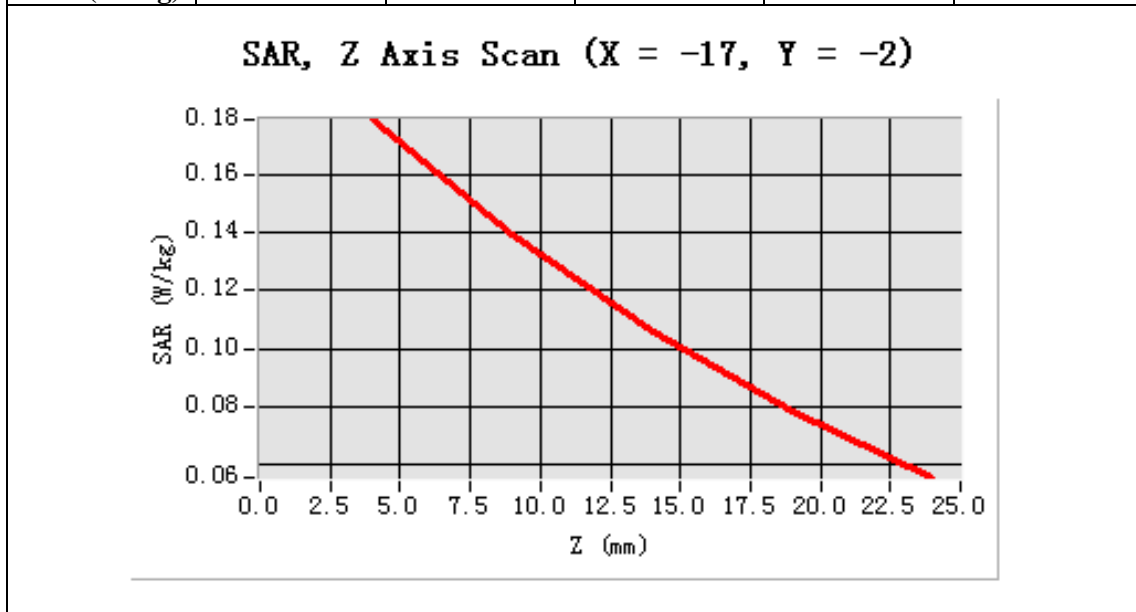

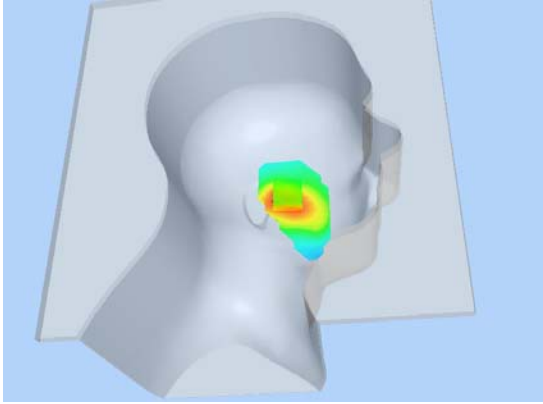
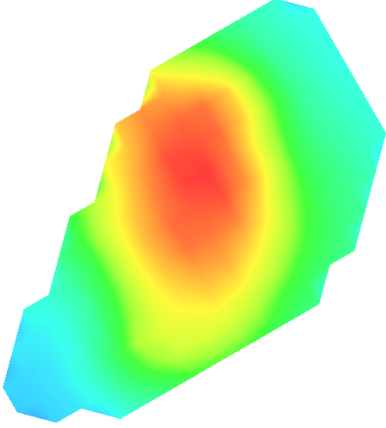
3D screen shot	Hot spot position
 A 3D rendering of a human head model in profile, facing right. A color-coded hot spot is visible on the ear area, with a red core transitioning through yellow and green to blue at the edges. The head is positioned on a light blue rectangular base against a light blue background.	 A close-up view of the hot spot position. It shows a color gradient from a central red core, transitioning through yellow and green, to a blue outer edge. The shape is irregular and roughly oval, representing the spatial distribution of the hot spot.

Test Laboratory: AGC Lab
GSM 850 Mid-Body-Worn Front (MS)<SIM 1>
DUT:TINGLE; Type:S107

Date:APR.14,2012

Communication System: Generic GSM; Communication System Band: GSM 850; Duty Cycle: 1:8; Conv.F=6.79
Frequency: 836.6 MHz; Medium parameters used: $f = 835$ MHz; $\sigma = 0.94$ mho/m; $\epsilon_r = 53.46$; $\rho = 1000$ kg/m³ ;
Phantom section: Flat Section
Ambient temperature (°C):21, Liquid temperature (°C):21

Satimo Configuration:

Probe:SSE5; Calibrated: 12/09/2011

- Sensor-Surface: 4mm (Mechanical Surface Detection)
- Phantom: SAM1; Type: SAM
- Measurement SW: OpenSAR V4_02_01

Configuration/GSM850 Mid Body-Front/Area Scan (6x8x1): Measurement grid: dx=20mm, dy=20mm

Configuration/GSM850 Mid Body-Front/Zoom Scan (5x5x7)/Cube 0: Measurement grid: dx=8mm, dy=8mm, dz=5mm;

Area Scan	surf_sam_plan.txt
ZoomScan	5x5x7,dx=8mm dy=8mm dz=5mm,Very fast
Phantom	Validation plane
Device Position	Body Front
Band	GSM850
Channels	Middle
Signal	TDMA (Crest factor: 8.0)

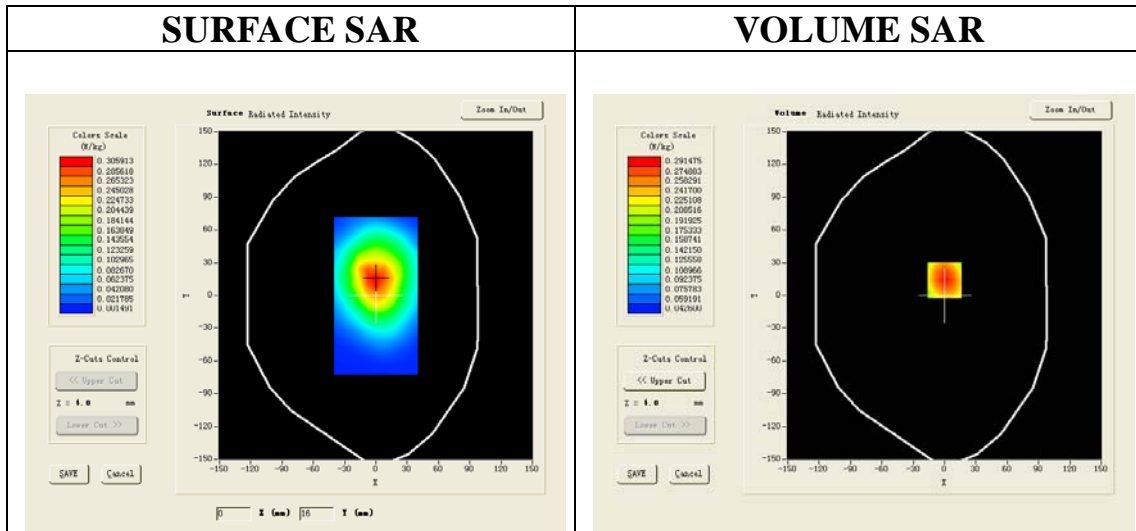

Maximum location: X=0.00, Y=14.00

SAR 10g (W/Kg)	0.208683
SAR 1g (W/Kg)	0.301222

Z (mm)	0.00	4.00	9.00	14.00	19.00
SAR (W/Kg)	0.0000	0.2915	0.2154	0.1570	0.1122

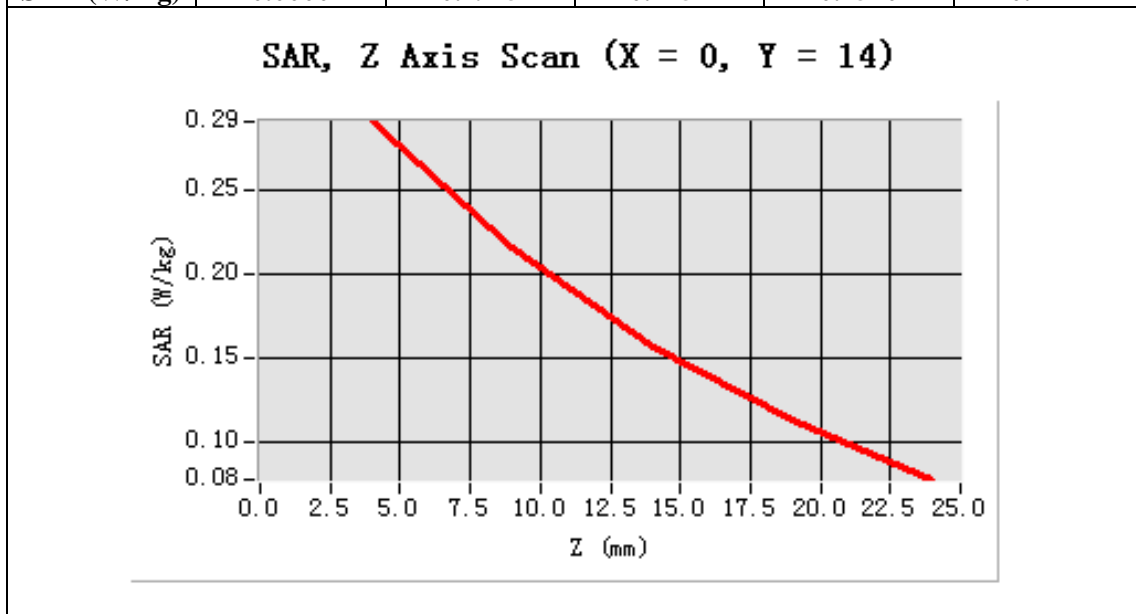

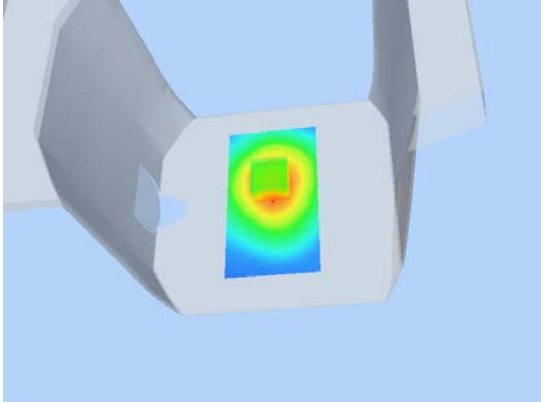
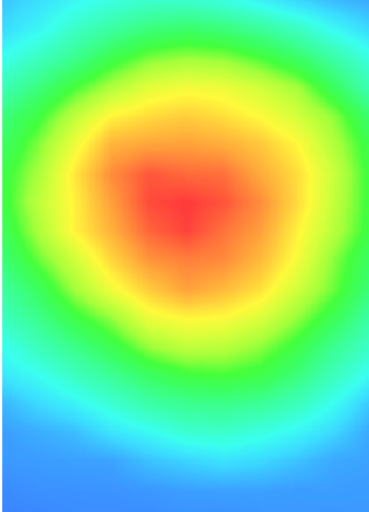
3D screen shot	Hot spot position
 A 3D perspective view of a grey, rectangular device. A small, square, multi-colored heatmap is overlaid on the front face of the device, indicating a localized hot spot. The colors transition from blue (cooler) to red (hottest) in the center of the square.	 A detailed, vertical heatmap showing the spatial distribution of the hot spot. It features a central red core, surrounded by concentric rings of orange, yellow, and green, with a blue outer boundary. The shape is roughly circular but elongated vertically.

Test Laboratory: AGC Lab
GPRS 850 Mid-body- Worn-Front (2up) <SIM 1>#
DUT:TINGLE; Type:S107

Date:APR.14,2012

Communication System: GPRS-2 Slot; Communication System Band: GSM850;Duty Cycle:1:4.2 ; Conv.F=6.79
Frequency: 836.6 MHz; Medium parameters used: $f = 835 \text{ MHz}$; $\sigma = 0.94 \text{ mho/m}$; $\epsilon_r = 53.46$; $\rho = 1000 \text{ kg/m}^3$; Phantom section: Flat Section
Ambient temperature ($^{\circ}\text{C}$):21, Liquid temperature ($^{\circ}\text{C}$):21

Satimo Configuration:

- Probe:SSE5; Calibrated: 12/09/2011
- Sensor-Surface: 4mm (Mechanical Surface Detection)
 - Phantom: SAM1; Type: SAM
 - Measurement SW: OpenSAR V4_02_01

Configuration/GPRS850 Mid Body-Front/Area Scan (6x8x1): Measurement grid: dx=20mm, dy=20mm

Configuration/GPRS850 Mid Body-Front/Zoom Scan (5x5x7)/Cube 0: Measurement grid: dx=8mm, dy=8mm, dz=5mm;

Area Scan	surf_sam_plan.txt
ZoomScan	5x5x7,dx=8mm dy=8mm dz=5mm,Very fast
Phantom	Validation plane
Device Position	Body Front
Band	GSM850
Channels	Middle
Signal	TDMA (Crest factor: 4.0)

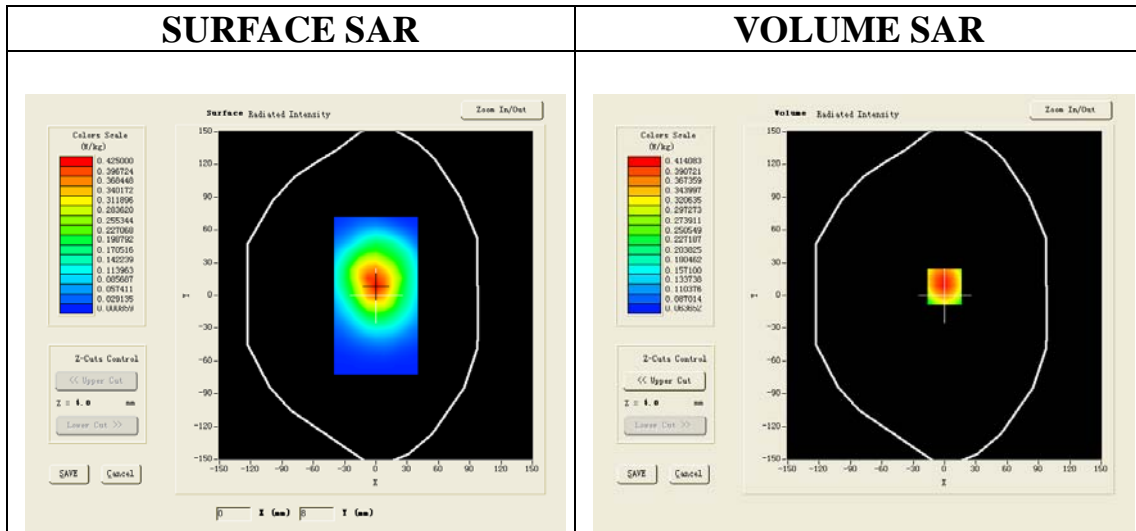

Maximum location: X=0.00, Y=8.00

SAR 10g (W/Kg)	0.293183
SAR 1g (W/Kg)	0.429562

Z (mm)	0.00	4.00	9.00	14.00	19.00
SAR (W/Kg)	0.0000	0.4141	0.2913	0.2106	0.1582

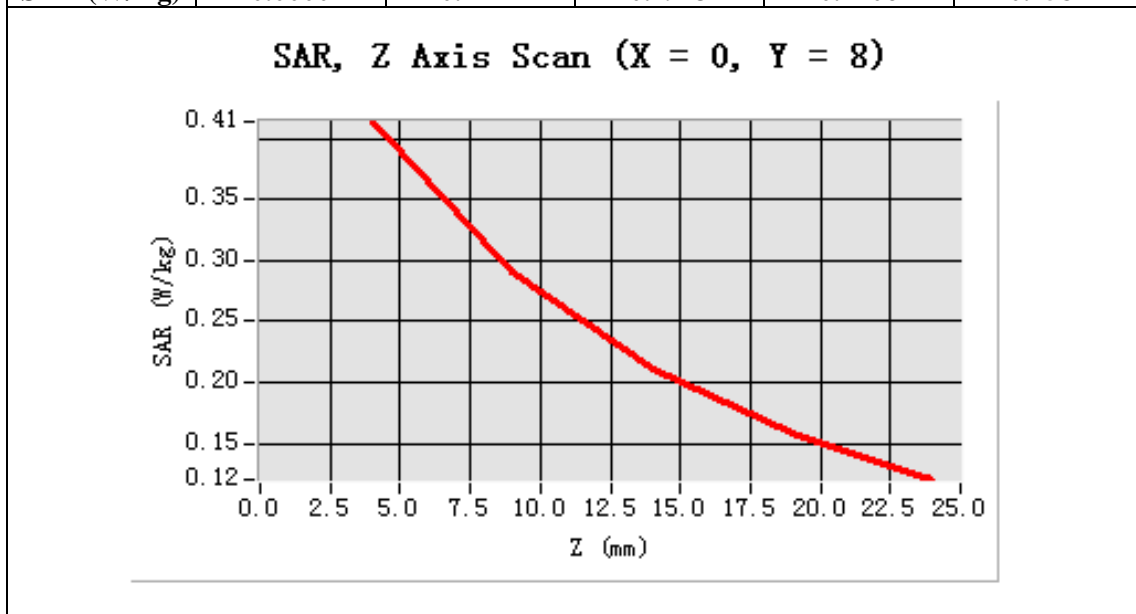

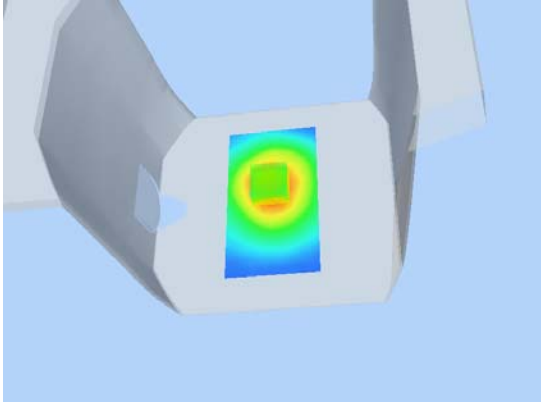
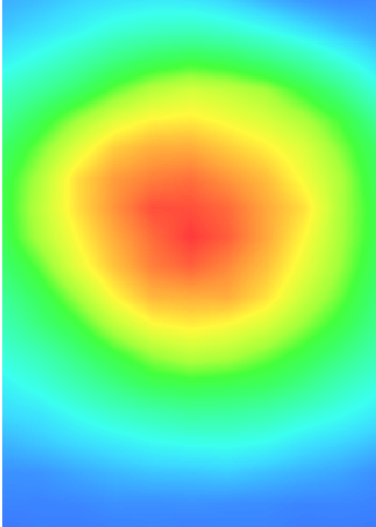
3D screen shot	Hot spot position
 A 3D perspective view of a grey, rectangular device. A square area on the front face of the device is highlighted with a color gradient overlay, indicating a hot spot. The colors range from blue (cooler) to red (hottest), with yellow and green in between.	 A 2D heatmap showing the spatial distribution of the hot spot. It features a central red core, surrounded by concentric rings of yellow, green, and cyan, all set against a blue background. This represents the intensity of the hot spot across a rectangular area.

Test Laboratory: AGC Lab
GPRS 850 Mid-body- Worn-Front (3up) <SIM 1>#
DUT:TINGLE; Type:S107

Date:APR.14,2012

Communication System: GPRS-3 Slot; Communication System Band: GSM850;Duty Cycle:1:2.7 ; Conv.F=6.79
Frequency: 836.6 MHz; Medium parameters used: $f = 835 \text{ MHz}$; $\sigma = 0.94 \text{ mho/m}$; $\epsilon_r = 53.46$; $\rho = 1000 \text{ kg/m}^3$; Phantom section: Flat Section
Ambient temperature ($^{\circ}\text{C}$):21, Liquid temperature ($^{\circ}\text{C}$):21

Satimo Configuration:

Probe:SSE5; Calibrated: 12/09/2011

- Sensor-Surface: 4mm (Mechanical Surface Detection)
- Phantom: SAM1; Type: SAM
- Measurement SW: OpenSAR V4_02_01

Configuration/GPRS850 Mid Body-Front/Area Scan (6x8x1): Measurement grid: dx=20mm, dy=20mm

Configuration/GPRS850 Mid Body-Front/Zoom Scan (5x5x7)/Cube 0: Measurement grid: dx=8mm, dy=8mm, dz=5mm;

Area Scan	surf_sam_plan.txt
ZoomScan	5x5x7,dx=8mm dy=8mm dz=5mm,Very fast
Phantom	Validation plane
Device Position	Body Front
Band	GSM850
Channels	Middle
Signal	TDMA (Crest factor: 2.7)

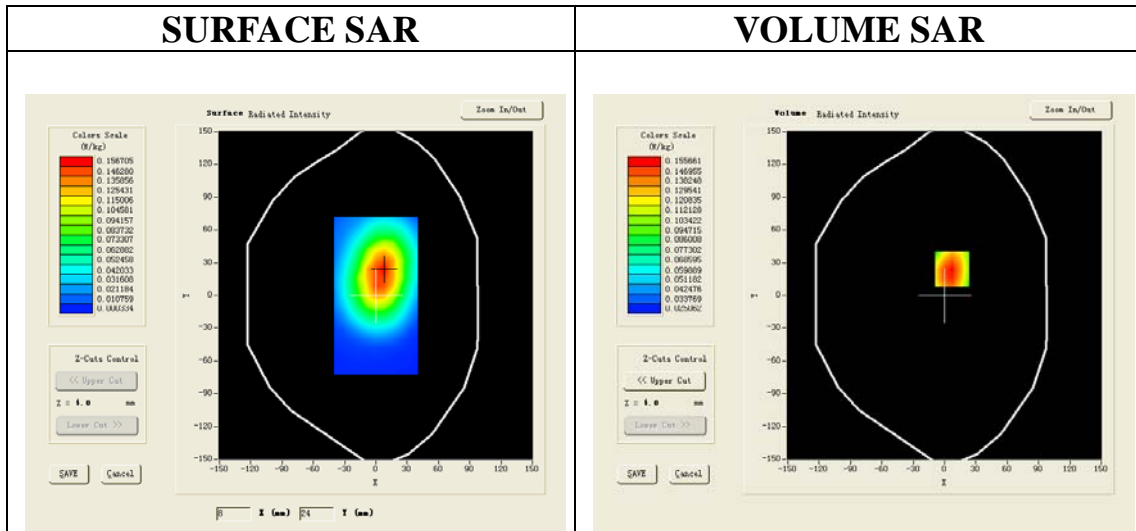

Maximum location: X=7.00, Y=24.00

SAR 10g (W/Kg)	0.111505
SAR 1g (W/Kg)	0.161302

Z (mm)	0.00	4.00	9.00	14.00	19.00
SAR (W/Kg)	0.0000	0.1557	0.1157	0.0855	0.0625

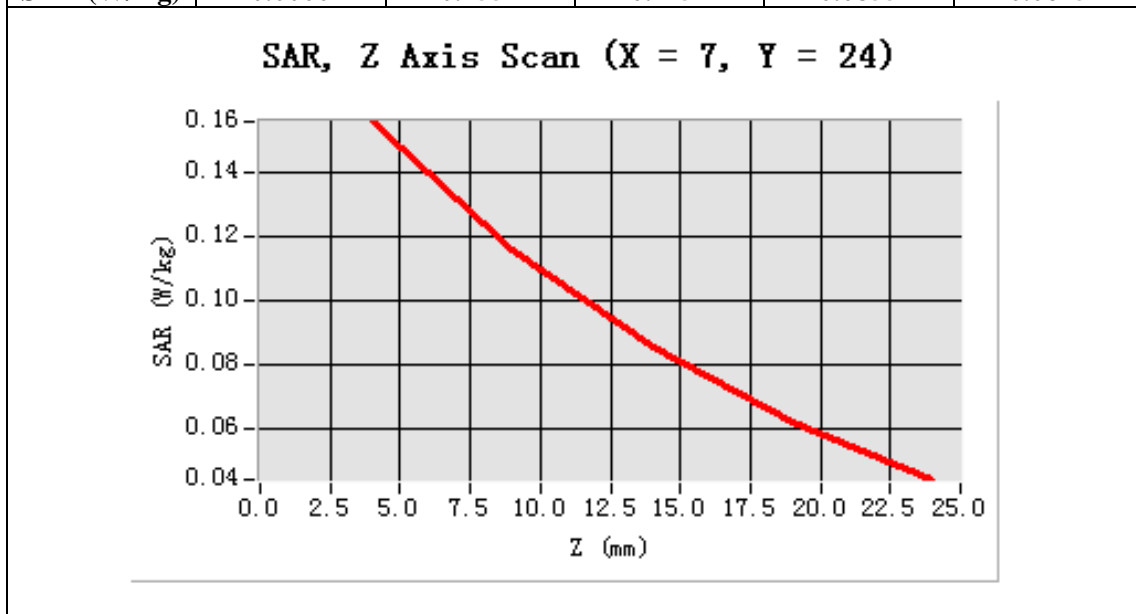

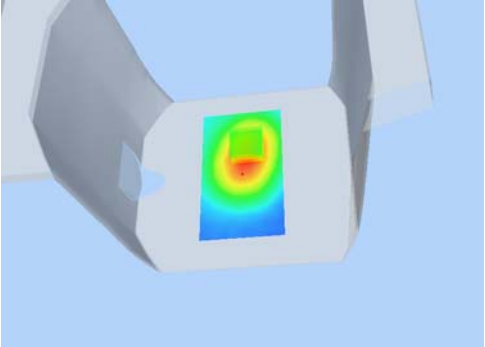
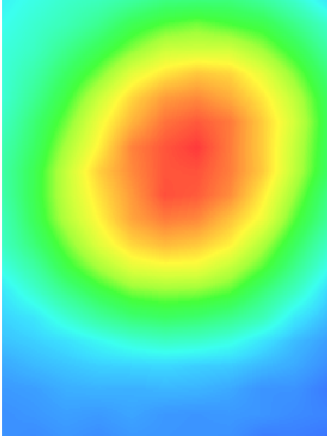
3D screen shot	Hot spot position
 A 3D perspective view of a grey, rectangular component with a central opening. A color-coded hot spot is visible on the inner surface of the opening, with a red center transitioning through yellow and green to blue at the edges.	 A 2D heatmap showing the spatial distribution of the hot spot. It features a central red circular region, surrounded by concentric rings of yellow, green, and blue, indicating a radial gradient of intensity.

Test Laboratory: AGC Lab
GPRS 850 Mid-body- Worn-Front (4up) <SIM 1>#
DUT:TINGLE; Type:S107

Date:APR.14,2012

Communication System: GPRS-4 Slot; Communication System Band: GSM850;Duty Cycle:1:2 ; Conv.F=6.79
Frequency: 836.6 MHz; Medium parameters used: $f = 835 \text{ MHz}$; $\sigma = 0.94 \text{ mho/m}$; $\epsilon_r = 53.46$; $\rho = 1000 \text{ kg/m}^3$; Phantom section: Flat Section
Ambient temperature ($^{\circ}\text{C}$):21, Liquid temperature ($^{\circ}\text{C}$):21

Satimo Configuration:

- Probe:SSE5; Calibrated: 12/09/2011
- Sensor-Surface: 4mm (Mechanical Surface Detection)
 - Phantom: SAM1; Type: SAM
 - Measurement SW: OpenSAR V4_02_01

Configuration/GPRS850 Mid Body-Front/Area Scan (6x8x1): Measurement grid: dx=20mm, dy=20mm

Configuration/GPRS850 Mid Body-Front/Zoom Scan (5x5x7)/Cube 0: Measurement grid: dx=8mm, dy=8mm, dz=5mm;

Area Scan	surf_sam_plan.txt
ZoomScan	5x5x7,dx=8mm dy=8mm dz=5mm,Very fast
Phantom	Validation plane
Device Position	Body Front
Band	GSM850
Channels	Middle
Signal	TDMA (Crest factor: 2.0)

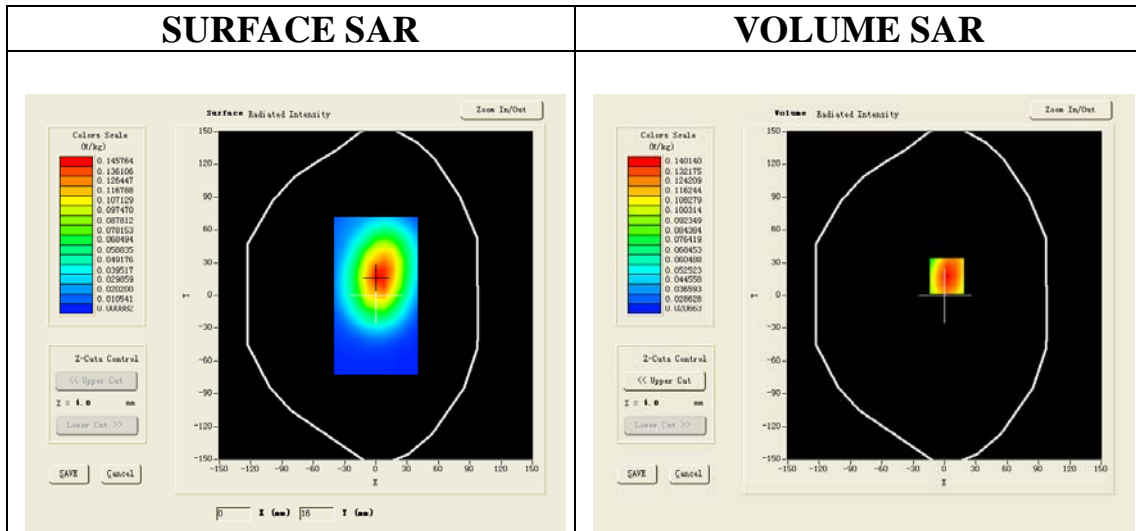

Maximum location: X=2.00, Y=18.00

SAR 10g (W/Kg)	0.100686
SAR 1g (W/Kg)	0.144585

Z (mm)	0.00	4.00	9.00	14.00	19.00
SAR (W/Kg)	0.0000	0.1401	0.1059	0.0784	0.0565

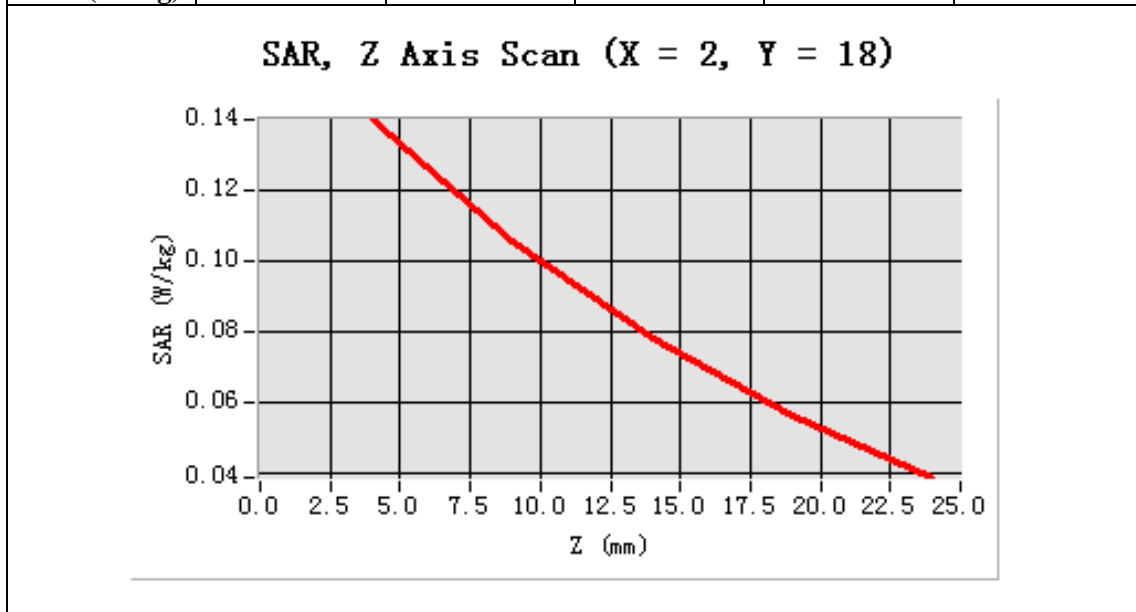

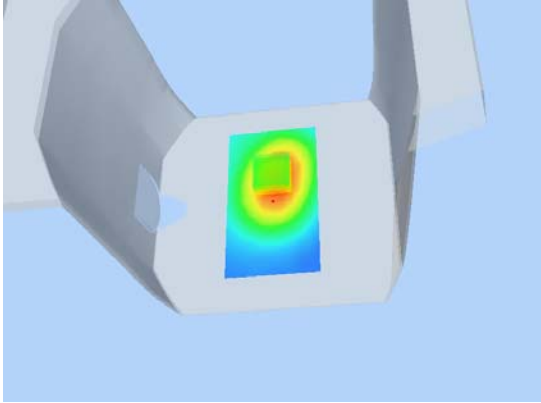
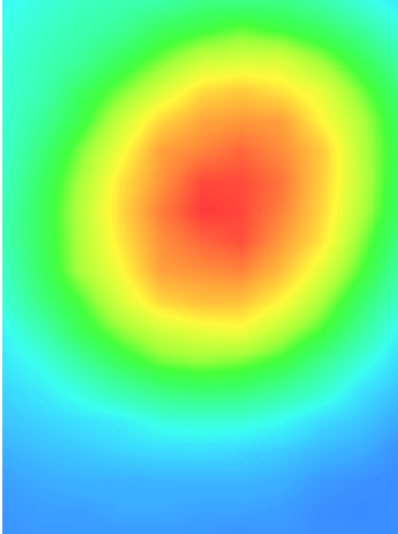
3D screen shot	Hot spot position
 A 3D perspective view of a grey, rectangular device. A small, square, multi-colored heatmap is overlaid on the front face of the device, indicating a localized hot spot. The colors transition from blue at the edges to red in the center.	 A detailed, vertical heatmap showing the hot spot position. It features a central red core surrounded by concentric rings of orange, yellow, and green, all set against a blue background. The shape is roughly circular but elongated vertically.

Test Laboratory: AGC Lab
GPRS 850 Mid-body- Worn-Back(2 up) <SIM 1>#
DUT:TINGLE; Type:S107

Date:APR.14,2012

Communication System: General GSM; Communication System Band: GSM 850;Duty Cycle:1:4.2 ;
ConvF=6.79
Frequency: 836.6 MHz; Medium parameters used: $f = 835$ MHz; $\sigma = 0.94$ mho/m; $\epsilon_r = 53.46$; $\rho = 1000$ kg/m³ ; Phantom section: Flat Section
Ambient temperature (°C):21, Liquid temperature (°C):21

Satimo Configuration:

- Probe:SSE5; Calibrated: 12/09/2011
- Sensor-Surface: 4mm (Mechanical Surface Detection)
- Phantom: SAM1; Type: SAM
- Measurement SW: OpenSAR V4_02_01

Configuration/GSM 850 Mid Body-Back/Area Scan (6x8x1): Measurement grid: dx=20mm, dy=20mm

Configuration/GSM 850 Mid Body-Back/Zoom Scan (5x5x7)/Cube 0: Measurement grid: dx=8mm, dy=8mm, dz=5mm;

Area Scan	surf_sam_plan.txt
ZoomScan	5x5x7,dx=8mm dy=8mm dz=5mm,Very fast
Phantom	Validation plane
Device Position	Body Back
Band	GSM850
Channels	Middle
Signal	TDMA (Crest factor:4)

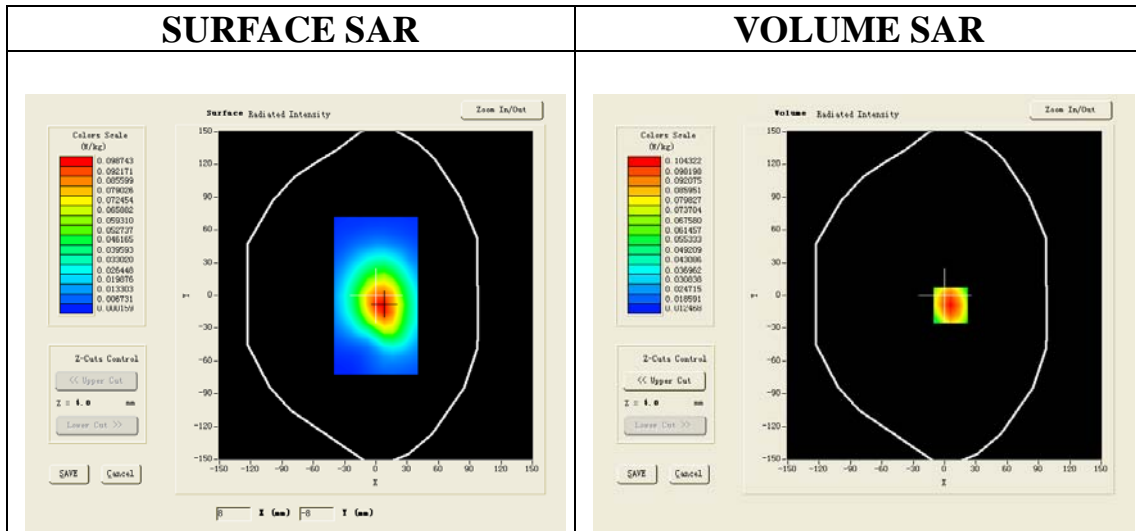

Maximum location: X=6.00, Y=-9.00

SAR 10g (W/Kg)	0.065711
SAR 1g (W/Kg)	0.099068

Z (mm)	0.00	4.00	9.00	14.00	19.00
SAR (W/Kg)	0.0000	0.1043	0.0732	0.0521	0.0379

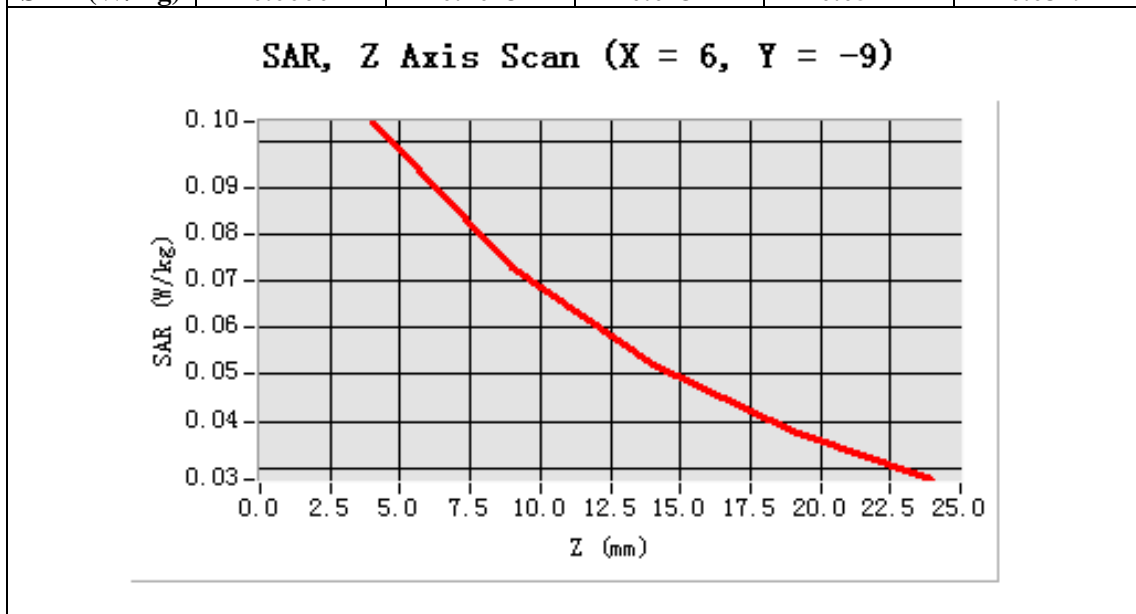

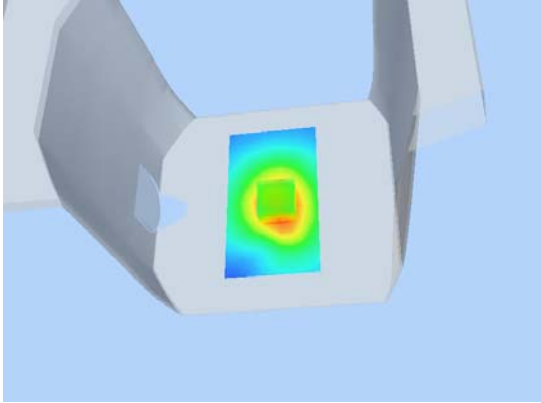
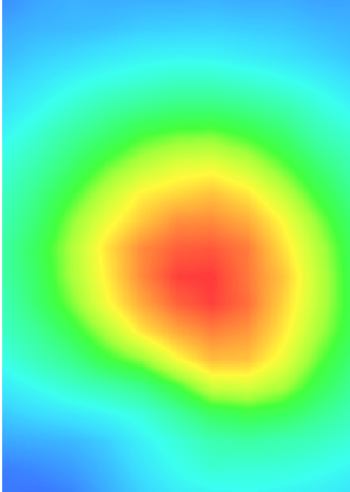
3D screen shot	Hot spot position
 A 3D perspective view of a grey, rectangular device. A small, square, multi-colored heatmap is overlaid on the front face of the device, indicating a localized hot spot. The colors transition from blue (cooler) to red (hottest) in the center.	 A close-up, rectangular heatmap showing the hot spot position. The center is a bright red circle, surrounded by concentric rings of yellow, green, and cyan, fading to blue at the edges. This represents a radial temperature gradient.

Test Laboratory: AGC Lab
GPRS 850 Mid-body- Worn-Back(2 up)With earphone <SIM 1>#
DUT:TINGLE; Type:S107

Date:APR.14,2012

Communication System: General GSM; Communication System Band: GSM 850;Duty Cycle:1:4.2 ;
ConvF=6.79
Frequency: 836.6 MHz; Medium parameters used: $f = 835$ MHz; $\sigma = 0.94$ mho/m; $\epsilon_r = 53.46$; $\rho = 1000$ kg/m³ ; Phantom section: Flat Section
Ambient temperature (°C):21, Liquid temperature (°C):21

Satimo Configuration:

- Probe:SSE5; Calibrated: 12/09/2011
- Sensor-Surface: 4mm (Mechanical Surface Detection)
- Phantom: SAM1; Type: SAM
- Measurement SW: OpenSAR V4_02_01

Configuration/GSM 850 Mid Body-Back/Area Scan: Measurement grid: dx=20mm, dy=20mm

Configuration/GSM 850 Mid Body-Back/Zoom Scan: Measurement grid: dx=8mm, dy=8mm, dz=5mm;

Area Scan	surf_sam_plan.txt
ZoomScan	5x5x7,dx=8mm dy=8mm dz=5mm,Very fast
Phantom	Validation plane
Device Position	Body Back
Band	GSM850
Channels	Middle
Signal	TDMA (Crest factor:4.0)

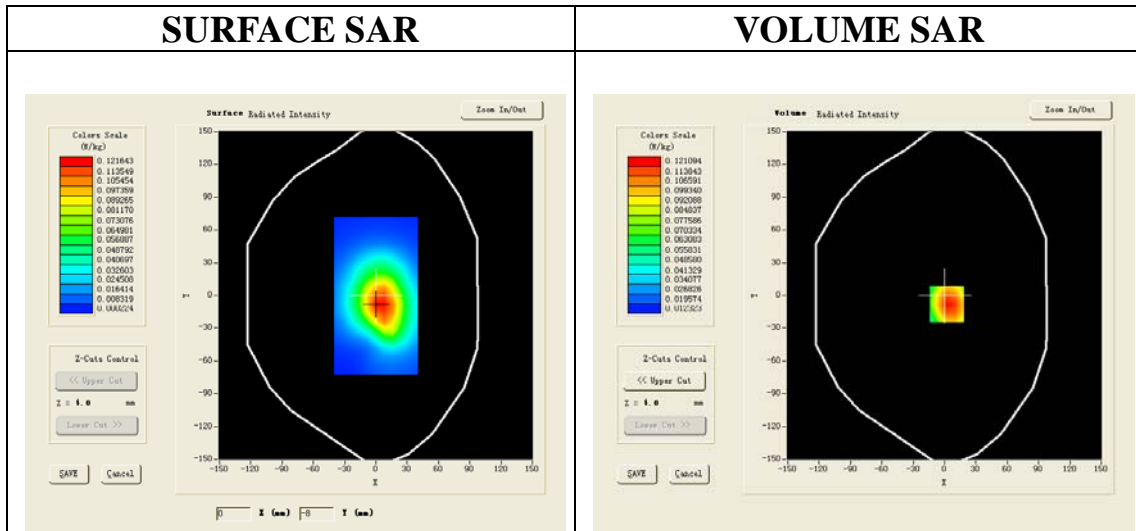

Maximum location: X=2.00, Y=-8.00

SAR 10g (W/Kg)	0.078133
SAR 1g (W/Kg)	0.115943

Z (mm)	0.00	4.00	9.00	14.00	19.00
SAR (W/Kg)	0.0000	0.1211	0.0897	0.0652	0.0463

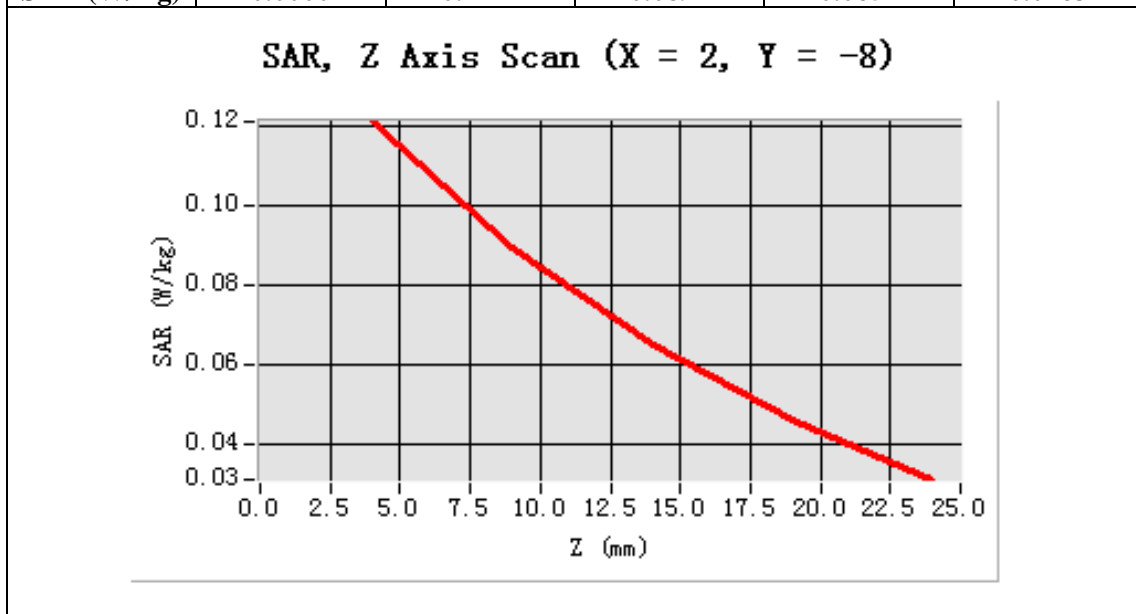

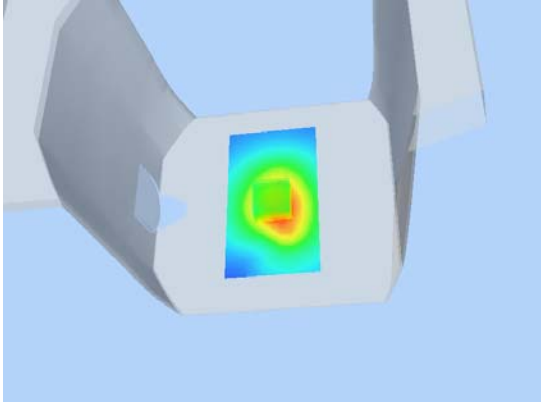
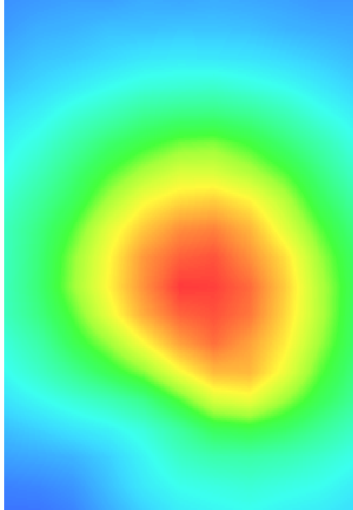
3D screen shot	Hot spot position
 A 3D perspective view of a grey, rectangular device. A small, square, multi-colored heatmap is overlaid on the front face of the device, indicating a localized hot spot. The colors transition from blue (cooler) to red (hottest).	 A detailed, rectangular heatmap showing the spatial distribution of the hot spot. The center is a bright red circle, surrounded by concentric rings of orange, yellow, green, and cyan, indicating a radial temperature gradient.

Test Laboratory: AGC Lab
PCS 1900 Mid-Touch Left <SIM 1>
DUT:TINGLE; Type:S107

Date:APR.14,2012

Communication System: Generic GSM;Communication System Band: PCS 1900;Duty Cycle:1:8;ConvF=6.42
Frequency: 1880 MHz; Medium parameters used: $f = 1900$ MHz; $\sigma = 1.41$ mho/m; $\epsilon_r = 40.17$;
 $\rho = 1000$ kg/m³ ; Phantom section: Left Section
Ambient temperature (°C):21, Liquid temperature (°C):21

Satimo Configuration:

- Probe:SSE5; Calibrated: 12/09/2011
- Sensor-Surface: 4mm (Mechanical Surface Detection)
- Phantom: SAM1; Type: SAM
- Measurement SW: OpenSAR V4_02_01

Configuration/PCS1900 Mid Touch-Left/Area Scan: Measurement grid: dx=20mm, dy=20mm

Configuration/PCS1900 Mid Touch-Left/Zoom Scan: Measurement grid: dx=8mm,
dy=8mm, dz=5mm;

Area Scan	sam_direct_droit2_surf8mm.txt
ZoomScan	5x5x7,dx=8mm dy=8mm dz=5mm,Very fast
Phantom	Left head
Device Position	Cheek
Band	GSM1900
Channels	Middle
Signal	TDMA (Crest factor: 8.0)

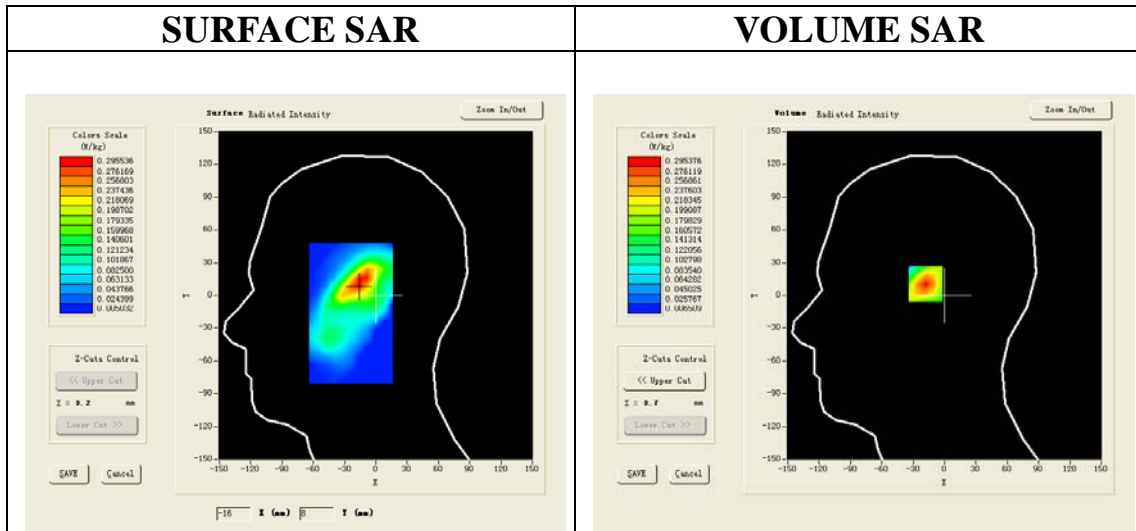

Maximum location: X=-16.00, Y=11.00

SAR 10g (W/Kg)	0.155738
SAR 1g (W/Kg)	0.274483

Z (mm)	0.00	4.00	9.00	14.00	19.00
SAR (W/Kg)	0.0000	0.2954	0.1865	0.1149	0.0688

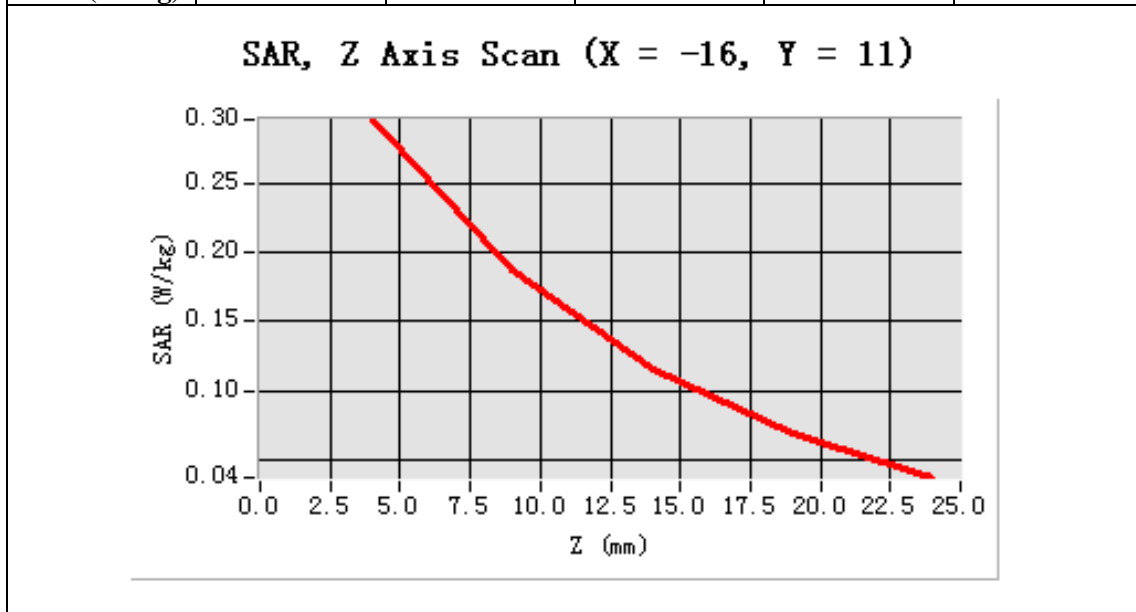

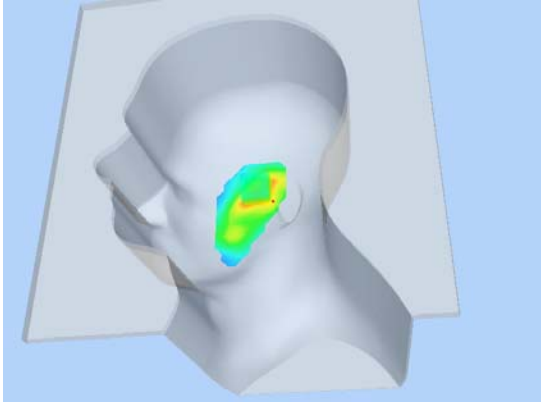
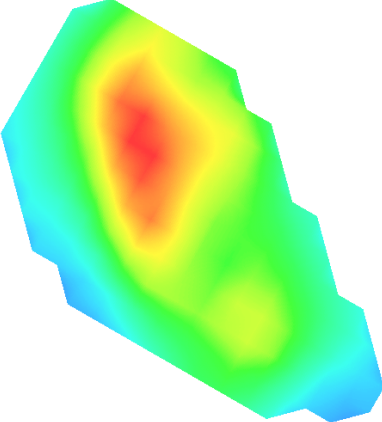
3D screen shot	Hot spot position
 A 3D rendered model of a human head in profile, facing left. The head is light gray. A small, irregularly shaped area on the ear is highlighted with a color gradient from blue to red, indicating a hot spot. The background is a light blue gradient.	 A close-up view of the hot spot area. It is a 2D-like projection of the 3D model's surface, showing a color gradient from blue (low intensity) to red (high intensity). The red area is concentrated in the center, with yellow and green areas surrounding it, and blue areas at the edges.

Test Laboratory: AGC Lab
PCS 1900 Mid-Tilt-Left <SIM 1>
DUT:TINGLE; Type:S107

Date:APR.14,2012

Communication System: Generic GSM; Communication System Band: PCS 1900; Duty Cycle: 1:8; ConvF=6.42
Frequency: 1880 MHz; Medium parameters used: $f = 1900$ MHz; $\sigma = 1.41$ mho/m; $\epsilon_r = 40.17$; $\rho = 1000$ kg/m³ ;
Phantom section: Left Section
Ambient temperature (°C):21, Liquid temperature (°C):21

Satimo Configuration:

Probe:SSE5; Calibrated: 12/09/2011

- Sensor-Surface: 4mm (Mechanical Surface Detection)
- Phantom: SAM1; Type: SAM
- Measurement SW: OpenSAR V4_02_01

Configuration/PCS1900 Mid Tilt-Left/Area Scan: Measurement grid: dx=20mm, dy=20mm

Configuration/PCS1900 Mid Tilt-Left/Zoom Scan: Measurement grid: dx=8mm, dy=8mm, dz=5mm;

Area Scan	sam_direct_droit2_surf8mm.txt
ZoomScan	5x5x7,dx=8mm dy=8mm dz=5mm,Very fast
Phantom	Left head
Device Position	Tilt
Band	GSM1900
Channels	Middle
Signal	TDMA (Crest factor: 8.0)

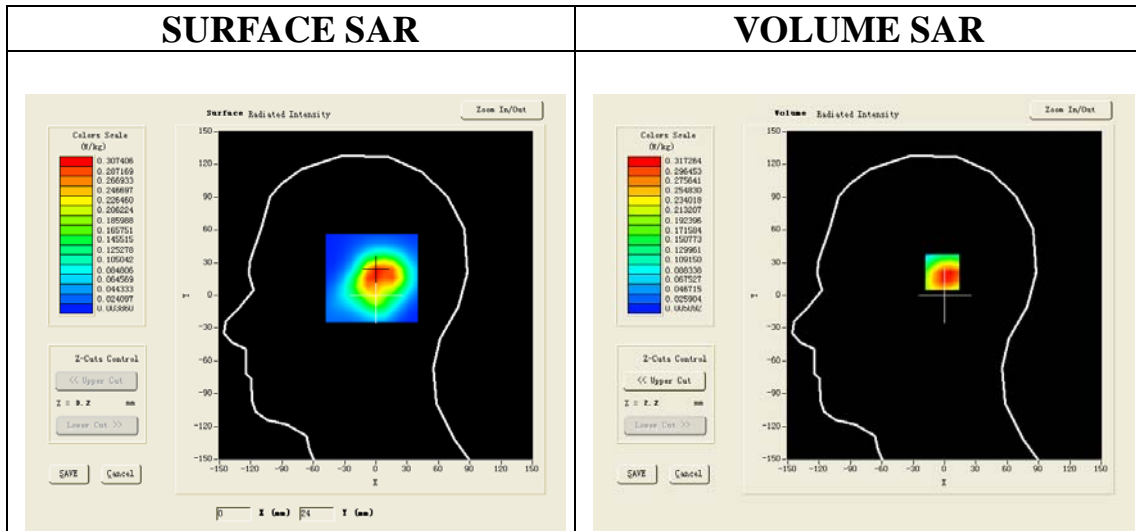

Maximum location: X=1.00, Y=22.00

SAR 10g (W/Kg)	0.167715
SAR 1g (W/Kg)	0.309016

Z (mm)	0.00	4.00	9.00	14.00	19.00
SAR (W/Kg)	0.0000	0.3099	0.1606	0.0848	0.0491

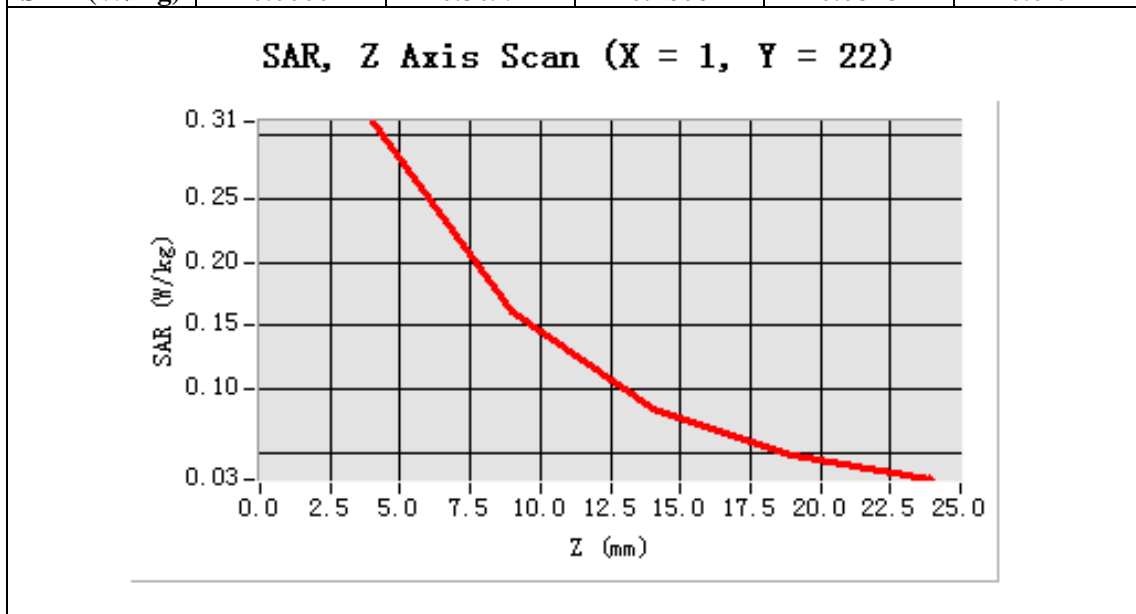

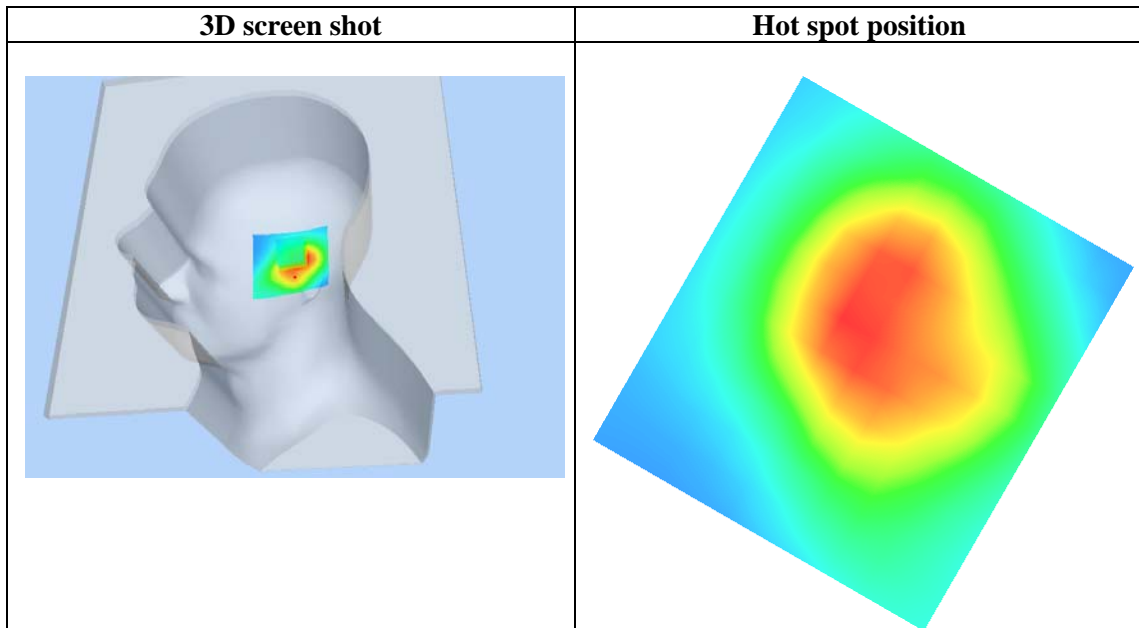

Test Laboratory: AGC Lab
PCS 1900 Mid-Touch Right <SIM 1>
DUT:TINGLE; Type:S107

Date:APR.14,2012

Communication System: Generic GSM; Communication System Band: PCS 1900; Duty Cycle: 1:8; ConvF=6.42
Frequency: 1880 MHz; Medium parameters used: $f = 1900$ MHz; $\sigma = 1.41$ mho/m; $\epsilon_r = 40.17$; $\rho = 1000$ kg/m³ ;
Phantom section: Right Section
Ambient temperature (°C):21, Liquid temperature (°C):21

Satimo Configuration:

Probe:SSE5; Calibrated: 12/09/2011

- Sensor-Surface: 4mm (Mechanical Surface Detection)
- Phantom: SAM1; Type: SAM
- Measurement SW: OpenSAR V4_02_01

Configuration/PCS1900 Mid Touch-Right/Area Scan: Measurement grid: dx=20mm, dy=20mm

Configuration/PCS1900 Mid Touch-Right/Zoom Scan: Measurement grid: dx=8mm,
dy=8mm, dz=5mm;

Area Scan	sam_direct_droit2_surf8mm.txt
ZoomScan	5x5x7,dx=8mm dy=8mm dz=5mm,Very fast
Phantom	Right head
Device Position	Cheek
Band	GSM1900
Channels	Middle
Signal	TDMA (Crest factor: 8.0)

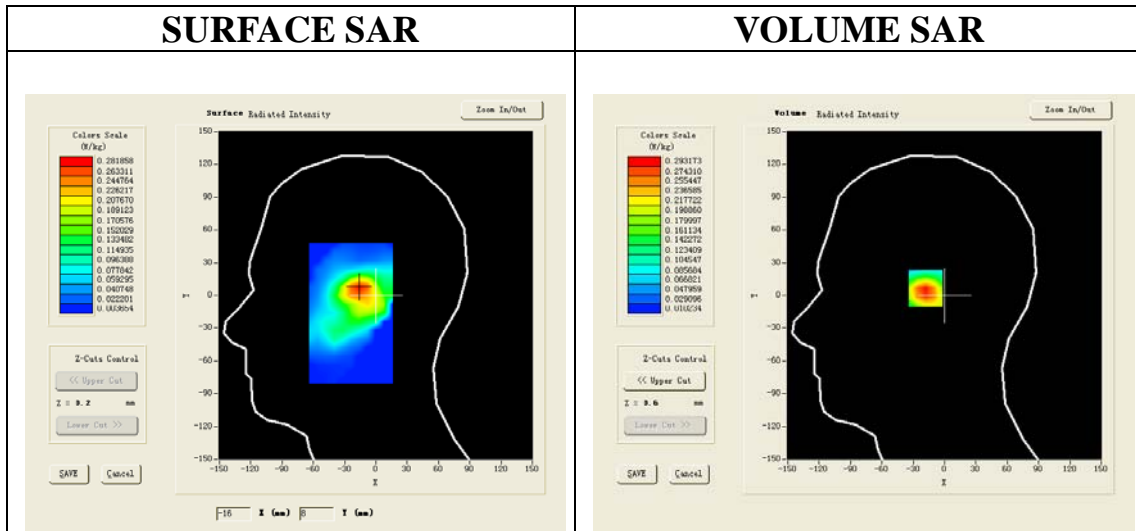

Maximum location: X=-16.00, Y=7.00

SAR 10g (W/Kg)	0.163509
SAR 1g (W/Kg)	0.279784

Z (mm)	0.00	4.00	9.00	14.00	19.00
SAR (W/Kg)	0.0000	0.2932	0.1930	0.1259	0.0814

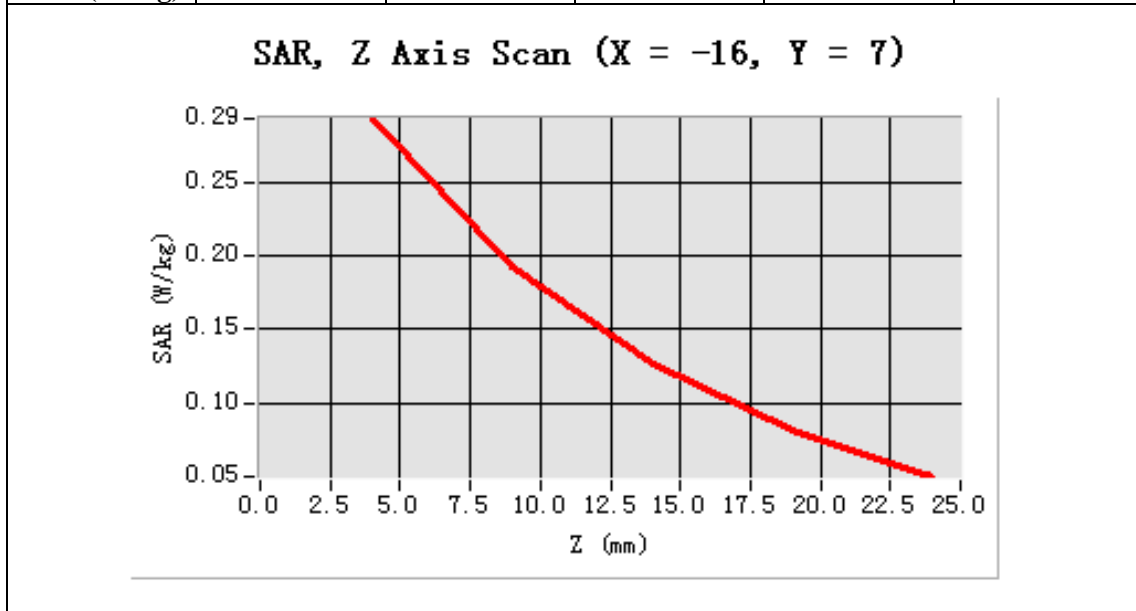

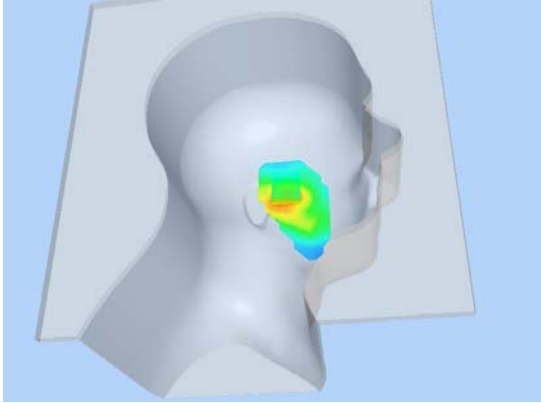
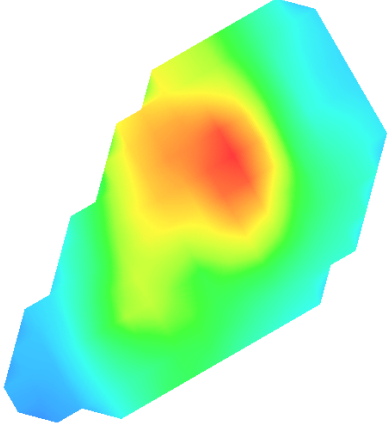
3D screen shot	Hot spot position
 A 3D rendered image of a human head model in profile, facing right. The head is light gray. A small, irregularly shaped area on the ear is highlighted with a color gradient from blue to red, indicating a hot spot. The background is a light blue gradient.	 A close-up view of the hot spot area. It is a 2D-like projection of the 3D model's surface, showing a color gradient from blue (low intensity) to red (high intensity). The red area is concentrated in the center, surrounded by yellow, green, and cyan.

Test Laboratory: AGC Lab
PCS 1900 Mid-Tilt Right <SIM 1>
DUT:TINGLE; Type:S107

Date:APR.14,2012

Communication System: Generic GSM; Communication System Band: PCS 1900; Duty Cycle: 1:8; ConvF=6.42
Frequency: 1880 MHz; Medium parameters used: $f = 1900$ MHz; $\sigma = 1.41$ mho/m; $\epsilon_r = 40.17$; $\rho = 1000$ kg/m³ ;
Phantom section: Right Section
Ambient temperature (°C):21, Liquid temperature (°C):21

Satimo Configuration:

Probe:SSE5; Calibrated: 12/09/2011

- Sensor-Surface: 4mm (Mechanical Surface Detection)
- Phantom: SAM1; Type: SAM
- Measurement SW: OpenSAR V4_02_01

Configuration/PCS1900 Mid Tilt-Right/Area Scan: Measurement grid: dx=20mm, dy=20mm

Configuration/PCS1900 Mid Tilt-Right/Zoom Scan: Measurement grid: dx=8mm,
dy=8mm, dz=5mm;

Area Scan	sam_direct_droit2_surf8mm.txt
ZoomScan	5x5x7,dx=8mm dy=8mm dz=5mm,Very fast
Phantom	Right head
Device Position	Tilt
Band	GSM1900
Channels	Middle
Signal	TDMA (Crest factor: 8.0)

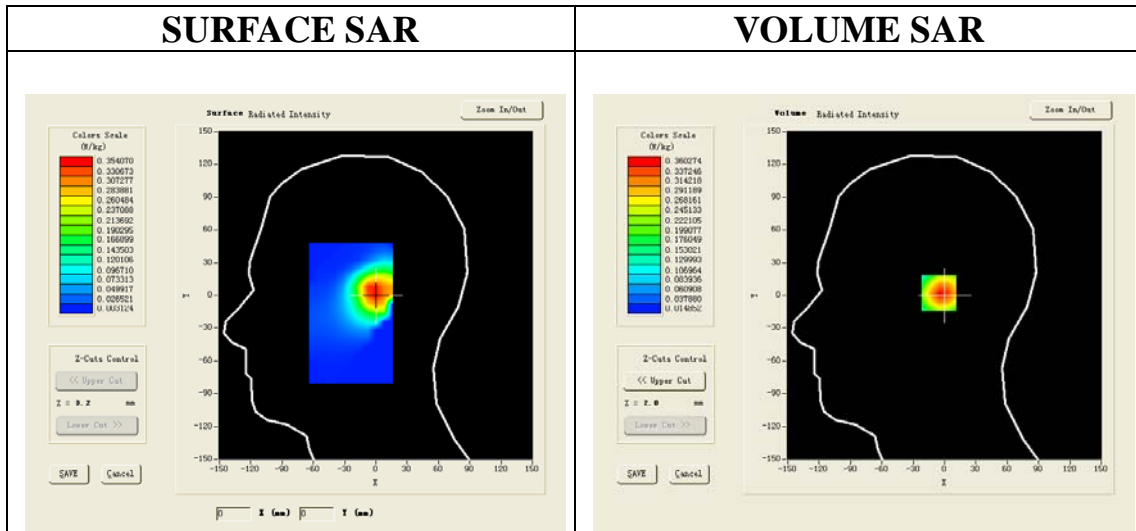

Maximum location: X=-1.00, Y=2.00

SAR 10g (W/Kg)	0.195667
SAR 1g (W/Kg)	0.342245

Z (mm)	0.00	4.00	9.00	14.00	19.00
SAR (W/Kg)	0.0000	0.3603	0.2100	0.1238	0.0762

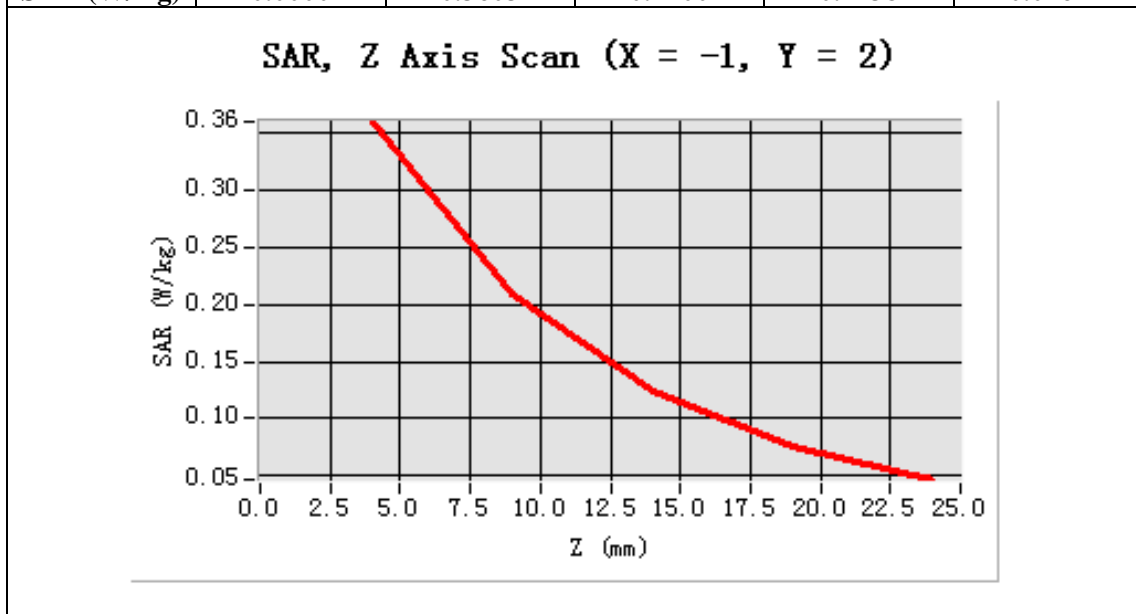

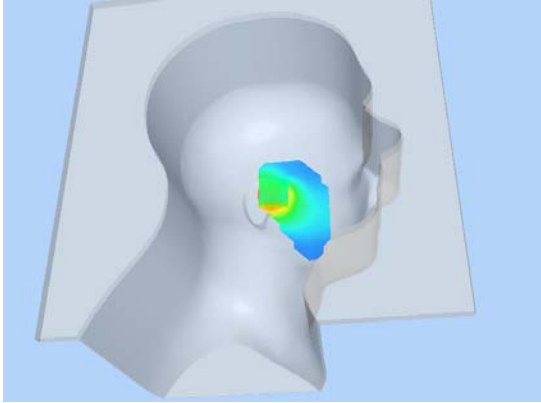
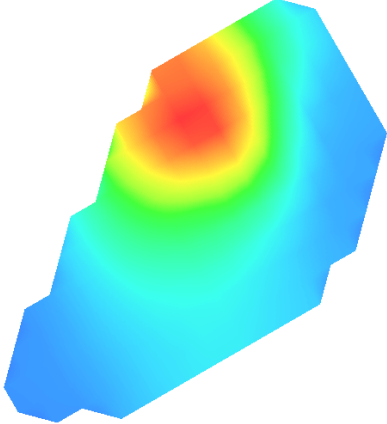
3D screen shot	Hot spot position
 A 3D rendering of a human head model in profile, facing right. The ear area is highlighted with a color gradient from blue to red, indicating a hot spot. The rest of the head is shown in a light gray color.	 A close-up view of the hot spot position on the ear area. The hot spot is represented by a color gradient from blue to red, with the red area indicating the highest intensity. The shape is irregular, following the contour of the ear.

Test Laboratory: AGC Lab
PCS 1900 Mid-Title Right<SIM 2>
DUT:TINGLE; Type:S107

Date:APR.14,2012

Communication System: Generic GSM; Communication System Band: PCS 1900; Duty Cycle: 1:8; ConvF=6.42
Frequency: 1880 MHz; Medium parameters used: $f = 1900$ MHz; $\sigma = 1.41$ mho/m; $\epsilon_r = 40.17$; $\rho = 1000$ kg/m³ ;
Phantom section: Right Section
Ambient temperature (°C):21, Liquid temperature (°C):21

Satimo Configuration:

Probe:SSE5; Calibrated: 12/09/2011

- Sensor-Surface: 4mm (Mechanical Surface Detection)
- Phantom: SAM1; Type: SAM
- Measurement SW: OpenSAR V4_02_01

Configuration/PCS1900 Mid Title-Right/Area Scan: Measurement grid: dx=20mm, dy=20mm

Configuration/PCS1900 Mid Title-Right/Zoom Scan: Measurement grid: dx=8mm,
dy=8mm, dz=5mm;

Area Scan	sam_direct_droit2_surf8mm.txt
ZoomScan	5x5x7,dx=8mm dy=8mm dz=5mm,Very fast
Phantom	Right head
Device Position	Title
Band	GSM1900
Channels	Middle
Signal	TDMA (Crest factor: 8.0)

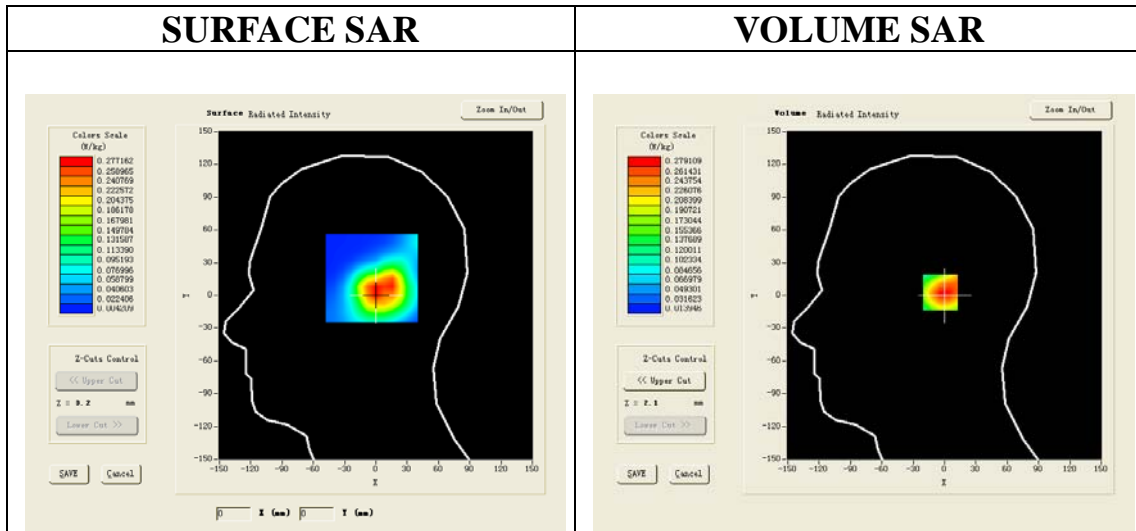

Maximum location: X=0.00, Y=3.00

SAR 10g (W/Kg)	0.158758
SAR 1g (W/Kg)	0.267845

Z (mm)	0.00	4.00	9.00	14.00	19.00
SAR (W/Kg)	0.0000	0.2791	0.1722	0.1060	0.0659

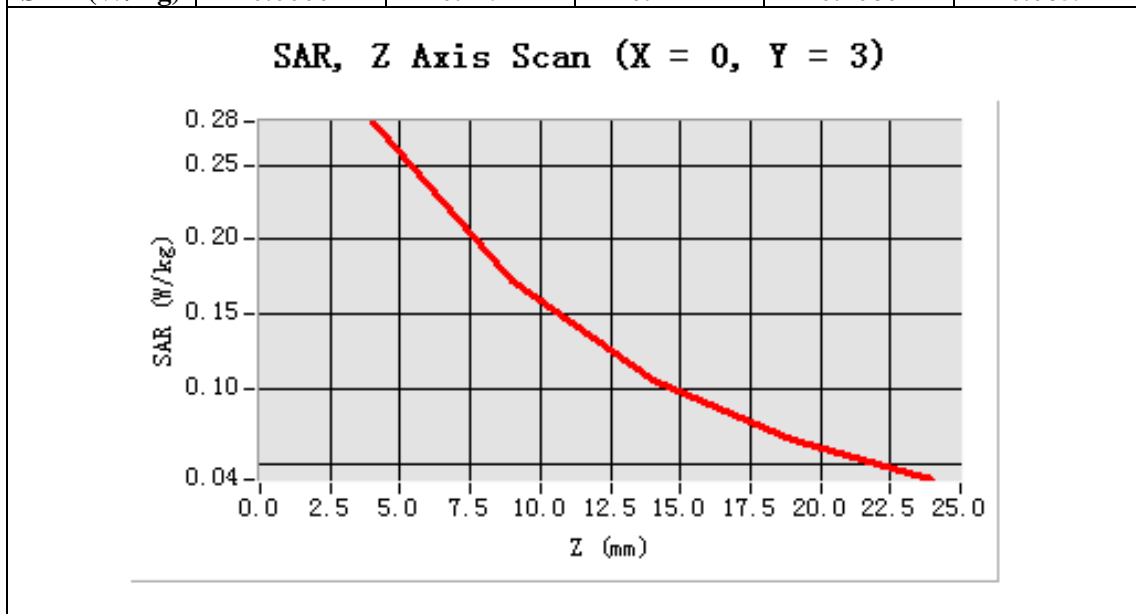

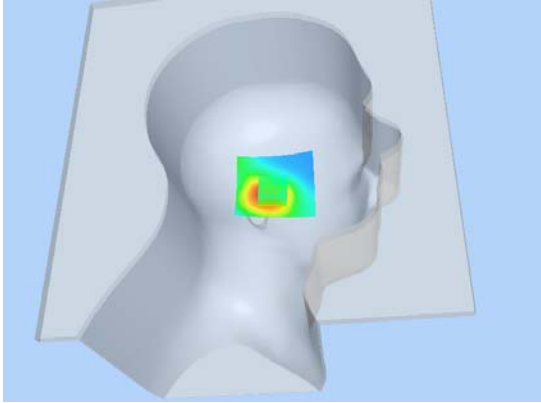
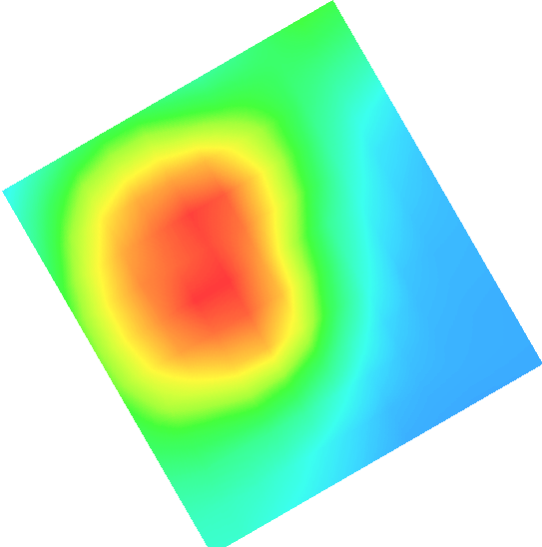
3D screen shot	Hot spot position
 A 3D rendered model of a human head in profile, facing right. A small, square, multi-colored hot spot is overlaid on the ear area. The hot spot shows a gradient from blue to green to yellow to red, indicating a localized area of high intensity.	 A detailed view of the hot spot position. It is a rectangular area with a color gradient. The center is red, transitioning through yellow and green to blue at the edges. The entire area is tilted at an angle.

Test Laboratory: AGC Lab
PCS 1900 Mid-Body-worn-Front <SIM 1>
DUT:TINGLE; Type:S107

Date:APR.14,2012

Communication System: Generic GSM; Communication System Band: PCS 1900; Duty Cycle: 1:8; ConvF=6.42
Frequency: 1880 MHz; Medium parameters used: $f = 1900$ MHz; $\sigma = 1.49$ mho/m; $\epsilon_r = 53.27$; $\rho = 1000$ kg/m³ ;
Phantom section: Flat Section
Ambient temperature (°C):21, Liquid temperature (°C):21

Satimo Configuration:

Probe:SSE5; Calibrated: 12/09/2011

- Sensor-Surface: 4mm (Mechanical Surface Detection)
- Phantom: SAM1; Type: SAM
- Measurement SW: OpenSAR V4_02_01

Configuration/PCS1900 Mid Body-Front/Area Scan: Measurement grid: dx=20mm, dy=20mm

Configuration/PCS1900 Mid Body-Front/Zoom Scan: Measurement grid: dx=8mm,
dy=8mm, dz=5mm;

Area Scan	surf_sam_plan.txt
ZoomScan	5x5x7,dx=8mm dy=8mm dz=5mm,Very fast
Phantom	Validation plane
Device Position	Body Front
Band	GSM1900
Channels	Middle
Signal	TDMA (Crest factor: 8.0)

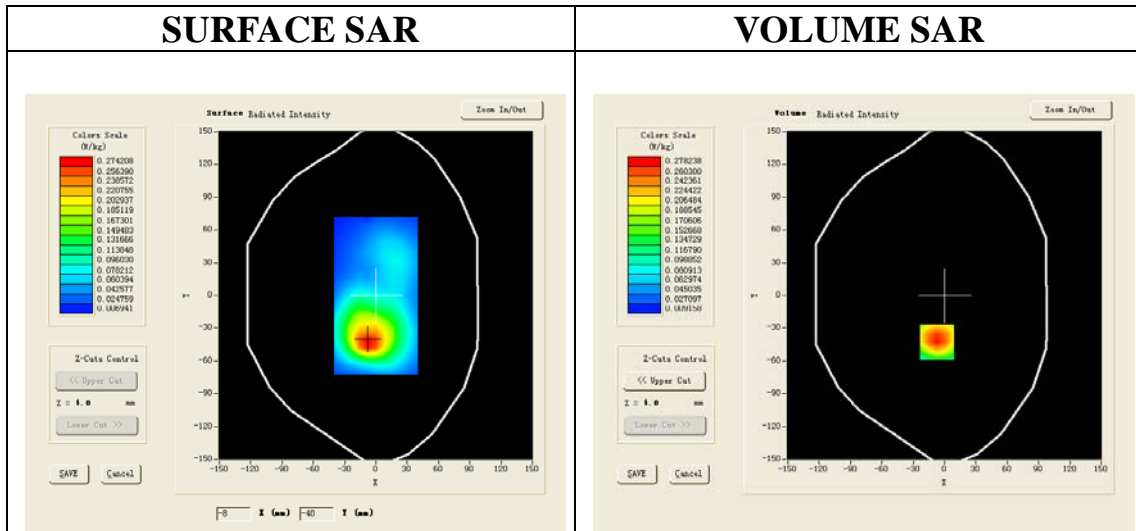

Maximum location: X=-7.00, Y=-43.00

SAR 10g (W/Kg)	0.149473
SAR 1g (W/Kg)	0.264567

Z (mm)	0.00	4.00	9.00	14.00	19.00
SAR (W/Kg)	0.0000	0.2782	0.1627	0.0941	0.0546

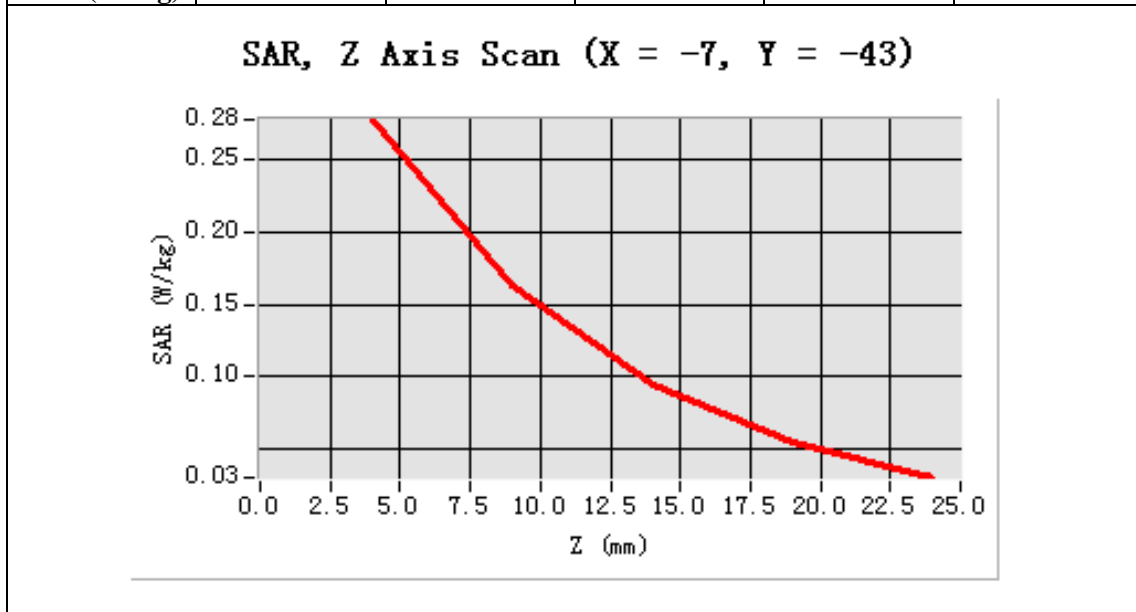

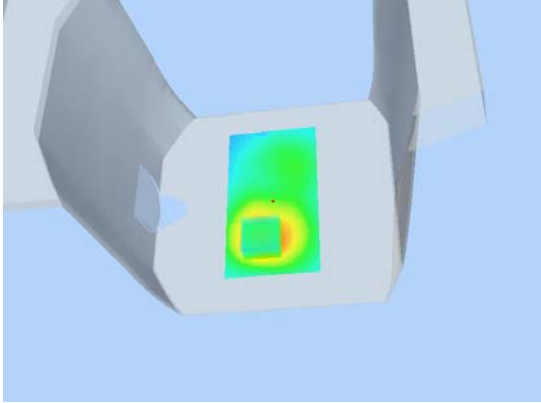
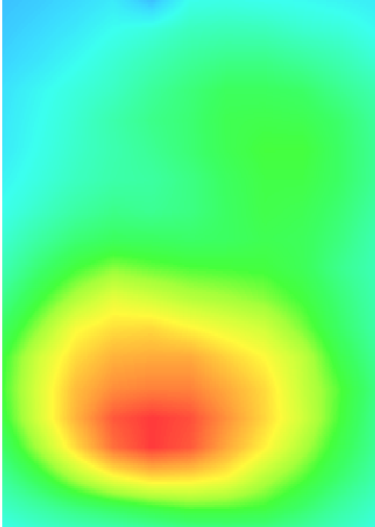
3D screen shot	Hot spot position
 A 3D perspective view of a grey, rectangular device. A small rectangular area on the front face of the device is highlighted with a color gradient from green to yellow to red, indicating a hot spot. The device is set against a light blue background.	 A close-up, 2D view of the hot spot area. It shows a circular region with a color gradient from green at the edges to yellow and then red in the center, representing the intensity of the hot spot.

Test Laboratory: AGC Lab
GPRS 1900 Mid-Body- worn-Front (2up) <SIM1>
DUT:TINGLE; Type:S107

Date:APR.14,2012

Communication System: GPRS-2 Slot; Communication System Band: PCS1900;Duty Cycle: 1:4.2; convF=6.42
Frequency: 1880 MHz; Medium parameters used: $f = 1900$ MHz; $\sigma = 1.49$ mho/m; $\epsilon_r = 53.27$; $\rho = 1000$ kg/m³ ;
Phantom section: Flat Section
Ambient temperature (°C):21, Liquid temperature (°C):21

Satimo Configuration:

Probe:SSE5; Calibrated: 12/09/2011

- Sensor-Surface: 4mm (Mechanical Surface Detection)
- Phantom: SAM1; Type: SAM
- Measurement SW: OpenSAR V4_02_01

Configuration/GPRS1900 Mid Body-Front/Area Scan: Measurement grid: dx=20mm, dy=20mm

Configuration/GPRS1900 Mid Body-Front/Zoom Scan: Measurement grid: dx=8mm,
dy=8mm, dz=5m;

Area Scan	surf_sam_plan.txt
ZoomScan	5x5x7,dx=8mm dy=8mm dz=5mm,Very fast
Phantom	Validation plane
Device Position	Body Front
Band	GSM1900
Channels	Middle
Signal	TDMA (Crest factor: 4.0)

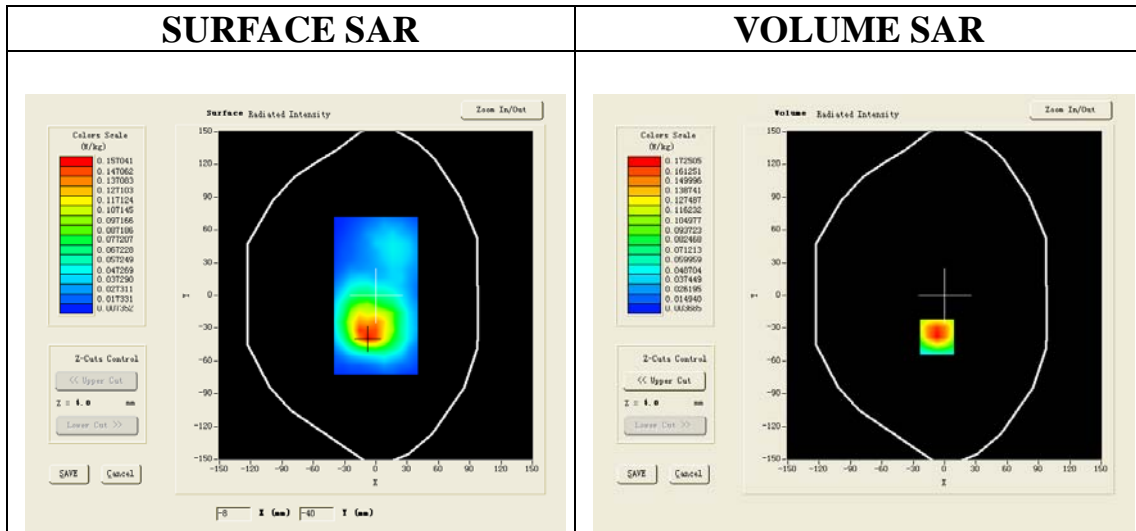

Maximum location: X=-7.00, Y=-38.00

SAR 10g (W/Kg)	0.087108
SAR 1g (W/Kg)	0.166194

Z (mm)	0.00	4.00	9.00	14.00	19.00
SAR (W/Kg)	0.0000	0.1725	0.0864	0.0452	0.0275

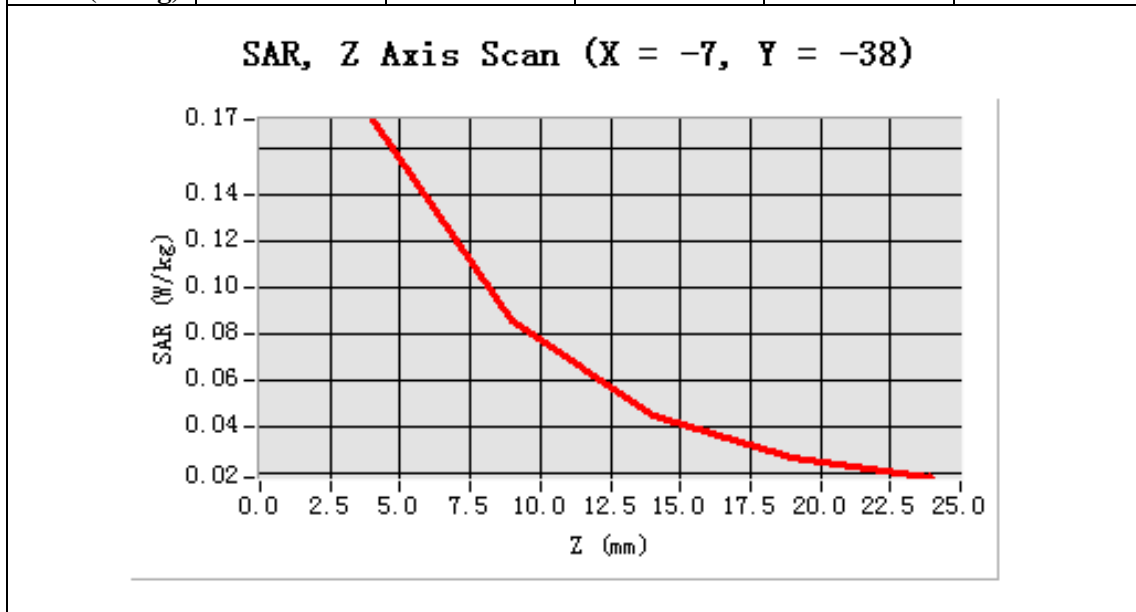

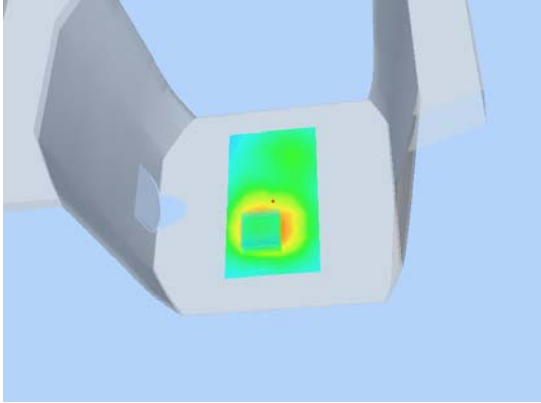
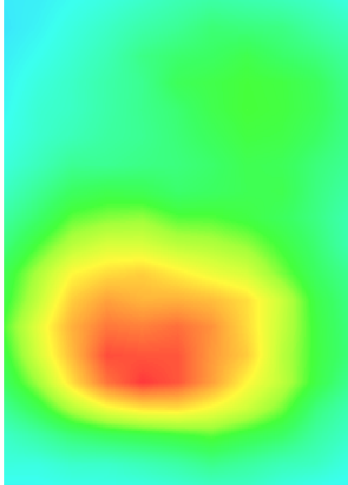
3D screen shot	Hot spot position
 A 3D perspective view of a grey, rectangular device. A small, square, multi-colored hot spot is visible on the front face of the device, centered around a small red dot. The hot spot colors transition from red at the center to yellow, green, and cyan towards the edges.	 A close-up, 2D view of the hot spot. It shows a circular area with a red center, transitioning through yellow and green to a cyan outer edge. The background is a uniform cyan color.

Test Laboratory: AGC Lab
GPRS 1900 Mid-Body- worn-Front (3up) <SIM1>
DUT:TINGLE; Type:S107

Date:APR.14,2012

Communication System: GPRS-3 Slot; Communication System Band: PCS1900;Duty Cycle: 1:2.7; convF=6.42
Frequency: 1880 MHz; Medium parameters used: $f = 1900$ MHz; $\sigma = 1.49$ mho/m; $\epsilon_r = 53.27$; $\rho = 1000$ kg/m³ ;
Phantom section: Flat Section
Ambient temperature (°C):21, Liquid temperature (°C):21

Satimo Configuration:

Probe:SSE5; Calibrated: 12/09/2011

- Sensor-Surface: 4mm (Mechanical Surface Detection)
- Phantom: SAM1; Type: SAM
- Measurement SW: OpenSAR V4_02_01

Configuration/GPRS1900 Mid Body-Front/Area Scan: Measurement grid: dx=20mm, dy=20mm

Configuration/GPRS1900 Mid Body-Front/Zoom Scan: Measurement grid: dx=8mm,
dy=8mm, dz=5m;

Area Scan	surf_sam_plan.txt
ZoomScan	5x5x7,dx=8mm dy=8mm dz=5mm,Very fast
Phantom	Validation plane
Device Position	Body Front
Band	GSM1900
Channels	Middle
Signal	TDMA (Crest factor: 2.7)

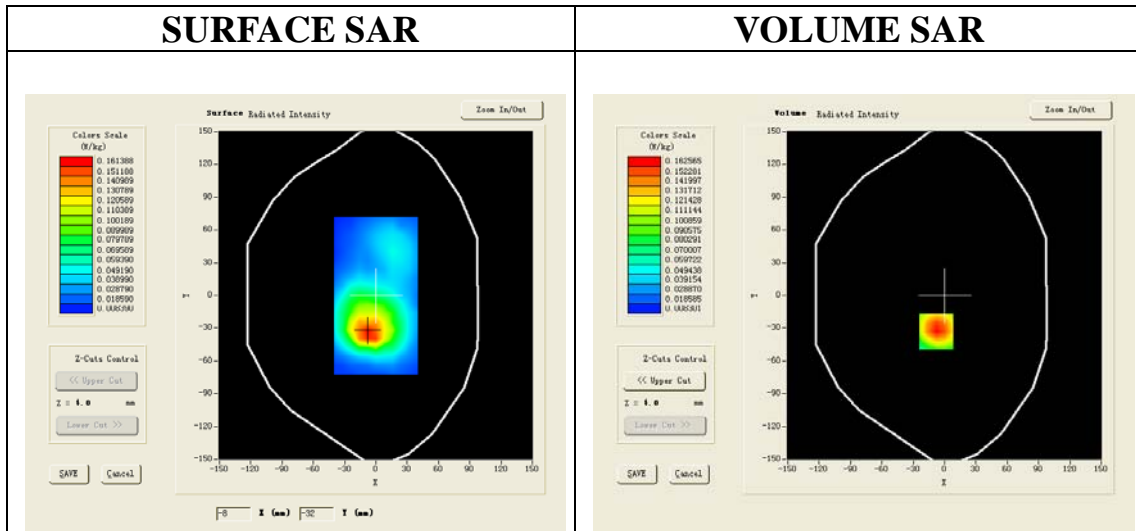

Maximum location: X=-8.00, Y=-33.00

SAR 10g (W/Kg)	0.089371
SAR 1g (W/Kg)	0.154780

Z (mm)	0.00	4.00	9.00	14.00	19.00
SAR (W/Kg)	0.0000	0.1626	0.0946	0.0561	0.0352

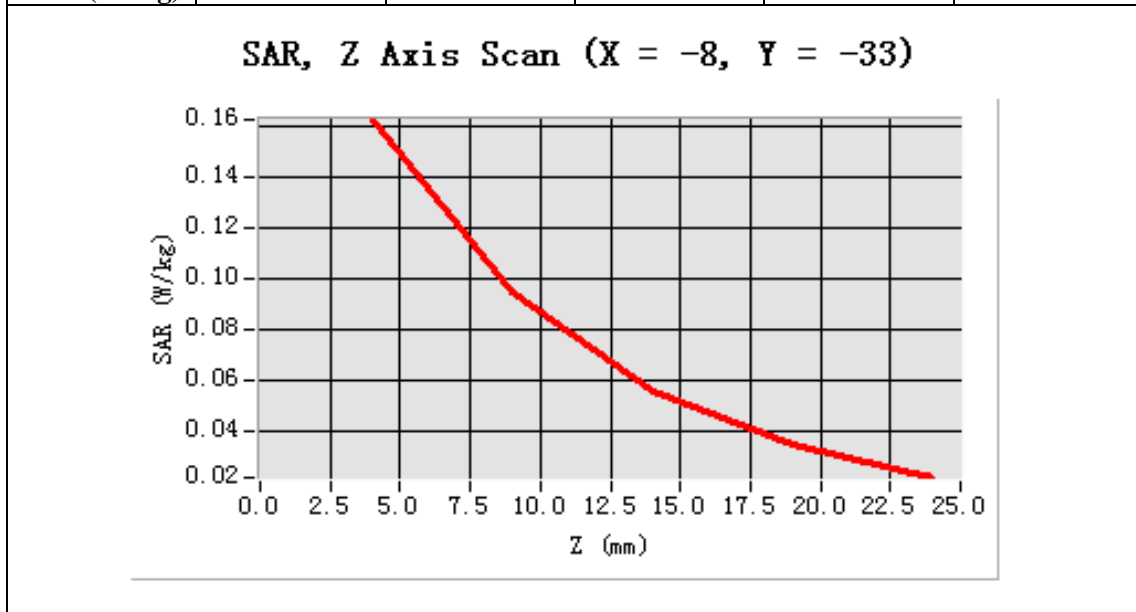

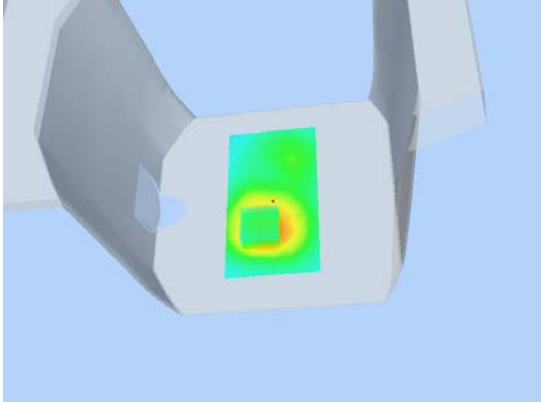
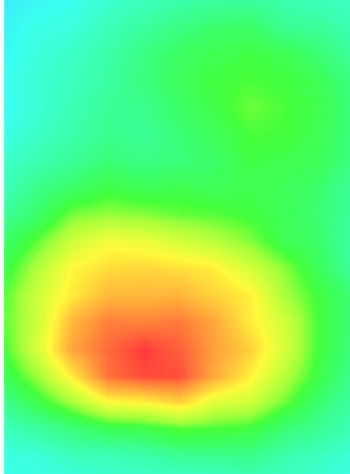
3D screen shot	Hot spot position
 A 3D perspective view of a grey, rectangular device. A small, square, multi-colored hot spot is visible on the front face of the device, centered around a small red dot. The hot spot colors transition from red at the center to yellow, then green, and finally cyan at the edges. The background is a light blue gradient.	 A close-up, 2D view of the hot spot. It shows a circular, multi-colored area with a red center, transitioning through yellow and green to a cyan outer edge. The background is a uniform cyan color.

#

Test Laboratory: AGC Lab
GPRS 1900 Mid-Body- worn-Front (4up) <SIM1>
DUT:TINGLE; Type:S107

Date:APR.14,2012

Communication System: GPRS-4 Slot; Communication System Band: PCS1900;Duty Cycle: 1:2; convF=6.42
Frequency: 1880 MHz; Medium parameters used: $f = 1900$ MHz; $\sigma = 1.49$ mho/m; $\epsilon_r = 53.27$; $\rho = 1000$ kg/m³ ;
Phantom section: Flat Section
Ambient temperature (°C):21, Liquid temperature (°C):21

Satimo Configuration:

Probe:SSE5; Calibrated: 12/09/2011

- Sensor-Surface: 4mm (Mechanical Surface Detection)
- Phantom: SAM1; Type: SAM
- Measurement SW: OpenSAR V4_02_01

Configuration/GPRS1900 Mid Body-Front/Area Scan: Measurement grid: dx=20mm, dy=20mm

Configuration/GPRS1900 Mid Body-Front/Zoom Scan: Measurement grid: dx=8mm,
dy=8mm, dz=5m;

Area Scan	surf_sam_plan.txt
ZoomScan	5x5x7,dx=8mm dy=8mm dz=5mm,Very fast
Phantom	Validation plane
Device Position	Body Front
Band	GSM1900
Channels	Middle
Signal	TDMA (Crest factor: 2.0)

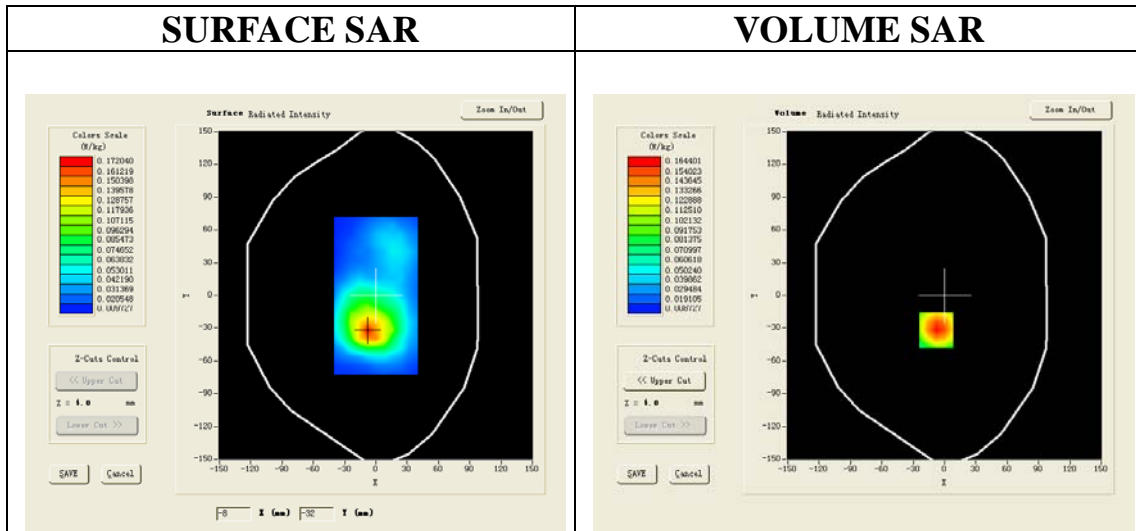

Maximum location: X=-8.00, Y=-32.00

SAR 10g (W/Kg)	0.089828
SAR 1g (W/Kg)	0.156019

Z (mm)	0.00	4.00	9.00	14.00	19.00
SAR (W/Kg)	0.0000	0.1644	0.0938	0.0552	0.0350

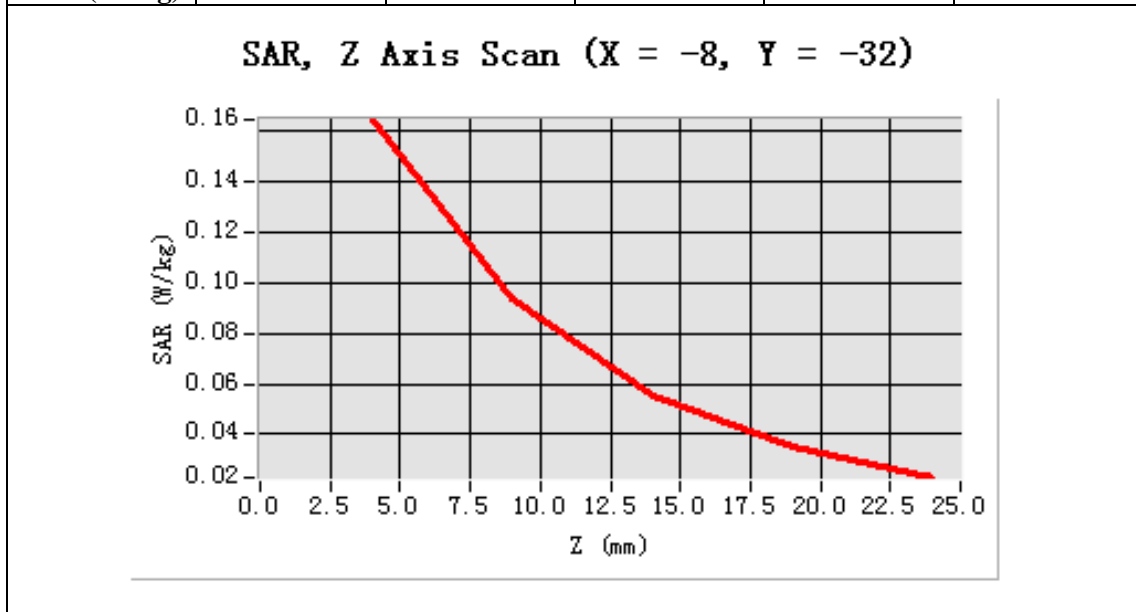

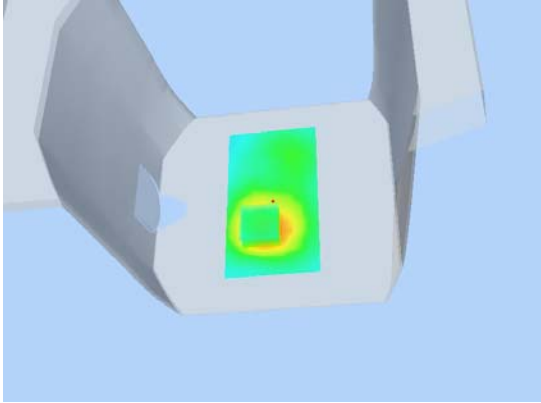
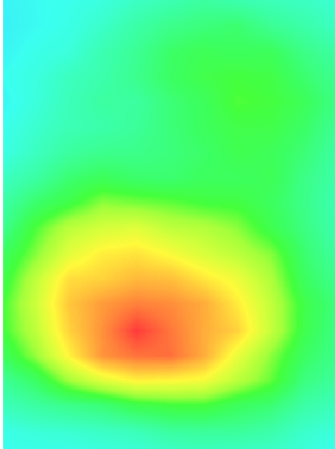
3D screen shot	Hot spot position
 A 3D perspective view of a grey, rectangular device. A small, circular hot spot is visible on the front face of the device, indicated by a color gradient from green to red. The device is set against a light blue background.	 A close-up, vertical view of the hot spot. It shows a circular area with a color gradient from green at the edges to red in the center, indicating the intensity of the hot spot. The background is a uniform light blue.