



# **FCC 47 CFR PART 15 SUBPART C**

# **TEST REPORT**

*For*

**Applicant: CLC Hong Kong Limited**

**Address: 907 Hart Avenue Plaza, 5-9A Hart Avenue, Tsim Sha Tsui,  
Kowloon, Hong Kong**

**Product Name: GSM mobile phone**

**Model Name: P300**

**Brand Name: Plum**

**FCC ID: Y7WPLUMP300**

**Report No.: STS111126F2**

**Date of Issue: December. 19, 2011**

**Issued by: Shenzhen Super Test Service Technology Co., Ltd.**

**Address: No.5, 2nd Langshan Road, North District, Hi-tech Industrial Park,  
Nanshan, Shenzhen, Guangdong, China**

**Tel: 86-755-2795 8522**

**Fax: 86-755-2795 8022**

*The report consists 40 pages in total. It may be duplicated completely for legal use with the approval of the applicant. It should not be reproduced except in full, without the written approval of our laboratory. The client should not use it to claim product endorsement by STS. The test results in the report only apply to the tested sample. The test report shall be invalid without all the signatures of testing engineers, reviewer and approver.*

**TABLE OF CONTENTS**

**1. VERIFICATION OF CONFORMITY ..... 3**

**2. GENERAL INFORMATION..... 4**

2.1 Product Information ..... 4

2.2 OBJECTIVE ..... 5

2.3 TEST STANDARDS AND RESULTS ..... 5

2.4 ENVIRONMENTAL CONDITIONS ..... 5

**3. TEST FACILITY ..... 6**

3.1 TEST FACILITY ..... 6

3.2 GENERAL TEST PROCEDURES ..... 6

3.3 FCC PART 15.205 RESTRICTED BANDS OF OPERATIONS ..... 7

**4. SETUP OF EQUIPMENT UNDER TEST ..... 8**

4.1 SUPPORT EQUIPMENT ..... 8

4.2 TEST EQUIPMENT LIST ..... 9

**5. 47 CFR Part 15C 15.249 Requirements..... 10**

5.1 SPURIOUS EMISSION TEST ..... 10

5.1.1 REQUIREMENT ..... 10

5.1.2 TEST DESCRIPTION ..... 11

5.1.3 TEST DESCRIPTION ..... 12

5.1.4 TEST RESULT ..... 13

5.2 BAND EDGE ..... 19

5.2.1 REQUIREMENT ..... 19

5.2.2 TEST DESCRIPTION ..... 19

5.2.3 TEST RESULT ..... 19

5.3 LINE CONDUCTED EMISSION TEST ..... 22

5.3.1. LIMITS OF LINE CONDUCTED EMISSION TEST ..... 22

5.3.2. BLOCK DIAGRAM OF TEST SETUP ..... 22

5.3.3. PRELIMINARY PROCEDURE OF LINE CONDUCTED EMISSION TEST ..... 23

5.3.4. FINAL PROCEDURE OF LINE CONDUCTED EMISSION TEST ..... 23

5.3.5. TEST RESULT OF LINE CONDUCTED EMISSION TEST ..... 24

**APPENDIX 1 ..... 26**

**PHOTOGRAPHS OF TEST SETUP ..... 26**

**APPENDIX 2 ..... 29**

**PHOTOGRAPHS OF EUT ..... 29**

1. VERIFICATION OF CONFORMITY

**Equipment Under Test:** GSM mobile phone  
**Brand Name:** Plum  
**Model Number:** P300  
**FCC ID:** Y7WPLUMP300  
**Applicant:** CLC Hong Kong Limited  
 907 Hart Avenue Plaza, 5-9A Hart Avenue,  
 Tsim Sha Tsui, Kowloon, Hong Kong  
**Manufacturer:** CLC China Limited  
 4 Floor, C Building, Fuxinlin Industrial Park, Hangcheng Industrial Area,  
 Baoan District, Shenzhen, China  
**Technical Standards:** 47 CFR Part 15 Subpart C  
**File Number:** STS111126F2  
**Date of test:** November. 24,2011 ~ December.15, 2011  
**Deviation:** None  
**Condition of Test Sample:** Normal  
**Test Result:** PASS

The above equipment was tested by STS for compliance with the requirements set forth in FCC rules and the Technical Standards mentioned above. This said equipment in the configuration described in this report shows the maximum emission levels emanating from equipment and the level of the immunity endurance of the equipment are within the compliance requirements.

The test results of this report relate only to the tested sample identified in this report.

Tested by (+ signature): Zhang Ling  
 Zhang Ling      December. 19, 2011

Review by (+ signature): July Wen  
 July Wen      December. 19, 2011

Approved by (+ signature): Terry Yang  
 Terry Yang      December. 19, 2011

**2. GENERAL INFORMATION**

**2.1 Product Information**

<b>Product</b>	GSM mobile phone
<b>Trade Name</b>	Plum
<b>Model Number</b>	P300
<b>Series Number:</b>	N/A
<b>Description of Differences:</b>	N/A
<b>Power Supply</b>	DC 5V by AC/DC adapter 100-240V~50/60Hz DC 3.7V by battery
<b>Frequency Range</b>	2402MHz -2480MHz
<b>Modulation Type</b>	FHSS
<b>Antenna Type:</b>	Internal Fixed
<b>Channel Spacing:</b>	1MHz
<b>Channel Number</b>	79(CH Low: 2402MHz, CH Mid: 2441MHz, CH High: 2480MHz)
<b>Temperature Range</b>	-20°C ~ 50°C

**NOTE:**

1. Please refer to Appendix I for the photographs of the EUT. For a more detailed features description about the EUT, please refer to User’s Manual.

## 2.2 OBJECTIVE

The objective of the report is to perform tests according to 47 CFR Part 15 Subpart C for the EUT FCC ID Certification:

No.	Identity	Document Title
1	47 CFR Part 15 (10-1-05 Edition)	Radio Frequency Devices

## 2.3 TEST STANDARDS AND RESULTS

Test items and the results are as bellow:

No.	Section	Description	Result	Date of Test
1	15.249(a)	Spurious Emission	PASS	November. 29, 2011
2	15.249(a)	Band Edge	PASS	December. 15, 2011
3	15.207	Power Line Conducted Emission Test	PASS	December. 01, 2011

Note: 1. The test result judgment is decided by the limit of measurement standard  
 2. The information of measurement uncertainty is available upon the customer's request.

## 2.4 ENVIRONMENTAL CONDITIONS

During the measurement the environmental conditions were within the listed ranges:

- Temperature: 15-35°C
- Humidity: 30-60 %
- Atmospheric pressure: 86-106 kPa

### 3. TEST FACILITY

#### 3.1 TEST FACILITY

Test Site:	Most Technology Service Co.,Ltd
Location:	No.5, Langshan 2nd Rd., North Hi-Tech Industrial park, Nanshan, Shenzhen, Guangdong ,China
Description:	<p>There is one 3m semi-anechoic an area test sites and two line conducted labs for final test. The Open Area Test Sites and the Line Conducted labs are constructed and calibrated to meet the FCC requirements in documents ANSI C63.4:2009 and CISPR 16 requirements.</p> <p>The FCC Registration Number is <b>490827</b>.</p> <p>The <b>IC</b> Registration Number is <b>46405-7103</b>.</p> <p>The <b>CNAS</b> Registration Number is <b>CNAS L3573</b>.</p>
Site Filing:	The site description is on file with the Federal Communications Commission, 7435 Oakland Mills Road, Columbia, MD 21046.
Instrument Tolerance:	All measuring equipment is in accord with ANSI C63.4:2009 and CISPR 16 requirements that meet industry regulatory agency and accreditation agency requirement.
Ground Plane:	Two conductive reference ground planes were used during the Line Conducted Emission, one in vertical and the other in horizontal. The dimensions of these ground planes are as below. The vertical ground plane was placed distancing 40 cm to the rear of the wooden test table on where the EUT and the support equipment were placed during test. The horizontal ground plane projected 50 cm beyond the footprint of the EUT system and distanced 80 cm to the wooden test table. For Radiated Emission Test, one horizontal conductive ground plane extended at least 1m beyond the periphery of the EUT and the largest measuring antenna, and covered the entire area between the EUT and the antenna.

#### 3.2 GENERAL TEST PROCEDURES

##### EUT Function and Test Mode

The EUT has been tested under normal operating (TX) and standby (RX) condition.

The field strength of radiation emission was measured in the following position: EUT stand-up position (Y axis), lie-down position (X, Z axis).

The following data show only with the worst case setup.

The worst case of Y axis was reported.

Based on client request, all normal using modes of the normal function were tested but only the worst test data of the worst mode is reported by this report.

##### Conducted Emissions

The EUT is placed on the turntable, which is 0.8 m above ground plane. According to the requirements in Section 13.1.4.1 of ANSI C63.4:2009,Conducted emissions from the EUT measured in the frequency range between 0.15 MHz and 30MHz using CISPR Quasi-peak and average detector modes.

Radiated Emissions

The EUT is placed on a turn table, which is 0.8 m above ground plane. The turntable shall rotate 360 degrees to determine the position of maximum emission level. EUT is set 3m away from the receiving antenna, which varied from 1m to 4m to find out the highest emission. And also, each emission was to be maximized by changing the polarization of receiving antenna both horizontal and vertical. In order to find out the maximum emissions, exploratory radiated emission measurements were made according to the requirements in Section 13.1.4.1 of ANSI C63.4:2009.

**3.3 FCC PART 15.205 RESTRICTED BANDS OF OPERATIONS**

(a) Except as shown in paragraph (d) of this section, only spurious emissions are permitted in any of the frequency bands listed below:

MHz	MHz	MHz	GHz
0.090 - 0.110	16.42 - 16.423	399.9 - 410	4.5 - 5.15
<sup>1</sup> 0.495 - 0.505	16.69475 - 16.69525	608 - 614	5.35 - 5.46
2.1735 - 2.1905	16.80425 - 16.80475	960 - 1240	7.25 - 7.75
4.125 - 4.128	25.5 - 25.67	1300 - 1427	8.025 - 8.5
4.17725 - 4.17775	37.5 - 38.25	1435 - 1626.5	9.0 - 9.2
4.20725 - 4.20775	73 - 74.6	1645.5 - 1646.5	9.3 - 9.5
6.215 - 6.218	74.8 - 75.2	1660 - 1710	10.6 - 12.7
6.26775 - 6.26825	108 - 121.94	1718.8 - 1722.2	13.25 - 13.4
6.31175 - 6.31225	123 - 138	2200 - 2300	14.47 - 14.5
8.291 - 8.294	149.9 - 150.05	2310 - 2390	15.35 - 16.2
8.362 - 8.366	156.52475 - 156.52525	2483.5 - 2500	17.7 - 21.4
8.37625 - 8.38675	156.7 - 156.9	2655 - 2900	22.01 - 23.12
8.41425 - 8.41475	162.0125 - 167.17	3260 - 3267	23.6 - 24.0
12.29 - 12.293	167.72 - 173.2	3332 - 3339	31.2 - 31.8
12.51975 - 12.52025	240 - 285	3345.8 - 3358	36.43 - 36.5
12.57675 - 12.57725	322 - 335.4	3600 - 4400	( <sup>2</sup> )
13.36 - 13.41			

<sup>1</sup> Until February 1, 1999, this restricted band shall be 0.490-0.510 MHz.

<sup>2</sup> Above 38.6

(b) Except as provided in paragraphs (d) and (e), the field strength of emissions appearing within these frequency bands shall not exceed the limits shown in Section 15.209. At frequencies equal to or less than 1000 MHz, compliance with the limits in Section 15.209 shall be demonstrated using measurement instrumentation employing a CISPR quasi-peak detector. Above 1000 MHz, compliance with the emission limits in Section 15.209 shall be demonstrated based on the average value of the measured emissions. The provisions in Section 15.35 apply to these measurements.

#### 4. SETUP OF EQUIPMENT UNDER TEST

##### 4.1 SUPPORT EQUIPMENT

Device Type	Brand	Model	Series No.	Data Cable	Power Cord
N/A	N/A	N/A	N/A	N/A	N/A

*Remark:*

*All the equipment/cables were placed in the worst-case configuration to maximize the emission during the test. Grounding was established in accordance with the manufacturer's requirements and conditions for the intended use.*



## 4.2 TEST EQUIPMENT LIST

**Instrumentation:** The following list contains equipment used at Most for testing. The equipment conforms to the CISPR 16-1 / ANSI C63.2 Specifications for Electromagnetic Interference and Field Strength Instrumentation from 10 kHz to 1.0 GHz or above.

No.	Equipment	Manufacturer	Model No.	S/N	Calculator due date
1	Test Receiver	Rohde & Schwarz	ESCI	100492	2012/03/14
2	L.I.S.N.	Rohde & Schwarz	ENV216	100093	2012/03/14
3	Coaxial Switch	Anritsu Corp	MP59B	6200283933	2012/03/14
4	Terminator	Hubersuhner	50Ω	No.1	2012/03/14
5	RF Cable	SchwarzBeck	N/A	No.1	2012/03/14
6	Test Receiver	Rohde & Schwarz	ESPI	101202	2012/03/14
7	Bilog Antenna	SCHWARZBECK	BBHA9120D	D69250	2012/03/14
8	Cable	Resenberger	N/A	NO.1	2012/03/14
9	Cable	SchwarzBeck	N/A	NO.2	2012/03/14
10	Cable	SchwarzBeck	N/A	NO.3	2012/03/14
11	DC Power Filter	DuoJi	DL2×30B	N/A	2012/03/14
12	Single Phase Power Line Filter	DuoJi	FNF 202B30	N/A	2012/03/14
13	3 Phase Power Line Filter	DuoJi	FNF 402B30	N/A	2012/03/14
14	Test Receiver	Rohde & Schwarz	ESCI	100492	2012/03/14
15	Absorbing Clamp	Luthi	MDS21	3635	2012/03/14
16	Coaxial Switch	Anritsu Corp	MP59B	6200283933	2012/03/14
17	AC Power Source	Kikusui	AC40MA	LM003232	2012/03/14
18	Test Analyzer	Kikusui	KHA1000	LM003720	2012/03/14
19	Line Impedence Network	Kikusui	LIN40MA-PCR-L	LM002352	2012/03/14
20	ESD Tester	Kikusui	KES4021	LM003537	2012/03/14
21	EMCPRO System	EM Test	UCS-500-M4	V0648102026	2012/03/14
22	Signal Generator	IFR	2032	203002/100	2012/03/14
23	Amplifier	A&R	150W1000	301584	2012/03/14
24	CDN	FCC	FCC-801-M2-25	47	2012/03/14
25	CDN	FCC	FCC-801-M3-25	107	2012/03/14
26	EM Injection Clamp	FCC	F-203I-23mm	403	2012/03/14
27	RF Cable	MIYAZAKI	N/A	No.1/No.2	2012/03/14
28	Universal Radio Communication Tester	ROHDE&SCHWARZ	CMU200	0304789	2012/03/14
29	Telecommunication Antenna	European Antennas	PSA 75301R/170	0304213	2012/03/14
30	Telecommunication Test Equipment	R&S	CMU200	N/A	2012/03/14
31	Loop Antenna	SCHWARZBECK	BBHA9120D	D69250	2012/03/14

**NOTE:** Equipments listed above have been calibrated and are in the period of validation.

## 5. 47 CFR Part 15C 15.249 Requirements

### 5.1 SPURIOUS EMISSION TEST

#### 5.1.1 REQUIREMENT

According to FCC section 15.249(a):

Except as provided in paragraph (a) of this section, the field strength of emissions from intentional radiators operated within these frequency bands shall comply with the following:

Fundamental Frequency (MHz)	Field Strength of Fundamental (mV/m)	Field Strength of Harmonics (µV/m)
902-928	50	500
2400-2483.5	50	500
5725-5875	50	500
24000-24250	250	2500

According to FCC section 15.209 (a), except as provided elsewhere in this subpart, the emissions from an intentional radiator shall not exceed the field strength levels specified in the following table:

Frequency (MHz)	Field Strength (µV/m)	Measurement Distance (m)
1.705 - 30.0	30	30
30 - 88	100	3
88 - 216	150	3
216 - 960	200	3
Above 960	500	3

**Remark:** Except as provided in paragraph (g), fundamental emissions from intentional radiators operating under this Section shall not be located in the frequency bands 54-72 MHz, 76-88 MHz, 174-216 MHz or 470-806 MHz. However, operation within these frequency bands is permitted under other sections of this Part, e.g., Sections 15.231 and 15.241.

In the above emission table, the tighter limit applies at the band edges.

Frequency (MHz)	Field Strength (µV/m)	Measurement Distance (m)
30 - 88	100	3
88 - 216	150	3
216 - 960	200	3
Above 960	500	3

### 5.1.2 TEST DESCRIPTION

#### TEST SETUP:

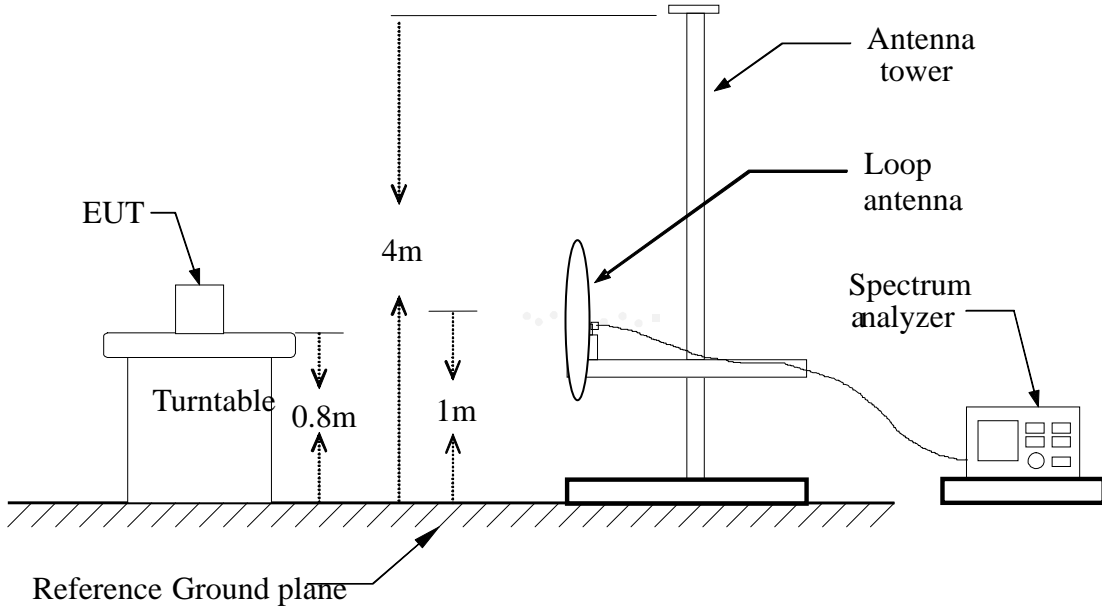

#### Blow 1GHz:

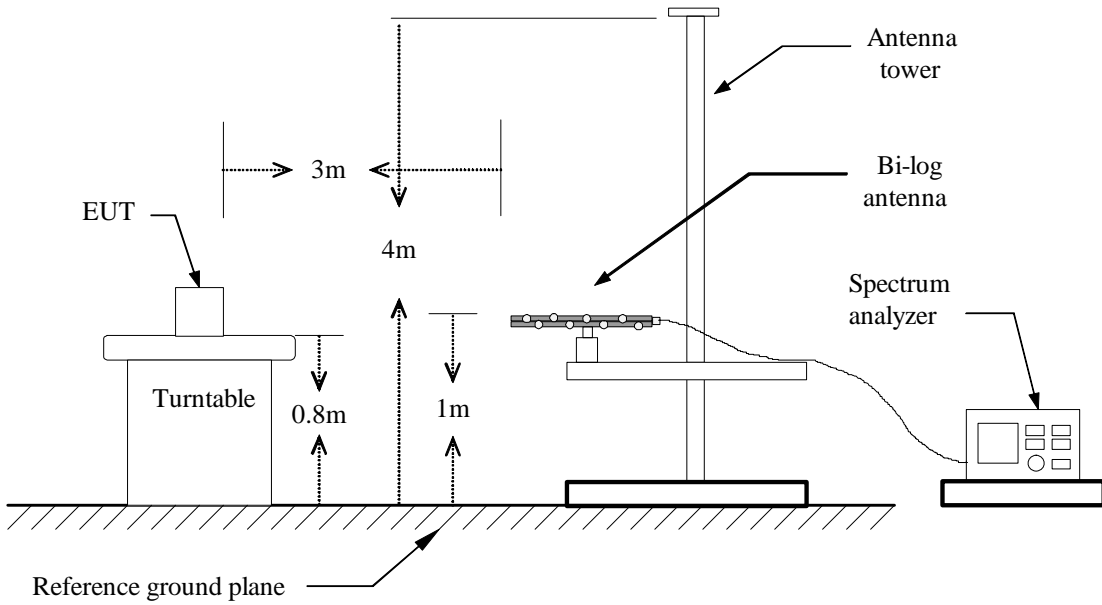

**Above 1GHz:**

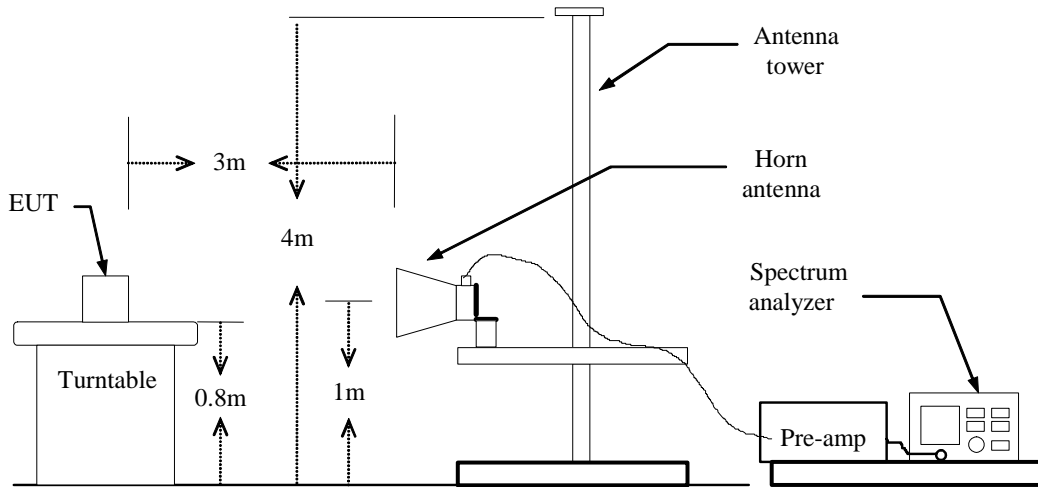

**5.1.3 TEST DESCRIPTION**

1. The EUT is placed on a turntable, which is 0.8m above ground plane.
2. The turntable shall be rotated for 360 degrees to determine the position of maximum emission level.
3. EUT is set 3m away from the receiving antenna, which is varied from 1m to 4m to find out the highest emissions.
4. Maximum procedure was performed on the six highest emissions to ensure EUT compliance.
5. And also, each emission was to be maximized by changing the polarization of receiving antenna both horizontal and vertical.
6. Set the spectrum analyzer in the following setting as:  
 Below 1GHz: RBW=100 kHz / VBW=300 kHz / Sweep=AUTO  
 Above 1GHz : ( a) PEAK: RBW=VBW=1MHz / Sweep=AUTO  
               (b) AVERAGE: RBW=1MHz / VBW=10Hz / Sweep=AUTO
7. Repeat above procedures until the measurements for all frequencies are complete.

Preliminary Radiated Emission Test			
Frequency Range Investigated	9KHz to 26 GHz		
Mode of operation	Date	Data#	Worst Mode
Bluetooth Mode	2011-11-29	P300 ( 3, 4)	☒
Camera Mode	2011-11-29	P300 ( 1, 2)	
Call Mode	2011-11-29	P300 ( 7, 8)	
USB Mode	2011-11-29	P300 ( 9, 10)	
WIFI Mode	2011-11-29	P300 ( 5, 6)	

Note: All the test modes were tested, but only the worst test data was listed on the following description.

**5.1.4 TEST RESULT**

Form 9 KHz to 30MHz:

Freq. (MHz)	Ant. Pol H/V	Peak Reading (dBuV)	AV Reading (dBuV)	Ant. / CL CF (dB)	Actual Fs		Peak Limit (dBuV/m)	AV Limit (dBuV/m)	AV Margin (dB)
					Peak (dBuV/m)	AV (dBuV/m)			
N/A	H								>20
N/A	V								>20

**Note: No test data was detected in below 30MHz.**

Form 30 MHz to 1GHz:



Address: No.5, Langshan 2nd Rd., North Hi-Tech Industrial park  
 Guangdong, China  
 Tel: 0755-86170306 Fax: 0755-86170310

Radiated Emission Measurement

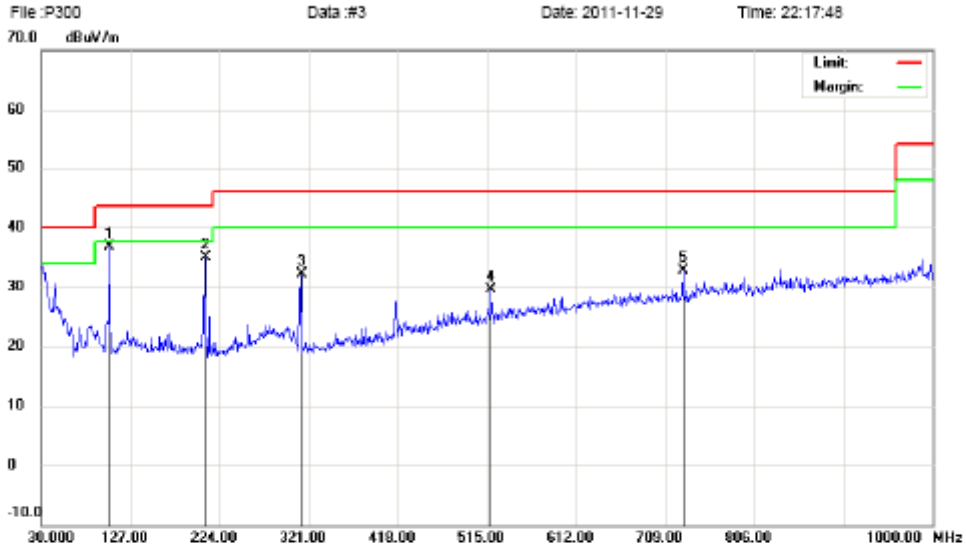

Site: site MOST 3M Polarization: **Vertical** Temperature: 26  
 Limit: FCC Part15 B 3M Radiation Power: AC 120V/60Hz Humidity: 61 %  
 EUT: GSM Mobile phone Distance:  
 M/N: P300  
 Mode: bluetooth  
 Note:

No.	Mk.	Freq. MHz	Reading Level dBuV	Correct Factor dB	Measure- ment dBuV/m	Limit dBuV/m	Over dB	Antenna Height cm	Table Degree degree	Comment
1	*	103.7200	22.35	14.28	36.63	43.50	-6.87	peak		
2		207.5100	18.29	16.53	34.82	43.50	-8.68	peak		
3		312.2700	15.51	16.69	32.20	46.00	-13.80	peak		
4		519.8500	7.63	21.79	29.42	46.00	-16.58	peak		
5		728.4000	7.95	24.85	32.80	46.00	-13.20	peak		

\*:Maximum data x:Over limit !:over margin



Address: No.5, Langshan 2nd Rd., North Hi-Tech Industrial park  
 Guangdong, China  
 Tel: 0755-88170306 Fax: 0755-88170310

**Radiated Emission Measurement**

File :P300 Data :#4 Date: 2011-11-29 Time: 22:19:31

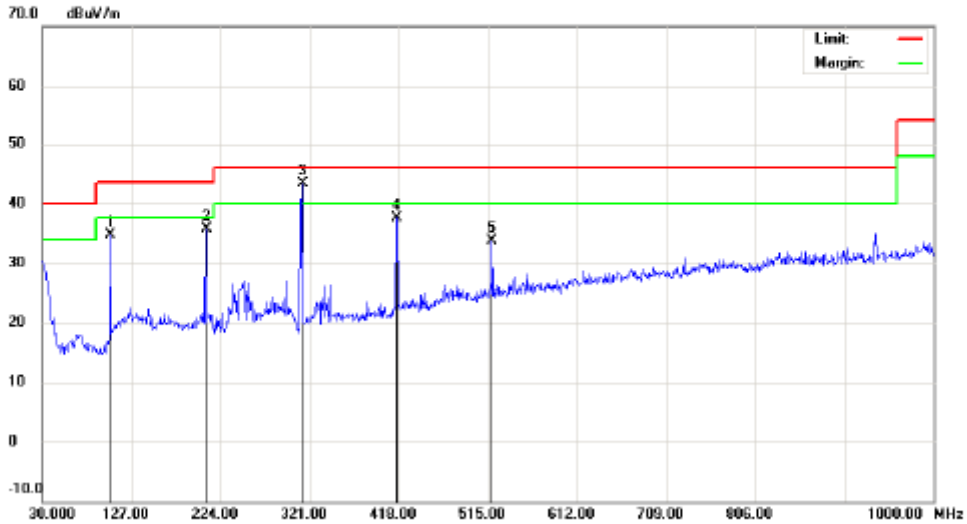

Site site MOST 3M Polarization: *Horizontal* Temperature: 26  
 Limit: FCC Part15 B 3M Radiation Power: AC 120V/50Hz Humidity: 61 %  
 EUT: GSM Mobile phone Distance:  
 M/N: P300  
 Mode: bluetooth  
 Note:

No. Mk.	Freq. MHz	Reading Level dBuV	Correct Factor dB	Measurement dBuV/m	Limit dBuV/m	Over dB	Detector	Antenna Height cm	Table Degree	Comment
1	103.7200	20.49	14.28	34.77	43.50	-8.73	peak			
2	207.5100	19.14	16.53	35.67	43.50	-7.83	peak			
3 *	312.2700	26.53	16.69	43.22	48.00	-2.78	peak			
4	416.0800	17.94	19.57	37.51	48.00	-8.49	peak			
5	519.8500	12.00	21.79	33.79	48.00	-12.21	peak			

\*:Maximum data x:Over limit !:over margin

**Above 1 GHz**

<b>Operation Mode:</b>	CH Low	<b>Test Date:</b>	November. 29, 2011
<b>Temperature:</b>	20°C	<b>Tested by:</b>	Habby Guo
<b>Humidity:</b>	70 % RH	<b>Polarity:</b>	Ver. / Hor.

Freq. (MHz)	Ant. Pol H/V	Peak Reading (dBuV)	AV Reading (dBuV)	Ant. / CL CF (dB)	Actual Fs		Peak Limit (dBuV/m)	AV Limit (dBuV/m)	AV Margin (dB)
					Peak (dBuV/m)	AV (dBuV/m)			
2402.00	H	92.73	63.29	9.15	101.88	72.44	114.00	94.00	-21.56
1612.50	H	54.33	30.59	6.43	60.76	37.02	74.00	54.00	-16.98
4815.00	H	52.89	28.57	17.37	70.26	45.94	74.00	54.00	-8.06
N/A									>20
2402.00	V	94.82	64.75	9.15	103.97	73.90	114.00	94.00	-20.10
1612.50	V	56.64	29.09	6.43	63.07	35.52	74.00	54.00	-18.48
4815.00	V	51.17	26.72	17.37	68.54	44.09	74.00	54.00	-9.91
N/A									>20

**Notes:**

1. Measuring frequencies from 1 GHz to the 10th harmonic of highest fundamental frequency.
2. Measurements above show only up to 6 maximum emissions noted, or would be lesser if no specific emissions from the EUT are recorded (ie: margin>20dB from the applicable limit) and considered that's already beyond the background noise floor.
3. Radiated emissions measured in frequency above 1000MHz were made with an instrument using Peak detector mode and average detector mode of the emission shown in Actual FS column.
4. Spectrum setting:
  - a. Peak Setting 1GHz - 26GHz, RBW = 1MHz, VBW = 1MHz, Sweep time = auto.
  - b. AV Setting 1GHz - 26GHz, RBW = 1MHz, VBW = 10Hz, Sweep time = auto





**Operation Mode:** CH High  
**Temperature:** 20°C  
**Humidity:** 70 % RH

**Test Date:** November. 29, 2011  
**Tested by:** Habby Guo  
**Polarity:** Ver. / Hor.

Freq. (MHz)	Ant. Pol H/V	Peak Reading (dBuV)	AV Reading (dBuV)	Ant. / CL CF (dB)	Actual Fs		Peak Limit (dBuV/m)	AV Limit (dBuV/m)	AV Margin (dB)
					Peak (dBuV/m)	AV (dBuV/m)			
2480.00	H	92.97	64.52	9.38	102.35	73.90	114.00	94.00	-20.10
1647.50	H	53.72	30.84	6.73	60.45	37.57	74.00	54.00	-16.43
4955.00	H	48.75	28.78	17.57	66.32	46.35	74.00	54.00	-7.65
N/A									>20
2480.00	V	93.85	65.79	9.38	103.23	75.17	114.00	94.00	-18.83
1647.50	V	54.82	29.37	6.73	61.55	36.10	74.00	54.00	-17.90
4955.00	V	49.87	27.89	17.57	67.44	45.46	74.00	54.00	-8.54
N/A									>20

**Notes:**

1. Measuring frequencies from 1 GHz to the 10th harmonic of highest fundamental frequency.
2. Measurements above show only up to 6 maximum emissions noted, or would be lesser if no specific emissions from the EUT are recorded (ie: margin>20dB from the applicable limit) and considered that's already beyond the background noise floor.
3. Radiated emissions measured in frequency above 1000MHz were made with an instrument using Peak detector mode and average detector mode of the emission shown in Actual FS column.
4. Spectrum setting:
  - a. Peak Setting 1GHz - 26GHz, RBW = 1MHz, VBW = 1MHz, Sweep time = *auto*.
  - b. AV Setting 1GH z- 26GHz, RBW = 1MHz, VBW = 10Hz, Sweep time = *auto*.

## 5.2 BAND EDGE

### 5.2.1 REQUIREMENT

According to FCC section 15.249(a), in any 100kHz bandwidth outside the frequency band in which the spread spectrum or digitally modulated intentional radiator is operating, the radio frequency power that is produced by the intentional radiator shall be at least 20dB below that in the 100kHz bandwidth within the band that contains the highest level of the desired power, based on either an RF conducted or a radiated measurement.

### 5.2.2 TEST DESCRIPTION

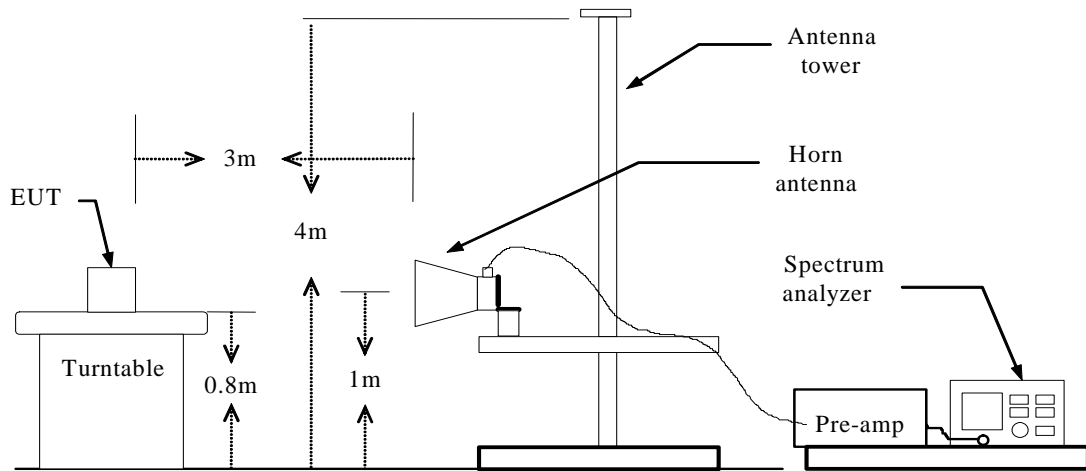

### 5.2.3 TEST RESULT

The EUT operates at hopping-off test mode. The lowest and highest channels are tested to verify the band edge emissions.

Test Mode		Channel Marked Frequency	Limit (dBuV/m)	Test Result Highest Emission (dBuV/m)			
				Vertical		Horizontal	
				Peak	Average	Peak	Average
Bluetooth	Low Channel	2390MHz	74(Peak) 54(Average)	65.46	41.93	66.23	39.22
		2400MHz		73.15	47.70	72.98	45.95
	High Channel	2483.5MHz		67.75	42.96	69.44	41.74
		2500MHz		66.32	38.47	66.04	39.60

Test Plot:

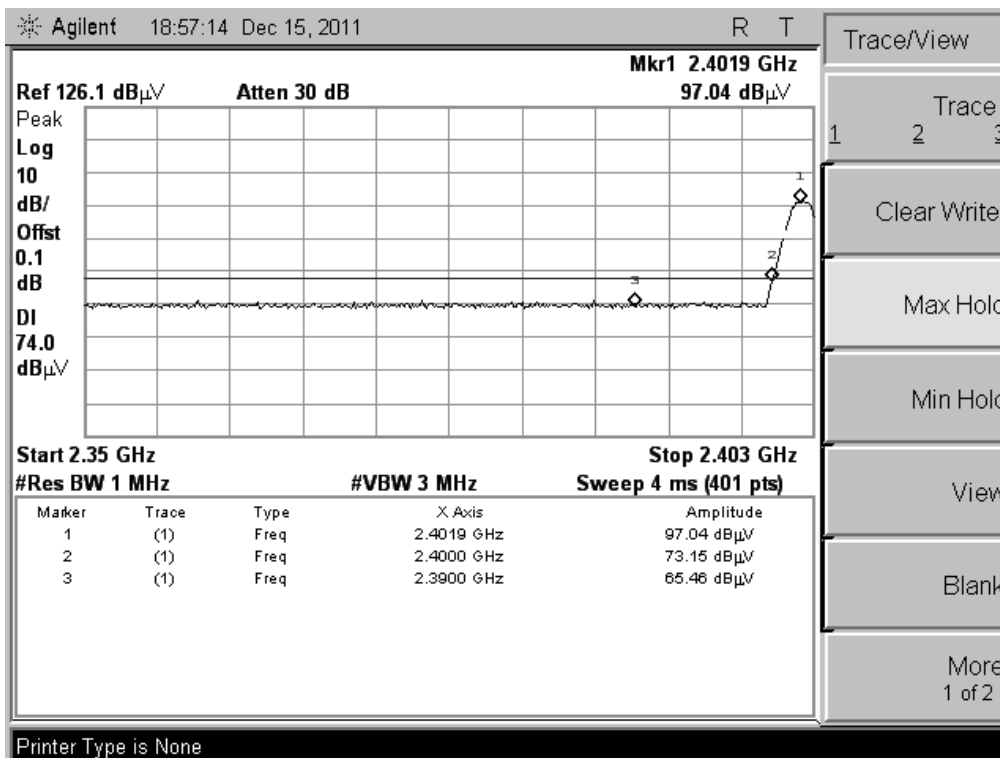

(CH Low, Vertical)

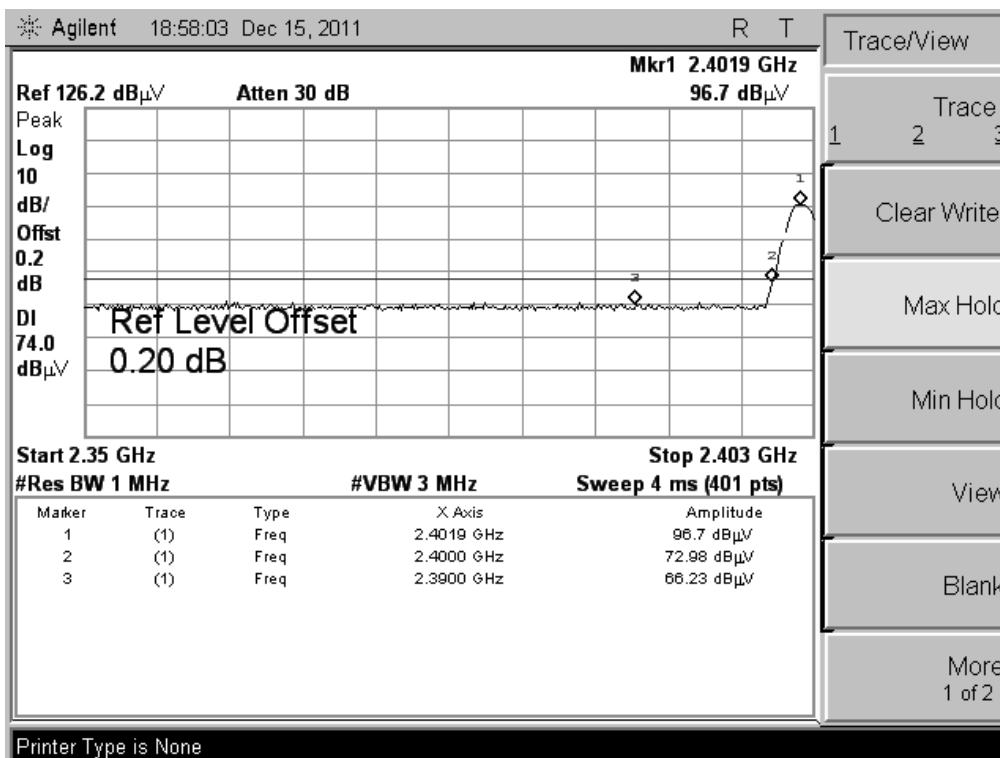

(CH Low, Horizontal)

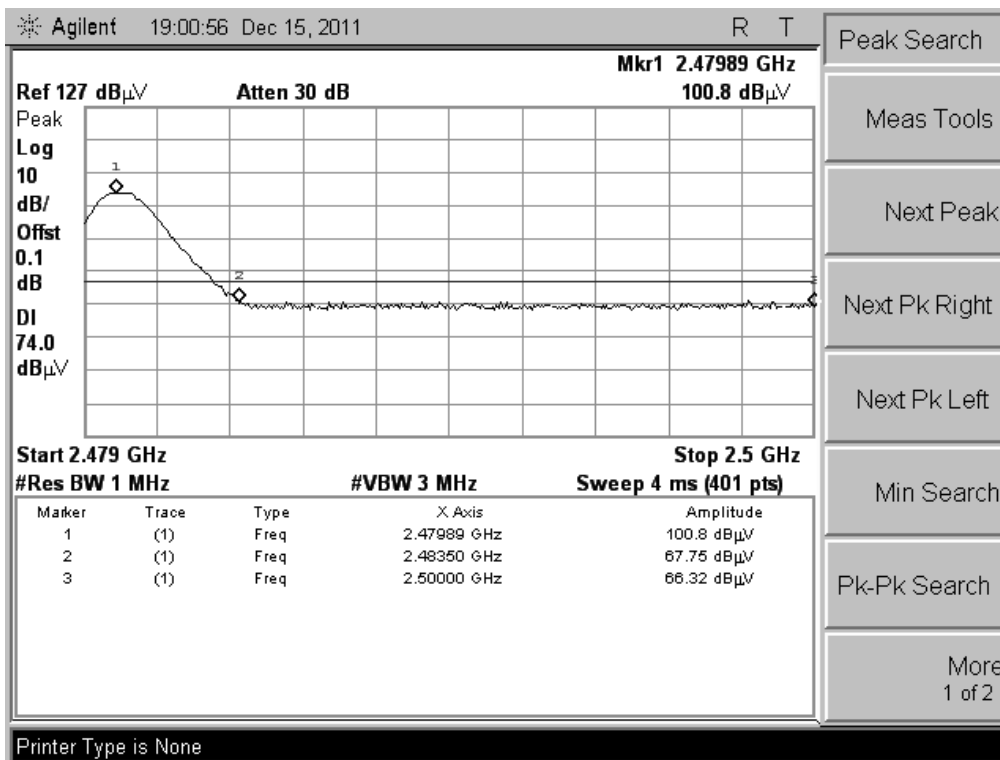

(CH High, Vertical)

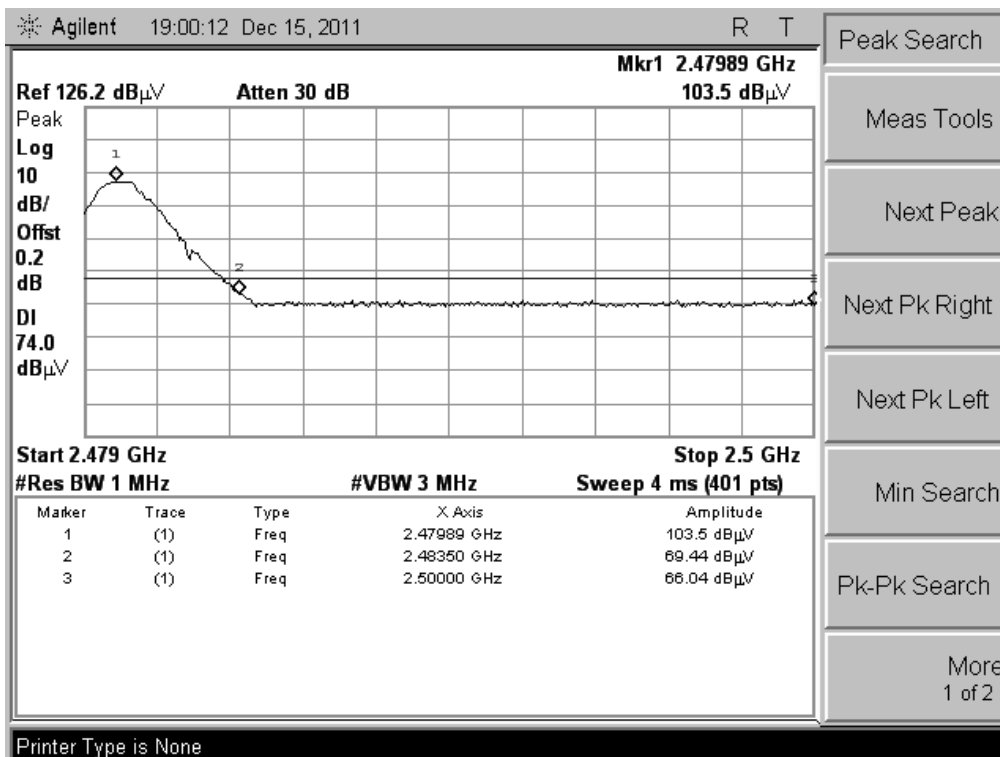

(CH High, Horizontal)

### 5.3 LINE CONDUCTED EMISSION TEST

#### 5.3.1. LIMITS OF LINE CONDUCTED EMISSION TEST

Frequency	Maximum RF Line Voltage	
	Q.P.( dBuV)	Average( dBuV)
150kHz-500kHz	66-56	56-46
500kHz-5MHz	56	46
5MHz-30MHz	60	50

**\*\*Note:** 1. the lower limit shall apply at the transition frequency.

2. The limit decreases linearly with the logarithm of the frequency in the range 0.15 MHz to 0.50 MHz

#### 5.3.2. BLOCK DIAGRAM OF TEST SETUP

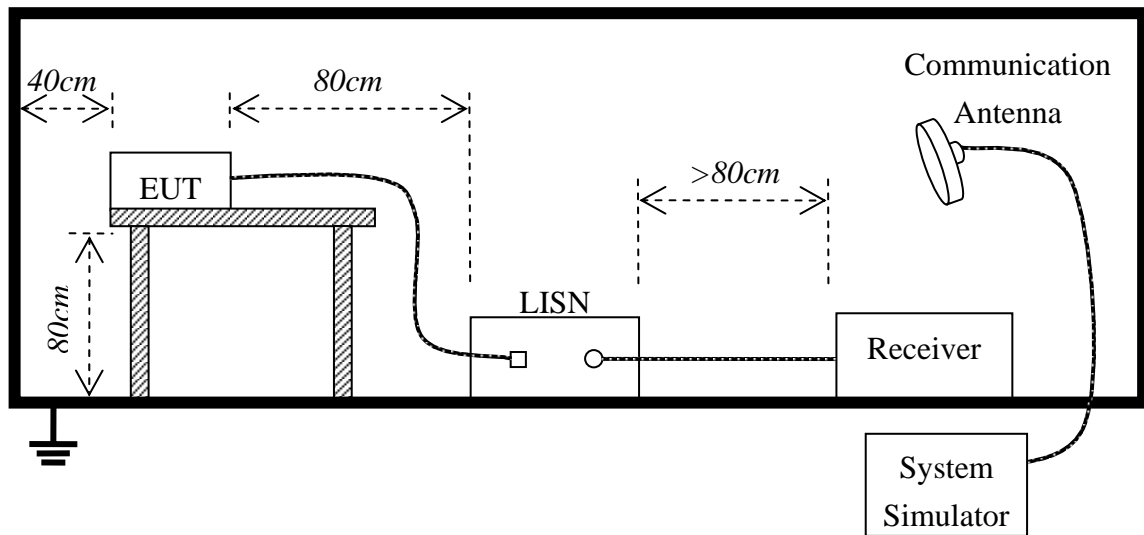

**5.3.3. PRELIMINARY PROCEDURE OF LINE CONDUCTED EMISSION TEST**

- 1) The equipment was set up as per the test configuration to simulate typical actual usage per the user’s manual. When the EUT is a tabletop system, a wooden table with a height of 0.8 meters is used and is placed on the ground plane as per FCC Part 15 (see Test Facility for the dimensions of the ground plane used). When the EUT is floor-standing equipment, it is placed on the ground plane which has a 3-12 mm non-conductive covering to insulate the EUT from the ground plane.
- 2) Support equipment, if needed, was placed as per FCC Part 15.
- 3) All I/O cables were positioned to simulate typical actual usage as per FCC Part 15.
- 4) The EUT received DC 5V power by AC/DC adapter which through a Line Impedance Stabilization Network (LISN) which supplied power source and was grounded to the ground plane.
- 5) All support equipments received power from a second LISN supplying power of AC 120V/60Hz, if any.
- 6) The EUT test program was started. Emissions were measured on each current carrying line of the EUT using a spectrum Analyzer / Receiver connected to the LISN powering the EUT. The LISN has two monitoring points: Line 1 (Hot Side) and Line 2 (Neutral Side). Two scans were taken: one with Line 1 connected to Analyzer / Receiver and Line 2 connected to a 50 ohm load; the second scan had Line 1 connected to a 50 ohm load and Line 2 connected to the Analyzer / Receiver.
- 7) Analyzer / Receiver scanned from 150 kHz to 30 MHz for emissions in each of the test modes.
- 8) During the above scans, the emissions were maximized by cable manipulation.
- 9) The following test mode(s) were scanned during the preliminary test:

PRELIMINARY PROCEDURE OF LINE CONDUCTED EMISSION TEST			
Frequency Range Investigated	9KHz to 26 GHz		
Mode of operation	Date	Data#	Worst Mode
Bluetooth Mode	2011-12-01	P300 ( 5,6)	☒
Camera Mode	2011-12-01	P300 ( 1, 2)	
Call Mode	2011-12-01	P300 ( 7, 8)	
WIFI Mode	2011-12-01	P300 ( 3,4)	
MP3 Mode	2011-12-01	P300 (9,10)	

Then, the EUT configuration and cable configuration of the above highest emission level were recorded for reference of final testing.

**5.3.4. FINAL PROCEDURE OF LINE CONDUCTED EMISSION TEST**

EUT and support equipment was set up on the test bench as per step 9 of the preliminary test.

A scan was taken on both power lines, Line 1 and Line 2, recording at least the six highest emissions. Emission frequency and amplitude were recorded into a computer in which correction factors were used to calculate the emission level and compare reading to the applicable limit. If EUT emission level was less -2dB to the A.V. limit in Peak mode, then the emission signal was re-checked using Q.P and Average detector.

The test data of the worst case condition(s) was reported on the Summary Data page.

### 5.3.5. TEST RESULT OF LINE CONDUCTED EMISSION TEST



Address: No.5, Langshan 2nd Rd., North Hi-Tech Industrial park  
 Guangdong, China  
 Tel: 0755-86170306 Fax: 0755-86170310

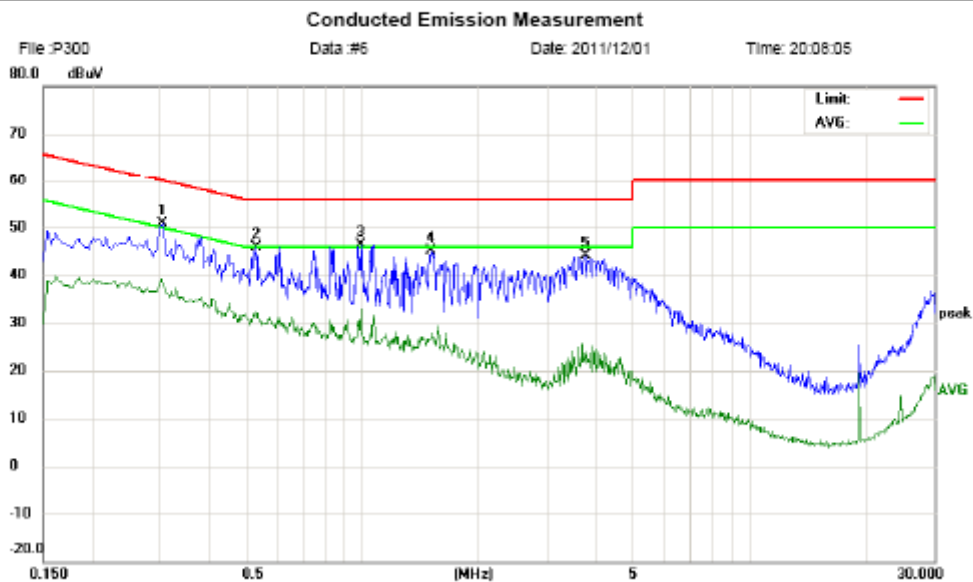

Site: site #1      Phase: **N**      Temperature: 26  
 Limit: FCC Part15 B Class B QP      Power: AC 120V/60Hz      Humidity: 60 %  
 EUT: GSM MOBILE PHONE  
 M/N: P300  
 Mode: BLUETOOTH  
 Note:

No.	Mk.	Freq. MHz	Reading Level dBuV	Correct Factor dB	Measure- ment dBuV	Limit dBuV	Over dB	Detector	Comment
1	*	0.3059	39.52	11.29	50.81	60.08	-9.27	peak	
2		0.5340	35.95	10.00	45.95	56.00	-10.05	peak	
3		0.9939	36.44	10.00	46.44	56.00	-9.56	peak	
4		1.5100	35.68	9.49	45.15	56.00	-10.85	peak	
5		3.7700	33.28	10.77	44.05	56.00	-11.95	peak	

\*:Maximum data    x:Over limit    !:over margin





Address: No.5, Langshan 2nd Rd., North Hi-Tech Industrial park  
 Guangdong, China  
 Tel: 0755-86170306 Fax: 0755-86170310

**Conducted Emission Measurement**

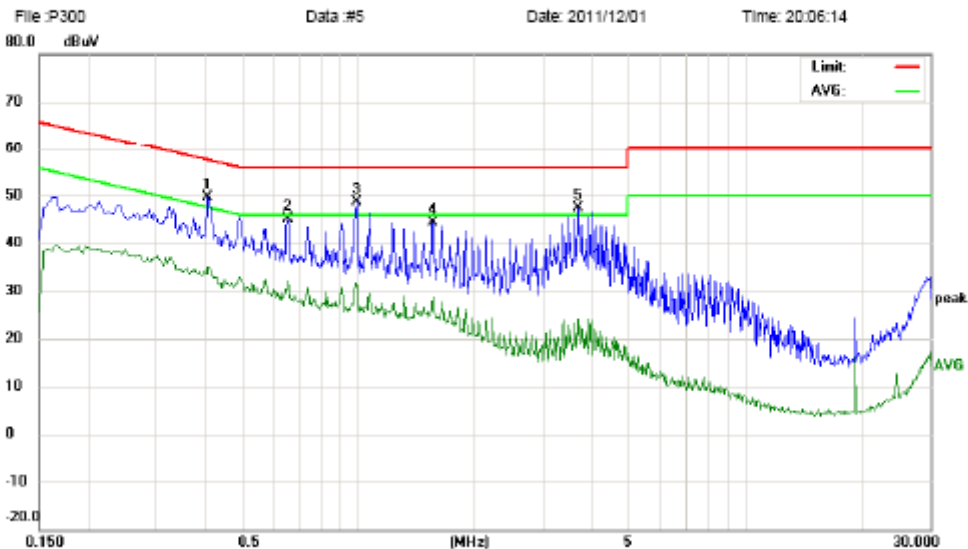

Site site #1 Phase: **L1** Temperature: 26  
 Limit: FCC Part15 B Class B QP Power: AC 120V/60Hz Humidity: 60 %  
 EUT: GSM MOBILE PHONE  
 M/N: P300  
 Mode: BLUETOOTH  
 Note:

No.	Mk.	Freq.	Reading Level	Correct Factor	Measurement	Limit	Over	Detector	Comment
		MHz	dBuV	d5	dBuV	dBuV	dB		
1		0.4100	39.07	10.60	49.67	57.65	-7.98	peak	
2		0.6580	35.21	10.00	45.21	56.00	-10.79	peak	
3	*	0.9900	38.75	10.00	48.75	56.00	-7.25	peak	
4		1.5620	35.00	9.44	44.44	56.00	-11.56	peak	
5		3.7099	36.61	10.71	47.32	56.00	-8.68	peak	

\*:Maximum data x:Over limit !:over margin

**APPENDIX 1**  
**PHOTOGRAPHS OF TEST SETUP**

CE TEST SETUP



RE TEST SETUP

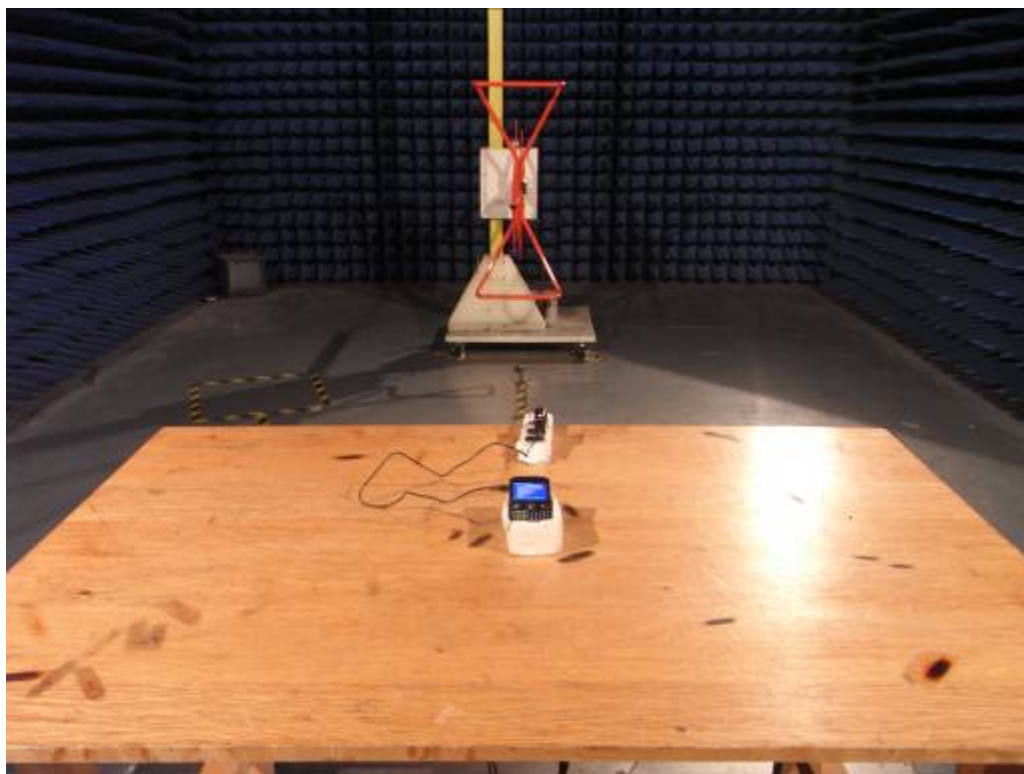

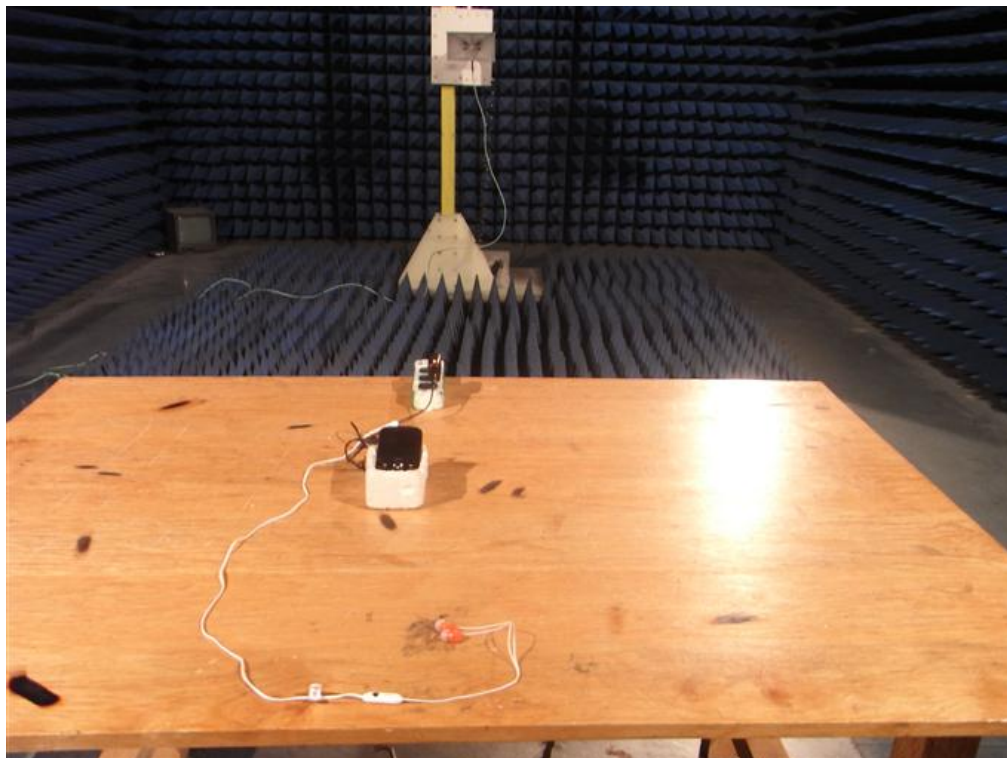

**APPENDIX 2  
PHOTOGRAPHS OF EUT**

FRONT VIEW OF SAMPLE



BACK VIEW OF SAMPLE



LEFT VIEW OF SAMPLE



RIGHT VIEW OF SAMPLE



UP VIEW OF SAMPLE



DOWN VIEW OF SAMPLE





PHOTO OF POWER SUPPLY



PHOTO OF HEADPHONE



PHOTO OF USB



PHOTO OF BATTERY



INTERNAL PHOTO OF POWER SUPPLY - 1

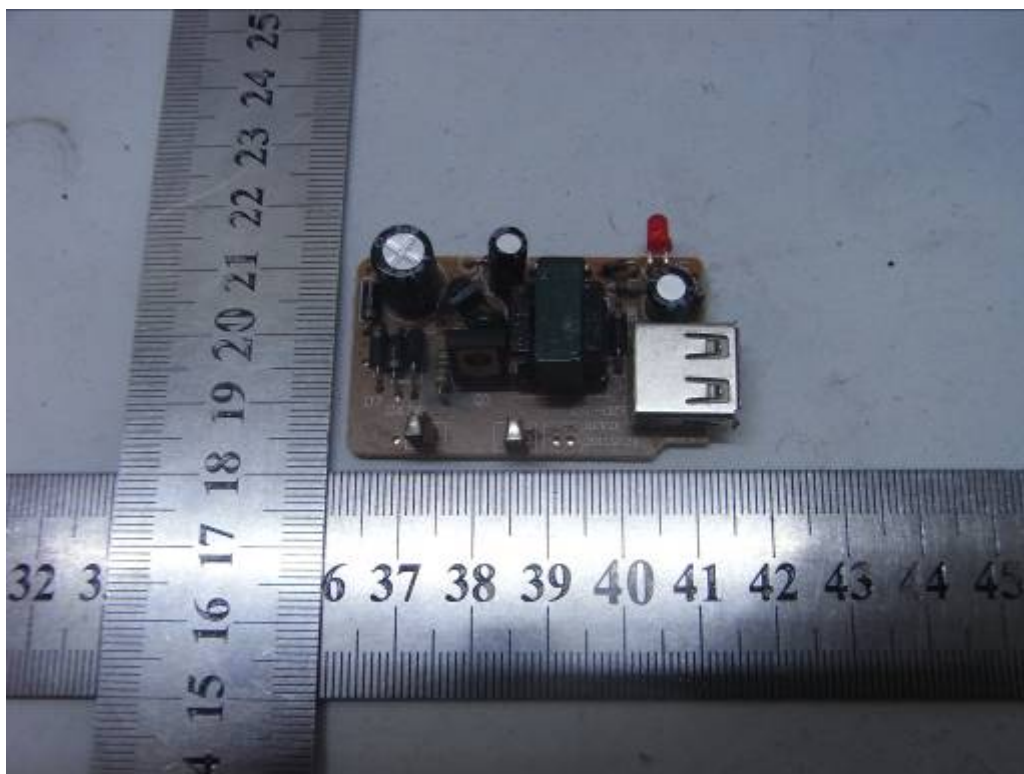

INTERNAL PHOTO OF POWER SUPPLY - 2

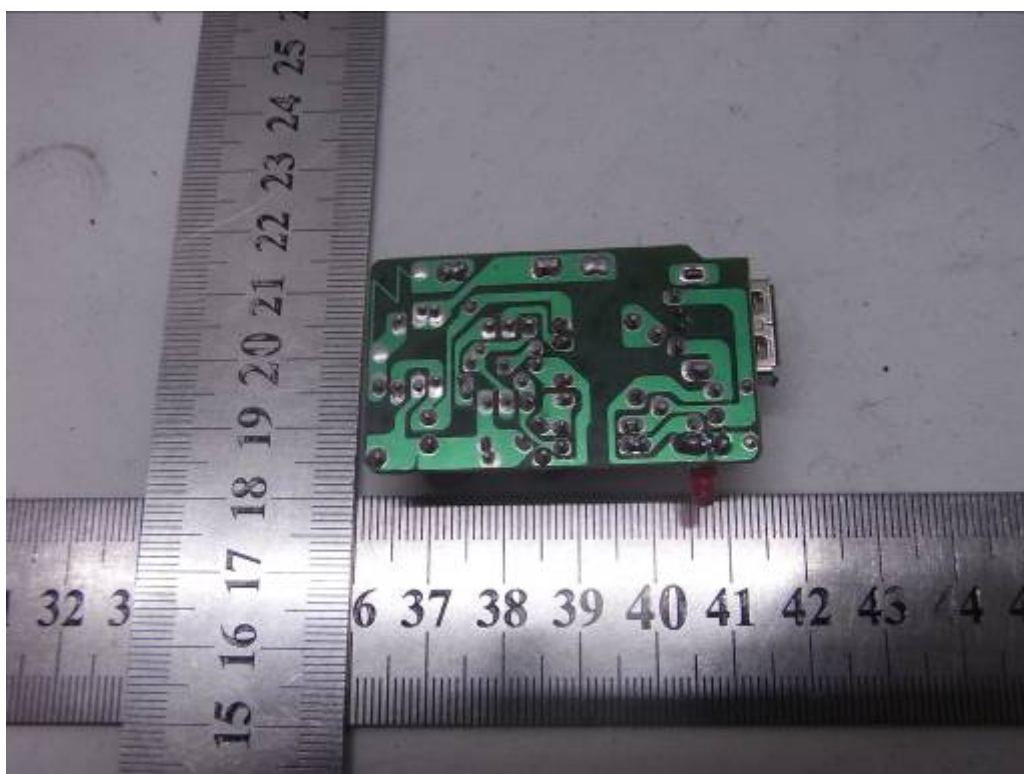

PHOTO OF THE ENTIRE SAMPLE



INTERNAL PHOTO OF SAMPLE - 1



INTERNAL PHOTO OF SAMPLE -2



INTERNAL PHOTO OF SAMPLE - 3



INTERNAL PHOTO OF SAMPLE - 4



INTERNAL PHOTO OF SAMPLE - 5



INTERNAL PHOTO OF SAMPLE - 6

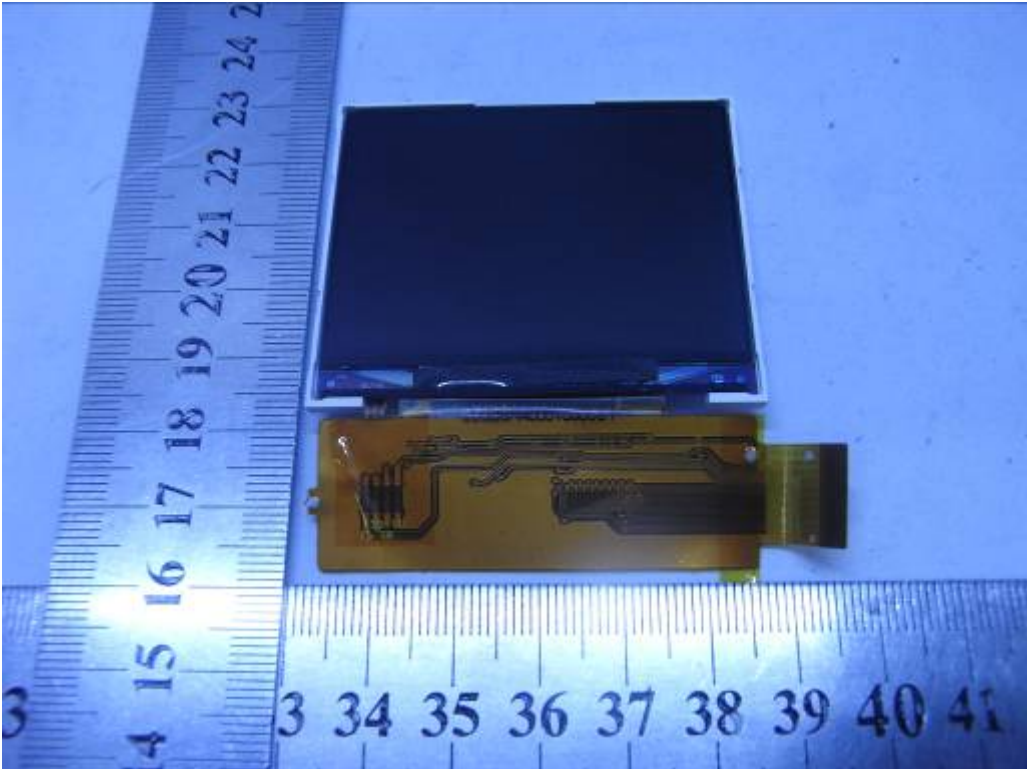

INTERNAL PHOTO OF SAMPLE - 7

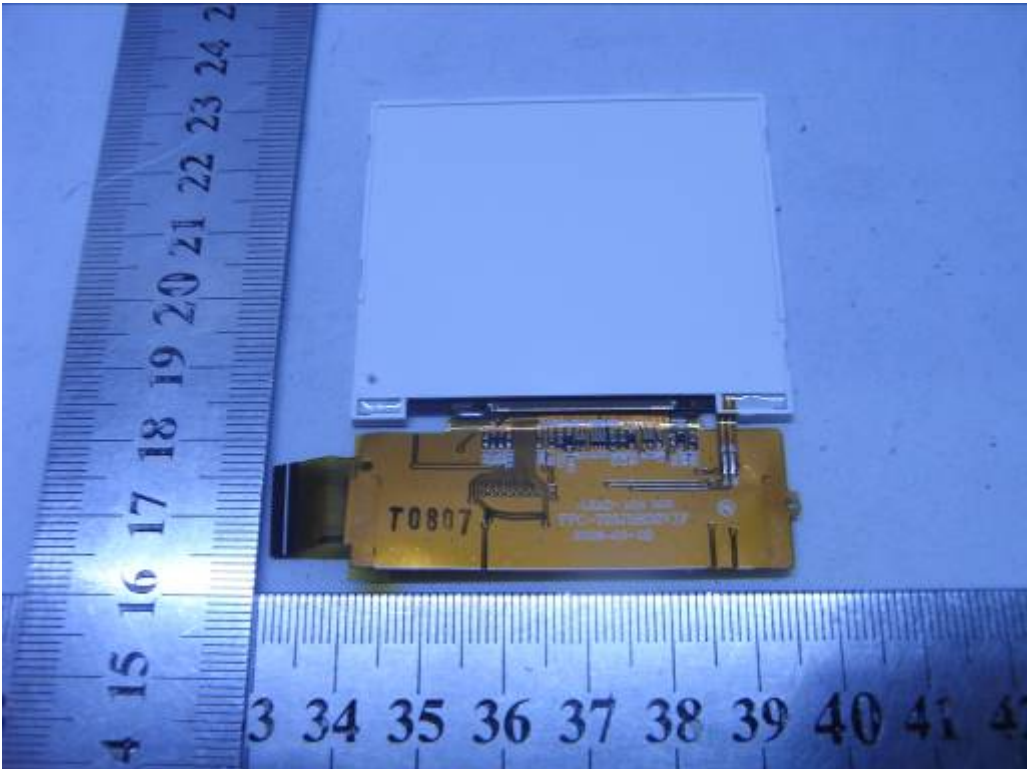

-----END OF REPORT-----