



# FCC 47 CFR PART 24 SUBPART E

## TEST REPORT

*For*

**Applicant :** CLC Hong Kong Limited

**Address :** 907 Hart Avenue Plaza, 5-9A Hart Avenue, Tsim Sha Tsui,  
Kowloon, Hong Kong

**Product Name :** GSM Mobile Phone

**Model Name :** K100

**Brand Name :** PLUM

**FCC ID :** Y7WPLUMK100

**Report No. :** STS110217F4

**Date of Issue :** March. 11, 2011

**Issued by :** Shenzhen Super Test Service Technology Co., Ltd.

**Address :** No.5, Nangshan 2nd Rd., North Hi-Tech Industrial Park ,  
Nanshan, Shenzhen, Guangdong ,China

**Tel :** 86-755-2795 8522

**Fax :** 86-755-2795 8022

*The report consists 43 pages in total. It may be duplicated completely for legal use with the approval of the applicant. It should not be reproduced except in full, without the written approval of our laboratory. The client should not use it to claim product endorsement by STS. The test results in the report only apply to the tested sample. The test report shall be invalid without all the signatures of testing engineers, reviewer and approver.*

**TABLE OF CONTENTS**

**1. VERIFICATION OF CONFORMITY ..... 4**

**2. GENERAL INFORMATION ..... 5**

2.1 Product Information ..... 5

2.2 Objective ..... 6

2.3 Test Standards and Results ..... 6

2.4 Environmental Conditions ..... 6

**3. TEST FACILITY ..... 7**

**4. TEST EQUIPMENT LIST ..... 8**

**5. 47 CFR Part 2, Part 24E Requirements ..... 9**

5.1 General Information ..... 9

5.1.1 Conducted Related Tests ..... 9

5.1.2 Radiated Power and Spurious Emission Tests ..... 10

5.1.3 Frequency Stability Test ..... 11

**6. FREQUENCIES ..... 12**

6.1. Requirement ..... 12

6.2 Test Procedure ..... 12

6.3 Test Result ..... 12

**7. Conducted RF Output Power ..... 14**

7.1 Requirement ..... 14

7.2 Test Procedure ..... 14

7.3 Test Result ..... 14

**8. OCCUPIED BANDWIDTH ..... 17**

8.1 Occupied Bandwidth Definition ..... 17

8.2 Test Procedure ..... 17

8.3 Test Result ..... 17

**9. CONDUCTED SPURIOUS EMISSION ..... 20**

9.1 Requirement ..... 20

9.2 Test Procedure ..... 20

9.3 Test Result ..... 21

**10. Transmitter Radiated Power (EIRP/ERP) ..... 26**

10.1 Requirement ..... 26

10.2 Test Procedure ..... 26

10.3 Test Result ..... 26

**11. Radiated Spurious Emission ..... 27**

11.1 Requirement ..... 27

11.2 Test Procedure ..... 27

11.3 Test Result ..... 28

**12. Frequency Stability ..... 29**

12.1 Frequency Stability Requirement..... 29

12.2 Test Procedure ..... 29

12.3 Test Result..... 30

**APPENDIX 1 ..... 31**

**PHOTOGRAPHS OF TEST SETUP ..... 31**

**APPENDIX 2 ..... 34**

**PHOTOGRAPHS OF EUT ..... 34**

1. VERIFICATION OF CONFORMITY

Equipment Under Test: GSM Mobile Phone
Brand Name: PLUM
Model Number: K100
FCC ID: Y7WPLUMK100
Applicant: CLC Hong Kong Limited.
907 Hart Avenue Plaza, 5-9A Hart Avenue, Tsim Sha Tsui, Kowloon, Hong Kong
Manufacturer: C-LONGER ELECTRONIC CO., LTD.
Room 1806, A Building, Jiahe Huaqiang, Huaqiangbei, Shenzhen, China.
Technical Standards: 47 CFR Part 2
47 CFR Part 22 Subpart H
File Number: STS110217F4
Date of test: March. 7 ~ March. 10, 2011
Deviation: None
Condition of Test Sample: Normal
Test Result: PASS

The above equipment was tested by Shenzhen Super Test Service Technology Co., Ltd. for compliance with the requirements set forth in FCC rules and the Technical Standards mentioned above. This said equipment in the configuration described in this report shows the maximum emission levels emanating from equipment and the level of the immunity endurance of the equipment are within the compliance requirements.

The test results of this report relate only to the tested sample identified in this report.

Tested by (+ signature): Petter Ping
Petter Ping March. 11, 2011

Review by (+ signature): July Wen
July Wen March. 11, 2011

Approved by (+ signature): Terry Yang
Terry Yang March. 11, 2011

## 2. GENERAL INFORMATION

### 2.1 Product Information

<b>EUT1- Mobile Phone</b>	
Description:	GSM Mobile Phone
Model Name:	K100
IMEI No.:	355236030010475/ 355236030010483
Hardware Version:	---
Software Version:	---
Frequency:	Tx: 824.2-848.8 MHz 1850.2-1909.8 MHz Rx: 849.2-893.8 MHz 1930.2-1989.8 MHz
<b>Ancillary Equipment – Power Supply</b>	
Description:	Travel Charger
Model Name:	---
Brand Name:	PLUM
Manufacturer:	SHENZHEN AOLIDE ELECTRONIC TECHNOLOGY CO., LTD.
Rated Input:	AC 100-240V, 50/60HZ 0.15A
Rated Output:	DC 5.0V, 1A
Length USB cable:	1.00m
<b>Ancillary Equipment – Battery</b>	
Description:	Lithium-ion Battery
Model Name:	BL-4U
Brand Name:	PLUM
Manufacturer:	SHENZHEN CHUANGHUITONG TECHNOLOGY CO., LTD.
Capacitance:	800 mAh
Rated Voltage:	3.7V
Charge Limit:	4.2V

**NOTE:**

1. The EUT is a GSM Mobile Station, here only PCS 1900MHz band was tested in this report.
2. The transmitter (Tx) frequency arrangement of the PCS 1900MHz band for the EUT can be represented with a formula  $F(n)=1850.2+0.2*(n-512)$ ,  $512 \leq n \leq 810$ .
3. The normal, high and low voltage supply for the Battery of the EUT is separately 3.7V, 4.2V and 3.6V, which are specified by the applicant.
4. Please refer to Appendix 2 for the photographs of the EUT. For a more detailed features description about the EUT, please refer to User's Manual

### 2.2 Objective

The objective of the report is to perform tests according to 47 CFR Part 2, Part 24 for FCC ID Certification:

No.	Identity	Document Title
1	47 CFR Part 2 (10-1-05 Edition)	Frequency Allocations and Radio Treaty Matters; General Rules and Regulations
2	47 CFR Part 24 (10-1-05 Edition)	Personal Communications Services

### 2.3 Test Standards and Results

Test items and the results are as bellow:

No.	Rules	Test Type	Result	Date of Test
1	§2.106 §24.229	Frequencies	PASS	2011-3-10
2	§2.1046	Conducted RF Output Power at Antenna Terminal	PASS	2011-3-10
3	§2.1049	Occupied Bandwidth	PASS	2011-3-10
4	§2.1051 §2.1057 §24.238	Conducted Spurious Emission at Antenna Terminal	PASS	2011-3-10
5	§24.232	Transmitter Radiated Power (EIPR/ERP)	PASS	2011-3-10
6	§2.1053 §2.1057 §24.238	Radiated Spurious Emission	PASS	2011-3-10
7	§2.1055 §24.235	Frequency Stability	PASS	2011-3-10

Note: 1. The test result judgment is decided by the limit of measurement standard  
 2. The information of measurement uncertainty is available upon the customer's request.

### 2.4 Environmental Conditions

During the measurement the environmental conditions were within the listed ranges:

- Temperature: 15-35°C
- Humidity: 30-60 %
- Atmospheric pressure: 86-106 kPa

### 3. TEST FACILITY

Test Site:	Most Technology Service Co., Ltd.
Location:	No.5, Langshan 2nd Rd., North Hi-Tech Industrial park , Nanshan, Shenzhen, Guangdong ,China
Description:	There is one 3m semi-anechoic an area test sites and two line conducted labs for final test. The Open Area Test Sites and the Line Conducted labs are constructed and calibrated to meet the FCC requirements in documents ANSI C63.4:2009 and CISPR 16 requirements. The FCC Registration Number is <b>490827</b> .
Site Filing:	The site description is on file with the Federal Communications Commission, 7435 Oakland Mills Road, Columbia, MD 21046.
Instrument Tolerance:	All measuring equipment is in accord with ANSI C63.4:2009 and CISPR 16 requirements that meet industry regulatory agency and accreditation agency requirement.
Ground Plane:	Two conductive reference ground planes were used during the Line Conducted Emission, one in vertical and the other in horizontal. The dimensions of these ground planes are as below. The vertical ground plane was placed distancing 40 cm to the rear of the wooden test table on where the EUT and the support equipment were placed during test. The horizontal ground plane projected 50 cm beyond the footprint of the EUT system and distanced 80 cm to the wooden test table. For Radiated Emission Test, one horizontal conductive ground plane extended at least 1m beyond the periphery of the EUT and the largest measuring antenna, and covered the entire area between the EUT and the antenna.

#### 4. TEST EQUIPMENT LIST

**Instrumentation:** The following list contains equipment used at Most for testing. The equipment conforms to the CISPR 16-1 / ANSI C63.2 Specifications for Electromagnetic Interference and Field Strength Instrumentation from 10 kHz to 1.0 GHz or above.

No.	Equipment	Manufacturer	Model No.	S/N	Calibration date	Calibration due date
1	Test Receiver	Rohde & Schwarz	ESCI	100492	2011/03/01	2012/03/01
2	L.I.S.N.	Rohde & Schwarz	ENV216	100093	2011/03/01	2012/03/01
3	Coaxial Switch	Anritsu Corp	MP59B	6200283933	2011/03/01	2012/03/01
4	Terminator	Hubersuhner	50Ω	No.1	2011/03/01	2012/03/01
5	RF Cable	SchwarzBeck	N/A	No.1	2011/03/01	2012/03/01
6	Test Receiver	Rohde & Schwarz	ESPI	101202	2011/03/01	2012/03/01
7	Bilog Antenna	Sunol	JB3	A121206	2011/03/01	2012/03/01
8	Test Antenna - Horn	Schwarzbeck	BBHA 9120C	--	2011/03/01	2012/03/01
9	Test Antenna - LOOP	Schwarzbeck	VULB 9163	--	2011/03/01	2012/03/01
10	Cable	Resenberger	N/A	NO.1	2011/03/01	2012/03/01
11	Cable	SchwarzBeck	N/A	NO.2	2011/03/01	2012/03/01
12	Cable	SchwarzBeck	N/A	NO.3	2011/03/01	2012/03/01
13	DC Power Filter	DuoJi	DL2×30B	N/A	2011/03/01	2012/03/01
14	Single Phase Power Line Filter	DuoJi	FNF 202B30	N/A	2011/03/01	2012/03/01
15	3 Phase Power Line Filter	DuoJi	FNF 402B30	N/A	2011/03/01	2012/03/01
16	Spectrum Analyzer	Agilent	4408B	MY41440460	2011/03/01	2012/03/01
17	Absorbing Clamp	Luthi	MDS21	3635	2011/03/01	2012/03/01
18	Coaxial Switch	Anritsu Corp	MP59B	6200283933	2011/03/01	2012/03/01
19	AC Power Source	Kikusui	AC40MA	LM003232	2011/03/01	2012/03/01
20	Test Analyzer	Kikusui	KHA1000	LM003720	2011/03/01	2012/03/01
21	Line Impedence Network	Kikusui	LIN40MA-PCR-L	LM002352	2011/03/01	2012/03/01
22	ESD Tester	Kikusui	KES4021	LM003537	2011/03/01	2012/03/01
23	EMC PRO System	EM Test	UCS-500-M4	V064810202 6	2011/03/01	2012/03/01
24	Signal Generator	IFR	2032	203002/100	2011/03/01	2012/03/01
25	Amplifier	A&R	150W1000	301584	2011/03/01	2012/03/01
26	CDN	FCC	FCC-801-M2-25	47	2011/03/01	2012/03/01
27	CDN	FCC	FCC-801-M3-25	107	2011/03/01	2012/03/01
28	EM Injection Clamp	FCC	F-203I-23mm	403	2011/03/01	2012/03/01
29	RF Cable	MIYAZAKI	N/A	No.1/No.2	2011/03/01	2012/03/01
30	Universal Radio Communication Tester	ROHDE&SCHWARZ	CMU200	0304789	2011/03/01	2012/03/01
31	Telecommunication Antenna	European Antennas	PSA 75301R/170	0304213	2011/03/01	2012/03/01
32	Temperature Chamber	Guangzhou Gongwen	GDS-250	N/A	2011/03/01	2012/03/01

**NOTE:** Equipments listed above have been calibrated and are in the period of validation.



## 5. 47 CFR Part 2, Part 24E Requirements

### 5.1 General Information

#### 5.1.1 Conducted Related Tests

Based on ANSI/TIA-603-C-2004

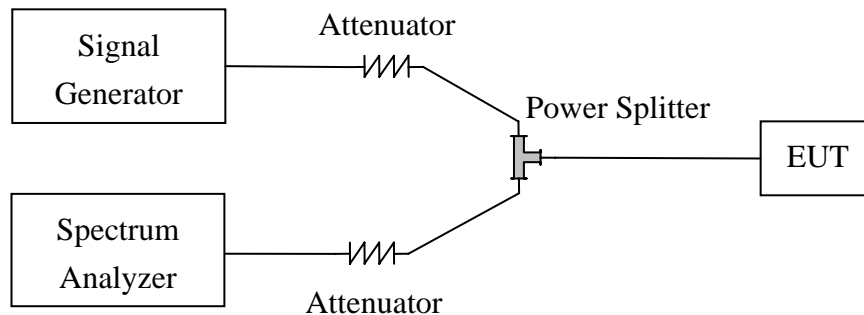

1. The EUT is coupled to the Spectrum Analyzer and the System Simulator with the suitable Attenuators through the Power Splitter; the path loss is calibrated to correct the reading.
2. The EUT is configured here as MS + Battery.
3. Set the spectrum analyzer to measure peak hold with the required settings.
4. Set the signal generator to a known output power and record the path loss in dB (LOSS) for frequencies up to the tenth harmonic of the EUT's carrier frequency.  $LOSS = \text{Generator Output Power (dBm)} - \text{Analyzer reading (dBm)}$ .
5. Replace the signal generator with the EUT.
6. Adjust the settings of the Digital Radio communication Tester (DRT) to set the EUT to its maximum power at the required channel.
7. Set the spectrum analyzer to measure peak hold with the required settings. Offset the spectrum analyzer reference level by the path loss measured above.
8. Measure and record all spurious emissions up to the tenth harmonic of the carrier frequency.
9. Measurements are to be performed with the EUT set to the low, middle and high channel of each frequency band.
10. If necessary steps 7 and 8 may be performed with the spectrum analyzer set to average detector.

Note: Step 4 above is performed prior to testing and LOSS is recorded by test software. Steps 3, 7, and 8 above are performed with test software.

### 5.1.2 Radiated Power and Spurious Emission Tests

Based on ANSI/TIA-603-C-2004

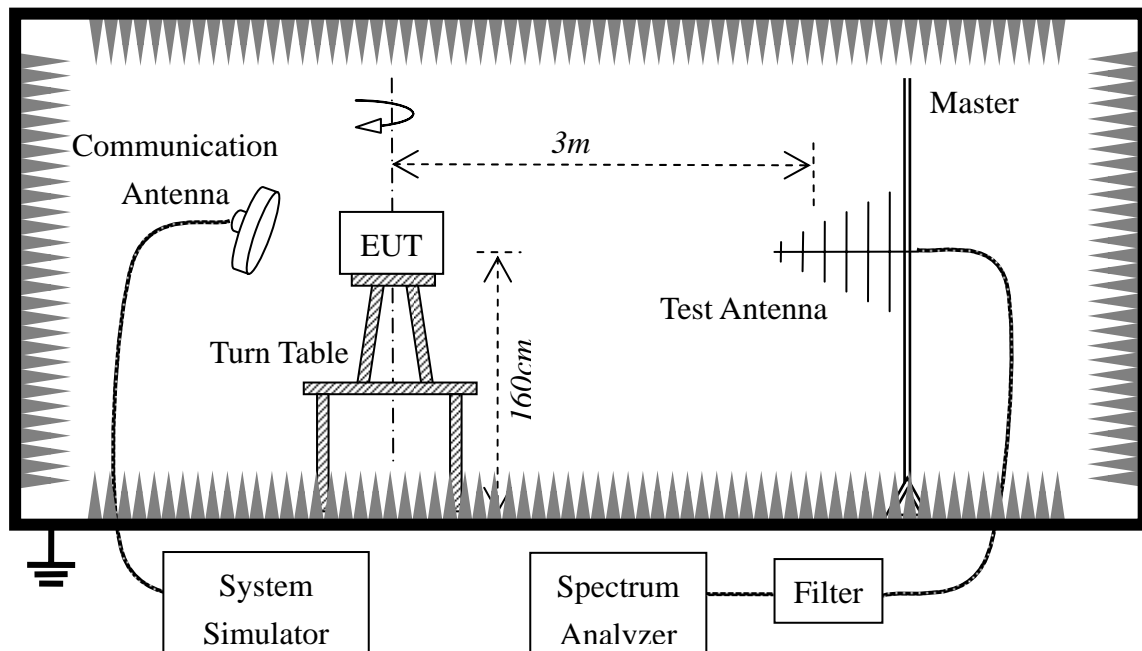

1. The test is performed in a full-Anechoic Chamber; the air loss of the site and the factors of the test system are pre-calibrated using the substitution method.
2. Connect the equipment as shown in the above diagram with the EUT'S antenna in a vertical orientation.
3. Adjust the setting of System Simulator to set the EUT to its maximum power at the require channel.
4. Set the Spectrum Analyzer to the channel frequency, set the analyzer to measure peak hold with the required setting.
5. Rotate the EUT 360 degree, recorded the peak level in dBm(LVL).
6. Replace the EUT with a vertically polarized half wave dipole or known gain antenna. The center of the antenna should be at the same location as the center of the EUT's antenna.
7. Connect the antenna to a signal generator with known output power and record the path loss in dB (Loss),  
 $Loss = \text{Generator Output Power(dBm)} - \text{Spectrum Analyzer reading Power(dBm)}$ .
8. Determine the ERP using the following equation:  
 $ERP(\text{dBm}) = LVL(\text{dBm}) + Loss(\text{dB})$
9. Determine the EIRP using the following equation:  
 $EIRP(\text{dBm}) = ERP(\text{dBm}) + 2.14(\text{dB})$
10. Measurements are to be performed with the EUT set to the low, middle and high channel of each frequency band.

Note: Steps 6 and 7 above are performed prior to setting and Loss is recorded by test software.

### 5.1.3 Frequency Stability Test

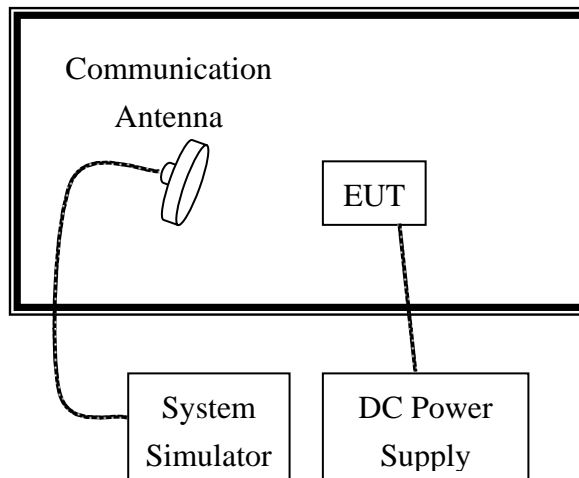

1. The test is performed in a Temperature Chamber.
2. The EUT is configured as MS + DC Power Supply.
3. The BCCH number of the SS used here is 520.

## 6. FREQUENCIES

### 6.1. Requirement

According to FCC §24.229, the frequencies available in the Broadband PCS services are listed as below, in accordance with the frequency allocations table of FCC §2.106.

(a) The following frequency blocks are available for assignment on an MTA basis:

Block A: 1850 - 1865MHz paired with 1930 - 1945MHz;

Block B: 1870 - 1885MHz paired with 1950 - 1965MHz.

(b) The following frequency blocks are available for assignment on a BTA basis:

Block C: 1895 - 1910 MHz paired with 1975 - 1990MHz;

Block D: 1865 - 1870 MHz paired with 1945 - 1950MHz;

Block E: 1885 - 1890 MHz paired with 1965 - 1970MHz;

Block F: 1890 - 1895 MHz paired with 1970 - 1975MHz.

### 6.2 Test Procedure

1. Perform test system setup as section 5.1.1.
2. The resolution bandwidth of the Spectrum Analyzer is set to at least one percent of the emission bandwidth of the fundamental emission of the transmitter, e.g. for GSM modulated signal (here used):  $RBW=VBW=3kHz$ , for CDMA modulated signal:  $RBW=VBW=30kHz$ .
3. The lowest and the highest channels are selected to perform tests respectively. Set the TCH number to 512 via the SS as the lowest channel.
4. Set the frequency range of the Spectrum Analyzer suitably to capture the waveform; search peak and mark it; finally record the plot.
5. Set the TCH number to 810 as the highest channel, then repeat step 4.

### 6.3 Test Result

The transmitter (Tx) frequency arrangement of the PCS 1900MHz band is represented with a formula

$F(n)=1850.2+0.2*(n-512)$ ,  $512 \leq n \leq 810$ . The frequencies of the lowest channel and the highest channel are listed as follows.

1. Plot when the TCH number set to 512:

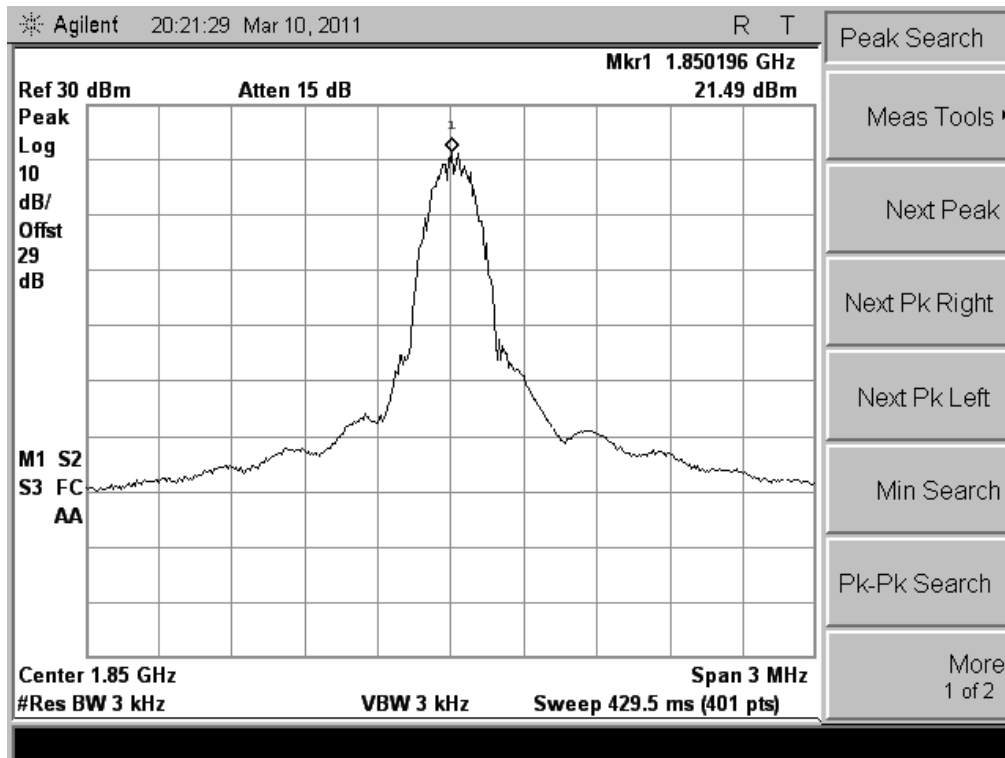

2. Plot when the TCH number set to 810:

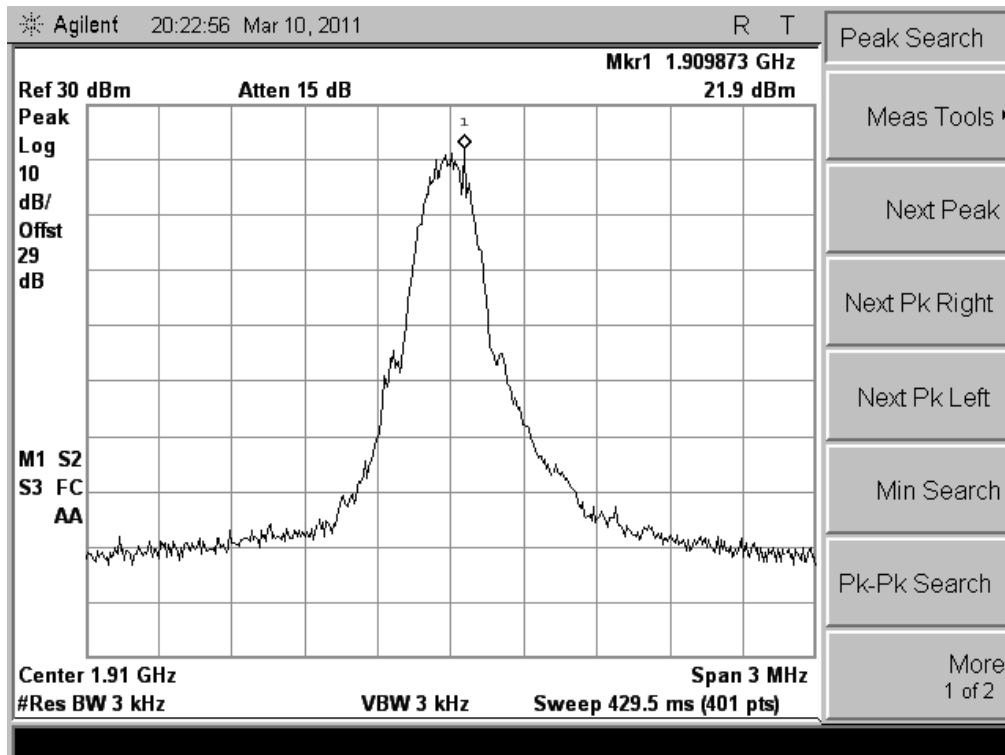

## 7. Conducted RF Output Power

### 7.1 Requirement

According to FCC §2.1046(a), for transmitters other than single sideband, independent sideband and controlled carrier radiotelephone, power output shall be measured at the RF output terminals when the transmitter is adjusted in accordance with the tune-up procedure to give the values of current and voltage on the circuit elements specified in §2.1033(c)(8). The electrical characteristics of the radio frequency load attached to the output terminals when this test is made shall be stated.

### 7.2 Test Procedure

1. Perform test system setup as section 5.1.1 (the radio frequency load attached to the EUT antenna terminal is 50Ω).
2. The resolution bandwidth of the Spectrum Analyzer is set to be comparable to the emission bandwidth of the transmitter, e.g. for GSM modulated signal (here used): RBW=VBW=1MHz, for CDMA modulated signal: RBW=VBW=3MHz.
3. The low, middle and the high channels are selected to perform tests respectively. Set the TCH number to 512 as the low channel.
4. Set the frequency range of the Spectrum Analyzer suitably to capture the waveform; search peak and mark it; finally record the peak and the plot.
5. Set the TCH number to 661 as the middle channel, then repeat step 4.
6. Set the TCH number to 810 as the high channel, then repeat step 4.

### 7.3 Test Result

No.	Channel Number	Frequency (MHz)	Measured Power		Rated Power	
			dBm	W	dBm	W
1	512	1850.2	29.38	0.867	30	1
2	661	1880.0	29.45	0.881	30	1
3	810	1909.8	29.61	0.914	30	1

1. Plot when the TCH number set to 512:

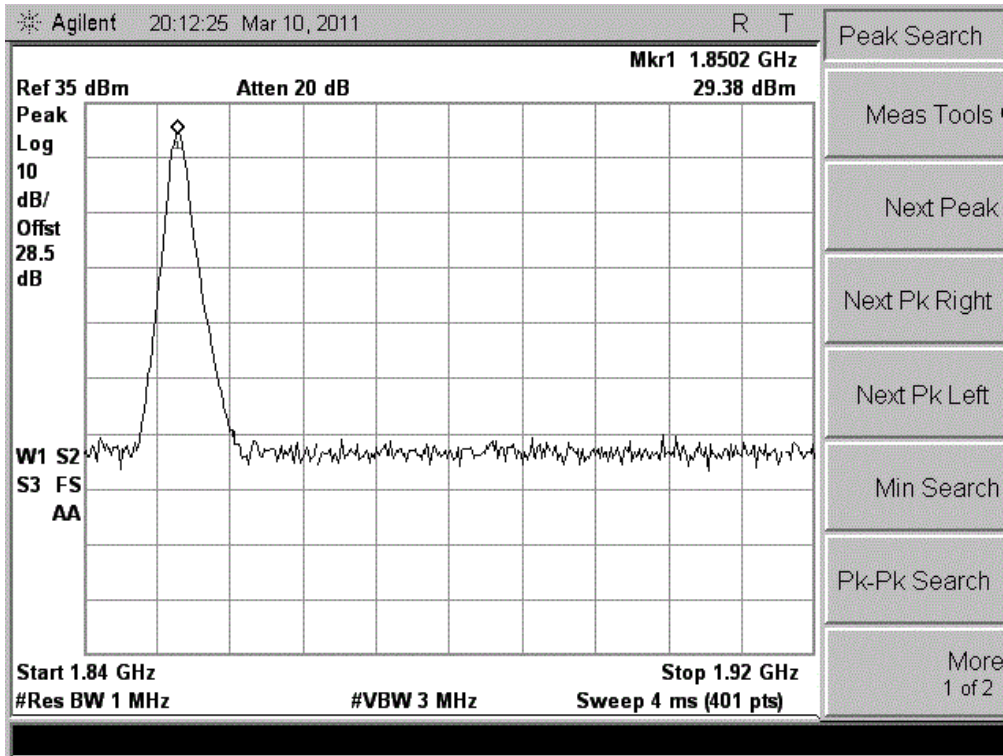

2. Plot when the TCH number set to 661:

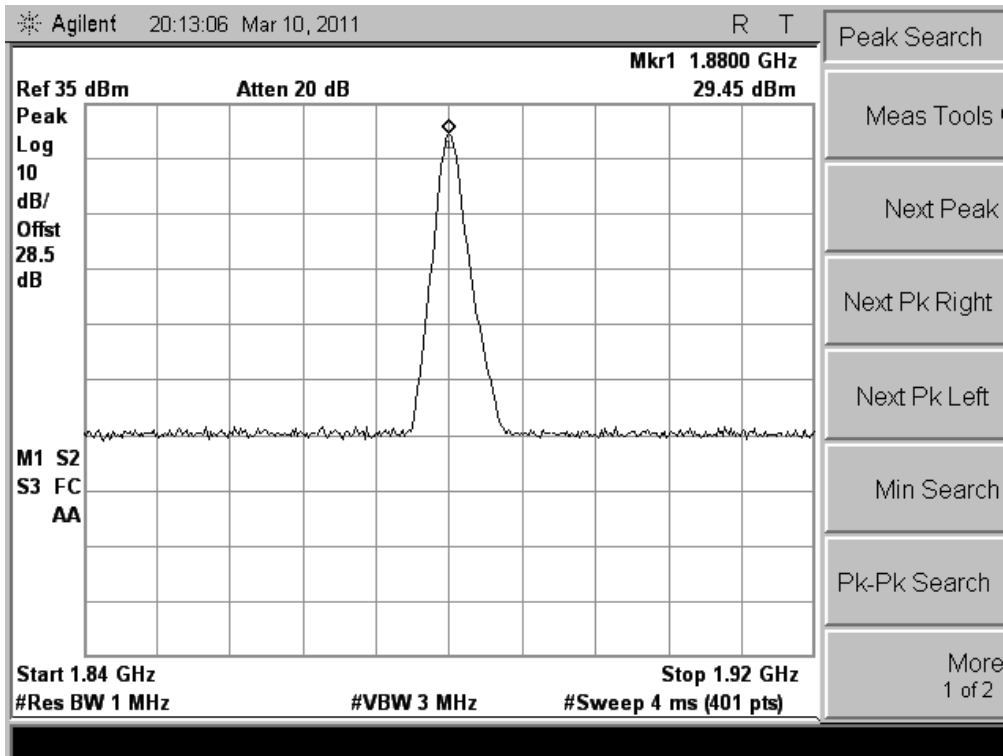

3. Plot when the TCH number set to 810:

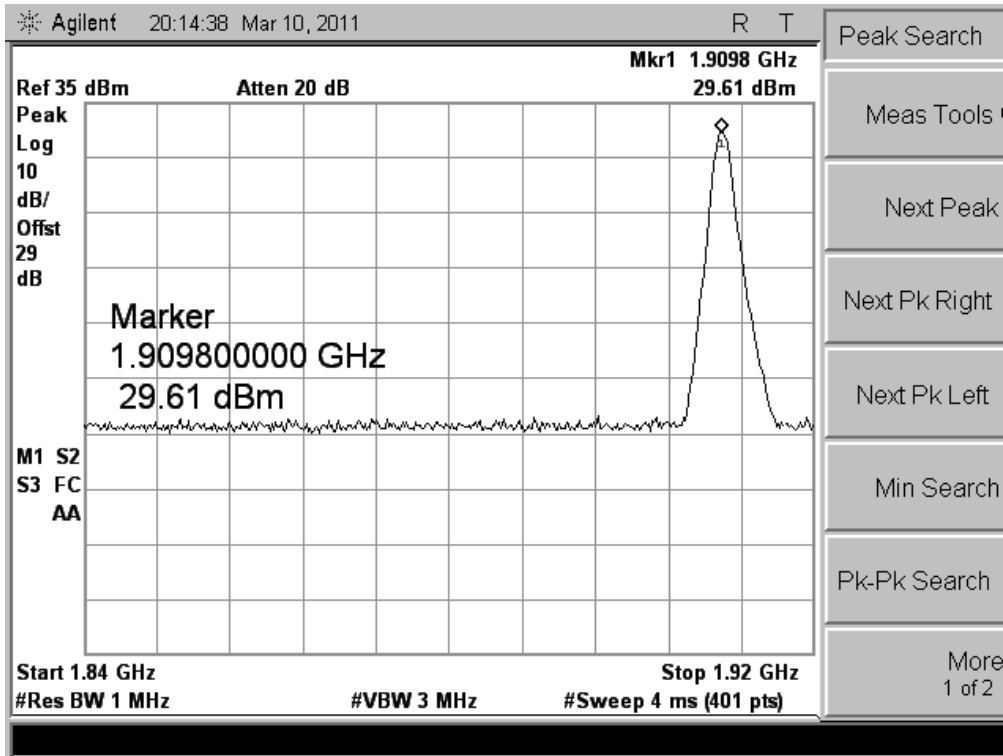



**8. OCCUPIED BANDWIDTH**

**8.1 Occupied Bandwidth Definition**

According to FCC §2.1049, the occupied bandwidth is the frequency bandwidth such that, below its lower and above its upper frequency limits, the mean powers radiated are each equal to 0.5 percent of the total mean power radiated by a given emission.

Occupied bandwidth is also known as the 99% emission bandwidth, or 20dB bandwidth ( $10 \cdot \log 1\%$  is equal to 20dB) taking the total RF output power as reference.

**8.2 Test Procedure**

1. Perform test system setup as section 5.1.1
2. The resolution bandwidth of the Spectrum Analyzer is set to at least one percent of the emission bandwidth, e.g. for GSM modulated signal (here used): RBW=VBW=3 kHz, for CDMA modulated signal: RBW=VBW=30 kHz.
3. The low, middle and the high channels are selected to perform tests respectively. Set the TCH number to 512 as the low channel.
4. Set the frequency range of the Spectrum Analyzer suitably to capture the waveform; search peak; make a line whose value is 20dB lower than the peak; mark two points which the line intersected the waveform at; finally record the delta of the two points as the occupied bandwidth and the plot.
5. Set the TCH number to 661 as middle channel, then repeat step 4.
6. Set the TCH number to 810 as high channel, then repeat step 4.

**8.3 Test Result**

No.	Channel	Frequency (MHz)	Measured Occupied Bandwidth (kHz)
1	512	1850.2	285.0
2	661	1880.0	285.0
3	810	1909.8	293.0

1. Plot when the TCH number set to 512:

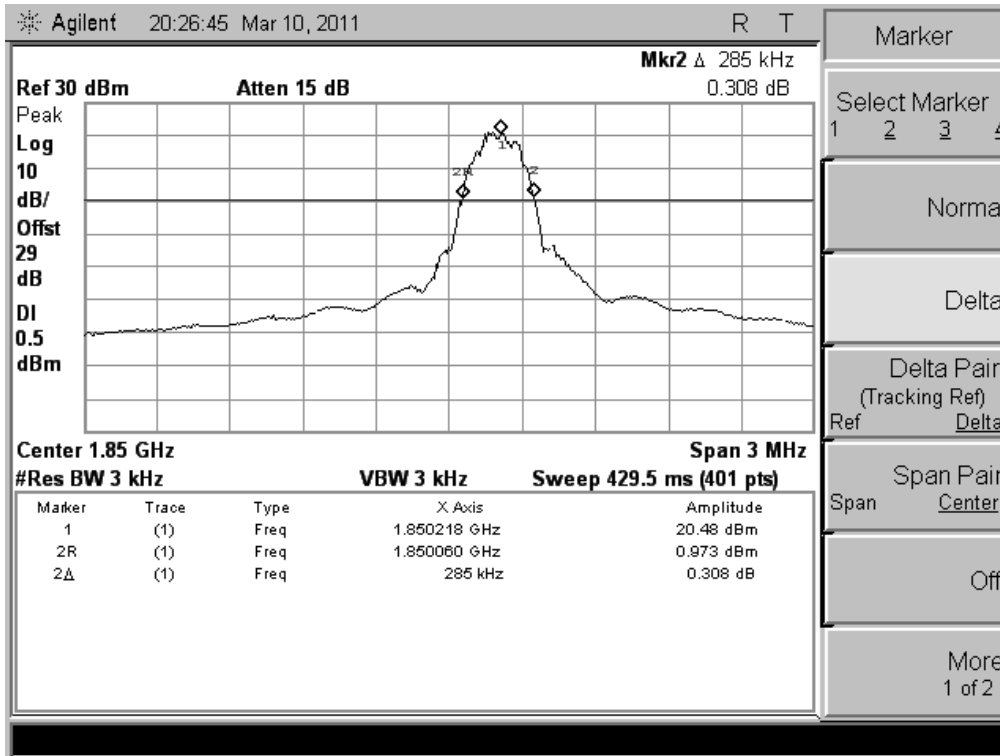

2. Plot when the TCH number set to 661:

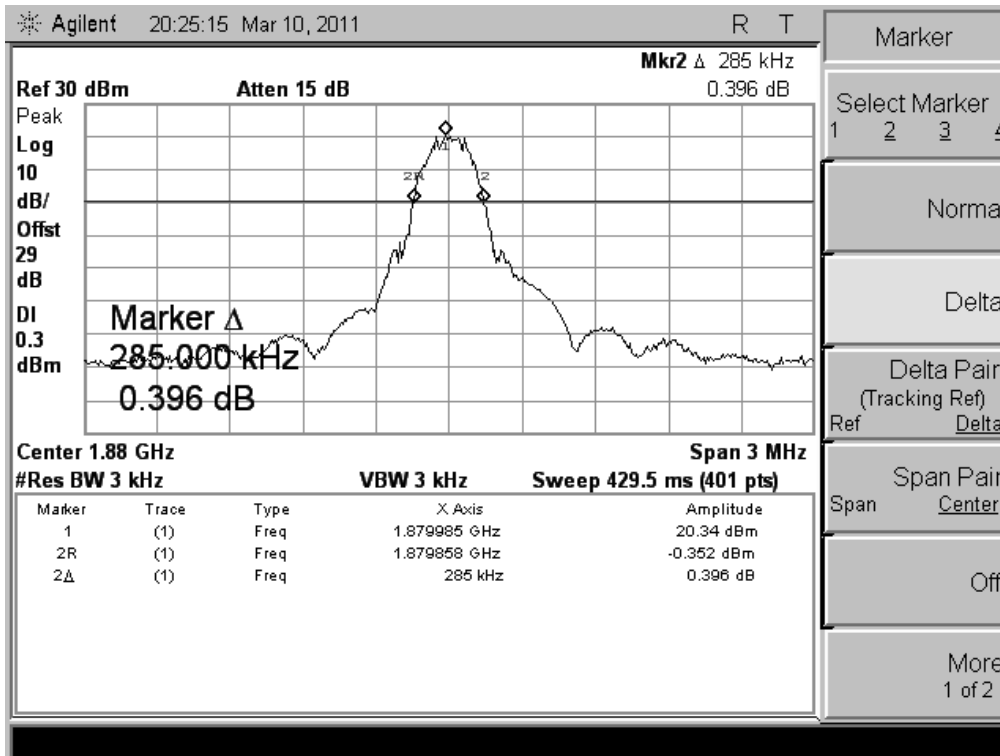

3. Plot when the TCH number set to 810:

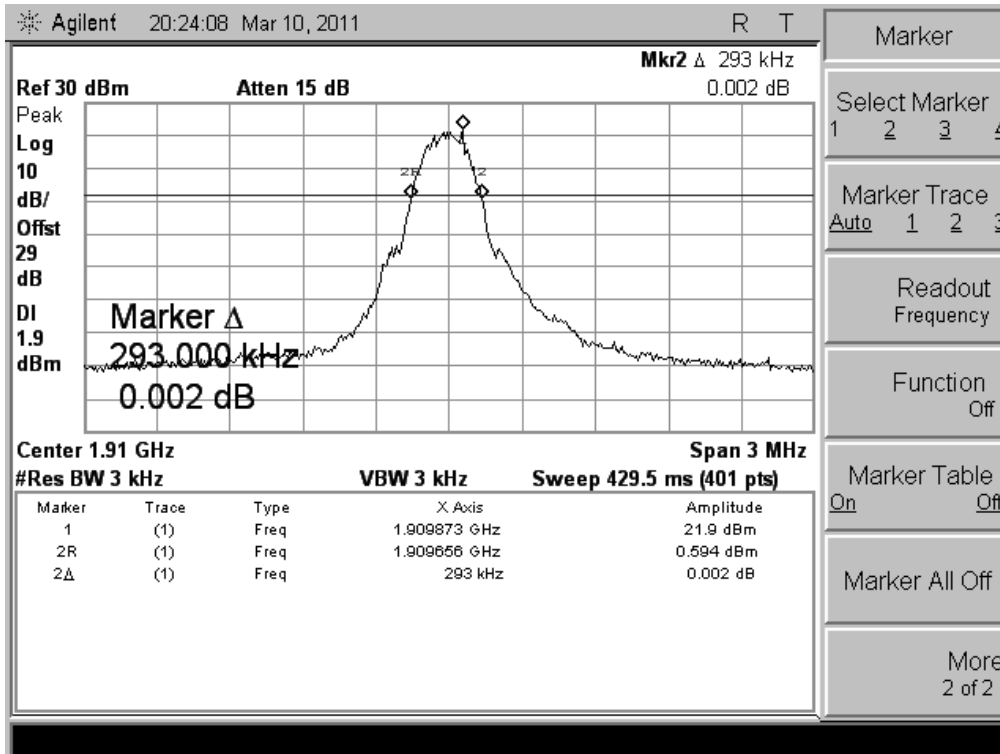

## 9. CONDUCTED SPURIOUS EMISSION

### 9.1 Requirement

1. According to FCC §24.238(a), the power of any emission outside of the authorized operating frequency ranges must be attenuated below the transmitting power (P) by a factor of at least  $43+10*\log(P)$ dB. This calculated to be -13dBm.
2. According to FCC §24.238(b), in the 1MHz bands immediately outside and adjacent to the frequency block a resolution bandwidth of at least one percent of the emission bandwidth of the fundamental emission of the transmitter may be employed. Thus the 26dB emission bandwidth is measurement for showing compliance at the band-edge.

### 9.2 Test Procedure

1. Perform test system setup as section section 5.1.1.
2. Make a limit line whose value is -13dBm on the Spectrum Analyzer.
3. The lowest, middle and the highest channels are selected to perform tests respectively. Set the TCH number to 512 as the lowest channel.
4. Set the RBW of the Spectrum Analyzer to 1MHz, and the measuring frequency range from 9kHz to 10th harmonic of the fundamental frequency (here used 26.5GHz); mark the fundamental frequency and the harmonics thereof; finally record the harmonics and the plot. Note, the measuring frequency range can be divided into several parts to perform tests.
5. In the 1MHz bands immediately outside and adjacent to the frequency black, the RBW of the Spectrum Analyzer was set to at least one percent of the emission bandwidth of the fundamental emission of the transmitter, e.g. for GSM modulated signal (here used): RBW=3kHz, for CDMA modulated signal: RBW=30kHz.
6. Set the TCH number to 661 as the middle channel, then repeat step 4.
7. Set the TCH number to 810 as the highest channel, then repeat step 4 and 5.

**9.3 Test Result**

**Table for the Harmonics and Plots for the Spurious Emission**

1. Table for the Harmonics:

NOTE: “---” in the table following means that the emission power was too small to be measured and was at least 12dB below the limit.

No.	Frequency (MHz)	Emission Power (dBm)	Limit (dBm)
TCH number set to 512 (1850.20MHz)			
1	3700.40	-26.31	-13
2	5550.60	---	-13
3	7400.80	---	-13
4	9251.00	-28.92	-13
5	11101.20	---	-13
6	12951.40	---	-13
7	14801.60	---	-13
8	16651.80	---	-13
9	18502.00	---	-13
TCH number set to 661 (1880.00MHz)			
10	3760.00	-25.11	-13
11	5640.00	---	-13
12	7520.00	---	-13
13	9400.00	-30.58	-13
14	11280.00	---	-13
15	13160.00	---	-13
16	15040.00	---	-13
17	16920.00	---	-13
18	18800.00	---	-13
TCH number set to 810 (1909.80MHz)			
19	3819.60	-20.35	-13
20	5729.40	---	-13
21	7639.20	---	-13
22	9549.00	-27.19	-13
23	11458.80	---	-13
24	13368.60	---	-13
25	15278.40	---	-13
26	17188.20	---	-13
27	19098.00	---	-13

2. Plot for Spurious Emission:

The measuring frequency range was from 9 kHz to 20GHz.

NOTE: The marker points are the Mobile Phone and/or System Simulator transmitting frequencies which should be ignored.

2.1 Plot when the TCH number set to 512:

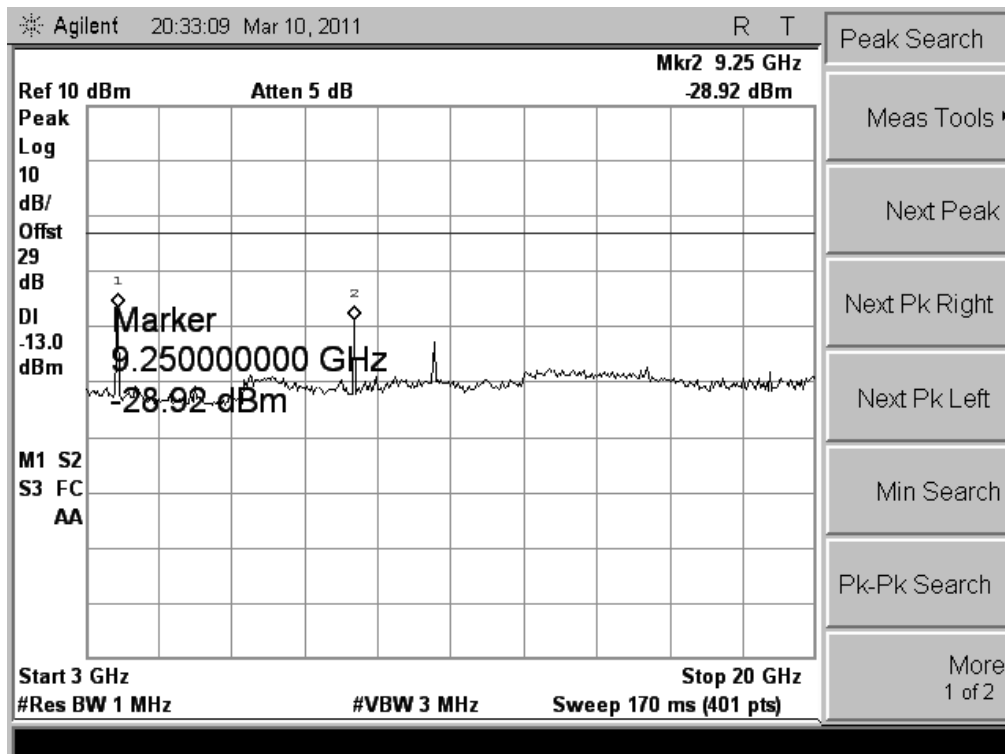
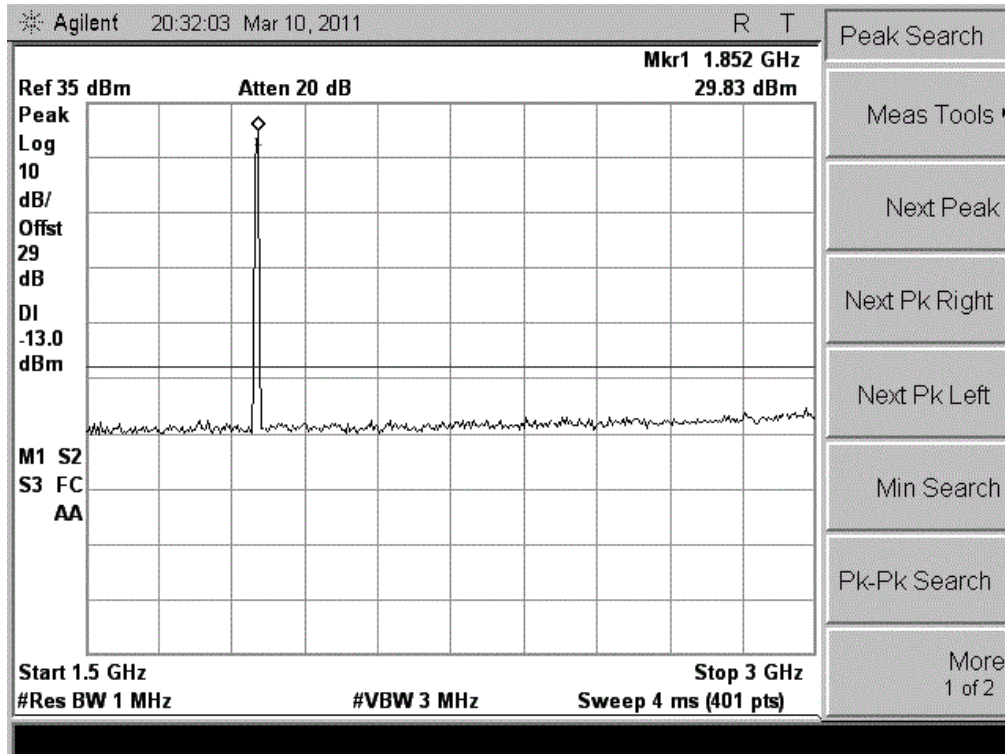

2.2 Plot when the TCH number set to 661:

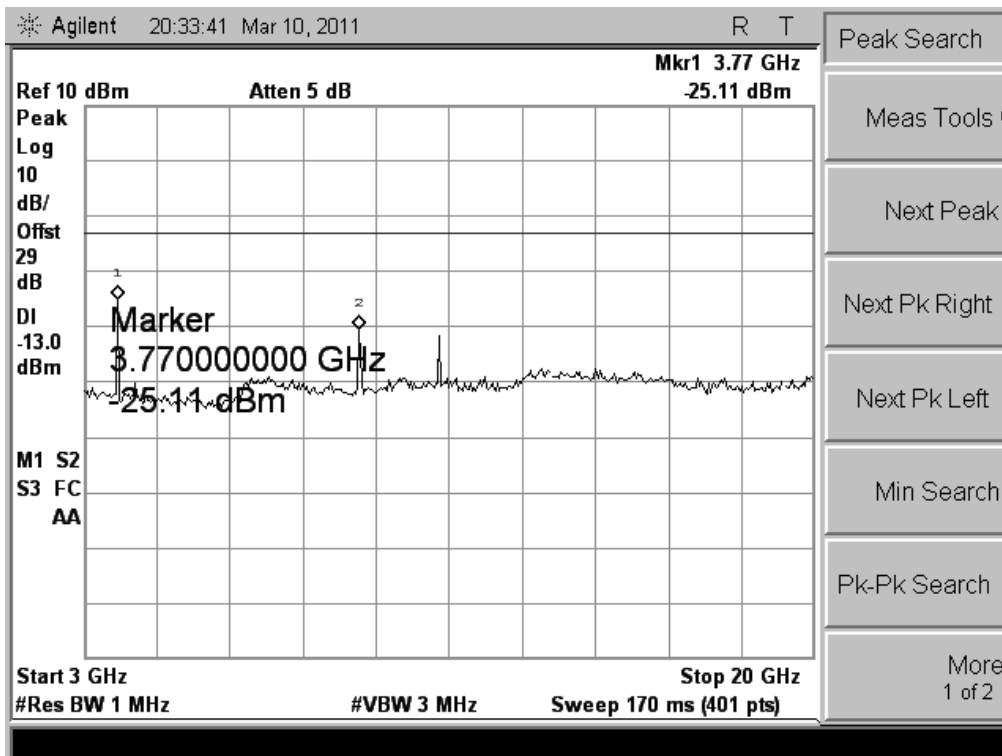
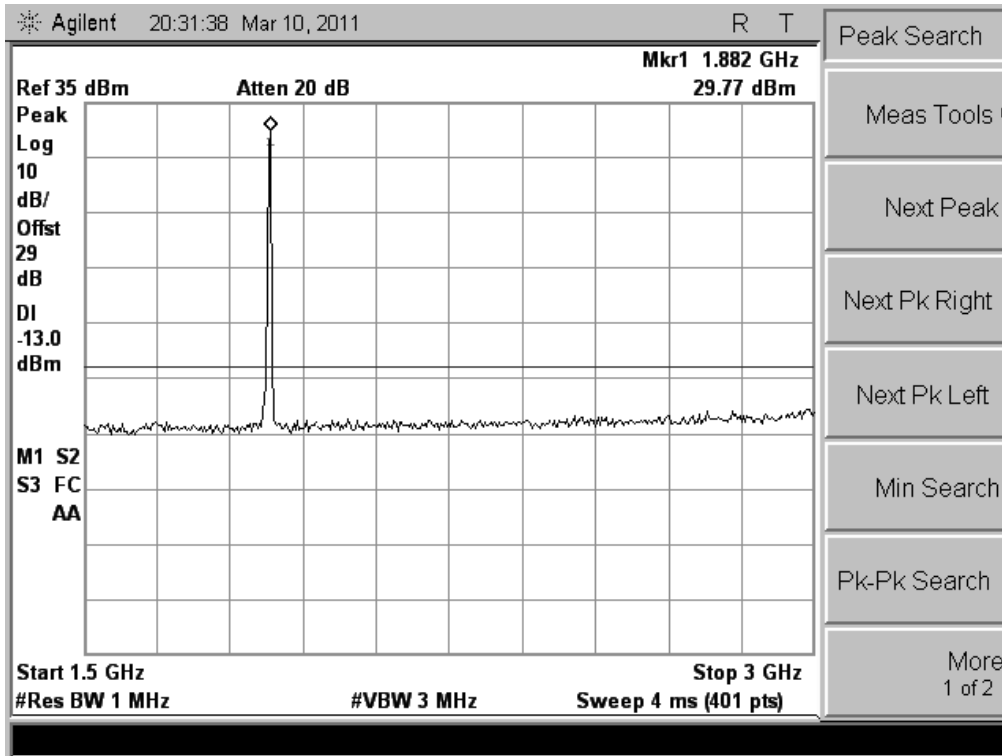

2.3 Plot when the TCH number set to 810:

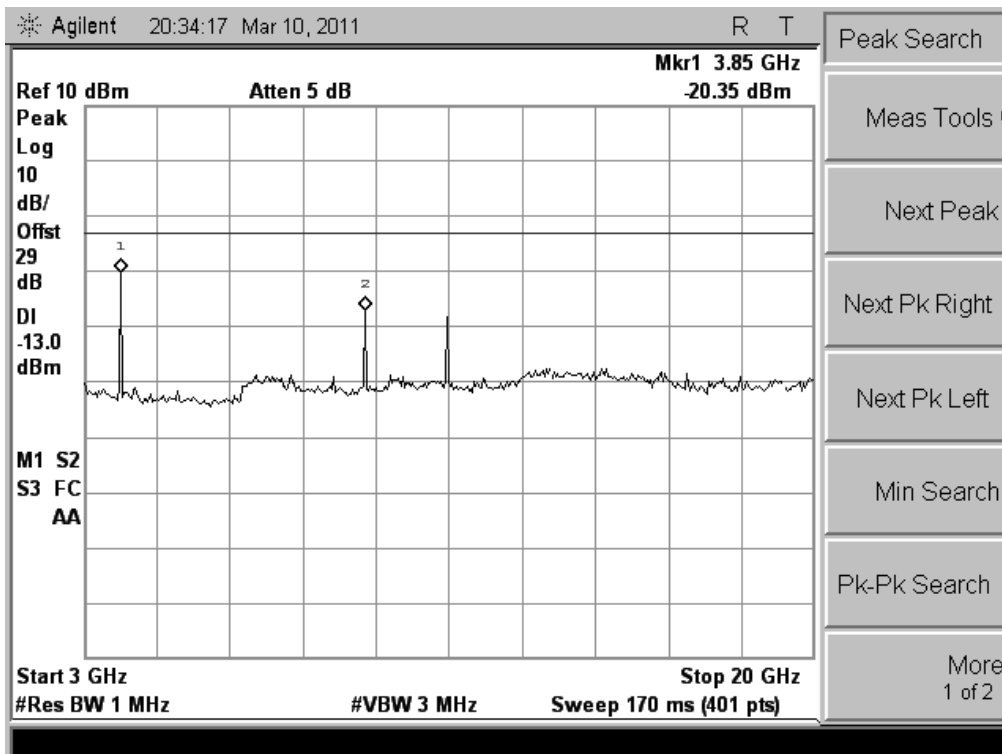
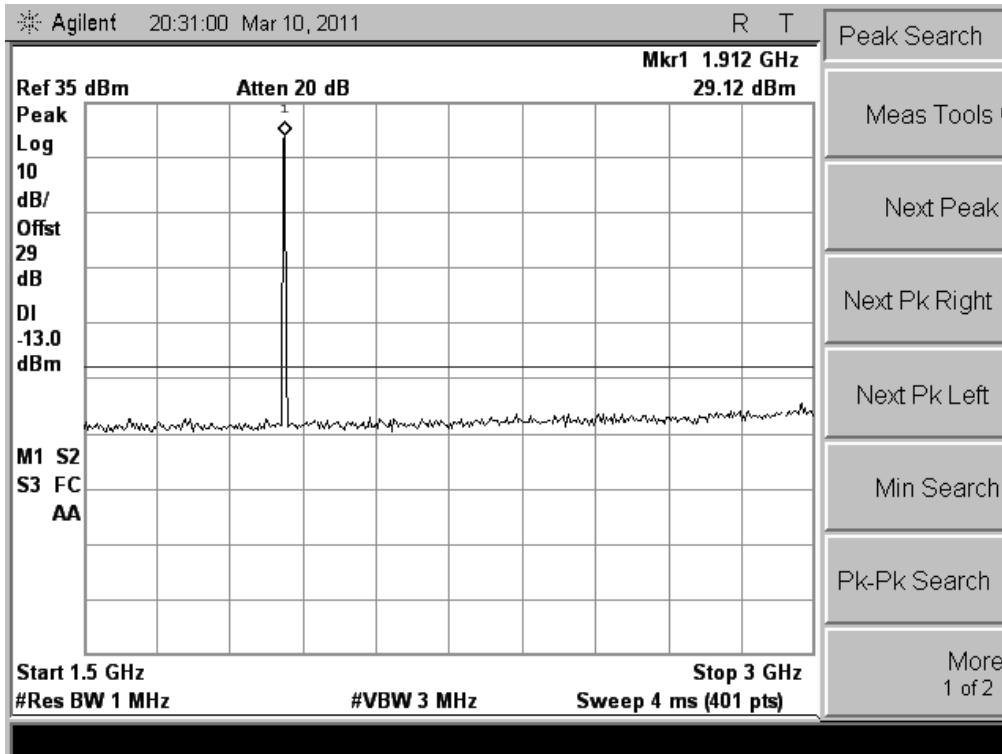



3. Plot for Band-edge

3.1 Plot when the TCH number set to 512:

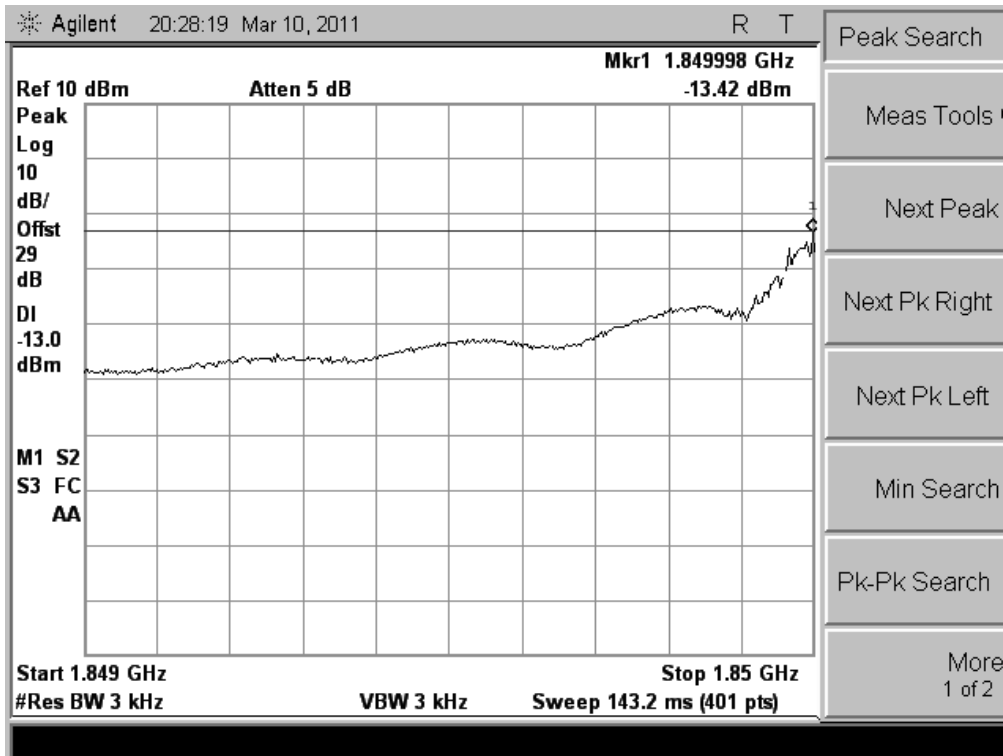

3.2 Plot when the TCH number set to 810:

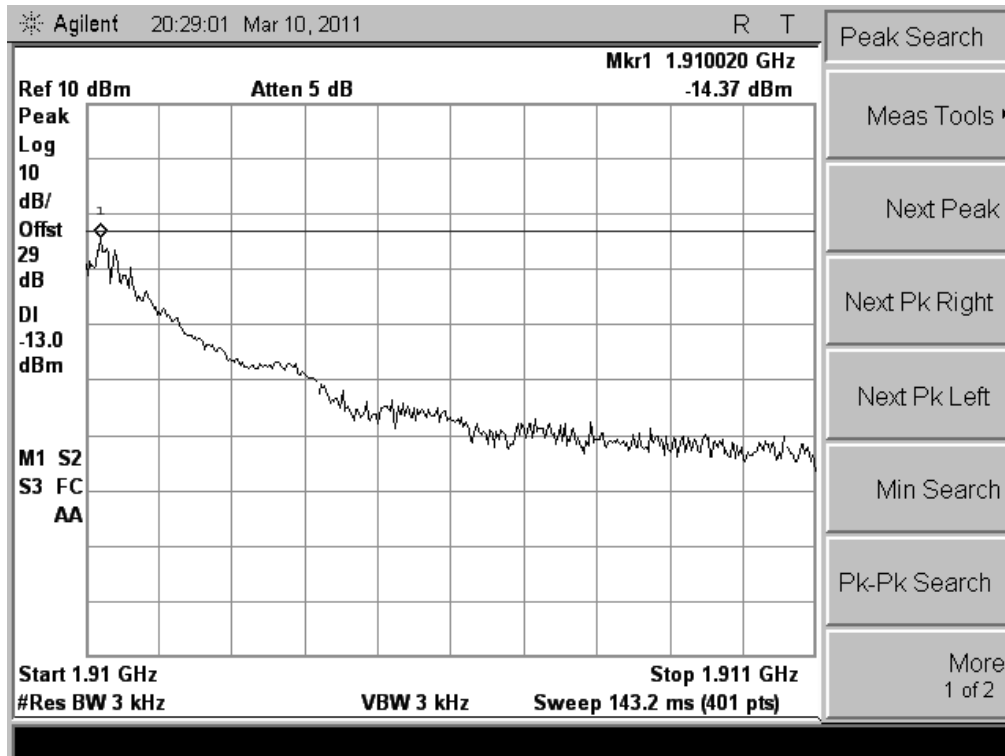

## 10. Transmitter Radiated Power (EIRP/ERP)

### 10.1 Requirement

According to FCC §24.232, the EIRP of Cellular mobile transmitters must not exceed 2 Watts (33dBm) e.i.r.p peak power.

### 10.2 Test Procedure

1. Perform test system setup as section 5.1.1.
2. The resolution bandwidth of the Spectrum Analyzer is set to be comparable to the emission bandwidth of the transmitter, e.g. for GSM modulated signal (here used): RBW=VBW=1MHz, for CDMA modulated signal: RBW=VBW=3MHz.
3. The low, middle and the high channels are selected to perform tests respectively. Set the TCH number to 512 as the low channel.
4. Employ the bi-log Test Antenna as the test system receiving antenna; set the polarization of the Test Antenna to be the same as that of the EUT transmitting antenna.
5. Set the frequency range of the Spectrum Analyzer suitably to capture the waveform; actuate the Turn Table to turn from 0 degrees to 360 degrees to find the maximum reading via the Spectrum Analyzer, mark the peak; finally record the peak and the plot.
6. Set the TCH number to 661 as the middle channel, then repeat step 5.
7. Set the TCH number to 810 as the high channel, then repeat step 5.

### 10.3 Test Result

No.	Channel	Frequency (MHz)	Measured EIRP		Limit EIRP		Result
			dBm	W	dBm	W	
1	512	1850.20	29.65	0.923	< 33.0	< 2	PASS
2	661	1880.00	29.53	0.897	< 33.0	< 2	PASS
3	810	1909.80	29.58	0.908	< 33.0	< 2	PASS

## 11. Radiated Spurious Emission

### 11.1 Requirement

According to FCC §24.238(a), the power of any emission outside of the authorized operating frequency ranges must be attenuated below the transmitting power (P) by a factor of at least  $43+10*\log(P)$ dB. This calculated to be -13dBm.

### 11.2 Test Procedure

1. Perform test system setup as section 5.1.2.
2. Make a limit line whose value is -13dBm on the Spectrum Analyzer, and set the RBW of the Spectrum Analyzer to 1MHz.
3. The low, middle and the high channels are selected to perform tests respectively. Set the TCH number to 512 as the low channel.
4. Employ the bi-log Test Antenna as the test system receiving antenna and set the frequency range of the Spectrum Analyzer from 30MHz to 3GHz.
5. The measurement is performed with the Test Antenna at both horizontal and vertical polarization respectively. Set the polarization of the Test Antenna to be horizontal.
6. Actuate the Turn Table to turn from 0 degrees to 360 degrees to find the maximum reading via the Spectrum Analyzer, mark the fundamental frequency and the harmonics thereof, after then record the harmonics and the plot.
7. Set the polarization of the Test Antenna to be vertical, then repeat step 6.
8. Employ the horn Test Antenna as the test system receiving antenna and set the frequency range of the Spectrum Analyzer from 3GHz to 10th harmonic of the fundamental frequency (here used 10GHz), then repeat step 5 to 7.
9. Set the TCH number to 661 as the middle channel, then repeat step 4 to 8.
10. Set the TCH number to 810 as the high channel, then repeat step 4 to 8.

**11.3 Test Result**

Table for the Harmonics

NOTE: “---” in the table following means that the emission power was too small to be measured and was at least 12dB below the limit.

No.	Frequency (MHz)	Emission Power (dBm)		Limit (dBm)
		Test Antenna Vertical	Test Antenna Horizontal	
TCH number set to 512 (1850.20MHz)				
1	3700.40	-36.31	-37.57	-13
2	5550.60	---	---	-13
3	7400.80	---	---	-13
4	9251.00	---	---	-13
5	11101.20	---	---	-13
6	12951.40	---	---	-13
7	14801.60	---	---	-13
8	16651.80	---	---	-13
9	18502.00	---	---	-13
TCH number set to 661 (1880.0MHz)				
10	3760.00	-36.94	-35.29	-13
11	5640.00	---	---	-13
12	7520.00	---	---	-13
13	9400.00	---	---	-13
14	11280.00	---	---	-13
15	13160.00	---	---	-13
16	15040.00	---	---	-13
17	16920.00	---	---	-13
18	18800.00	---	---	-13
TCH number set to 810 (1909.80MHz)				
19	3819.60	-35.18	-36.73	-13
20	5729.40	---	---	-13
21	7639.20	---	---	-13
22	9549.00	---	---	-13
23	11458.80	---	---	-13
24	13368.60	---	---	-13
25	15278.40	---	---	-13
26	17188.20	---	---	-13
27	19098.00	---	---	-13

## 12. Frequency Stability

### 12.1 Frequency Stability Requirement

According to FCC §24.235, the frequency stability shall be sufficient to ensure that the fundamental emission stays within the authorized frequency block.

According to FCC §2.1055, the test conditions are:

(a) Temperature:

The temperature is varied from  $-30^{\circ}\text{C}$  to  $+50^{\circ}\text{C}$  at intervals of not more than  $10^{\circ}\text{C}$ .

(b) Primary Supply Voltage:

For hand carried battery powered equipment, the primary supply voltage is reduced to the battery operating end point which shall be specified by the manufacture. The supply voltage shall be measured at the input to the cable normally provided with the equipment, or at the power supply terminals if cables are not normally provided.

### 12.2 Test Procedure

1. Perform test system setup as section 5.1.3.
2. Set the voltage of the DC Power Supply to normal supply voltage (here used 3.7V) and the temperature of the Temperature Chamber to vary from  $-30^{\circ}\text{C}$  to  $+50^{\circ}\text{C}$  at intervals of  $10^{\circ}\text{C}$ .
3. At each temperature level, the EUT is powered off and kept in the Temperature Chamber for two hours.
4. After sufficient stabilization, turn on the EUT, command it via the System Simulator (SS) to operate at the maximum output power i.e. Power Control Level (PCL) = 0 and Power Class = 1, and then establish a communication link between the EUT and the SS.
5. The low, middle and the high channels are selected to perform tests respectively. Set the TCH number to 512 as the low channel.
6. The frequency deviation is measured (directly read from the SS, which can report the parameter) within three minutes.
7. Set the TCH number to 661 as the middle channel, then repeat step 5.
8. Set the TCH number to 810 as the high channel, then repeat step 5.
9. Adjust the temperature of the Temperature Chamber as specified in step 2, then repeat step 3 to 7.
10. Set the voltage of the DC Power Supply to high extreme supply voltage (here used 4.2V) and the temperature of the Temperature Chamber to normal (here used  $+22^{\circ}\text{C}$ ), then repeat step 3 to 8.
11. Set the voltage of the DC Power Supply to low extreme supply voltage (here used 3.6V) and the temperature of the Temperature Chamber to normal (here used  $+22^{\circ}\text{C}$ ), then repeat step 3 to 8.

**12.3 Test Result**

No.	Test Conditions		Frequency Deviation (Hz) at Channels Used			
	Voltage	Temperature	512	661	810	Limit ( $\pm 2.5$ ppm)
1	V-nor	-30°C	-36.02	-42.83	-17.45	(a) $\pm 1850$ Hz at 512 Channel (b) $\pm 1880$ Hz at 661 Channel (c) $\pm 1910$ Hz at 810 Channel
2		-20°C	-36.79	-35.16	-20.39	
3		-10°C	-39.66	-29.85	-14.25	
4		0°C	-30.76	-27.73	-17.45	
5		+10°C	-36.52	-20.67	-21.39	
6		+20°C	-32.30	-32.88	-14.25	
7		+30°C	-36.08	-35.99	-45.65	
8		+40°C	-36.52	-35.28	-23.59	
9		+50°C	-27.45	-32.04	-50.90	
10	V-high	+22°C	-30.65	-36.88	-23.32	
11	V-low	+22°C	-22.59	-24.75	-20.85	

**Result: PASS**

**APPENDIX 1**  
**PHOTOGRAPHS OF TEST SETUP**

CONDUCTED TEST SETUP



RADIATED EMISSION TEST SETUP

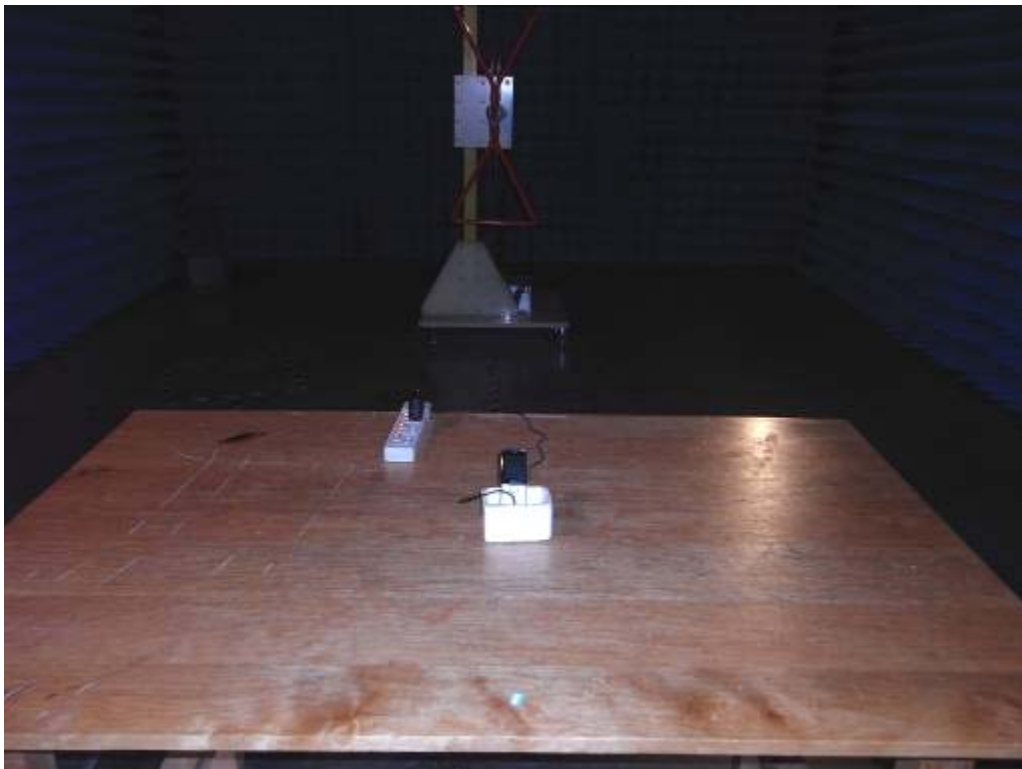



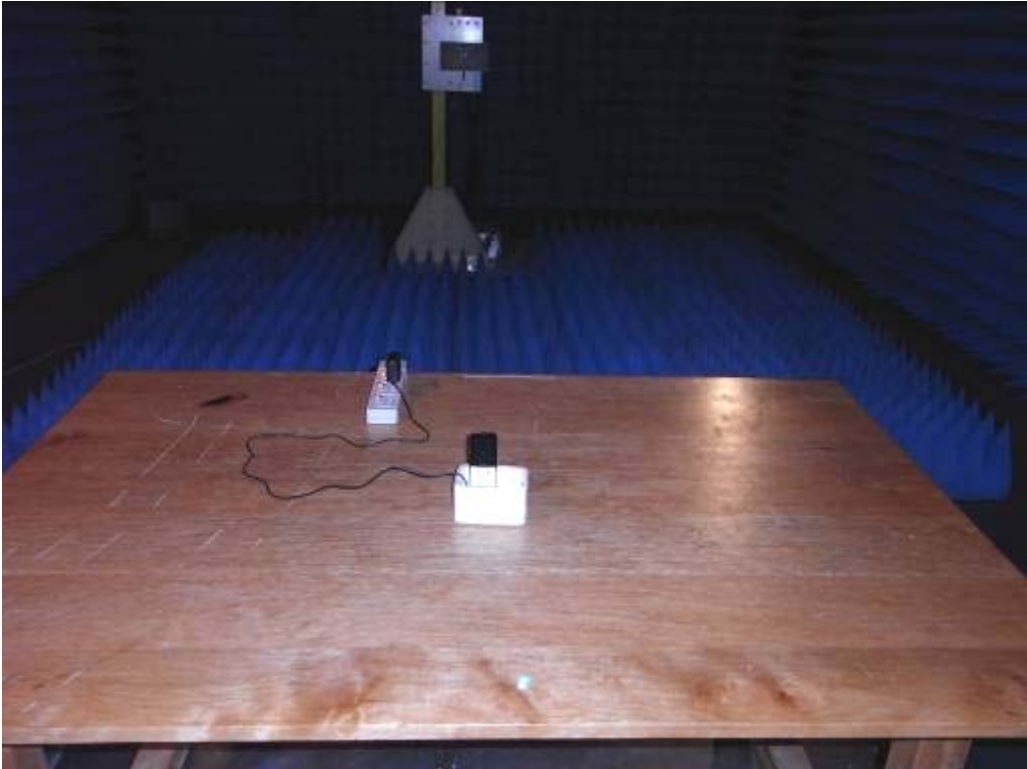

**APPENDIX 2  
PHOTOGRAPHS OF EUT**

FRONT VIEW OF SAMPLE



BACK VIEW OF SAMPLE



LEFT VIEW OF SAMPLE



RIGHT VIEW OF SAMPLE



TOP VIEW OF SAMPLE



BOTTOM VIEW OF SAMPLE



PHOTO OF POWER SUPPLY



PHOTO OF USB CABLE



PHOTO OF HEADPHONE



PHOTO OF BATTERY



PHOTO OF THE ENTIRE SAMPLE



INTERNAL PHOTO OF SAMPLE – 1

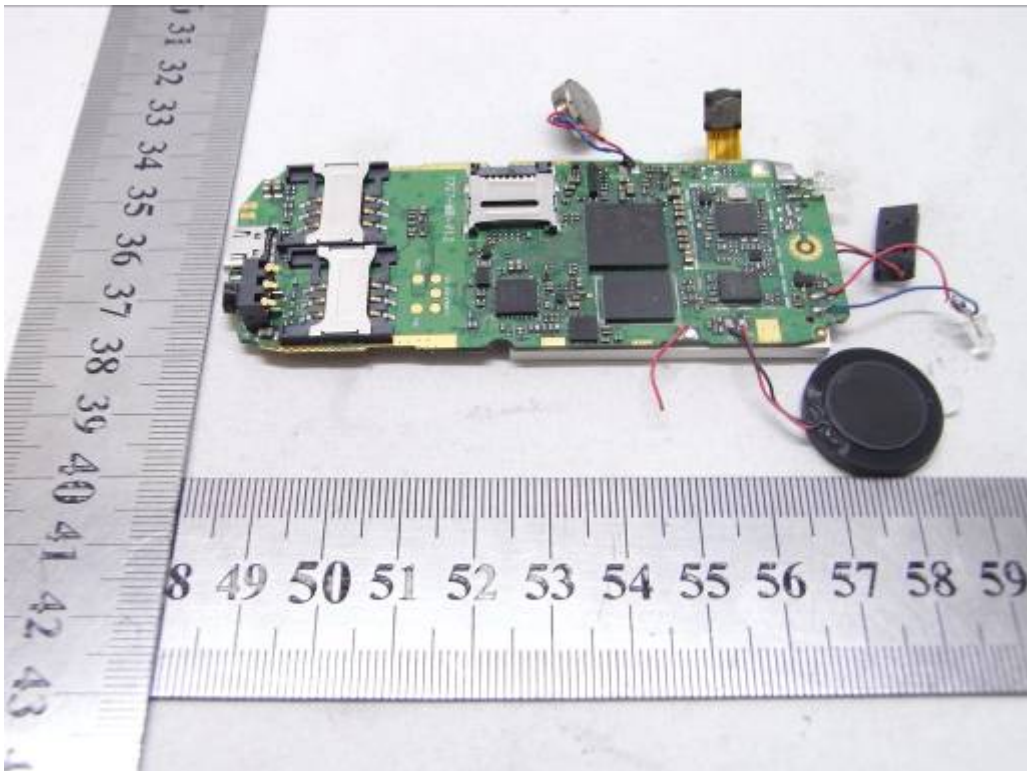



INTERNAL PHOTO OF SAMPLE -2

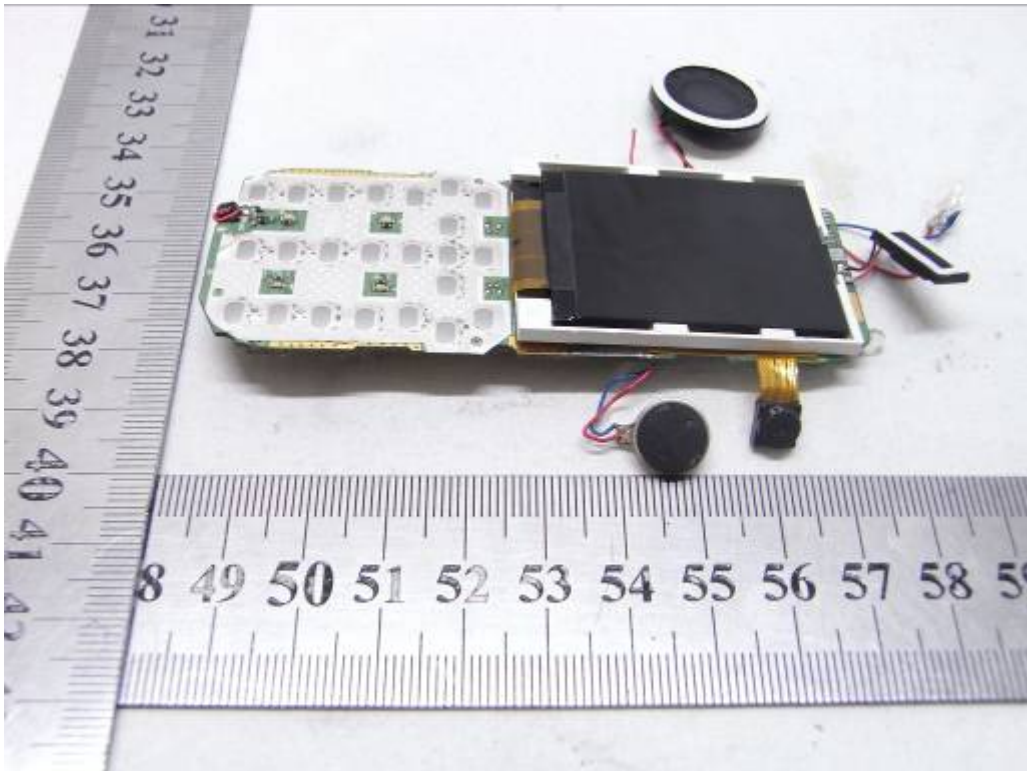

INTERNAL PHOTO OF SAMPLE -3

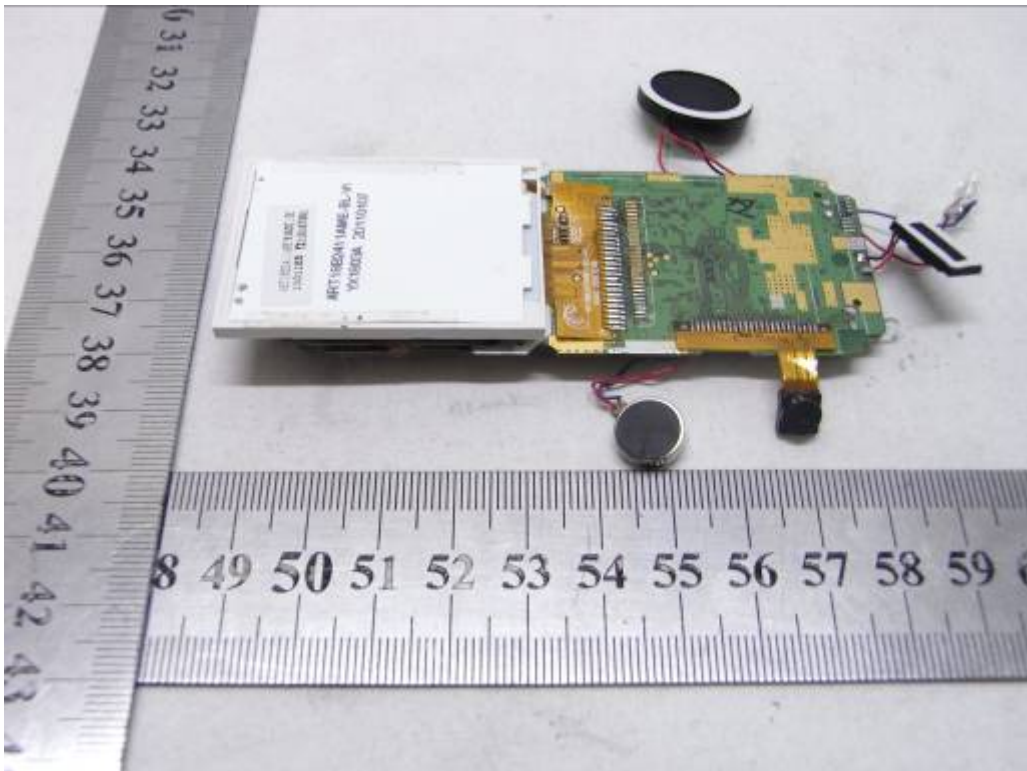

INTERNAL PHOTO OF POWER SUPPLY-1

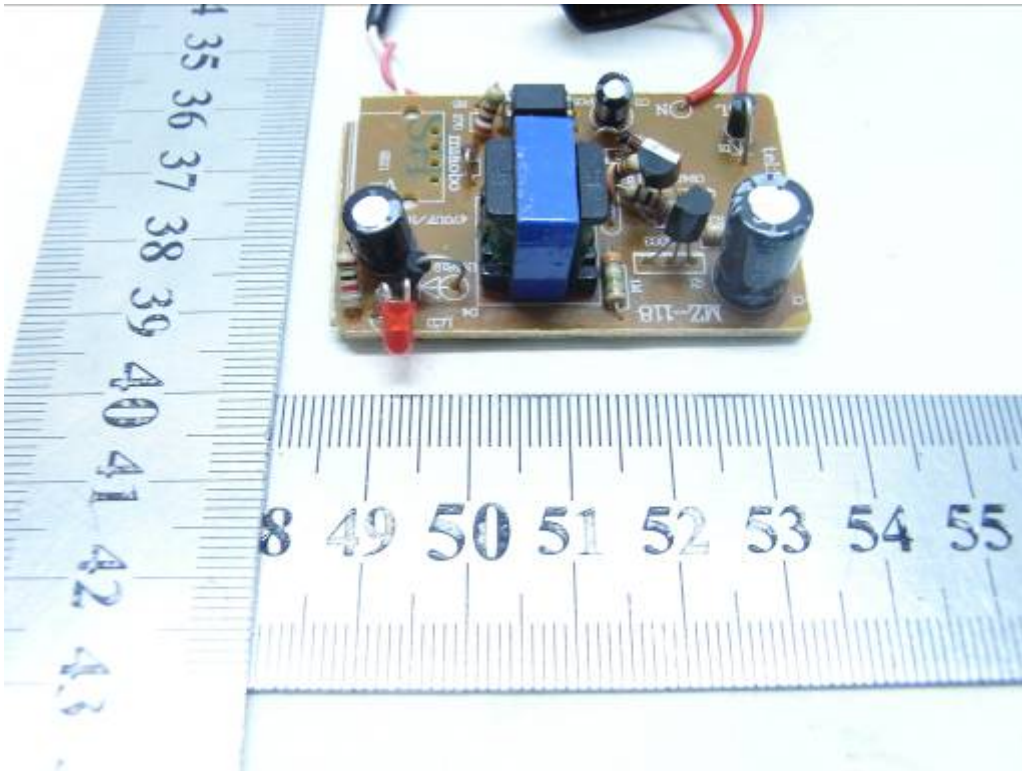

INTERNAL PHOTO OF POWER SUPPLY-2

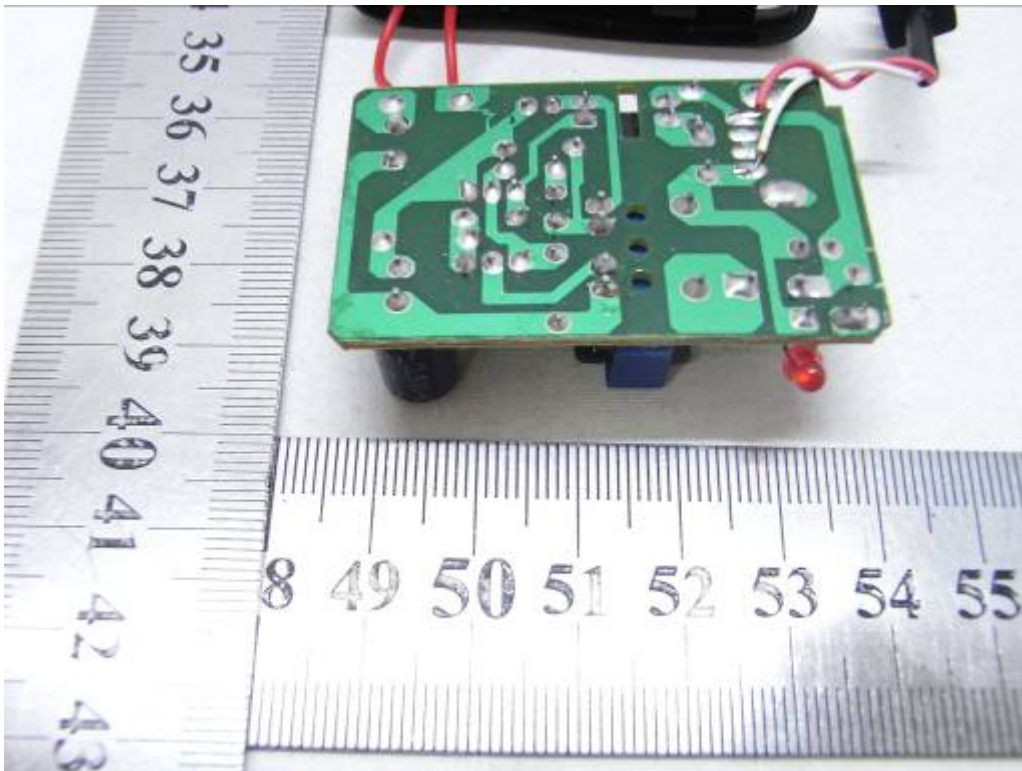

-----END OF REPORT-----