



ANSI/IEEE Std. C95.1-1992
In accordance with the requirements of
FCC Report and Order: ET Docket 93-62, and OET Bulletin 65 Supplement (

FCC SAR TEST REPORT

For

GSM Mobile Phone

Model: P008, C2

Trade Name: PLUM

Issued to

CLC Hong Kong Limited

**907 Hart Avenue Plaza, 5-9A Hart Avenue, Tsim Sha Tsui, Kowloon,
Hong Kong**

Issued by

Compliance Certification Services Inc.

Kunshan Laboratory

**No.10 Weiye Rd., Innovation park, Eco&Tec,
Development Zone, Kunshan City, Jiangsu, China**

TEL: 86-512-57355888

FAX: 86-512-57370818

<http://www.ccsrf.com>

service@ccsrf.com



Note: This report shall not be reproduced except in full, without the written approval of Compliance Certification Services Inc. This document may be altered or revised by Compliance Certification Services Inc. personnel only, and shall be noted in the revision section of the document.



TABLE OF CONTENTS

| | | |
|------------|---|-----------|
| 1. | CERTIFICATE OF COMPLIANCE (SAR EVALUATION) | 3 |
| 2. | EUT DESCRIPTION | 4 |
| 3. | REQUIREMENTS FOR COMPLIANCE TESTING DEFINED BY THE FCC | 5 |
| 4. | TEST METHODOLOGY | 5 |
| 5. | DOSIMETRIC ASSESSMENT SETUP | 5 |
| | 5.1 MEASUREMENT SYSTEM DIAGRAM | 6 |
| | 5.2 SYSTEM COMPONENTS | 7 |
| 6. | EVALUATION PROCEDURES | 10 |
| 7. | MEASUREMENT UNCERTAINTY | 14 |
| 8. | EXPOSURE LIMIT | 15 |
| 9. | EUT ARRANGEMENT | 16 |
| | 9.1 ANTHROPOMORPHIC HEAD PHANTOM..... | 16 |
| | 9.2 DEFINITION OF THE "CHEEK/TOUCH" POSITION..... | 17 |
| | 9.3 DEFINITION OF THE "TILTED" POSITION | 18 |
| 10. | MEASUREMENT RESULTS | 19 |
| | 10.1 TEST LIQUIDS CONFIRMATION..... | 19 |
| | 10.2 SYSTEM PERFORMANCE CHECK..... | 21 |
| | 10.3 EUT TUNE-UP PROCEDURES | 23 |
| | 10.4 KDB 648474 SAR HANDSETS MULTI XMITER ASSESSMENT | 24 |
| | 10.5 SAR MEASUREMENT RESULTS | 25 |
| 11. | EUT PHOTO | 29 |
| 12. | EQUIPMENT LIST & CALIBRATION STATUS | 33 |
| 13. | FACILITIES | 34 |
| 14. | REFERENCES | 34 |
| 15. | ATTACHMENTS | 35 |



1. CERTIFICATE OF COMPLIANCE (SAR EVALUATION)

Applicant: CLC Hong Kong Limited

907 Hart Avenue Plaza, 5-9A Hart Avenue, Tsim Sha Tsui, Kowloon,
Hong Kong

Manufacturer: C-LONGER ELECTRONIC CO., LTD

Room 1806, A Building, Jiahe Huaqiang, Huaqiangbei, Shenzhen China.

Equipment Under Test: GSM Mobile Phone

Trade Name: PLUM

Model Number: P008, C2

Devices supporting GPRS: Class B

Description Test Modes(worst case): The EUT was pretested, then the SIM1 was found to transmit the highest SAR value after tested dual SIM1 and SIM2.

Date of Test: January 24, 2011

Device Category: PORTABLE DEVICES

Exposure Category: GENERAL POPULATION/UNCONTROLLED EXPOSURE

Application Type: Certification

| APPLICABLE STANDARDS | |
|------------------------------------|-------------------------|
| STANDARD | TEST RESULT |
| FCC OET 65 Supplement C | No non-compliance noted |
| Deviation from Applicable Standard | |
| None | |

The device was tested by Compliance Certification Services Inc. in accordance with the measurement methods and procedures specified in OET Bulletin 65 Supplement C (Edition 01-01). The test results in this report apply only to the tested sample of the stated device/equipment. Other similar device/equipment will not necessarily produce the same results due to production tolerance and measurement uncertainties.

Approved by:

Vincent Yao
RF Manager
Compliance Certification Services Inc.

Sean Yu
Test Engineer
Compliance Certification Services Inc



2. EUT DESCRIPTION

| | | |
|--------------------------------|--|---|
| Product | GSM Mobile Phone | |
| Model Number | P008,C2 | |
| Trade Name | PLUM | |
| Model Discrepancy | Only the model name is different | |
| Frequency Range | GSM / GPRS: 850: 824.2 ~ 848.8 MHz GSM / GPRS: 1900: 1850.2 ~ 1909.8 MHz Bluetooth: 2402 ~ 2483.5 MHz | |
| Operating Mode | Maximum continuous output | |
| Transmit Power(Average) | 850 Band: GSM 850: 32.72 dBm GPRS 850: 31.87 dBm | 1900 Band: GSM 1900: 29.68 dBm GPRS 1900: 29.64 dBm |
| | Bluetooth (GFSK): -0.16 dBm Bluetooth (8DPSK): -2.45 dBm | |
| Max. SAR (1g): | GSM 850: Head: 0.55 W/kg (Left head Cheek position) Body: 0.37 W/kg (Body position) GPRS: 0.35 W/kg (Body position) PCS1900: Head: 0.56 W/kg (Left head Cheek position) Body: 0.35 W/kg (Body position) GPRS: 0.37 W/kg (Body position) Bluetooth: <i>SAR not required, please refer to page 25</i> | |
| Modulation Technique | GSM / PCS: GMSK Bluetooth: GFSK for 1Mbps; $\pi/4$ -DQPSK for 2Mbps; 8DPSK for 3Mbps | |
| Antenna Specification | Antenna. Type: GSM: PIFA antenna Bluetooth: PIFA antenna | |
| Accessories | Battery: NOMINAL VOLTAGE : 3.7V CAPACTIY:800mAh | |



3. REQUIREMENTS FOR COMPLIANCE TESTING DEFINED BY THE FCC

The US Federal Communications Commission has released the report and order "Guidelines for Evaluating the Environmental Effects of RF Radiation", ET Docket No. 93-62 in August 1996. The order requires routine SAR evaluation prior to equipment authorization of portable transmitter devices, including portable telephones. For consumer products, the applicable limit is 1.6 mW/g for an uncontrolled environment and 8.0 mW/g for an occupational/controlled environment as recommended by the ANSI/IEEE standard C95.1-1992. According to the Supplement C of OET Bulletin 65 "Evaluating Compliance with FCC Guide-lines for Human Exposure to Radio frequency Electromagnetic Fields", released on Jun 29, 2001 by the FCC, the device should be evaluated at maximum output power (radiated from the antenna) under "worst-case" conditions for normal or intended use, incorporating normal antenna operating positions, device peak performance frequencies and positions for maximum RF energy coupling.

4. TEST METHODOLOGY

The Specific Absorption Rate (SAR) testing specification, method and procedure for this Mobile Phone is in accordance with the following standards:

47 CFR Part 2 (2.1093)

OET Bulletin 65 Supplement C (Edition 01-01)

IEEE C95.1-1999

IEEE 1528 – 2003 IEEE Recommended Practice for Determining the Peak Spatial-Average Specific Absorption Rate (SAR) in the Human Head from Wireless Communications Devices: Measurement Technique

KDB 248227 D01 SAR measurement procedures for 802.11 a/b/g transmitters

KDB 648474 D01 SAR evaluation considerations for handsets with multiple transmitters and antennas

5. DOSIMETRIC ASSESSMENT SETUP

These measurements were performed with the automated near-field scanning system OPENSAR from ATENNESSA. The system is based on a high precision robot (working range greater than 0.9 m), which positions the probes with a positional repeatability of better than ± 0.02 mm. Special E- and H-field probes have been developed for measurements close to material discontinuity, the sensors of which are directly loaded with a Schottky diode and connected via highly resistive lines to the data acquisition unit. The SAR measurements were conducted with the dosimetric probe EP100 1109 (manufactured by SATIMO), designed in the classical triangular configuration and optimized for dosimetric evaluation. The probe has been calibrated according to the procedure described in [7] with accuracy of better than ±10%. The spherical isotropy was evaluated with the procedure described in [8] and found to be better than ±0.25 dB. The phantom used was the SAM Twin Phantom as described in FCC supplement C, IEEE1528 and CENELEC EN50361.

The Tissue simulation liquid used for each test is in according with the FCC OET65 supplement C as listed below.

| Ingredients (% by weight) | Frequency (MHz) | | | | | | | | | |
|------------------------------|--------------------|-------|-------|------|-------|-------|-------|------|------|------|
| | 450 | | 835 | | 915 | | 1900 | | 2450 | |
| Tissue Type | Head | Body | Head | Body | Head | Body | Head | Body | Head | Body |
| Water | 38.56 | 51.16 | 41.45 | 52.4 | 41.05 | 56.0 | 54.9 | 40.4 | 62.7 | 73.2 |
| Salt (NaCl) | 3.95 | 1.49 | 1.45 | 1.4 | 1.35 | 0.76 | 0.18 | 0.5 | 0.5 | 0.04 |
| Sugar | 56.32 | 46.78 | 56.0 | 45.0 | 56.5 | 41.76 | 0.0 | 58.0 | 0.0 | 0.0 |
| HEC | 0.98 | 0.52 | 1.0 | 1.0 | 1.0 | 1.21 | 0.0 | 1.0 | 0.0 | 0.0 |
| Bactericide | 0.19 | 0.05 | 0.1 | 0.1 | 0.1 | 0.27 | 0.0 | 0.1 | 0.0 | 0.0 |
| Triton X-100 | 0.0 | 0.0 | 0.0 | 0.0 | 0.0 | 0.0 | 0.0 | 0.0 | 36.8 | 0.0 |
| DGBE | 0.0 | 0.0 | 0.0 | 0.0 | 0.0 | 0.0 | 44.92 | 0.0 | 0.0 | 26.7 |
| Dielectric Constant | 43.42 | 58.0 | 42.54 | 56.1 | 42.0 | 56.8 | 39.9 | 54.0 | 39.8 | 52.5 |
| Conductivity (S/m) | 0.85 | 0.83 | 0.91 | 0.95 | 1.0 | 1.07 | 1.42 | 1.45 | 1.88 | 1.78 |



5.1 MEASUREMENT SYSTEM DIAGRAM

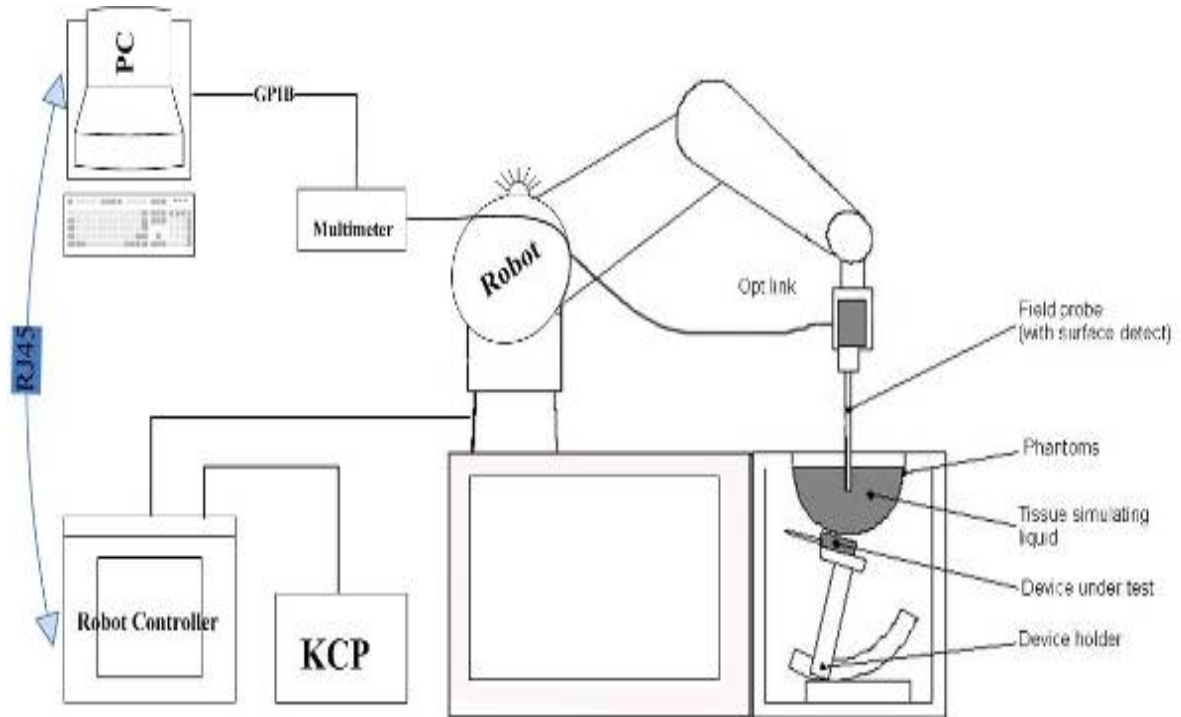

The OPENSAR system for performing compliance tests consists of the following items:

- A standard high precision 6-axis robot (KUKA) with controller and software.
- KUKA Control Panel (KCP).
- A dosimetric probe, i.e., an isotropic E-field probe optimized and calibrated for usage in tissue simulating liquid. The probe is equipped with an optical surface detector system.
- The functions of the PC plug-in card are to perform the time critical task such as signal filtering, surveillance of the robot operation fast movement interrupts.
- A computer operating Windows 95.
- OPENSAR software.
- Remote control with teaches pendant and additional circuitry for robot safety such as warning lamps, etc.
- The SAM phantom enabling testing left-hand right-hand and body usage.
- The Position device for handheld EUT.
- Tissue simulating liquid mixed according to the given recipes (see Application Note).
- System validation dipoles to validate the proper functioning of the system.



5.2 SYSTEM COMPONENTS

Comosar is a system that is able to determine the SAR distribution inside a phantom of human being according to different standards. The Comosar system consists of the following items:

- Main computer to control all the system
- 6 axis robot
- Data acquisition system
- Miniature E-field probe
- Phone holder
- Head simulating tissue

The following figure shows the system.

COMOSAR bench

The mobile phone under test operating at the maximum power level is placed in the phone holder, under the phantom, which is filled with head simulating liquid. The E-Field probe measures the electric field inside the phantom. The OpenSAR software computes the results to give a SAR value in a 1g or 10 g mass.



COMOSAR bench

Sam Phantom

The SAM Phantom SAM29 is constructed of a fiberglass shell integrated in a wooden table. The shape of the shell is in compliance with the specification set in IEEE P1528 and CENELEC EN62209-1. The phantom enables the dosimetric evaluation of left and right hand phone usage as well as body mounted usage at the flat phantom region. A cover prevents the evaporation of the liquid. Reference markings on the Phantom allow the complete setup of all predefined phantom positions and measurement grids by manually teaching three points in the robot.

Shell thickness: 2 mm +/-0.2 mm

Filling Volume: Approx. 25 liters

Dimensions (H x L x W): 810 x 1000 x 500 mm

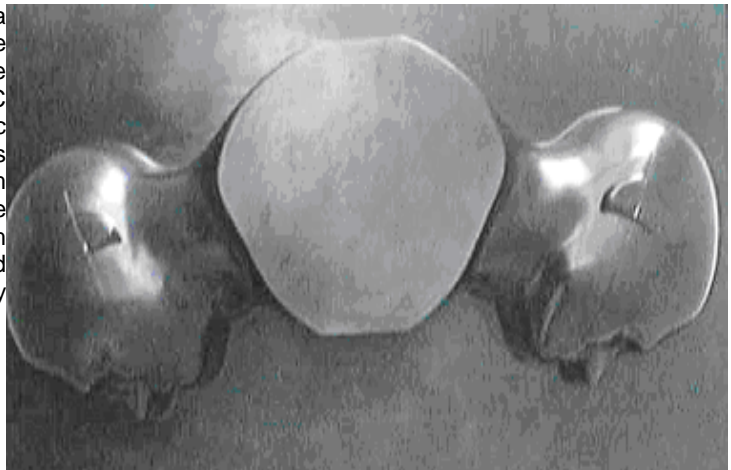

Probe

For the measurements the Specific Dosimetric E-Field Probe SN11/09 EP100 with following specifications is used.

Dynamic range: 0.01-100 W/kg

Tip Diameter : 5 mm

Distance between probe tip and sensor center: 2.5 mm

Distance between sensor center and inner phantom surface: 4 mm(repeatability better than +/- 1 mm)

Probe linearity : <0.25 dB

Axial Isotropy: <0.25 dB

Spherical Isotropy: <0.50 dB

Calibration range : 835 to 2500 MHz for head & body simulating liquid

Angle between probe axis (evaluation axis) and surface normal line : less than 30°

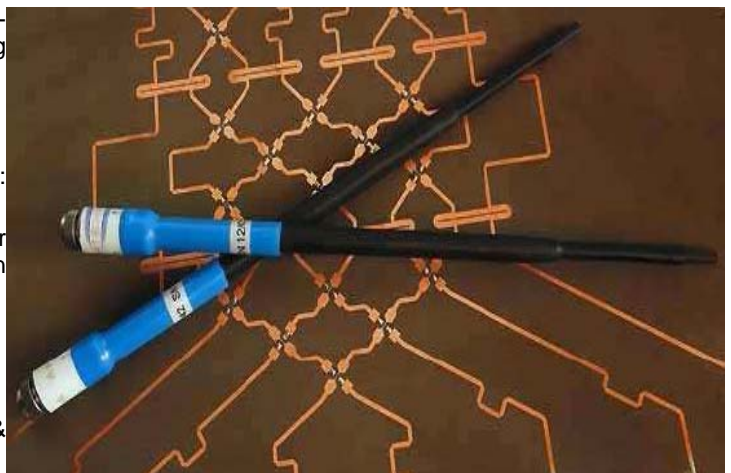



Keithley multimeter

In the measurement chain, the Keithley multimeter is located just after the probe. It measures voltages returned by each dipole, results are then sent to the PC on the GPIB interface.



Scan card

The scan card is an option of the multimeter to make measurements on several channels (10 channels in this case).

Antenna dosimetric probes are made of 3 orthogonal sensors. For each field measurement, three voltage values must be read. The scan card, controlled by the PC, will switch between the 3 channels.

The scan card is installed in the multimeter by Antenna and should not be removed without Antenna's approval.

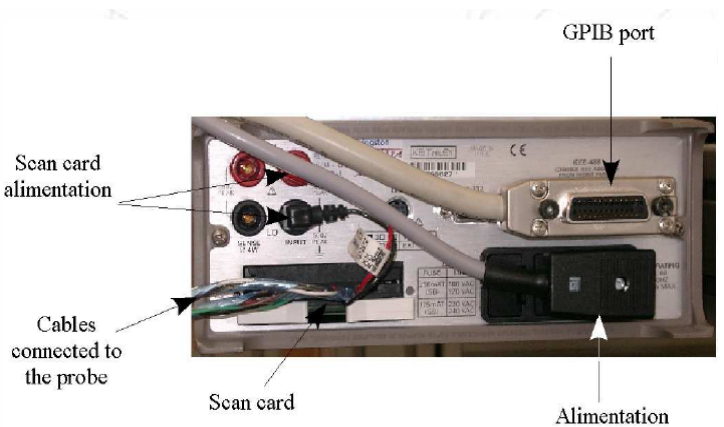

Device holder

The SAR value is approximately inversely proportional to the square of the distance between the source and the internal phantom surface. For a source at 5 mm distance, a positioning uncertainty of ± 0.5 mm would produce a SAR uncertainty of ± 20 %. An accurate device positioning is therefore essential for accurate and repeatable measurements.

This Positioning system allows the translation of the mobile phone along the x, y and z axis, as well as the required rotation around the phantom ear, for the 2 positions defined by standards (0° "cheek" position and 15° "tilt" position).

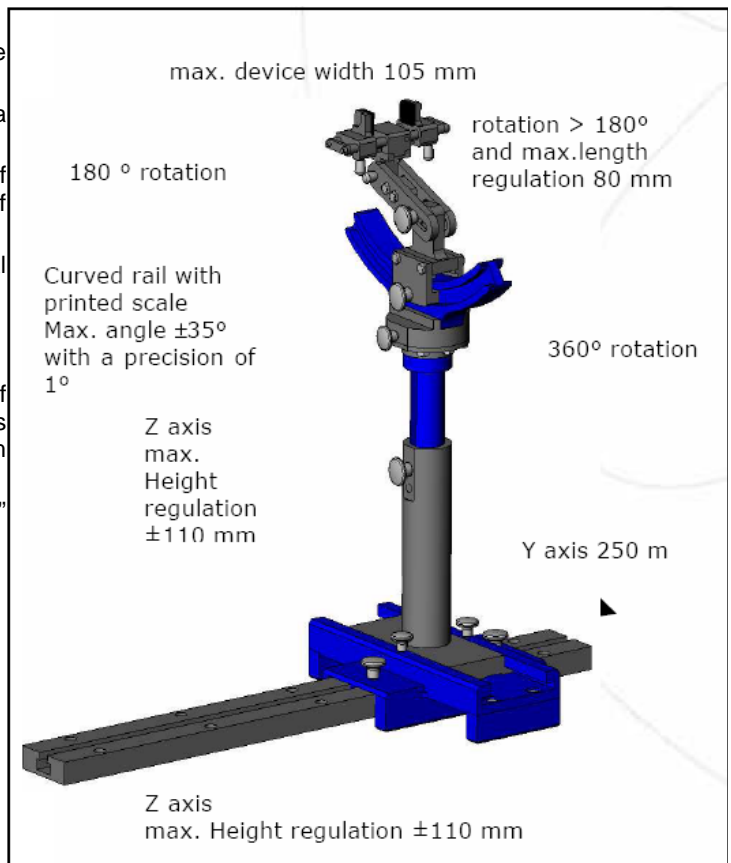



Validation dipoles

Frequencies:

Antenna has a full range of dipoles corresponding to the frequencies defines by the standards :835, 900, 1800, 1900, 2000, 2450MHz

Adaptation: S11 < -20dB in specified validation position.

Maximum input Power: 100W

Connectors: SMA

Dimensions: (depends on the dipole frequency)

Height : between 200 mm and 300 mm

Length : between 25 mm and 83 mm

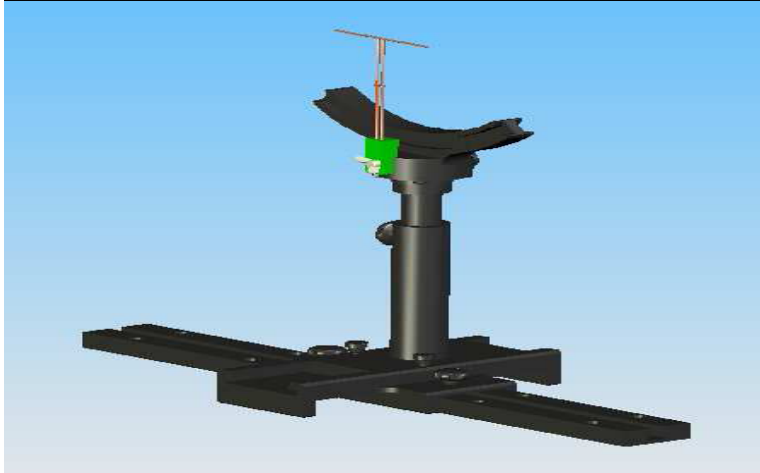

Positioning system for the validation dipole

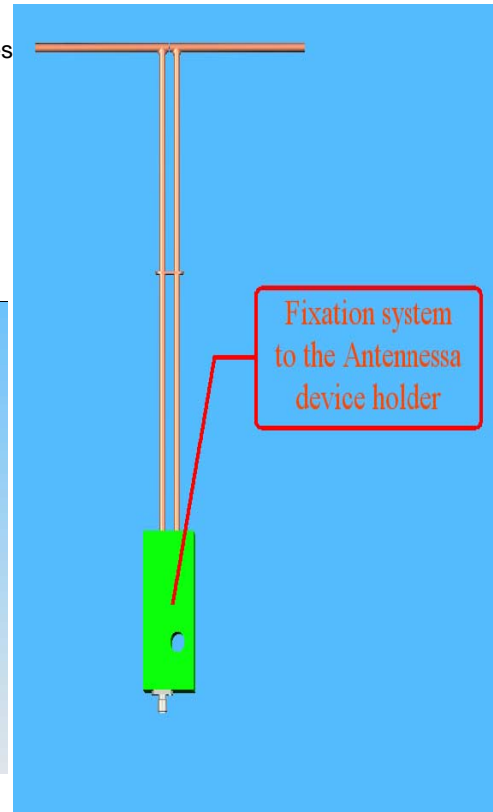



6. EVALUATION PROCEDURES

DATA EVALUATION

The COMOSAR post processing software (OPENSAR) automatically executes the following procedures to calculate the field units from the microvolt readings at the probe connector. The parameters used in the evaluation are stored in the configuration modules of the software:

| | | |
|--------------------|---------------------------|----------------------------------|
| Probe parameters: | - Sensitivity | $Norm_i, a_{i0}, a_{i1}, a_{i2}$ |
| | - Conversion factor | $ConvF_i$ |
| | - Diode compression point | dcp_i |
| Device parameters: | - Frequency | f |
| | - Crest factor | cf |
| Media parameters: | - Conductivity | σ |
| | - Density | ρ |

These parameters must be set correctly in the software. They can be found in the component documents or be imported into the software from the configuration files issued for the COMOSAR components. In the direct measuring mode of the multi-meter option, the parameters of the actual system setup are used. In the scan visualization and export modes, the parameters stored in the corresponding document files are used.

The first step of the evaluation is a linearization of the filtered input signal to account for the compression characteristics of the detector diode. The compensation depends on the input signal, the diode type and the DC-transmission factor from the diode to the evaluation electronics. If the exciting field is pulsed, the crest factor of the signal must be known to correctly compensate for peak power. The formula for each channel can be given as:

$$V_i = U_i + U_i^2 \cdot \frac{cf}{dcp_i}$$

| | | | |
|------|---------|-----------------------------------|---------------------|
| with | V_i | = Compensated signal of channel i | (i = x, y, z) |
| | U_i | = Input signal of channel i | (i = x, y, z) |
| | cf | = Crest factor of exciting field | (COMOSAR parameter) |
| | dcp_i | = Diode compression point | (COMOSAR parameter) |

From the compensated input signals the primary field data for each channel can be evaluated:

E-field probes:

$$E_i = \sqrt{\frac{V_i}{Norm_i \cdot ConvF}}$$

H-field probes:

$$H_i = \sqrt{V_i} \cdot \frac{a_{i10} + a_{i11}f + a_{i12}f^2}{f}$$

| | | | |
|------|----------|---|---------------|
| with | V_i | = Compensated signal of channel i | (i = x, y, z) |
| | $Norm_i$ | = Sensor sensitivity of channel i | (i = x, y, z) |
| | | $\mu V/(V/m)^2$ for E0field Probes | |
| | $ConvF$ | = Sensitivity enhancement in solution | |
| | aij | = Sensor sensitivity factors for H-field probes | |
| | f | = Carrier frequency (GHz) | |
| | E_i | = Electric field strength of channel i in V/m | |
| | H_i | = Magnetic field strength of channel i in A/m | |

The RSS value of the field components gives the total field strength (Hermitian magnitude):

$$E_{tot} = \sqrt{E_x^2 + E_y^2 + E_z^2}$$

The primary field data are used to calculate the derived field units.



$$SAR = E_{tot}^2 \cdot \frac{\sigma}{\rho \cdot 1000}$$

- with SAR = local specific absorption rate in mW/g
 E_{tot} = total field strength in V/m
 σ = conductivity in [mho/m] or [Siemens/m]
 ρ = equivalent tissue density in g/cm³

Note that the density is normally set to 1 (or 1.06), to account for actual brain density rather than the density of the simulation liquid.

The power flow density is calculated assuming the excitation field as a free space field.

$$P_{pwe} = \frac{E_{tot}^2}{3770} \quad \text{or} \quad P_{pwe} = H_{tot}^2 \cdot 37.7$$

- with P_{pwe} = Equivalent power density of a plane wave in mW/cm²
 E_{tot} = total electric field strength in V/m
 H_{tot} = total magnetic field strength in A/m



SAR EVALUATION PROCEDURES

The procedure for assessing the peak spatial-average SAR value consists of the following steps:

- **Power Reference Measurement**

The reference and drift jobs are useful jobs for monitoring the power drift of the device under test in the batch process. Both jobs measure the field at a specified reference position, at a selectable distance from the phantom surface. The reference position can be either the selected section's grid reference point or a user point in this section. The reference job projects the selected point onto the phantom surface, orients the probe perpendicularly to the surface, and approaches the surface using the selected detection method.

- **Area Scan**

The area scan is used as a fast scan in two dimensions to find the area of high field values, before doing a finer measurement around the hot spot. The sophisticated interpolation routines implemented in COMOSAR software can find the maximum locations even in relatively coarse grids. The scan area is defined by an editable grid. This grid is anchored at the grid reference point of the selected section in the phantom. When the area scan's property sheet is brought-up, grid was at to 15 mm by 15 mm and can be edited by a user.

- **Zoom Scan**

Zoom scans are used to assess the peak spatial SAR values within a cubic averaging volume containing 1 g and 10 g of simulated tissue. The default zoom scan measures 7 x 7 x 9 points within a cube whose base faces are centered around the maximum found in a preceding area scan job within the same procedure. If the preceding Area Scan job indicates more than one maximum, the number of Zoom Scans has to be enlarged accordingly (The default number inserted is 1).

- **Power Drift measurement**

The drift job measures the field at the same location as the most recent reference job within the same procedure, and with the same settings. The drift measurement gives the field difference in dB from the reading conducted within the last reference measurement. Several drift measurements are possible for one reference measurement. This allows a user to monitor the power drift of the device under test within a batch process. In the properties of the Drift job, the user can specify a limit for the drift and have COMOSAR software stop the measurements if this limit is exceeded.



SPATIAL PEAK SAR EVALUATION

The procedure for spatial peak SAR evaluation has been implemented according to the IEEE1529 standard. It can be conducted for 1 g and 10 g.

The COMOSAR system allows evaluations that combine measured data and robot positions, such as:

- maximum search
- extrapolation
- boundary correction
- peak search for averaged SAR

During a maximum search, global and local maximum searches are automatically performed in 2-D after each Area Scan measurement with at least 6 measurement points. It is based on the evaluation of the local SAR gradient calculated by the Quadratic Shepard's method. The algorithm will find the global maximum and all local maxima within -2 dB of the global maxima for all SAR distributions.

Extrapolation

Extrapolation routines are used to obtain SAR values between the lowest measurement points and the inner phantom surface. The extrapolation distance is determined by the surface detection distance and the probe sensor offset. Several measurements at different distances are necessary for the extrapolation.

Extrapolation routines require at least 10 measurement points in 3-D space. They are used in the Cube Scan to obtain SAR values between the lowest measurement points and the inner phantom surface. The routine uses the modified Quadratic Shepard's method for extrapolation. For a grid using 7x7x9 measurement points with 5mm resolution amounting to 441 measurement points, the uncertainty of the extrapolation routines is less than 1% for 1 g and 10 g cubes.

Boundary effect

For measurements in the immediate vicinity of a phantom surface, the field coupling effects between the probe and the boundary influence the probe characteristics. Boundary effect errors of different dosimetric probe types have been analyzed by measurements and using a numerical probe model. As expected, both methods showed an enhanced sensitivity in the immediate vicinity of the boundary. The effect strongly depends on the probe dimensions and disappears with increasing distance from the boundary. The sensitivity can be approximately given as:

$$S \approx S_o + S_b \exp\left(-\frac{z}{a}\right) \cos\left(\pi \frac{z}{\lambda}\right)$$

Since the decay of the boundary effect dominates for small probes ($a \ll \lambda$), the cos-term can be omitted. Factors S_b (parameter Alpha in the COMOSAR software) and a (parameter Delta in the COMOSAR software) are assessed during probe calibration and used for numerical compensation of the boundary effect. Several simulations and measurements have confirmed that the compensation is valid for different field and boundary configurations.

This simple compensation procedure can largely reduce the probe uncertainty near boundaries. It works well as long as:

- the boundary curvature is small
- the probe axis is angled less than 30° to the boundary normal
- the distance between probe and boundary is larger than 25% of the probe diameter
- the probe is symmetric (all sensors have the same offset from the probe tip)

Since all of these requirements are fulfilled in a COMOSAR system, the correction of the probe boundary effect in the vicinity of the phantom surface is performed in a fully automated manner via the measurement data extraction during post processing.



7. MEASUREMENT UNCERTAINTY

| Uncertainty Component | Sec. | Tol (+-%) | Prob. Dist. | Div. | Ci (1g) | Ci (10g) | 1g Ui (+-%) | 10g Ui (+-%) | Vi |
|---|-------|-----------|-------------|------------|-----------------|-----------------|-------------|--------------|-----|
| Measurement System | | | | | | | | | |
| Probe calibration | E.2.1 | 4.7 | N | 1.0 | 1.0 | 1.0 | 4.7 | 4.7 | ∞ |
| Axial Isotropy | E.2.2 | 2.5 | R | $\sqrt{3}$ | $(1-C_p)^{1/2}$ | $(1-C_p)^{1/2}$ | 1.0 | 1.0 | ∞ |
| Hemispherical Isotropy | E.2.2 | 4.0 | R | $\sqrt{3}$ | $\sqrt{C_p}$ | $\sqrt{C_p}$ | 1.6 | 1.6 | ∞ |
| Boundary effect | E.2.3 | 1.0 | R | $\sqrt{3}$ | 1.0 | 1.0 | 0.6 | 0.6 | ∞ |
| Linearity | E.2.4 | 5.0 | R | $\sqrt{3}$ | 1.0 | 1.0 | 2.9 | 2.9 | ∞ |
| System detection limits | E.2.5 | 1.0 | R | $\sqrt{3}$ | 1.0 | 1.0 | 0.6 | 0.6 | ∞ |
| Readout Electronics | E.2.6 | 1.0 | N | 1 | 1.0 | 1.0 | 1.0 | 1.0 | ∞ |
| Reponse Time | E.2.7 | 0.8 | R | $\sqrt{3}$ | 1.0 | 1.0 | 0.5 | 0.5 | ∞ |
| Integration Time | E.2.8 | 2.0 | R | $\sqrt{3}$ | 1.0 | 1.0 | 1.2 | 1.2 | ∞ |
| RF ambient Conditions-Noise | E.6.1 | 3.0 | R | $\sqrt{3}$ | 1.0 | 1.0 | 1.7 | 1.7 | ∞ |
| RF ambient Conditions-Reflections | E.6.1 | 3.0 | R | $\sqrt{3}$ | 1.0 | 1.0 | 1.7 | 1.7 | ∞ |
| Probe positioner Mechanical Tolerance | E.6.2 | 2.0 | R | $\sqrt{3}$ | 1.0 | 1.0 | 1.2 | 1.2 | ∞ |
| Probe positioning with respect to Phantom Shell | E.6.3 | 0.4 | R | $\sqrt{3}$ | 1.0 | 1.0 | 0.2 | 0.2 | ∞ |
| Extrapolation, interpolation and integration Algorithms for Max. SAR Evaluation | E.5 | 1.0 | R | $\sqrt{3}$ | 1.0 | 1.0 | 0.6 | 0.6 | ∞ |
| Test sample Related | | | | | | | | | |
| Test Sample Positioning | E.4.2 | 1.1 | N | 1.0 | 1.0 | 1.0 | 1.1 | 1.1 | N-1 |
| Device Holder Uncertainty | E.4.1 | 5.0 | N | 1.0 | 1.0 | V | 5.0 | 5.0 | N-1 |
| Output Power Variation - SAR drift measurement | 6.6.2 | 1.0 | R | $\sqrt{3}$ | 1.0 | 1.0 | 1.7 | 1.7 | ∞ |
| Phantom and Tissue Parameters | | | | | | | | | |
| Phantom Uncertainty (Shape and thickness tolerances) | E.3.1 | 4.0 | R | $\sqrt{3}$ | 1.0 | 1.0 | 2.3 | 2.3 | ∞ |
| Liquid conductivity - deviation from target value | E.3.2 | 5.0 | R | $\sqrt{3}$ | 0.6 | 0.4 | 1.8 | 1.2 | ∞ |
| Liquid conductivity - measurement uncertainty | E.3.3 | 5.0 | N | 1.0 | 0.6 | 0.4 | 3.2 | 2.2 | M |
| Liquid permittivity - deviation from target value | E.3.2 | 3.0 | R | $\sqrt{3}$ | 0.6 | 0.5 | 1.0 | 0.9 | ∞ |
| Liquid permittivity - measurement uncertainty | E.3.3 | 2.5 | N | 1.0 | 0.6 | 0.5 | 1.5 | 1.2 | M |
| Combined Standard Uncertainty | | | RSS | | | | 9.8 | 9.5 | |
| Expanded Uncertainty (95% Confidence interval) | | | K | | | | 19.6 | 19.0 | |



8. EXPOSURE LIMIT

(A). Limits for Occupational/Controlled Exposure (W/kg)

| Whole-Body | Partial-Body | Hands, Wrists, Feet and Ankles |
|------------|--------------|--------------------------------|
| 0.4 | 8.0 | 20.0 |

(B). Limits for General Population/Uncontrolled Exposure (W/kg)

| Whole-Body | Partial-Body | Hands, Wrists, Feet and Ankles |
|------------|--------------|--------------------------------|
| 0.08 | 1.6 | 4.0 |

NOTE: **Whole-Body SAR** is averaged over the entire body, **partial-body SAR** is averaged over any 1 gram of tissue defined as a tissue volume in the shape of a cube. **SAR for hands, wrists, feet and ankles** is averaged over any 10 grams of tissue defined as a tissue volume in the shape of a cube.

Population/Uncontrolled Environments:

are defined as locations where there is the exposure of individuals who have no knowledge or control of their exposure.

Occupational/Controlled Environments:

are defined as locations where there is exposure that may be incurred by people who are aware of the potential for exposure, (i.e. as a result of employment or occupation).

NOTE
GENERAL POPULATION/UNCONTROLLED EXPOSURE
PARTIAL BODY LIMIT
1.6 W/kg



9. EUT ARRANGEMENT

Please refer to IEEE P1528 illustration below.

9.1 ANTHROPOMORPHIC HEAD PHANTOM

Figure 7-1a shows the front, back and side views of SAM. The point “M” is the reference point for the center of mouth, “LE” is the left ear reference point (ERP), and “RE” is the right ERP. The ERPs are 15 mm posterior to the entrance to ear canal (EEC) along the B-M line (Back-Mouth), as shown in Figure 7-1b. The plane passing through the two ear reference points and M is defined as the Reference Plane. The line N-F (Neck-Front) perpendicular to the reference plane and passing through the RE (or LE) is called the Reference Pivoting Line (see Figure 7-1c). Line B-M is perpendicular to the N-F line. Both N-F and B-M lines should be marked on the external phantom shell to facilitate handset positioning. Posterior to the N-F line, the thickness of the phantom shell with the shape of an ear is a flat surface 6 mm thick at the ERPs. Anterior to the N-F line, the ear is truncated as illustrated in Figure 7-1b. The ear truncation is introduced to avoid the handset from touching the ear lobe, which can cause unstable handset positioning at the cheek.

Figure 7-1a

Front, back and side view of SAM (model for the phantom shell)

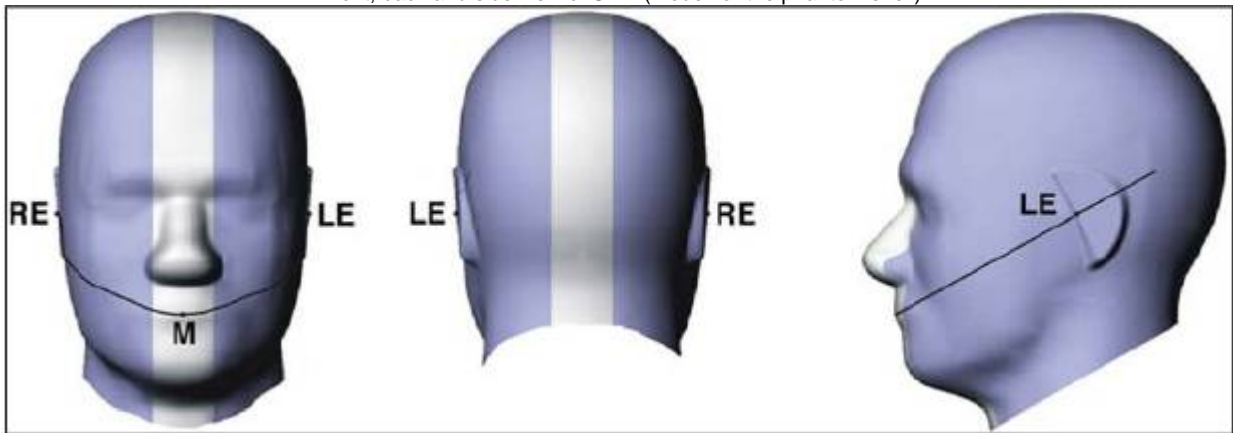

Figure 7-1b

Close up side view of phantom showing the ear region

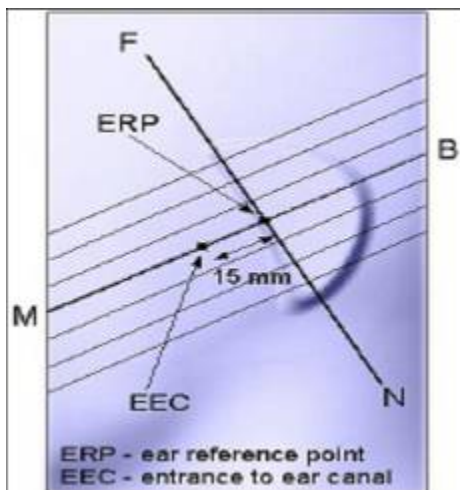

Figure 7-1b

Close up side view of phantom showing the ear region

Figure 7-1c

Side view of the phantom showing relevant markings and the 7 cross sectional plane locations

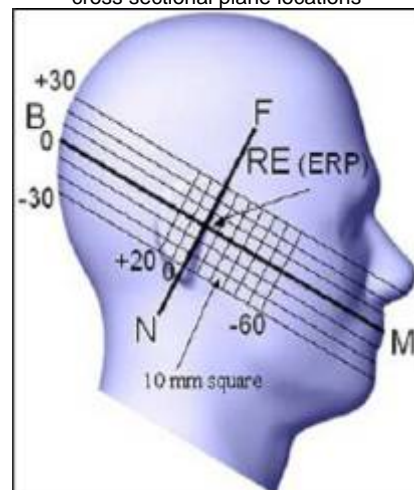

Figure 7-1c

Side view of the phantom showing relevant markings and the 7 cross-sectional plane locations



9.2 DEFINITION OF THE “CHEEK/TOUCH” POSITION

The “cheek” or “touch” position is defined as follows:

- a. Ready the handset for talk operation, if necessary. For example, for handsets with a cover piece, open the cover. (If the handset can also be used with the cover closed both configurations must be tested.)
- b. Define two imaginary lines on the handset: the vertical centerline and the horizontal line. The vertical centerline passes through two points on the front side of the handset: the midpoint of the width w_t of the handset at the level of the acoustic output (point A on Figures 7-2a and 7-2b), and the midpoint of the width w_b of the bottom of the handset (point B). The horizontal line is perpendicular to the vertical centerline and passes through the center of the acoustic output (see Figure 7-2a). The two lines intersect at point A. Note that for many handsets, point A coincides with the center of the acoustic output. However, the acoustic output may be located elsewhere on the horizontal line. Also note that the vertical centerline is not necessarily parallel to the front face of the handset (see Figure 7-2b), especially for clamshell handsets, handsets with flip pieces, and other irregularly-shaped handsets.
- c. Position the handset close to the surface of the phantom such that point A is on the (virtual) extension of the line passing through points RE and LE on the phantom (see Figure 7-2c), such that the plane defined by the vertical center line and the horizontal line of the handset is approximately parallel to the sagittal plane of the phantom.
- d. Translate the handset towards the phantom along the line passing through RE and LE until the handset touches the pinna.
- e. e) While maintaining the handset in this plane, rotate it around the LE-RE line until the vertical centerline is in the plane normal to MB-NF including the line MB (called the reference plane).
- f. Rotate the handset around the vertical centerline until the handset (horizontal line) is symmetrical with respect to the line NF.
- g. While maintaining the vertical centerline in the reference plane, keeping point A on the line passing through RE and LE and maintaining the handset contact with the pinna, rotate the handset about the line NF until any point on the handset is in contact with a phantom point below the pinna (cheek). See Figure 7-2c. The physical angles of rotation should be noted.

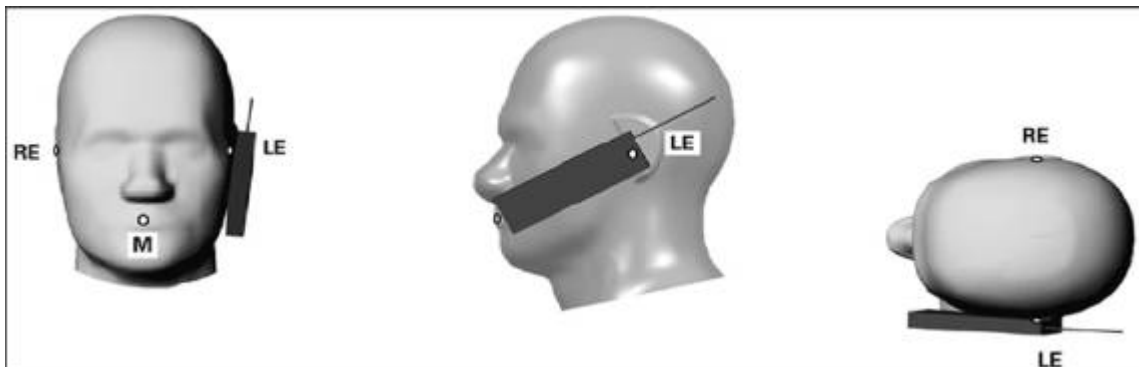

Figure 7.2c

Phone “cheek” or “touch” position. The reference points for the right ear (RE), left ear (LE) and mouth (M), which define the reference plane for handset positioning, are indicated.

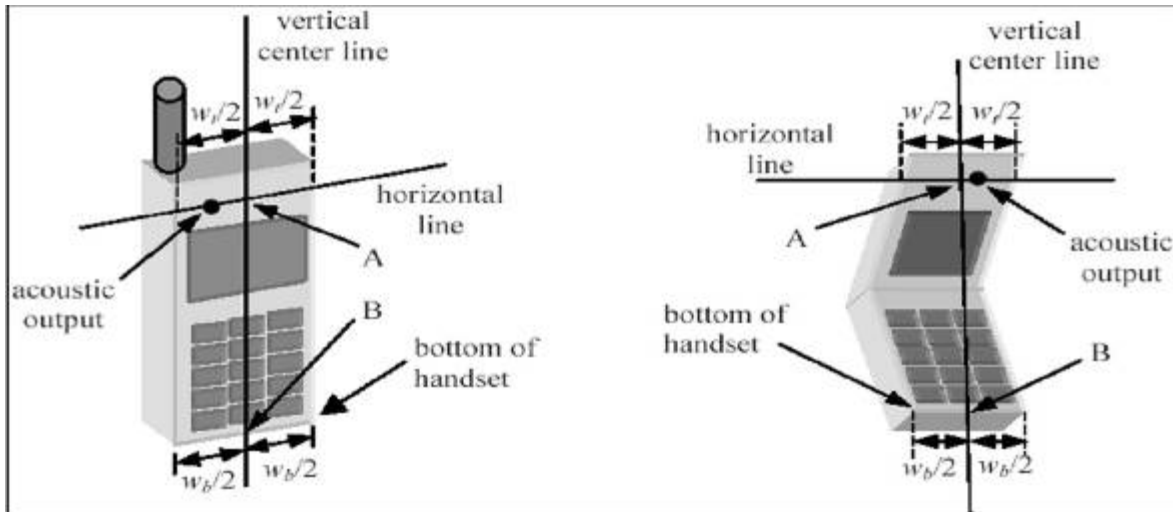

Figure 7.2a

Figure 7.2b

9.3 DEFINITION OF THE “TILTED” POSITION

The “tilted” position is defined as follows:

- Repeat steps (a) – (g) of 7.2 to place the device in the “cheek position.”
- While maintaining the orientation of the handset move the handset away from the pinna along the line passing through RE and LE in order to enable a rotation of the handset by 15 degrees.
- Rotate the handset around the horizontal line by 15 degrees.
- While maintaining the orientation of the handset, move the handset towards the phantom on a line passing through RE and LE until any part of the handset touches the ear. The tilted position is obtained when the contact is on the pinna. If the contact is at any location other than the pinna (e.g., the antenna with the back of the phantom head), the angle of the handset should be reduced. In this case, the tilted position is obtained if any part of the handset is in contact with the pinna as well as a second part of the handset is contact with the phantom (e.g., the antenna with the back of the head).

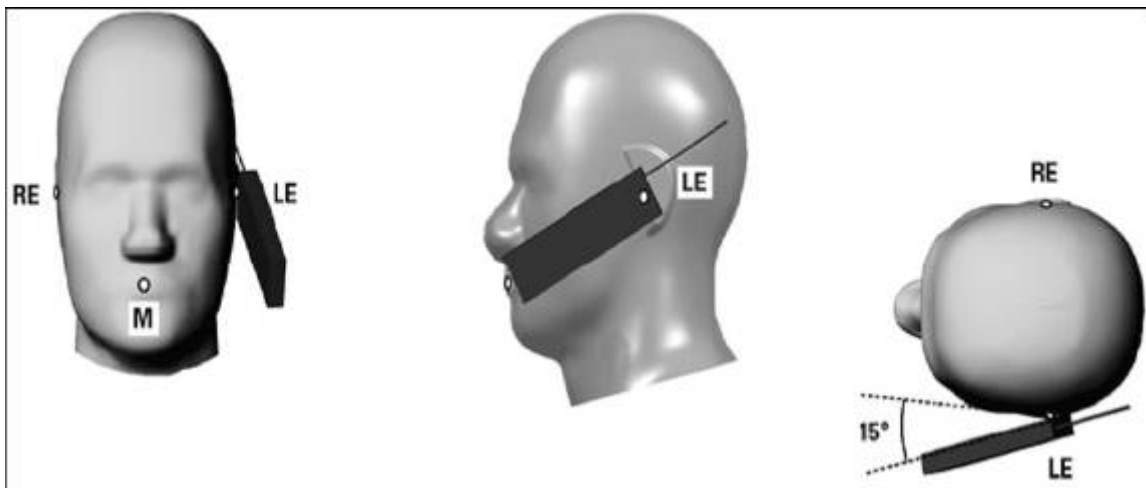

Figure 7-3

Phone “tilted” position. The reference points for the right ear (RE), left ear (LE) and mouth (M), which define the reference plane for handset positioning, are indicated.



10. MEASUREMENT RESULTS

10.1 TEST LIQUIDS CONFIRMATION

SIMULATING LIQUIDS PARAMETER CHECK

The simulating liquids should be checked at the beginning of a series of SAR measurements to determine if the dielectric parameters are within the tolerances of the specified target values

The relative permittivity and conductivity of the tissue material should be within $\pm 5\%$ of the values given in the table below. 5% may not be easily achieved at certain frequencies. Under such circumstances, 10% tolerance may be used until more precise tissue recipes are available

IEEE SCC-34/SC-2 P1528 RECOMMENDED TISSUE DIELECTRIC PARAMETERS

The head tissue dielectric parameters recommended by the IEEE SCC-34/SC-2 in P1528 have been incorporated in the following table. These head parameters are derived from planar layer models simulating the highest expected SAR for the dielectric properties and tissue thickness variations in a human head. Other head and body tissue parameters that have not been specified in P1528 are derived from the tissue dielectric parameters computed from the 4-Cole-Cole equations and extrapolated according to the head parameters specified in P1528

| Target Frequency (MHz) | Head | | Body | |
|------------------------|--------------|----------------|--------------|----------------|
| | ϵ_r | σ (S/m) | ϵ_r | σ (S/m) |
| 150 | 52.3 | 0.76 | 61.9 | 0.80 |
| 300 | 45.3 | 0.87 | 58.2 | 0.92 |
| 450 | 43.5 | 0.87 | 56.7 | 0.94 |
| 835 | 41.5 | 0.90 | 55.2 | 0.97 |
| 900 | 41.5 | 0.97 | 55.0 | 1.05 |
| 915 | 41.5 | 0.98 | 55.0 | 1.06 |
| 1450 | 40.5 | 1.20 | 54.0 | 1.30 |
| 1610 | 40.3 | 1.29 | 53.8 | 1.40 |
| 1800-2000 | 40.0 | 1.40 | 53.3 | 1.52 |
| 2450 | 39.2 | 1.80 | 52.7 | 1.95 |
| 3000 | 38.5 | 2.40 | 52.0 | 2.73 |
| 5800 | 45.3 | 5.27 | 48.2 | 6.00 |

(ϵ_r = relative permittivity, σ = conductivity and $\rho = 1000 \text{ kg/m}^3$)



LIQUID MEASUREMENT RESULTS

Date: January 24, 2011

Ambient condition: Temperature 22°C; Relative humidity: 57%

| Head Simulating Liquid | | | Parameters | Target | Measured | Deviation[%] | Limited[%] |
|------------------------|------------|------------|---------------|--------|----------|--------------|------------|
| Frequency | Temp. [°C] | Depth [cm] | | | | | |
| 835 MHz | 20.50 | 15.00 | Permittivity: | 41.50 | 42.06 | 1.35 | ±5 |
| | | | Conductivity: | 0.90 | 0.87 | -3.33 | ±5 |

Date: January 24, 2011

Ambient condition: Temperature 22°C; Relative humidity: 57%

| Body Simulating Liquid | | | Parameters | Target | Measured | Deviation[%] | Limited[%] |
|------------------------|------------|------------|---------------|--------|----------|--------------|------------|
| Frequency | Temp. [°C] | Depth [cm] | | | | | |
| 835 MHz | 20.50 | 15.00 | Permittivity: | 55.20 | 54.24 | -1.74 | ±5 |
| | | | Conductivity: | 0.97 | 0.99 | 2.06 | ±5 |

Date: January 24, 2011

Ambient condition: Temperature 22°C; Relative humidity: 57%

| Head Simulating Liquid | | | Parameters | Target | Measured | Deviation[%] | Limited[%] |
|------------------------|------------|------------|---------------|--------|----------|--------------|------------|
| Frequency | Temp. [°C] | Depth (cm) | | | | | |
| 1900 MHz | 20.50 | 15.00 | Permittivity: | 40.00 | 39.87 | -0.33 | ±5 |
| | | | Conductivity: | 1.40 | 1.42 | 1.43 | ±5 |

Date: January 24, 2011

Ambient condition: Temperature 22°C; Relative humidity: 57%

| Body Simulating Liquid | | | Parameters | Target | Measured | Deviation[%] | Limited[%] |
|------------------------|------------|------------|---------------|--------|----------|--------------|------------|
| Frequency | Temp. [°C] | Depth (cm) | | | | | |
| 1900 MHz | 20.50 | 15.00 | Permittivity: | 53.30 | 53.68 | 0.71 | ±5 |
| | | | Conductivity: | 1.52 | 1.47 | -3.29 | ±5 |



10.2 SYSTEM PERFORMANCE CHECK

The system performance check is performed prior to any usage of the system in order to guarantee reproducible results. The system performance check verifies that the system operates within its specifications of $\pm 10\%$. The system performance check results are tabulated below. And also the corresponding SAR plot is attached as well in the SAR plots files.

IEEE P1528 Recommended Reference Value

| Frequency (MHz) | 1 g SAR | 10 g SAR | Local SAR at surface (Above feed point) | Local SAR at surface (y=2cm offset from feed point) |
|-----------------|---------|----------|---|---|
| 300 | 3.0 | 2.0 | 4.4 | 2.1 |
| 450 | 4.9 | 3.3 | 7.2 | 3.2 |
| 835 | 9.5 | 6.2 | 14.1 | 4.9 |
| 900 | 10.8 | 6.9 | 16.4 | 5.4 |
| 1450 | 29.0 | 16.0 | 50.2 | 6.5 |
| 1800 | 38.1 | 19.8 | 69.5 | 6.8 |
| 1900 | 38.8 | 20.4 | 67.6 | 6.6 |
| 2000 | 41.1 | 21.1 | 74.6 | 6.5 |
| 2450 | 52.4 | 24.0 | 104.2 | 7.7 |
| 3000 | 63.8 | 25.7 | 140.2 | 9.5 |

SYSTEM PERFORMANCE CHECK MEASUREMENT CONDITIONS

- The measurements were performed in the flat section of the SAM twin phantom filled with head and body simulating liquid of the following parameters.
- The OPENSAR system with an E-field probe EP_100 SN:1109 was used for the measurements.
- The dipole was mounted on the small tripod so that the dipole feed point was positioned below the center marking of the flat phantom section and the dipole was oriented parallel to the body axis (the long side of the phantom). The standard measuring distance was 15 mm (below 1 GHz) and 10 mm (above 1 GHz) from dipole center to the simulating liquid surface.
- The coarse grid with a grid spacing of 10mm was aligned with the dipole.
- Special 7x7x7 fine cube was chosen for cube integration (dx= 5 mm, dy= 5 mm, dz= 5 mm).
- Distance between probe sensors and phantom surface was set to 2.5 mm.
- The dipole input power was $1W \pm 3\%$.
- The results are normalized to 1 W input power.

The depth of Liquid must above 15cm

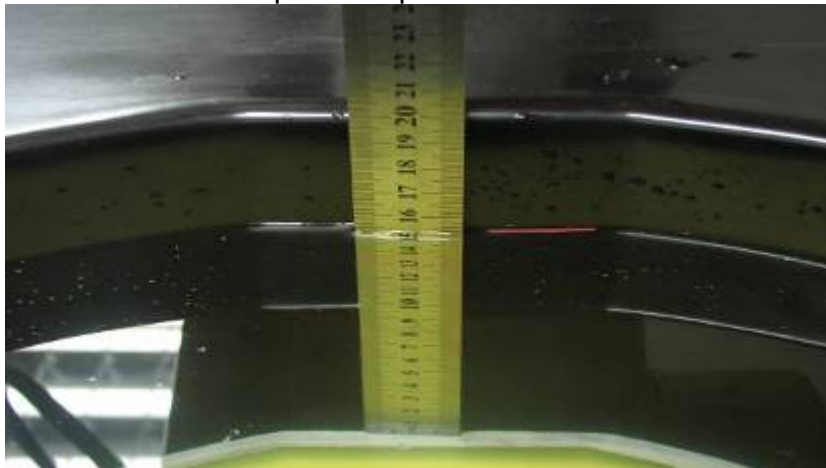



SYSTEM PERFORMANCE CHECK RESULTS

Dipole: DIPOLE850 SN:SN 48/05 DIPC32

Date: January 24, 2011

Ambient condition: Temperature 21.2°C; Relative humidity: 53%

| Head Simulatinf Liquid | | | Parameters | Target | Measured | Deviation[%] | Limited[%] |
|------------------------|------------|------------|---------------|--------|----------|---------------|-------------|
| Frequency | Temp. [°C] | Depth [cm] | | | | | |
| 835 MHz | 20.50 | 15.00 | Permittivity: | 41.50 | 41.06 | -1.06 | ±5 |
| | | | Conductivity: | 0.90 | 0.87 | -3.33 | ± 5 |
| | | | 1 g SAR: | 9.39 | 9.22 | -1.81 | ± 5 |

Dipole: DIPOLE850 SN:SN 48/05 DIPC32

Date: January 24, 2011

Ambient condition: Temperature 21.2°C; Relative humidity: 53%

| Body Simulatinf Liquid | | | Parameters | Target | Measured | Deviation[%] | Limited[%] |
|------------------------|------------|------------|---------------|--------|----------|---------------|-------------|
| Frequency | Temp. [°C] | Depth [cm] | | | | | |
| 835.00 | 20.50 | 15.00 | Permittivity: | 55.20 | 54.24 | -1.74 | ±5 |
| | | | Conductivity: | 0.97 | 0.99 | 2.06 | ± 5 |
| | | | 1 g SAR: | 9.62 | 9.46 | -1.66 | ± 5 |

Dipole: DIPOLE1900 SN:SN 48/05 DIPG35

Date: January 24, 2011

Ambient condition: Temperature 21°C; Relative humidity: 54%

| Head Simulatinf Liquid | | | Parameters | Target | Measured | Deviation[%] | Limited[%] |
|------------------------|------------|------------|---------------|--------|----------|---------------|-------------|
| Frequency | Temp. [°C] | Depth [cm] | | | | | |
| 1900.00 | 20.50 | 15.00 | Permittivity: | 40.00 | 39.87 | -0.33 | ±5 |
| | | | Conductivity: | 1.40 | 1.42 | 1.43 | ± 5 |
| | | | 1 g SAR: | 39.60 | 39.85 | 0.63 | ± 5 |

Dipole: DIPOLE1900 SN:SN 48/05 DIPG35

Date: January 24, 2011

Ambient condition: Temperature 21°C; Relative humidity: 54%

| Body Simulatinf Liquid | | | Parameters | Target | Measured | Deviation[%] | Limited[%] |
|------------------------|------------|------------|---------------|--------|----------|---------------|-------------|
| Frequency | Temp. [°C] | Depth [cm] | | | | | |
| 1900.00 | 20.50 | 15.00 | Permittivity: | 53.30 | 53.68 | 0.71 | ±5 |
| | | | Conductivity: | 1.52 | 1.47 | -3.29 | ± 5 |
| | | | 1 g SAR: | 41.60 | 40.19 | -3.39 | ± 5 |



10.3 EUT TUNE-UP PROCEDURES

The following procedures had been used to prepare the EUT for the SAR test.

- To setup the desire channel frequency and the maximum output power. A Radio Communication Tester "CMU200 " was used to program the EUT.

GSM 850 / GPRS850

Network Support: GSM / GPRS
 Main Service: Circuit Switched / Packet data
 Power Setting: 33dBm / 33dBm
 Class: 12 (4 Up / 1 Down)

GSM 1900 / GPRS 1900

Network Support: GSM / GPRS
 Main Service: Circuit Switched / Packet data
 Power Setting: 30dBm / 30dBm
 Class: 12 (4 Up / 1Down)

- Maximum conducted power was measured by replacing the antenna with an adapter for conductive measurement.
- Bluetooth
 - The client supplied a special driver to program the EUT, allowing it to continually transmit the specified maximum power and change the channel frequency.
 - The conducted power was measured at the high, middle and low channel frequency before and after the SAR measurement.
 - During SAR test, the highest output channel per band measured first, and then if necessary, the other channels were measured according to the normal procedures.

Conducted output power (Average)(dBm)

| GSM | | GSM mode | | GPRS mode | |
|---------|--------|----------|-------|-----------|-------|
| | | before | after | before | after |
| GSM850 | Ch 128 | 32.72 | 32.64 | 31.87 | 31.70 |
| | Ch 190 | 32.39 | 32.30 | 31.28 | 31.12 |
| | Ch 251 | 32.25 | 32.11 | 31.14 | 31.95 |
| GSM | | GSM mode | | GPRS mode | |
| | | before | after | before | after |
| GSM1900 | Ch 512 | 29.56 | 29.51 | 29.62 | 29.39 |
| | Ch 661 | 29.53 | 29.50 | 29.54 | 29.37 |
| | Ch 810 | 29.68 | 29.66 | 29.64 | 29.26 |



10.4 KDB 648474 SAR HANDSETS MULTI XMITER ASSESSMENT

Summary of Measurement Results (Bluetooth function)

The distance between BT antenna and GSM antenna is 1cm. The location of the antennas inside mobile phone is shown below:

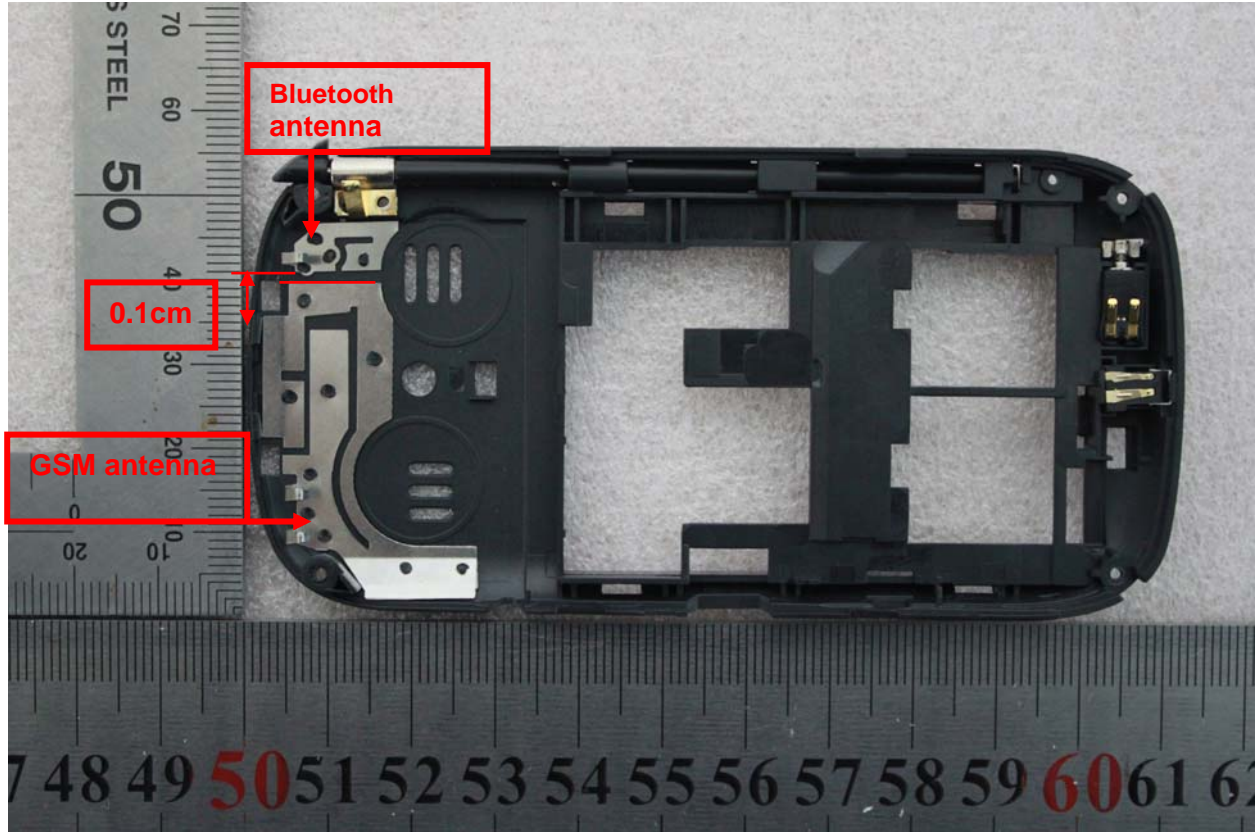

Bluetooth output power (Average) (dBm)

| Mode / Frequency | DATA1 1M | | DATA3 3M | |
|------------------|--------------|--|--------------|--|
| | before test | after test | before test | after test |
| 2402 MHz | -0.69 | N/A SAR measurement is not required | -3.28 | N/A SAR measurement is not required |
| 2441 MHz | -0.16 | | -2.45 | |
| 2480 MHz | -1.28 | | -3.87 | |

According to the output power measurement result and the SAR values, we can draw the conclusion that : stand-alone SAR and simultaneous transmission SAR are not required for BT transmitter, because the all SAR measurement results of GSM transmitter are <1.2W/kg and BT antenna is <2.5cm from other antenna.



10.5 SAR MEASUREMENT RESULTS

Left head / Right Head mode:

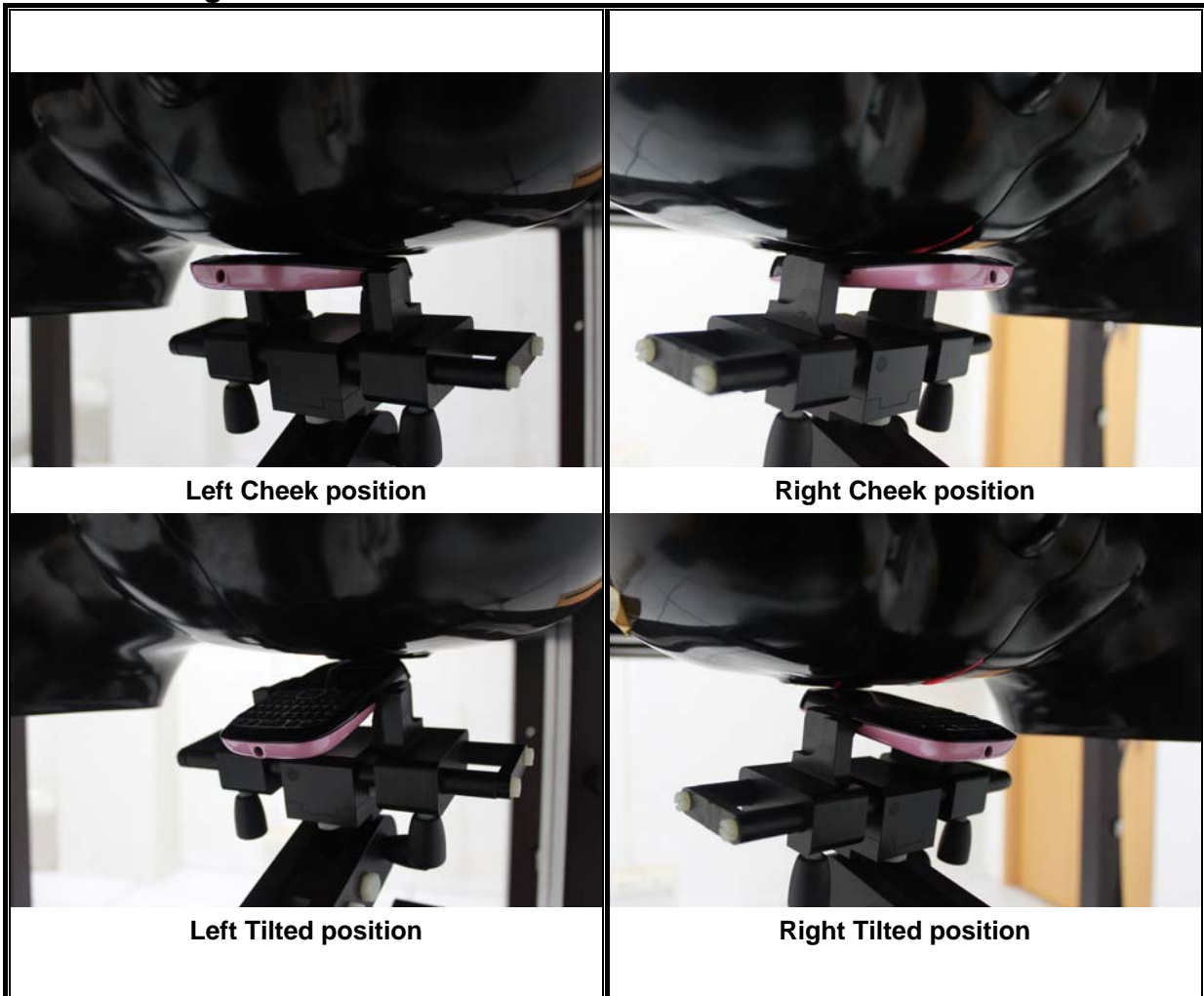

| Test mode: GSM 850 , Duty Cycle: 12.5%, Crest Factor: 8 Depth of liquid: 15.0 cm | | | | | | |
|--|---------|-----------|-------|----------------|-----------------|--------------|
| EUT Position | Antenna | Frequency | | Liquid Temp_°C | SAR (1g) (W/kg) | Limit (W/kg) |
| | | Channel | MHz | | | |
| Right Cheek | Fixed | 128 | 824.2 | 20.3 | 0.48 | 1.6 |
| Right Cheek | Fixed | 180 | 836.6 | 20.3 | 0.46 | |
| Right Cheek | Fixed | 251 | 848.8 | 20.3 | 0.45 | |
| Right Tilted | Fixed | 128 | 824.2 | 20.3 | 0.50 | |
| Right Tilted | Fixed | 180 | 836.6 | 20.3 | 0.46 | |
| Right Tilted | Fixed | 251 | 848.8 | 20.3 | 0.49 | |
| Left Cheek | Fixed | 128 | 824.2 | 20.3 | 0.51 | |
| Left Cheek | Fixed | 180 | 836.6 | 20.3 | 0.53 | |
| Left Cheek | Fixed | 251 | 848.8 | 20.3 | 0.55 | |
| Left Tilted | Fixed | 128 | 824.2 | 20.3 | 0.48 | |
| Left Tilted | Fixed | 180 | 836.6 | 20.3 | 0.46 | |
| Left Tilted | Fixed | 251 | 848.8 | 20.3 | 0.43 | |

Notes: 1) Please refer to attachment for the result presentation in plot format.



Left head / Right Head mode:

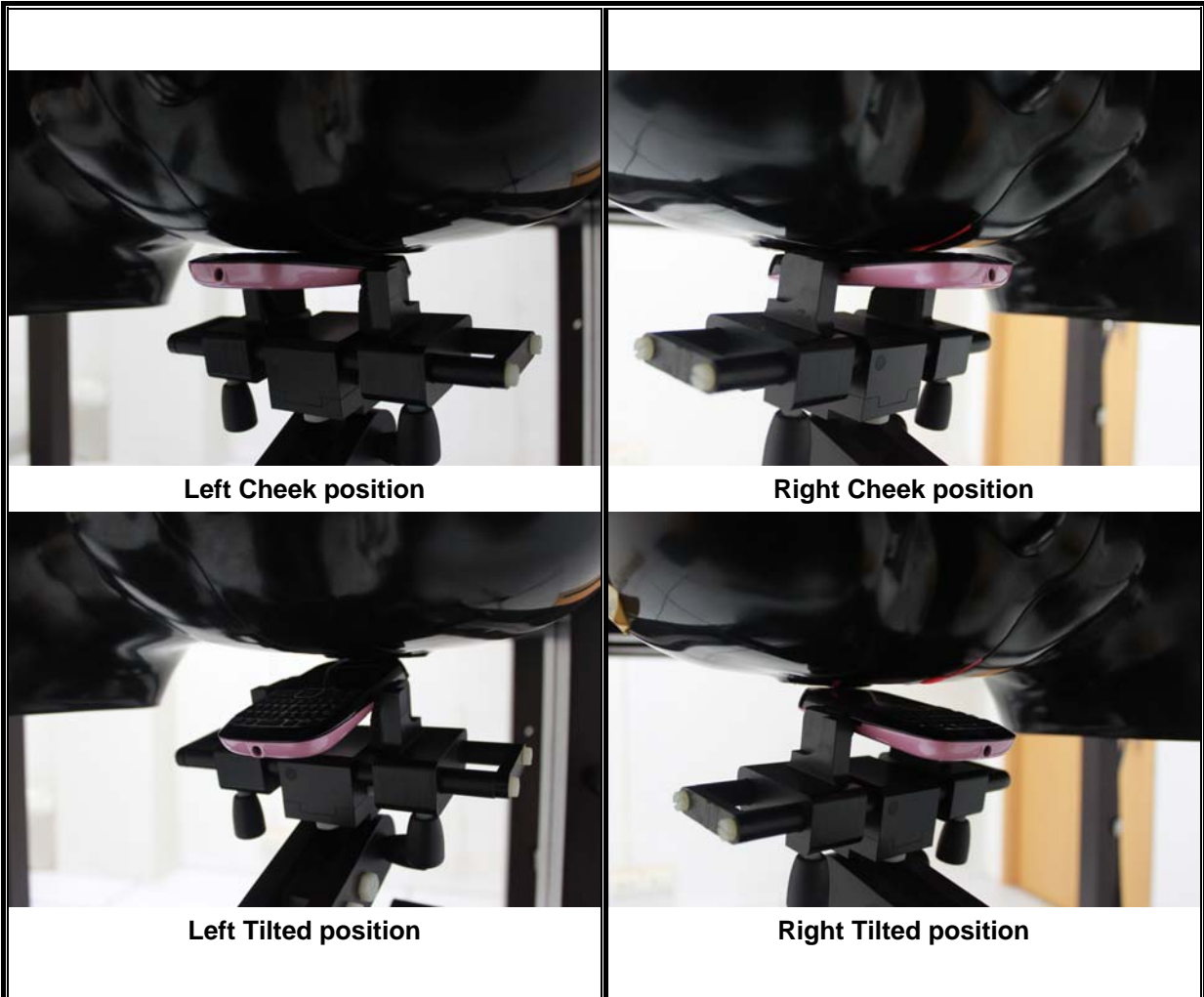

Test mode: **GSM1900**, Duty Cycle: 12.5%, Crest Factor: 8 Depth of liquid: 15.0 cm

| EUT Position | Antenna | Frequency | | Liquid Temp_°C | SAR (1g) (W/kg) | Limit (W/kg) |
|--------------|---------|-----------|--------|----------------|-----------------|--------------|
| | | Channel | MHz | | | |
| Right Cheek | Fixed | 512 | 1850.2 | 20.3 | 0.42 | 1.6 |
| Right Cheek | Fixed | 661 | 1880.0 | 20.3 | 0.50 | |
| Right Cheek | Fixed | 810 | 1910.0 | 20.3 | 0.54 | |
| Right Tilted | Fixed | 512 | 1850.2 | 20.3 | 0.42 | |
| Right Tilted | Fixed | 661 | 1880.0 | 20.3 | 0.36 | |
| Right Tilted | Fixed | 810 | 1910.0 | 20.3 | 0.34 | |
| Left Cheek | Fixed | 512 | 1850.2 | 20.3 | 0.54 | |
| Left Cheek | Fixed | 661 | 1880.0 | 20.3 | 0.46 | |
| Left Cheek | Fixed | 810 | 1910.0 | 20.3 | 0.56 | |
| Left Tilted | Fixed | 512 | 1850.2 | 20.3 | 0.38 | |
| Left Tilted | Fixed | 661 | 1880.0 | 20.3 | 0.33 | |
| Left Tilted | Fixed | 810 | 1910.0 | 20.3 | 0.39 | |

Notes: 1) Please refer to attachment for the result presentation in plot format.



Body position

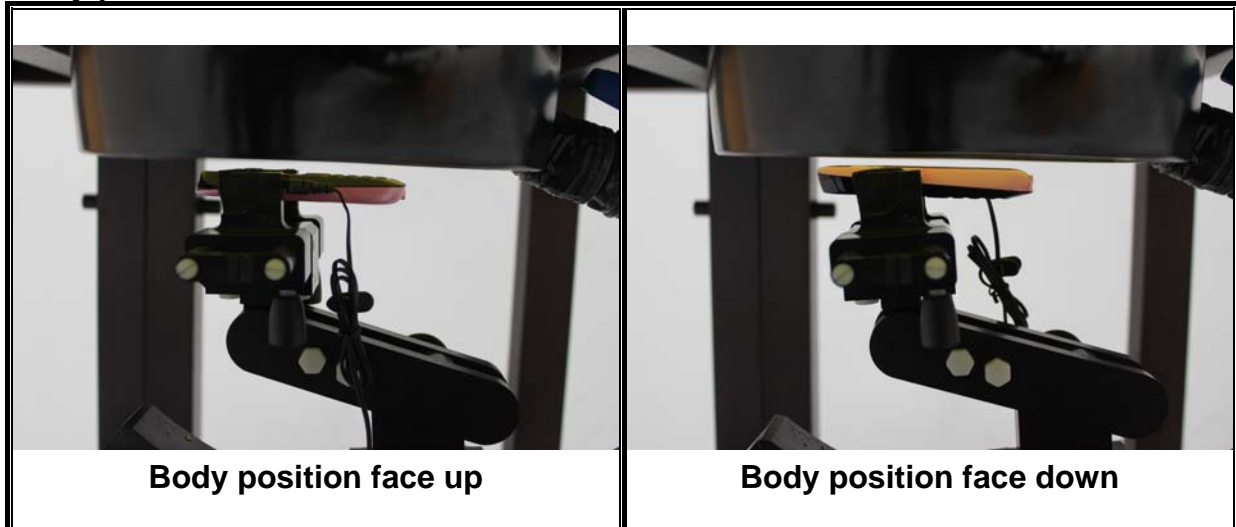

Test mode: **GSM 850**, Duty Cycle: 12.5%, Crest Factor: 8 Depth of liquid: 15.0 cm

| EUT Position | Antenna | Frequency | | Liquid Temp_°C | SAR (1g) (W/kg) | Limit (W/kg) |
|--------------|---------|-----------|-------|----------------|-----------------|--------------|
| | | Channel | MHz | | | |
| Face Up | Fixed | 128 | 824.2 | 20.3 | 0.37 | 1.6 |
| Face Up | Fixed | 180 | 836.6 | 20.3 | 0.32 | |
| Face Up | Fixed | 251 | 848.8 | 20.3 | 0.35 | |
| Face Down | Fixed | 128 | 824.2 | 20.3 | 0.30 | |
| Face Down | Fixed | 180 | 836.6 | 20.3 | 0.33 | |
| Face Down | Fixed | 251 | 848.8 | 20.3 | 0.35 | |

Test mode: **GPRS 850**, Duty Cycle: 50%, Crest Factor: 2 Depth of liquid: 15.0 cm

| EUT Position | Antenna | Frequency | | Liquid Temp_°C | SAR (1g) (W/kg) | Limit (W/kg) |
|--------------|---------|-----------|-------|----------------|-----------------|--------------|
| | | Channel | MHz | | | |
| Face Up | Fixed | 128 | 824.2 | 20.3 | 0.35 | 1.6 |
| Face Up | Fixed | 180 | 836.6 | 20.3 | 0.35 | |
| Face Up | Fixed | 251 | 848.8 | 20.3 | 0.33 | |
| Face Down | Fixed | 128 | 824.2 | 20.3 | 0.31 | |
| Face Down | Fixed | 180 | 836.6 | 20.3 | 0.32 | |
| Face Down | Fixed | 251 | 848.8 | 20.3 | 0.31 | |

Notes: 1) Front panel / Bottom face in parallel with flat phantom
 2) Please refer to attachment for the result presentation in plot format.

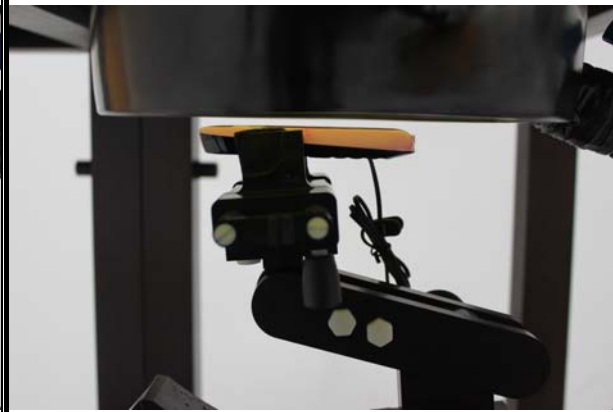

Body position

|  | | | |  | | | |
|--|---------|-----------|--------|--|--------------------------|--------------|--|
| Body position face up | | | | Body position face down | | | |
| Test mode: GSM 1900 , Duty Cycle: 12.5%, Crest Factor: 8 | | | | | Depth of liquid: 15.0 cm | | |
| EUT Position | Antenna | Frequency | | Liquid Temp_°C | SAR (1g) (W/kg) | Limit (W/kg) | |
| | | Channel | MHz | | | | |
| Face Up | Fixed | 512 | 1850.2 | 20.3 | 0.33 | 1.6 | |
| Face Up | Fixed | 661 | 1880.0 | 20.3 | 0.35 | | |
| Face Up | Fixed | 810 | 1910.0 | 20.3 | 0.29 | | |
| Face Down | Fixed | 512 | 1850.2 | 20.3 | 0.30 | | |
| Face Down | Fixed | 661 | 1880.0 | 20.3 | 0.30 | | |
| Face Down | Fixed | 810 | 1910.0 | 20.3 | 0.33 | | |
| Test mode: GPRS 1900 , Duty Cycle: 50%, Crest Factor: 2 | | | | | Depth of liquid: 15.0 cm | | |
| EUT Position | Antenna | Frequency | | Liquid Temp_°C | SAR (1g) (W/kg) | Limit (W/kg) | |
| | | Channel | MHz | | | | |
| Face Up | Fixed | 512 | 1850.2 | 20.3 | 0.35 | 1.6 | |
| Face Up | Fixed | 661 | 1880.0 | 20.3 | 0.37 | | |
| Face Up | Fixed | 810 | 1910.0 | 20.3 | 0.33 | | |
| Face Down | Fixed | 512 | 1850.2 | 20.3 | 0.28 | | |
| Face Down | Fixed | 661 | 1880.0 | 20.3 | 0.32 | | |
| Face Down | Fixed | 810 | 1910.0 | 20.3 | 0.34 | | |
| Notes: 1) Front panel / Bottom face in parallel with flat phantom 2) Please refer to attachment for the result presentation in plot format. | | | | | | | |



11. EUT PHOTO







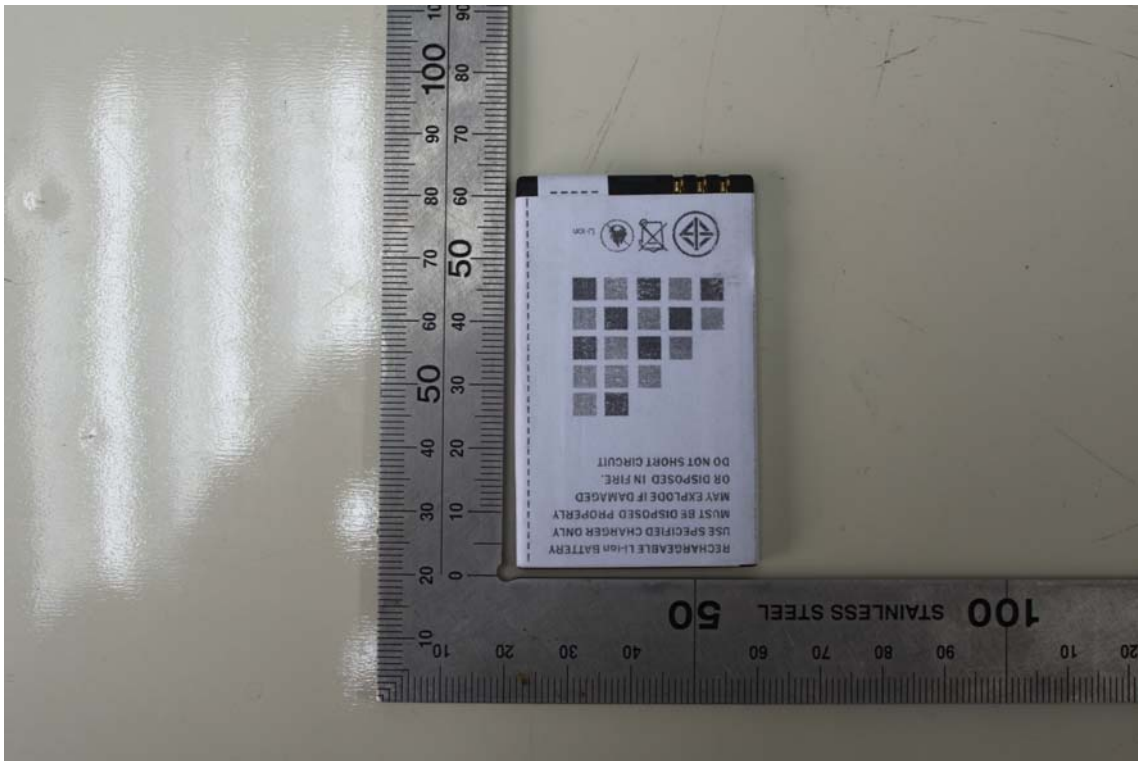



12. EQUIPMENT LIST & CALIBRATION STATUS

| Name of Equipment | Manufacturer | Type/Model | Serial Number | Calibration Due |
|---------------------------------|--------------|------------|---------------|-----------------|
| P C | HP | PV 3.06GHz | 375052-AA1 | N/A |
| Signal Generator | Agilent | E8257C | MY43321570 | 03/24/2011 |
| MultiMeter | Keithley | 2000 | 1015843 | 05/25/2011 |
| S-Parameter Network Analyzer | Agilent | E5071B | MY42301382 | 03/24/2011 |
| Wireless Communication Test Set | R&S | CMU200 | SN:B23-03291 | 05/25/2011 |
| Power Meter | Agilent | E4416A | QB41292714 | 03/24/2011 |
| E-field PROBE | ANTENNESSA | EP_100 | SN1109 | 05/04/2011 |
| DIPOLE 835 | ANTENNESSA | DIPC32 | SN 48/05 | 02/09/2011 |
| DIPOLE 1900 | ANTENNESSA | DIPG35 | SN 48/05 | 02/09/2011 |
| POSITIONING DEVICE | ANTENNESSA | MSH_14 | SN 41_05 | N/A |
| DUMMY PROBE | ANTENNESSA | DP_12 | SN 39_05 | N/A |
| SAM PHANTOM | ANTENNESSA | SAM29 | SN 41_05 | N/A |
| PHANTON WOOD TABLE | ANTENNESSA | N/A | N/A | N/A |
| 6 AXIS ROBOT | KUKA | KR3 | 846428 | N/A |
| ROBOT KRC | KUKA | KCP2 | 01436 | N/A |
| CHANELS SCAN CARD | KEITHLEY | 2000 | 2000-172-01B | N/A |
| PROBE/ROBOT POSITIONING DEVICE | ANTENNESSA | MSH14 | SN 41_05 | N/A |
| LIQUID CALIBRATION KIT | ANTENNESSA | 41/05 OCP9 | 00425167 | N/A |



13. FACILITIES

All measurement facilities used to collect the measurement data are located at

No.10, Weiye Rd., Innovation Park, Eco & Tec. Development Part, Kunshan City, Jiangsu Province, China.

14. REFERENCES

- [1] Federal Communications Commission, "Report and order: Guidelines for evaluating the environmental effects of radiofrequency radiation", Tech. Rep. FCC 96-326, FCC, Washington, D.C. 20554, 1996.
- [2] FCC 47 CFR Part 2 "Frequency Allocations and Radio Treaty Matters; General Rules and Regulations"
- [3] IEEE Std. C95.1-1999, "IEEE Standard for Safety Levels with Respect to Human Exposure to Radio Frequency Electromagnetic Fields, 3 kHz to 300 GHz", 1999
- [4] IEEE Std. 1528-2003, "Recommended Practice for Determining the Peak Spatial-Average Specific Absorption Rate (SAR) in the Human Head from Wireless Communications Devices: Measurement Techniques", December 2003
- [5] FCC OET Bulletin 65 (Edition 97-01) Supplement C (Edition 01-01), "Evaluating Compliance with FCC Guidelines for Human Exposure to Radiofrequency Electromagnetic Fields", June 2001
- [6] SATIMO ANTENNESSA System Handbook
- [7] FCC KDB 248227 D01 v01r02, "SAR Measurement Procedures for 802.11 a/b/g Transmitters", May 2007
- [8] FCC KDB 447498 D01 v04, "Mobile and Portable Device RF Exposure Procedures and Equipment Authorization Policies", November 2009
- [9] FCC KDB 447498 D02 v02, "SAR Measurement Procedures for USB Dongle Transmitters", November 2009
- [10] FCC KDB 616217 D01 v01r01, "SAR Evaluation Considerations for Laptop Computers with Antennas Built-in on Display Screens", November 2009
- [11] FCC KDB 616217 D03 v01, "SAR Evaluation Considerations for Laptop/Notebook/Notebook and Tablet Computers", November 2009
- [12] FCC KDB 648474 D01 v01r05, "SAR Evaluation Considerations for Handsets with Multiple Transmitters and Antennas", September 2008
- [13] FCC KDB 941225 D01 v02, "SAR Measurement Procedures for 3G Devices – CDMA 2000 / Ev-Do / WCDMA / HSDPA / HSPA", October 2007
- [14] FCC KDB 941225 D03 v01, "Recommended SAR Test Reduction Procedures for GSM / GPRS / EDGE", December 2008
- [15] FCC KDB 941225 D04 v01, "Evaluating SAR for GSM/(E)GPRS Dual Transfer Mode", January 27 2010



15. ATTACHMENTS

| Exhibit | Content |
|----------------|--|
| 1 | System Performance Check Plots |
| 2 | SAR Test Plots |
| 3 | Probe calibration report EP100 sn11/09 |
| 4 | Dipole calibration report DIPOLE850 SN:SN 48/05 DIPC32 |
| 5 | Dipole calibration report DIPOLE1900 SN: SN 48/05 DIPG35 |

END OF REPORT