

# FCC CERTIFICATION TEST REPORT

## FOR

|                             |   |   |
|-----------------------------|---|---|
| <b>Applicant</b>            | : | Continental Automotive GmbH   |
| <b>Address</b>              | : | Philipsstrasse 1, 35576 Wetzlar, Germany  |
| <b>Equipment under Test</b> | : | Car Radio   |
| <b>Model No.</b>            | : | TRD7412UBA-OR/CAT, 524-3711-01  |
| <b>Trade Mark</b>           | : | CAT   |
| <b>FCC ID</b>               | : | Y70-TRD7412UBA  |
| <b>Manufacturer</b>         | : | Huizhou Foryou General Electronics Co., Ltd.  |
| <b>Address</b>              | : | North Shangxia Road, Dongjiang Hi-tech Industry Park,<br>Huizhou, Guangdong Province, 516005, P R China |

**Issued By: Dongguan Dongdian Testing Service Co., Ltd.**

**Add:** No. 17, Zongbu Road 2, Songshan Lake Sci&Tech, Industry Park, Dongguan City,  
Guangdong Province, China, 523808

**Tel:** +86-0769-22891499 [Http://www.dgddt.com](http://www.dgddt.com)

## TABLE OF CONTENTS

|      |   |    |
|------|---|----|
|      | Test report declares.....                         | 4  |
| 1.   | Summary of test results .....                     | 5  |
| 2.   | General test information.....                     | 6  |
| 2.1. | Description of EUT .....                          | 6  |
| 2.2. | Accessories of EUT.....                           | 6  |
| 2.3. | Assistant equipment used for test.....            | 6  |
| 2.4. | Block diagram of EUT configuration for test ..... | 6  |
| 2.5. | Deviations of test standard .....                 | 7  |
| 2.6. | Test environment conditions .....                 | 7  |
| 2.7. | Test laboratory.....                              | 7  |
| 2.8. | Measurement uncertainty .....                     | 8  |
| 3.   | Equipment used during test.....                   | 9  |
| 4.   | Maximum Output Power .....                        | 10 |
| 4.1. | Block diagram of test setup.....                  | 10 |
| 4.2. | Limits .....                                      | 10 |
| 4.3. | Test Procedure.....                               | 10 |
| 4.4. | Test Result.....                                  | 10 |
| 5.   | 20dB Bandwidth and 99% Bandwidth.....             | 11 |
| 5.1. | Block diagram of test setup.....                  | 11 |
| 5.2. | Limits .....                                      | 11 |
| 5.3. | Test Procedure.....                               | 11 |
| 5.4. | Test Result.....                                  | 11 |
| 5.5. | Original test data .....                          | 12 |
| 6.   | Carrier Frequency Separation.....                 | 14 |
| 6.1. | Block diagram of test setup.....                  | 14 |
| 6.2. | Limits .....                                      | 14 |
| 6.3. | Test Procedure.....                               | 14 |
| 6.4. | Test Result.....                                  | 14 |
| 6.5. | Original test data .....                          | 14 |
| 7.   | Number Of Hopping Channel .....                   | 15 |
| 7.1. | Block diagram of test setup.....                  | 15 |
| 7.2. | Limits .....                                      | 15 |
| 7.3. | Test Procedure.....                               | 15 |
| 7.4. | Test Result.....                                  | 15 |
| 7.5. | Original test data .....                          | 15 |
| 8.   | Dwell Time.....                                   | 17 |
| 8.1. | Block diagram of test setup.....                  | 17 |

|       |   |    |
|-------|---|----|
| 8.2.  | Limits .....  | 17 |
| 8.3.  | Test Procedure.....                                 | 17 |
| 8.4.  | Test Result.....                                    | 17 |
| 8.5.  | Original test data .....                            | 17 |
| 9.    | Radiated emission .....                             | 20 |
| 9.1.  | Block diagram of test setup .....                   | 20 |
| 9.2.  | Limit .....   | 21 |
| 9.3.  | Test Procedure.....                                 | 22 |
| 9.4.  | Test result .....                                   | 23 |
| 10.   | Band Edge Compliance (radiated method) .....        | 27 |
| 10.1. | Block diagram of test setup .....                   | 27 |
| 10.2. | Limit .....   | 27 |
| 10.3. | Test Procedure.....                                 | 27 |
| 10.4. | Test result .....                                   | 27 |
| 11.   | Band Edge Compliance (conducted method).....        | 36 |
| 11.1. | Block diagram of test setup .....                   | 36 |
| 11.2. | Limit .....   | 36 |
| 11.3. | Test result .....                                   | 36 |
| 11.4. | Original test data .....                            | 36 |
| 12.   | Power Line Conducted Emission .....                 | 40 |
| 12.1. | Block diagram of test setup .....                   | 40 |
| 12.2. | Power Line Conducted Emission Limits(Class B) ..... | 40 |
| 12.3. | Test Procedure.....                                 | 40 |
| 12.4. | Test Result.....                                    | 41 |
| 13.   | Antenna Requirements .....                          | 42 |
| 13.1. | Limit .....   | 42 |
| 13.2. | Result.....   | 42 |
| 14.   | Test setup photograph .....                         | 43 |
| 15.   | Photos of the EUT .....                             | 44 |

## TEST REPORT DECLARE

|                             |   |  |
|-----------------------------|---|--|
| <b>Applicant</b>            | : | Continental Automotive GmbH  |
| <b>Address</b>              | : | Philipsstrasse 1, 35576 Wetzlar, Germany   |
| <b>Equipment under Test</b> | : | Car Radio  |
| <b>Model No.</b>            | : | TRD7412UBA-OR/CAT, 524-3711-01   |
| <b>Trade Mark</b>           | : | CAT  |
| <b>Manufacturer</b>         | : | Huizhou Foryou General Electronics Co., Ltd.   |
| <b>Address</b>              | : | North Shangxia Road, Dongjiang Hi-tech Industry Park, Huizhou, Guangdong Province, 516005, P R China |

**Test Standard Used:**

FCC Rules and Regulations Part 15 Subpart C

**Test procedure used:**

ANSI C63.10:2013, ANSI C63.4:2014

**We Declare:**

The equipment described above is tested by Dongguan Dongdian Testing Service Co., Ltd and in the configuration tested the equipment complied with the standards specified above. The test results are contained in this test report and Dongguan Dongdian Testing Service Co., Ltd is assumed of full responsibility for the accuracy and completeness of these tests.

**After test and evaluation, our opinion is that the equipment provided for test compliance with the requirement of the above FCC standards.**

|                         |                   |                      |                              |
|-------------------------|-------------------|----------------------|------------------------------|
| <b>Report No:</b>       | DDT-R17Q0628-12E1 |                      |                              |
| <b>Date of Receipt:</b> | Jun. 28, 2017     | <b>Date of Test:</b> | Jun. 28, 2017 ~ Aug. 5, 2017 |

*Prepared By:*

  
 Leo Liu/Engineer

  
 Kevin Cheng/EMC Manager

Note: This report applies to above tested sample only. This report shall not be reproduced in parts without written approval of Dongguan Dongdian Testing Service Co., Ltd.

## 1. Summary of test results

| Description of Test Item   | Standard   | Results |
|--|--|---------|
| Maximum Output Power   | FCC Part 15: 15.247(b)(1)<br>ANSI C63.10:2013<br>ANSI C63.4:2014                     | PASS    |
| 20dB Bandwidth and 99% Bandwidth   | FCC Part 15: 15.215<br>ANSI C63.10:2013<br>ANSI C63.4:2014                           | PASS    |
| Carrier Frequency Separation   | FCC Part 15: 15.247(a)(1)<br>ANSI C63.10:2013<br>ANSI C63.4:2014                     | PASS    |
| Number Of Hopping Channel  | FCC Part 15: 15.247(a)(1)(iii)<br>ANSI C63.10:2013<br>ANSI C63.4:2014                | PASS    |
| Dwell Time   | FCC Part 15: 15.247(a)(1)(iii)<br>ANSI C63.10:2013<br>ANSI C63.4:2014                | PASS    |
| Radiated Emission  | FCC Part 15: 15.209<br>FCC Part 15: 15.247(d)<br>ANSI C63.10:2013<br>ANSI C63.4:2014 | PASS    |
| Band Edge Compliance   | FCC Part 15: 15.247(d)<br>ANSI C63.10:2013<br>ANSI C63.4:2014                        | PASS    |
| Power Line Conducted Emissions   | FCC Part 15: 15.207<br>ANSI C63.10:2013<br>ANSI C63.4:2014                           | N/A     |
| Antenna requirement  | FCC Part 15: 15.203<br>ANSI C63.4:2014   | PASS    |
| Note: 'N/A' is an abbreviation for Not Applicable. This product can not be connected into public power supply. |  |         |

## 2. General test information

### 2.1. Description of EUT

|                          |  |
|--------------------------|--|
| EUT* Name                | : Car Radio  |
| Model Number             | : TRD7412UBA-OR/CAT, 524-3711-01                       |
| EUT function description | : Please reference user manual of this device          |
| Power supply             | : DC 12V   |
| Radio Specification      | : Bluetooth V2.1                                       |
| Operation frequency      | : 2402MHz -2480MHz                                     |
| Modulation               | : GFSK, $\pi/4$ QPSK, 8-DPSK                           |
| Modulation Types         | : Frequency Hopping Spread Spectrum (FHSS) modulation. |
| Equipment type           | : Adaptive frequency hopping equipment.                |
| Data rate                | : 1Mbps, 2Mbps, 3Mbps                                  |
| Antenna Type             | : Integrated antenna, maximum PK gain: 0 dBi           |
| Sample Type              | : Series production                                    |

Note: EUT is the ab. of equipment under test.

### 2.2. Accessories of EUT

| Description of Accessories | Manufacturer | Model number or Type | Serial No. | Other |
|----------------------------|--------------|----------------------|------------|-------|
| /                          | /            | /                    | /          | /     |

### 2.3. Assistant equipment used for test

| Description of Assistant equipment | Manufacturer | Model number or Type | EMC Compliance | Other             |
|------------------------------------|--------------|----------------------|----------------|-------------------|
| Notebook                           | DELL         | Latitude D610        | FCC DOC        | 00045-534-136-300 |

### 2.4. Block diagram of EUT configuration for test



Test software: BlueSuite2.6.0

The test software was used to control EUT work in Continuous TX mode, and select test channel, wireless mode as blow table.

| Tested mode, channel, information |             |                 |
|-----------------------------------|-------------|-----------------|
| Mode                              | Channel     | Frequency (MHz) |
| GFSK hopping on Tx Mode           | CH0 to CH78 | 2402 to 2480    |
| $\pi/4$ QPSK Hopping on TX mode   | CH0 to CH78 | 2402 to 2480    |
| 8-DPSK hopping on Tx Mode         | CH0 to CH78 | 2402 to 2480    |
| GFSK hopping off Tx Mode          | CH0         | 2402            |
|                                   | CH39        | 2441            |
|                                   | CH78        | 2480            |
| $\pi/4$ QPSK hopping off Tx Mode  | CH0         | 2402            |
|                                   | CH39        | 2441            |
|                                   | CH78        | 2480            |
| 8-DPSK hopping off Tx Mode        | CH0         | 2402            |
|                                   | CH39        | 2441            |
|                                   | CH78        | 2480            |

Note1: For  $\pi/4$  QPSK its same modulation type with 8-DPSK, and based exploratory test, there is no significant difference of that two types test result, after the preliminary scan, 8-DPSK will have higher emission, so except output power, all other items final test were only performed with the worse case 8-DPSK and GFSK.

Note2: EUT have left headset and right headset, left headset and right headset are electrically identical, only the PCB layout and appearance have a little different. Left headset and right headset all have been tested, only worse case Left headset is reported in this report.

## 2.5. Deviations of test standard

No Deviation.

## 2.6. Test environment conditions

During the measurement the environmental conditions were within the listed ranges:

|                    |           |
|--------------------|-----------|
| Temperature range: | 21-25°C   |
| Humidity range:    | 40-75%    |
| Pressure range:    | 86-106kPa |

## 2.7. Test laboratory

Dongguan Dongdian Testing Service Co., Ltd

Add: No. 17, Zongbu Road 2, Songshan Lake Sci&Tech, Industry Park, Dongguan City, Guangdong Province, China, 523808 Tel: +86-0769-22891499 <http://www.dgddt.com>

FCC Registration Number: 270092; Industry Canada site registration number: 10288A-1

CNAS Accreditation No. L6451; A2LA Accreditation No. 3870.01

## 2.8. Measurement uncertainty

| Test Item   | Uncertainty                       |
|---|-----------------------------------|
| Bandwidth   | 1.1%                              |
| Peak Output Power(Conducted)( Spectrum analyzer)  | 0.86dB(10 MHz $\leq$ f < 3.6GHz); |
|   | 1.38dB(3.6GHz $\leq$ f < 8GHz)    |
| Peak Output Power(Conducted)(Power Sensor)  | 0.74dB                            |
| Power Spectral Density  | 0.74dB(10 MHz $\leq$ f < 3.6GHz); |
|   | 1.38dB(3.6GHz $\leq$ f < 8GHz)    |
| Conducted spurious emissions  | 0.86dB(10 MHz $\leq$ f < 3.6GHz); |
|   | 1.40dB(3.6GHz $\leq$ f < 8GHz)    |
|   | 1.66dB(8GHz $\leq$ f < 22GHz)     |
| Uncertainty for radio frequency (RBW<20KHz)   | $3 \times 10^{-8}$                |
| Temperature   | 0.4°C                             |
| Humidity  | 2%                                |
| Uncertainty for Radiation Emission test<br>(30MHz-1GHz)   | 4.70 dB (Antenna Polarize: V)     |
|   | 4.84 dB (Antenna Polarize: H)     |
| Uncertainty for Radiation Emission test<br>(1GHz-18GHz)   | 4.10dB(1-6GHz)                    |
|   | 4.40dB (6GHz-18Gz)                |
| Uncertainty for Power line conduction emission test   | 3.32dB (150KHz-30MHz)             |
| Note: This uncertainty represents an expanded uncertainty expressed at approximately the 95% confidence level using a coverage factor of k=2. |                                   |



### 3. Equipment used during test

| Equipment                                  | Manufacturer  | Model No.    | Serial No.     | Last Cal.     | Cal. Interval |
|--|---------------|--------------|----------------|---------------|---------------|
| <b>RF Connected Test</b>                   |               |              |                |               |               |
| Spectrum analyzer                          | R&S           | FSU26        | 1166.1660.26   | Oct. 16, 2016 | 1Year         |
| Vector Signal Generator                    | Agilent       | E8267D       | MY52098743     | Oct. 20, 2016 | 1Year         |
| Vector Signal Generator                    | Agilent       | N5182A       | MY48180737     | Jul. 05, 2017 | 1Year         |
| Power Sensor                               | Agilent       | U2021XA      | MY55150010     | Apr. 18, 2017 | 1Year         |
| Power Sensor                               | Agilent       | U2021XA      | MY55150011     | Apr. 19, 2017 | 1Year         |
| DC Power Source                            | MATRIS        | MPS-3005L-3  | D813058W       | Oct. 24, 2016 | 1Year         |
| Attenuator                                 | Mini-Circuits | BW-S10W2     | 101109         | Aug. 18, 2016 | 1Year         |
| RF Cable                                   | Micable       | C10-01-01-1  | 100309         | Aug. 18, 2016 | 1Year         |
| Test Software                              | JS Tonscend   | JS1120-2     | Ver.2.5        | N/A           | N/A           |
| USB Data acquisition                       | Agilent       | U2531A       | TW55043503     | N/A           | N/A           |
| Auto control Unit                          | JS Tonscend   | JS0806-2     | 158060010      | N/A           | N/A           |
| <b>Radiated Emission Test</b>              |               |              |                |               |               |
| EMI Test Receiver                          | R&S           | ESU8         | 100316         | Oct. 16, 2016 | 1Year         |
| Spectrum analyzer                          | R&S           | FSU26        | 1166.1660.26   | Oct. 16, 2016 | 1Year         |
| Trilog Broadband Antenna                   | Schwarzbeck   | VULB9163     | 9163-462       | Oct. 27, 2016 | 1 Year        |
| Active Loop antenna                        | Schwarzbeck   | FMZB-1519    | 1519-038       | Oct. 16, 2016 | 1 Year        |
| Broadband Horn antenna                     | Schwarzbeck   | BBHA 9170    | BBHA 9170 #790 | Aug. 11, 2017 | 1 Year        |
| Double Ridged Horn Antenna                 | R&S           | HF907        | 100276         | Oct. 12, 2016 | 1 Year        |
| Pre-amplifier                              | A.H.          | PAM-0118     | 360            | Oct. 16, 2016 | 1 Year        |
| RF Cable                                   | HUBSER        | CP-X2        | W11.03         | Oct. 16, 2016 | 1Year         |
| RF Cable                                   | HUBSER        | CP-X1        | W12.02         | Oct. 16, 2016 | 1 Year        |
| MI Cable                                   | HUBSER        | C10-01-01-1M | 1091629        | Oct. 16, 2016 | 1 Year        |
| Test software                              | Audix         | E3           | V 6.11111b     | /             | /             |
| <b>Power Line Conducted Emissions Test</b> |               |              |                |               |               |
| Test Receiver                              | R&S           | ESU8         | 100316         | Oct. 16, 2016 | 1 Year        |
| LISN 1                                     | R&S           | ENV216       | 101109         | Oct. 16, 2016 | 1 Year        |
| LISN 2                                     | R&S           | ESH2-Z5      | 100309         | Oct. 16, 2016 | 1 Year        |
| Pulse Limiter                              | R&S           | ESH3-Z2      | 101242         | Oct. 16, 2016 | 1 Year        |
| CE Cable 1                                 | HUBSER        | ESU8/RF2     | W10.01         | Oct. 16, 2016 | 1 Year        |
| Test software                              | Audix         | E3           | V 6.11111b     | /             | /             |

## 4. Maximum Output Power

### 4.1. Block diagram of test setup

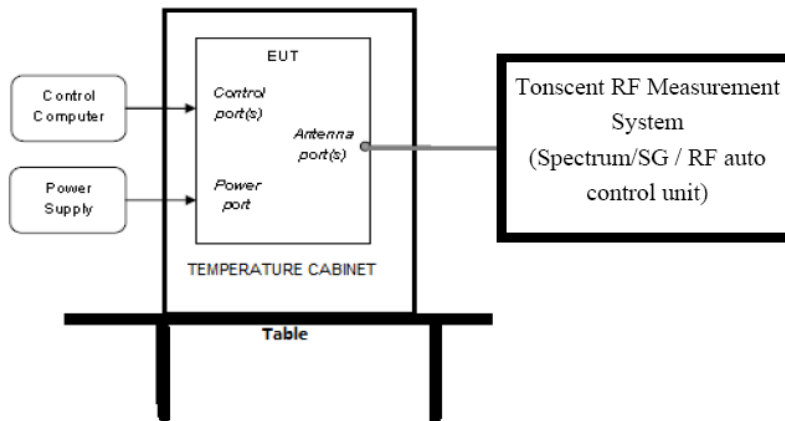

### 4.2. Limits

For frequency hopping systems operating in the 2400-2483.5 MHz band employing at least 75 non-overlapping hopping channels, and all frequency hopping systems in the 5725-5850 MHz band: 1 watt. For all other frequency hopping systems in the 2400-2483.5 MHz band: 0.125 watts, the e.i.r.p shall not exceed 4W.

### 4.3. Test Procedure

Place the EUT on the table and set it in the transmitting mode.

Remove the antenna from the EUT and then connect a low loss RF cable from the antenna port to the Power sensor.

### 4.4. Test Result

| Mode                      | Freq (MHz) | Result (dBm)             | Limit (dBm) | Conclusion |
|---------------------------|------------|--------------------------|-------------|------------|
| GFSK                      | 2402       | 4.050                    | 21          | PASS       |
|                           | 2441       | 4.390                    | 21          | PASS       |
|                           | 2480       | 4.260                    | 21          | PASS       |
| $\pi/4$ QPSK              | 2402       | 2.950                    | 21          | PASS       |
|                           | 2441       | 3.250                    | 21          | PASS       |
|                           | 2480       | 3.180                    | 21          | PASS       |
| 8-DPSK                    | 2402       | 2.990                    | 21          | PASS       |
|                           | 2441       | 3.370                    | 21          | PASS       |
|                           | 2480       | 3.240                    | 21          | PASS       |
| Test Date : Jul. 14, 2016 |            | Test Engineer : Toby Ren |             |            |

## 5. 20dB Bandwidth and 99% Bandwidth

### 5.1. Block diagram of test setup

Same as section 4.1

### 5.2. Limits

Intentional radiators operating under the alternative provisions to the general emission limits, as contained in § 15.217 through 15.257 and in Subpart E of this part, must be designed to ensure that the 20 dB bandwidth of the emission, or whatever bandwidth may otherwise be specified in the specific rule section under which the equipment operates, is contained within the frequency band designated in the rule section under which the equipment is operated.

### 5.3. Test Procedure

- (1) Connect EUT's antenna output to spectrum analyzer by RF cable.
- (2) The bandwidth of the fundamental frequency was measured by spectrum analyzer with 100 kHz RBW and 300 kHz VBW. The 20dB bandwidth is defined as the total spectrum the power of which is higher than peak power minus 20dB.

### 5.4. Test Result

| Mode                      | Freq (MHz) | 20dB bandwidth Result (MHz) | 99% bandwidth Result (MHz) | Limit (MHz)              | Margin (MHz) | Conclusion |
|---------------------------|------------|-----------------------------|----------------------------|--------------------------|--------------|------------|
| GFSK                      | 2402       | 1.114                       | 0.954                      | /                        | /            | PASS       |
|                           | 2441       | 1.118                       | 0.954                      | /                        | /            | PASS       |
|                           | 2480       | 1.116                       | 0.954                      | /                        | /            | PASS       |
| 8-DPSK                    | 2402       | 1.380                       | 1.216                      | /                        | /            | PASS       |
|                           | 2441       | 1.386                       | 1.220                      | /                        | /            | PASS       |
|                           | 2480       | 1.384                       | 1.216                      | /                        | /            | PASS       |
| Test Date : Jul. 14, 2016 |            |                             |                            | Test Engineer : Toby Ren |              |            |

5.5. Original test data

| Graphs   |  |
|----------|--|
| GFSK/LCH | <p>Ref 20 dBm -Att 20 dB -RBW 100 kHz -VBW 300 kHz SWT 5 ms</p> <p>Offset 9.6 dB</p> <p>Center 2.402 GHz 200 kHz/ Span 2 MHz</p> <p>Date: 14.JUL.2017 10:56:06</p> |
| GFSK/MCH | <p>Ref 20 dBm -Att 20 dB -RBW 100 kHz -VBW 300 kHz SWT 5 ms</p> <p>Offset 9.7 dB</p> <p>Center 2.441 GHz 200 kHz/ Span 2 MHz</p> <p>Date: 14.JUL.2017 10:55:15</p> |
| GFSK/HCH | <p>Ref 20 dBm -Att 20 dB -RBW 100 kHz -VBW 300 kHz SWT 5 ms</p> <p>Offset 9.5 dB</p> <p>Center 2.48 GHz 200 kHz/ Span 2 MHz</p> <p>Date: 14.JUL.2017 10:56:25</p>  |

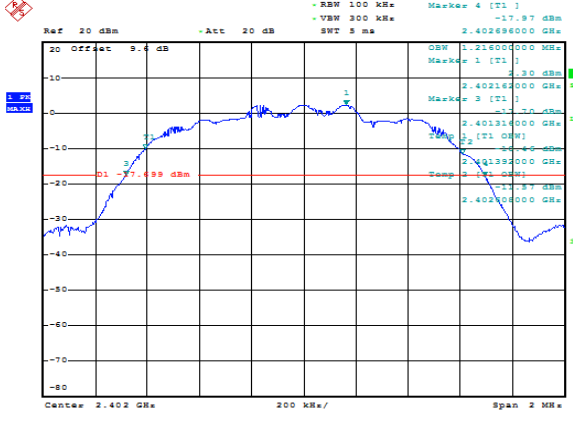
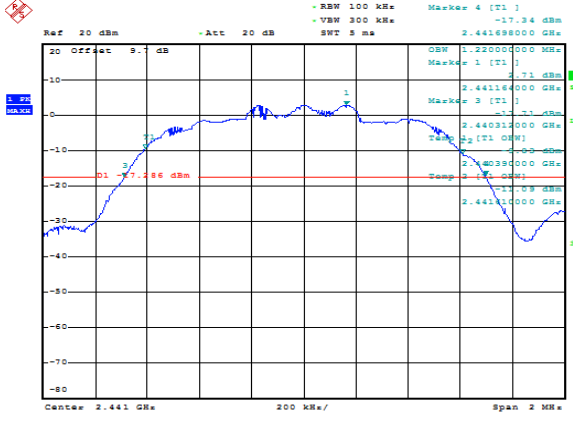
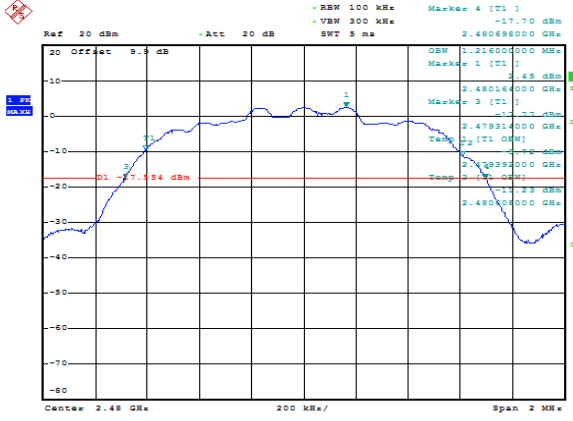
|                  |  |
|------------------|--|
| <p>8DPSK/LCH</p> |  <p>Ref 20 dBm -Att 20 dB -RBW 100 KHz -VBW 300 KHz SWT 5 ms</p> <p>OSW 1.21600000 GHz -17.97 dBm<br/>         Marker 1 (T1)<br/>         2.40200000 GHz<br/>         Marker 3 (T1)<br/>         2.40200000 GHz<br/>         Marker 4 (T1)<br/>         2.40268600 GHz</p> <p>Offset 9.6 dB</p> <p>Center 2.402 GHz 200 kHz/ Span 2 MHz</p> <p>Date: 14.JUL.2017 10:58:23</p>  |
| <p>8DPSK/MCH</p> |  <p>Ref 20 dBm -Att 20 dB -RBW 100 KHz -VBW 300 KHz SWT 5 ms</p> <p>OSW 1.22000000 GHz -17.34 dBm<br/>         Marker 1 (T1)<br/>         2.44100000 GHz<br/>         Marker 3 (T1)<br/>         2.44031000 GHz<br/>         Marker 4 (T1)<br/>         2.44100000 GHz</p> <p>Offset 9.6 dB</p> <p>Center 2.441 GHz 200 kHz/ Span 2 MHz</p> <p>Date: 14.JUL.2017 10:59:39</p> |
| <p>8DPSK/HCH</p> |  <p>Ref 20 dBm -Att 20 dB -RBW 100 KHz -VBW 300 KHz SWT 5 ms</p> <p>OSW 1.22800000 GHz -17.70 dBm<br/>         Marker 1 (T1)<br/>         2.48000000 GHz<br/>         Marker 3 (T1)<br/>         2.47931000 GHz<br/>         Marker 4 (T1)<br/>         2.48068600 GHz</p> <p>Offset 9.6 dB</p> <p>Center 2.48 GHz 200 kHz/ Span 2 MHz</p> <p>Date: 14.JUL.2017 11:02:08</p> |

## 6. Carrier Frequency Separation

### 6.1. Block diagram of test setup

Same as section 4.1

### 6.2. Limits

Frequency hopping systems shall have hopping channel carrier frequencies separated by a minimum of 25 kHz or the 20 dB bandwidth of the hopping channel, whichever is greater. Alternatively, frequency hopping systems operating in the 2400-2483.5 MHz band may have hopping channel carrier frequencies that are separated by 25 kHz or two-thirds of the 20 dB bandwidth of the hopping channel, whichever is greater, provided the systems operate with an output power no greater than 125 mW.

### 6.3. Test Procedure

- (1) Connect EUT's antenna output to spectrum analyzer by RF cable.
- (2) The carrier frequency was measured by spectrum analyzer with 100 KHz RBW and 300 KHz VBW.

### 6.4. Test Result

| Mode                      | Channel separation (MHz) | Limit (MHz)<br>2/3 of 20dB bandwidth                       | Conclusion               |
|---------------------------|--------------------------|--|--------------------------|
| GFSK                      | 1.004                    | ≥ two-thirds of the 20 dB Bandwidth Of The Hopping Channel | PASS                     |
| 8-DPSK                    | 1.006                    | ≥ two-thirds of the 20 dB Bandwidth Of The Hopping Channel | PASS                     |
| Test Date : Jul. 14, 2016 |                          |  | Test Engineer : Toby Ren |

### 6.5. Original test data

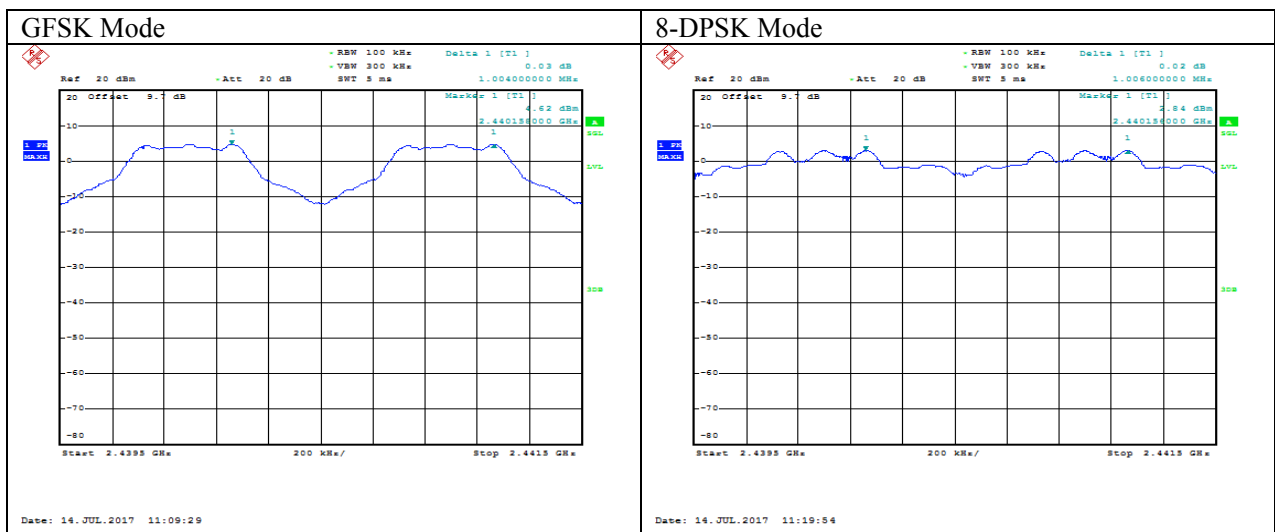

## 7. Number Of Hopping Channel

### 7.1. Block diagram of test setup

Same as section 4.1

### 7.2. Limits

Frequency hopping systems in the 2400-2483.5 MHz band shall use at least 15 channels.

### 7.3. Test Procedure

- (1) Connect EUT's antenna output to spectrum analyzer by RF cable.
- (2) The number of hopping channel was measured by spectrum analyzer with 100 kHz RBW and 300KHz VBW.

### 7.4. Test Result

| Mode   | Number of hopping channel | Limit | Conclusion |
|--------|---------------------------|-------|------------|
| GFSK   | 79                        | >15   | PASS       |
| 8-DPSK | 79                        | >15   | PASS       |

Test Date : Jul. 14, 2016 Test Engineer : Toby Ren

### 7.5. Original test data

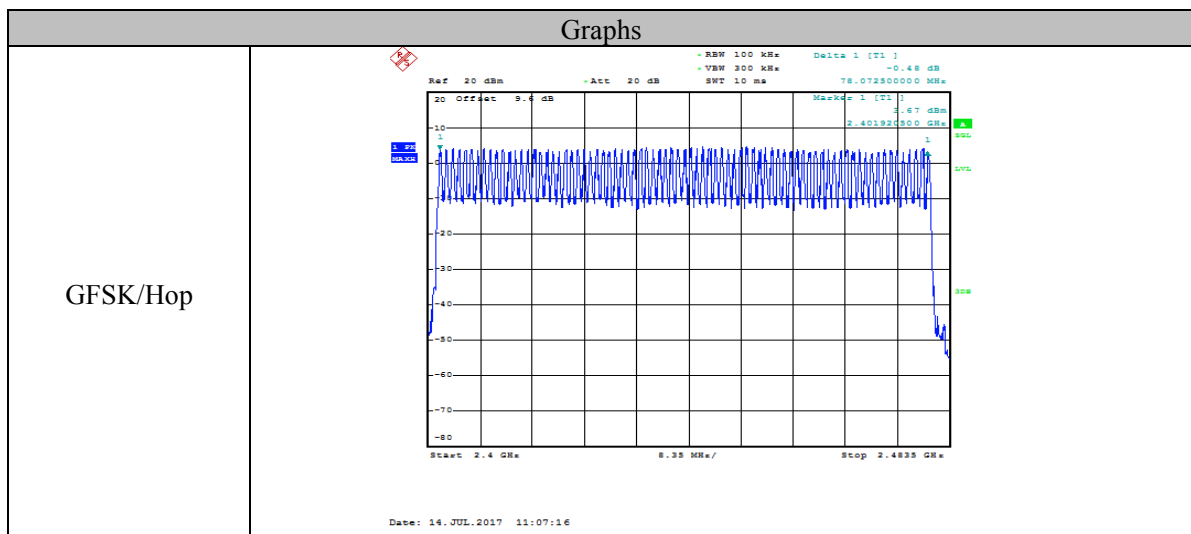

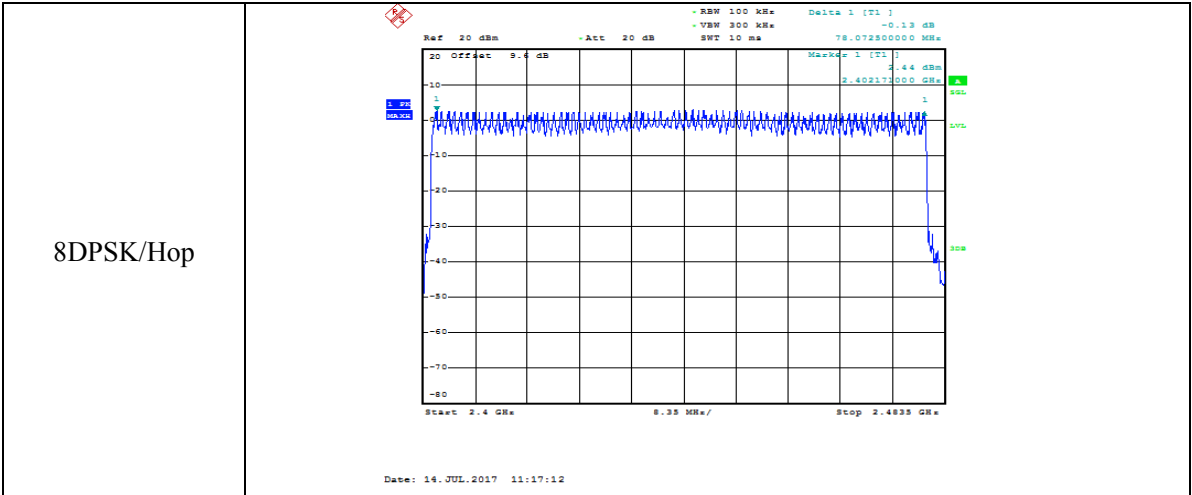



## 8. Dwell Time

### 8.1. Block diagram of test setup

Same as section 4.1

### 8.2. Limits

The average time of occupancy on any channel shall not be greater than 0.4 seconds within a period of 0.4 seconds multiplied by the number of hopping channels employed.

### 8.3. Test Procedure

- (1) Connect EUT's antenna output to spectrum analyzer by RF cable.
- (2) Measure the hopping number and on time of each pulse with spectrum analyzer in zero span set, and calculate dwell time with formula Dwell time = total hops \*pulse's on time.

DH1 Packet permit maximum  $1600 / 79 / 2 = 10.12$  hops per second in each channel (1 time slot RX, 1 time slot TX). So, total hops is  $10.12 \times 31.6 = 320$ .

DH3 Packet permit maximum  $1600 / 79 / 4 = 5.06$  hops per second in each channel (3 time slots RX, 1 time slot TX). So, total hops is  $5.06 \times 31.6 = 160$ .

DH5 Packet permit maximum  $1600 / 79 / 6 = 3.37$  hops per second in each channel (5 time slots RX, 1 time slot TX). So, total hops is  $3.37 \times 31.6 = 106.6$ .

3DH1 Packet permit maximum  $1600 / 79 / 2 = 10.12$  hops per second in each channel (1 time slot RX, 1 time slot TX). So, total hops is  $10.12 \times 31.6 = 320$ .

3DH3 Packet permit maximum  $1600 / 79 / 4 = 5.06$  hops per second in each channel (3 time slots RX, 1 time slot TX). So, total hops is  $5.06 \times 31.6 = 160$ .

3DH5 Packet permit maximum  $1600 / 79 / 6 = 3.37$  hops per second in each channel (5 time slots RX, 1 time slot TX). So, total hops is  $3.37 \times 31.6 = 106.6$ .

### 8.4. Test Result

| Mode  | Pulse's on time (ms) | Total hops | Dwell time (s)           | Limit  | Conclusion |
|---|----------------------|------------|--------------------------|--------|------------|
| DH1   | 0.39                 | 320        | 0.125                    | <400ms | PASS       |
| DH3   | 1.65                 | 160        | 0.264                    | <400ms | PASS       |
| DH5   | 2.88                 | 106.7      | 0.307                    | <400ms | PASS       |
| 3-DH1   | 0.41                 | 320        | 0.131                    | <400ms | PASS       |
| 3-DH3   | 1.66                 | 160        | 0.266                    | <400ms | PASS       |
| 3-DH5   | 2.9                  | 106.7      | 0.309                    | <400ms | PASS       |
| Test Date : Jul. 14, 2016                       |                      |            | Test Engineer : Toby Ren |        |            |
| Note: Dwell time = total hops *pulse's on time. |                      |            |                          |        |            |

### 8.5. Original test data

|        |
|--------|
| Graphs |
|--------|

|                     |   |
|---------------------|---|
| <p>GFSK_DH1/MCH</p> | <p>Ref 20 dBm -Att 20 dB RBW 1 MHz Marker 3 [T1] -5.34 dBm<br/>-VSW 3 MHz SWT 10 ms 1.320000 ms<br/>Marker 1 [T1] -4.35 dBm<br/>70.000000 us<br/>Marker 2 [T1] -5.62 dBm<br/>450.000000 us<br/>Center 2.441 GHz 1 ms/</p> <p>Date: 14. JUL. 2017 11:03:07</p> |
| <p>GFSK_DH3/MCH</p> | <p>Ref 20 dBm -Att 20 dB RBW 1 MHz Marker 3 [T1] -5.35 dBm<br/>-VSW 3 MHz SWT 10 ms 3.800000 ms<br/>Marker 1 [T1] -4.37 dBm<br/>1.300000 ms<br/>Marker 2 [T1] -5.67 dBm<br/>7.350000 ms<br/>Center 2.441 GHz 1 ms/</p> <p>Date: 14. JUL. 2017 11:03:51</p>    |
| <p>GFSK_DH5/MCH</p> | <p>Ref 20 dBm -Att 20 dB RBW 1 MHz Marker 3 [T1] -5.58 dBm<br/>-VSW 3 MHz SWT 20 ms 5.840000 ms<br/>Marker 1 [T1] -4.51 dBm<br/>2.080000 ms<br/>Marker 2 [T1] -4.79 dBm<br/>4.460000 ms<br/>Center 2.441 GHz 2 ms/</p> <p>Date: 14. JUL. 2017 10:55:33</p>    |

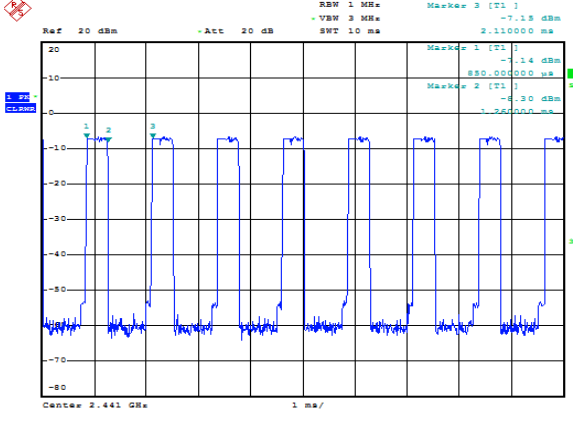
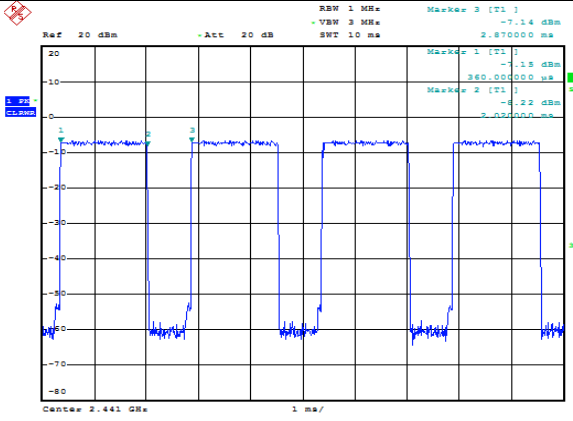
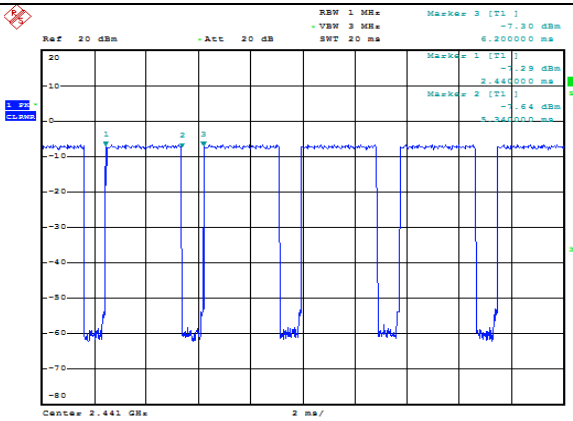
|                      |   |
|----------------------|---|
| <p>GFSK_3DH1/MCH</p> |  <p>Ref 20 dBm -Att 20 dB</p> <p>RBW 1 MHz Marker 3 [T1] -7.15 dBm<br/>VBW 3 MHz SWT 10 ms 2.110000 ms</p> <p>Marker 1 [T1] -1.14 dBm<br/>850.000000 us</p> <p>Marker 2 [T1] -6.30 dBm<br/>1.250000 ms</p> <p>Center 2.441 GHz 1 ms/</p> <p>Date: 14.JUL.2017 11:04:41</p>  |
| <p>GFSK_3DH3/MCH</p> |  <p>Ref 20 dBm -Att 20 dB</p> <p>RBW 1 MHz Marker 3 [T1] -7.14 dBm<br/>VBW 3 MHz SWT 10 ms 2.070000 ms</p> <p>Marker 1 [T1] -1.15 dBm<br/>850.000000 us</p> <p>Marker 2 [T1] -6.22 dBm<br/>1.250000 ms</p> <p>Center 2.441 GHz 1 ms/</p> <p>Date: 14.JUL.2017 11:05:21</p> |
| <p>GFSK_3DH5/MCH</p> |  <p>Ref 20 dBm -Att 20 dB</p> <p>RBW 1 MHz Marker 3 [T1] -7.30 dBm<br/>VBW 3 MHz SWT 20 ms 6.200000 ms</p> <p>Marker 1 [T1] -1.29 dBm<br/>2.440000 ms</p> <p>Marker 2 [T1] -6.54 dBm<br/>1.340000 ms</p> <p>Center 2.441 GHz 2 ms/</p> <p>Date: 14.JUL.2017 10:59:56</p>  |

## 9. Radiated emission

### 9.1. Block diagram of test setup

In 3m Anechoic Chamber Test Setup Diagram for 9KHz-30MHz

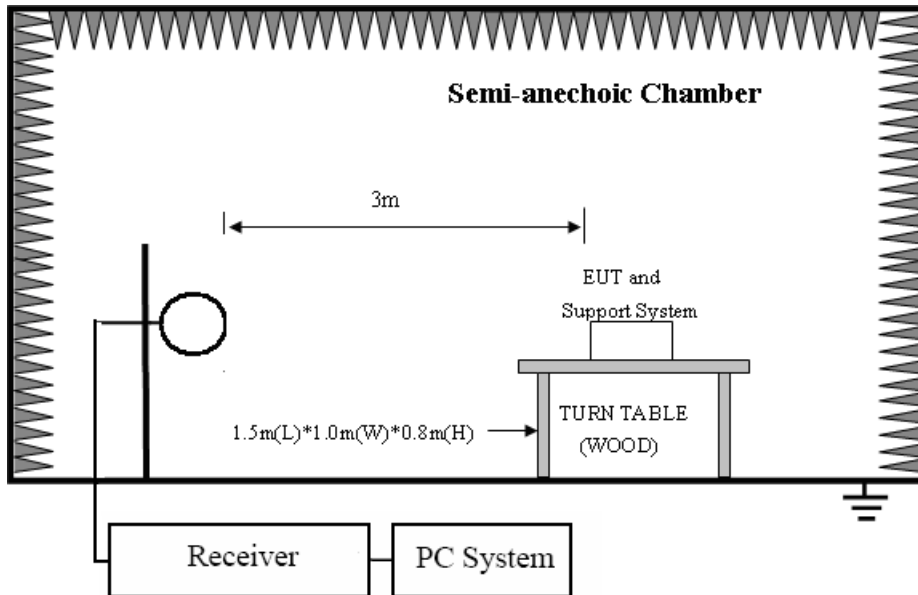

In 3m Anechoic Chamber Test Setup Diagram for below 1GHz

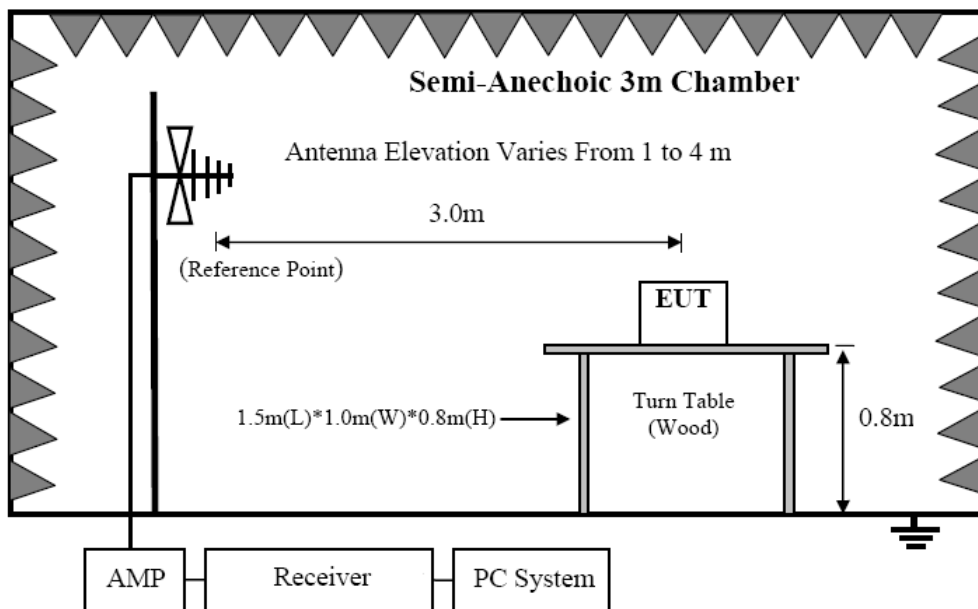

In 3m Anechoic Chamber Test Setup Diagram for frequency above 1GHz

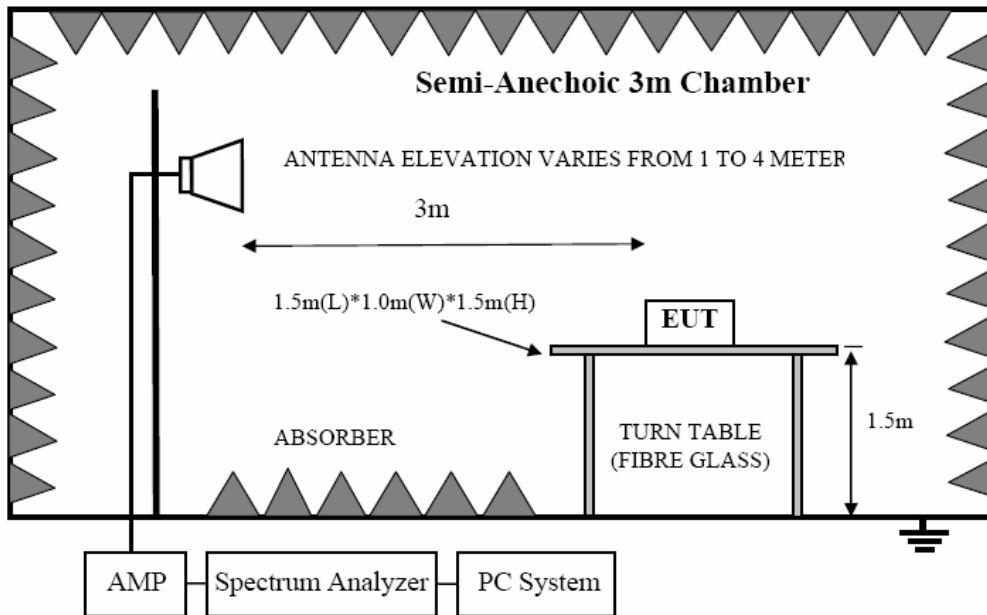

Note: For harmonic emissions test a appropriate high pass filter was inserted in the input port of AMP.

**9.2. Limit**

9.2.1 FCC 15.205 Restricted frequency band

| MHz                        | MHz                   | MHz             | GHz              |
|----------------------------|-----------------------|-----------------|------------------|
| 0.090 - 0.110              | 16.42 - 16.423        | 399.9 - 410     | 4.5 - 5.15       |
| <sup>1</sup> 0.495 - 0.505 | 16.69475 - 16.69525   | 608 - 614       | 5.35 - 5.46      |
| 2.1735 - 2.1905            | 16.80425 - 16.80475   | 960 - 1240      | 7.25 - 7.75      |
| 4.125 - 4.128              | 25.5 - 25.67          | 1300 - 1427     | 8.025 - 8.5      |
| 4.17725 - 4.17775          | 37.5 - 38.25          | 1435 - 1626.5   | 9.0 - 9.2        |
| 4.20725 - 4.20775          | 73 - 74.6             | 1645.5 - 1646.5 | 9.3 - 9.5        |
| 6.215 - 6.218              | 74.8 - 75.2           | 1660 - 1710     | 10.6 - 12.7      |
| 6.26775 - 6.26825          | 108 - 121.94          | 1718.8 - 1722.2 | 13.25 - 13.4     |
| 6.31175 - 6.31225          | 123 - 138             | 2200 - 2300     | 14.47 - 14.5     |
| 8.291 - 8.294              | 149.9 - 150.05        | 2310 - 2390     | 15.35 - 16.2     |
| 8.362 - 8.366              | 156.52475 - 156.52525 | 2483.5 - 2500   | 17.7 - 21.4      |
| 8.37625 - 8.38675          | 156.7 - 156.9         | 2690 - 2900     | 22.01 - 23.12    |
| 8.41425 - 8.41475          | 162.0125 - 167.17     | 3260 - 3267     | 23.6 - 24.0      |
| 12.29 - 12.293             | 167.72 - 173.2        | 3332 - 3339     | 31.2 - 31.8      |
| 12.51975 - 12.52025        | 240 - 285             | 3345.8 - 3358   | 36.43 - 36.5     |
| 12.57675 - 12.57725        | 322 - 335.4           | 3600 - 4400     | ( <sup>2</sup> ) |

9.2.2 FCC 15.209 Limit.

| FREQUENCY<br>MHz | DISTANCE<br>Meters | FIELD STRENGTHS LIMIT |               |
|------------------|--------------------|-----------------------|---------------|
|                  |                    | μV/m                  | dB(μV)/m      |
| 0.009 ~ 0.490    | 300                | 2400/F(KHz)           | 67.6-20log(F) |
| 0.490 ~ 1.705    | 30                 | 24000/F(KHz)          | 87.6-20log(F) |
| 1.705 ~ 30.0     | 30                 | 30                    | 29.54         |
| 30 ~ 88          | 3                  | 100                   | 40.0          |
| 88 ~ 216         | 3                  | 150                   | 43.5          |
| 216 ~ 960        | 3                  | 200                   | 46.0          |
| 960 ~ 1000       | 3                  | 500                   | 54.0          |

|            |   |   |
|------------|---|---|
| Above 1000 | 3 | 74.0 dB( $\mu$ V)/m (Peak)<br>54.0 dB( $\mu$ V)/m (Average) |
|------------|---|---|

Note: (1) The emission limits shown in the above table are based on measurements employing a CISPR QP detector except for the frequency bands 9-90KHz, 110-490KHz and above 1000MHz. Radiated emissions limits in these three bands are based on measurements employing an average detector.

(2) At frequencies below 30MHz, measurement may be performed at a distance closer than that specified, and the limit at closer measurement distance can be extrapolated by below formula:

$$\text{Limit}_{3m}(\text{dBuV/m}) = \text{Limit}_{30m}(\text{dBuV/m}) + 40\text{Log}(30m/3m)$$

### 9.2.3 Limit for this EUT

All the emissions appearing within 15.205 restricted frequency bands shall not exceed the limits shown in 15.209, all the other emissions shall be at least 20dB below the fundamental emissions, or comply with 15.209 limits.

## 9.3. Test Procedure

- (1) EUT was placed on a non-metallic table, 150 cm above the ground plane inside a semi-anechoic chamber.
- (2) Test antenna was located 3m from the EUT on an adjustable mast, and the antenna used as below table.

| Test frequency range | Test antenna used                      |
|----------------------|--|
| 9KHz-30MHz           | Active Loop antenna                    |
| 30MHz-1GHz           | Trilog Broadband Antenna               |
| 1GHz-18GHz           | Double Ridged Horn Antenna(1GHz-18GHz) |
| 18GHz-40GHz          | Horn Antenna(18GHz-40GHz)              |

According ANSI C63.10:2013 clause 6.4.4.2 and 6.5.3, for measurements below 30 MHz, the loop antenna was positioned with its plane vertical from the EUT and rotated about its vertical axis for maximum response at each azimuth position around the EUT. And the loop antenna also be positioned with its plane horizontal at the specified distance from the EUT. The center of the loop is 1 m above the ground. for measurement above 30MHz, the Trilog Broadband Antenna or Horn Antenna was located 3m from EUT, Measurements were made with the antenna positioned in both the horizontal and vertical planes of Polarization, and the measurement antenna was varied from 1 m to 4 m. in height above the reference ground plane to obtain the maximum signal strength.

(3) Below pre-scan procedure was first performed in order to find prominent frequency spectrum radiated emissions from 9KHz to 25GHz:

- (a) Scanning the peak frequency spectrum with the antenna specified in step (3), and the EUT was rotated 360 degree, the antenna height was varied from 1m to 4m(Except loop antenna, it's fixed 1m above ground.)
- (b) Change work frequency or channel of device if practicable.
- (c) Change modulation type of device if practicable.
- (d) Change power supply range from 85% to 115% of the rated supply voltage
- (e) Rotated EUT though three orthogonal axes to determine the attitude of EUT arrangement produces

highest emissions.

Spectrum frequency from 9KHz to 25GHz (tenth harmonic of fundamental frequency) was investigated, and no any obvious emission were detected from 18GHz to 25GHz, so below final test was performed with frequency range from 9KHz to 18GHz.

- (4) For final emissions measurements at each frequency of interest, the EUT was rotated and the antenna height was varied between 1m and 4m in order to maximize the emission. Measurements in both horizontal and vertical polarities were made and the data was recorded. In order to find the maximum emission, the relative positions of equipments and all of the interface cables were changed according to ANSI C63.10 2013 on Radiated Emission test.
- (5) The emissions from 9KHz to 1GHz were measured based on CISPR QP detector except for the frequency bands 9-90KHz, 110-490KHz, for emissions from 9KHz-90KHz,110KHz-490KHz and above 1GHz were measured based on average detector, for emissions above 1GHz, peak emissions also be measured and need comply with Peak limit.
- (6) The emissions from 9KHz to 1GHz, QP or average values were measured with EMI receiver with below RBW.

| Frequency band | RBW    |
|----------------|--------|
| 9KHz-150KHz    | 200Hz  |
| 150KHz-30MHz   | 9KHz   |
| 30MHz-1GHz     | 120KHz |

- (7) For emissions above 1GHz, both Peak and Average level were measured with Spectrum Analyzer, and the RBW is set at 1MHz, VBW is set at 3MHz for Peak measure; RMS detector RBW 1MHz VBW 3MHz for Average measure(according ANSI C63.10:2013 clause 4.2.3.2.3 procedure for average measure).
- (8) X axis, Y axis, Z axis are tested, and worse setup X axis is reported.

#### 9.4. Test result

##### **PASS. (See below detailed test result)**

All the emissions except fundamental emission from 9 KHz to 25GHz were comply with 15.209 limits.

Note1: According exploratory test no any obvious emission were detected from 9KHz to 30MHz and 18GHz to 25GHz, so the final test was performed with frequency range from 30MHz to 18GHz and recorded in below.

Note2: For emissions below 1GHz, according exploratory explorer test, when change Tx mode and channel, have no distinct influence on emissions level, so for emissions below 1GHz, the final test was only performed with EUT working in GFSK, Tx 2441MHz mode.

Note3: For emissions above 1GHz. If peak results comply with AV limit, AV Result is deemed to comply with AV limit.

**Radiated Emission test (below 1GHz)**

**TR-4-E-009 Radiated Emission Test Result**

|                     |   |  |
|---------------------|---|--|
| <b>Test Site</b>    | : DDT 3m Chamber 2#                       | E:\2017 RE2# Report Data\17Q0628-12\RE.EM6               |
| <b>Test Date</b>    | : 2017-08-01                              | <b>Tested By</b> : Jerry                                 |
| <b>EUT</b>          | : Car Radio                               | <b>Model Number</b> : TRD7412UBA-OR/CAT, 524-3711-01     |
| <b>Power Supply</b> | : DC 12V                                  | <b>Test Mode</b> : Tx mode                               |
| <b>Condition</b>    | : Temp:24.5°C,Humi:55%,<br>Press:100.1kPa | <b>Antenna/Distance</b> : 2016 VULB9163 2#/3m/HORIZONTAL |
| <b>Memo</b>         | :   |  |

Data: 11

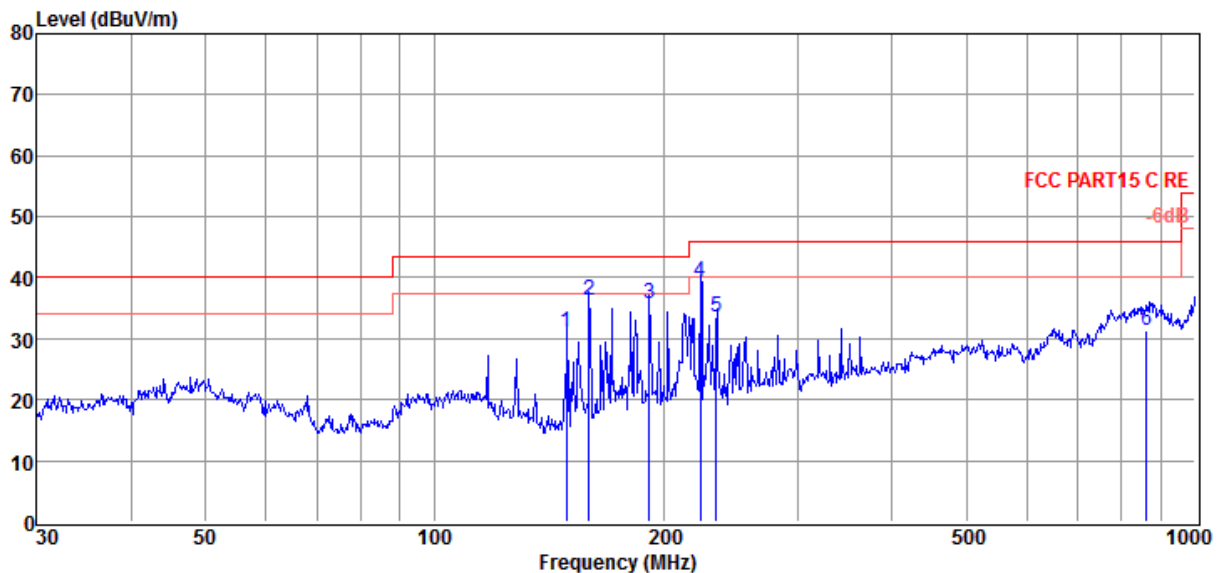

| Item (Mark) | Freq. (MHz) | Read Level (dBμV) | Antenna Factor (dB/m) | Cable Loss (dB) | Result Level (dBUV/m) | Limit Line (dBUV/m) | Over Limit (dB) | Detector | Polarization |
|-------------|-------------|-------------------|-----------------------|-----------------|-----------------------|---------------------|-----------------|----------|--------------|
| 1           | 149.12      | 19.52             | 7.33                  | 4.23            | 31.08                 | 43.50               | -12.42          | QP       | HORIZONTAL   |
| 2           | 159.75      | 24.15             | 7.89                  | 4.27            | 36.31                 | 43.50               | -7.19           | QP       | HORIZONTAL   |
| 3           | 191.61      | 21.16             | 10.17                 | 4.38            | 35.71                 | 43.50               | -7.79           | QP       | HORIZONTAL   |
| 4           | 223.55      | 23.53             | 11.18                 | 4.52            | 39.23                 | 46.00               | -6.77           | QP       | HORIZONTAL   |
| 5           | 234.65      | 17.16             | 11.77                 | 4.58            | 33.51                 | 46.00               | -12.49          | QP       | HORIZONTAL   |
| 6           | 863.06      | 2.26              | 22.47                 | 6.55            | 31.28                 | 46.00               | -14.72          | QP       | HORIZONTAL   |

- Note: 1. Result Level = Read Level + Antenna Factor + Cable loss.  
 2. If Peak Result complies with QP limit, QP Result is deemed to comply with QP limit.  
 3. Test setup: RBW: 120 kHz, VBW: 300 kHz, Sweep time: auto.



# TR-4-E-009 Radiated Emission Test Result

**Test Site** : DDT 3m Chamber 2# E:\2017 RE2# Report Data\17Q0628-12\RE.EM6  
**Test Date** : 2017-08-01 **Tested By** : Jerry  
**EUT** : Car Radio **Model Number** : TRD7412UBA-OR/CAT, 524-3711-01  
**Power Supply** : DC 12V **Test Mode** : Tx mode  
**Condition** : Temp:24.5°C,Humi:55%,  
 : Press:100.1kPa **Antenna/Distance** : 2016 VULB9163 2#/3m/VERTICAL  
**Memo** :

Data: 12

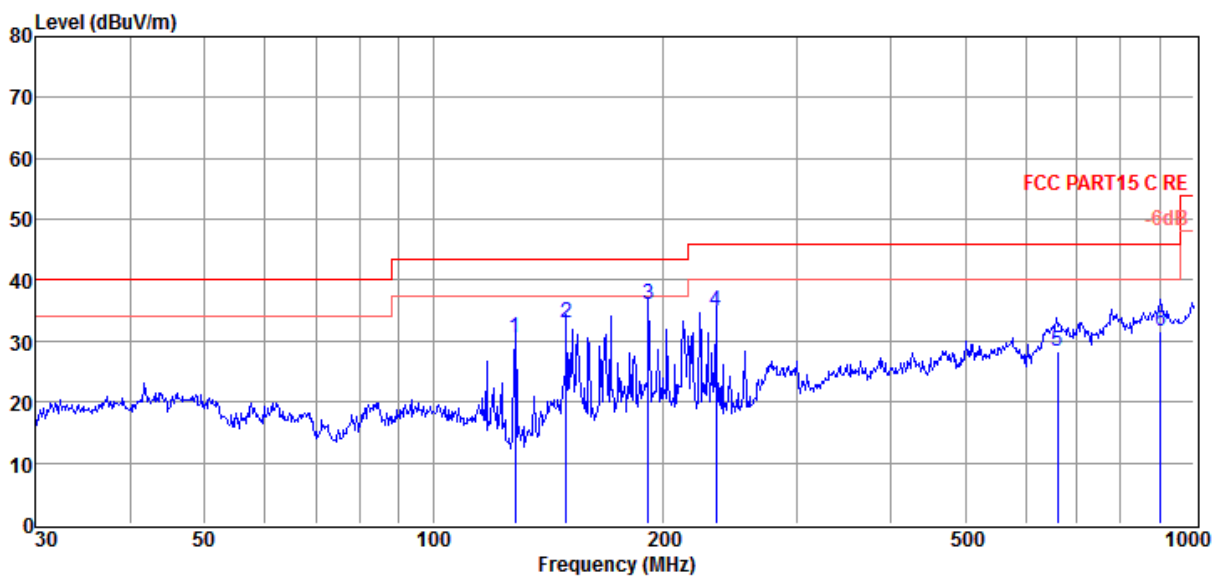

| Item (Mark) | Freq. (MHz) | Read Level (dBuV) | Antenna Factor (dB/m) | Cable Loss (dB) | Result Level (dBuV/m) | Limit Line (dBuV/m) | Over Limit (dB) | Detector | Polarization |
|-------------|-------------|-------------------|-----------------------|-----------------|-----------------------|---------------------|-----------------|----------|--------------|
| 1           | 128.20      | 18.52             | 7.82                  | 4.14            | 30.48                 | 43.50               | -13.02          | QP       | VERTICAL     |
| 2           | 149.48      | 21.54             | 7.34                  | 4.23            | 33.11                 | 43.50               | -10.39          | QP       | VERTICAL     |
| 3           | 191.71      | 21.54             | 10.18                 | 4.38            | 36.10                 | 43.50               | -7.40           | QP       | VERTICAL     |
| 4           | 234.97      | 18.51             | 11.78                 | 4.58            | 34.87                 | 46.00               | -11.13          | QP       | VERTICAL     |
| 5           | 661.51      | 0.99              | 21.35                 | 6.02            | 28.36                 | 46.00               | -17.64          | QP       | VERTICAL     |
| 6           | 903.31      | 2.00              | 22.89                 | 6.68            | 31.57                 | 46.00               | -14.43          | QP       | VERTICAL     |

- Note: 1. Result Level = Read Level + Antenna Factor + Cable loss.  
 2. If Peak Result complies with QP limit, QP Result is deemed to comply with QP limit.  
 3. Test setup: RBW: 120 kHz, VBW: 300 kHz, Sweep time: auto.

**Radiated Emission test (above 1GHz)**

| Freq (MHz)                | Read level (dB $\mu$ V) | Antenna Factor (dB/m) | PRM Factor (dB) | Cable Loss (dB) | Result Level (dB $\mu$ V/m) | Limit (dB $\mu$ V/m) | Margin (dB) | Detector type | Polarization |
|---------------------------|-------------------------|-----------------------|-----------------|-----------------|-----------------------------|----------------------|-------------|---------------|--------------|
| GFSK Tx mode 2402MHz      |                         |                       |                 |                 |                             |                      |             |               |              |
| 1329.00                   | 48.63                   | 24.73                 | 29.37           | 4.49            | 48.48                       | 74.00                | -25.52      | Peak          | VERTICAL     |
| 3583.00                   | 38.78                   | 32.16                 | 29.38           | 7.34            | 48.90                       | 74.00                | -25.10      | Peak          | VERTICAL     |
| 3996.00                   | 38.00                   | 33.39                 | 29.05           | 7.61            | 49.95                       | 74.00                | -24.05      | Peak          | VERTICAL     |
| 5396.00                   | 35.70                   | 34.50                 | 29.29           | 9.09            | 50.00                       | 74.00                | -24.00      | Peak          | VERTICAL     |
| 6054.00                   | 36.31                   | 35.09                 | 29.23           | 9.71            | 51.88                       | 74.00                | -22.12      | Peak          | VERTICAL     |
| 6754.00                   | 36.66                   | 36.01                 | 30.18           | 10.19           | 52.68                       | 74.00                | -21.32      | Peak          | VERTICAL     |
| 3891.00                   | 37.96                   | 33.09                 | 29.10           | 7.54            | 49.49                       | 74.00                | -24.51      | Peak          | HORIZONTAL   |
| 4738.00                   | 37.19                   | 33.75                 | 29.30           | 8.42            | 50.06                       | 74.00                | -23.94      | Peak          | HORIZONTAL   |
| 5382.00                   | 36.12                   | 34.47                 | 29.30           | 9.05            | 50.34                       | 74.00                | -23.66      | Peak          | HORIZONTAL   |
| 6243.00                   | 36.02                   | 35.40                 | 29.42           | 9.81            | 51.81                       | 74.00                | -22.19      | Peak          | HORIZONTAL   |
| 6873.00                   | 37.10                   | 36.10                 | 30.30           | 10.31           | 53.21                       | 74.00                | -20.79      | Peak          | HORIZONTAL   |
| 7524.00                   | 36.07                   | 36.60                 | 30.81           | 10.87           | 52.73                       | 74.00                | -21.27      | Peak          | HORIZONTAL   |
| GFSK Tx mode 2441MHz      |                         |                       |                 |                 |                             |                      |             |               |              |
| 1329.00                   | 48.11                   | 24.73                 | 29.37           | 4.49            | 47.96                       | 74.00                | -26.04      | Peak          | VERTICAL     |
| 3198.00                   | 38.94                   | 31.78                 | 30.05           | 6.98            | 47.65                       | 74.00                | -26.35      | Peak          | VERTICAL     |
| 4115.00                   | 37.53                   | 33.50                 | 29.06           | 7.75            | 49.72                       | 74.00                | -24.28      | Peak          | VERTICAL     |
| 4724.00                   | 36.87                   | 33.75                 | 29.30           | 8.39            | 49.71                       | 74.00                | -24.29      | Peak          | VERTICAL     |
| 6047.00                   | 36.38                   | 35.08                 | 29.23           | 9.71            | 51.94                       | 74.00                | -22.06      | Peak          | VERTICAL     |
| 6943.00                   | 36.23                   | 36.16                 | 30.34           | 10.39           | 52.44                       | 74.00                | -21.56      | Peak          | VERTICAL     |
| 1329.00                   | 44.48                   | 24.73                 | 29.37           | 4.49            | 44.33                       | 74.00                | -29.67      | Peak          | HORIZONTAL   |
| 3702.00                   | 37.45                   | 32.53                 | 29.23           | 7.42            | 48.17                       | 74.00                | -25.83      | Peak          | HORIZONTAL   |
| 4976.00                   | 36.53                   | 33.70                 | 29.35           | 8.65            | 49.53                       | 74.00                | -24.47      | Peak          | HORIZONTAL   |
| 5970.00                   | 35.94                   | 34.98                 | 29.19           | 9.66            | 51.39                       | 74.00                | -22.61      | Peak          | HORIZONTAL   |
| 6677.00                   | 36.74                   | 35.95                 | 30.12           | 10.12           | 52.69                       | 74.00                | -21.31      | Peak          | HORIZONTAL   |
| 7657.00                   | 36.17                   | 36.63                 | 30.94           | 10.94           | 52.80                       | 74.00                | -21.20      | Peak          | HORIZONTAL   |
| GFSK Tx mode 2480MHz      |                         |                       |                 |                 |                             |                      |             |               |              |
| 1329.00                   | 47.22                   | 24.73                 | 29.37           | 4.49            | 47.07                       | 74.00                | -26.93      | Peak          | VERTICAL     |
| 4073.00                   | 37.88                   | 33.46                 | 29.05           | 7.69            | 49.98                       | 74.00                | -24.02      | Peak          | VERTICAL     |
| 4962.00                   | 37.50                   | 33.71                 | 29.35           | 8.65            | 50.51                       | 74.00                | -23.49      | Peak          | VERTICAL     |
| 6215.00                   | 35.98                   | 35.35                 | 29.40           | 9.80            | 51.73                       | 74.00                | -22.27      | Peak          | VERTICAL     |
| 7048.00                   | 36.62                   | 36.24                 | 30.41           | 10.47           | 52.92                       | 74.00                | -21.08      | Peak          | VERTICAL     |
| 7909.00                   | 35.47                   | 36.68                 | 31.09           | 11.09           | 52.15                       | 74.00                | -21.85      | Peak          | VERTICAL     |
| 1329.00                   | 43.13                   | 24.73                 | 29.37           | 4.49            | 42.98                       | 74.00                | -31.02      | Peak          | HORIZONTAL   |
| 3758.00                   | 37.90                   | 32.70                 | 29.19           | 7.45            | 48.86                       | 74.00                | -25.14      | Peak          | HORIZONTAL   |
| 4066.00                   | 37.34                   | 33.46                 | 29.05           | 7.69            | 49.44                       | 74.00                | -24.56      | Peak          | HORIZONTAL   |
| 5704.00                   | 36.41                   | 34.83                 | 29.22           | 9.38            | 51.40                       | 74.00                | -22.60      | Peak          | HORIZONTAL   |
| 6432.00                   | 35.36                   | 35.69                 | 29.70           | 9.90            | 51.25                       | 74.00                | -22.75      | Peak          | HORIZONTAL   |
| 7748.00                   | 35.98                   | 36.65                 | 31.00           | 10.99           | 52.62                       | 74.00                | -21.38      | Peak          | HORIZONTAL   |
| Result: Pass              |                         |                       |                 |                 |                             |                      |             |               |              |
| Test Date : Jul. 26, 2016 |                         |                       |                 |                 | Test Engineer : Toby Ren    |                      |             |               |              |

Note: 1.30MHz~18GHz: (Scan with GFSK,  $\pi/4$  QPSK, 8-DPSK, the worst case is GFSK Mode)

2. Result Level = Read Level + Antenna Factor + Cable loss - PRM Factor.

3: For emissions above 1GHz. If peak results comply with AV limit, AV Result is deemed to comply with

AV limit.

## 10. Band Edge Compliance (radiated method)

### 10.1. Block diagram of test setup

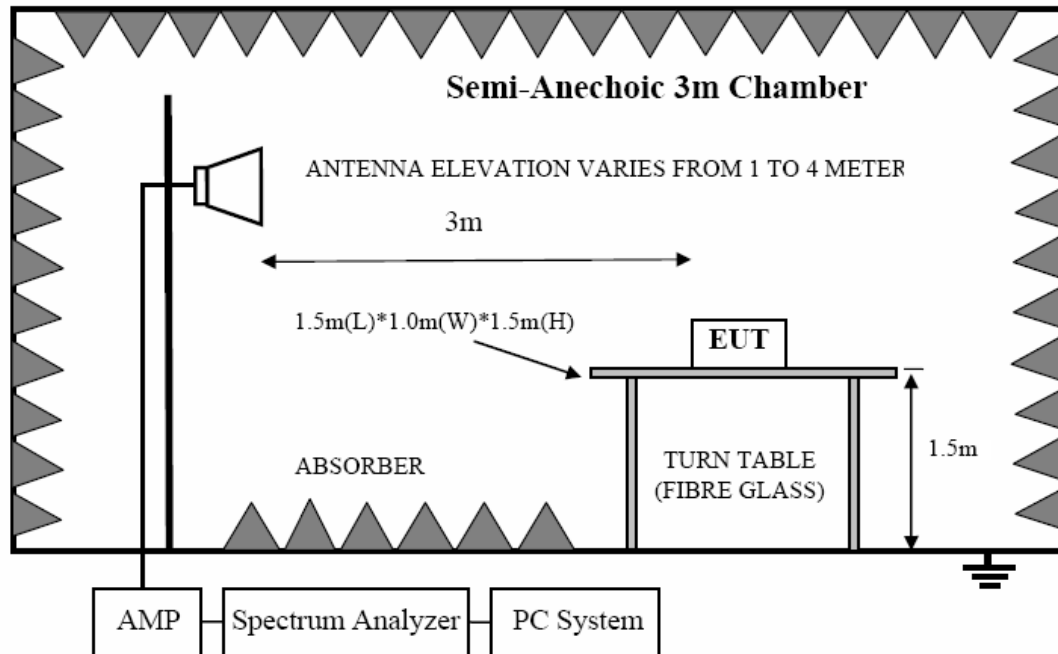

### 10.2. Limit

All restriction band should comply with 15.209, other emission should be at least 20dB below the fundamental.

### 10.3. Test Procedure

Same with clause 9.3 except change investigated frequency range from 2310MHz to 2415MHz and 2475MHz to 2500MHz.

Remark: All restriction band have been tested, and only the worse case is shown in report.

### 10.4. Test result

**PASS.** (See below detailed test result)

**Remark:** hopping on and hopping off mode all have been test, hopping off mode is worse and reported only.

## TR-4-E-009 Radiated Emission Test Result

|  |  |
|--|--|
| <b>Test Site</b> : DDT 3m Chamber 1#                       | D:\2017 RE1# Report Data\17Q0628-12\RF FCC 1G-8G.EM6 |
| <b>Test Date</b> : 2017-07-26                              | <b>Tested By</b> : Sunny                             |
| <b>EUT</b> : Car Radio                                     | <b>Model Number</b> : TRD7412UBA-OR/CAT, 524-3711-01 |
| <b>Power Supply</b> : DC 12V                               | <b>Test Mode</b> : TX mode                           |
| <b>Condition</b> : Temp:24.5°C,Humi:55%,<br>Press:100.1kPa | <b>Antenna/Distance</b> : 2016 HF907/3m/HORIZONTAL   |
| <b>Memo</b> : GFSK 2402MHz                                 |  |

Data: 3

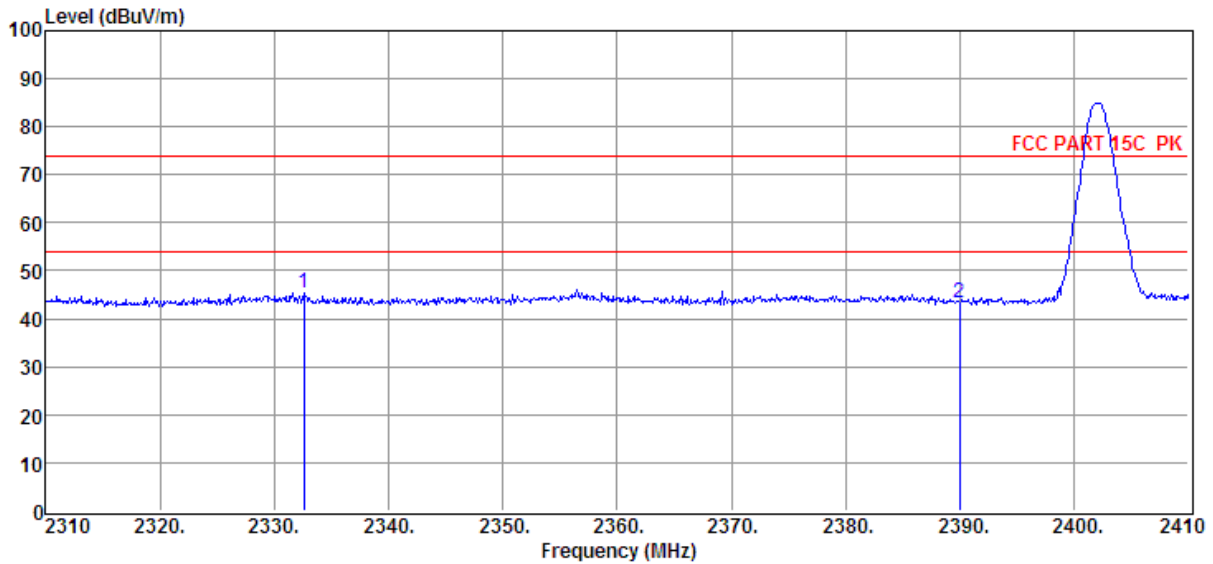

| Item<br>(Mark) | Freq.<br>(MHz) | Read<br>Level<br>(dBμV) | Antenna<br>Factor<br>(dB/m) | PRM<br>Factor<br>dB | Cable<br>Loss<br>dB | Result<br>Level<br>(dBμV/m) | Limit<br>Line<br>(dBμV/m) | Over<br>Limit<br>(dB) | Detector | Polarization |
|----------------|----------------|-------------------------|-----------------------------|---------------------|---------------------|-----------------------------|---------------------------|-----------------------|----------|--------------|
| 1              | 2332.60        | 39.24                   | 29.55                       | 29.31               | 5.94                | 45.42                       | 74.00                     | -28.58                | Peak     | HORIZONTAL   |
| 2              | 2390.00        | 36.86                   | 29.78                       | 29.42               | 6.03                | 43.25                       | 74.00                     | -30.75                | Peak     | HORIZONTAL   |

- Note: 1. Result Level = Read Level + Antenna Factor + Cable loss - PRM Factor.  
 2. If Peak Result complies with AV limit, AV Result is deemed to comply with AV limit.  
 3. Test setup: RBW: 1 MHz, VBW: 3 MHz, Sweep time: auto.  
 4. For emissions above 1GHz. If peak results comply with AV limit, AV Result is deemed to comply with AV limit.

# TR-4-E-009 Radiated Emission Test Result

**Test Site** : DDT 3m Chamber 1# **D:\2017 RE1# Report Data\17Q0628-12\RF FCC 1G-8G.EM6**  
**Test Date** : 2017-07-26 **Tested By** : Sunny  
**EUT** : Car Radio **Model Number** : TRD7412UBA-OR/CAT, 524-3711-01  
**Power Supply** : DC 12V **Test Mode** : TX mode  
**Condition** : Temp:24.5°C,Humi:55%,  
 Press:100.1kPa **Antenna/Distance** : 2016 HF907/3m/VERTICAL  
**Memo** : GFSK 2402MHz

Data: 4

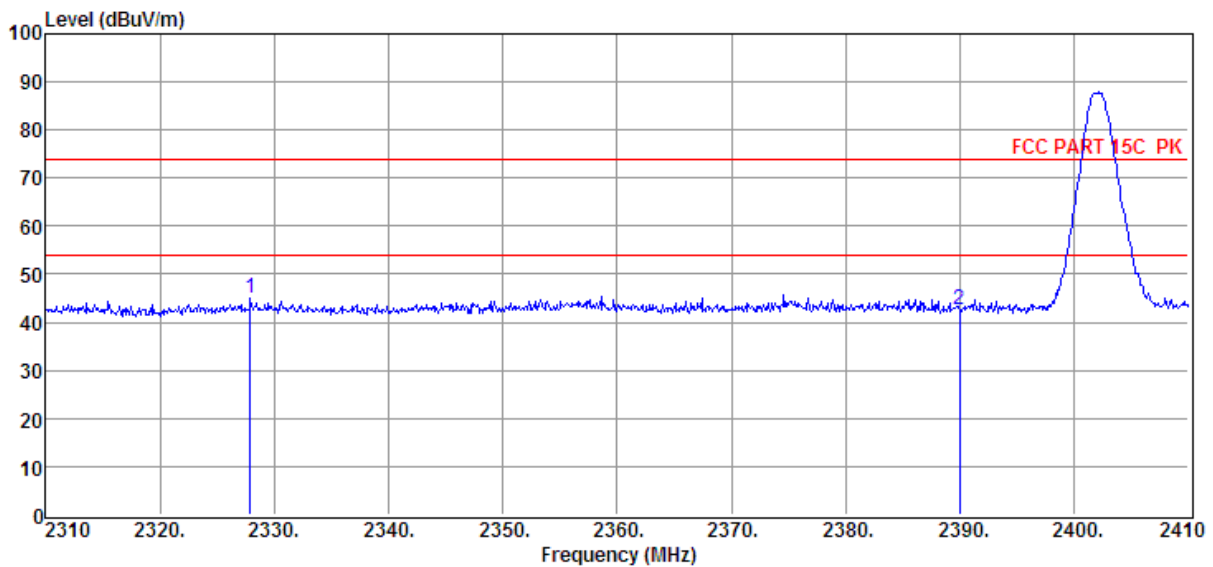

| Item<br>(Mark) | Freq.<br>(MHz) | Read<br>Level<br>(dBμV) | Antenna<br>Factor<br>(dB/m) | PRM<br>Factor<br>dB | Cable<br>Loss<br>dB | Result<br>Level<br>(dBμV/m) | Limit<br>Line<br>(dBμV/m) | Over<br>Limit<br>(dB) | Detector | Polarization |
|----------------|----------------|-------------------------|-----------------------------|---------------------|---------------------|-----------------------------|---------------------------|-----------------------|----------|--------------|
| 1              | 2327.90        | 38.71                   | 29.53                       | 29.31               | 5.94                | 44.87                       | 74.00                     | -29.13                | Peak     | VERTICAL     |
| 2              | 2390.00        | 36.09                   | 29.78                       | 29.42               | 6.03                | 42.48                       | 74.00                     | -31.52                | Peak     | VERTICAL     |

- Note: 1. Result Level = Read Level + Antenna Factor + Cable loss - PRM Factor.  
 2. If Peak Result complies with AV limit, AV Result is deemed to comply with AV limit.  
 3. Test setup: RBW: 1 MHz, VBW: 3 MHz, Sweep time: auto.  
 4. For emissions above 1GHz. If peak results comply with AV limit, AV Result is deemed to comply with AV limit.

# TR-4-E-009 Radiated Emission Test Result

**Test Site** : DDT 3m Chamber 1# D:\2017 RE1# Report Data\17Q0628-12\RF FCC 1G-8G.EM6  
**Test Date** : 2017-07-26 **Tested By** : Sunny  
**EUT** : Car Radio **Model Number** : TRD7412UBA-OR/CAT, 524-3711-01  
**Power Supply** : DC 12V **Test Mode** : TX mode  
**Condition** : Temp:24.5°C,Humi:55%,  
 Press:100.1kPa **Antenna/Distance** : 2016 HF907/3m/VERTICAL  
**Memo** : GFSK 2480MHz

Data: 9

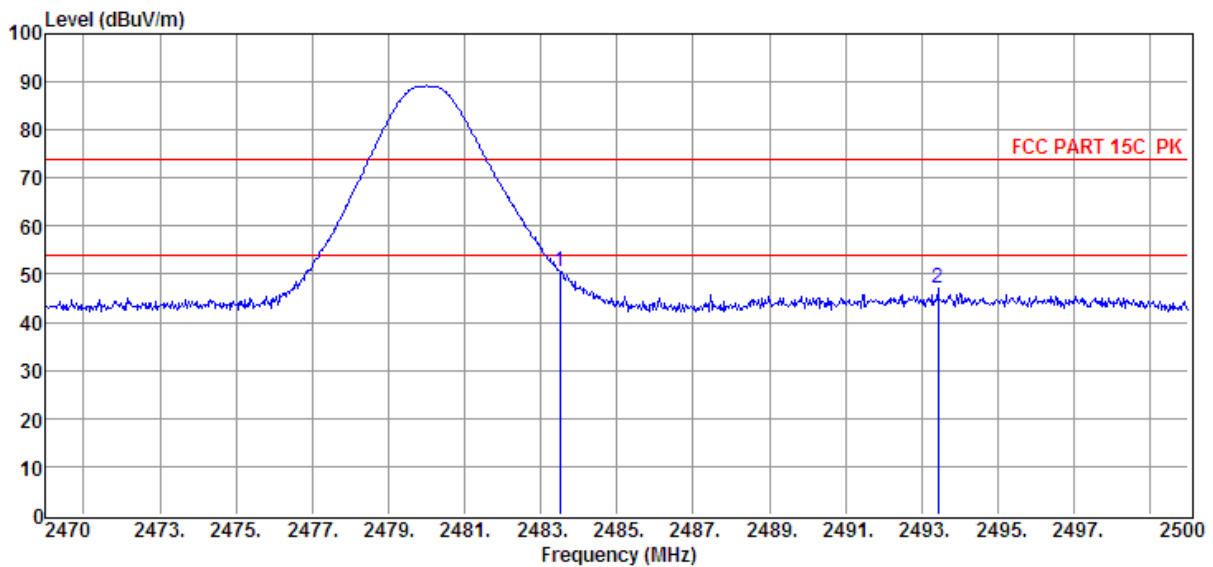

| Item<br>(Mark) | Freq.<br>(MHz) | Read<br>Level<br>(dBμV) | Antenna<br>Factor<br>(dB/m) | PRM<br>Factor<br>dB | Cable<br>Loss<br>dB | Result<br>Level<br>(dBμV/m) | Limit<br>Line<br>(dBμV/m) | Over<br>Limit<br>(dB) | Detector | Polarization |
|----------------|----------------|-------------------------|-----------------------------|---------------------|---------------------|-----------------------------|---------------------------|-----------------------|----------|--------------|
| 1              | 2483.50        | 43.94                   | 30.14                       | 29.71               | 6.13                | 50.50                       | 74.00                     | -23.50                | Peak     | VERTICAL     |
| 2              | 2493.43        | 40.30                   | 30.18                       | 29.73               | 6.17                | 46.92                       | 74.00                     | -27.08                | Peak     | VERTICAL     |

- Note: 1. Result Level = Read Level + Antenna Factor + Cable loss - PRM Factor.  
 2. If Peak Result complies with AV limit, AV Result is deemed to comply with AV limit.  
 3. Test setup: RBW: 1 MHz, VBW: 3 MHz, Sweep time: auto.  
 4. For emissions above 1GHz. If peak results comply with AV limit, AV Result is deemed to comply with AV limit.

# TR-4-E-009 Radiated Emission Test Result

**Test Site** : DDT 3m Chamber 1# D:\2017 RE1# Report Data\17Q0628-12\RF FCC 1G-8G.EM6  
**Test Date** : 2017-07-26 **Tested By** : Sunny  
**EUT** : Car Radio **Model Number** : TRD7412UBA-OR/CAT, 524-3711-01  
**Power Supply** : DC 12V **Test Mode** : TX mode  
**Condition** : Temp:24.5°C,Humi:55%,  
 Press:100.1kPa **Antenna/Distance** : 2016 HF907/3m/HORIZONTAL  
**Memo** : GFSK 2480MHz

Data: 10

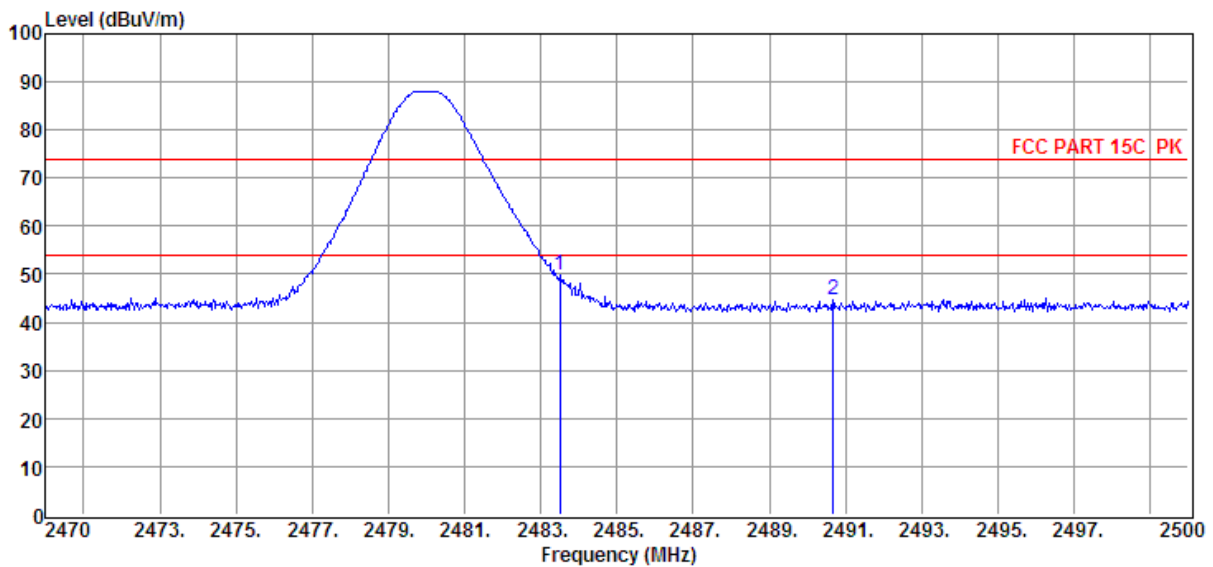

| Item<br>(Mark) | Freq.<br>(MHz) | Read<br>Level<br>(dBμV) | Antenna<br>Factor<br>(dB/m) | PRM<br>Factor<br>dB | Cable<br>Loss<br>dB | Result<br>Level<br>(dBμV/m) | Limit<br>Line<br>(dBμV/m) | Over<br>Limit<br>(dB) | Detector | Polarization |
|----------------|----------------|-------------------------|-----------------------------|---------------------|---------------------|-----------------------------|---------------------------|-----------------------|----------|--------------|
| 1              | 2483.50        | 43.16                   | 30.14                       | 29.71               | 6.13                | 49.72                       | 74.00                     | -24.28                | Peak     | HORIZONTAL   |
| 2              | 2490.67        | 38.10                   | 30.16                       | 29.73               | 6.17                | 44.70                       | 74.00                     | -29.30                | Peak     | HORIZONTAL   |

- Note: 1. Result Level = Read Level + Antenna Factor + Cable loss - PRM Factor.  
 2. If Peak Result complies with AV limit, AV Result is deemed to comply with AV limit.  
 3. Test setup: RBW: 1 MHz, VBW: 3 MHz, Sweep time: auto.  
 4. For emissions above 1GHz. If peak results comply with AV limit, AV Result is deemed to comply with AV limit.

# TR-4-E-009 Radiated Emission Test Result

**Test Site** : DDT 3m Chamber 1# D:\2017 RE1# Report Data\17Q0628-12\RF FCC 1G-8G.EM6  
**Test Date** : 2017-07-26 **Tested By** : Sunny  
**EUT** : Car Radio **Model Number** : TRD7412UBA-OR/CAT, 524-3711-01  
**Power Supply** : DC 12V **Test Mode** : TX mode  
**Condition** : Temp:24.5°C,Humi:55%,  
 Press:100.1kPa **Antenna/Distance** : 2016 HF907/3m/HORIZONTAL  
**Memo** : 8-DPSK 2480MHz

Data: 11

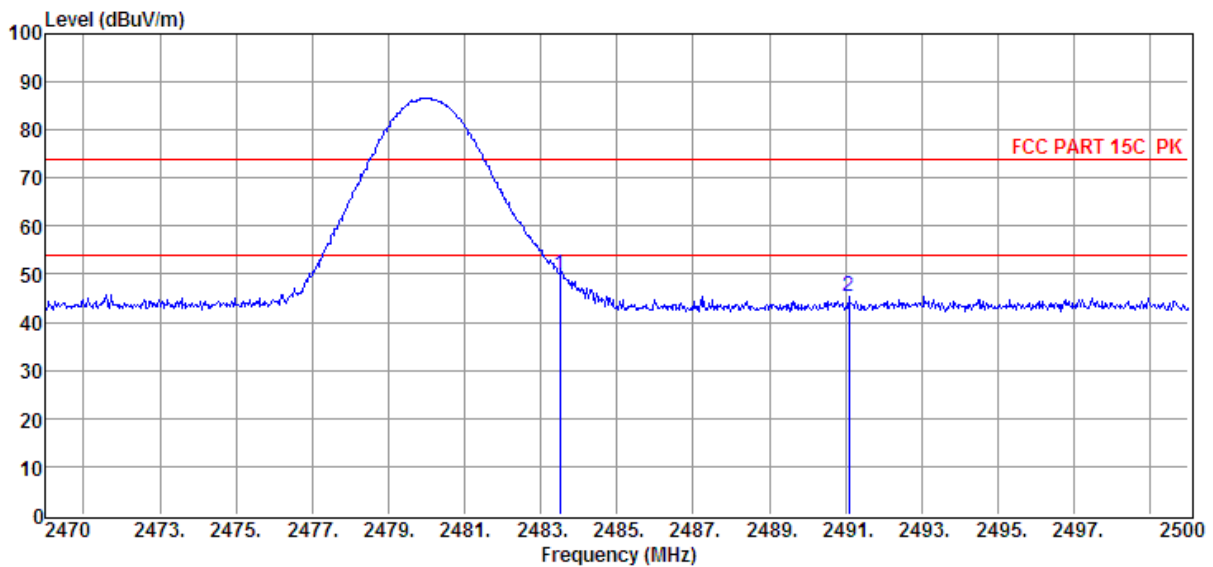

| Item<br>(Mark) | Freq.<br>(MHz) | Read<br>Level<br>(dBμV) | Antenna<br>Factor<br>(dB/m) | PRM<br>Factor<br>dB | Cable<br>Loss<br>dB | Result<br>Level<br>(dBμV/m) | Limit<br>Line<br>(dBμV/m) | Over<br>Limit<br>(dB) | Detector | Polarization |
|----------------|----------------|-------------------------|-----------------------------|---------------------|---------------------|-----------------------------|---------------------------|-----------------------|----------|--------------|
| 1              | 2483.50        | 43.35                   | 30.14                       | 29.71               | 6.13                | 49.91                       | 74.00                     | -24.09                | Peak     | HORIZONTAL   |
| 2              | 2491.09        | 38.72                   | 30.17                       | 29.73               | 6.17                | 45.33                       | 74.00                     | -28.67                | Peak     | HORIZONTAL   |

- Note: 1. Result Level = Read Level + Antenna Factor + Cable loss - PRM Factor.  
 2. If Peak Result complies with AV limit, AV Result is deemed to comply with AV limit.  
 3. Test setup: RBW: 1 MHz, VBW: 3 MHz, Sweep time: auto.  
 4. For emissions above 1GHz. If peak results comply with AV limit, AV Result is deemed to comply with AV limit.



# TR-4-E-009 Radiated Emission Test Result

**Test Site** : DDT 3m Chamber 1# D:\2017 RE1# Report Data\17Q0628-12\RF FCC 1G-8G.EM6  
**Test Date** : 2017-07-26 **Tested By** : Sunny  
**EUT** : Car Radio **Model Number** : TRD7412UBA-OR/CAT, 524-3711-01  
**Power Supply** : DC 12V **Test Mode** : TX mode  
**Condition** : Temp:24.5°C,Humi:55%,  
 Press:100.1kPa **Antenna/Distance** : 2016 HF907/3m/VERTICAL  
**Memo** : 8-DPSK 2480MHz

Data: 12

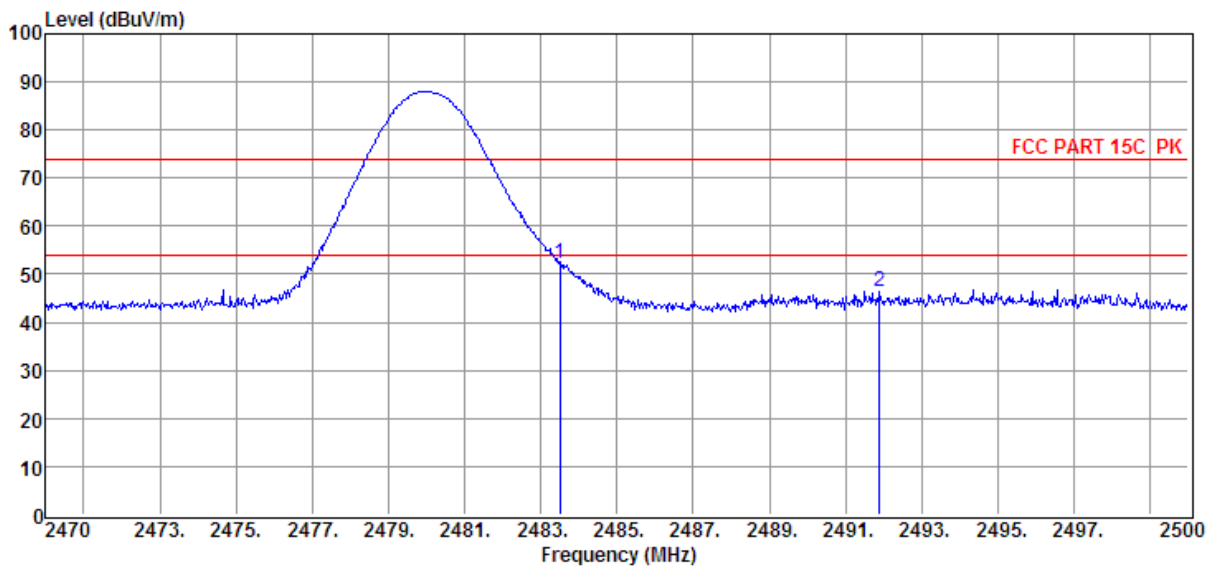

| Item<br>(Mark) | Freq.<br>(MHz) | Read<br>Level<br>(dBμV) | Antenna<br>Factor<br>(dB/m) | PRM<br>Factor<br>dB | Cable<br>Loss<br>dB | Result<br>Level<br>(dBμV/m) | Limit<br>Line<br>(dBμV/m) | Over<br>Limit<br>(dB) | Detector | Polarization |
|----------------|----------------|-------------------------|-----------------------------|---------------------|---------------------|-----------------------------|---------------------------|-----------------------|----------|--------------|
| 1              | 2483.50        | 45.79                   | 30.14                       | 29.71               | 6.13                | 52.35                       | 74.00                     | -21.65                | Peak     | VERTICAL     |
| 2              | 2491.90        | 39.95                   | 30.17                       | 29.73               | 6.17                | 46.56                       | 74.00                     | -27.44                | Peak     | VERTICAL     |

- Note: 1. Result Level = Read Level + Antenna Factor + Cable loss - PRM Factor.  
 2. If Peak Result complies with AV limit, AV Result is deemed to comply with AV limit.  
 3. Test setup: RBW: 1 MHz, VBW: 3 MHz, Sweep time: auto.  
 4. For emissions above 1GHz. If peak results comply with AV limit, AV Result is deemed to comply with AV limit.

## TR-4-E-009 Radiated Emission Test Result

|                     |   |                         |                                  |
|---------------------|---|-------------------------|----------------------------------|
| <b>Test Site</b>    | : DDT 3m Chamber 1#                       | <b>Tested By</b>        | : Sunny                          |
| <b>Test Date</b>    | : 2017-07-26                              | <b>Model Number</b>     | : TRD7412UBA-OR/CAT, 524-3711-01 |
| <b>EUT</b>          | : Car Radio                               | <b>Test Mode</b>        | : TX mode                        |
| <b>Power Supply</b> | : DC 12V                                  | <b>Antenna/Distance</b> | : 2016 HF907/3m/VERTICAL         |
| <b>Condition</b>    | : Temp:24.5°C,Humi:55%,<br>Press:100.1kPa |                         |                                  |
| <b>Memo</b>         | : 8-DPSK 2402MHz                          |                         |                                  |

Data: 13

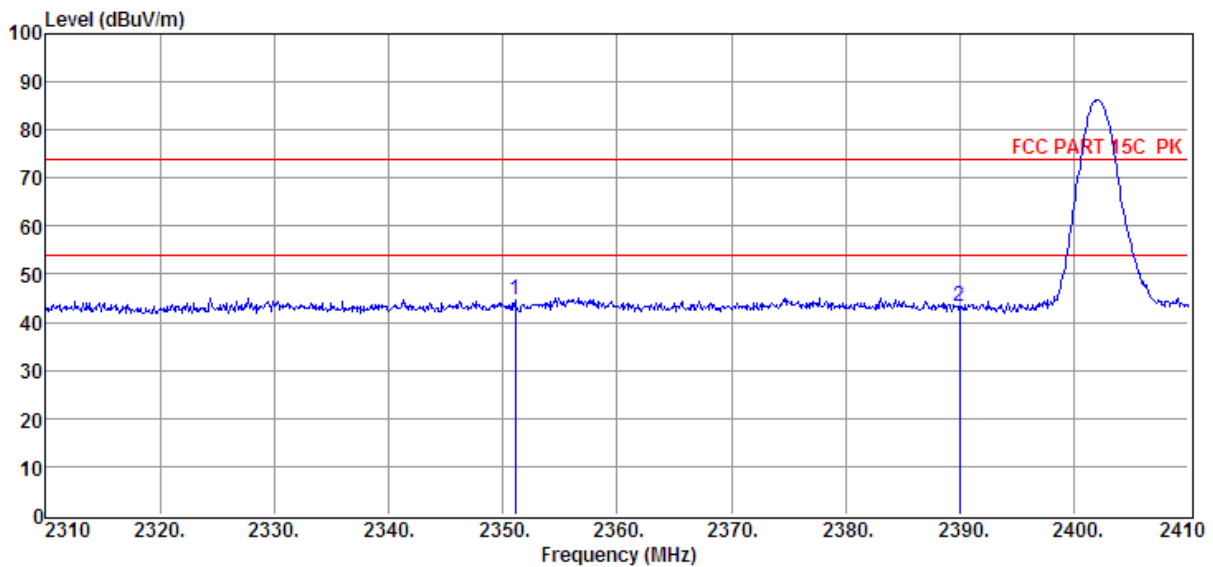

| Item<br>(Mark) | Freq.<br>(MHz) | Read<br>Level<br>(dBμV) | Antenna<br>Factor<br>(dB/m) | PRM<br>Factor<br>dB | Cable<br>Loss<br>dB | Result<br>Level<br>(dBμV/m) | Limit<br>Line<br>(dBμV/m) | Over<br>Limit<br>(dB) | Detector | Polarization |
|----------------|----------------|-------------------------|-----------------------------|---------------------|---------------------|-----------------------------|---------------------------|-----------------------|----------|--------------|
| 1              | 2351.10        | 38.53                   | 29.62                       | 29.34               | 5.96                | 44.77                       | 74.00                     | -29.23                | Peak     | VERTICAL     |
| 2              | 2390.00        | 36.95                   | 29.78                       | 29.42               | 6.03                | 43.34                       | 74.00                     | -30.66                | Peak     | VERTICAL     |

- Note: 1. Result Level = Read Level + Antenna Factor + Cable loss - PRM Factor.  
 2. If Peak Result complies with AV limit, AV Result is deemed to comply with AV limit.  
 3. Test setup: RBW: 1 MHz, VBW: 3 MHz, Sweep time: auto.  
 4. For emissions above 1GHz. If peak results comply with AV limit, AV Result is deemed to comply with AV limit.

# TR-4-E-009 Radiated Emission Test Result

**Test Site** : DDT 3m Chamber 1# D:\2017 RE1# Report Data\17Q0628-12\RF FCC 1G-8G.EM6  
**Test Date** : 2017-07-26 **Tested By** : Sunny  
**EUT** : Car Radio **Model Number** : TRD7412UBA-OR/CAT, 524-3711-01  
**Power Supply** : DC 12V **Test Mode** : TX mode  
**Condition** : Temp:24.5°C,Humi:55%,  
 Press:100.1kPa **Antenna/Distance** : 2016 HF907/3m/HORIZONTAL  
**Memo** : 8-DPSK 2402MHz

Data: 14

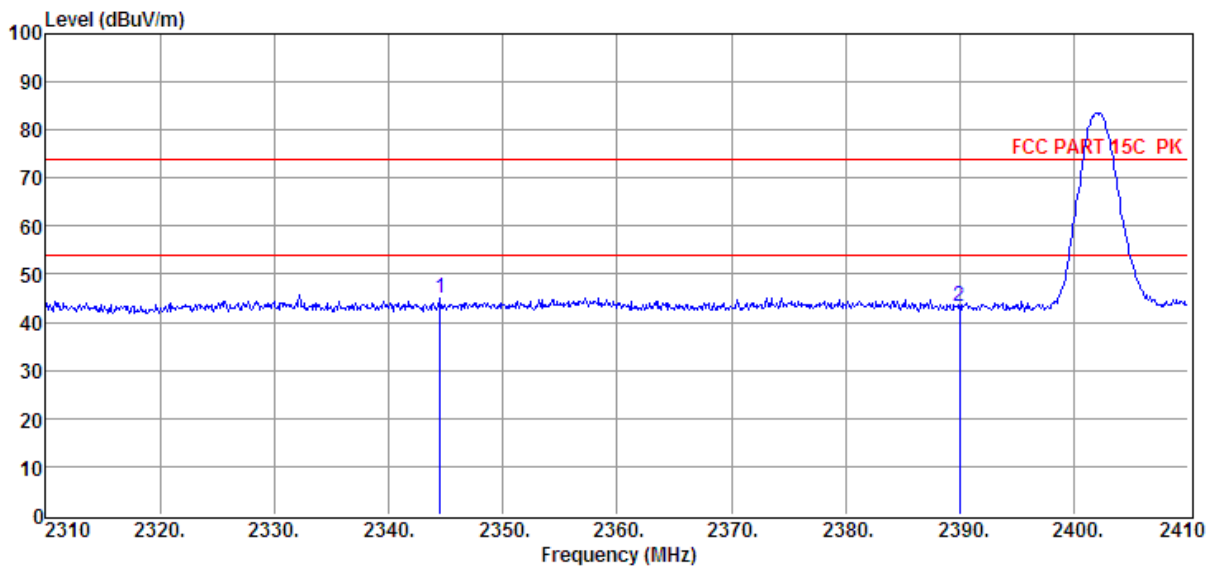

| Item<br>(Mark) | Freq.<br>(MHz) | Read<br>Level<br>(dBμV) | Antenna<br>Factor<br>(dB/m) | PRM<br>Factor<br>dB | Cable<br>Loss<br>dB | Result<br>Level<br>(dBμV/m) | Limit<br>Line<br>(dBμV/m) | Over<br>Limit<br>(dB) | Detector | Polarization |
|----------------|----------------|-------------------------|-----------------------------|---------------------|---------------------|-----------------------------|---------------------------|-----------------------|----------|--------------|
| 1              | 2344.50        | 38.92                   | 29.60                       | 29.33               | 5.96                | 45.15                       | 74.00                     | -28.85                | Peak     | HORIZONTAL   |
| 2              | 2390.00        | 36.74                   | 29.78                       | 29.42               | 6.03                | 43.13                       | 74.00                     | -30.87                | Peak     | HORIZONTAL   |

- Note: 1. Result Level = Read Level + Antenna Factor + Cable loss - PRM Factor.  
 2. If Peak Result complies with AV limit, AV Result is deemed to comply with AV limit.  
 3. Test setup: RBW: 1 MHz, VBW: 3 MHz, Sweep time: auto.  
 4. For emissions above 1GHz. If peak results comply with AV limit, AV Result is deemed to comply with AV limit.

## 11. Band Edge Compliance (conducted method)

### 11.1. Block diagram of test setup

Same as section 4.1

### 11.2. Limit

All restriction band should comply with 15.209, other emission should be at least 20dB below the fundamental.

### 11.3. Test result

| Mode                      | Freq (MHz)       | Conclusion               |
|---------------------------|------------------|--------------------------|
| GFSK                      | Hopping off 2402 | PASS                     |
|                           | Hopping off 2480 | PASS                     |
|                           | Hopping on       | PASS                     |
| 8-DPSK                    | Hopping off 2402 | PASS                     |
|                           | Hopping off 2480 | PASS                     |
|                           | Hopping on       | PASS                     |
| Test Date : Jul. 14, 2016 |                  | Test Engineer : Toby Ren |

### 11.4. Original test data

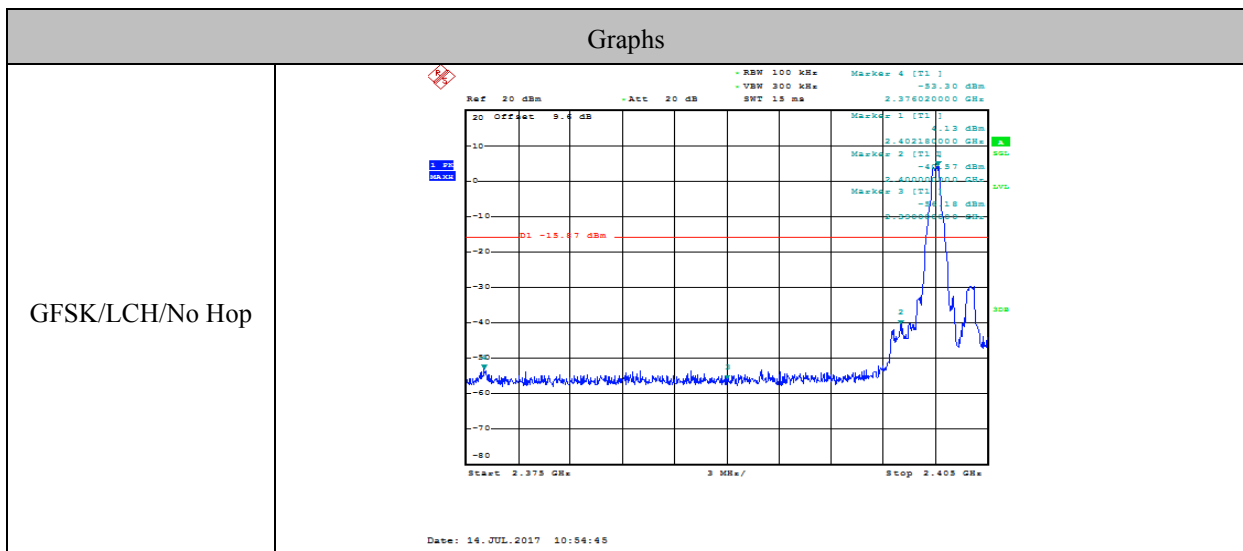

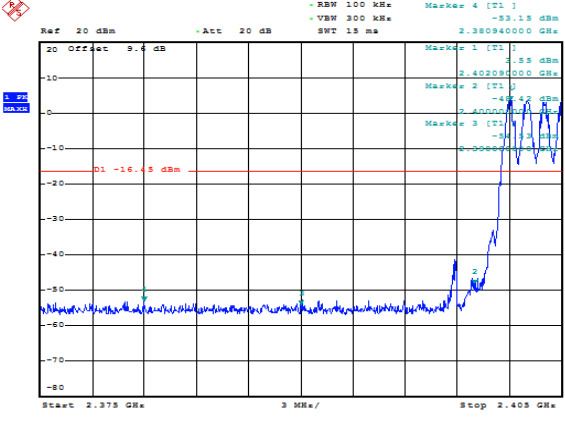
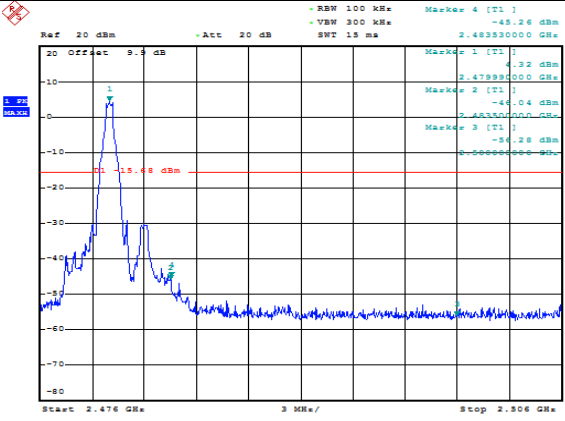
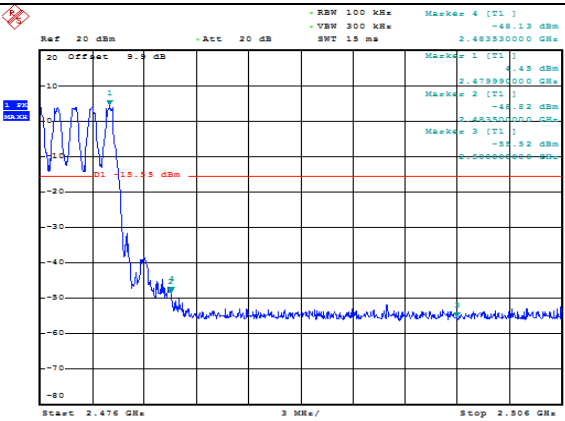
|                        |   |
|------------------------|---|
| <p>GFSK/LCH/Hop</p>    |  <p>Ref 20 dBm -Att 20 dB -RBW 100 KHz -VMW 300 KHz SWT 15 ms Marker 4 [T1] -53.15 dBm 2.380940000 GHz</p> <p>20 Offset 9.4 dB Marker 1 [T1] -3.55 dBm 2.402000000 GHz</p> <p>10 Marker 2 [T1] -48.42 dBm 2.400000000 GHz</p> <p>0 Marker 3 [T1] -53.15 dBm 2.380940000 GHz</p> <p>-10 -15.45 dBm</p> <p>-20</p> <p>-30</p> <p>-40</p> <p>-50</p> <p>-60</p> <p>-70</p> <p>-80</p> <p>Start 2.375 GHz 3 MHz/ Stop 2.405 GHz</p> <p>Date: 14. JUL. 2017 11:08:07</p>   |
| <p>GFSK/HCH/No Hop</p> |  <p>Ref 20 dBm -Att 20 dB -RBW 100 KHz -VMW 300 KHz SWT 15 ms Marker 4 [T1] -43.26 dBm 2.483330000 GHz</p> <p>20 Offset 9.4 dB Marker 1 [T1] -4.32 dBm 2.479990000 GHz</p> <p>10 Marker 2 [T1] -44.04 dBm 2.483330000 GHz</p> <p>0 Marker 3 [T1] -56.28 dBm 2.480000000 GHz</p> <p>-10 -15.45 dBm</p> <p>-20</p> <p>-30</p> <p>-40</p> <p>-50</p> <p>-60</p> <p>-70</p> <p>-80</p> <p>Start 2.476 GHz 3 MHz/ Stop 2.506 GHz</p> <p>Date: 14. JUL. 2017 10:57:03</p>  |
| <p>GFSK/HCH/Hop</p>    |  <p>Ref 20 dBm -Att 20 dB -RBW 100 KHz -VMW 300 KHz SWT 15 ms Marker 4 [T1] -48.13 dBm 2.483330000 GHz</p> <p>20 Offset 9.4 dB Marker 1 [T1] -4.45 dBm 2.479990000 GHz</p> <p>10 Marker 2 [T1] -44.82 dBm 2.483330000 GHz</p> <p>0 Marker 3 [T1] -56.52 dBm 2.480000000 GHz</p> <p>-10 -15.45 dBm</p> <p>-20</p> <p>-30</p> <p>-40</p> <p>-50</p> <p>-60</p> <p>-70</p> <p>-80</p> <p>Start 2.476 GHz 3 MHz/ Stop 2.506 GHz</p> <p>Date: 14. JUL. 2017 11:10:47</p> |

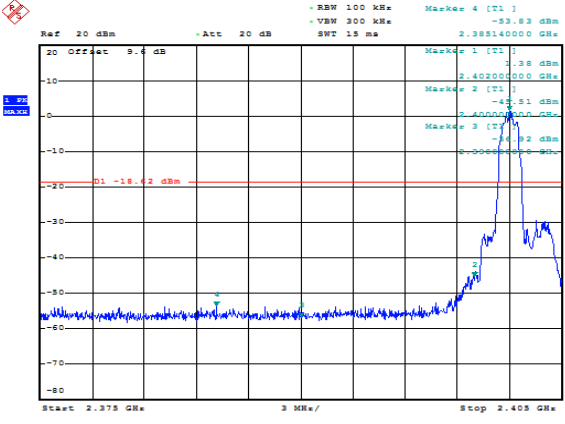
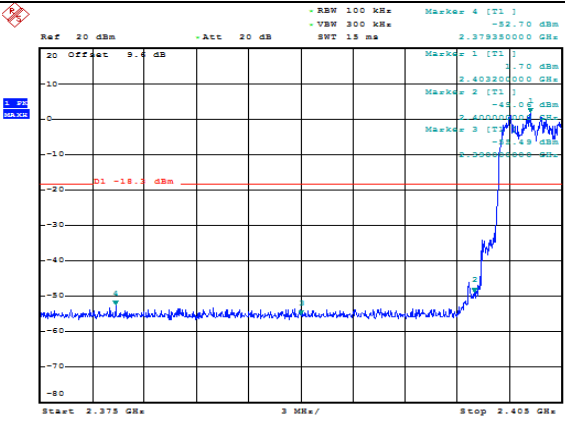
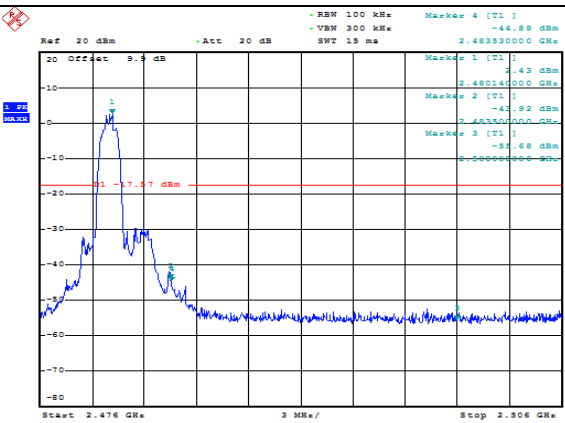
|                         |  |
|-------------------------|--|
| <p>8DPSK/LCH/No Hop</p> |  <p>Ref 20 dBm - Att 20 dB - RBW 100 KHz - VSW 300 KHz - SWT 15 ms - Marker 4 [T1] -33.83 dBm 2.385140000 GHz</p> <p>20 Offset 9.6 dB</p> <p>Marker 1 [T1] 2.402000000 GHz -3.38 dBm</p> <p>Marker 2 [T1] 2.402000000 GHz -4.51 dBm</p> <p>Marker 3 [T1] 2.402000000 GHz -4.92 dBm</p> <p>D1 -18.62 dBm</p> <p>Start 2.375 GHz 3 MHz/ Stop 2.405 GHz</p> <p>Date: 14. JUL. 2017 10:59:02</p>     |
| <p>8DPSK/LCH/Hop</p>    |  <p>Ref 20 dBm - Att 20 dB - RBW 100 KHz - VSW 300 KHz - SWT 15 ms - Marker 4 [T1] -32.70 dBm 2.379330000 GHz</p> <p>20 Offset 9.6 dB</p> <p>Marker 1 [T1] 2.402000000 GHz -1.70 dBm</p> <p>Marker 2 [T1] 2.402000000 GHz -4.51 dBm</p> <p>Marker 3 [T1] 2.402000000 GHz -4.92 dBm</p> <p>D1 -18.11 dBm</p> <p>Start 2.375 GHz 3 MHz/ Stop 2.405 GHz</p> <p>Date: 14. JUL. 2017 11:18:42</p>    |
| <p>8DPSK/HCH/No Hop</p> |  <p>Ref 20 dBm - Att 20 dB - RBW 100 KHz - VSW 300 KHz - SWT 15 ms - Marker 4 [T1] -64.88 dBm 2.483330000 GHz</p> <p>20 Offset 9.6 dB</p> <p>Marker 1 [T1] 2.480140000 GHz -2.43 dBm</p> <p>Marker 2 [T1] 2.480140000 GHz -41.92 dBm</p> <p>Marker 3 [T1] 2.480140000 GHz -39.68 dBm</p> <p>D1 -17.67 dBm</p> <p>Start 2.476 GHz 3 MHz/ Stop 2.506 GHz</p> <p>Date: 14. JUL. 2017 11:01:24</p> |

8DPSK/HCH/Hop

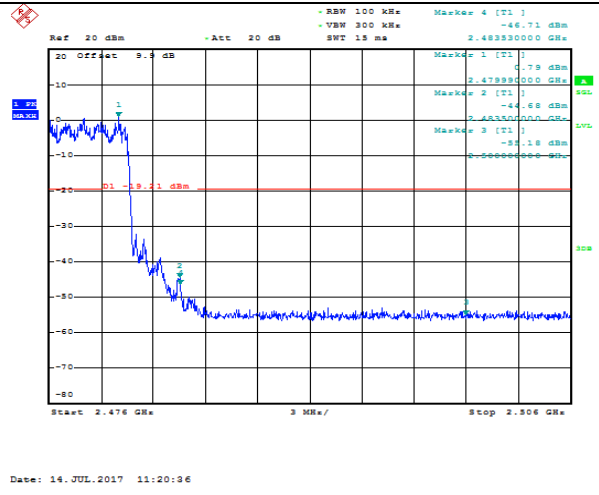

## 12. Power Line Conducted Emission

### 12.1. Block diagram of test setup

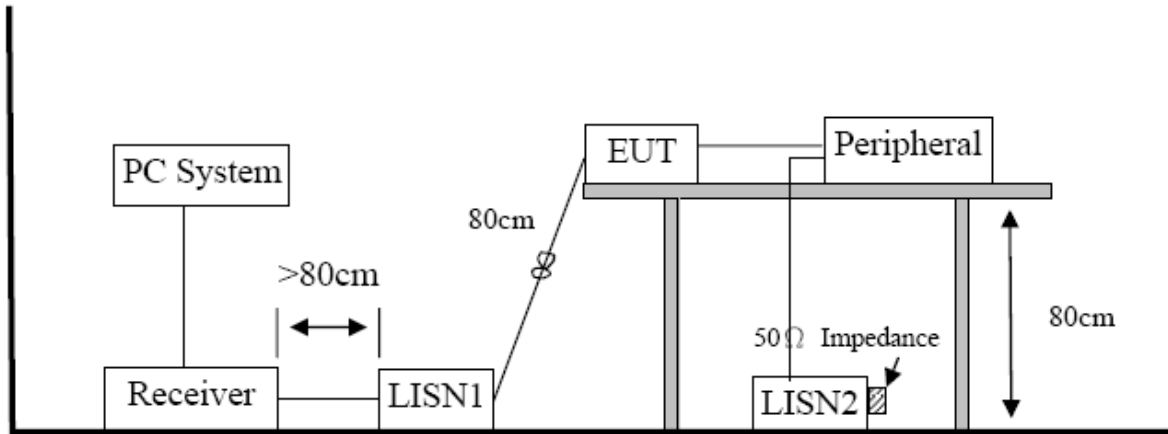

### 12.2. Power Line Conducted Emission Limits(Class B)

| Frequency       | Quasi-Peak Level<br>dB( $\mu$ V) | Average Level<br>dB( $\mu$ V) |
|-----------------|----------------------------------|-------------------------------|
| 150kHz ~ 500kHz | 66 ~ 56*                         | 56 ~ 46*                      |
| 500kHz ~ 5MHz   | 56                               | 46                            |
| 5MHz ~ 30MHz    | 60                               | 50                            |

Note 1: \* Decreasing linearly with logarithm of frequency.

Note 2: The lower limit shall apply at the transition frequencies.

### 12.3. Test Procedure

The EUT and Support equipment, if needed, were put placed on a non-metallic table, 80cm above the ground plane.

Configuration EUT to simulate typical usage as described in clause 2.4 and test equipment as described in clause 10.2 of this report.

All I/O cables were positioned to simulate typical actual usage as per ANSI C63.4.

All support equipment power received from a second LISN.

Emissions were measured on each current carrying line of the EUT using an EMI Test Receiver connected to the LISN powering the EUT.

The Receiver scanned from 150 kHz to 30MHz for emissions in each of the test modes.

During the above scans, the emissions were maximized by cable manipulation.

The test mode(s) described in clause 2.4 were scanned during the preliminary test.

After the preliminary scan, we found the test mode producing the highest emission level.



The EUT configuration and worse cable configuration of the above highest emission levels were recorded for reference of the final test.

EUT and support equipment were set up on the test bench as per the configuration with highest emission level in the preliminary test.

A scan was taken on both power lines, Neutral and Line, recording at least the six highest emissions.

Emission frequency and amplitude were recorded into a computer in which correction factors were used to calculate the emission level and compare reading to the applicable limit.

The test data of the worst-case condition(s) was recorded.

The bandwidth of test receiver is set at 9 KHz.

#### **12.4. Test Result**

Not Applicable

## **13. Antenna Requirements**

### **13.1. Limit**

For intentional device, according to FCC 47 CFR Section 15.203, an intentional radiator shall be designed to ensure that no antenna other than that furnished by the responsible party shall be used with the device. And according to FCC 47 CFR Section 15.247 (b), if transmitting antennas of directional gain greater than 6dBi are used, the power shall be reduced by the amount in dB that the directional gain of the antenna exceeds 6dBi.

### **13.2. Result**

The antennas used for this product are integrated antenna and that no antenna other than that furnished by the responsible party shall be used with the device, the maximum peak gain of the transmit antenna is only 0 dBi.

14. Test setup photograph

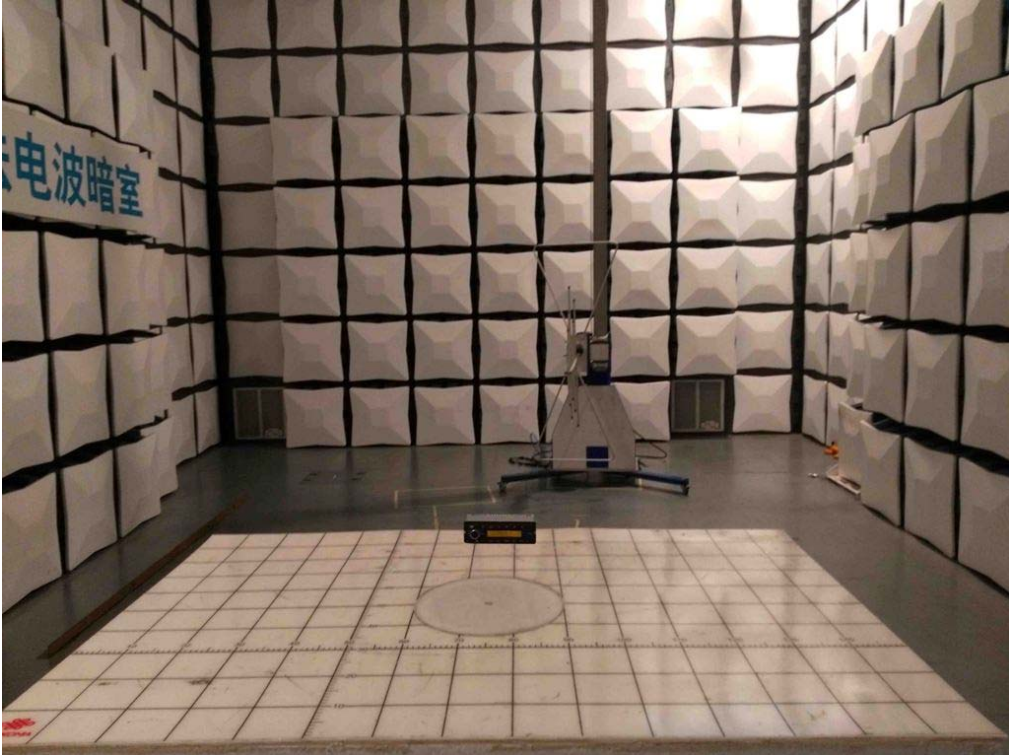

15. Photos of the EUT

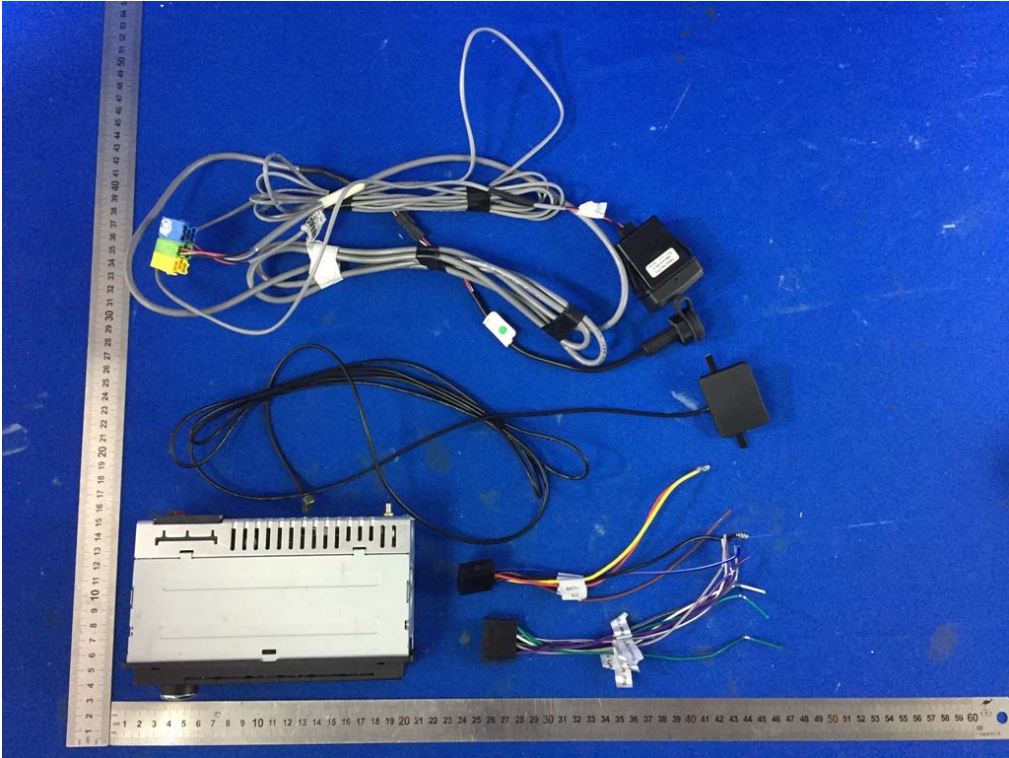



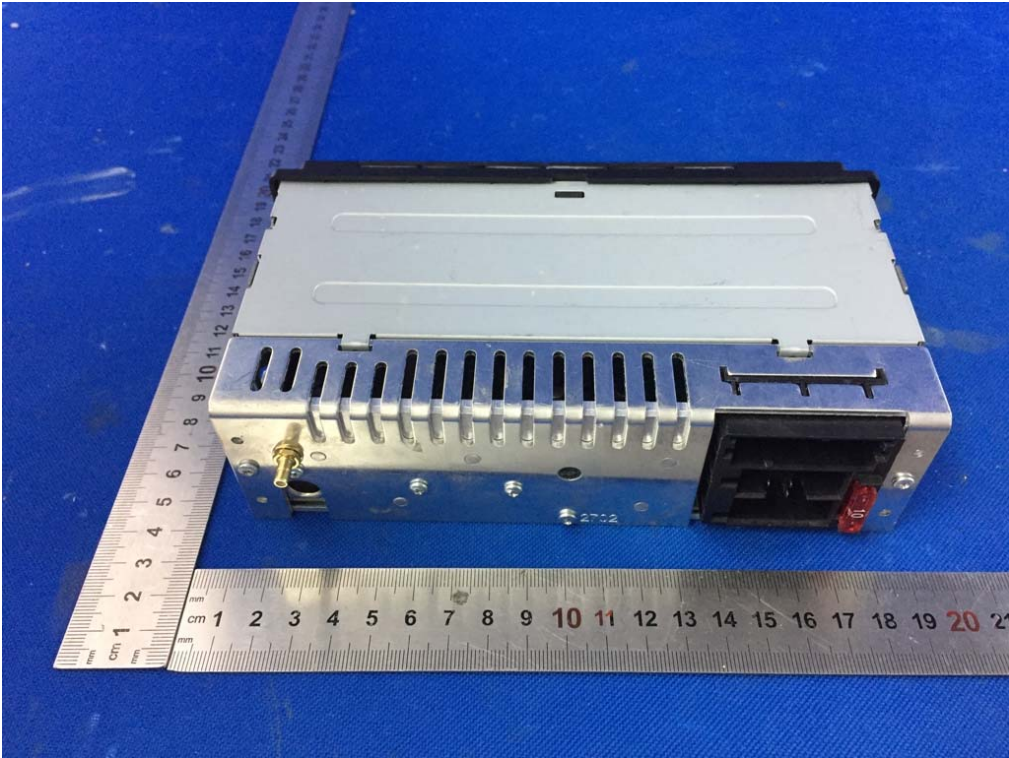









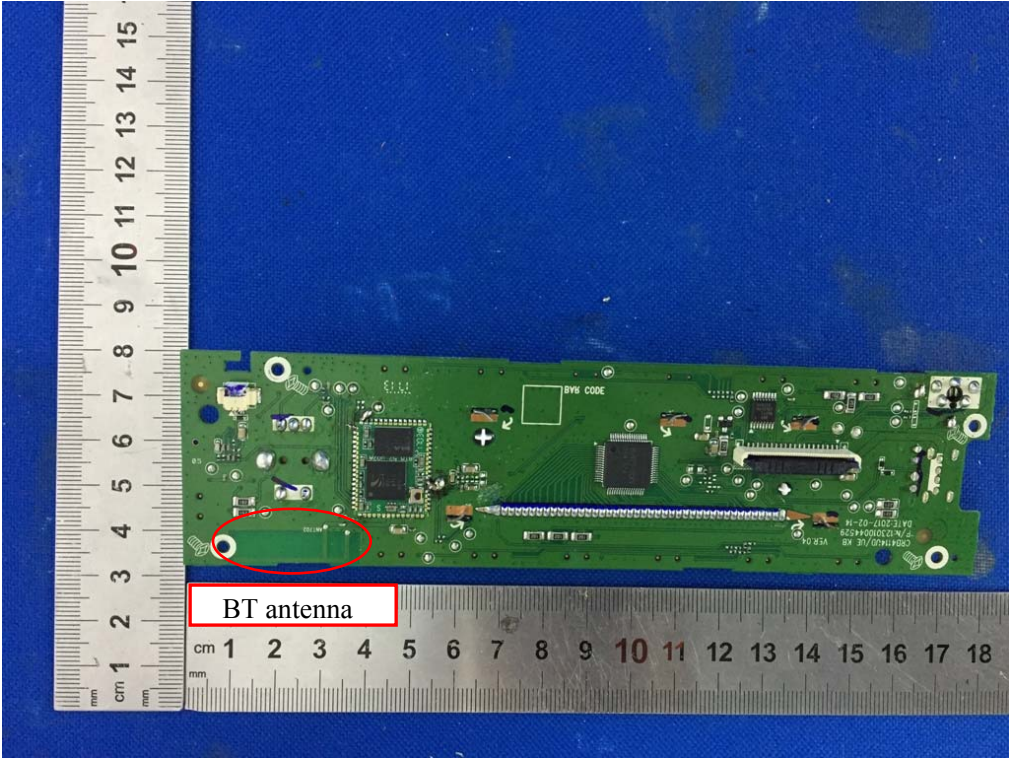
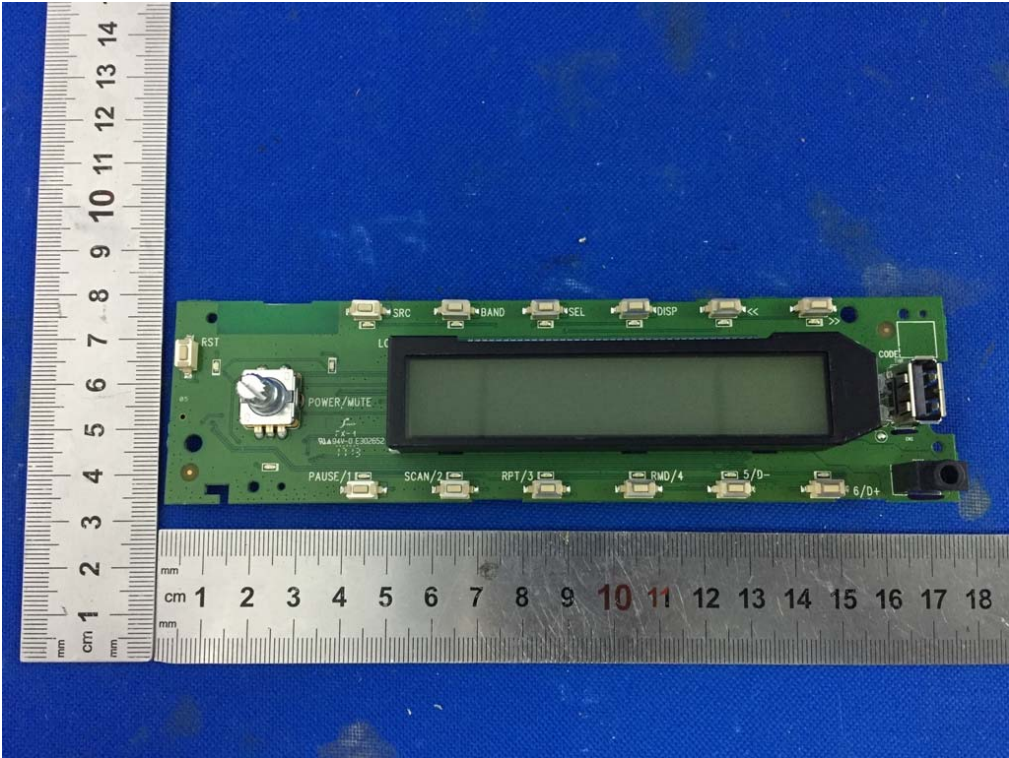





**END OF REPORT**