



RADIO / USB MP3 / WMA / DAB+ / DMB / Bluetooth® 12V

### OWNER'S MANUAL



RADIO DATA  
SYSTEM



WORLDWIDE  
TUNER



DIGITAL AUDIO  
BROADCASTING



MP3 / WMA



Bluetooth®



LOUDNESS  
CONTROL



LOGIC ON  
LOGIC OFF



BACKUP  
MEMORY



USB CONNECT



AUX IN

## Safety Information

Thank you for purchasing this product, please read the manual carefully before operating, and reserve it for future reference.

### Precaution

- Use only in a 12-volt DC negative- ground electrical system.
- Disconnect the vehicle's negative battery terminal while mounting and connecting the unit.
- When replacing the fuse, be sure to use one with an identical amperage rating.
- Using a fuse with a higher amperage rating may cause serious damage to the unit.
- Make sure that pins or obstacles do not get inside the unit, they may cause malfunctions, or create safety hazards such as electrical shock.
- If you have parked the vehicle for a long time in hot or cold weather, wait until the temperature in the vehicle becomes normal before operating the unit.

### Before operation

- Do not raise the volume level too high. Keep the volume at a level at which you can hear outside warning sounds (horns sirens, etc.).
- Stop the vehicle before performing any complicated operations.

### Caution

- Do not open the cover and do not repair by yourself. Ask your authorised dealer for help.

#### **Note:**

1. According to models with different wiring harness to connect the definition of the specific content, please refer to the model label.
2. Specifications and the design are subject to change without notice due to improvements in technology.

## Contents

Safety Information .....	2
Panel Controls .....	3
General Operation.....	4
Volume and Sound .....	5
AM/FM Radio .....	6
DAB Radio (applicable to DAB feature).....	7
USB/MP3/WMA.....	8
Bluetooth.....	9
Dimming.....	11
System Settings Items List .....	12
Electrical connections.....	14
Troubleshooting.....	15
Specifications.....	16
Declaration of Conformity.....	17
FCC .....	18
Accessories.....	19

# Pane

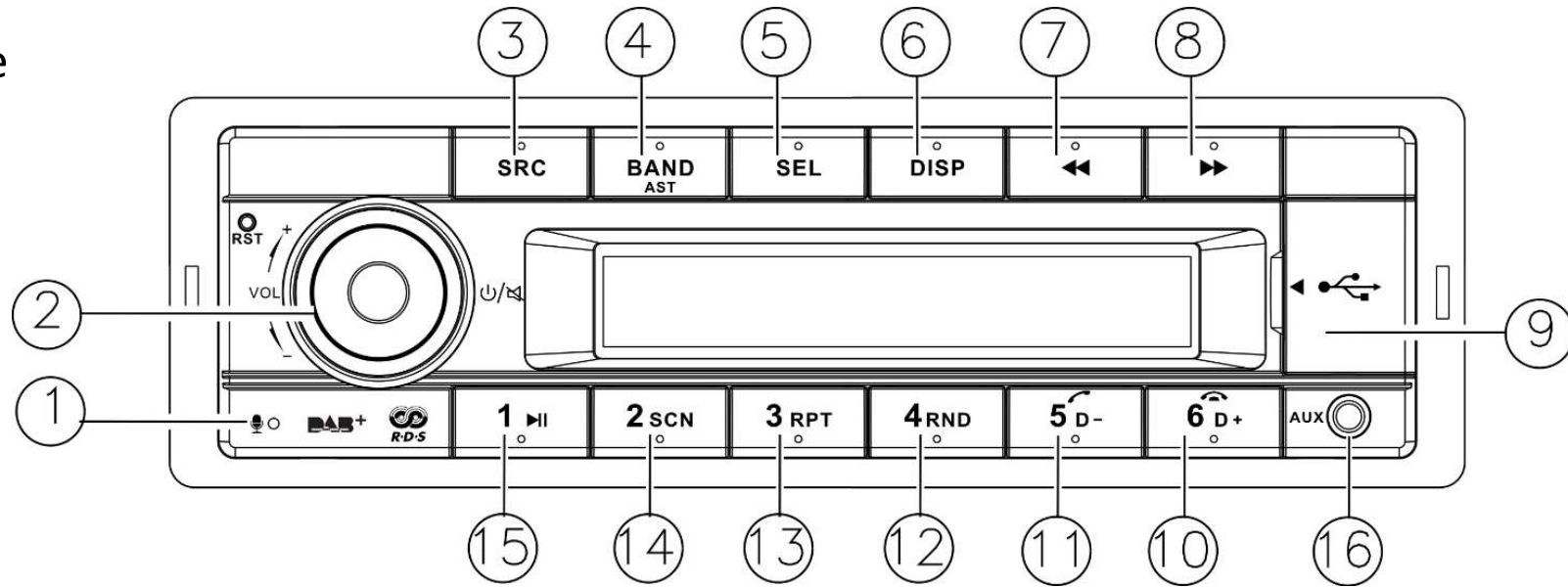

- |   |  |   |
|---|--|---|
| <p>(1) Microphone</p> <p>(2) Power button<br/>- On/Off (long press)<br/>- Mute (short press)<br/>- Rotate the VOL knob to adjust volume</p> <p>(3) Source Button<br/>- Select Source (short press)<br/>- Select PTY Mode (long press)</p> <p>(4) Band /AST Button<br/>- Band select (short press)<br/>- Auto store/DAB Service Scan (long press)<br/>(applicable to DAB feature).</p> <p>(5) Select Button<br/>- Manual and Automatic Equalizing<br/>- Select Menu entry in user Menu</p> | <p>(6) Display button<br/>- Display System clock,<br/>- Display PTY Information in Radio mode<br/>- Display MP3 Information (USB Mode)</p> <p>(7) &lt;&lt; Button<br/>Previous Station/Previous Track</p> <p>(8) &gt;&gt; Button<br/>Next Station/Next Track</p> <p>(9) USB slot</p> <p>(10 – 15) AM/FM, DAB Favorites<br/>(applicable to DAB feature)</p> | <p>(10) MP3 folder ahead<br/>Phone: Hang up</p> <p>(11) MP3 folder back<br/>Phone: Contact mode/Dial/Call transfer</p> <p>(12) MP3 Random play</p> <p>(13) MP3 repeat play</p> <p>(14) Program intro Play (Scan)</p> <p>(15) MP3/Bluetooth Play/Pause</p> <p>(16) Front auxiliary input</p> |
|---|--|---|

## General Operation

### Power ON/OFF , Mute

To Switch on the Radio push the Power ON/OFF button.

To switch off the Radio push the Power ON/OFF button for more than 2 sec.

The Radio will be muted by pushing the Power ON/OFF button for less than 2 sec.

### Ignition Logic

With ignition logic activated (Default setting) the Radio can be switched on and off manually even if the vehicles ignition pin is not connected. To avoid battery discharge the radio is switched off after 1h without user operation.

### System Settings

The system settings menu is entered by long pressing the [DISP] button. To access the available menu entries push the search buttons [ << / >> ]. To select the available options of each menu entry rotate the [VOL] knob.

For details see chapter system settings of this manual.

### Select Source

Press the [SRC] button to switch between and select available sources: TUNER->USB->AUX F->AUX R-> Bluetooth->DAB (applicable to DAB feature). USB and Bluetooth is only visible in the menu when connected.

### Reception Area

This Radio is designed to work in different regions with different frequency ranges.

The Reception area can be adjusted via the System Settings menu. The default setting is "EUROPE".

The following Areas are available:  
EUROPE/ASIA/JAPAN/NORTH AFRICA/USA

### Clock Setting

The clock time can be adjusted manually by long pressing the [DISP] button to set the time. Select [CLOCK] with the search buttons [ << / >> ]. Press [SEL] button and rotate [VOL] knob to adjust the minutes. Press search buttons [ << / >> ] to select adjust hours. Rotate [VOL] knob to adjust the hours. Press the [SEL] button to exit the clock setting.

## Volume and Sound

### Volume

To adjust the Volume rotate the [VOL] knob

### Predefined sound effects

The Radio provides different predefined sound effects .

Press the [SEL] button to enter the Sound settings menu. Rotate the [VOL] knob to select one of the following options: EQ OFF -> POP -> ROCK -> CLASSIC -> JAZZ -> CUSTOM.

### BALANCE, FADE and Loudness

To adjust Balance, Fader and Loudness press the [SEL] button and then push [ << / >> ] button to select BALANCE -> FADER -> LOUDNESS. Rotate the [VOL] knob to adjust Balance, Fade and Loudness according to your needs.

### Manual Sound Adjustment

For manual sound adjustment first select CUSTOM. Push the [SEL] button again and then select BASS or TREBLE with the [ << / >> ] button. Rotate the [VOL] knob to adjust BASS and TREBLE according to your needs.

## AM/FM Radio

### AM/FM Radio Selection

To access AM/FM Radio press the [SRC] button and select Tuner

### Select Band

Press the [ BAND ] Button to select one of the available Radio Bands. The Radio bands will be changed in the following order:

FM1 -> FM2 -> FM3 -> AM1 -> AM2 -> LW

The AM and LW Bands can be deactivated by the user via the system settings menu.

### Automatic Tuning

For Automatic tuning press the [ << / >> ] button. The Radio will search and select the next receivable station.

When Traffic Announcement is activated ("TA = ON") only stations that broadcast Traffic announcements will be tuned.

### Manual Tuning

For manual station selection press the [ << / >> ] button for longer than 2 sec. "MANUAL" is shown in the display. Pressing the [ << / >> ] button again the frequency will be incrementally increased/decreased.

### Manual Storing Favourites

There are 3 FM , 2 MW and 1 LW Favourite banks available.

Select the favourite bank where to store the station and tune the station that shall be stored.

Push the preset button longer than 2 sec .to store the station

### Recall Stored Favourites

To recall a stored favourite push the according preset button

### Auto Memory Store

To search for the best receivable stations and store them as favourite press the (BAND/AST) button for 2 sec. The Radio searches the best receivable station and stores them.

### RDS

Many FM Stations in Europe transmit RDS data (Radio Data System) in addition to their audio program. With RDS the user has the following benefits:

- The best audible frequency (AF) of a selected station is tuned automatically for best reception quality.  
To enable automatic selection of best audible frequency select "AF=ON" in the Settings menu
- The Radio recognizes Traffic Announcements and can switch to Radio even if an other Audio source is selected.  
To enable automatic Traffic announcement select "TA=ON" in the Settings menu
- Some Stations provide regional specific programs.  
With the regional (REG) function only those frequencies are followed that broadcast the selected regional program. To follow regional programs select "REG=ON" in the Settings menu
- The stations name can be displayed

For further settings see System Menu

**PTY**

Via the RDS System FM stations in many countries transmit the type of program (Program Type , PTY) that is broadcasted.

To search for a desired Program type push [SRC] for about 2 sec. and select the Program type by rotating the[VOL] knob.

The Radio will search for a Radio-Program with the selected Program type when the [SEL] button is pushed. "PTY SEEK" is shown in the Display.

If no station with the selected Program Type can be found the last tuned station will be selected and "NO PTY" is shown in the Display.

The following program types are available:

NEWS, AFFAIRS, INFO, SPORT, EDUCATE,  
 DRAMA, CULTURE, SCIENCE, VARIED, POP-M,  
 ROCK-M, EASY-M, LIGHT-M, CLASSICS-M,  
 OTHER-M, WEATHER, FINANCE, CHILDREN,  
 SOCIAL, RELIGION, PHONE IN, TRAVEL, LEISURE,  
 JAZZ, COUNTRY, NATIONAL-M, OLDIES, FOLK- M,  
 DOCUMENT, TEST, ALARM

**DAB Radio**

(applicable to DAB feature)

**DAB Radio Selection**

DAB/DAB+ Provides radio programs in digital sound quality.

To access Digital Audio Broadcast (DAB) press the [SRC] button and select DAB.

**DAB Service SCAN**

To search for receivable DAB Services the DAB service SCAN has to be started by pushing [BAND/AST] for 2 sec. "SCAN" is shown in the display.

**Select DAB Band**

Press the [ BAND ] Button to select one of the available DAB Bands. The DAB bands will be changed in the following order:  
 DAB1 -> DAB2 -> DAB3

**Tuning a DAB Service**

To tune a DAB service push [ << / >> ] to select the next/previous DAB service. "Tuning" is shown on the Display.

**DAB Service List**

To get an overview of receivable DAB services a DAB Service List can be displayed.

Push [SEL] for 2 sec. to open the DAB Service List. Rotate the [VOL] Button to scroll through the list of receivable stations.

To tune a DAB service push [SEL]. "Tuning" is shown on the display.

In the case that a Service is temporary not receivable "No Service" will be shown on the display.

**Storing DAB Favourites**

There are 3 DAB favourite banks available. Select the favourite bank where to store the station and tune the station that shall be stored.  
 Push the preset button longer than 2 sec. to store the station

**Recall Stored Favourites**

To recall a stored favourite push the according preset button

**Switching between DAB and FM**

When the DAB signal quality drops significant it is reasonable to switch and listen to the service via FM.  
 Switching between DAB and FM (DABFMLNK) can be disabled via the system settings menu

## USB/MP3/WMA

### Note on MP3

- MP3 is short for MPEG Audio Layer 3 and refers to an audio compression technology standard.
- This product allows playback of MP3 files.
- The unit can not read an MP3 file that has a file extension other than ".mp3".
- If you play a non-MP3 file that has the ".mp3" extension, you may hear some noise.
- In this manual, we refer to what are called "MP3 file" and "folder " in PC terminology as "track" and "Album," respectively.
- Maximum number of directory and files is 65535, including the root directory. Maximum number of files per folder is 1000.
- The unit may not play tracks in the order of Track numbers.
- Supports bit rate from 8 to 320 kbps and VBR (Variable Bit Rate).

### Note on WMA

Supports bit rate from 5 to 384 kbps and VBR (Variable Bit Rate).

### USB Notes

USB functions (flash memory type) MP3 music play.

- USB flash memory 2 in 1 support
- FAT 12/FAT 16/FAT 32 format supported.
- File name: 64 byte/dir name: 64 byte/tag name: 30 byte.
- Tag (id3 tag ver 2.0)  
- title/artist/album: 32 byte support.
- USB 1.1 support, USB 2.0 support  
(For 2.0, speed performance is as USB 1.1)
- Not all USB devices are compatible with the unit.
- USB connector is support maximum work power with 500 mA.

### Loading/ Removal of USB Device

Insert a USB device into the USB-slot "Reading" is shown on the Display. MP3 Playback will start immediate afterwards.

Before removing the USB Device switch to an other Source by pushing the [SRC] button.

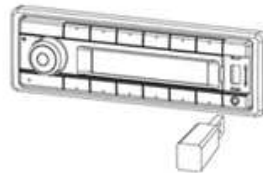

### MP3 Playback/Pause

To pause and resume MP3 Playback push button [1>].

### Next/Previous MP3 Track.

To select the next/previous track push the [←/→] button.

### Fast forward/fast rewind.

To fast forward/fast rewind the current track push the [←/→] button longer than 2 sec.

### Random Play

To activate random play push the button [4 RND].

### Repeat

Push the [3 RPT] button to activate repeat Track/repeat directory/repeat all.

### SCAN

To activate/stop the scan function push the button [2 SCN]. In scan mode all titles are played for 10 sec.

## Bluetooth

The Bluetooth allows you to utilize your vehicle's built-in audio system for wireless mobile phone or music hands free communication. Some Bluetooth mobile phones have the audio features, and some portable audio players support Bluetooth feature. This system can play audio data stored in a Bluetooth audio device. The vehicle stereo with Bluetooth will be able to retrieve phonebook contacts, received call, dialed call, missed call, incoming calls, outgoing call and listen to music.

### **Notes:**

- Do not leave the microphone on Bluetooth hands free in the places with wind passing such as air outlet of the air conditioner, etc. This may cause a malfunction.
- If left in places subjected to direct sun, high temperature can cause distortion, discoloration which may result in a malfunction.
- This system will not operate or may operate improperly with some Bluetooth audio players.
- Cannot guarantee the compatibility of all mobile phones together with unit.
- Audio playback will be set to the same volume level as set during telephone call. This might cause problems, if extreme volume level is set during telephone call.

## Hands free Operations

### **Pairing**

1. Turn on Bluetooth function of your mobile phone.
2. Enter mobile phone's Bluetooth setup menu.
3. Search for new Bluetooth devices.
4. Select Bluetooth devices from the pairing list on the mobile phone.
5. Enter "1234" as the password (The password default setting is "1234").
6. After pairing successfully, BT and HPF icons will light up.  
A2DP icon will light up after A2DP connected

### **Dial Number**

1. Phone dialing  
Mobile phone dialing, LCD screen displays dialing information.
2. Unit dialing  
Press [SRC] button switch to BT /Audio mode  
press [5 D+] to choose the DIAL ON function, press [SEL] button / [←/→] button and rotate the knob to input dialing numbers,

### **Transfer Call**

You can switch between hands free call and mobile phone call. Press the [5 /] button during call.

### **Answering a call**

You can answer an incoming call by pressing the [5/] button.  
Press the [6 /] button to reject an incoming call.



# Audio Streaming

## ***What is audio streaming?***

Audio streaming is a technique for transferring audio data such that it can be processed as a steady and continuous stream. Users can stream music from their external audio player to their vehicle stereo wirelessly and listen to the tracks through the vehicle's speakers. Please consult your nearest dealer for more information on the product of wireless audio streaming transmitter offered.

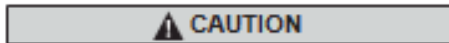

**Please avoid operating your connected mobile phone while audio streaming as this may cause noise or sound choppy on the song playback.**

**Audio streaming may or may not resume after telephone interrupt as this is dependent on mobile phone.**

**The system will always return to Radio mode if audio streaming is disconnected.**

## ***Note:***

Be sure to read the chapter "Pairing" before proceeding.

## **BT /Audio mode (A2DP)**

### **Playback/Pause**

To pause and resume Playback push button [1>].

### **Next/Previous Track.**

To select the next/previous track push the [ <</>> ] button.

## ***Note:***

Playing order will depend on Bluetooth audio player. When the [ <</>> ] button is pressed, some A2DP devices will restart the current track depends on the duration of playback.

During music streaming playback, "A2DP and HFP" will be shown on the display. When A2DP device is disconnected, "DISCONN" will be shown on the display. Some Bluetooth audio players may not have play / pause synchronized with this unit.

Please make sure both device and main unit are in the same play/ pause status in **BT /Audio** mode.

# Dimming

## Display and Button Dimming

This radio allows manual or automatic dimming. Select "DIMMING" in the settings menu and select one of the following options:

- Select "OFF" to disable Dimming
- Select Manual dimming when the radio is not connected to the vehicles ignition pin.
- Select Automatic dimming when the Radio is connected correct to the vehicles ignition-pin.

**To adjust your favourite brightness-setting for display- and button brightness select manual mode.**

## Brightness adjustment

Select Manual dimming to adjust Brightness of Display and Buttons

### DAY/Night Selection

Select DIM MAN and change between day mode and night mode by selecting "DIMDAY" or "DIMNIGHT"

### Night Brightness adjustment of display and Buttons

To adjust Night Brightness of the display and buttons select "DIMNIGHT". Then select "LCD Menu" and adjust the brightness of the Display accordingly. Then select "Key Menu" and adjust the brightness of the Buttons accordingly.

### Day Brightness adjustment of display and Buttons

To adjust Day Brightness of the display and buttons select "DIMDAY". Then select "LCD Menu" and adjust the brightness of the Display accordingly. Then select "Key Menu" and adjust the brightness of the Buttons accordingly

## Manual Mode

Change between Day and Night Mode by selecting "DIMDAY" or "DIMNIGHT"

## Automatic Mode

In automatic mode the display will change automatically between day and night mode when the radio is correct connected to the vehicles illumination pin.

# System Setting Item List

## Radio region: Europe

### Tuner source

### DAB source

### AUX/ USB / BT (A2DP) source

(applicable to DAB feature)

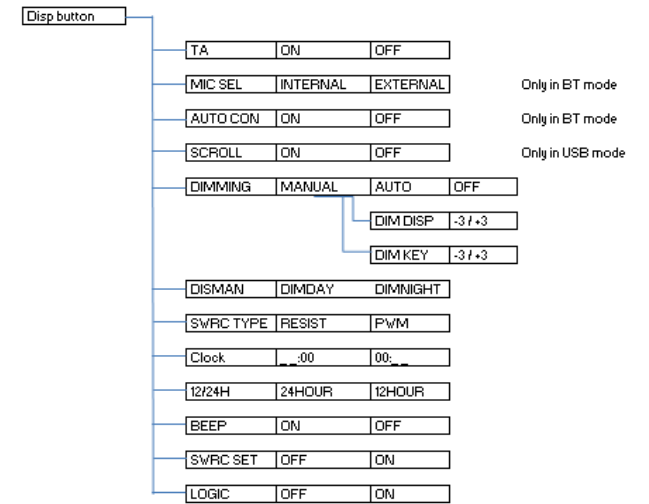
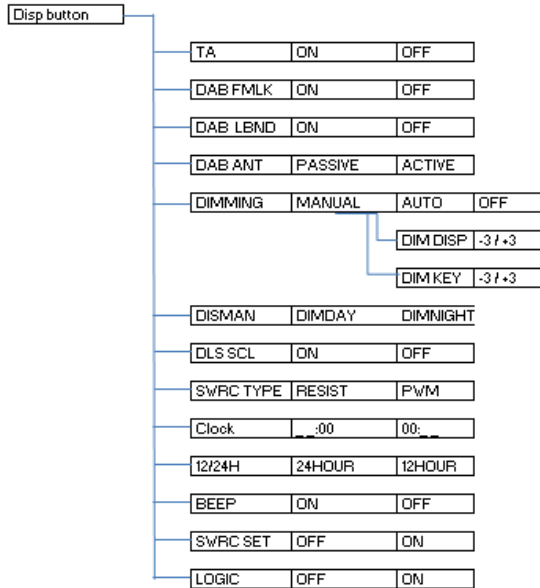
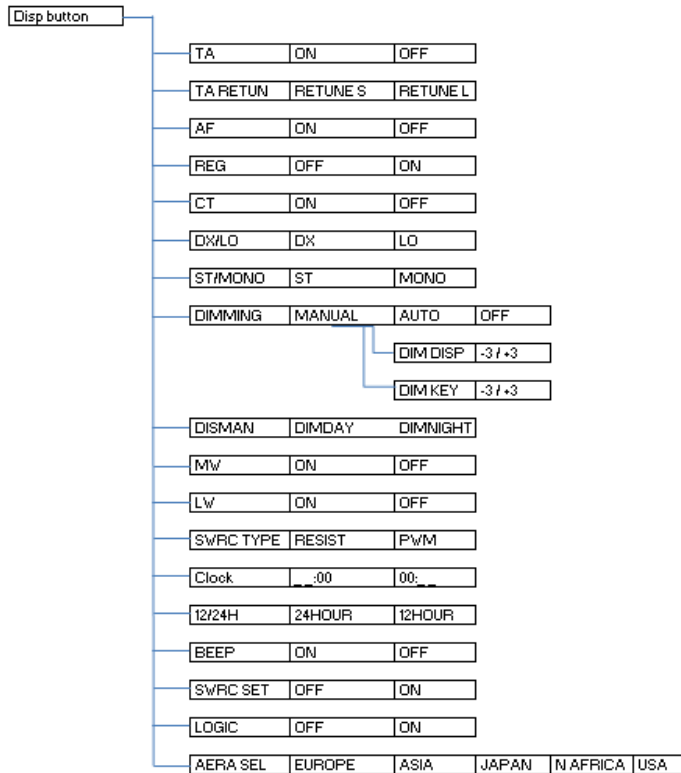

# System Setting Item List

## Radio region: Asia/ Japan/ N Africa/ USA

Tuner source	DAB source	AUX/ USB / BT (A2DP) source
--------------	------------	-----------------------------

(applicable to DAB feature)

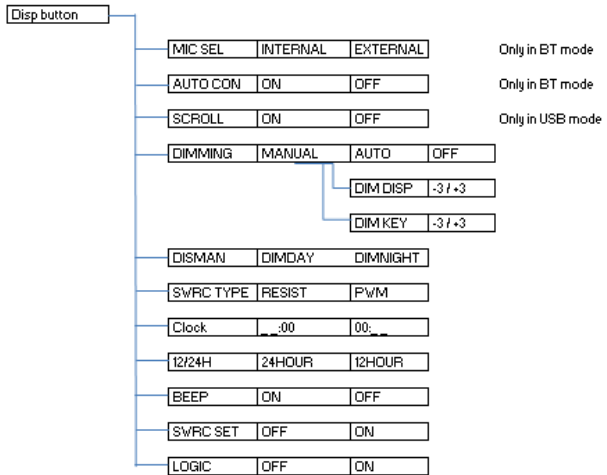
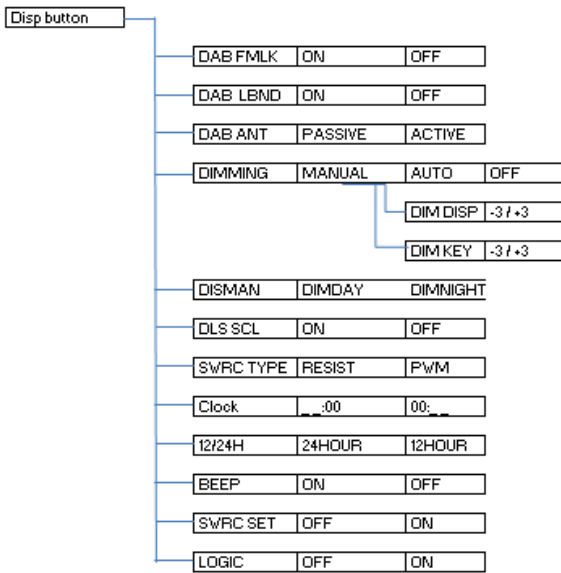
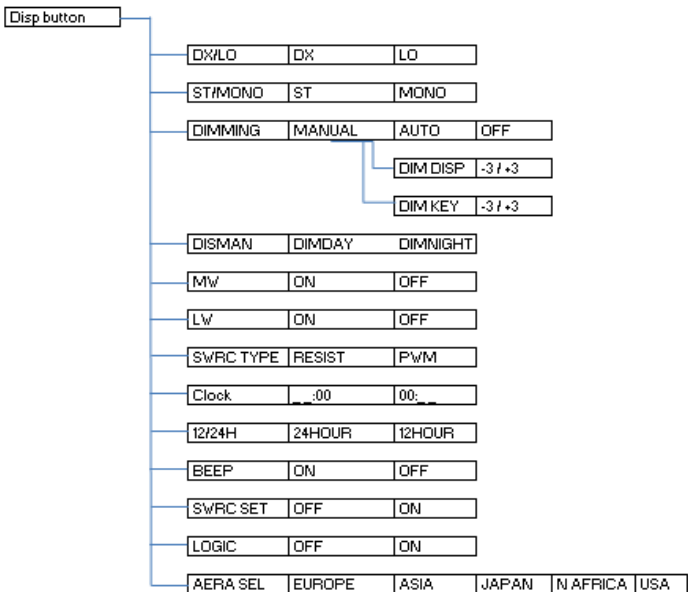

# System Setting

## AM/FM Tuner Options

### TA

Enable /Disable automatic switching to FM-tuner mode in case of incoming Traffic announcements.

### TA Return

Switch back time in the case that Announcement-Signal can not be detected any more.

### AF

Enable/Disable automatic selection of best audible frequency in FM-Tuner Mode (RDS).

### REG

Enable/Disable automatic selection of better audible frequencies that broadcast different regional content.

### CT

Automatic synchronization of Clock with time received via RDS-Signal.

### DX/LO

Search Level of AM/FM-Tuner.

### ST/Mono

Selection of Stereo or Mono output of FM/AM tuner

### AERA SEL

To adjust the AM/FM tuner to your region.

## DAB Tuner Options

(applicable to DAB feature)

### DAB FMLINK

Enable /Disable automatic switching to FM-tuner when DAB-Signal drops.

### DAB LBND

Enable/Disable L-Band Decoding

### DAB ANT

Selection of Active or Passive antenna is connected.

### DLS SCROLL

Enable display of Artist and Song

## Bluetooth Options

### SCROLL

ON: Display ID3 tag information cyclic: Track-Folder-File-Album-Title-Artist-Track

OFF: Display Track

### MIC SEL

Use of integrated Microphone in front panel or external Microphone connected by rear connector

### AUTO CON

To disable/enable Bluetooth connection

## Steering Wheel Control Options

### SWRC TYPE

Selection of Steering Wheel control type (Resistance/PWM)

### SWRC SET

To enable/disable steering wheel control

## Dimming Options

### DIMMING

To Select Dimming Mode (OFF, Manual, automatic)

### LCD Menu

To Adjust Display brightness

### KEY Menu

To adjust Button brightness

### DIM MAN

To switch between DAY and Night Mode

## Others

### MW

To enable/disable MW Reception

### LW

To enable/disable LW Reception

### BEEP

To enable/disable confirmation signal

### Logic

To enable/disable ignition logic

### Clock

To adjust hours and minutes

### 12/24H

To select 12 / 24 h Clock format

# Electrical Connections

## Wiring Diagram

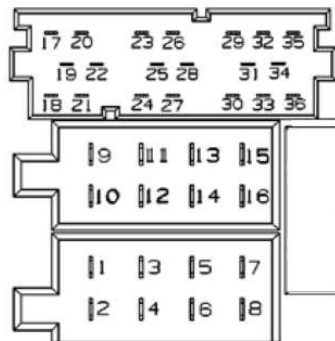
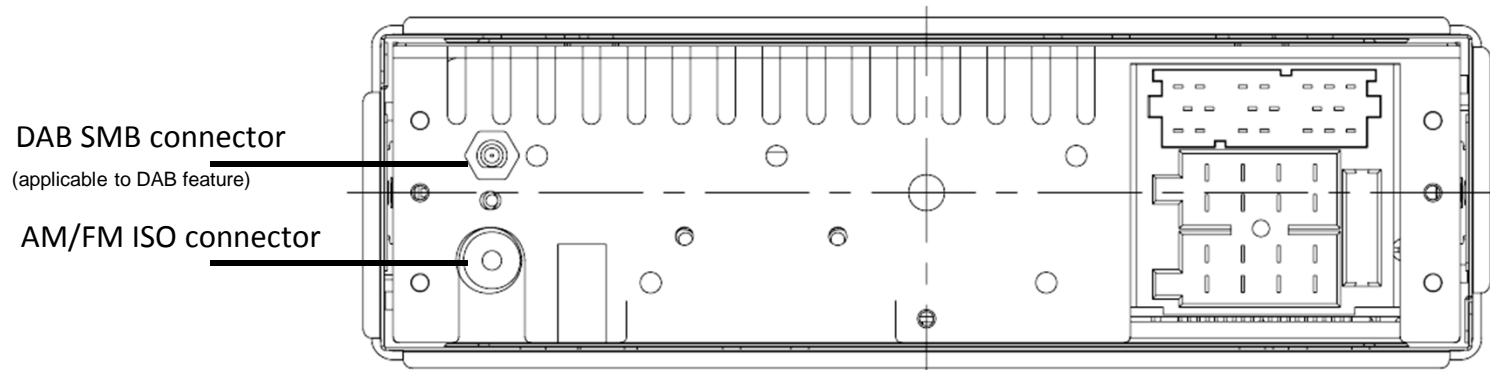

Pin No	Note	Pin No	Note
3	Telephone mute low	9	Rear R+
4	Ignition	10	Rear R-
5	Antenna Remote	11	Front R+
6	Illumination	12	Front R-
7	Battery+	13	Front L+
8	Power Ground	14	Front L-
21	SWRC+	15	Rear L+
22	SWRC GND	16	Rear L-
23	Left AUX Input	25	AUX GND
24	AUX Shield GND	26	Right AUX Input
31	Mic+	32	Mic-

## Trouble Shooting

The following checklist can help you solve some problems which you may encounter when using the unit. Before consulting it, check the connections and follow the instructions in the user manual. Do not use the unit in abnormal condition, for example without sound, or with smoke or foul smell can cause fire or electric shock, immediately stop using it and call the store where you purchased it.

Problem	Possible cause	Solution
<b>General</b>		
The unit will not switch on.	vehicle ignition is not on. Cable is not properly connected. Fuse is burnt.	Turn your vehicle key in the ignition. Check cable connection. Replace fuse with a new fuse of the same capacity.
No sound	Volume is set at minimum or the mute function is on.	Check the volume or switch the mute function off.
The unit or screen does not work normally.	The unit system is unstable.	Press the RESET button.
<b>Mode TUNER</b>		
Unable to receive stations.	The antenna is not connected properly.	Connect the antenna properly.
Poor quality reception of radio station.	The antenna is not fully extended or it is broken.	Fully extend the antenna and if broken, replace it with a new one.
<b>Mode USB</b>		
Unable to insert USB device	The USB device has been inserted the wrong way around.	Insert it the other way around.
The USB device cannot be read.	NTFS format is not supported.	Check that the file system is in FAT or FAT32 format. Due to different formats, some models of storage devices or MP3 players may not be read.

# Specifications

## General

Power supply : 12-volt DC or a 24-volt DC negative ground according to the right radio variant. (Refer to variants table)

Maximum power output: 41 W x 4 channels (4  $\Omega$ ) for 12-volt variant

Suitable speaker impedance: 4  $\Omega$

Dimensions (W x D x H): 188 x 114.7 x 58.5 mm

Weight: 0.9Kg

Note: for different bit-rate MP3, ESP time are different;  
40 seconds only for bit-rate MP3 file of 128Kbps

## FM Stereo Radio

Frequency range: Refer to AM/FM Tuner table

Usable sensitivity: < 14 dB $\mu$

Frequency response: 50 Hz – 10 KHz

Stereo separation:  $\geq$  22dB (1KHz)

Image response ratio:  $\geq$  40dB

IF response ratio:  $\geq$  60 dB

Signal/noise ratio:  $\geq$  50dB

## AM/MW) radio

Frequency range: Refer to AM/FM Tuner table

Usable sensitivity (S/N = 20 dB): < 35 dB $\mu$

USB Charging: 0.5A 5V

AM/FM tuner	BAND	RECEIVED FREQUENCY	AUTO SPACE	CHANNEL SPACE
American	FM	87.5 - 107.9MHz	200KHz	100KHz
	AM	530 - 1710KHz	10KHz	10KHz
EUROPE*	FM	87.5 - 108.0MHz	100KHz	50KHz
	MW	522 - 1620KHz	9KHz	9KHz
	LW	144 - 288KHz	3KHz	3KHz
ASIA	FM	87.5 - 108.0MHz	50KHz	50KHz
	AM	522 - 1629KHz	9KHz	9KHz
Japan	FM	76,0 - 95,0MHz	100KHz	100KHz
	AM	522 - 1629KHz	9KHz	9KHz
LATAM	FM	76,0 - 107.9MHz	50KHz	50KHz
	AM	530 - 1710KHz	10KHz	10KHz
NORTH AFRICA	FM	87.5 - 108.0MHz	100KHz	50KHz
	MW	531 - 1602KHz	9KHz	9KHz
	LW	153 - 252KHz	3KHz	3KHz

## Digital (DAB) Radio (applicable to DAB feature)

Frequency range:	DAB Band III: 174.928MHz ~ 239.200MHz DAB Band L: 1452.960MHz ~ 1490.624MHz		
Usable sensitivity (RF=-72 dBm):	-95dBm		
Frequency response:	20hz-20khz		
Stereo separation:	$\geq$ 50db		
Signal/noise ratio:	$\geq$ 60db		
	Item	Min	Max
	Far off selectivity:	42dB	60dB
Adjacent channel rejection:	35dB	40dB	

Note: specifications and the design are subject to change without notice due to improvements in technology

## Bluetooth

Output power	4 dBm (Class 2)
Frequency band	2.4000 GHz - 2.4835 GHz (ISM Band)
Range	10 meters (free space)
Standard	Bluetooth 2.0 specification



## Declaration of Conformity

17

Caterpillar Inc. declares the radio has been so constructed that it complies with basic requirements and other relevant regulations of the European Union directives 2014/53/EU and 2014/35/EU

# FCC

## FCC STATEMENT

This device complies with Part 15 of the FCC Rules. Operation is subject to the following two conditions:

- (1) This device may not cause harmful interference.
- (2) This device must accept any interference received, including interference that may cause undesired operation.
- (3) Changes or modifications not expressly approved by the party responsible for compliance could void the user's authority to operate the equipment.

### **NOTE:**

This equipment has been tested and found to comply with the limits for a Class B digital device, pursuant to Part 15 of the FCC Rules. These limits are designed to provide reasonable protection against harmful interference in a residential installation.

This equipment generates uses and can radiate radio frequency energy and, if not installed and used in accordance with the instructions, may cause harmful interference to radio communications. However, there is no guarantee that interference will not occur in a particular installation. If this equipment does cause harmful interference to radio or

television reception, which can be determined by turning the equipment off and on, the user is encouraged to try to correct the interference by one or more of the following measures:

Reorient or relocate the receiving antenna.

Increase the separation between the equipment and receiver

Connect the equipment into an outlet on a circuit different from that to which the receiver is connected.

Consult the dealer or an experienced radio/ TV technician for help.

## FCC Radiation Exposure Statement

This equipment complies with FCC radiation exposure limits set forth for an uncontrolled environment. This equipment should be installed and operated with minimum distance 20cm between the radiator & your body.

# Accessories

**Metal sleeve**



**Removal Tools**



**Bezel**



**[www.parts.cat.com](http://www.parts.cat.com)**

© 2017 Caterpillar

All Rights Reserved.

CAT, CATERPILLAR, their respective logos, “Caterpillar Yellow” the “Power Edge” trade dress, as well as corporate and product identity used herein, are trademarks of Caterpillar and may not be used without permission.



P/N: 127075017331