

Internal view

FCC ID: Y7HXGCS85

IC: 7002C-XGCS85

The Osisense XG Smart antenna is structured as below :

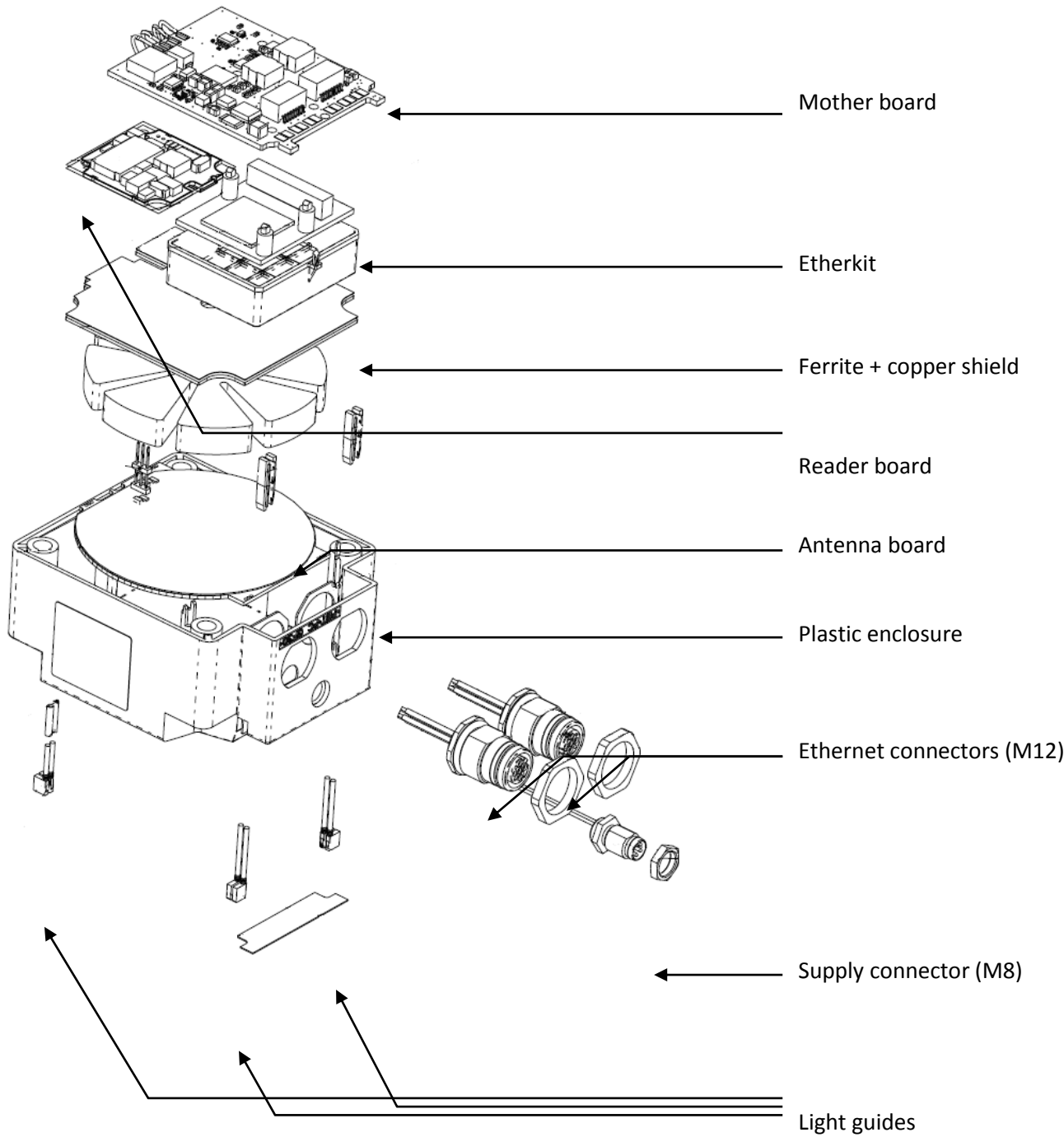

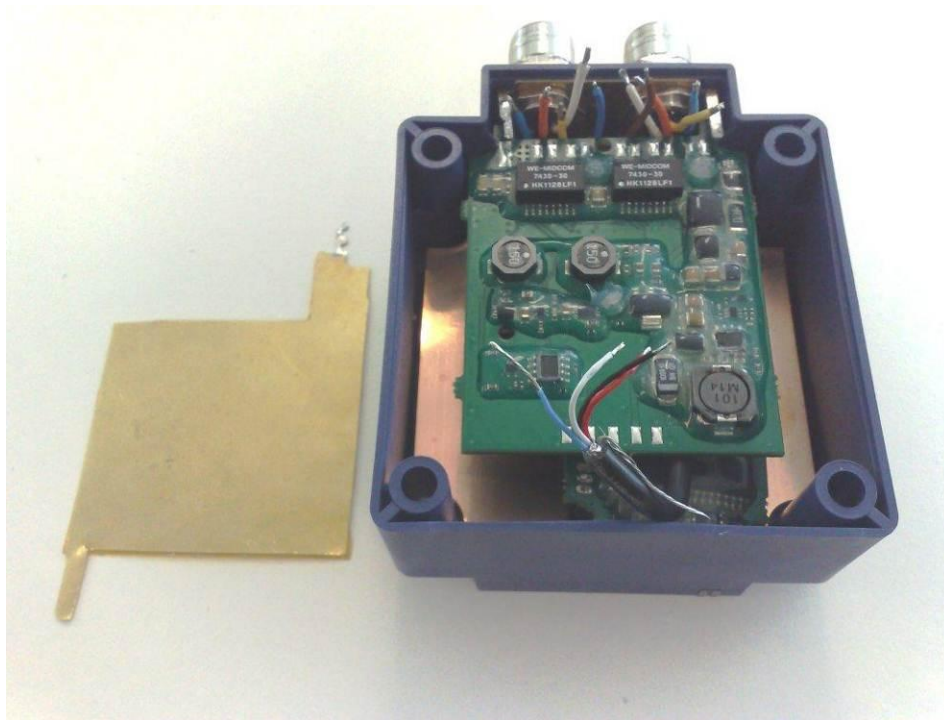

1 Mother board :

Top side :

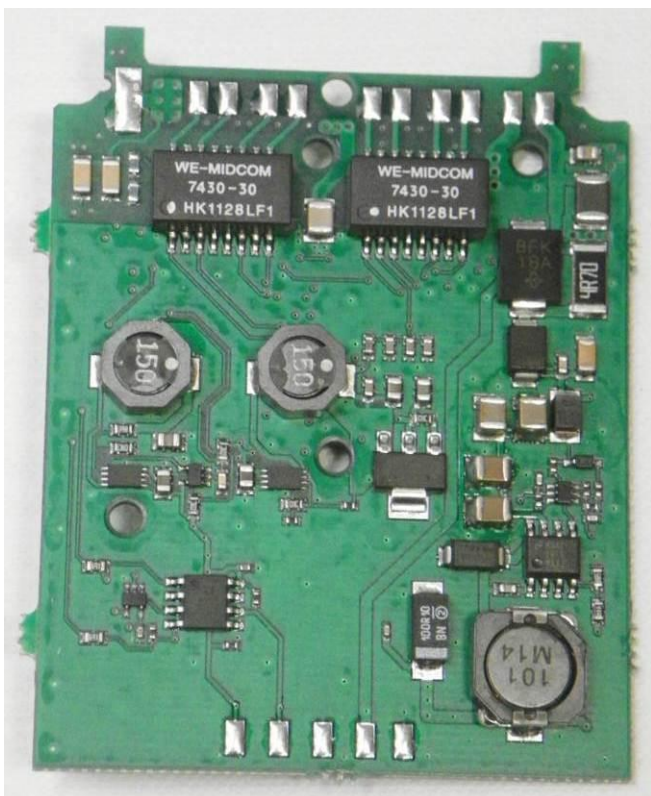

Bottom side :

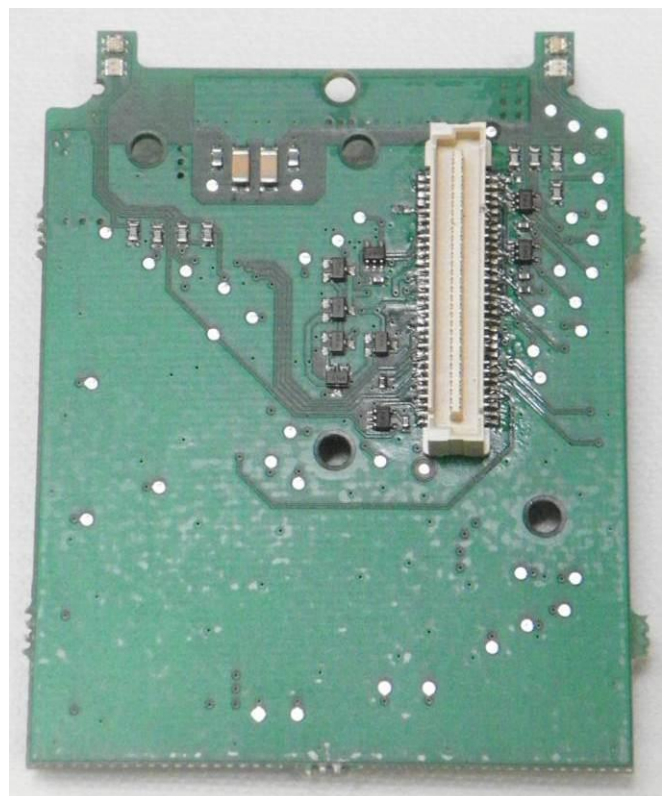

4.2 Etherkit :

Top side :

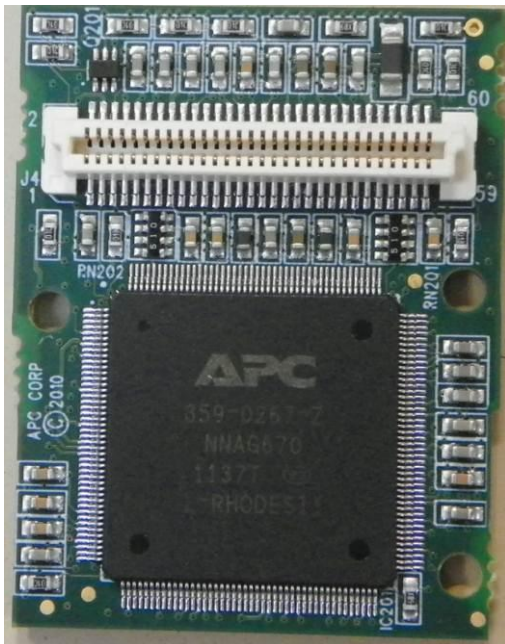

Bottom side :



3 Reader board :

Top side :

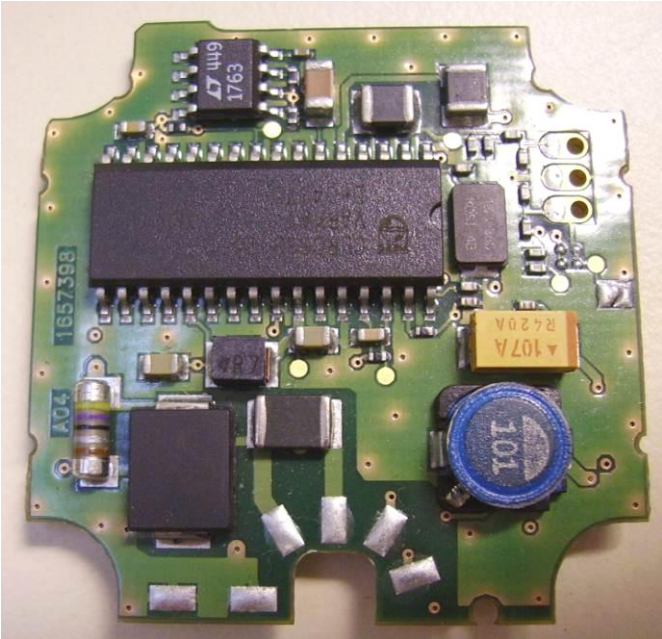

Bottom side :

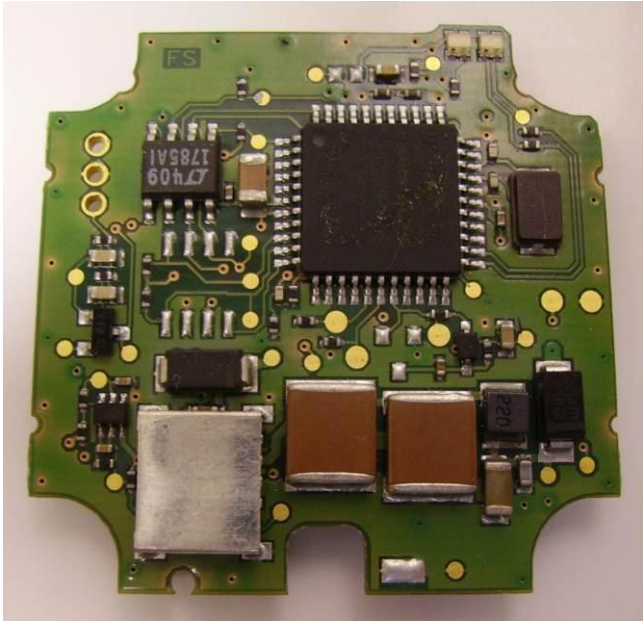

4 Antenna board :

Coil side :

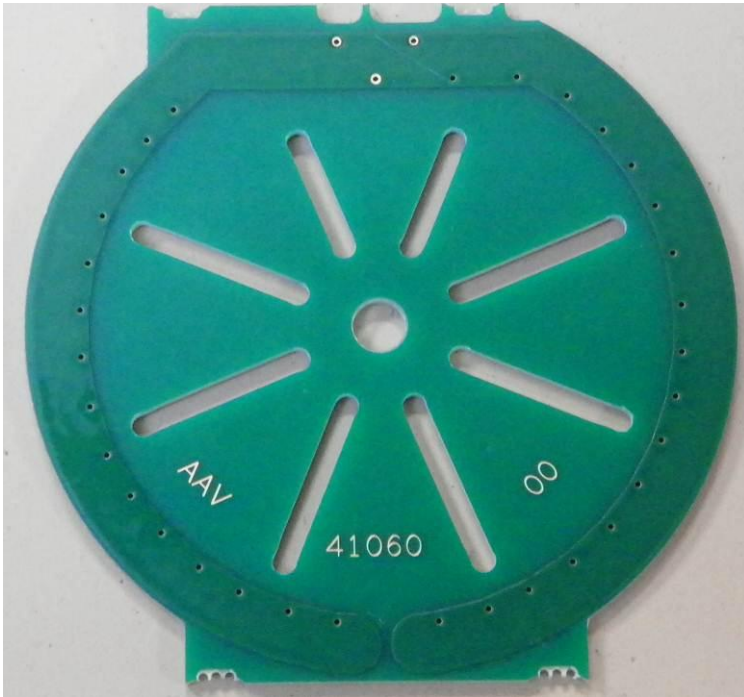

Components side :

