



**EN** USER INSTRUCTIONS AND SAFETY

Firmware Version: 4.0x

Congratulations on your purchase of an N-Com product.

N-Com **B5** was made using the most advanced technologies and the best materials. Long-running tests and thorough system development have allowed the highest audio quality to be achieved.

For additional information about **B5**, and to download high-definition instructions as well as the latest Firmware version, visit the website [www.n-com.it](http://www.n-com.it)

---

## REFERENCE STANDARDS

The products of the N-Com line are in compliance with standards as per the table below:

<b>B5</b>	The Bluetooth system complies with the main safety requirements and other applicable provisions of Directive 99/5/CE, Directive 2009/65/EC, Directive 2011/65/CE, Directive 2012/19/EU
-----------	--

<b>Battery charger</b>	Directive 2006/95, 2004/108, 2009/65/EC, 2011/65/CE, 2012/19/EU, 2009/125/CE
------------------------	--

<b>Battery</b>	Directive 2006/66/CE
----------------	----------------------

The Declarations of Compliance can be downloaded from the website [www.n-com.it](http://www.n-com.it) (Download section).

FccID: XXXXXX	 <b>Bluetooth</b> <sup>®</sup>	 XXXXXX	
---------------	---	--	--

Bluetooth is a registered trademark property of Bluetooth SIG, Inc.

# Contents

<b>1. WARNINGS AND SAFETY .....</b>	<b>4</b>
1.1.Road safety .....	4
1.2.Switching on the system in safe environments.....	4
1.3.Interferences .....	4
1.4.Appropriate use.....	4
1.5.Qualified personnel.....	5
1.6.Accessories and batteries .....	5
1.7.Disposal.....	6
<b>2. CONTENT OF THE PACKAGING .....</b>	<b>6</b>
<b>3. INSTALLATION .....</b>	<b>7</b>
3.1.Removing the B5 system from the helmet.....	10
<b>4. BASIC FUNCTIONS.....</b>	<b>11</b>
4.1.N-Com Wizard and N-Com App .....	11
4.1.Pairing up with Bluetooth devices .....	11
<b>5. MOBILE PHONE .....</b>	<b>12</b>
5.1.Friend Number.....	12
5.2.Managing two mobile phones (or Bluetooth devices).....	12
<b>6. MUSIC VIA BLUETOOTH – A2DP BLUETOOTH PROTOCOL .....</b>	<b>13</b>
<b>7. MUSIC VIA CABLE.....</b>	<b>13</b>
<b>8. SATELLITE NAVIGATOR FOR MOTORCYCLES.....</b>	<b>13</b>
8.1.Navigators on Smartphone (Smart Navi System) .....	14
<b>9. FM RADIO.....</b>	<b>14</b>
<b>10. AUTO ON / OFF FUNCTION .....</b>	<b>14</b>
<b>11. RIDER-PASSENGER INTERCOM.....</b>	<b>14</b>
11.1.Rider-Passenger intercom pairing up .....	14
11.2.Rider-Passenger intercom function .....	14
<b>12. BIKE TO BIKE INTERCOM.....</b>	<b>15</b>
12.1.Bike-to-Bike Intercom Affiliation (Standard configuration).....	15
12.2.Bike to bike intercom function.....	16
<b>13. “UNIVERSAL INTERCOM” INTERCOM.....</b>	<b>17</b>
13.1.Pairing up the UNIVERSAL INTERCOM .....	17
13.2.Universal Intercom Function .....	17
<b>14. SETTING MODE .....</b>	<b>18</b>
<b>15. BATTERY AND RECHARGE .....</b>	<b>18</b>
15.1.Low battery signal.....	18
15.2.Charging the system .....	18
<b>16. SCHEMA RIASSUNTIVO COMANDI – Configurazione standard .....</b>	<b>19</b>
<b>17. LIMITED WARRANTY .....</b>	<b>21</b>
17.1.Warranty coverage .....	21
17.2.Exclusions and limitations of the coverage.....	21
17.3.Validity of this limited warranty.....	22
17.4.Procedure for the forwarding of claims.....	22
17.5.Product identification.....	22
<b>18. WARRANTY REGISTRATION FORM .....</b>	<b>23</b>

## 1. WARNINGS AND SAFETY

Read this User Manual carefully, as well as the simple rules listed below. Failure to comply with these rules may lead to dangerous situations.

**Caution:** The product cannot be used in official or non-official competitions, motordromes, circuits, racing tracks and the like.

**Caution:** Installation of the N-Com **B5** system results in a weight increase of approximately 107g, which is added to the weight of the helmet and of the other accessories.

**Warning:** The electronic components of the N-Com system mounted inside the helmet are not waterproof. Consequently, make sure the inside of the helmet, including the comfort padding, does not get wet in order to avoid damage to the system. If it does, remove the N-Com system and the helmet comfort padding and let it air dry. Remove the battery from its housing and let it dry.

### 1.1. Road safety

Always obey all Traffic Regulations in force. While riding the motorcycle, your hands should always be engaged in actually riding the vehicle. Any operation to the N-Com system must be carried out with the vehicle stopped. Specifically:

- Set your cell phone on automatic answer (see the cell phone instructions to do this).
- If your cell phone is not equipped with this function, first stop your vehicle in a safe area, in compliance with Traffic Regulations and then answer the call.
- Do not make any calls while riding. Stop your vehicle in a safe place in compliance with Traffic Regulations, and then make the call.
- Adjust the volume so that it does not cause a disturbance or distraction while riding and at the same time allows you to distinctively hear background noises.
- Do not operate your cell phone or other devices connected to N-Com while riding your motorcycle.
- In all cases, obey the Traffic Regulations and remember that riding the motorcycle has absolute priority over any other manoeuvre.

### 1.2. Switching on the system in safe environments

- When using the N-Com system, comply with all limitations and instructions related to the use of cell phones.
- Do not turn on your cell phone or the N-Com system whenever their use is forbidden or when the devices can cause interference or dangerous situations.
- Turn off while refuelling. Do not use the N-Com system in filling stations. Do not use the device near combustible materials or chemical products.
- Turn off in proximity to explosive materials.

### 1.3. Interferences

All phones and devices with wireless signal transmission are subject to interferences that may affect the performance of the device connected to them. These interferences are not ascribable to a defect of the N-Com system.

### 1.4. Appropriate use

Use the device only in the normal position, as described in the product documentation. Do not attempt to disassemble, tamper with or modify any part of the N-Com system.

**Caution:** Adjust the volume of the N-Com system (where provided) and of the audio sources connected to it before you use the system on the road.

**Caution:** Adjusting the volume to very high levels may cause damage to your hearing.

**Caution:** Adjust the volume of the N-Com system (where provided) and of the audio sources connected to it so as to avoid audio reproduction at high volumes. Constant exposure to high audio volumes may damage your hearing.

**Caution:** An incorrect installation of the system in the helmet may alter the aerodynamic and safety characteristics of the helmet itself, thus creating dangerous conditions. Install the N-Com system according to the instructions provided in the product documentation. In case of doubt, please contact your local N-Com dealer.

**Warning:** Listening to other equipment should not interfere with driving the vehicle, which must be the top priority at all times. Carry out all operations on the electronic equipment and on the N-Com system with the vehicle stopped, in compliance with Traffic Regulations.

**Caution:** The N-Com system allows reception of the FM radio signal. Any radio licence fees are to the user's charge.

**1.5. Qualified personnel**

- Only qualified personnel can carry out technical assistance on this product. In case of any malfunction, always turn to your local dealer.
- The helmet is a safety device. Tampering with it and/or with the electronic system inside the helmet, in addition to invalidating the product warranty, can also lead to dangerous situations.

**1.6. Accessories and batteries**

- Only use the type of batteries, battery chargers and accessories approved by Nolan for the specific model.
- The use of a battery type different from the recommended one may lead to dangerous situations and invalidate the warranty.
- Contact your local dealer to see about the availability of approved accessories.
- When disconnecting the power supply cable of any accessory or of the battery charger, always grab and pull the plug not the cable.
- Do not use batteries for purposes other than the prescribed ones.
- Never use batteries or battery chargers that turn out to be damaged.
- Do not short-circuit the battery.
- Keep the battery at a temperature between **0° / +45°C (charging); -20° / +60 °C (in use)**.
- Danger of fire or explosion: do not throw the batteries into a fire nor expose them to high temperatures!
- Do not throw out batteries together with household refuse. The batteries should be disposed of in compliance with local regulations
- Do not wear the helmet while the battery is recharging.
- The helmet should never be left within the reach of unsupervised children in order to prevent damage to their health caused by access to the batteries.

<b>Battery</b>	Li-Po 523450P	Litio 3,7V – 1000 mAh
<b>Battery charger</b>	S-TR-009L	100/240V – 50/60 Hz 5V - 0.5 A

**1.7. Disposal**





Refer to this user manual and to manuals related to other parts of the N-Com system in order to disassemble the system from the helmet. Once the system has been disassembled, dispose of it according to the following instructions:

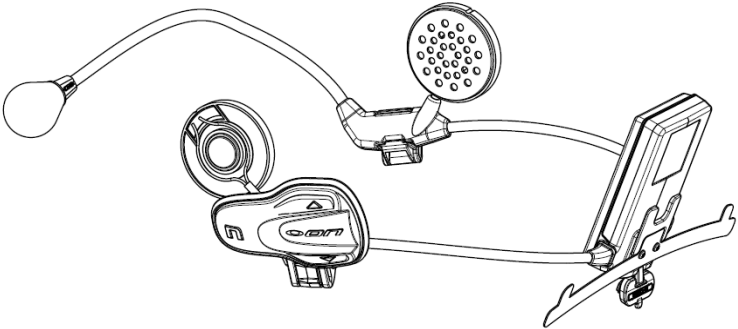

- The presence of a crossed-out wheeled bin indicates that in the European Union the product is subject to separate collection at the end of its useful life.
- Do not dispose of these products together with undifferentiated urban waste.
- The proper disposal of obsolete equipment contributes to preventing possible negative consequences on people's health and on the environment.
- For more detailed information on the disposal of obsolete equipment, contact your municipality, a waste disposal service or the store where the product was purchased.

**2. CONTENT OF THE PACKAGING**

The N-Com **B5** package contains:

	
<b>N-Com B5 system</b>	
	
<b>Mini USB wire</b>	<b>Battery charger</b>
	
<b>Key</b>	<b>Microphone foam</b>

### 3. INSTALLATION

**Important:** Prior to installing the N-Com system, it is recommended to write down the identification code affixed to the product (see chapter 17.5).

You can download the installation video from [www.n-com.it](http://www.n-com.it) N-Com / Download section.

- Before you install the **B5** system on the helmet, make sure it turns on properly. Press the “on” key for about 2 seconds, until the LED lights up and you hear a beep in the headset. Proceed with the installation.
- Remove the cheek padding (see helmet instructions).

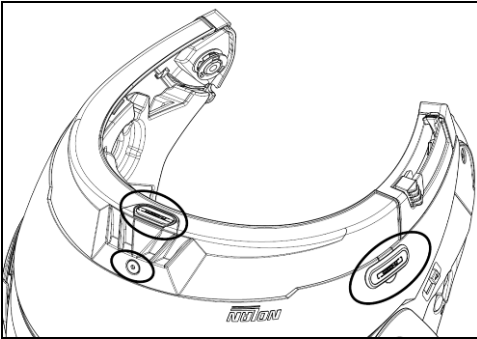

Fig. 1

- Remove the helmet edge gasket using the special tool (Fig. 1).
- Remove the “N-Com” plugs found at the back of the shell gasket and on the left side of the helmet (Fig. 1).

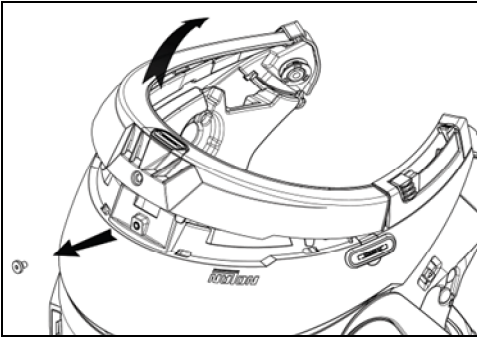

Fig. 2

- Completely remove the gasket as shown in Fig. 2; by doing so you also remove the padding.

- Prior to installing the N-Com system, remove any filling foam material found in the helmet.

**Option 1:** remove the bottom element in foam material and the filling materials in the housings of the N-Com earpieces located in the EPS cheek pads.

**Option 2:** remove the left and right side filling material as well as the filling material in the housings of the N-Com earpieces located in the EPS cheek pads.

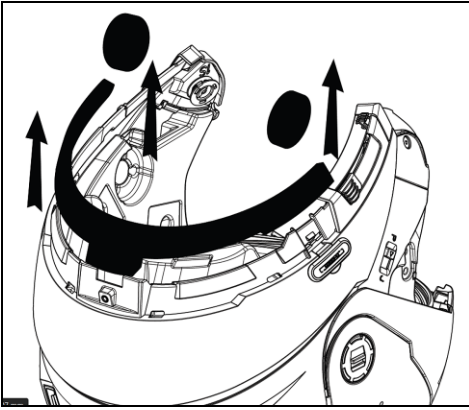

Option 1

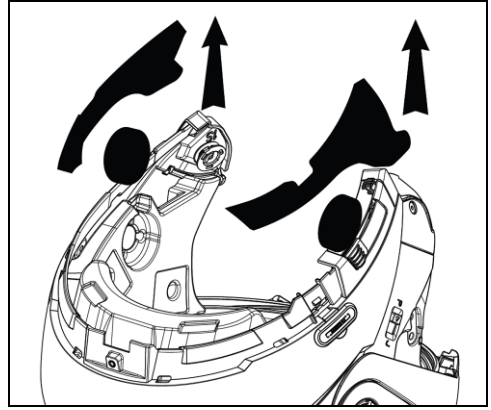

Option 2

**N.B.:** Keep the filling material in case you wish to use the helmet without the N-Com system in the future.

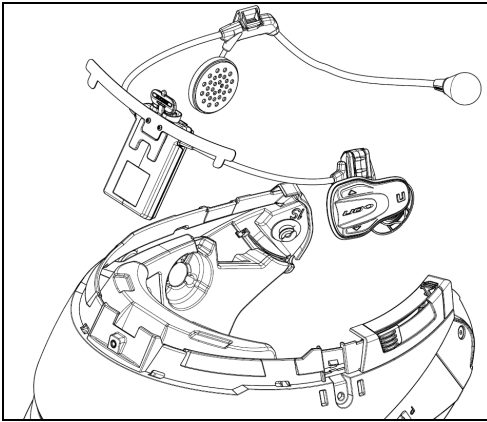

Fig. 3

- Place the system in the special housing in the back of the helmet, pushing it all the way into the groove (Fig. 3).

- Fold the antenna back inside the shell.

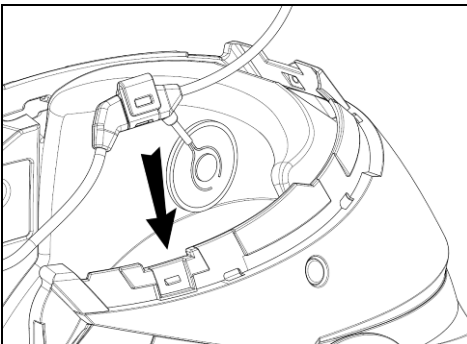

Fig. 4

- Fix the cable inside the helmet and make sure the right fixing clip snaps into its housing (Fig. 4)



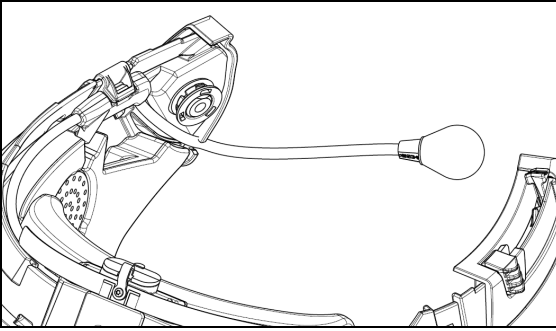

Fig. 5

- Position the microphone in the housing on the left of the helmet, inserting the metal boom in the groove found in the chin guard coupling frame (Fig. 5).

**Caution:** make sure that the side of the microphone support with the writing "N-Com" is facing inward.

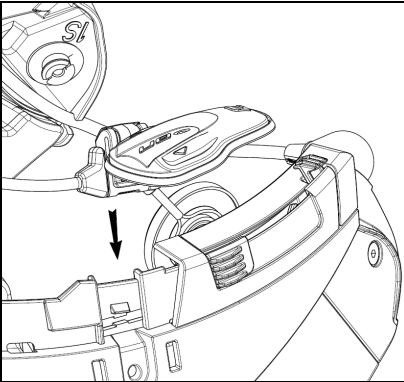

Fig. 6

- Fix the cable inside the helmet and make sure the left fixing clip snaps into its housing.
- Hook up the keypad to the helmet by clicking in the relevant hooks.

- Position the left and right speakers in the respective housing obtained in the polystyrene cheek padding. If necessary, rotate the speakers slightly in their housing.
- Reassemble the gasket and secure it with the specific screw
- Reassemble the cheek padding.

**3.1. Removing the B5 system from the helmet**

Proceed as follows to remove the **B5** system from the helmet:

- Remove the cheek padding and the shell gasket;

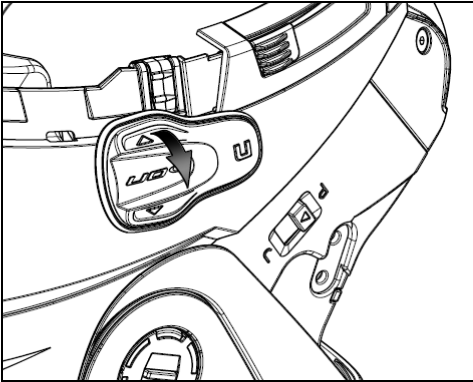

Fig. 7

- Remove the keypad from the shell, using a flat head screwdriver (or a similar tool) to lever upwards in the special hollow as shown in fig. 7.

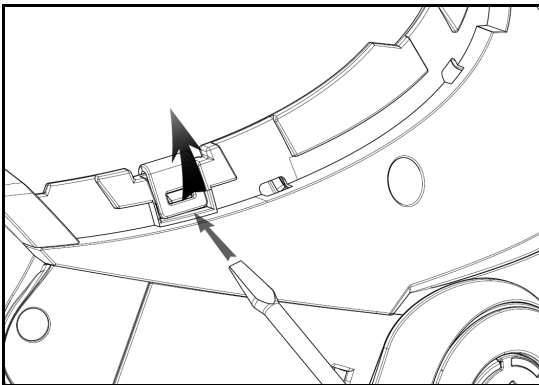

Fig. 8

- Unhook the right and left clips from the shell, levering upward using a flat head screw (or a similar tool), as shown in figure 8.

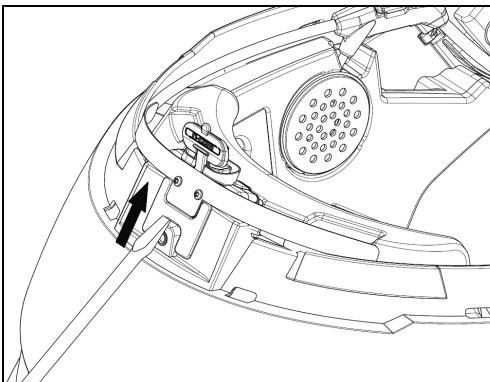



Fig. 9

- Completely remove the B5 system from helmet using a flat head screwdriver (or similar tool) and re-install the cheek padding and the edge gasket.

**4. BASIC FUNCTIONS**

<b>System ON</b>	Press “ <b>on</b> ” and keep it pressed for about 2 seconds, until the LEDs turn on and you hear a beep in the headset.
<b>System OFF</b>	Press “ <b>on</b> ” and keep it pressed for about 6 seconds, until the LEDs turn off and you hear a beep in the headset.
<b>Increase Volume</b>	Briefly press “▲” to increase the volume. A double tone signals the highest volume level.
<b>Decrease Volume</b>	Briefly press “▼” to decrease the volume. A double tone signals the lowest volume level.

**4.1. N-Com Wizard and N-Com App**



“N-Com Wizard” is the PC application that can be used to manage and configure the **B5** system.

The programme can be downloaded from the Internet site [www.n-com.it](http://www.n-com.it), in the “Download” section. In order to use it, a helmet equipped with **B5** must be connected to the PC, using the USB cable supplied with the system.

The functions that can also be managed from the N-Com Wizard are listed here below with the specific icon.



The N-Com system is preset to be hooked up to the “N-Com App”, the application compatible with Android, iPhone and iPad that can be used to configure and operate the N-Com system directly from a Smartphone.

With the N-Com App, you can carry out most of the functions included in the N-Com Wizard program or, alternatively, it can be used as a wireless Bluetooth keypad.

The N-Com APP can be downloaded free of charge from Google Play or Apple Store. For additional details, please visit the website [www.n-com.it](http://www.n-com.it)

The functions that can also be managed from the N-Com Wizard are listed here below with the specific icon.

**4.1. Pairing up with Bluetooth devices**

- Put the system in setting mode: press the “**on**” key and keep it pressed for **4 seconds**, until the blue LED starts to flash quickly;
- Turn on the search for Bluetooth devices (smartphone, GPS, MP3 reader) on the device;
- Select the N-Com device. If a password is requested, enter **0000** (four zeros);
- Connection between the two devices is established after a few seconds.

**Note:** The affiliation is stored in the helmet and in the cell phone and it is not lost when the two devices are turned off. As a result it needs to be carried out only once.

<b>Automatic Connection</b>	Once the Bluetooth device has been paired up, connection is automatic when the system is turned on.
<b>Manual Connection</b>	In case connection is not automatically initiated after a few seconds, you can connect from the Bluetooth device or by pressing “ <b>on</b> ” and “ <b>■</b> ” at the same time.

**5. MOBILE PHONE**

<b>Answering a phone call</b>	Briefly press any key when you hear the incoming call signal.
<b>Voice call</b>	Press “on” and keep it pressed for about 2 seconds.
<b>Redial last number</b>	Press “on” and “n” at the same time.
<b>Dial Friend Number</b>	Press “n” and keep it pressed for about 2 seconds.
<b>Hanging up/rejecting a phone call</b>	Press “on” and keep it pressed for about 2 seconds.
<b>Transferring a call from helmet to mobile phone</b>	To transfer an ongoing call from the helmet to the mobile phone, press both “on” and “n” at the same time and keep them pressed for 2 seconds.
<b>Manual phone connection</b>	Press “on” and “n” at the same time.
<b>Manual phone disconnection</b>	Press “▲” and keep it pressed for about 4 seconds.



**Conference call function**

When a call comes in on a mobile phone connected via Bluetooth to **B5**, the Rider-Pillion Passenger intercom is temporarily turned off. However, if you wish to share the phone call with the other helmet, simply turn on the intercom manually during the phone call.

<b>Turning on the phone conference call function</b>	During the phone call, briefly press “n”.
<b>Turning off the phone conference call function</b>	During the phone call, briefly press “n”.

**N.B.:** The Phone Conference Call function can only be used with a Rider-Pillion Passenger intercom (channel 1) and not with Bike-to-Bike communication (channels 2-6).

**5.1. Friend Number**

 	When you use the N-Com Wizard or the N-Com App, you can choose a “Favorite Number”, which you can be call by pressing a speed-dial button.
--	--

<b>Calling the Friend Number</b>	Press the “n” key and keep it pressed for 2 second.
----------------------------------	---

**5.2. Managing two mobile phones (or Bluetooth devices)**

The **B5** system can be hooked up to two phones (or Bluetooth) devices at the same time. The second phone (secondary device) can receive calls but not make them.

To pair up the second Bluetooth phone (secondary device):

- press the “on” key and keep it pressed for **4 seconds**, until the blue LED starts to flash quickly (setting mode);
- Press the “on” key and keep it pressed for about 2 seconds.
- Turn on the search for Bluetooth devices (smartphone, GPS, MP3 reader) on the device;
- Select the N-Com system from the list

## 6. MUSIC VIA BLUETOOTH – A2DP BLUETOOTH PROTOCOL

<b>Play music (Play)</b>	Briefly press “on”.
<b>Pause function (Pause)</b>	When the player is connected and playing music, briefly press “on”.
<b>Next track (Skip)</b>	When the player is playing music, press “▲” for 2 about seconds.
<b>Previous track (Rew)</b>	When the player is playing music, press “▼” for 2 about seconds.
<b>Turning off the A2DP</b>	Press “on” and keep it pressed for about 4 seconds.
<b>Turning on the A2DP</b>	The A2DP is already active when the system is turned on; otherwise, press the “on” key briefly.



You can also configure these settings through Smartphone Android, iPhone and iPad thanks to the dedicated N-Com App.

## 7. MUSIC VIA CABLE

Connect the mini USB connector of the Multimedia Wire (not included) to the helmet and the other end to the audio device. A coloured band on the cable indicates the connector to be hooked up to the audio device.

<b>Turning on the cable audio</b>	Press the “on” key three times.
<b>Turning off the cable audio</b>	Press the “on” key three times.

## 8. SATELLITE NAVIGATOR FOR MOTORCYCLES

B5 system is compatible with the most common satellite navigators for motorcycles. For a list of compatible models and additional details, visit the website [www.n-com.it](http://www.n-com.it)

To pair up a satellite navigator to the B5 system, follow the same procedure illustrated in Chapter 4.2.

### GPS Conference Call Function

The Conference function allows you to keep the “Rider-Pillion Passenger” intercom open even while the satellite navigator is giving instructions, thus preventing the intercom mode to be turned off every time the navigator gives instructions. However, if you wish to activate the Conference GPS function, simply turn on the intercom manually during the GPS directions.

<b>Turning on the GPS Conference function</b>	During the GPS directions, briefly press “■”.
<b>Turning off the GPS Conference function</b>	During the GPS directions, briefly press “■”.

At the end of the GPS communication, the intercom with the second helmet stays open and the “Conference” setting is stored for future GPS communications.

**N.B.:** The GPS Conference function can only be used with the Rider-Pillion Passenger intercom (channel 1) and not with the Bike-to-Bike communication (channels 2-6).

### 8.1. Navigators on Smartphone (Smart Navi System)

By connecting the **B5** system to a Smartphone, all navigator instructions are sent to the helmet through the A2DP profile. During each navigator communication, the intercom via Bluetooth is automatically cut off and subsequently restored when the navigator has stopped giving road instructions (SMART NAVI SYSTEM function).

The Smart Navi System function can be turned off in Setting Mode (see Chapter 15).

## 9. FM RADIO

Turning on the radio	Press the “on” key twice
Turning off the radio	Press the “on” key twice.
New station automatic search	Press “▲” and keep it pressed for 2 seconds.
Pre-setting a radio station (max. 6 stations)	Press “▼” and keep it pressed for 4 seconds.
Changing radio stations (among the pre-set ones)	Press “▼” and keep it pressed for 2 seconds.



This function can also be turned on through PC using the “N-Com Wizard” programme or through the “App N-Com” for Smartphone Android, iPhone, iPad.

## 10. AUTO ON / OFF FUNCTION

The system does not have to be turned on and off every time you use the motorcycle: thanks to the triaxial accelerometer, if the helmet does no move for more than 30 seconds, the **B5** system goes into “deep sleep” mode. The system is completely turned on as soon as movement is detected.

If the system is in “deep sleep” mode for more than 7 days, it turns off completely. To turn it back on, the “on” key need to be pressed.

## 11. RIDER-PASSENGER INTERCOM

### 11.1. Rider-Passenger intercom pairing up

- Put both systems in Setting mode (press the “on” key and keep it pressed for 4 seconds, until the blue LED starts to flash quickly);
- Press the “■” key briefly on one of the systems (Channel 1 pairing up).

### 11.2. Rider-Passenger intercom function

After carrying out the proper pair up procedure, turn on the two helmets. Intercom connection will be established automatically (this will take a few seconds. Wait until you hear the vocal confirmation message). If automatic connection is not possible, proceed with the manual connection.

Manual intercom connection	With <b>B5</b> turned on, briefly press “■”.
Manual intercom disconnection	With <b>B5</b> turned on, briefly press “■”.

**12. BIKE TO BIKE INTERCOM**

The N-Com system is used for bike-to-bike communication up to a distance of about **500 m** (open terrain, no obstacles).

The **B5** system entails the use of a default **"STANDARD"** commands configuration, or the use of a **"FRIENDS"** configuration that can be turned on from the N-Com Wizard or dedicated App.

The difference between the two configurations lies in the number of motorcycles that can be hooked up: the STANDARD configurations allows up to 3 different motorcycles to be hooked up to the **B5** system, while the FRIENDS configurations allows up to a total of 6.

**Important:** If you use the FRIENDS configuration, you need to visit the N-Com website and download the dedicated commands diagram (section Download/Command Summary Diagram).

**N.B.:** The range and quality of the communication may vary significantly depending on the presence of obstacles, weather conditions, magnetic fields.

**N.B.:** The range of the communication varies depending on the N-Com systems used.

**12.1. Bike-to-Bike Intercom Affiliation (Standard configuration)**

- Put both systems A and B in Setting Mode (press the **"on"** key and keep it pressed for 4 seconds, until the blue LED starts to flash quickly);
- On system A, press the command related to the "setting position" where you wish to store system B;

Pairing up CHANNEL 1	Briefly press <b>"■"</b> .
Pairing up CHANNEL 2	Press the <b>"■"</b> key twice.
Pairing up CHANNEL 3	Press the <b>"■"</b> key three times.
<b>Pairing up CHANNEL 4</b>	Briefly press <b>"on"</b> .
<b>Pairing up CHANNEL 5</b>	Press the <b>"on"</b> key twice.
<b>Pairing up CHANNEL</b>	Press the <b>"on"</b> key three times.

**N.B.:** Channels 4-5-6 can be used with the FRIENDS configuration only.

CHANNEL 1 is typically used for the Rider-Pillion Passenger connection, however it can also be used for the Bike-to-Bike intercom.

The use of CHANNEL 1 is different from the other channels due to the following specific characteristics:

- When the systems are turned on, the intercom is automatically activated.
- The Phone Conference function and the GPS Conference function can be used.

**12.2. Bike to bike intercom function**

**How the Bike-to-Bike call works (Standard Configuration)**

<b>Connection CHANNEL 1</b>	Briefly press " <b>■</b> ".
<b>Call CHANNEL 2</b>	Press the " <b>■</b> " key twice.
<b>Call CHANNEL 3</b>	Press the " <b>■</b> " key three times.
<b>Disconnection of active intercom</b>	Briefly press " <b>■</b> ".

Con FRIENDS CONFIGURATION active:

<b>Call CHANNEL 4</b>	Briefly press " <b>on</b> ".
<b>Call CHANNEL 5</b>	Press the " <b>on</b> " key twice.
<b>Call CHANNEL 6</b>	Press the " <b>on</b> " key three times.
<b>Disconnection of active intercom</b>	Briefly press " <b>on</b> ".

**N.B.:** In case the memory setting is empty, or the other helmet cannot be reached, an error tone will sound in your helmet.

**Taking a Bike to Bike call**

Four calling tones will sound in the helmet receiving the Bike-to-Bike call, and all open audio functions will be temporarily cut off (including the Rider – Pillion Passenger intercom, if any).

<b>Answering a Bike to Bike phone call</b>	Briefly press any key when you hear the incoming call signal.
--	---

- In case you take the call, communication is automatically established.
- In case the call is not answered, the system returns to the situation prior to receiving the call.



### **13. "UNIVERSAL INTERCOM" INTERCOM**

The N-Com **B5** system can be connected via Bluetooth to intercom systems of other brands, thanks to the UNIVERSAL INTERCOM function.

#### **13.1. Pairing up the UNIVERSAL INTERCOM**

The N-Com system can be paired up to an intercom of a different brand (from now on referred to as Intercom **B**) as if it was a mobile phone.

1. Put the N-Com system in Setting Mode: press the "**on**" key and keep it pressed for 4 seconds, until the blue LED starts to flash quickly;
2. Put intercom B in the mobile phone pairing up mode (refer to the Intercom B manual);
3. When both systems are in the pair up mode (setting), on the N-Com system press the command related to the "setting position" where you wish to store intercom B (CHANNEL 1-3), see paragraph 12.1;
4. After a few seconds, Intercom B will emit the "phone connection" confirmation beep;
5. To turn on communication between the two, briefly press the "**on**" key on the N-Com system.

#### **13.2. Universal Intercom Function**

To turn on and off the audio between two helmets, proceed as follows:

##### **From the N-Com system:**

Connect or disconnect Intercom B as you would for a regular N-Com intercom (chapter 11-12)  
Interco B receives a dialing one that must be answered with a phone reply command.

##### **From an intercom of a different brand**

Press the "Voice Call" command. The N-Com system receives a dialing tone; answer by pressing any key.  
To disconnect the intercom, press "Voice Call" once again.







##### **N.B.:**

- The N-systems keeps an active connection with a mobile phone or a GPS even during Bluetooth communication with other intercom systems.
- The intercom system connected to N-Com may not allow simultaneous connection to a mobile phone.

## 14. SETTING MODE

All Bluetooth pair ups and other adjustments are carried out in this mode.

To put the system in Setting mode, press the "on" key and keep it pressed for 4 seconds, until the red LED starts to flash quickly.

		ON	 + ON			 + 
Turning on/off the RDS					x1	
Turning on/off the Smart Navi System				2 sec		
Pairing up Secondary Phone		2 sec				
Pairing up CHANNEL 1	x1					
Pairing up CHANNEL 2	x2					
Pairing up CHANNEL 3	x3					
Pairing up CHANNEL 4		X				
Pairing up CHANNEL 5		x2				
Pairing up CHANNEL 6		x3				
Reset						4 sec

\*With Friends Configuration active.

## 15. BATTERY AND RECHARGE

### 15.1. Low battery signal

During its operation, the system alerts the user with a voice message when the battery is low. From the first message, the system has a 1-hour autonomy. Warning is given every 10 minute.

### 15.2. Charging the system

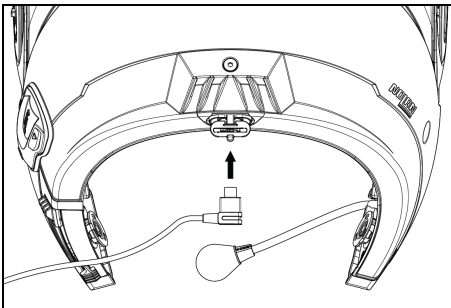

- To charge the system, hook it up to the battery charger or to a USB outlet powered with the USB-mini USB cable supplied as standard equipment. The charge will take place as follows:

<b>B5 system turned off</b>	When the B5 system is connected to the battery charger, the blue LED starts to flash quickly. When the battery is charged, the blue LED becomes steady.
<b>B5 system turned on</b>	When the B5 system is connected to the battery charger, the blue LED starts to flash quickly. When the battery is charged, the blue LED goes back to its standard flashing.

**N.B.:** If the device has not been charged for a long time (a few months), it may not be possible to turn on the system during the first few minutes of the charging, as the voltage may drop below the minimum limit.

**16. SUMMARY TABLE OF CONTROLS – STANDARD CONFIGURATION**

<i>Button</i>		<b>⏏</b>	<b>on</b>	<b>⏏ + on</b>	<b>▲</b>	<b>▼</b>	<b>▲ + ▼</b>
<b>Basic Functions</b>	Turning on						
	Turning off		<b>6 sec</b>				
	Increase Volume				<b>X</b>		
	Decrease Volume					<b>X</b>	
<b>Bluetooth Devices</b>	Answer phone call	<b>X</b>	<b>X</b>		<b>X</b>	<b>X</b>	
	Voice call		<b>2 sec</b>				
	Redial last number			<b>X</b>			
	Dial Friend Number	<b>2 sec</b>					
	Hang up/reject a phone call		<b>2 sec</b>				
	Call transfer			<b>2 sec</b>			
	Manual Device Connection			<b>X</b>			
	Manual Device Disconnection				<b>4 sec</b>		
	Turning on the Conference function	<b>X</b>					
	Turning off the Conference function	<b>X</b>					
<b>Intercom</b>	Connection CHANNEL 1	<b>X</b>					
	Disconnection of active intercom	<b>X</b>					
	Calling CHANNEL 2	<b>x2</b>					
	Calling CHANNEL 3	<b>x3</b>					
<b>Bluetooth Music / Cable</b>	Play music (Play)		<b>X</b>				
	Pause Function (Pause)		<b>X</b>				
	Next track (Forward)				<b>2 sec</b>		
	Previous track (REW)					<b>2 sec</b>	
	Enable A2DP profile		<b>X</b>				
	Disable A2DP profile		<b>4 sec</b>				
	Activate audio via cable		<b>x3</b>				
	Deactivate audio via cable		<b>x3</b>				

<i>Button</i>		<b>⏏</b>	<b>on</b>	<b>⏏ + on</b>	<b>▲</b>	<b>▼</b>	<b>▲ + ▼</b>
<b>Radio Menu</b>	Turning on the Radio		<b>x2</b>				
	Turning off the Radio		<b>x2</b>				
	Automatic search for new station				<b>2 sec</b>		
	Change station (pre-set stations)					<b>2 sec</b>	
	Pre-set station					<b>4 sec</b>	

<b>Setting*</b>	Pairing up mode (system turned off)						
	Turning on/off the RDS					<b>X</b>	
	Turning on/off the Smart Navi System				<b>2 sec</b>		
	Pairing up secondary mobile phone (or device)		<b>2 sec</b>				
	Pairing up CHANNEL 1	<b>X</b>					
	Pairing up CHANNEL 2	<b>x2</b>					
	Pairing up CHANNEL 3	<b>x3</b>					
	Pairing up CHANNEL 4		<b>X</b>				
	Pairing up CHANNEL 5		<b>x2</b>				
	Pairing up CHANNEL 6		<b>x3</b>				
	Reset						<b>4 sec</b>

\* All the Setting functions must be carried with the system in Setting Mode.

\*\*With Friends Configuration active.

## 17. LIMITED WARRANTY

With this LIMITED WARRANTY CERTIFICATE, Nolangroup warrants this Product to be free from defects in material and workmanship at the time of its original purchase by the buyer. We invite you to:

- Read the cautions pertaining to safety and proper use.
- Read the warranty terms and conditions.
- Keep the original sales receipt. This must be shown in case of repairs covered by warranty. In these cases, the product has to be taken back to the dealer where it was purchased.

### 17.1. Warranty coverage

If any defect covered by this limited warranty certificate is discovered within 2 (two) years from the purchase date shown on the tax receipt, Nolangroup shall repair or replace the defective product through its distribution network after having verified the defect. Nolangroup shall supply all the material and labor that is reasonably required to remedy the defect, except in those cases where the damage is caused by one of the items listed in the following paragraph "Exclusions and limitations of the Coverage".

### 17.2. Exclusions and limitations of the coverage

This warranty only covers defects in materials and manufacturing. Nolangroup shall not be considered responsible for product defects that can be attributed, either partially or in full, to any other cause, including but not limited to:

- Defects or damages resulting from using the Product in conditions that differ from the usual ones.
- Damages caused by improper use not conforming with normal operation in accordance with the product operating and maintenance instructions provided by Nolangroup.
- Negligence and normal wear of internal and external parts.
- Any damage caused by an accident;
- Any change or modification made to the helmet or to the N-com system by the user or by third parties.
- Colour changes or damages caused by exposure to harmful chemical products.
- The use of incompatible accessories that are not part of the N-Com product range.
- Moreover, the warranty does not cover product defects caused by fortuitous events, modifications or adjustments, causes of force majeure or damages deriving from the product coming in contact with liquids.
- The internal helmet components are not and cannot be waterproof. Consequently, any improper exposure to rain, humidity, food spillages or other liquids can result in damages to the N-Com electronic devices, damages for which Nolan shall not be responsible.
- This warranty does not include those parts subject to wear and tear such as, for example, the rechargeable battery and the cables used for connection between the various N-Com systems or between the N-Com systems and other devices.
- Since Nolangroup does not supply the system on which the cell phones work, it shall not be responsible for the operation, availability, coverage, services or range pertaining to the aforementioned system.
- Whenever the product is used in conjunction with accessories or equipment not supplied by Nolangroup, Nolangroup shall not guarantee proper operation of the product/device combination, nor will it accept requests for repairs or replacements under warranty in case the product is used in such a way.

Nolangroup shall not be responsible in case the product presents limited capabilities due to the operating mode of cell phones or of other accessories or equipment not supplied by Nolangroup.

Tampering with the internal electronic card or with other parts of the N-Com system shall invalidate the warranty.

Moreover, the defects covered by this warranty do not include all those specific and subjective situations that may come up during the active use of the helmet such as, for example, comfort problems while riding or aerodynamic noises.

Nolangroup shall not be held responsible in any case for incidental or consequential damages (including, without any limitation whatsoever, damages to one or more persons) resulting from non-fulfilment of the obligations arising from this warranty as it pertains to Nolangroup products.

### **17.3. Validity of this limited warranty**

This warranty is valid only if the enclosed warranty form is duly and completely filled out with the following information:

- Product identification code
- Name and stamp of the authorized dealer.
- Product purchase date.
- Buyer's name and address.

Nolangroup reserves itself the right to not carry out repairs under warranty if the aforementioned information is removed or modified after the original purchase of the product from the dealer.

### **17.4. Procedure for the forwarding of claims**

To forward a claim covered by this warranty, the buyer has to directly notify the dealer where the helmet was purchased with regards to the defect, presenting at the same time the defective product, a copy of the sales receipt and the Warranty registration form, duly filled out as instructed above.

PRIOR TO CONTACTING THE DEALER, WE RECOMMEND THAT YOU READ CAREFULLY THE USER MANUAL ENCLOSED WITH THE PRODUCT.

AFTER 2 (TWO) YEARS FROM THE DATE OF PURCHASE, THIS LIMITED WARRANTY IS VOID FOR ALL EFFECTS AND PURPOSES.

Repairs or maintenance under warranty do not extend the period of the warranty itself. Therefore, in case the product or one of its components is replaced, this does not initiate a new warranty period, as the purchase date of the original product shall be taken into account for warranty purposes.

Only for repairs or replacement of electronic components, in the event that Nolangroup proceeds to repairing or replacing the product, said product shall enjoy a warranty period equal to the residual portion of the original warranty or ninety (90) days from the repair date (the longer period being considered).

The repair or replacement can be carried out even with regenerated components with equivalent functions.

The replaced parts or components shall become property of Nolangroup.

THIS WARRANTY VOIDS AND REPLACES ANY OTHER WRITTEN OR VERBAL WARRANTIES PROVIDED FOR BY THE LAW THAT CAN BE DEROGATED AT THE PARTIES' WILL; SPECIFICALLY, NOLANGROUP DOES NOT GRANT SPECIFIC WARRANTIES OF MERCHANTABILITY OR FITNESS FOR A PARTICULAR PURPOSE. IN NO CASE SHALL NOLANGROUP BE LIABLE FOR INCIDENTAL OR CONSEQUENTIAL DAMAGES INCLUDING BUT NOT LIMITED TO LOST PROFITS OR COMMERCIAL DAMAGES, TO THE FULL EXTENT THOSE DAMAGES CAN BE DISCLAIMED BY THE LAW.

NOLANGROUP RESERVES ITSELF THE RIGHT TO MODIFY, AT ANY TIME AND WITHOUT ADVANCE NOTICE, THE PRODUCT CHARACTERISTICS, FUNCTIONS, COMPATIBILITY AND SOFTWARE.

Some Countries do not allow the exclusion or limitation of incidental or consequential damages, or the limitation of the duration of implied warranties; as a result of this, the previous limitations and exclusions may not be applicable to you.

This warranty does not have any effect on the customer's legal rights under the national jurisdiction in force or on the consumer's rights towards the dealer sanctioned by the purchase/sale contract.

This warranty is valid throughout the European territory, and it represents the only express warranty provided by Nolangroup in relation to the sale of its own products. This warranty does not affect the rights to which the buyer is entitled and which are expressly provided for by Directive 1999/44/CE.

This warranty does not affect the consumer's rights provided for by the law, and specifically by the provisions of Legislative Decree 2 February 2002 n. 24.

### **17.5. Product identification**

N-Com products are identified by means of a code that allows product traceability and identification.

The identification code is listed on the adhesive label applied to the B5 system and on the outside of the sales package.

**IMMAGINE**

**18. WARRANTY REGISTRATION FORM**

**Product name** B5

**Identification code**

--	--	--	--	--	--	--	--	--	--	--	--	--	--	--

**Buyer's Information**

**Name**

**Last name**

**Address**

**Phone**

**e-mail**

**Dealer's stamp**

**Date of purchase**



[www.n-com.it](http://www.n-com.it)



Printed on recycled paper

