

7.3.2. Test Procedures for Conducted Spurious Emissions

1. The transmitter output was connected to the spectrum analyzer.
2. The **reference level** of the fundamental frequency was measured with the spectrum analyzer using RBW = 100 kHz, VBW = 300 kHz.
3. The conducted spurious emission was tested each ranges were set as below.

Frequency range : 9 kHz ~ 30 MHz

RBW = 100 kHz, VBW = 300 kHz, SWEEP TIME = AUTO, DETECTOR = PEAK, TRACE = MAX HOLD, SWEEP POINT : 40001

Frequency range : 30 MHz ~ 10 GHz, 10 GHz ~ 25 GHz

RBW = 1 MHz, VBW = 3 MHz, SWEEP TIME = AUTO, DETECTOR = PEAK, TRACE = MAX HOLD, SWEEP POINT : 40001

LIMIT LINE = 20 dB below of the reference level of above measurement procedure Step 2. (RBW = 100 kHz, VBW = 300 kHz)

If the emission level with above setting was close to the limit (ie, less than 3 dB margin) then zoom scan is required using RBW = 100 kHz, VBW = 300 kHz, SPAN = 100 MHz and BINS = 2001 to get accurate emission level within 100 kHz BW.

Also the path loss for conducted measurement setup was used as described on the Appendix I of this test report.

7.4. Test Results

7.4.1. Radiated Emissions

9 kHz ~ 25 GHz Data (Modulation : GFSK)

▪ Lowest Channel

Frequency (MHz)	ANT Pol	The worst case EUT Position (Axis)	Detector Mode	Reading (dBuV)	T.F (dB/m)	D.C.F (dB)	Distance Factor (dB)	Result (dBuV/m)	Limit (dBuV/m)	Margin (dB)
2385.99	H	Z	PK	55.99	0.69	N/A	N/A	56.68	74.00	17.32
2385.99	H	Z	AV	55.99	0.69	-24.79	N/A	31.89	54.00	22.11
4803.34	H	Y	PK	52.41	4.77	N/A	N/A	57.18	74.00	16.82
4803.34	H	Y	AV	52.41	4.77	-24.79	N/A	32.39	54.00	21.61
12007.57	H	Y	PK	46.93	13.32	N/A	N/A	60.25	74.00	13.75
12007.57	H	Y	AV	46.93	13.32	-24.79	N/A	35.46	54.00	18.54

▪ Middle Channel

Frequency (MHz)	ANT Pol	The worst case EUT Position (Axis)	Detector Mode	Reading (dBuV)	T.F (dB/m)	D.C.F (dB)	Distance Factor (dB)	Result (dBuV/m)	Limit (dBuV/m)	Margin (dB)
7321.56	H	Y	PK	54.24	7.60	N/A	N/A	61.84	74.00	12.16
7321.56	H	Y	AV	54.24	7.60	-24.79	N/A	37.05	54.00	16.95
12202.67	H	Y	PK	53.32	13.55	N/A	N/A	66.87	74.00	7.13
12202.67	H	Y	AV	53.32	13.55	-24.79	N/A	42.08	54.00	11.92

▪ Highest Channel

Frequency (MHz)	ANT Pol	The worst case EUT Position (Axis)	Detector Mode	Reading (dBuV)	T.F (dB/m)	D.C.F (dB)	Distance Factor (dB)	Result (dBuV/m)	Limit (dBuV/m)	Margin (dB)
2483.52	H	Z	PK	66.51	0.94	N/A	N/A	67.45	74.00	6.55
2483.52	H	Z	AV	66.51	0.94	-24.79	N/A	42.66	54.00	11.34
7438.53	H	Y	PK	55.83	7.57	N/A	N/A	63.40	74.00	10.60
7438.53	H	Y	AV	55.83	7.57	-24.79	N/A	38.61	54.00	15.39
12397.38	H	Y	PK	48.05	13.77	N/A	N/A	61.82	74.00	12.18
12397.38	H	Y	AV	48.05	13.77	-24.79	N/A	37.03	54.00	16.97

• Note.

1. The radiated emissions were investigated 9 kHz to 25GHz. And no other spurious and harmonic emissions were found above listed frequencies.

2. Information of Distance Factor

For finding emissions, the test distance might be reduced from 3m to 1m. In this case, the distance factor(-9.54dB) is applied to the result.

- Calculation of distance factor = $20 \log(\text{applied distance} / \text{required distance}) = 20 \log(1 \text{ m} / 3 \text{ m}) = -9.54 \text{ dB}$

When distance factor is "N/A", the distance is 3 m and distance factor is not applied.

3. D.C.F Calculation. (D.C.F = Duty Cycle Correction Factor)

- Time to cycle through all channels = $\Delta t = T [\text{ms}] \times 20$ minimum hopping channels, where T = pulse width = 2.88 ms

- $100 \text{ ms} / \Delta t [\text{ms}] = H \rightarrow$ Round up to next highest integer, to account for worst case, $H' = 100 / (2.88 \times 20) = 1.74 \approx 2$

- The Worst Case Dwell Time = $T [\text{ms}] \times H' = 2.88 \text{ ms} \times 2 = 5.76 \text{ ms}$

- D.C.F = $20 \log(\text{The Worst Case Dwell Time} / 100 \text{ ms}) \text{ dB} = 20 \log(5.76 / 100) = -24.79 \text{ dB}$

4. Sample Calculation.

Margin = Limit - Result / Result = Reading + T.F + D.C.F / T.F = AF + CL - AG

Where, T.F = Total Factor, AF = Antenna Factor, CL = Cable Loss, AG = Amplifier Gain.

9 kHz ~ 25 GHz Data (Modulation : $\pi/4$ DQPSK)

▪ Lowest Channel

Frequency (MHz)	ANT Pol	The worst case EUT Position (Axis)	Detector Mode	Reading (dBuV)	T.F (dB/m)	D.C.F (dB)	Distance Factor (dB)	Result (dBuV/m)	Limit (dBuV/m)	Margin (dB)
2385.34	V	Y	PK	48.56	0.68	N/A	N/A	49.24	74.00	24.76
2385.34	V	Y	AV	48.56	0.68	-24.79	N/A	24.45	54.00	29.55
4803.00	V	Y	PK	45.80	4.77	N/A	N/A	50.57	74.00	23.43
4803.00	V	Y	AV	45.80	4.77	-24.79	N/A	25.78	54.00	28.22
9606.27	V	X	PK	46.26	9.35	N/A	N/A	55.61	74.00	18.39
9606.27	V	X	AV	46.26	9.35	-24.79	N/A	30.82	54.00	23.18

▪ Middle Channel

Frequency (MHz)	ANT Pol	The worst case EUT Position (Axis)	Detector Mode	Reading (dBuV)	T.F (dB/m)	D.C.F (dB)	Distance Factor (dB)	Result (dBuV/m)	Limit (dBuV/m)	Margin (dB)
4880.71	V	Y	PK	45.36	5.10	N/A	N/A	50.46	74.00	23.54
4880.71	V	Y	AV	45.36	5.10	-24.79	N/A	25.67	54.00	28.33
7321.54	V	X	PK	47.85	7.60	N/A	N/A	55.45	74.00	18.55
7321.54	V	X	AV	47.85	7.60	-24.79	N/A	30.66	54.00	23.34

▪ Highest Channel

Frequency (MHz)	ANT Pol	The worst case EUT Position (Axis)	Detector Mode	Reading (dBuV)	T.F (dB/m)	D.C.F (dB)	Distance Factor (dB)	Result (dBuV/m)	Limit (dBuV/m)	Margin (dB)
2483.53	V	Y	PK	60.19	0.94	N/A	N/A	61.13	74.00	12.87
2483.53	V	Y	AV	60.19	0.94	-24.79	N/A	36.34	54.00	17.66
4958.57	V	Y	PK	45.51	5.34	N/A	N/A	50.85	74.00	23.15
4958.57	V	Y	AV	45.51	5.34	-24.79	N/A	26.06	54.00	27.94
7439.25	V	X	PK	47.49	7.57	N/A	N/A	55.06	74.00	18.94
7439.25	V	X	AV	47.49	7.57	-24.79	N/A	30.27	54.00	23.73

 ▪ **Note.**

1. The radiated emissions were investigated 9 kHz to 25GHz. And no other spurious and harmonic emissions were found above listed frequencies.

2. Information of Distance Factor

For finding emissions, the test distance might be reduced from 3m to 1m. In this case, the distance factor(-9.54dB) is applied to the result.

- Calculation of distance factor = $20 \log(\text{applied distance} / \text{required distance}) = 20 \log(1 \text{ m} / 3 \text{ m}) = \mathbf{-9.54 \text{ dB}}$

When distance factor is "N/A", the distance is 3 m and distance factor is not applied.

3. D.C.F Calculation. (D.C.F = Duty Cycle Correction Factor)

- Time to cycle through all channels = $\Delta t = T [\text{ms}] \times 20$ minimum hopping channels, where T = pulse width = **2.88 ms**

- $100 \text{ ms} / \Delta t [\text{ms}] = H \rightarrow$ Round up to next highest integer, to account for worst case, $H' = 100 / (2.88 \times 20) = 1.74 \approx 2$

- The Worst Case Dwell Time = $T [\text{ms}] \times H' = 2.88 \text{ ms} \times 2 = 5.76 \text{ ms}$

- D.C.F = $20 \log(\text{The Worst Case Dwell Time} / 100 \text{ ms}) \text{ dB} = 20 \log(5.76 / 100) = \mathbf{-24.79 \text{ dB}}$

4. Sample Calculation.

Margin = Limit – Result / Result = Reading + T.F + D.C.F / T.F = AF + CL – AG

Where, T.F = Total Factor, AF = Antenna Factor, CL = Cable Loss, AG = Amplifier Gain.

9 kHz ~ 25 GHz Data (Modulation : 8DPSK)
▪ Lowest Channel

Frequency (MHz)	ANT Pol	The worst case EUT Position (Axis)	Detector Mode	Reading (dBuV)	T.F (dB/m)	D.C.F (dB)	Distance Factor (dB)	Result (dBuV/m)	Limit (dBuV/m)	Margin (dB)
2385.88	V	Y	PK	49.24	0.69	N/A	N/A	49.93	74.00	24.07
2385.88	V	Y	AV	49.24	0.69	-24.79	N/A	25.14	54.00	28.86
4802.72	V	Y	PK	45.71	4.77	N/A	N/A	50.48	74.00	23.52
4802.72	V	Y	AV	45.71	4.77	-24.79	N/A	25.69	54.00	28.31
9605.90	V	X	PK	46.20	9.35	N/A	N/A	55.55	74.00	18.45
9605.90	V	X	AV	46.20	9.35	-24.79	N/A	30.76	54.00	23.24

▪ Middle Channel

Frequency (MHz)	ANT Pol	The worst case EUT Position (Axis)	Detector Mode	Reading (dBuV)	T.F (dB/m)	D.C.F (dB)	Distance Factor (dB)	Result (dBuV/m)	Limit (dBuV/m)	Margin (dB)
4881.05	V	Y	PK	46.05	5.10	N/A	N/A	51.15	74.00	22.85
4881.05	V	Y	AV	46.05	5.10	-24.79	N/A	26.36	54.00	27.64
7321.63	V	X	PK	47.53	7.60	N/A	N/A	55.13	74.00	18.87
7321.63	V	X	AV	47.53	7.60	-24.79	N/A	30.34	54.00	23.66

▪ Highest Channel

Frequency (MHz)	ANT Pol	The worst case EUT Position (Axis)	Detector Mode	Reading (dBuV)	T.F (dB/m)	D.C.F (dB)	Distance Factor (dB)	Result (dBuV/m)	Limit (dBuV/m)	Margin (dB)
2483.51	V	Y	PK	60.66	0.94	N/A	N/A	61.60	74.00	12.40
2483.51	V	Y	AV	60.66	0.94	-24.79	N/A	36.81	54.00	17.19
4958.99	V	Y	PK	45.82	5.34	N/A	N/A	51.16	74.00	22.84
4958.99	V	Y	AV	45.82	5.34	-24.79	N/A	26.37	54.00	27.63
7439.76	V	X	PK	47.04	7.57	N/A	N/A	54.61	74.00	19.39
7439.76	V	X	AV	47.04	7.57	-24.79	N/A	29.82	54.00	24.18

▪ Note.

1. The radiated emissions were investigated 9 kHz to 25GHz. And no other spurious and harmonic emissions were found above listed frequencies.

2. Information of Distance Factor

For finding emissions, the test distance might be reduced from 3m to 1m. In this case, the distance factor(-9.54dB) is applied to the result.

- Calculation of distance factor = $20 \log(\text{applied distance} / \text{required distance}) = 20 \log(1 \text{ m} / 3 \text{ m}) = -9.54 \text{ dB}$

When distance factor is "N/A", the distance is 3 m and distance factor is not applied.

3. D.C.F Calculation. (D.C.F = Duty Cycle Correction Factor)

- Time to cycle through all channels = $\Delta t = T [\text{ms}] \times 20 \text{ minimum hopping channels}$, where T = pulse width = **2.88 ms**

- $100 \text{ ms} / \Delta t [\text{ms}] = H \rightarrow$ Round up to next highest integer, to account for worst case, $H' = 100 / (2.88 \times 20) = 1.74 \approx 2$

- The Worst Case Dwell Time = $T [\text{ms}] \times H' = 2.88 \text{ ms} \times 2 = 5.76 \text{ ms}$

- D.C.F = $20 \log(\text{The Worst Case Dwell Time} / 100 \text{ ms}) \text{ dB} = 20 \log(5.76 / 100) = -24.79 \text{ dB}$

4. Sample Calculation.

Margin = Limit – Result / Result = Reading + T.F + D.C.F / T.F = AF + CL – AG

Where, T.F = Total Factor, AF = Antenna Factor, CL = Cable Loss, AG = Amplifier Gain.

7.4.2. Conducted Spurious Emissions

Low Band-edge

Lowest Channel & Modulation : GFSK

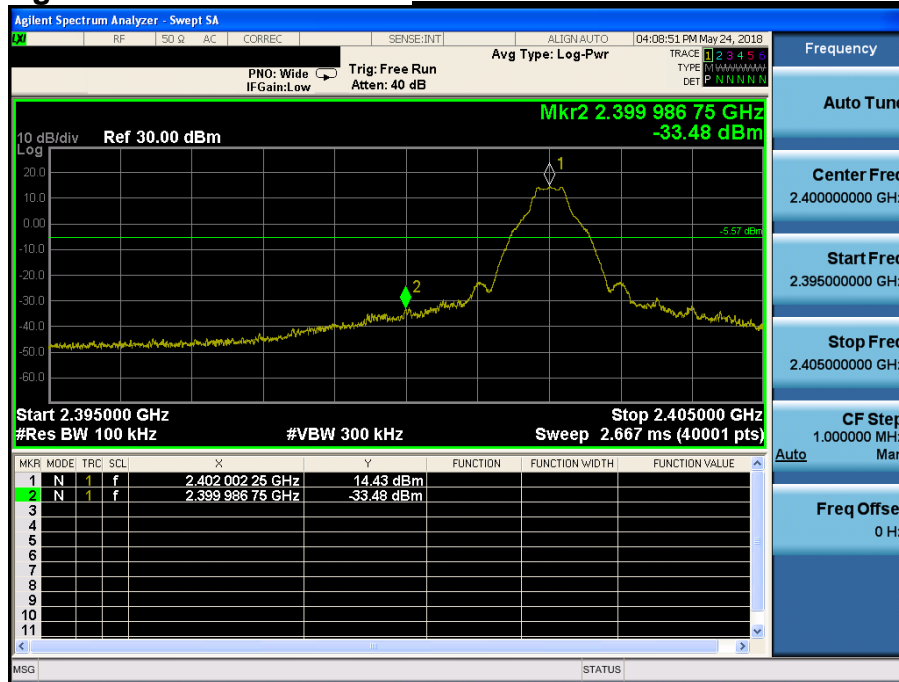

Low Band-edge

Hopping mode & Modulation : GFSK



Conducted Spurious Emissions **Lowest Channel & Modulation : GFSK**

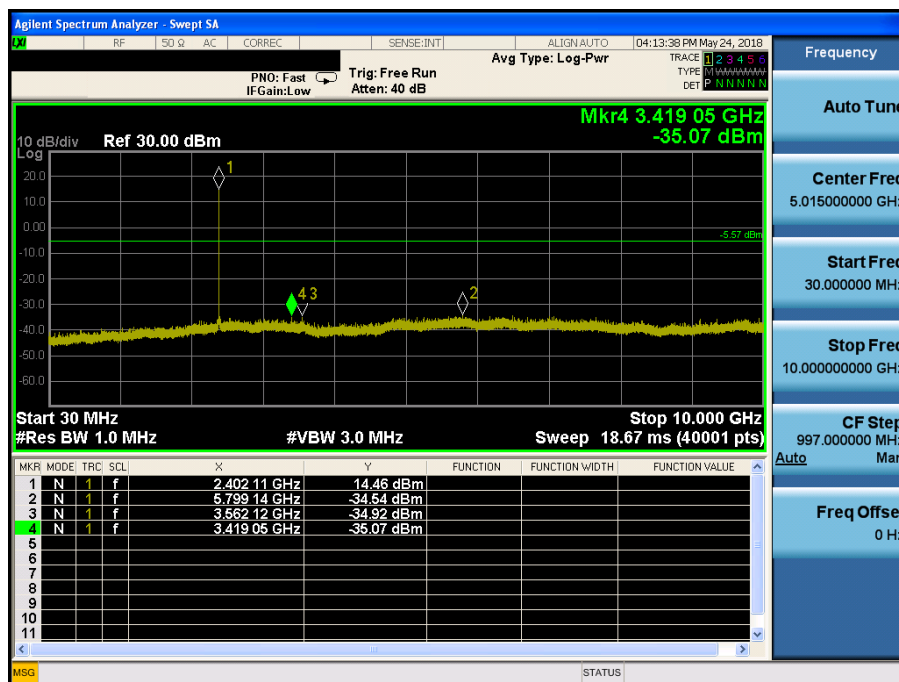
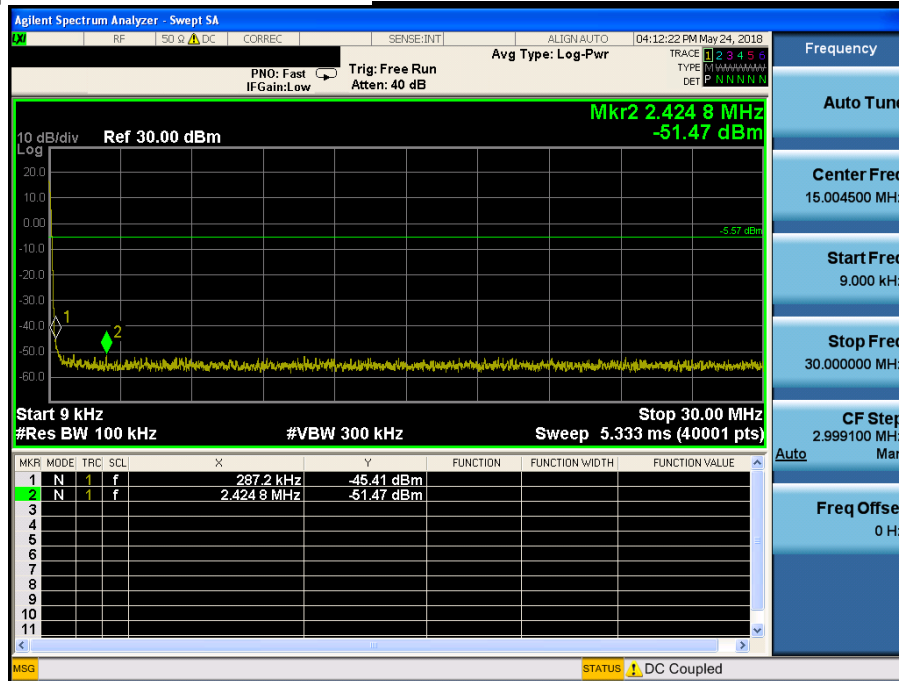

Conducted Spurious Emissions **Lowest Channel & Modulation : GFSK**



Reference for limit

Middle Channel & Modulation : GFSK

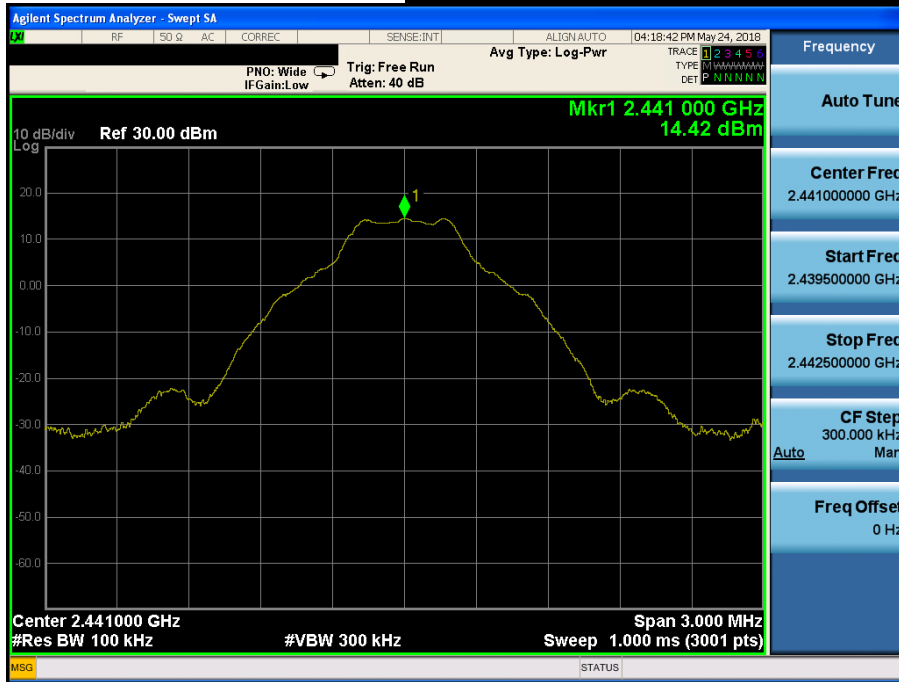

Conducted Spurious Emissions

Middle Channel & Modulation : GFSK

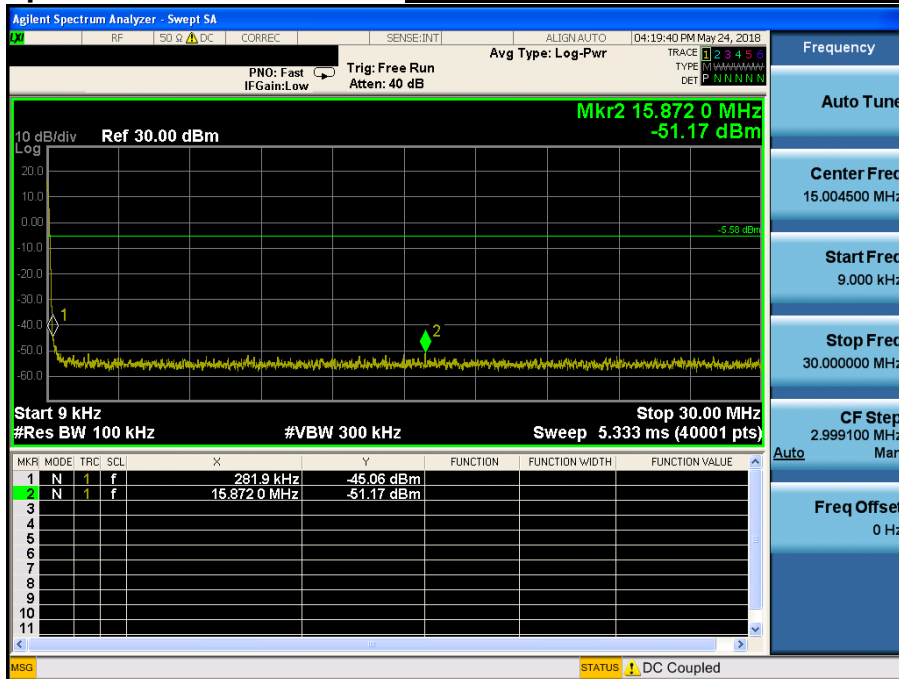

Conducted Spurious Emissions *Middle Channel & Modulation : GFSK*

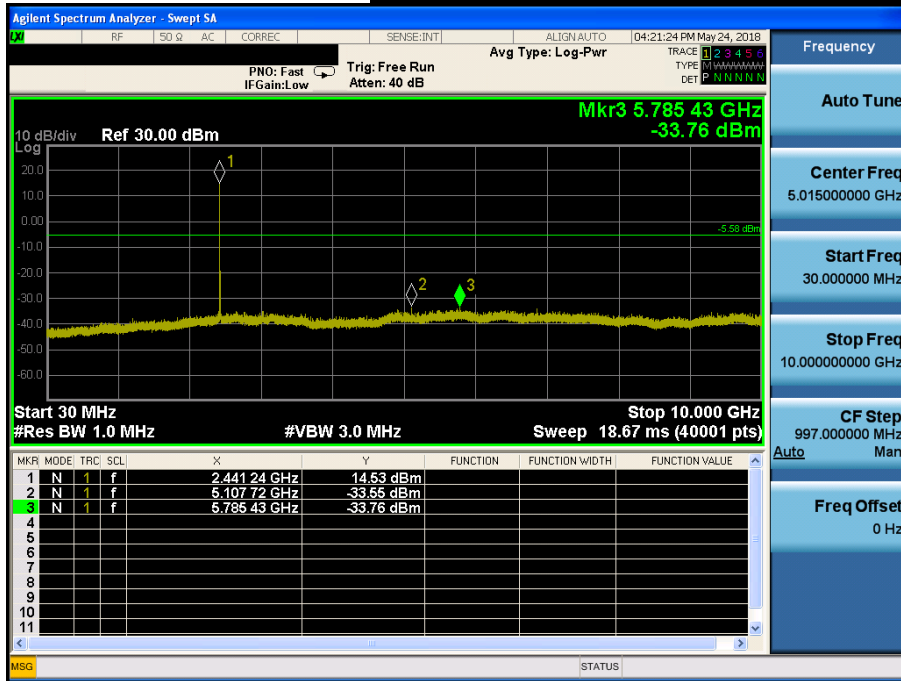

High Band-edge

Highest Channel & Modulation : GFSK

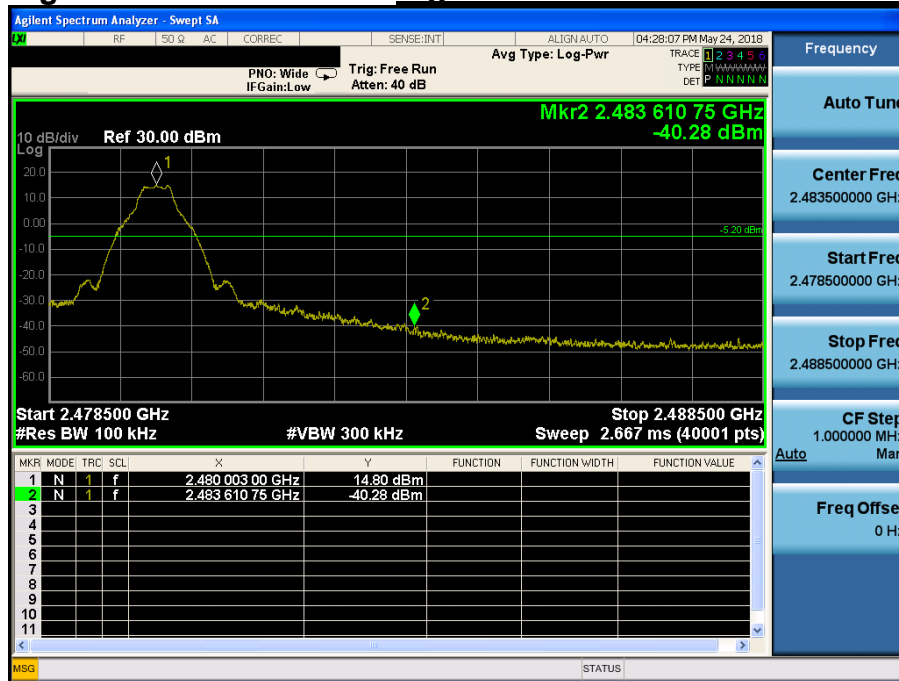

High Band-edge

Hopping mode & Modulation : GFSK

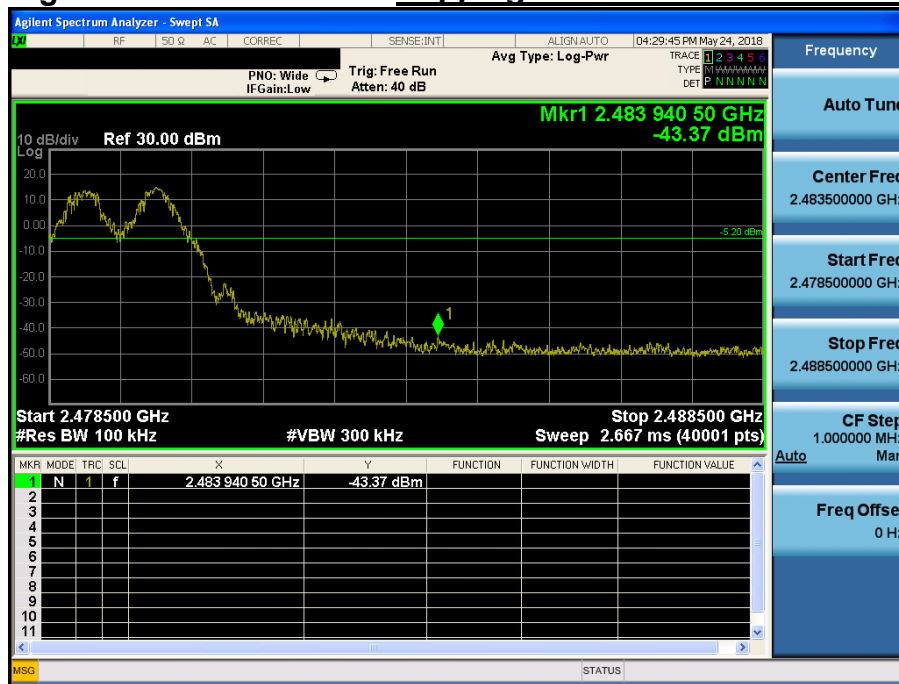

Conducted Spurious Emissions **Highest Channel & Modulation : GFSK**

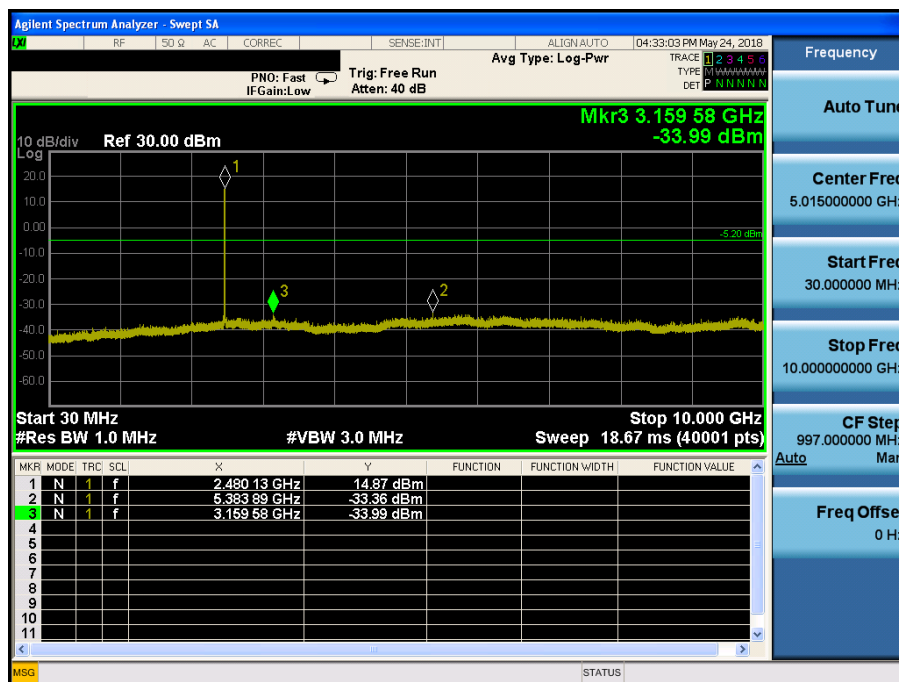
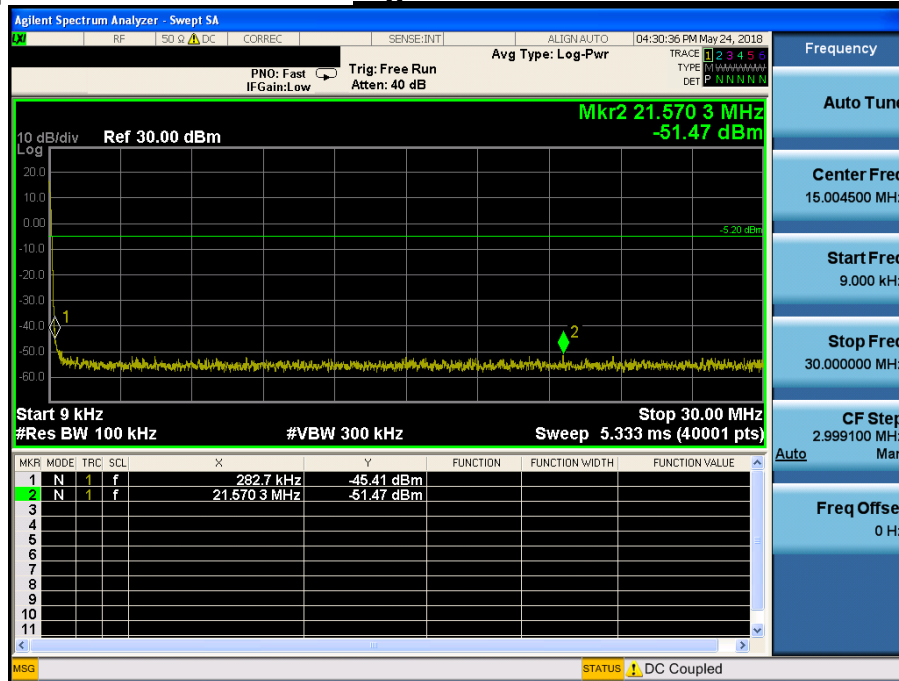

Conducted Spurious Emissions **Highest Channel & Modulation : GFSK**



Low Band-edge

Lowest Channel & Modulation : $\pi/4$ DQPSK



Low Band-edge

Hopping mode & Modulation : $\pi/4$ DQPSK



Conducted Spurious Emissions **Lowest Channel & Modulation : $\pi/4$ DQPSK**

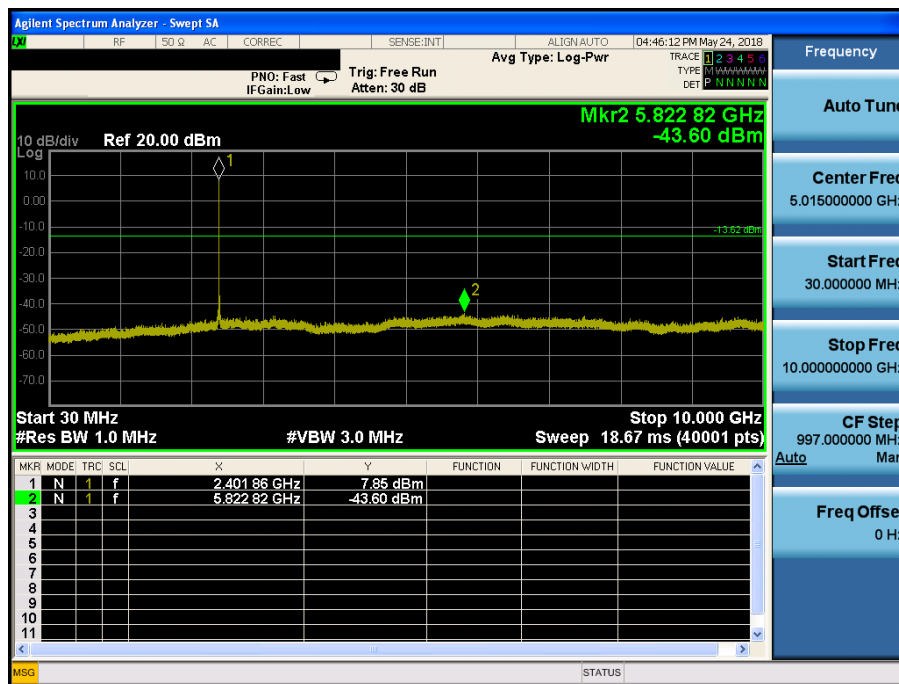
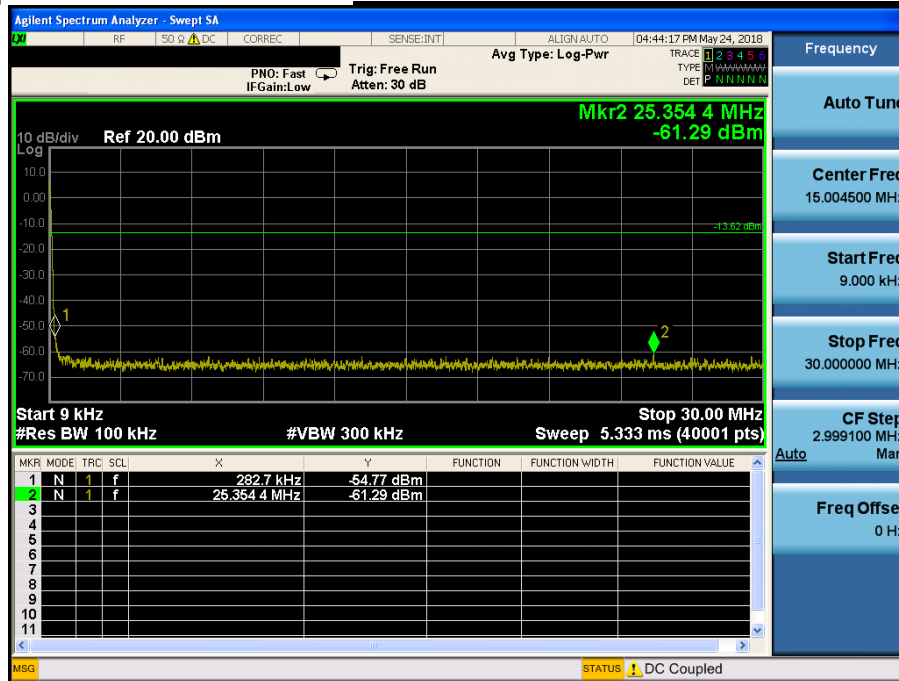

Conducted Spurious Emissions **Lowest Channel & Modulation : $\pi/4$ DQPSK**



Reference for limit

Middle Channel & Modulation : $\pi/4$ DQPSK

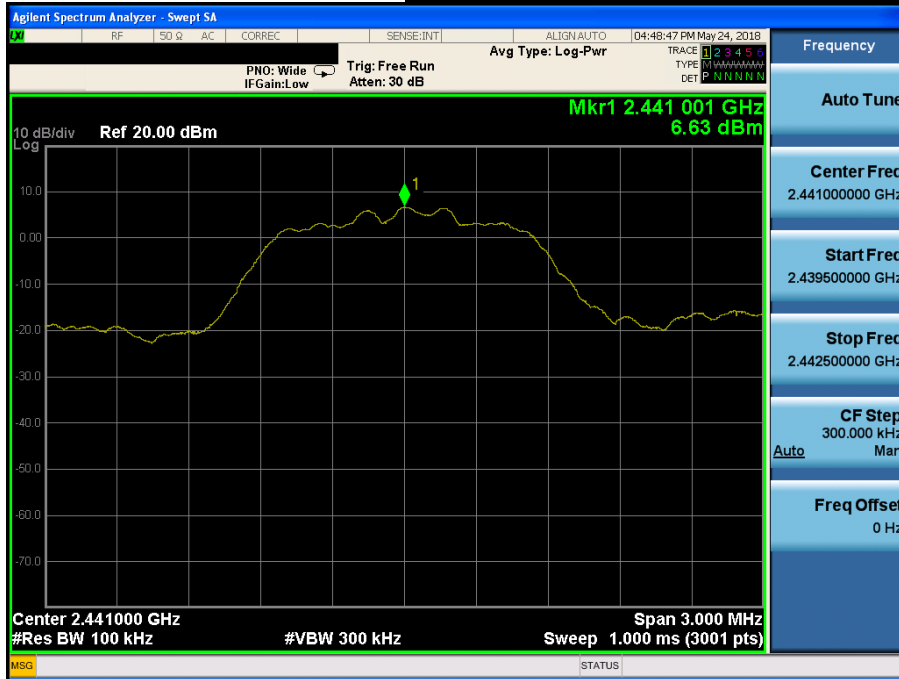

Conducted Spurious Emissions

Middle Channel & Modulation : $\pi/4$ DQPSK

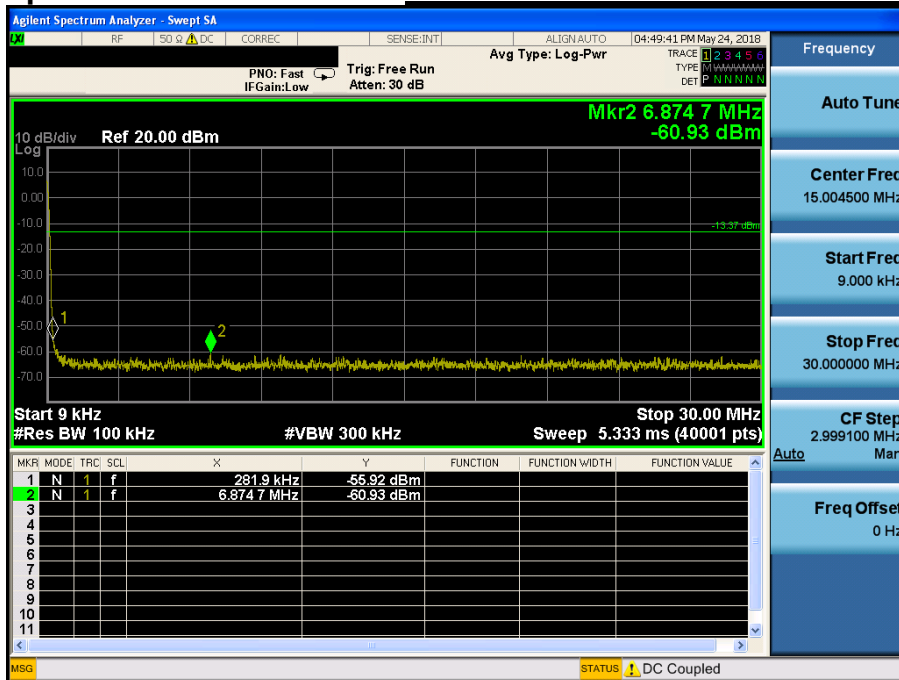

Conducted Spurious Emissions *Middle Channel & Modulation : $\pi/4$ DQPSK*

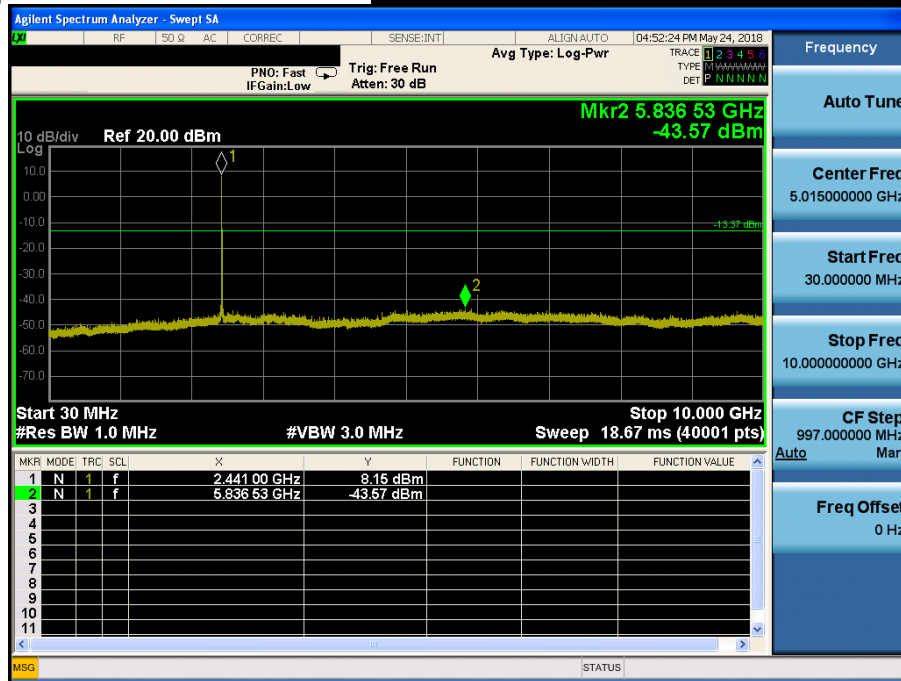

High Band-edge

Highest Channel & Modulation : $\pi/4$ DQPSK



High Band-edge

Hopping mode & Modulation : $\pi/4$ DQPSK



Conducted Spurious Emissions *Highest Channel & Modulation : $\pi/4$ DQPSK*

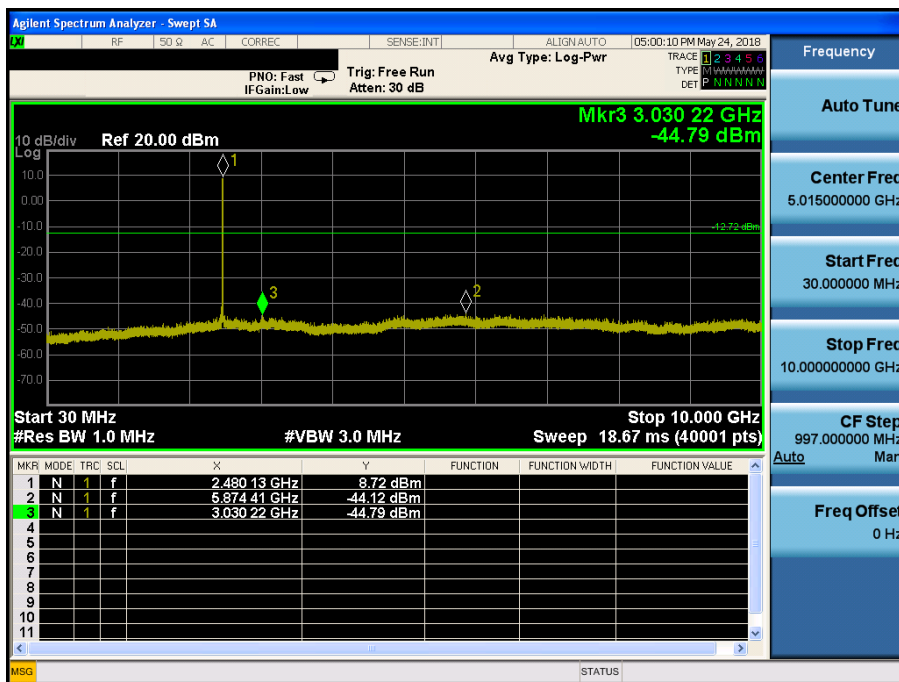
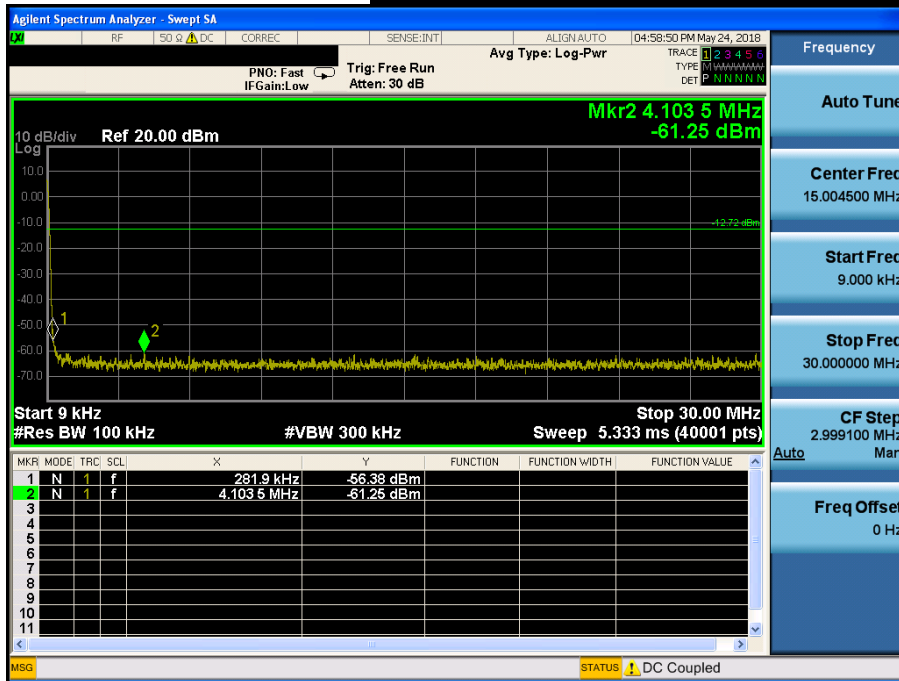

Conducted Spurious Emissions **Highest Channel & Modulation : $\pi/4$ DQPSK**



Low Band-edge

Lowest Channel & Modulation : 8DPSK



Low Band-edge

Hopping mode & Modulation : 8DPSK

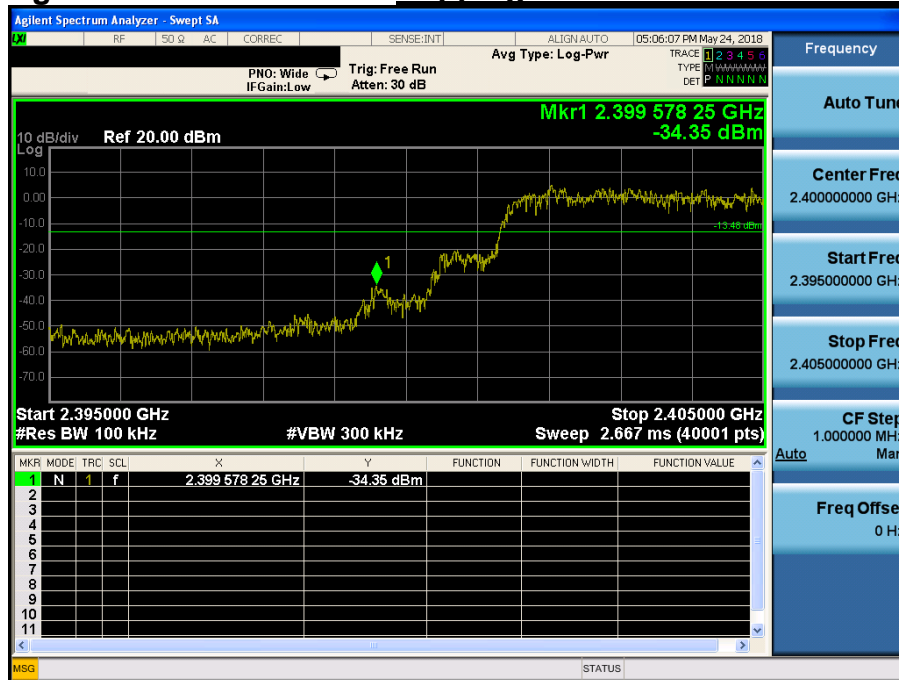

Conducted Spurious Emissions *Lowest Channel & Modulation : 8DPSK*

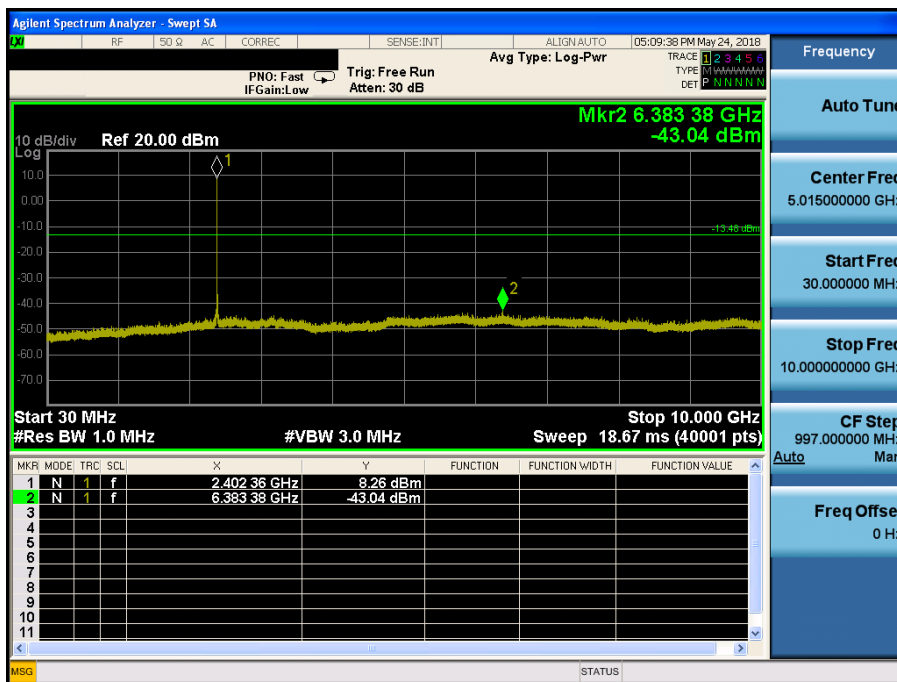
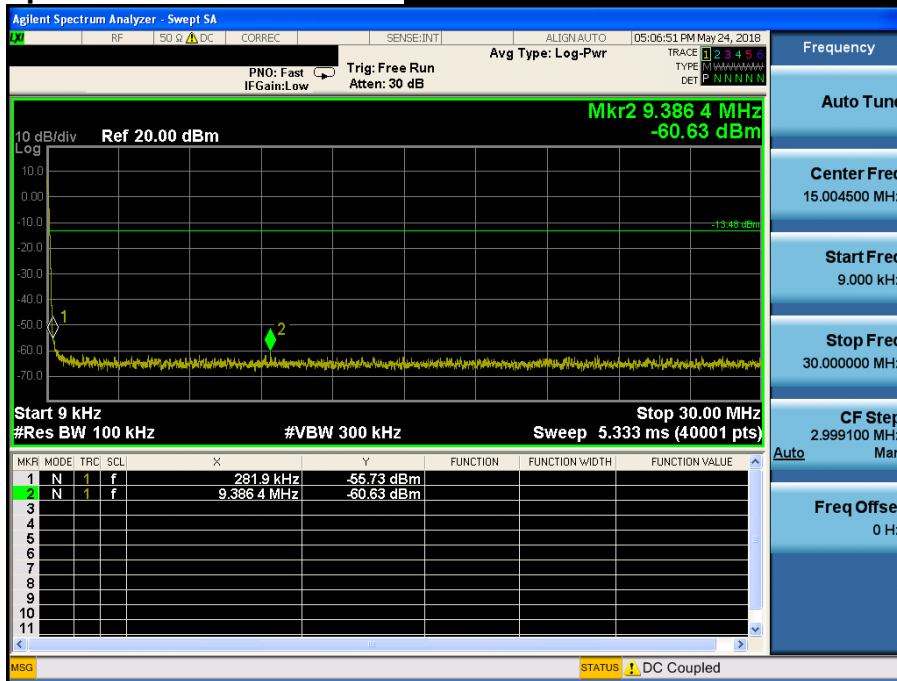

Conducted Spurious Emissions ***Lowest Channel & Modulation : 8DPSK***

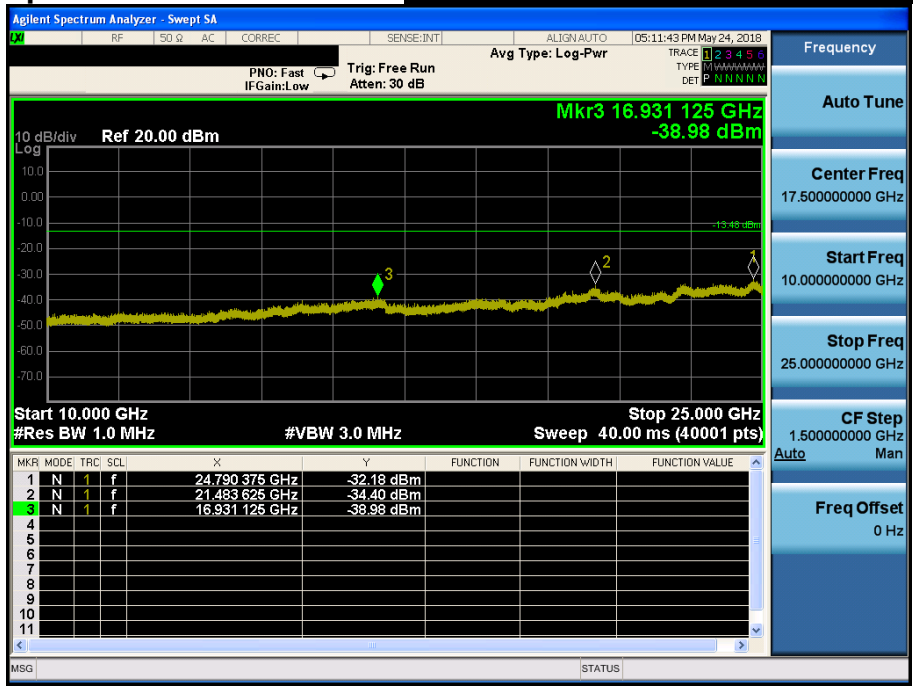

Reference for limit

Middle Channel & Modulation : 8DPSK

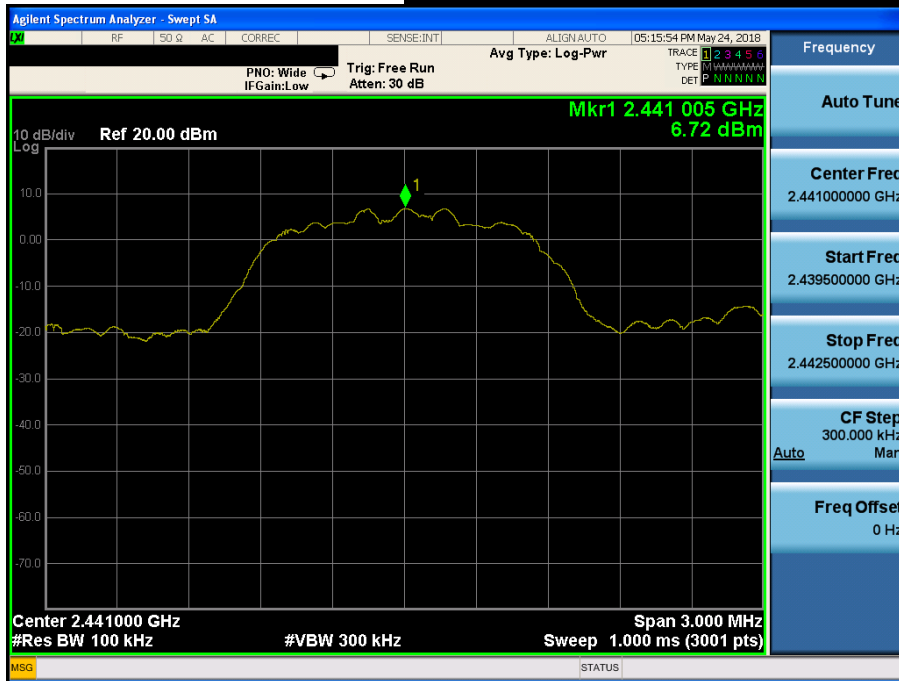

Conducted Spurious Emissions

Middle Channel & Modulation : 8DPSK

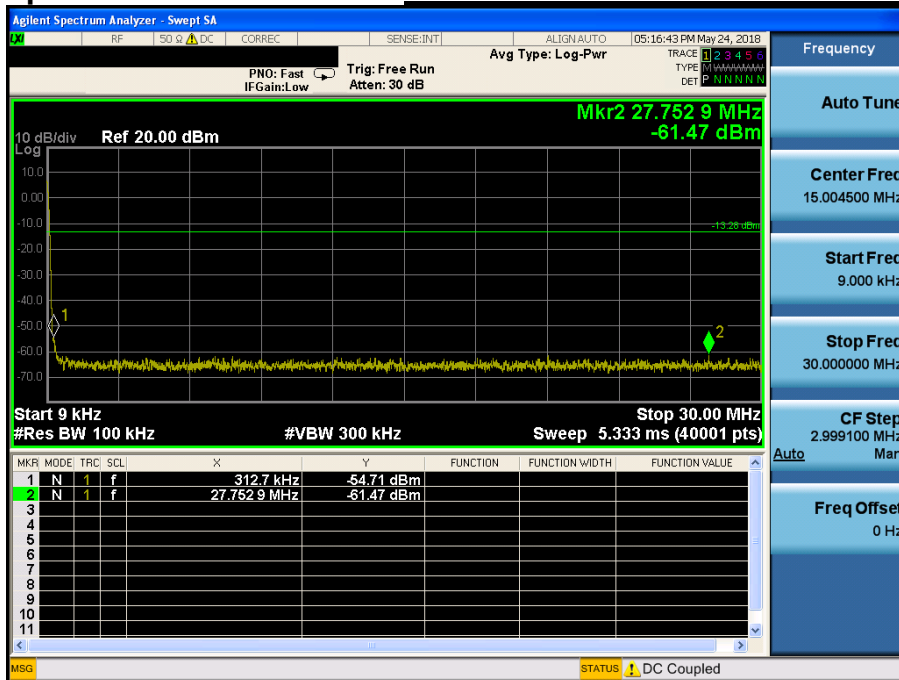

Conducted Spurious Emissions *Middle Channel & Modulation : 8DPSK*

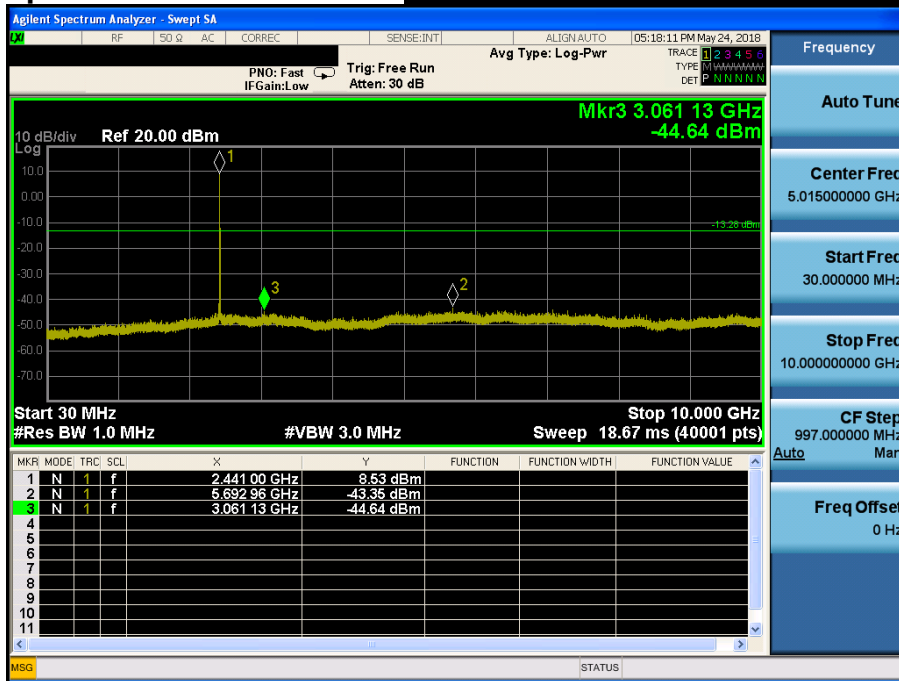

High Band-edge

Highest Channel & Modulation : 8DPSK



High Band-edge

Hopping mode & Modulation : 8DPSK



Conducted Spurious Emissions *Highest Channel & Modulation : 8DPSK*

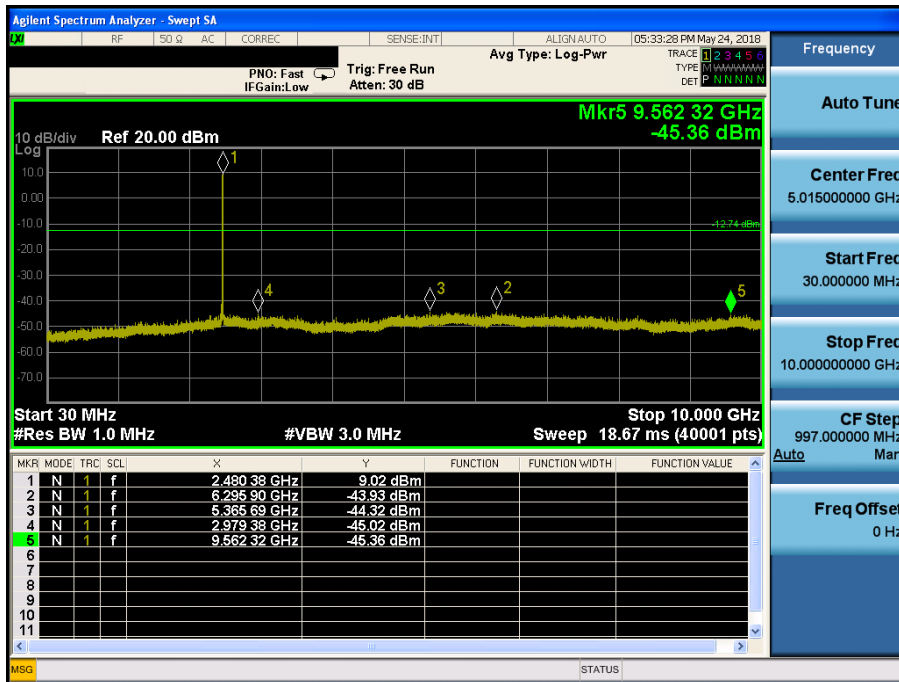
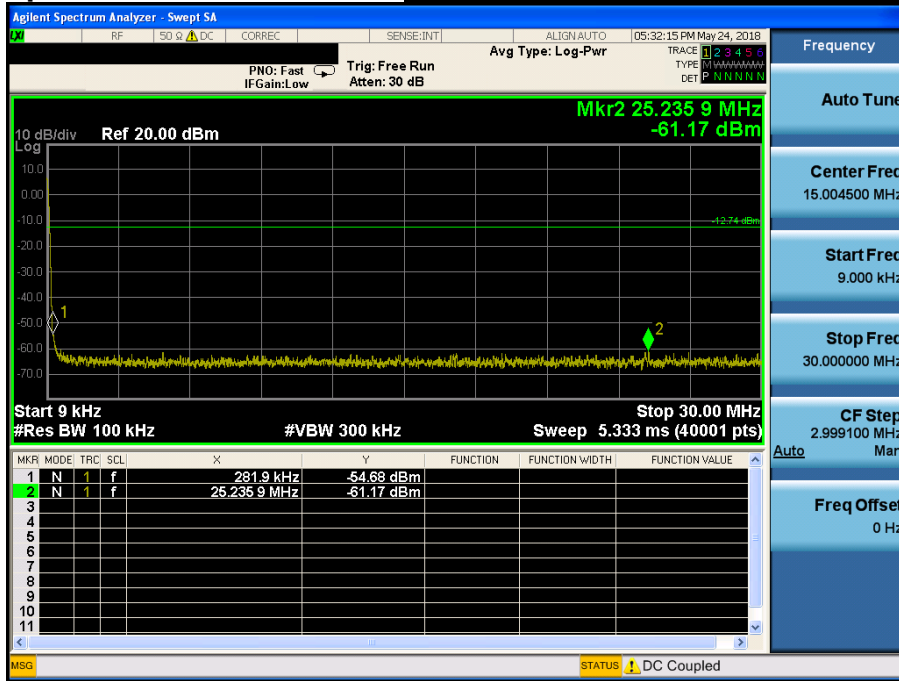

Conducted Spurious Emissions *Highest Channel & Modulation : 8DPSK*



8. Transmitter AC Power Line Conducted Emission

8.1 Test Setup

See test photographs for the actual connections between EUT and support equipment.

8.2 Limit

According to §15.207(a) for an intentional radiator that is designed to be connected to the public utility (AC) power line, the radio frequency voltage that is conducted back onto the AC power line on any frequency or frequencies, within the band 150 kHz to 30 MHz, shall not exceed the limits in the following table, as measured using a 50 uH/50 ohm line impedance stabilization network (LISN).

Compliance with the provision of this paragraph shall on the measurement of the radio frequency voltage between each power line and ground at the power terminal. The lower applies at the boundary between the frequency ranges.

Frequency Range (MHz)	Conducted Limit (dBuV)	
	Quasi-Peak	Average
0.15 ~ 0.5	66 to 56 *	56 to 46 *
0.5 ~ 5	56	46
5 ~ 30	60	50

* Decreases with the logarithm of the frequency

8.3 Test Procedures

Conducted emissions from the EUT were measured according to the ANSI C63.10.

1. The test procedure is performed in a 6.5 m × 3.5 m × 3.5 m (L × W × H) shielded room. The EUT along with its peripherals were placed on a 1.0 m (W) × 1.5 m (L) and 0.8 m in height wooden table and the EUT was adjusted to maintain a 0.4 meter space from a vertical reference plane.
2. The EUT was connected to power mains through a line impedance stabilization network (LISN) which provides 50 ohm coupling impedance for measuring instrument and the chassis ground was bounded to the horizontal ground plane of shielded room.
3. All peripherals were connected to the second LISN and the chassis ground also bounded to the horizontal ground plane of shielded room.
4. The excess power cable between the EUT and the LISN was bundled. The power cables of peripherals were unbundled. All connecting cables of EUT and peripherals were moved to find the maximum emission.

8.4 Test Results

AC Line Conducted Emissions (Graph) = Modulation : GFSK

Results of Conducted Emission

DTNC

Date 2018-05-25

Order No.
Model No. B601R
Serial No.
Test Condition BT

Reference No.
Power Supply 120V 60Hz
Temp/Humi. 22°C 44% R.H.
Operator

Memo

LIMIT : FCC P15.207 QP
FCC P15.207 AV

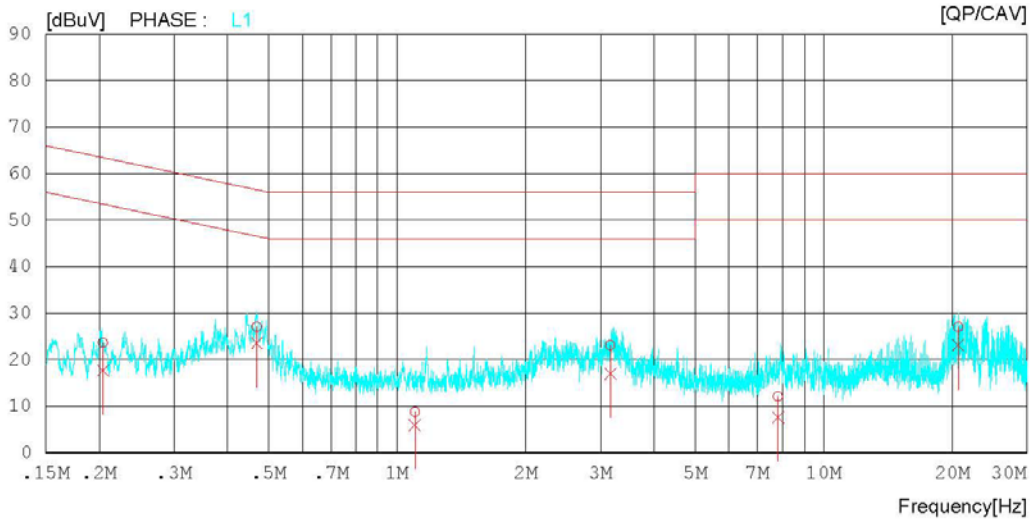
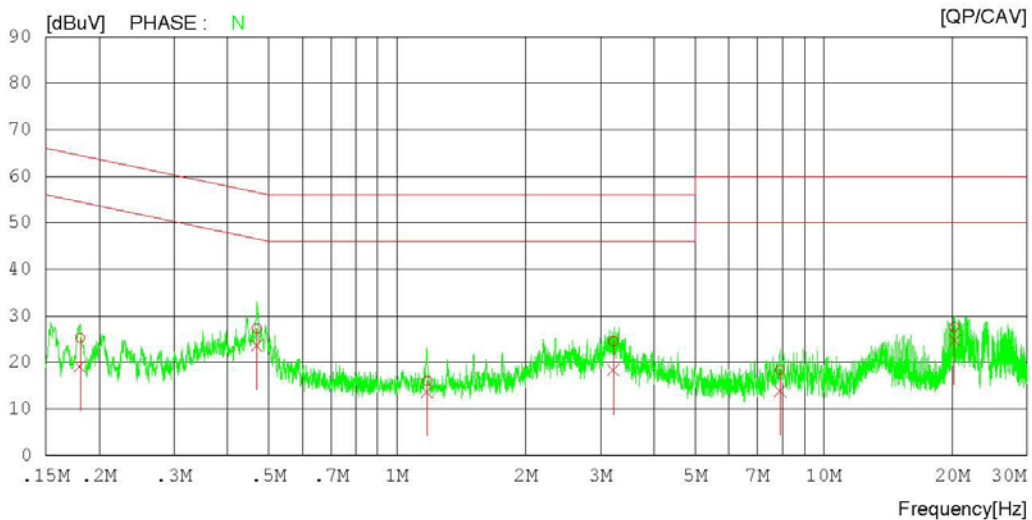

AC Line Conducted Emissions (List) = Modulation : GFSK

Results of Conducted Emission

DTNC

Date 2018-05-25

Order No.		Reference No.	
Model No.	B601R	Power Supply	120V 60Hz
Serial No.		Temp/Humi.	22°C 44% R.H.
Test Condition	BT	Operator	

Memo

 LIMIT : FCC P15.207 QP
 FCC P15.207 AV

NO	FREQ [MHz]	READING		C. FACTOR [dB]	RESULT		LIMIT		MARGIN		PHASE
		QP [dBuV]	CAV [dBuV]		QP [dBuV]	CAV [dBuV]	QP [dBuV]	CAV [dBuV]	QP [dBuV]	CAV [dBuV]	
1	0.18048	15.28	9.17	9.98	25.26	19.15	64.46	54.46	39.20	35.31	N
2	0.46887	17.26	13.54	10.00	27.26	23.54	56.53	46.53	29.27	22.99	N
3	1.17480	5.99	3.61	10.01	16.00	13.62	56.00	46.00	40.00	32.38	N
4	3.21040	14.48	8.27	10.07	24.55	18.34	56.00	46.00	31.45	27.66	N
5	7.90540	8.17	3.60	10.19	18.36	13.79	60.00	50.00	41.64	36.21	N
6	20.24600	17.11	14.26	10.42	27.53	24.68	60.00	50.00	32.47	25.32	N
7	0.20445	13.57	7.71	9.96	23.53	17.67	63.43	53.43	39.90	35.76	L1
8	0.46870	17.00	13.57	10.00	27.00	23.57	56.54	46.54	29.54	22.97	L1
9	1.10020	-1.26	-4.17	10.01	8.75	5.84	56.00	46.00	47.25	40.16	L1
10	3.16160	12.95	6.91	10.07	23.02	16.98	56.00	46.00	32.98	29.02	L1
11	7.82060	1.85	-2.59	10.19	12.04	7.60	60.00	50.00	47.96	42.40	L1
12	20.68680	16.52	12.68	10.43	26.95	23.11	60.00	50.00	33.05	26.89	L1

9. Antenna Requirement

Describe how the EUT complies with the requirement that either its antenna is permanently attached, or that it employs a unique antenna connector, for every antenna proposed for use with the EUT.

Conclusion: Comply

**The internal type antenna of EUT is permanently attached on the board. (Refer to Internal Photo file.)
Therefore this E.U.T Complies with the requirement of §15.203**

- Minimum Standard :

An intentional radiator shall be designed to ensure that no antenna other than that furnished by the responsible party shall be used with the device. The use of a permanently attached antenna or of an antenna that uses a unique coupling to the intentional radiator shall be considered sufficient to comply with the provisions.

APPENDIX I

Test set up diagrams

▪ Radiated Measurement

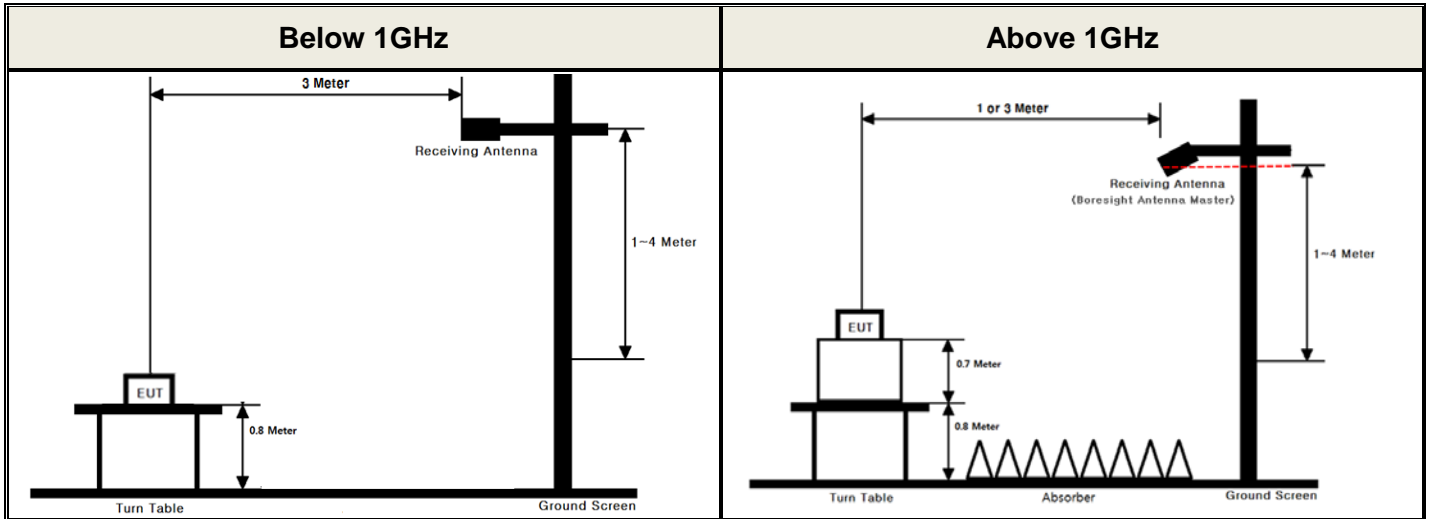

▪ Conducted Measurement

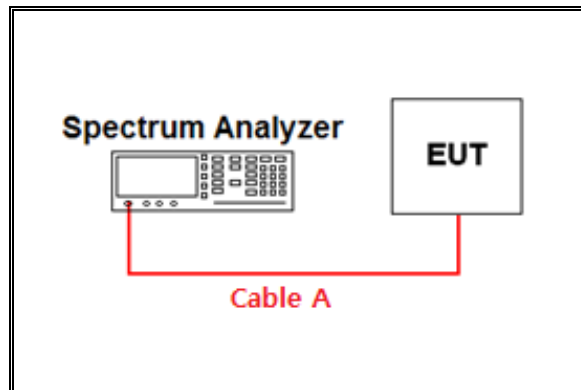

Path loss information

Frequency (GHz)	Path Loss (dB)	Frequency (GHz)	Path Loss (dB)
0.03	0.61	15	3.37
1	0.97	20	4.02
2.402 & 2.441 & 2.480	1.48	25	4.30
5	1.95	-	-
10	2.70	-	-

Note 1 : The path loss from EUT to Spectrum analyzer were measured and used for test.

Path loss (S/A's Correction factor) = Cable A

APPENDIX II

Unwanted Emissions (Radiated) Test Plot

GFSK & Lowest & Z & Hor

Detector Mode : PK

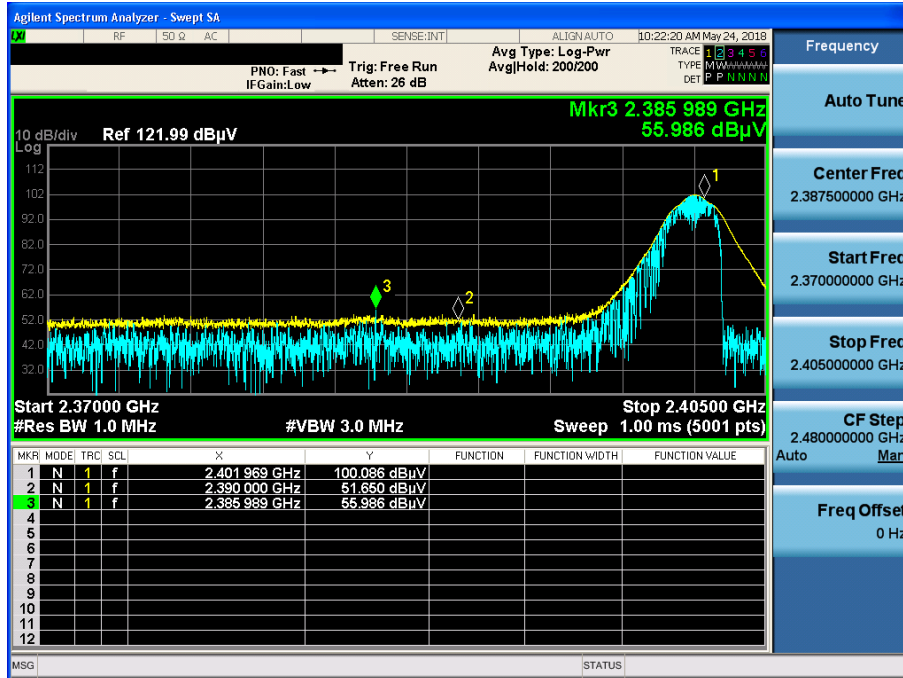

GFSK & Highest & Z & Hor

Detector Mode : PK

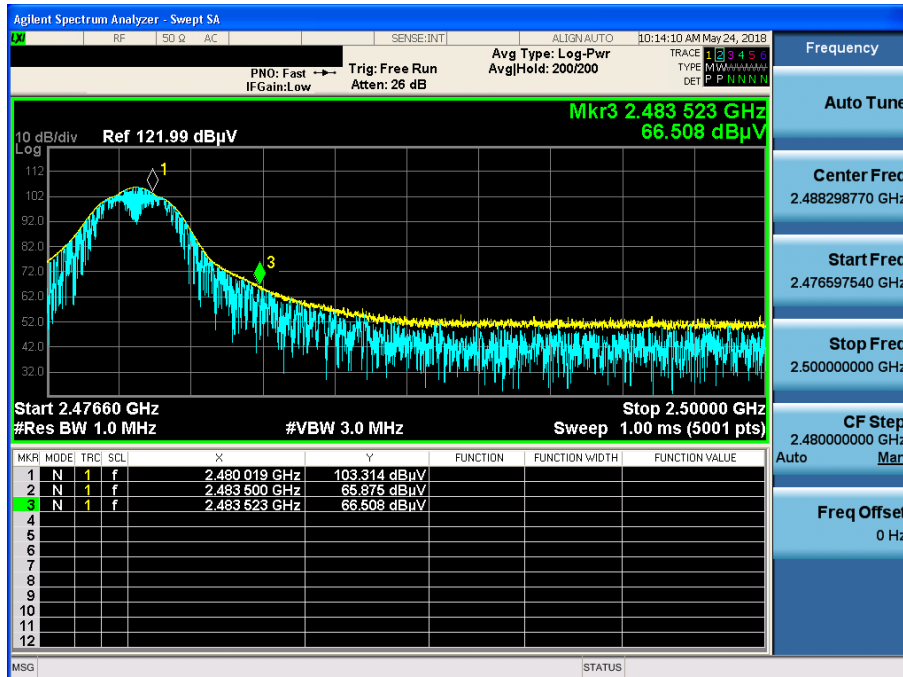

π /4DQPSK & Lowest & Y & Ver

Detector Mode : PK

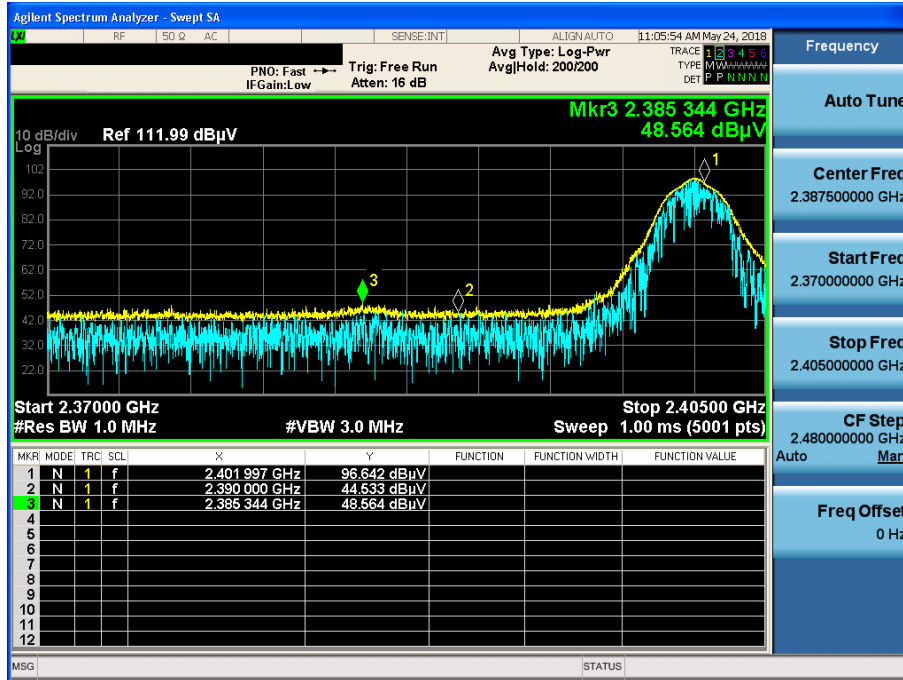

π /4DQPSK & Highest & Y & Ver

Detector Mode : PK

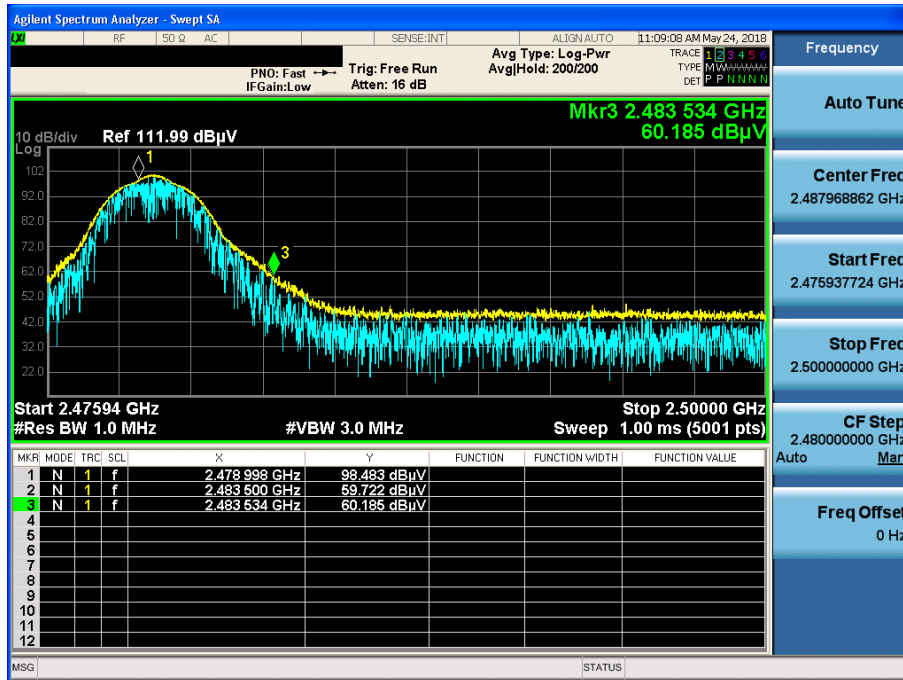

8DPSK & Lowest & Y & Ver

Detector Mode : PK

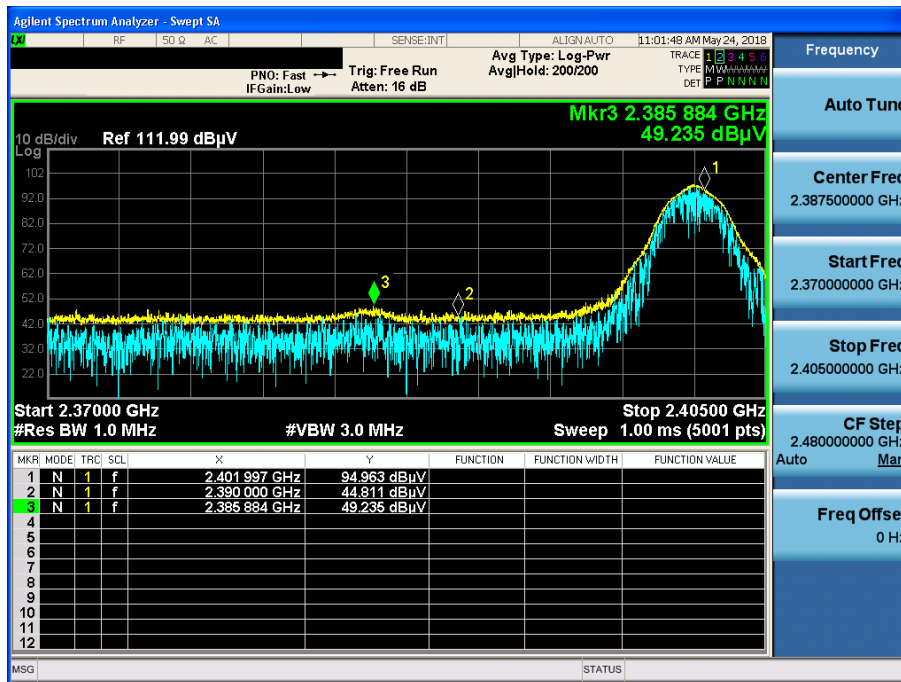

8DPSK & Highest & Y & Ver

Detector Mode : PK

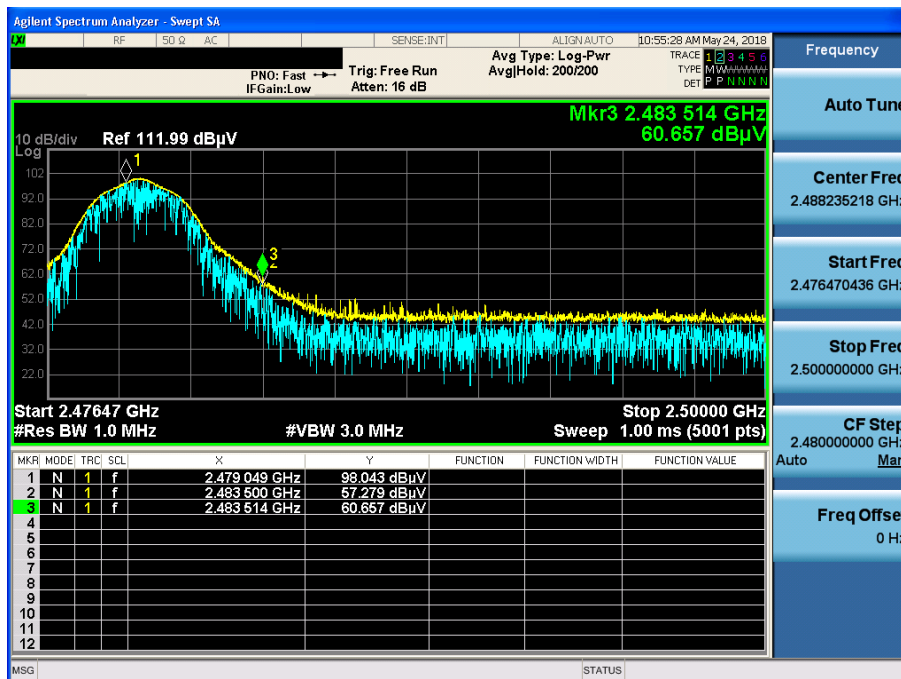

GFSK & Middle & Y & Hor

Detector Mode : PK

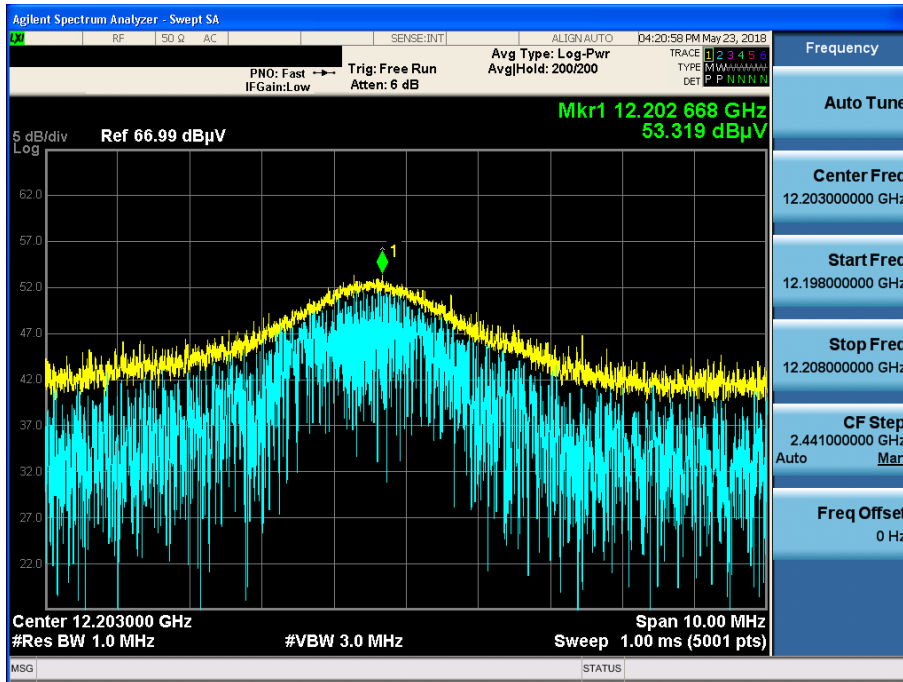

$\pi/4$ DQPSK & Lowest & X & Ver

Detector Mode : PK

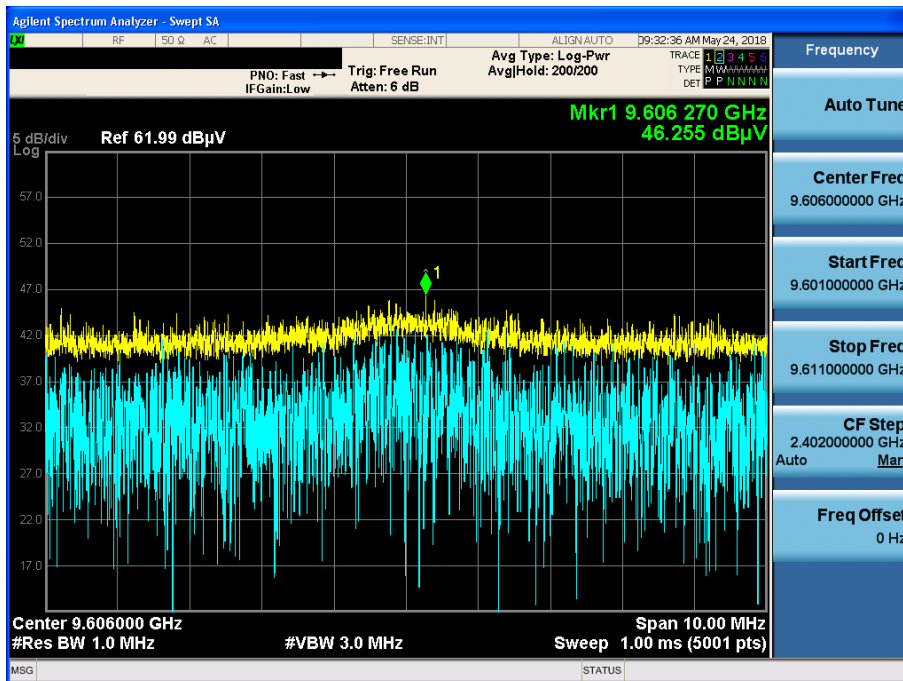

8DPSK & Lowest & X & Ver

Detector Mode : PK

