

Gstar Technology Ltd.

Wifi Modular

Model: MR100

13 January 2011

Report No.: 10021272
(This report supersedes NONE)



Modifications made to the product : None

This Test Report is Issued Under the Authority of:

| | |
|---|--|
|  |  |
| Alex Wang Compliance Engineer | Spring Zhou Director of Certification |

This test report may be reproduced in full only.
Test result presented in this test report is applicable to the representative sample only.

RF Test Report

SIEMIC, INC.
Assessing global markets

TO: FCC 15.247:2009

Laboratory Introduction

SIEMIC, headquartered in the heart of Silicon Valley, with superior facilities in US and Asia, is one of the leading independent testing and certification facilities providing customers with one-stop shop services for Compliance Testing and Global Certifications.



In addition to [testing](#) and [certification](#), SIEMIC provides initial design reviews and [compliance management](#) through out a project. Our extensive experience with [China](#), [Asia Pacific](#), [North America](#), [European](#), and [international](#) compliance requirements, assures the fastest, most cost effective way to attain regulatory compliance for the [global markets](#).

Accreditations for Conformity Assessment

| Country/Region | Accreditation Body | Scope |
|----------------|------------------------|------------------------------------|
| USA | FCC, A2LA | EMC , RF/Wireless , Telecom |
| Canada | IC, A2LA, NIST | EMC, RF/Wireless , Telecom |
| Taiwan | BSMI , NCC , NIST | EMC, RF, Telecom , Safety |
| Hong Kong | OFTA , NIST | RF/Wireless ,Telecom |
| Australia | NATA, NIST | EMC, RF, Telecom , Safety |
| Korea | KCC/RRA, NIST | EMI, EMS, RF , Telecom, Safety |
| Japan | VCCI, JATE, TELEC, RFT | EMI, RF/Wireless, Telecom |
| Mexico | NOM, COFETEL, Caniety | Safety, EMC , RF/Wireless, Telecom |
| Europe | A2LA, NIST | EMC, RF, Telecom , Safety |

Accreditations for Product Certifications

| Country | Accreditation Body | Scope |
|-----------|--------------------|--------------------|
| USA | FCC TCB, NIST | EMC , RF , Telecom |
| Canada | IC FCB , NIST | EMC , RF , Telecom |
| Singapore | iDA, NIST | EMC , RF , Telecom |



SIEMIC, INC.

Accessing global markets

Title: RF Test Report for Wifi Modular
Model: MR100
To: FCC 15.247:2009

Serial#: 10021272
Issue Date: 13 January 2011
Page: 3 of 113
www.siemac.com.cn

This page has been left blank intentionally.

CONTENTS

1 EXECUTIVE SUMMARY & EUT INFORMATION5

2 TECHNICAL DETAILS6

3 MODIFICATION7

4 TEST SUMMARY8

5 MEASUREMENTS, EXAMINATION AND DERIVED RESULTS9

ANNEX A. TEST INSTRUMENT & METHOD80

ANNEX B. EUT AND TEST SETUP PHOTOGRAPHS.....84

ANNEX C. TEST SETUP AND SUPPORTING EQUIPMENT.....85

ANNEX D. USER MANUAL / BLOCK DIAGRAM / SCHEMATICS / PART LIST89

ANNEX E. SIEMIC ACCREDITATION CERTIFICATES.....错误! 未定义书签。

1 Executive Summary & EUT information

The purpose of this test programme was to demonstrate compliance of the Gstar Technology Ltd. Wifi Modular , and model MR100 against the current Stipulated Standards. The Wifi Modular has demonstrated compliance with the FCC 15.247:2009.

EUT Information

EUT : Wifi Modular
Description
Model No : MR100
Serial No : N/A
Input Power : DC 12V/1A
Classification
Per Stipulated : Spread Spectrum System/Device
Test Standard



SIEMIC, Inc.

Accessing global markets

Title: RF Test Report for Wifi Modular
Model: MR100
To: FCC 15.247:2009

Serial#: 10021272
Issue Date: 13 January 2011
Page: 6 of 113
www.siemec.com.cn

2 TECHNICAL DETAILS

| | |
|---------------------------------|--|
| Purpose | Compliance testing of System on Module with stipulated standard |
| Applicant / Client | Gstar Technology Ltd. Wangjing222# Bilding B, Room1302, BeiJing, China |
| Manufacturer | Leading International Co.,Limited 10/F Xinghua Bldg A, Shennan M.Rd.,NO.2018,Shenzhen China |
| Laboratory performing the tests | SIEMIC Nanjing (China) Laboratories NO.2-1,Longcang Dadao, Yuhua Economic Development Zone, Nanjing, China Tel:+86(25)86730128/86730129 Fax:+86(25)86730127 Email:info@siemic.com |
| Test report reference number | 10021272 |
| Date EUT received | December 24 2010 |
| Standard applied | FCC 15.247:2009 |
| Dates of test (from – to) | January 7-12 January 2011 |
| No of Units: | #1 |
| Equipment Category: | DTS |
| Trade Name: | N/A |
| Model : | MR100 |
| RF Operating Frequency (ies) | 2412MHz-2462MHz |
| Number of Channels : | 11 |
| Modulation : | 802.11b/g/n |
| FCC ID: | Y4RMR100 |



SIEMIC, Inc.
Accessing global markets

Title: RF Test Report for Wifi Modular
Model: MR100
To: FCC 15.247:2009

Serial#: 10021272
Issue Date: 13 January 2011
Page: 7 of 113
www.siemec.com.cn

3 MODIFICATION

NONE

4 TEST SUMMARY

The product was tested in accordance with the following specifications.
All testing has been performed according to below product classification:

Spread Spectrum System/Device

Test Results Summary

| Test Standard | Description | Pass / Fail |
|--------------------------|----------------------------------|-------------|
| CFR 47 Part 15.247: 2009 | | |
| 15.203 | Antenna Requirement | Pass |
| 15.205 | Restricted Band of Operation | Pass |
| 15.207(a) | Conducted Emissions Voltage | Pass |
| 15.247(a)(1) | Channel Separation | N/A |
| 15.247(a)(1) | Occupied Bandwidth | Pass |
| 15.247(a)(2) | 6dB Bandwidth | Pass |
| 15.247(a)(1) | Number of Hopping Channels | N/A |
| 15.247(a)(1) | Time of Occupancy | N/A |
| 15.247(b) | Output Power | Pass |
| 15.247(c) | Antenna Gain > 6 dBi | Pass |
| 15.247(d) | Conducted Spurious Emissions | Pass |
| 15.209; 15.247(d) | Radiated Spurious Emissions | Pass |
| 15.247(e) | Power Spectral Density | Pass |
| 15.247(f) | Hybrid System Requirement | N/A |
| 15.247(g) | Hopping Capability | N/A |
| 15.247(h) | Hopping Coordination Requirement | N/A |
| 15.247(i) | RF Exposure requirement | Pass |

ANSI C63.4: 2009

PS: All measurement uncertainties are not taken into consideration for all presented test result.

5 MEASUREMENTS, EXAMINATION AND DERIVED RESULTS

5.1 Antenna Requirement

Requirement(s): 47 CFR §15.203

An intentional radiator shall be designed to ensure that no antenna other than that furnished by the responsible party shall be used with the device.

Antenna requirement must meet at least one of the following:

- a) Antenna must be permanently attached to the device.
- b) Antenna must use a unique type of connector to attach to the device.
- c) Device must be professionally installed. Installer shall be responsible for ensuring that the correct antenna is employed with the device.

The EUT antenna is using a unique type of connector., which meet the standard.

5.2 Conducted Emissions Voltage

Requirement:

| Frequency of emission (MHz) | Conducted limit (dBμV) | |
|-----------------------------|------------------------|-----------|
| | Quasi-peak | Average |
| 0.15–0.5 | 66 to 56* | 56 to 46* |
| 0.5–5 | 56 | 46 |
| 5–30 | 60 | 50 |

*Decreases with the logarithm of the frequency.

Procedures:

1. All possible modes of operation were investigated. Only the 6 worst case emissions measured, using the correct CISPR and Average detectors, are reported. All other emissions were relatively insignificant.
2. A "-ve" margin indicates a PASS as it refers to the margin present below the limit line at the particular frequency.
3. Conducted Emissions Measurement Uncertainty
All test measurements carried out are traceable to national standards. The uncertainty of the measurement at a confidence level of approximately 95% (in the case where distributions are normal), with a coverage factor of 2, in the range 9kHz – 30MHz (Average & Quasi-peak) is ±3.5dB.
4.

| | | |
|--------------------------|----------------------|----------|
| Environmental Conditions | Temperature | 16°C |
| | Relative Humidity | 50% |
| | Atmospheric Pressure | 1019mbar |
5. Test date : January 7~12 January 2011
Tested By : Alex Wang

Operating mode: Normal Working-Line

Peak Detector  **Quasi Peak Limit** 
Average Detector  **Average Limit** 

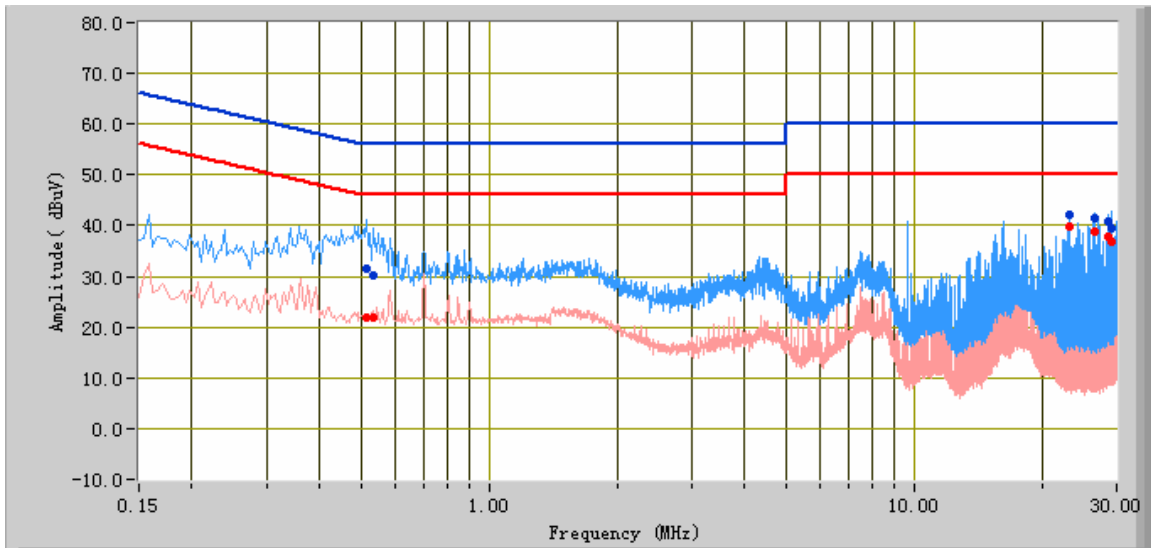

Test Data

| Frequency (MHz) | Quasi Peak (dBuV) | Limit (dBuV) | Margin (dB) | Average (dBuV) | Limit (dBuV) | Margin (dB) | Factors (dB) |
|-----------------|-------------------|--------------|-------------|----------------|--------------|-------------|--------------|
| 0.51 | 31.56 | 56.00 | -24.44 | 22.04 | 46.00 | -23.96 | 10.16 |
| 0.53 | 30.34 | 56.00 | -25.66 | 21.81 | 46.00 | -24.19 | 10.16 |
| 23.13 | 42.10 | 60.00 | -17.90 | 39.89 | 50.00 | -10.11 | 10.82 |
| 29.23 | 39.63 | 60.00 | -20.37 | 36.74 | 50.00 | -13.26 | 11.19 |
| 26.61 | 41.40 | 60.00 | -18.60 | 38.84 | 50.00 | -11.16 | 11.04 |
| 28.68 | 40.79 | 60.00 | -19.21 | 37.96 | 50.00 | -12.04 | 11.16 |

Operating mode: Normal Working-Neutral

Peak Detector  **Quasi Peak Limit** 
Average Detector  **Average Limit** 

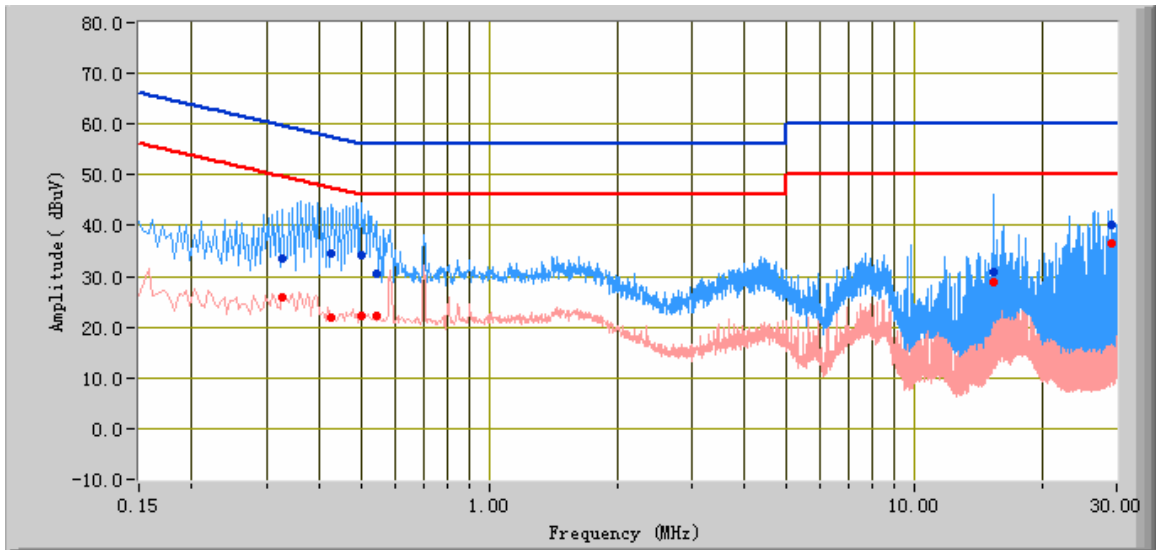

Test Data

| Frequency (MHz) | Quasi Peak (dBuV) | Limit (dBuV) | Margin (dB) | Average (dBuV) | Limit (dBuV) | Margin (dB) | Factors (dB) |
|-----------------|-------------------|--------------|-------------|----------------|--------------|-------------|--------------|
| 0.50 | 34.03 | 56.00 | -21.97 | 22.30 | 46.00 | -23.70 | 10.17 |
| 0.43 | 34.58 | 57.35 | -22.78 | 22.02 | 47.35 | -25.33 | 10.17 |
| 15.38 | 30.81 | 60.00 | -29.19 | 28.72 | 50.00 | -21.28 | 10.48 |
| 0.55 | 30.47 | 56.00 | -25.53 | 22.18 | 46.00 | -23.82 | 10.16 |
| 0.33 | 33.54 | 59.62 | -26.08 | 25.92 | 49.62 | -23.69 | 10.19 |
| 29.23 | 40.08 | 60.00 | -19.92 | 36.54 | 50.00 | -13.46 | 11.19 |

5.3 6dB Occupied Bandwidth

1. Conducted Measurement
EUT was set for low, mid, high channel with modulated mode and highest RF output power. The spectrum analyzer was connected to the antenna terminal.
2. Environmental Conditions

| | |
|----------------------|----------|
| Temperature | 16°C |
| Relative Humidity | 50% |
| Atmospheric Pressure | 1019mbar |
3. Conducted Emissions Measurement Uncertainty
All test measurements carried out are traceable to national standards. The uncertainty of the measurement at a confidence level of approximately 95% (in the case where distributions are normal), with a coverage factor of 2, in the range 30MHz – 40GHz is ±1.5dB.
4. Test date : January 7~12 January 2011
Tested By : Alex Wang

Requirement(s): 47 CFR § 15.247(a)(1)

Procedures: The 6dB Bandwidths were measured conducted using a spectrum analyzer at low, mid, and hi channels. 6dB Bandwidth Limit: >500kHz.

| Protocol | Channel | Channel Frequency (MHz) | 6dB Occupied Bandwidth Limit (MHz) | 6dB Channel Bandwidth (MHz) |
|---------------|---------|-------------------------|------------------------------------|-----------------------------|
| 802.11b | Low | 2412 | 0.5 | 8.33 |
| 802.11b | Mid | 2437 | 0.5 | 8.75 |
| 802.11b | High | 2462 | 0.5 | 8.08 |
| 802.11g | Low | 2412 | 0.5 | 16.67 |
| 802.11g | Mid | 2437 | 0.5 | 16.67 |
| 802.11g | High | 2462 | 0.5 | 16.75 |
| 802.11n-20MHz | Low | 2412 | 0.5 | 17.58 |
| 802.11n-20MHz | Mid | 2437 | 0.5 | 17.92 |
| 802.11n-20MHz | High | 2462 | 0.5 | 17.83 |
| 802.11n-40MHz | Low | 2412 | 0.5 | 36.2 |
| 802.11n-40MHz | Mid | 2437 | 0.5 | 36.2 |
| 802.11n-40MHz | High | 2462 | 0.5 | 36.7 |

Refer to the attached plots.

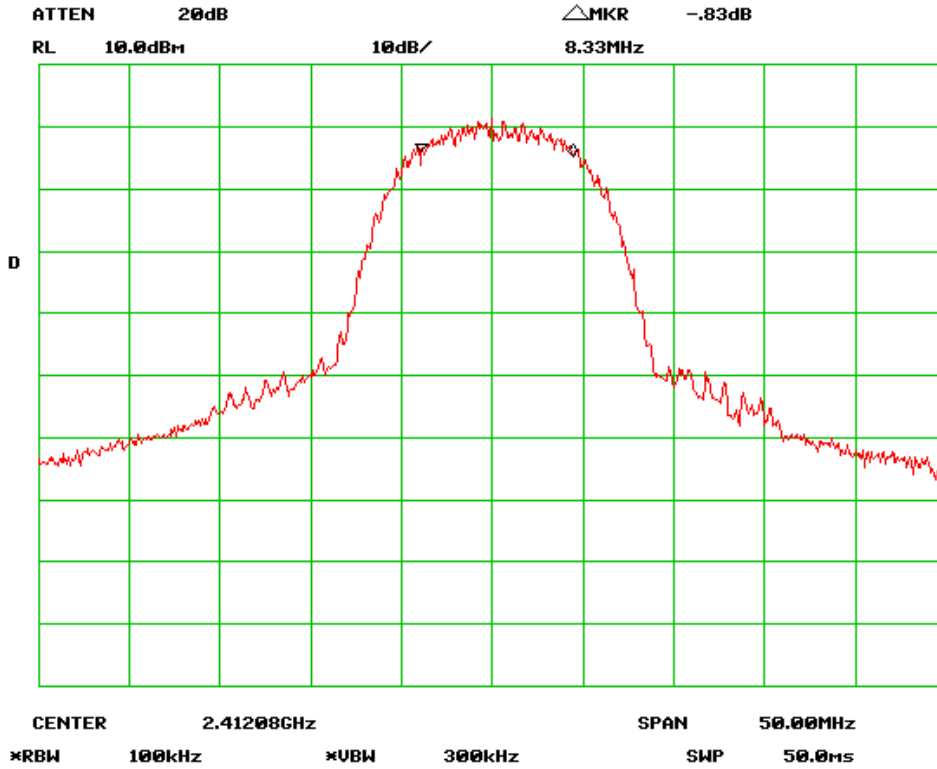

6dB Bandwidth – Low Channel (802.11b)

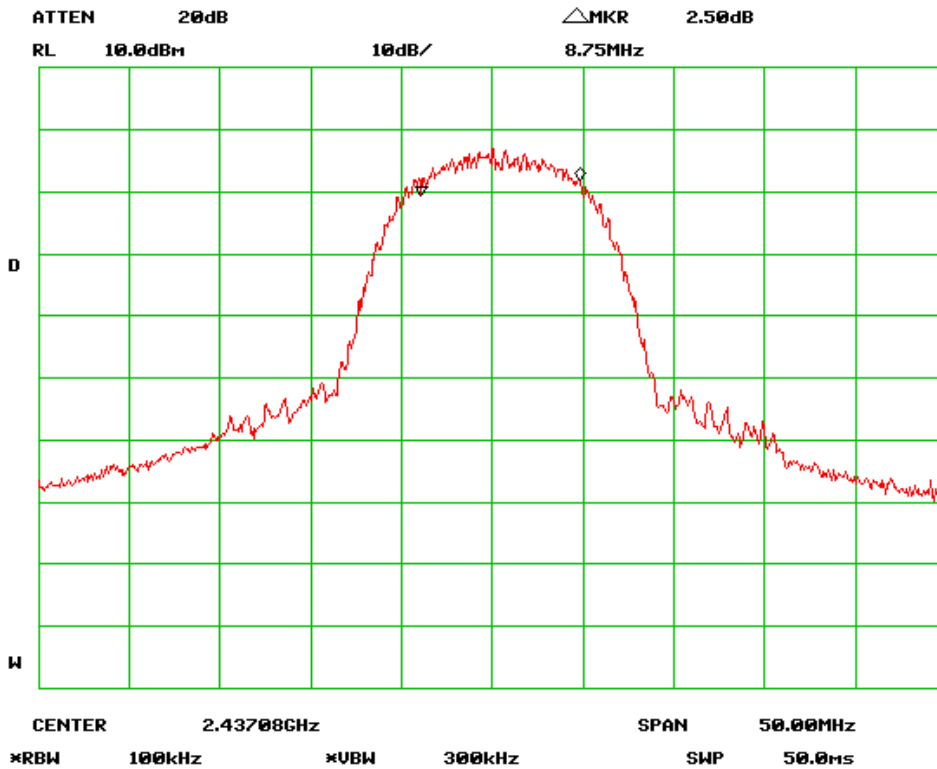

6dB Bandwidth – Mid Channel (802.11b)

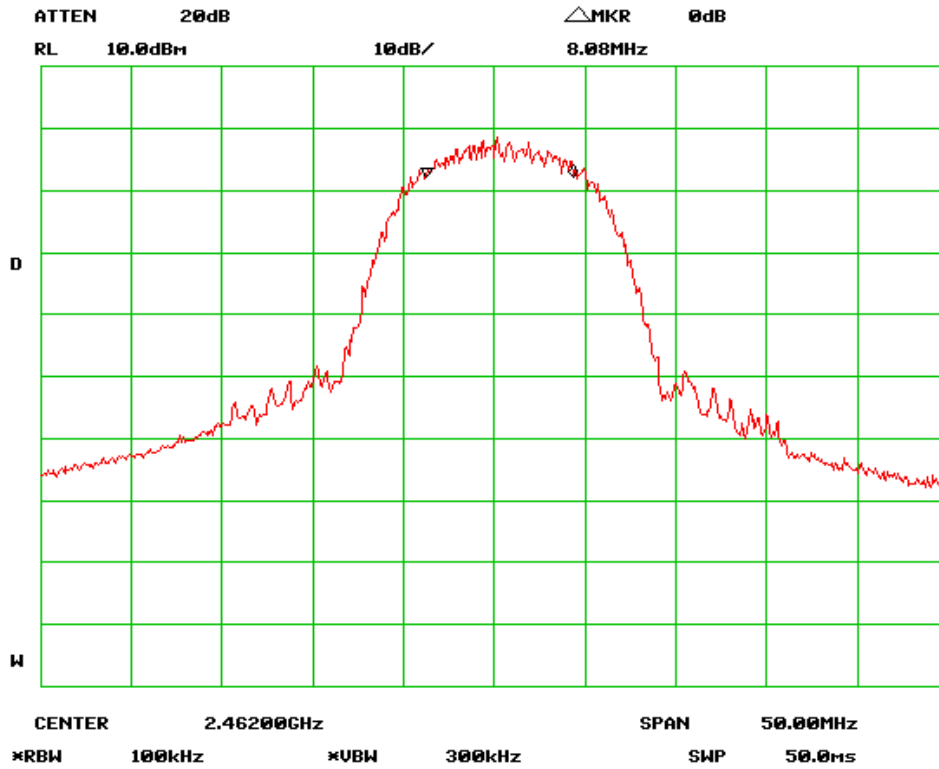

6dB Bandwidth – High Channel (802.11b)

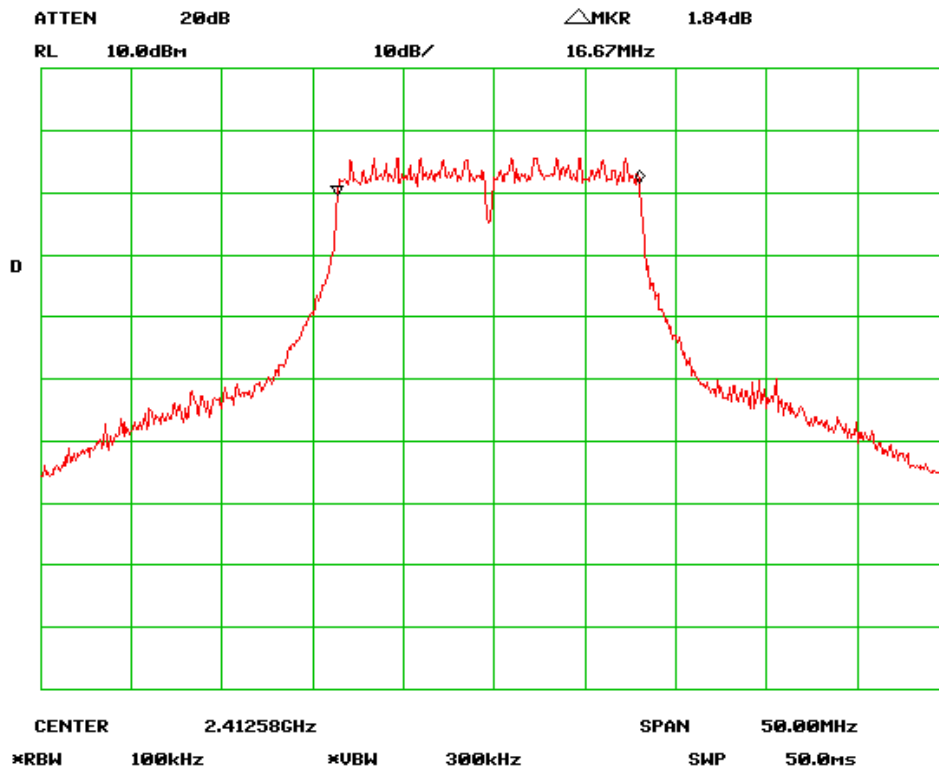

6dB Bandwidth – Low Channel (802.11g)



SIEMIC, INC.

Accessing global markets

Title: RF Test Report for Wifi Modular
Model: MR100
To: FCC 15.247:2009

Serial#: 10021272
Issue Date: 13 January 2011
Page: 16 of 113
www.siemic.com.cn

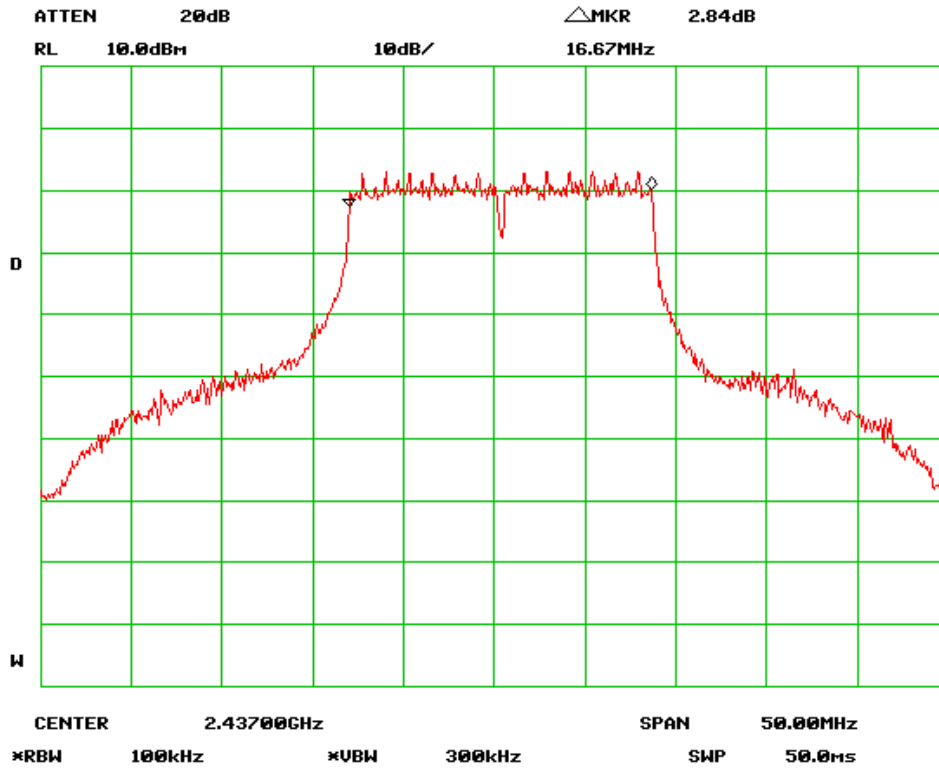

6dB Bandwidth – Mid Channel (802.11g)

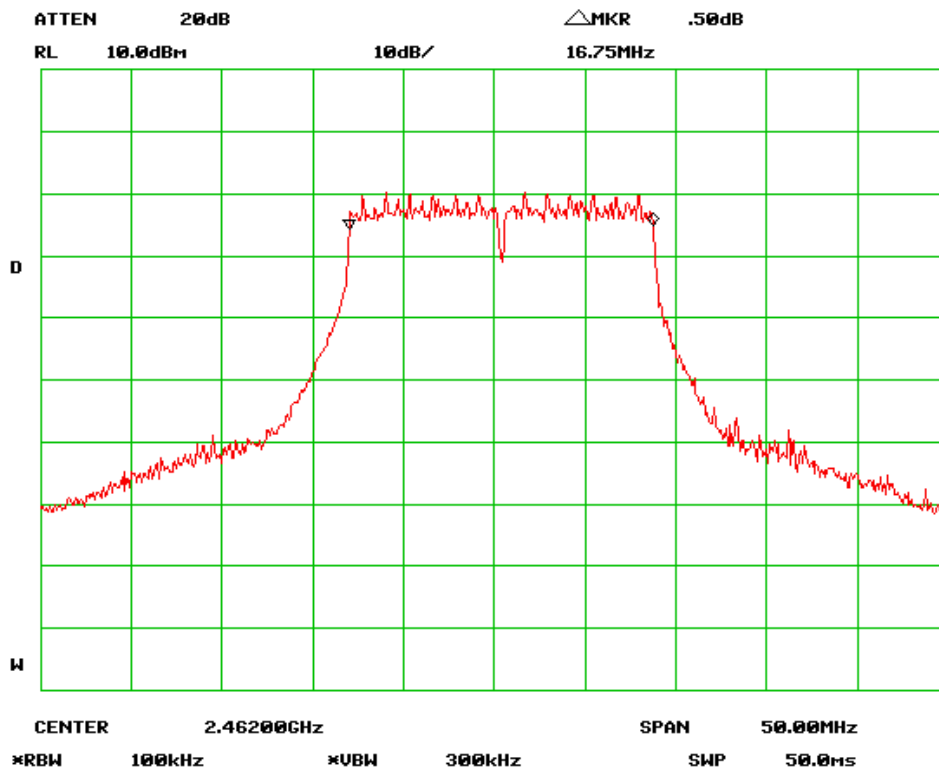

6dB Bandwidth – High Channel (802.11g)



SIEMIC, INC.

Accessing global markets

Title: RF Test Report for Wifi Modular
Model: MR100
To: FCC 15.247:2009

Serial#: 10021272
Issue Date: 13 January 2011
Page: 17 of 113
www.siemic.com.cn

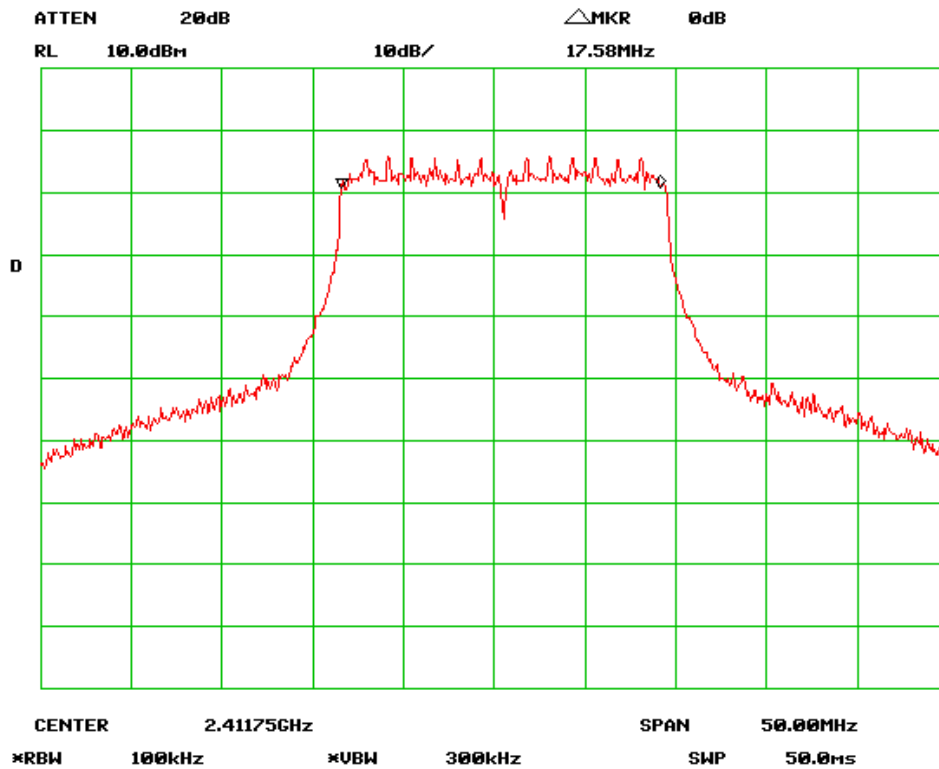

6dB Bandwidth – Low Channel (802.11n-20MHz)

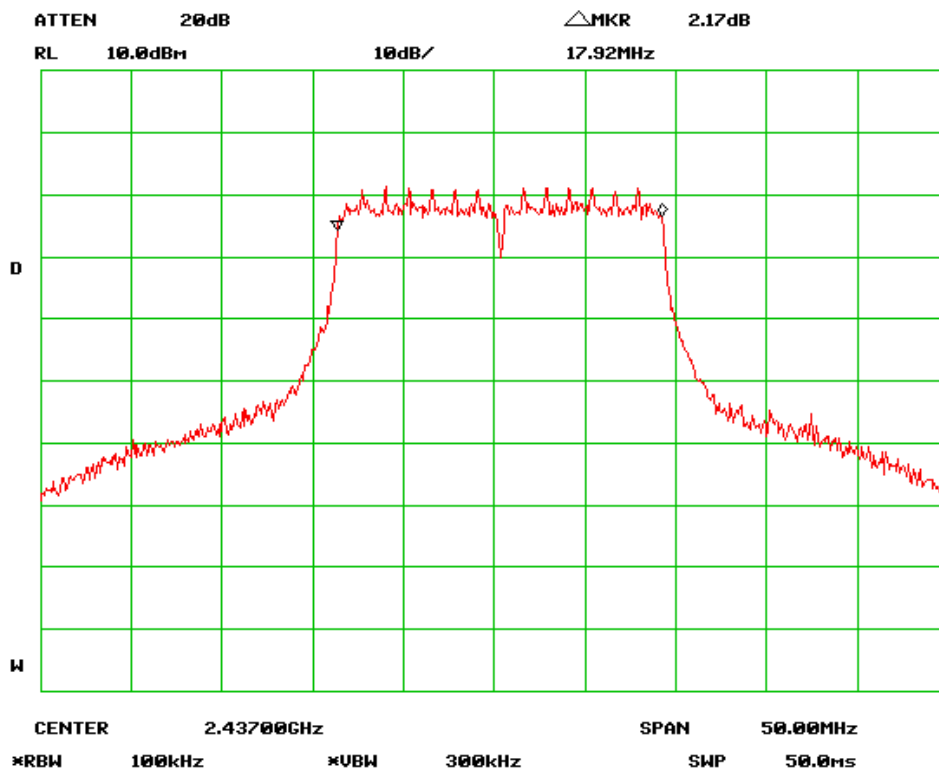

6dB Bandwidth – Mid Channel (802.11n-20MHz)

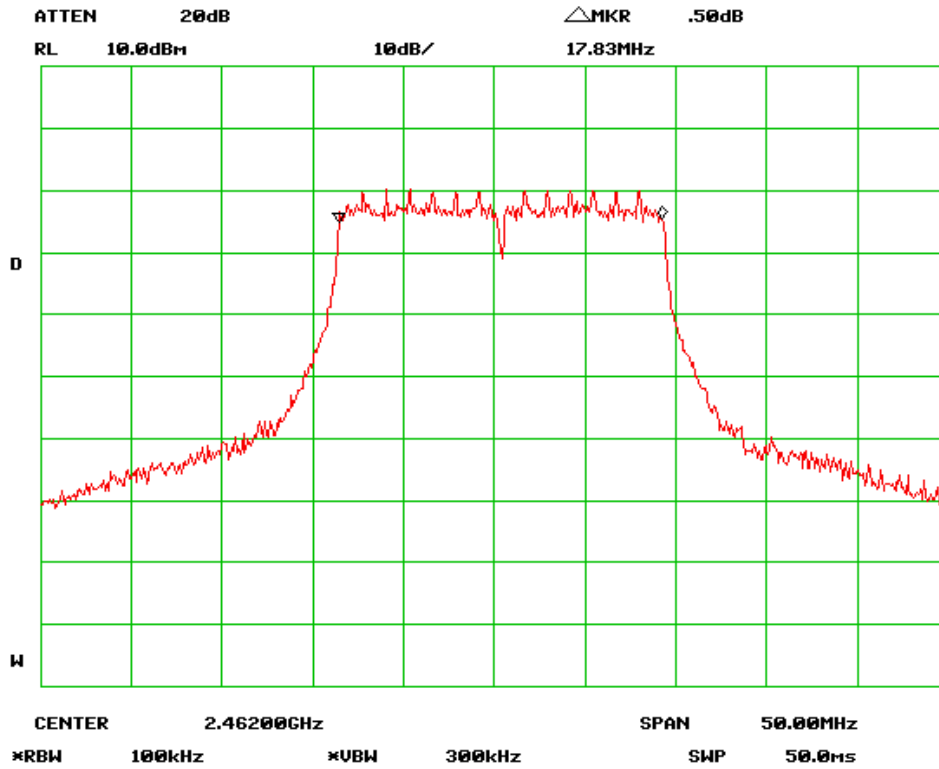

6dB Bandwidth – High Channel (802.11n-20MHz)

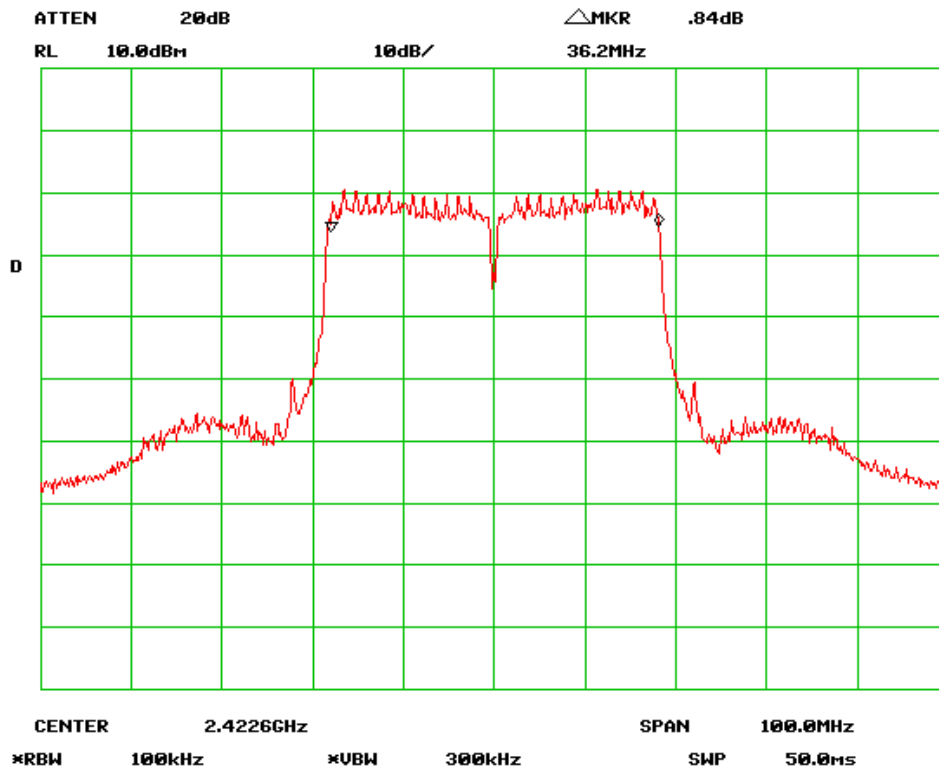

6dB Bandwidth – Low Channel (802.11n-40MHz)

5.4 Power Spectral Density

1. Conducted Measurement
EUT was set for low, mid, high channel with modulated mode and highest RF output power.
The spectrum analyzer was connected to the antenna terminal.
2. Environmental Conditions

| | |
|----------------------|----------|
| Temperature | 16°C |
| Relative Humidity | 50% |
| Atmospheric Pressure | 1019mbar |
3. Conducted Emissions Measurement Uncertainty
All test measurements carried out are traceable to national standards. The uncertainty of the measurement at a confidence level of approximately 95% (in the case where distributions are normal), with a coverage factor of 2, in the range 30MHz – 40GHz is ±1.5dB.
4. Test date : January 7~12 January 2011
Tested By : Alex Wang

Requirement(s): 47 CFR § 15.247(e)

For digitally modulated systems, the power spectral density conducted from the intentional radiator to the antenna shall not be greater than 8dBm in any 3KHz band during any time interval of continuous transmission.

Procedures: The power spectral density measurement was taken conducted using a spectrum analyzer.

RBW=3KHz, VBW>RBW, Sweep time to SPAN/RBW(s).

The result:

| Protocol | Channel | Channel Frequency (MHz) | Peak Spectral Density Limit (dBm/3KHz) | Peak Spectral Density (dBm/3KHz) |
|---------------|---------|-------------------------|--|----------------------------------|
| 802.11b | Low | 2412 | 8 | -19.67 |
| 802.11b | Mid | 2437 | 8 | -19.67 |
| 802.11b | High | 2462 | 8 | -19.17 |
| 802.11g | Low | 2412 | 8 | -23.33 |
| 802.11g | Mid | 2437 | 8 | -26.00 |
| 802.11g | High | 2462 | 8 | -23.67 |
| 802.11n-20MHz | Low | 2412 | 8 | -23.83 |
| 802.11n-20MHz | Mid | 2437 | 8 | -25.67 |
| 802.11n-20MHz | High | 2462 | 8 | -26.83 |
| 802.11n-40MHz | Low | 2412 | 8 | -28.17 |
| 802.11n-40MHz | Mid | 2437 | 8 | -26.17 |
| 802.11n-40MHz | High | 2462 | 8 | -26.17 |

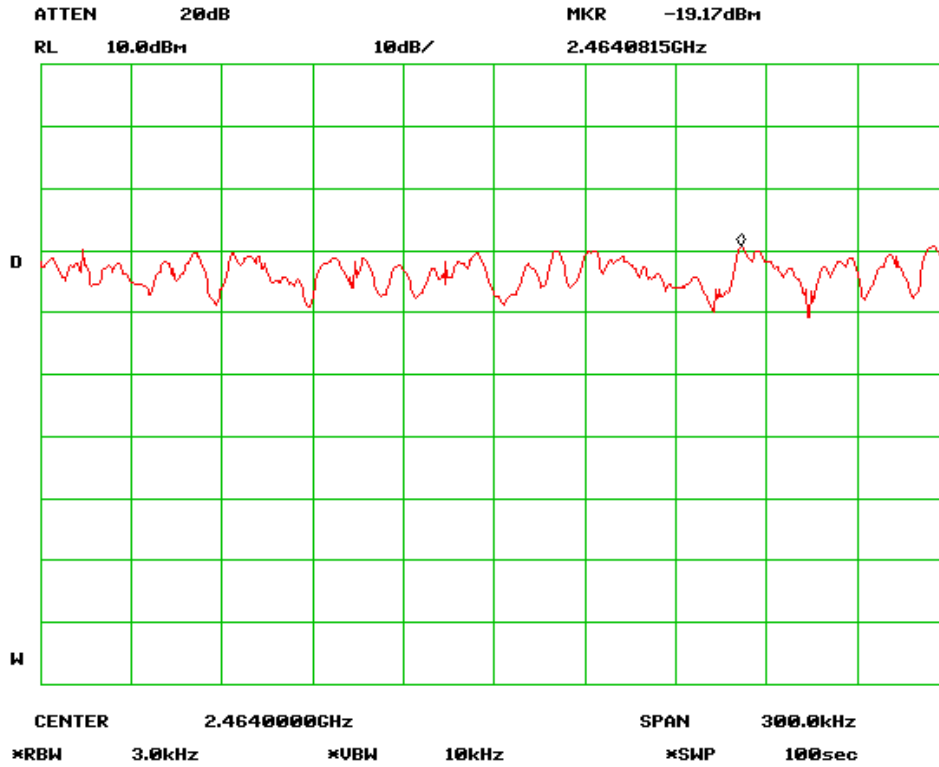

PSD - High Channel (802.11b)

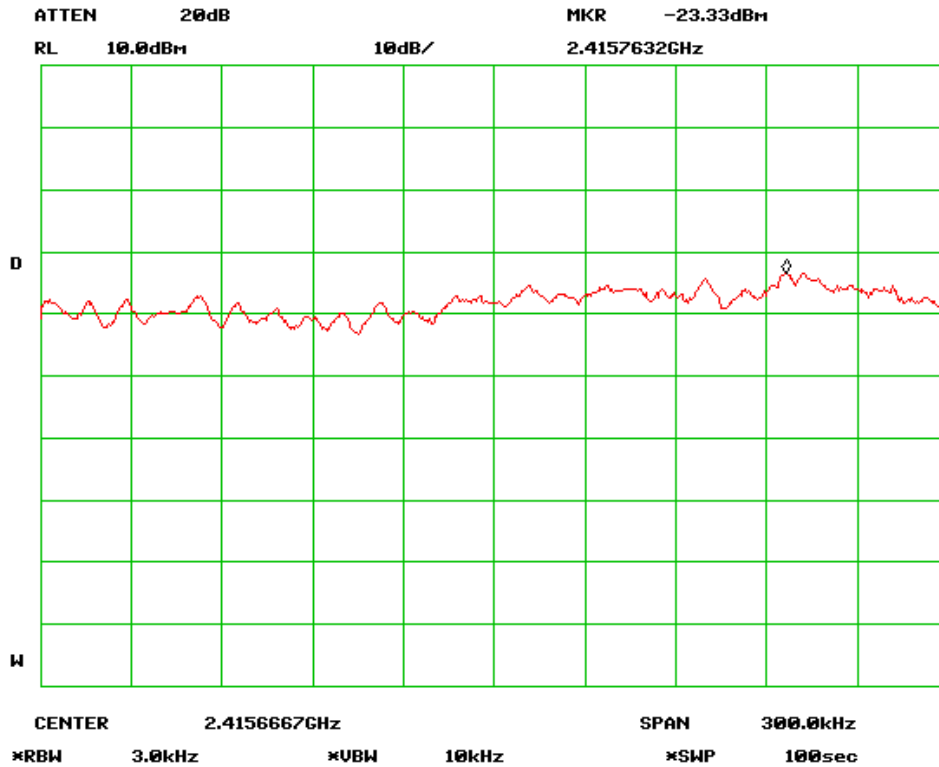

PSD - Low Channel (802.11g)



SIEMIC, INC.

Accessing global markets

Title: RF Test Report for Wifi Modular
Model: MR100
To: FCC 15.247:2009

Serial#: 10021272
Issue Date: 13 January 2011
Page: 23 of 113
www.siemic.com.cn

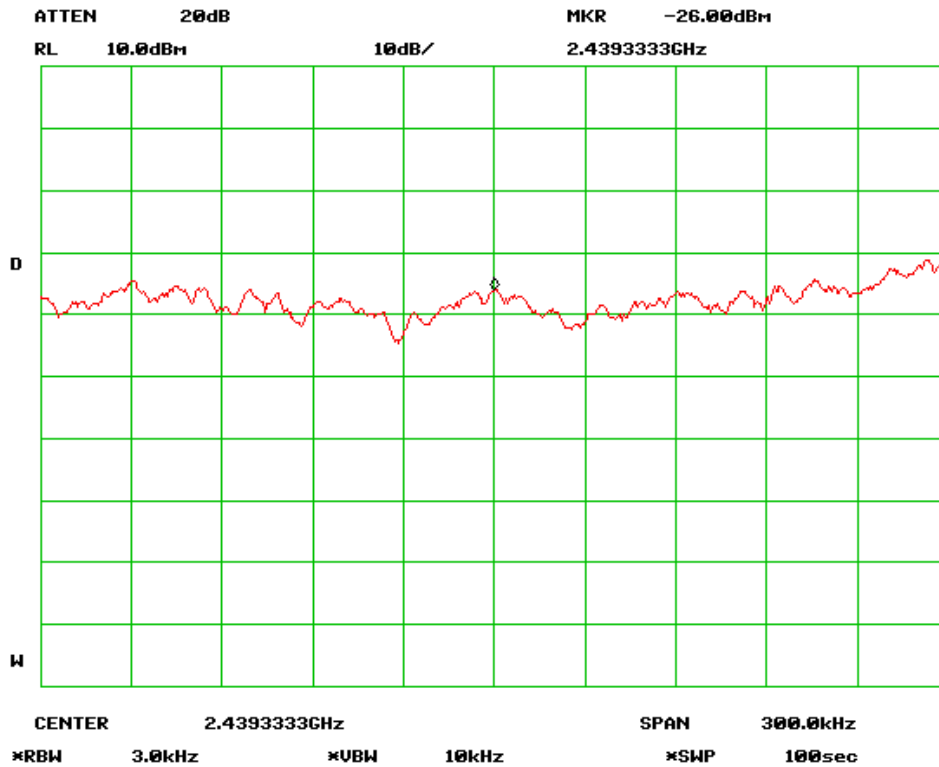

PSD - Mid Channel (802.11g)

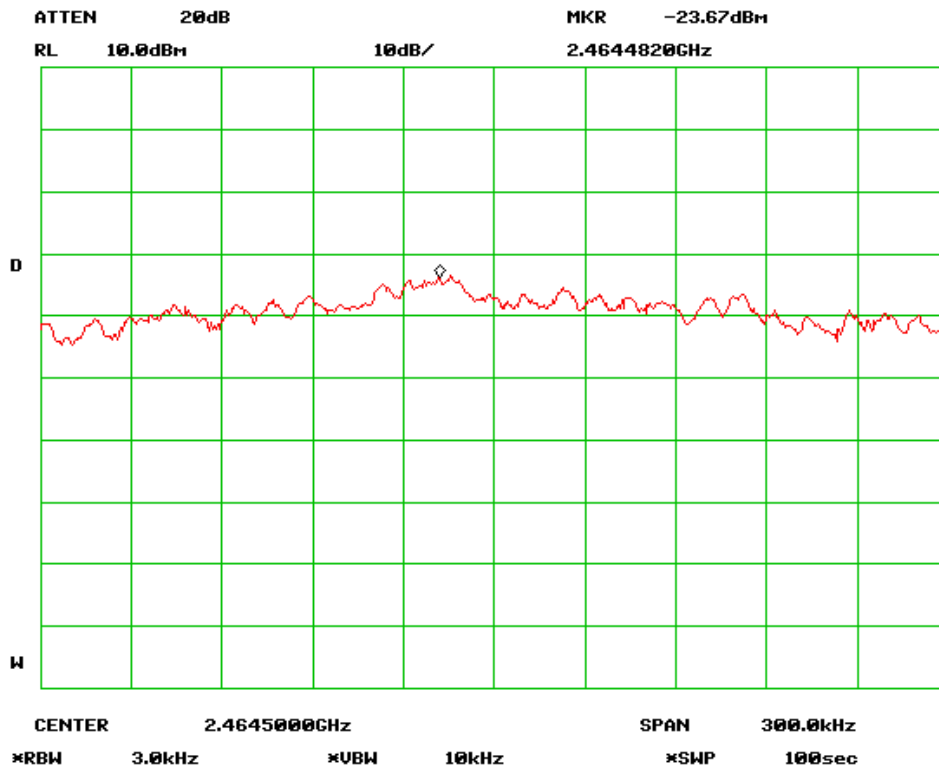

PSD - High Channel (802.11g)



SIEMIC, INC.

Accessing global markets

Title: RF Test Report for Wifi Modular
Model: MR100
To: FCC 15.247:2009

Serial#: 10021272
Issue Date: 13 January 2011
Page: 24 of 113
www.siemec.com.cn

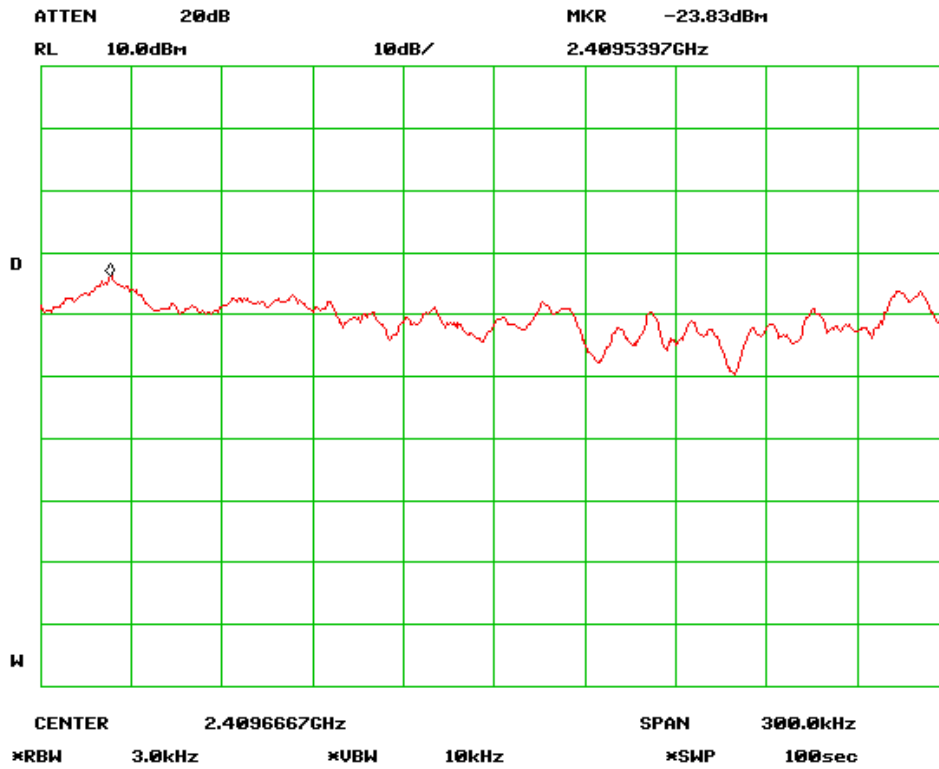

PSD - Low Channel (802.11n-20MHz)

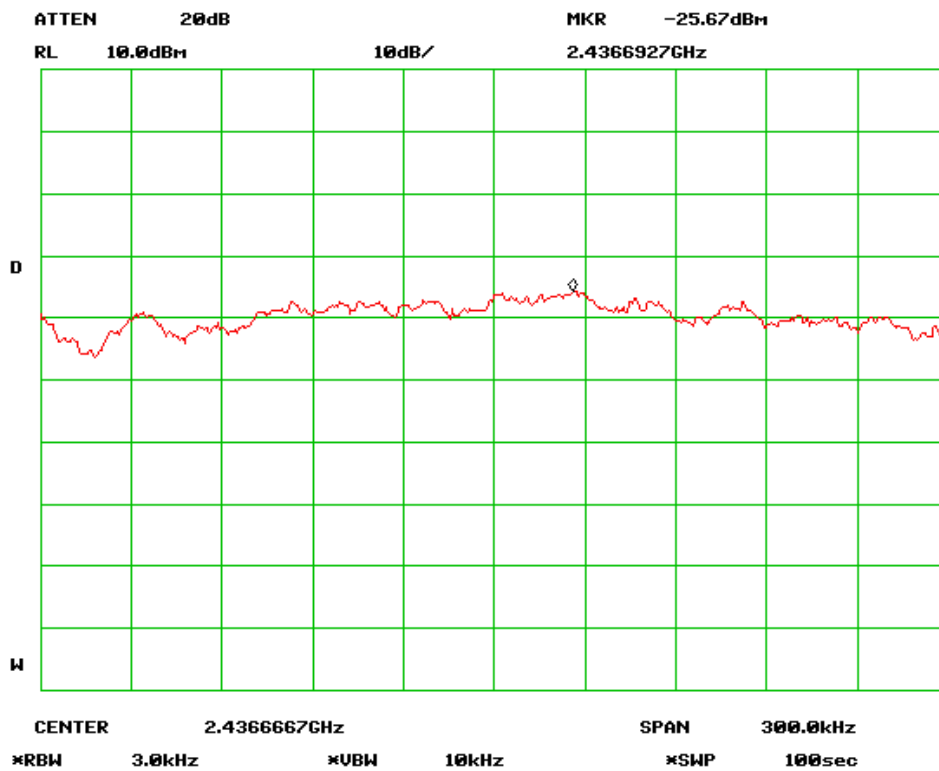

PSD - Mid Channel (802.11n-20MHz)



SIEMIC, INC.

Accessing global markets

Title: RF Test Report for Wifi Modular
Model: MR100
To: FCC 15.247:2009

Serial#: 10021272
Issue Date: 13 January 2011
Page: 25 of 113
www.siemic.com.cn

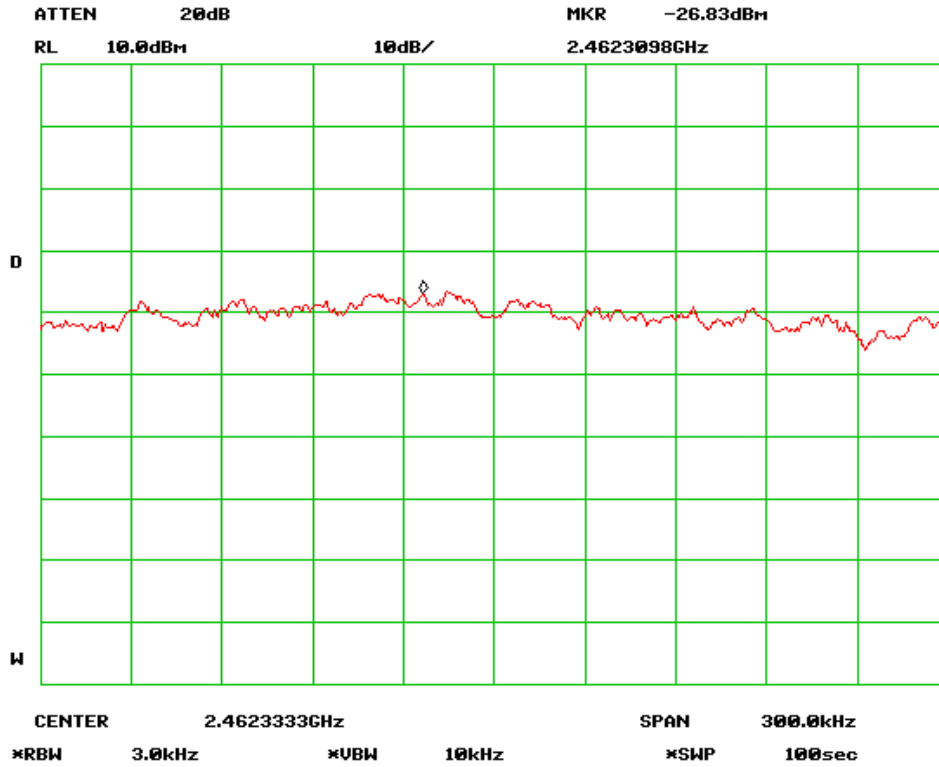

PSD - High Channel (802.11n-20MHz)

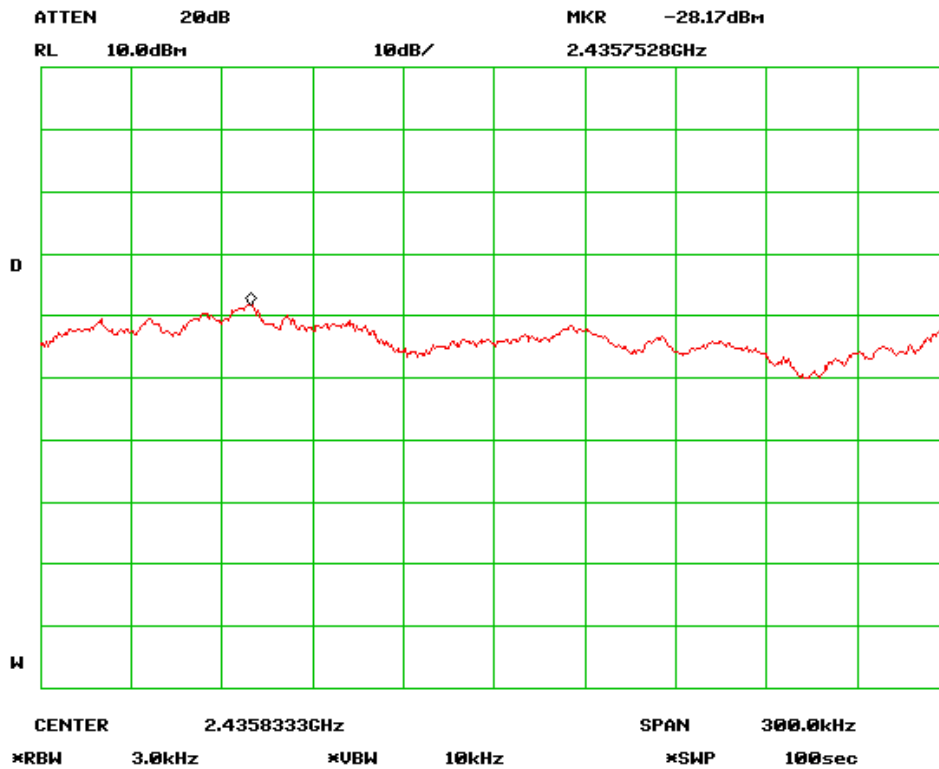

PSD - Low Channel (802.11n-40MHz)



SIEMIC, INC.

Accessing global markets

Title: RF Test Report for Wifi Modular
Model: MR100
To: FCC 15.247:2009

Serial#: 10021272
Issue Date: 13 January 2011
Page: 26 of 113
www.siemic.com.cn

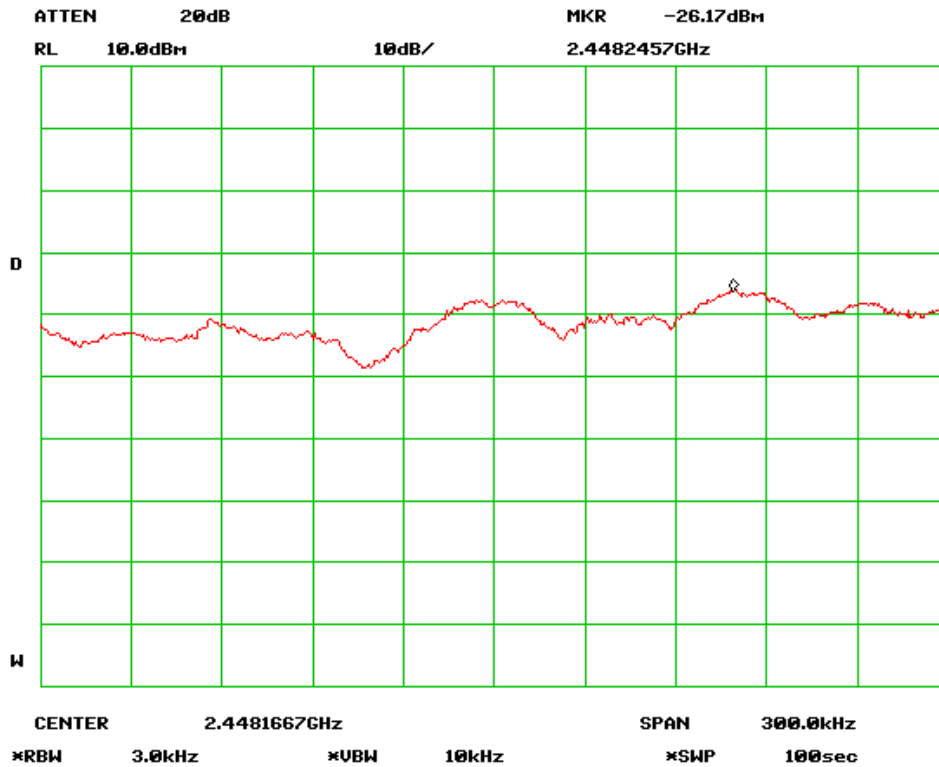

PSD - Mid Channel (802.11n-40MHz)

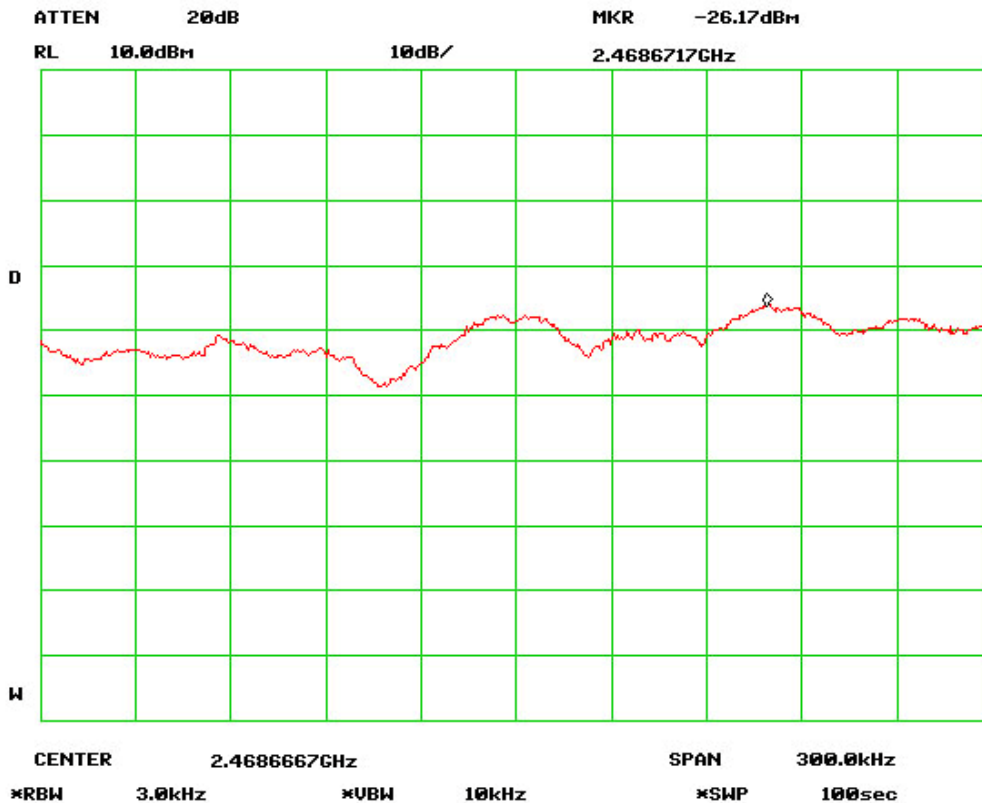

PSD - High Channel (802.11n-40MHz)

5.5 Peak Output Power

1. **Conducted Measurement**
 EUT was set for low, mid, high channel with modulated mode and highest RF output power.
 The spectrum analyzer was connected to the antenna terminal.
2. **Conducted Emissions Measurement Uncertainty**
 All test measurements carried out are traceable to national standards. The uncertainty of the measurement at a confidence level of approximately 95% (in the case where distributions are normal), with a coverage factor of 2, in the range 30MHz – 40GHz is ± 1.5 dB.
3. **Environmental Conditions**

| | |
|----------------------|----------|
| Temperature | 16°C |
| Relative Humidity | 50% |
| Atmospheric Pressure | 1019mbar |
4. Test date : January 7~12 January 2011
 Tested By : Alex Wang

Standard Requirement: 47 CFR § 15.247(b)

Procedures: The peak output power was measured conducted using a spectrum analyzer at low, mid, and hi channels. Peak detector was set to measure the power output. The power is converted from watt to dBm, therefore, 1 watt = 30 dBm. The highest antenna gain that will be used is 0.79dBi.

Test Result:

| Protocol | Channel | Channel Frequency (MHz) | Peak Output Power Limit (dBm) | Measured Output Power (dBm) |
|---------------|---------|-------------------------|-------------------------------|-----------------------------|
| 802.11b | Low | 2412 | 30 | 10.1 |
| 802.11b | Mid | 2437 | 30 | 11.5 |
| 802.11b | High | 2462 | 30 | 12.0 |
| 802.11g | Low | 2412 | 30 | 9.3 |
| 802.11g | Mid | 2437 | 30 | 11.1 |
| 802.11g | High | 2462 | 30 | 9.0 |
| 802.11n-20MHz | Low | 2412 | 30 | 9.3 |
| 802.11n-20MHz | Mid | 2437 | 30 | 9.6 |
| 802.11n-20MHz | High | 2462 | 30 | 8.8 |
| 802.11n-40MHz | Low | 2412 | 30 | 6.5 |
| 802.11n-40MHz | Mid | 2437 | 30 | 8.8 |
| 802.11n-40MHz | High | 2462 | 30 | 7.5 |

Refer to the attached plots.

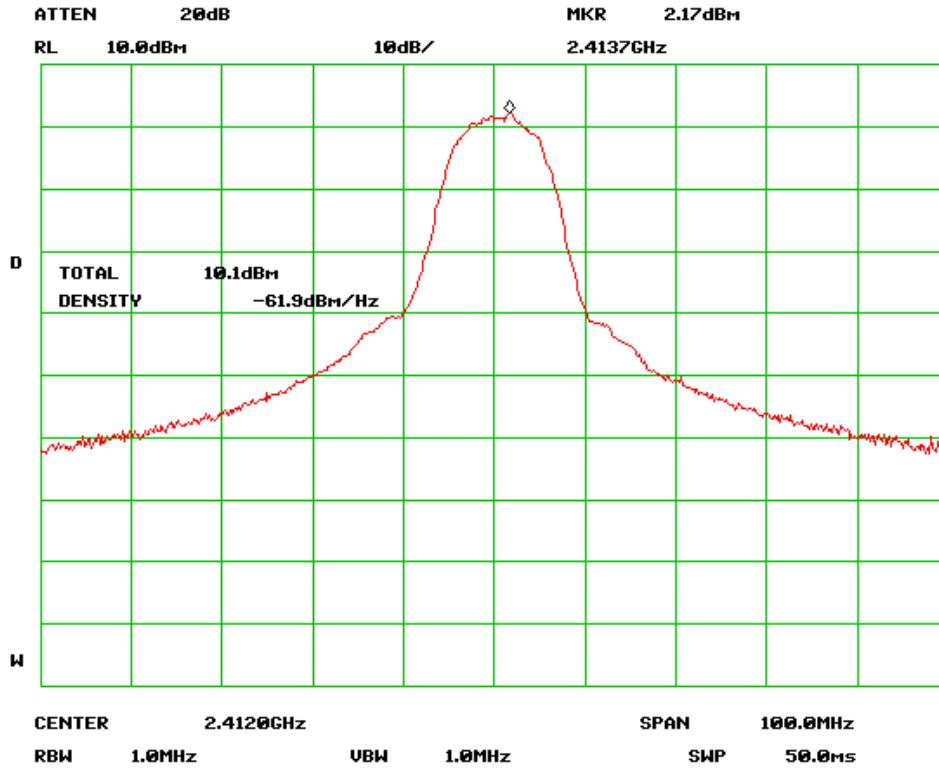

Output Power Low Channel (802.11b)

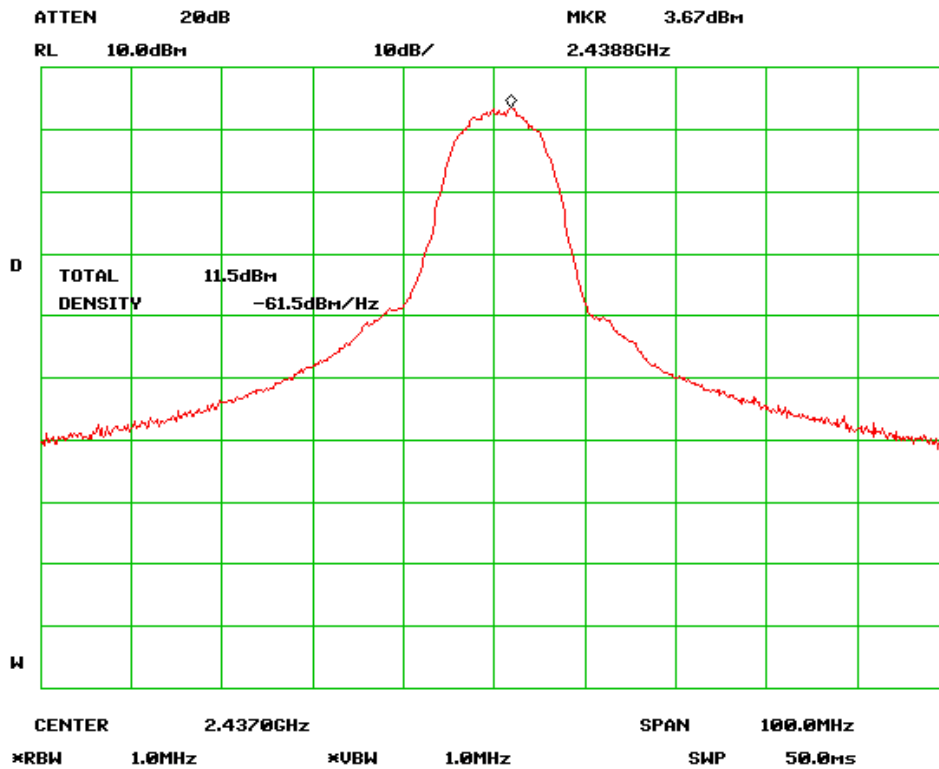

Output Power Mid Channel (802.11b)



SIEMIC, INC.

Accessing global markets

Title: RF Test Report for Wifi Modular
Model: MR100
To: FCC 15.247:2009

Serial#: 10021272
Issue Date: 13 January 2011
Page: 29 of 113
www.siemic.com.cn

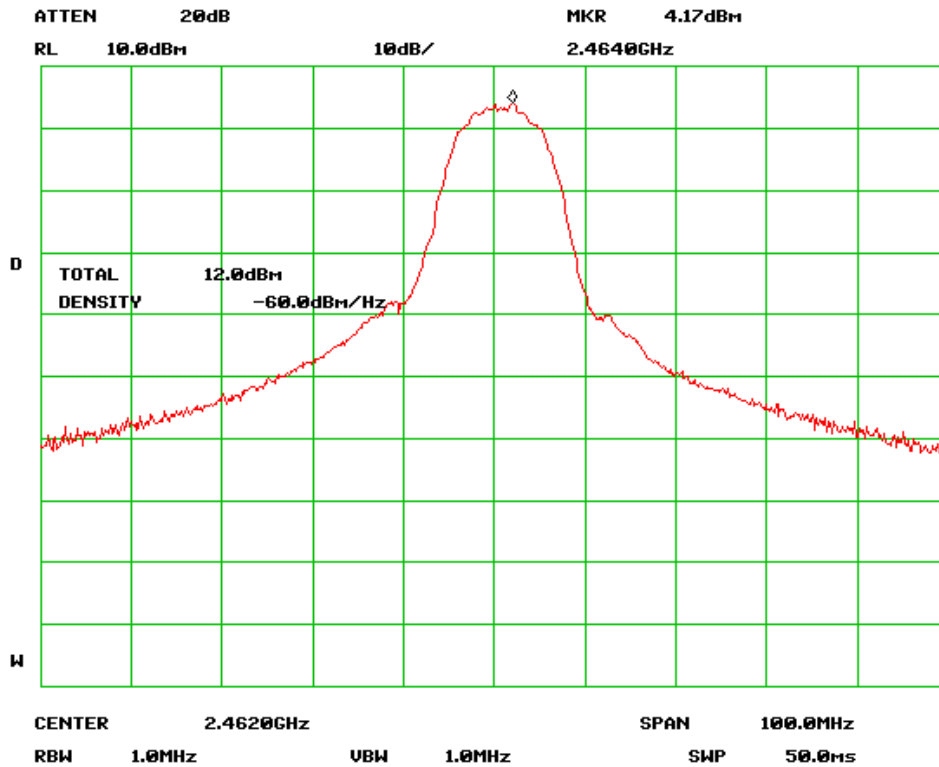

Output Power High Channel (802.11b)

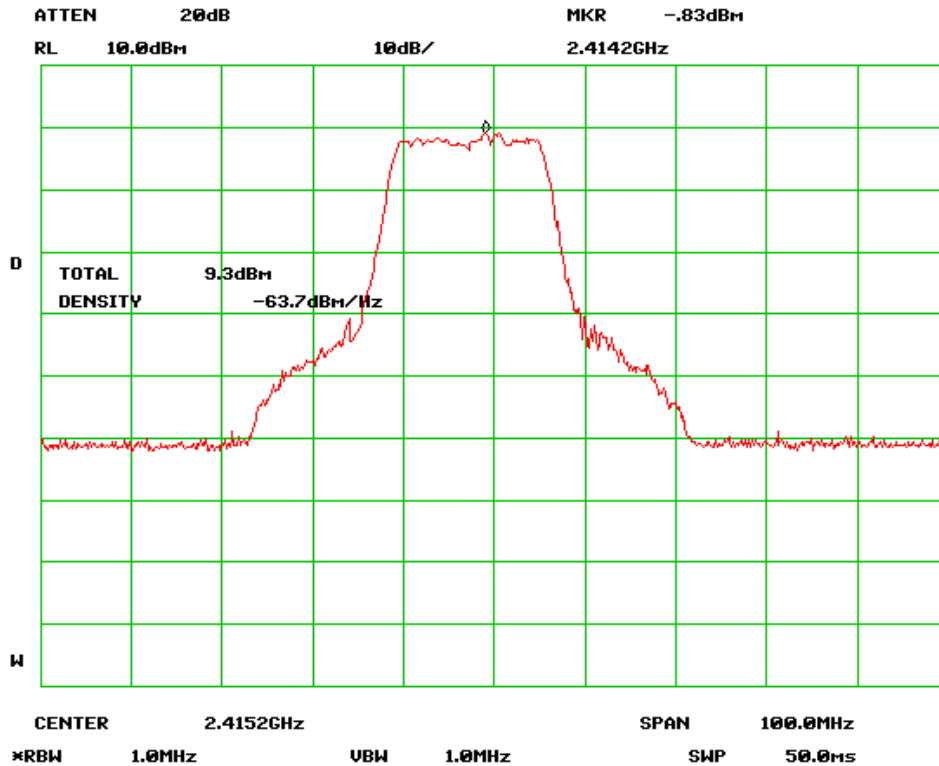

Output Power Low Channel (802.11g)



SIEMIC, INC.

Accessing global markets

Title: RF Test Report for Wifi Modular
Model: MR100
To: FCC 15.247:2009

Serial#: 10021272
Issue Date: 13 January 2011
Page: 30 of 113
www.siemic.com.cn

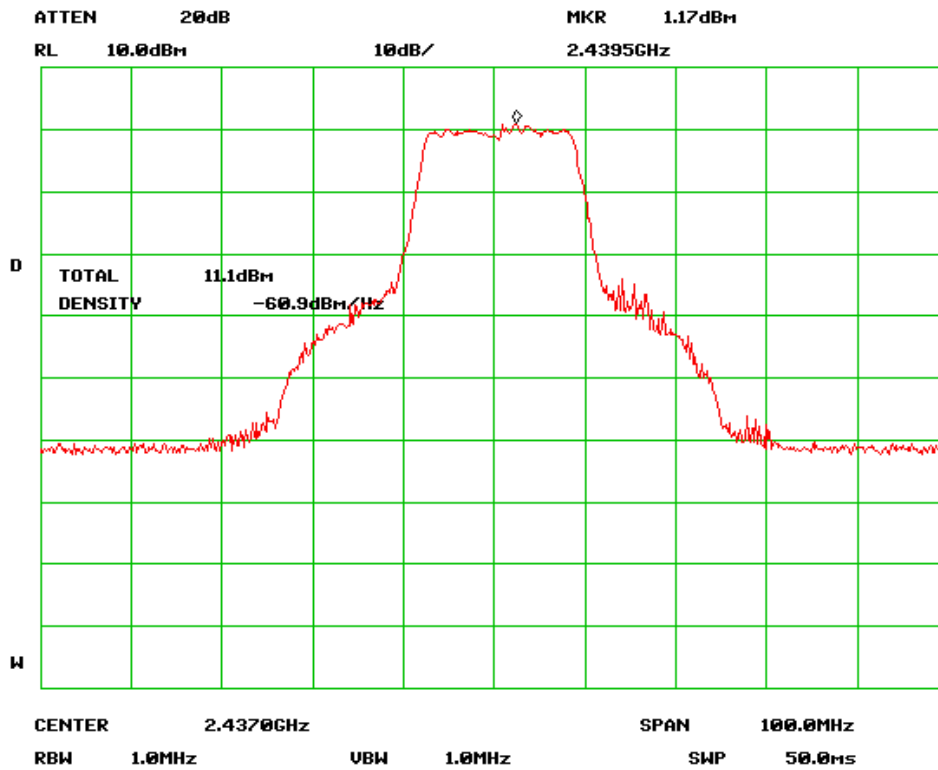

Output Power Mid Channel (802.11g)

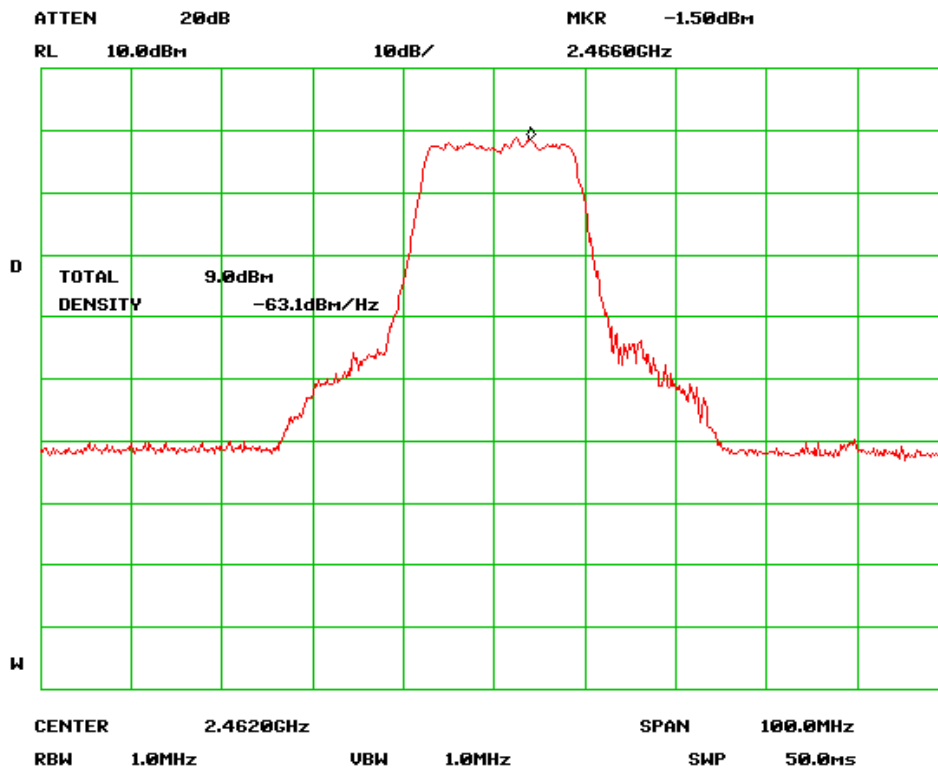

Output Power High Channel (802.11g)

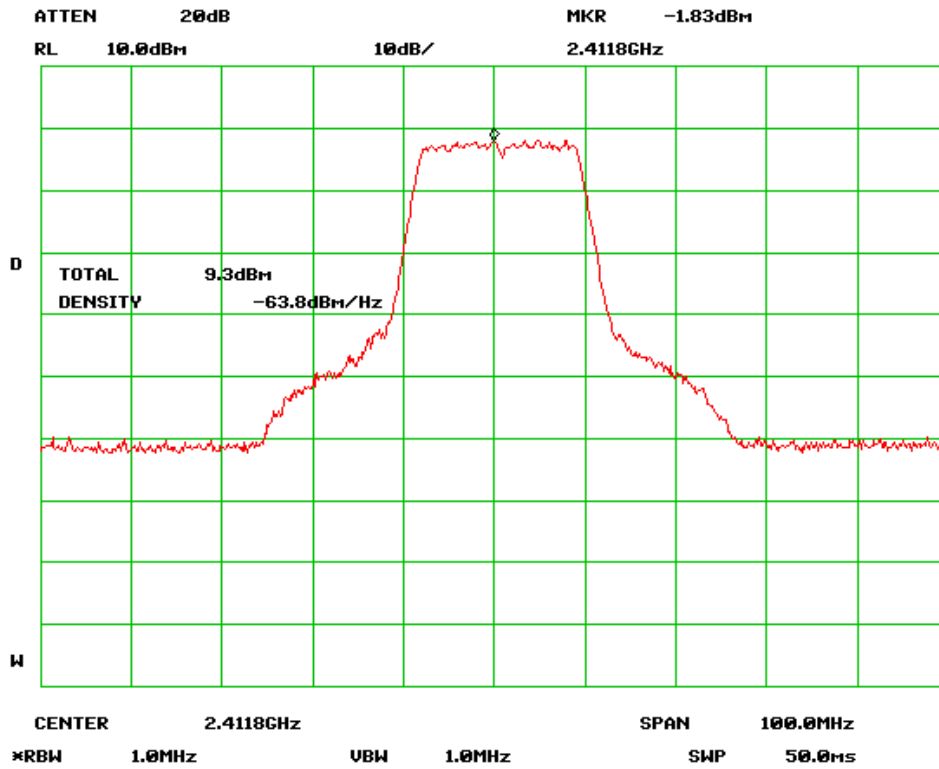

Output Power Low Channel (802.11n-20MHz)

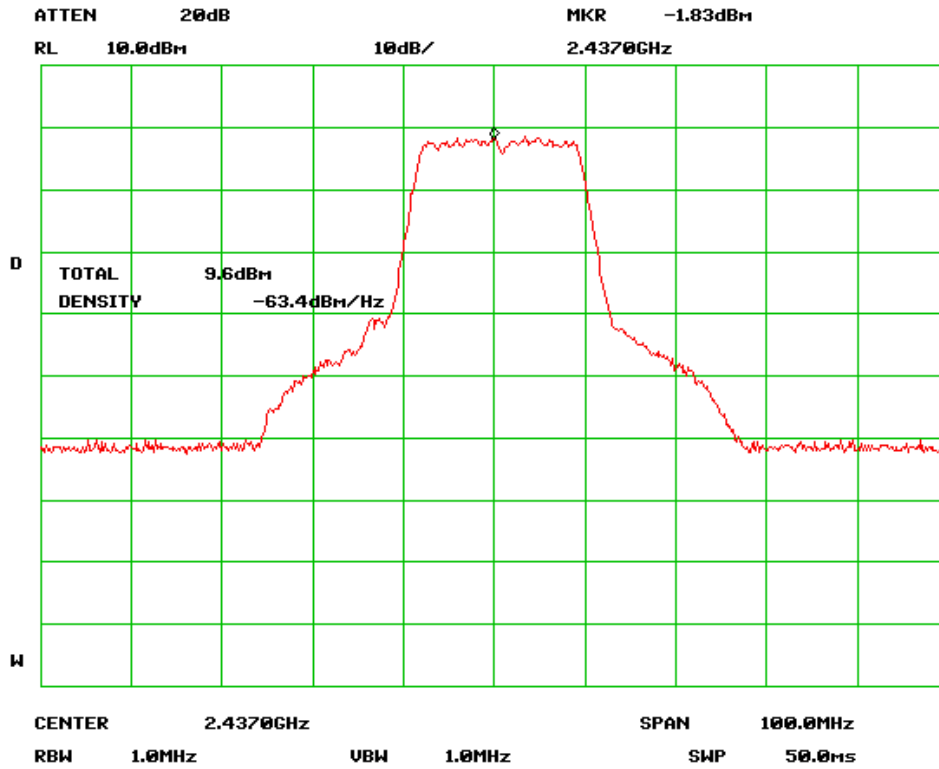

Output Power Mid Channel (802.11n-20MHz)

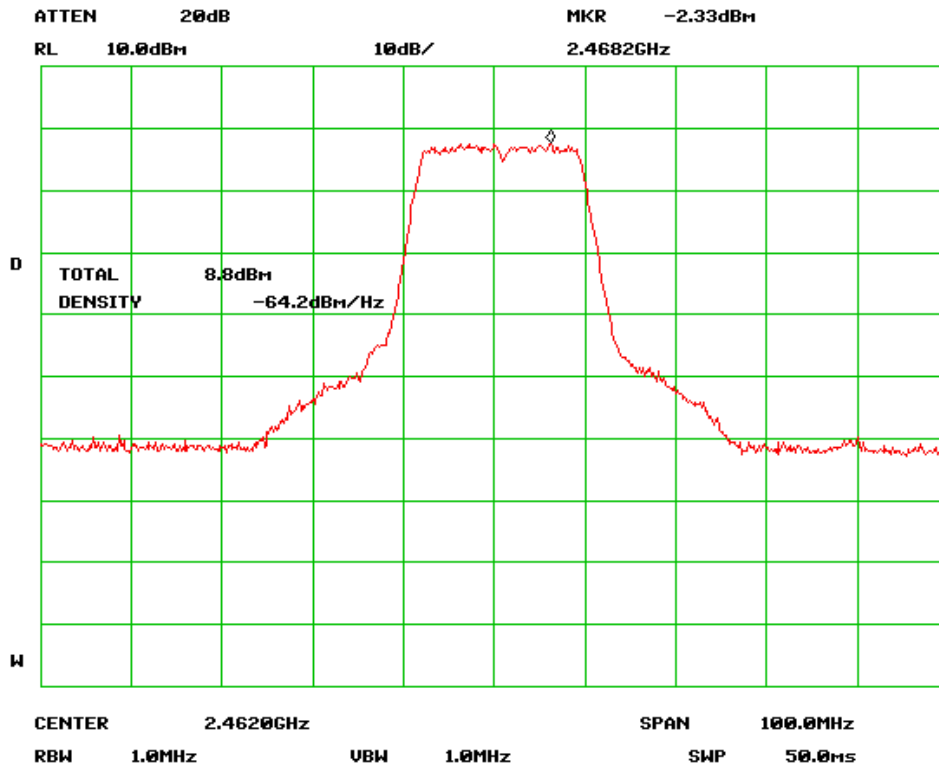

Output Power High Channel (802.11n-20MHz)

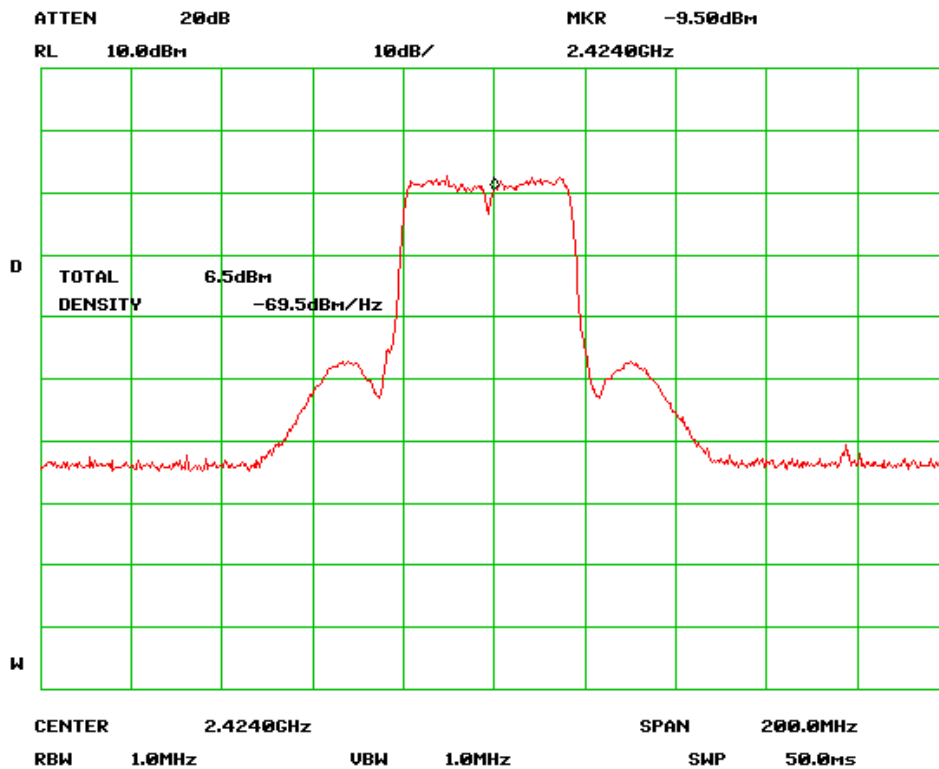

Output Power Low Channel (802.11n-40MHz)

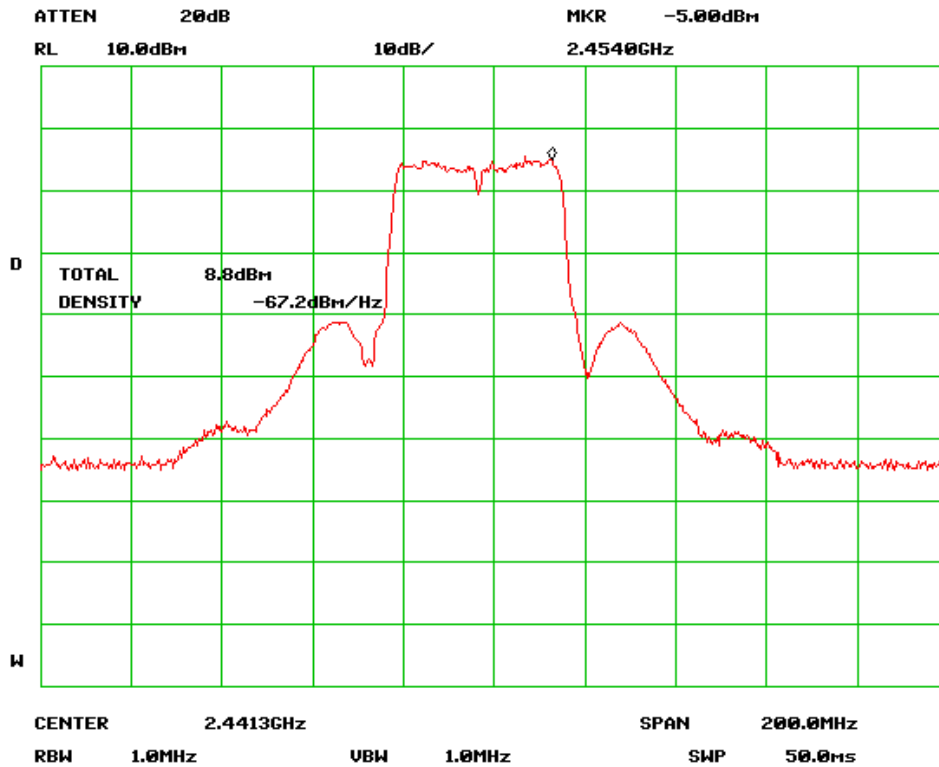

Output Power Mid Channel (802.11n-40MHz)

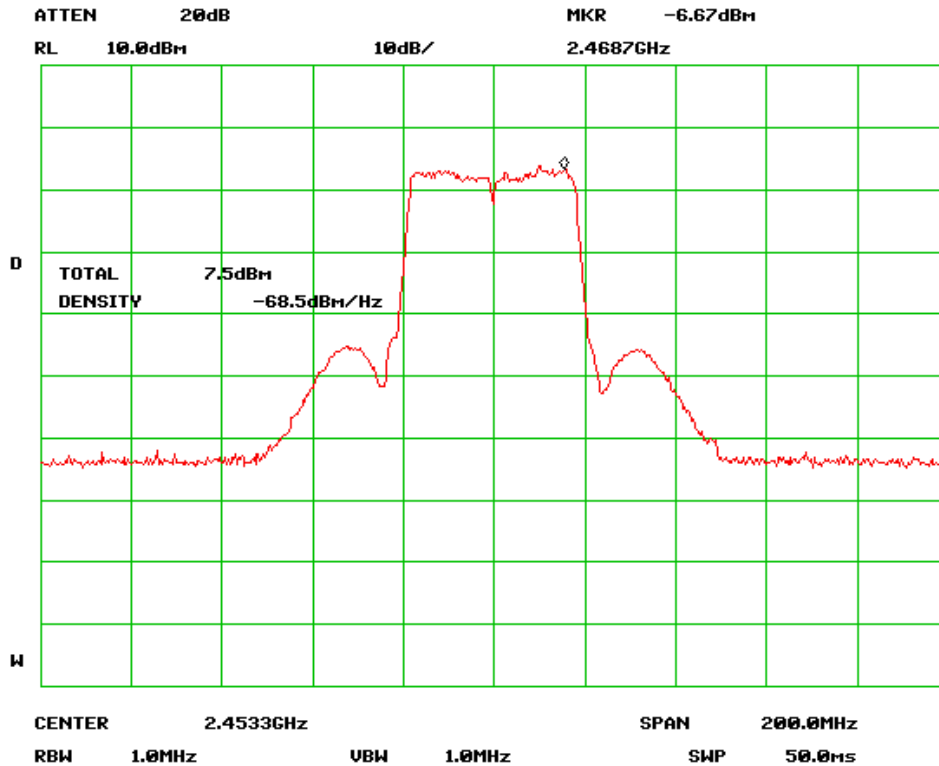

Output Power High Channel (802.11n-40MHz)

5.6 Antenna Port Emission

1. **Conducted Measurement**
EUT was set for low, mid, high channel with modulated mode and highest RF output power. The spectrum analyzer was connected to the antenna terminal.
2. **Conducted Emissions Measurement Uncertainty**
All test measurements carried out are traceable to national standards. The uncertainty of the measurement at a confidence level of approximately 95% (in the case where distributions are normal), with a coverage factor of 2, in the range 30MHz – 40GHz is $\pm 1.5\text{dB}$.
3. Environmental Conditions

| | |
|----------------------|----------|
| Temperature | 16°C |
| Relative Humidity | 50% |
| Atmospheric Pressure | 1019mbar |
4. Test date : January 7~12 January 2011
Tested By : Alex Wang

Standard Requirement: Radiated emission limits: In any 100 kHz bandwidth outside the frequency band in which the spread spectrum intentional radiator is operating, the radio frequency power that is produced by the modulation products of the spreading sequence, the information sequence and the carrier frequency shall be at least 20 dB below that in the 100 kHz bandwidth within the band that contains the highest level of the desired power

Procedures: The conducted spurious emissions were measured conducted using a spectrum analyzer at low, mid, and hi channels. The limit was determined by attenuating 20 dB of the RF peak power output.

Test Result:



SIEMIC, INC.

Accessing global markets

Title: RF Test Report for Wifi Modular
Model: MR100
To: FCC 15.247:2009

Serial#: 10021272
Issue Date: 13 January 2011
Page: 35 of 113
www.siemic.com.cn

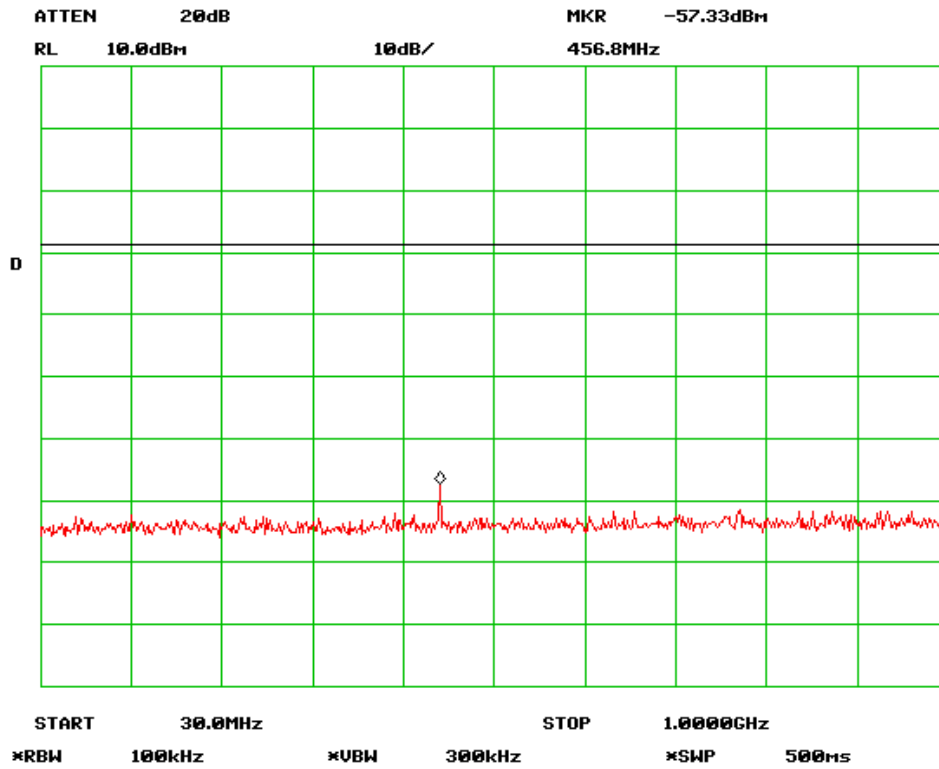

Antenna Port Emission Low Channel -1(802.11b)

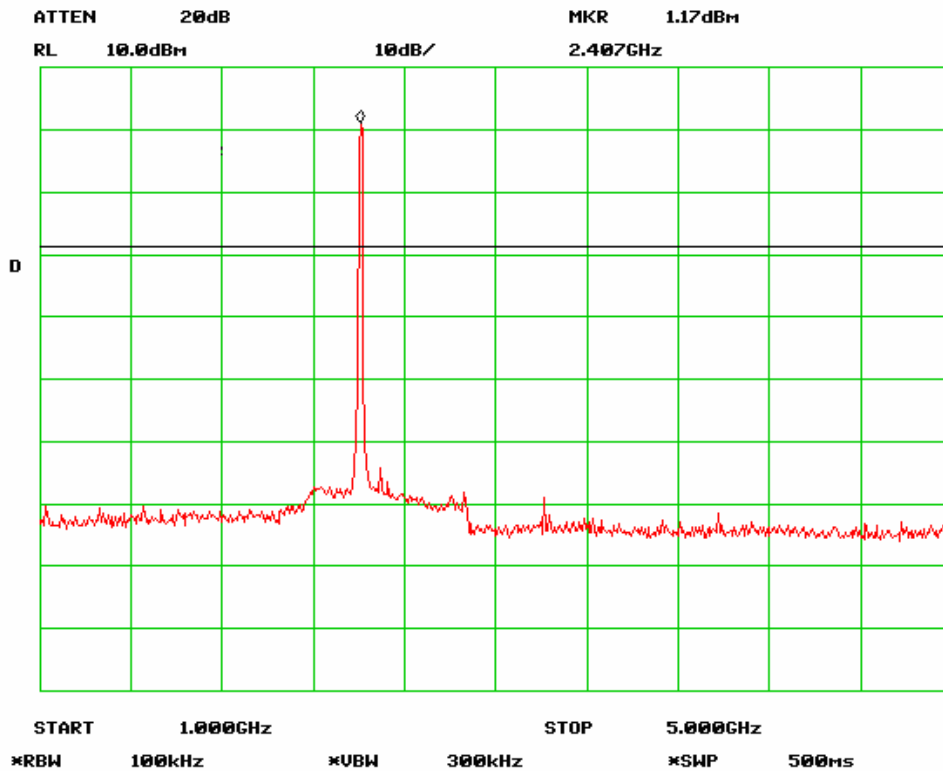

Antenna Port Emission Low Channel -2(802.11b)



SIEMIC, INC.

Accessing global markets

Title: RF Test Report for Wifi Modular
Model: MR100
To: FCC 15.247:2009

Serial#: 10021272
Issue Date: 13 January 2011
Page: 36 of 113
www.siemic.com.cn

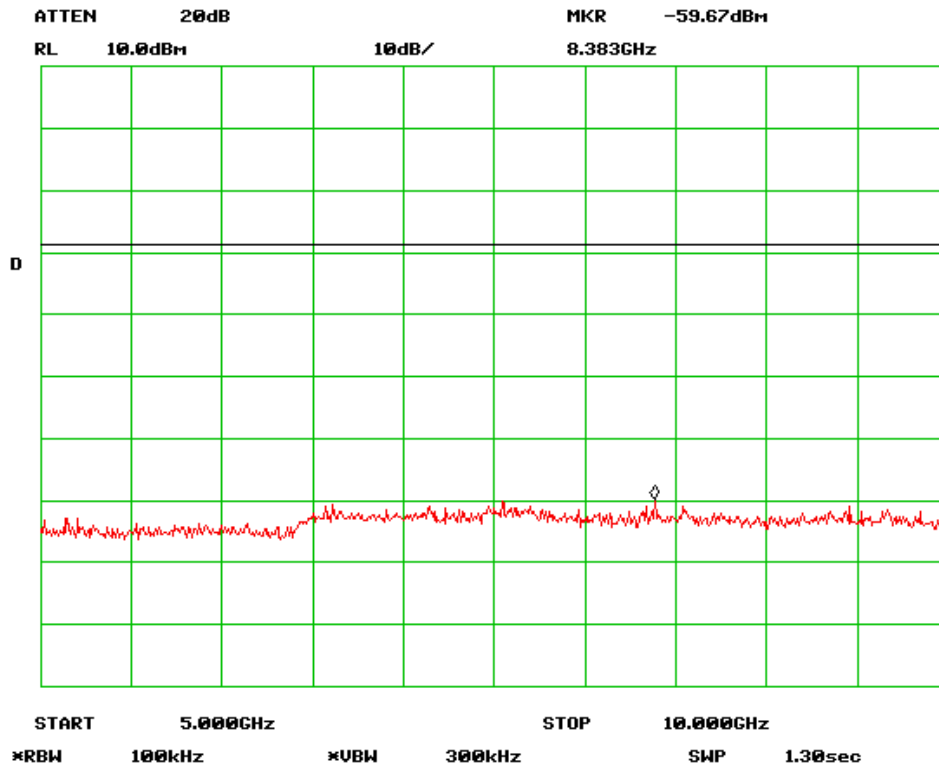

Antenna Port Emission Low Channel -3(802.11b)

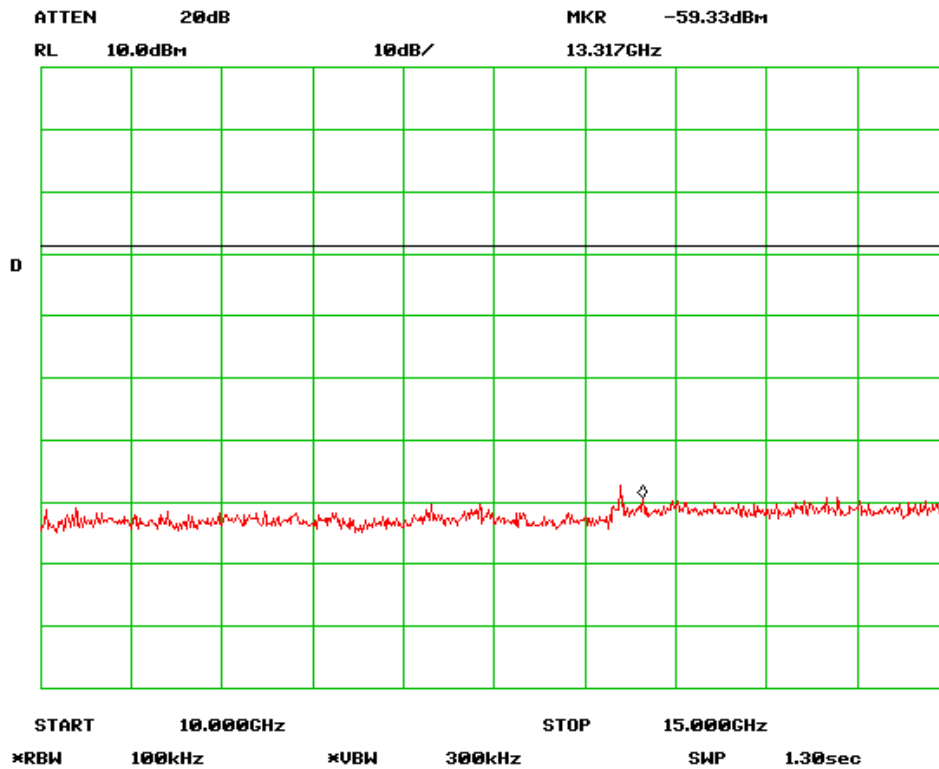

Antenna Port Emission Low Channel -4(802.11b)



SIEMIC, INC.

Accessing global markets

Title: RF Test Report for Wifi Modular
Model: MR100
To: FCC 15.247:2009

Serial#: 10021272
Issue Date: 13 January 2011
Page: 37 of 113
www.siemic.com.cn

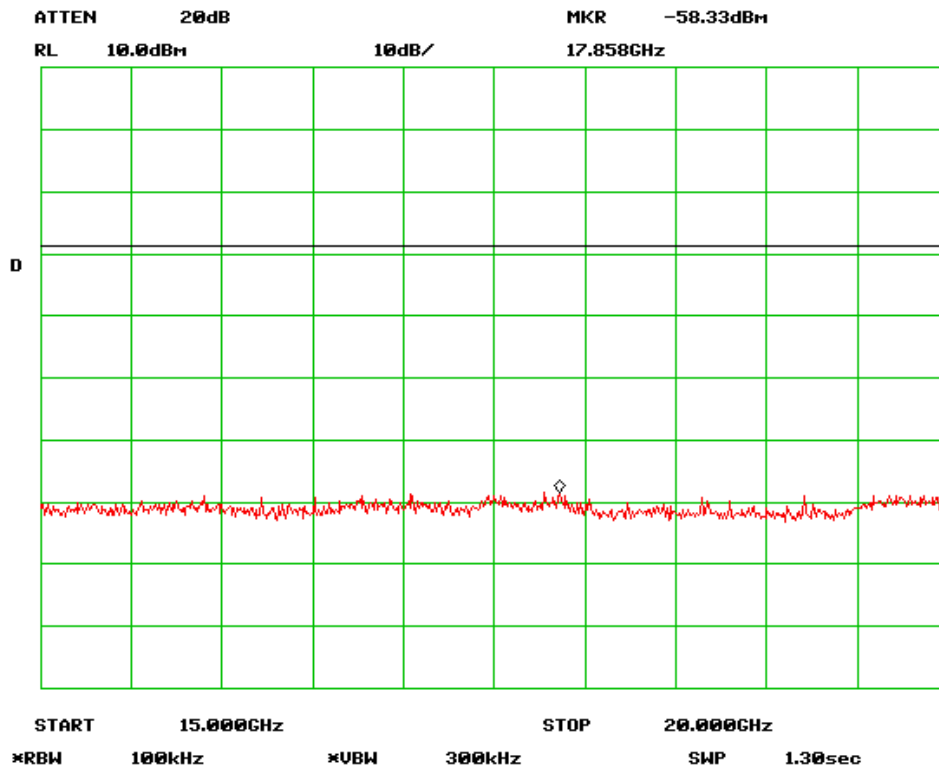

Antenna Port Emission Low Channel -5(802.11b)

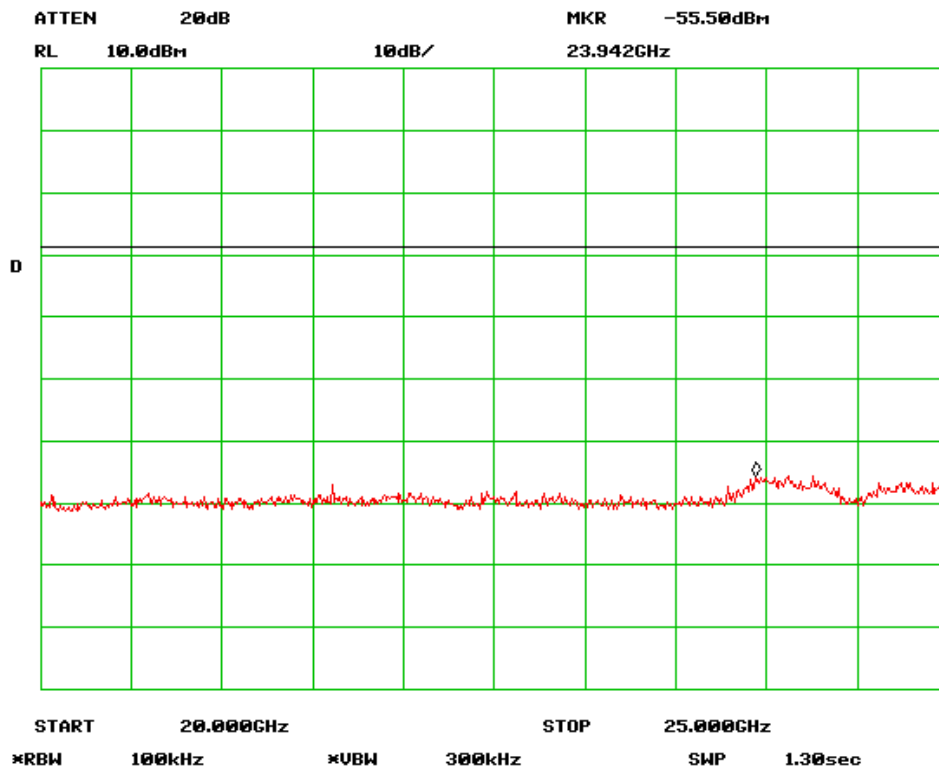

Antenna Port Emission Low Channel -6(802.11b)

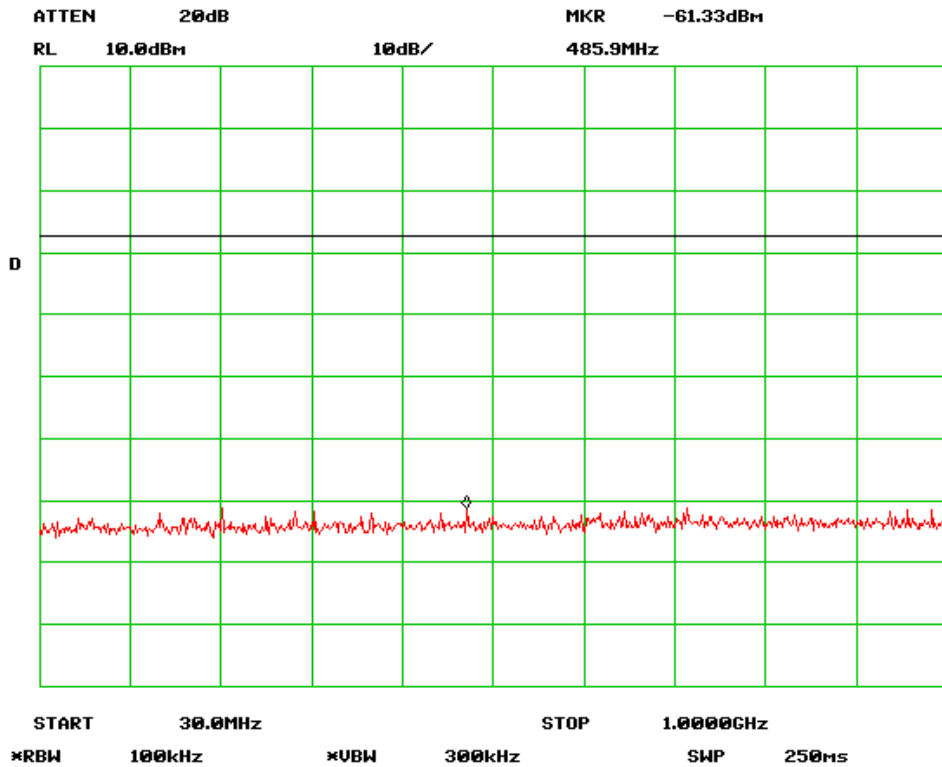

Antenna Port Emission Mid-1 Channel (802.11b)

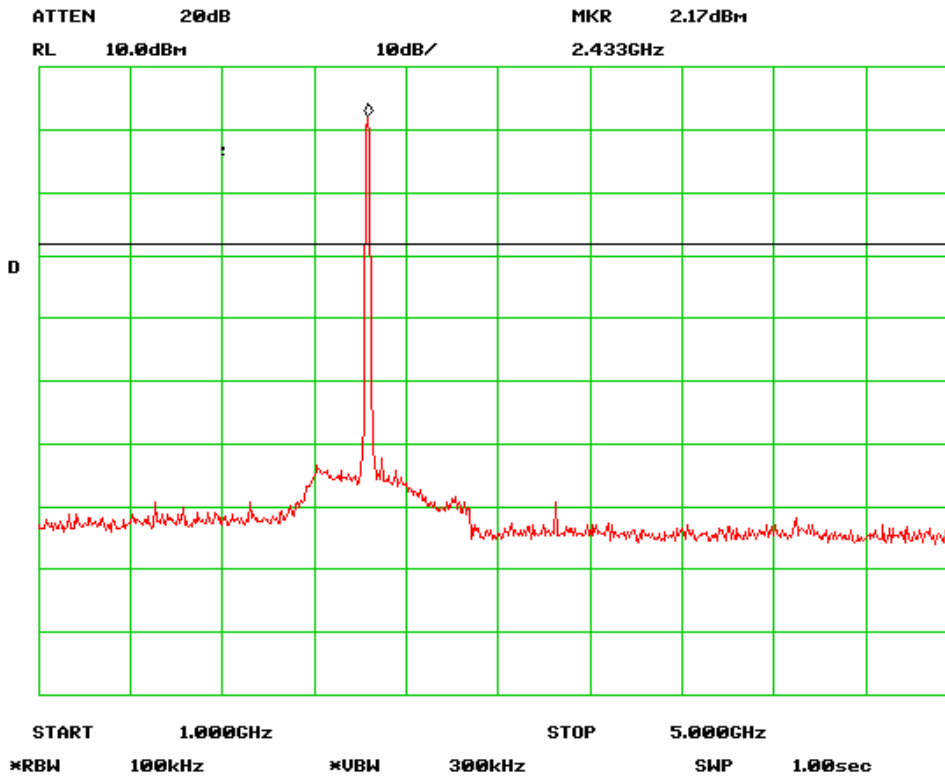

Antenna Port Emission Mid-2 Channel (802.11b)



SIEMIC, INC.

Accessing global markets

Title: RF Test Report for Wifi Modular
Model: MR100
To: FCC 15.247:2009

Serial#: 10021272
Issue Date: 13 January 2011
Page: 39 of 113
www.siemic.com.cn

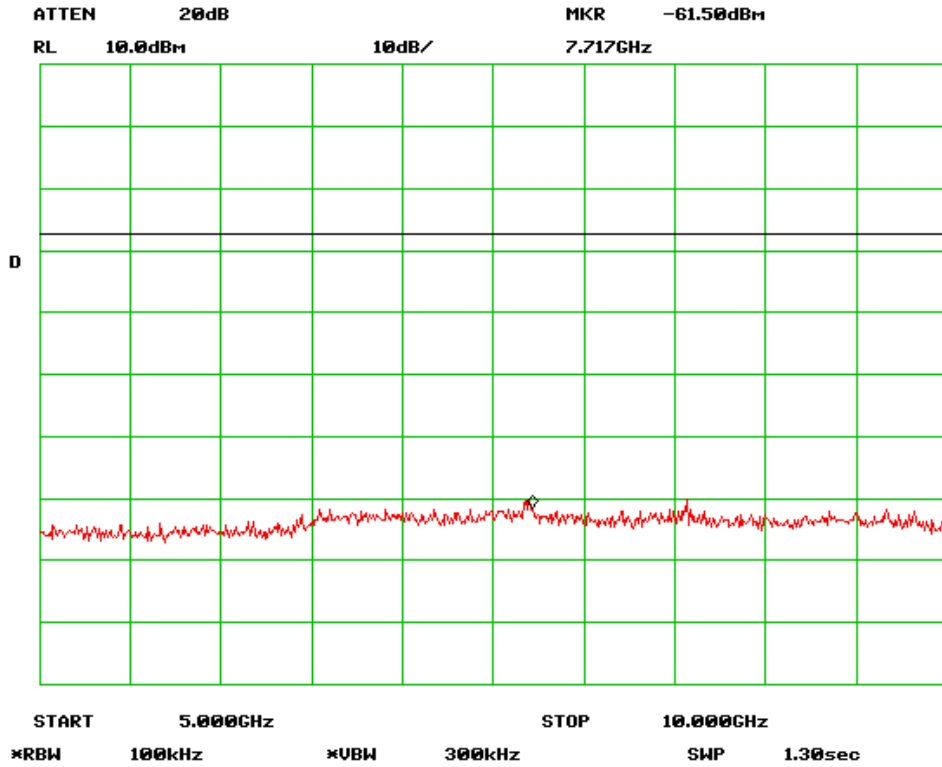

Antenna Port Emission Mid-3 Channel (802.11b)

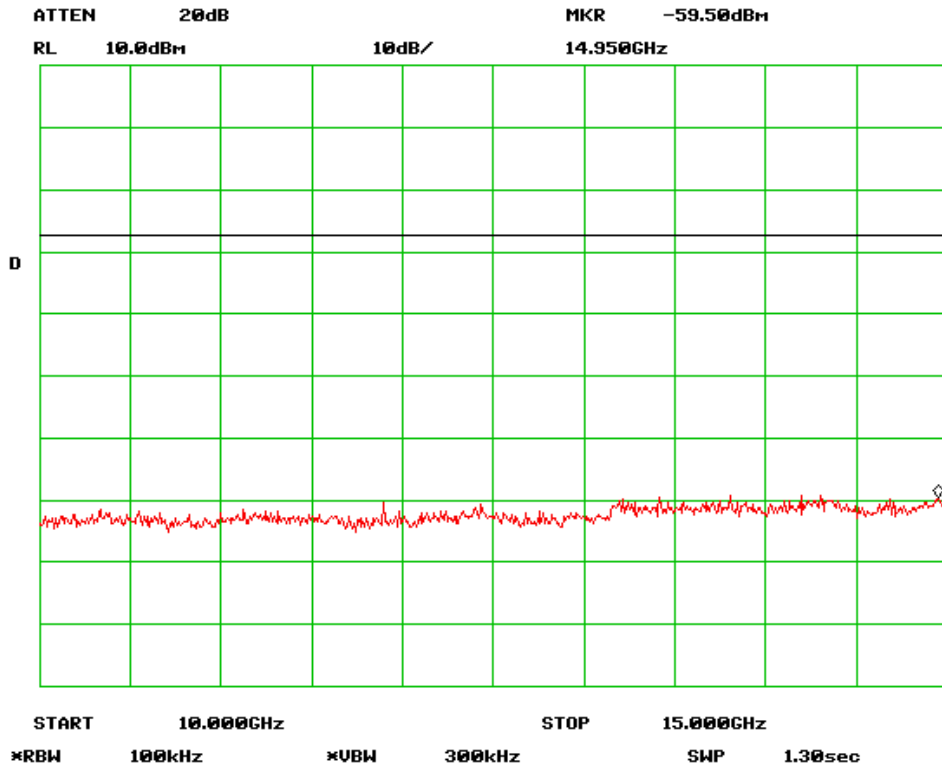

Antenna Port Emission Mid-4 Channel (802.11b)



SIEMIC, Inc.

Accessing global markets

Title: RF Test Report for Wifi Modular
Model: MR100
To: FCC 15.247:2009

Serial#: 10021272
Issue Date: 13 January 2011
Page: 40 of 113
www.siemic.com.cn

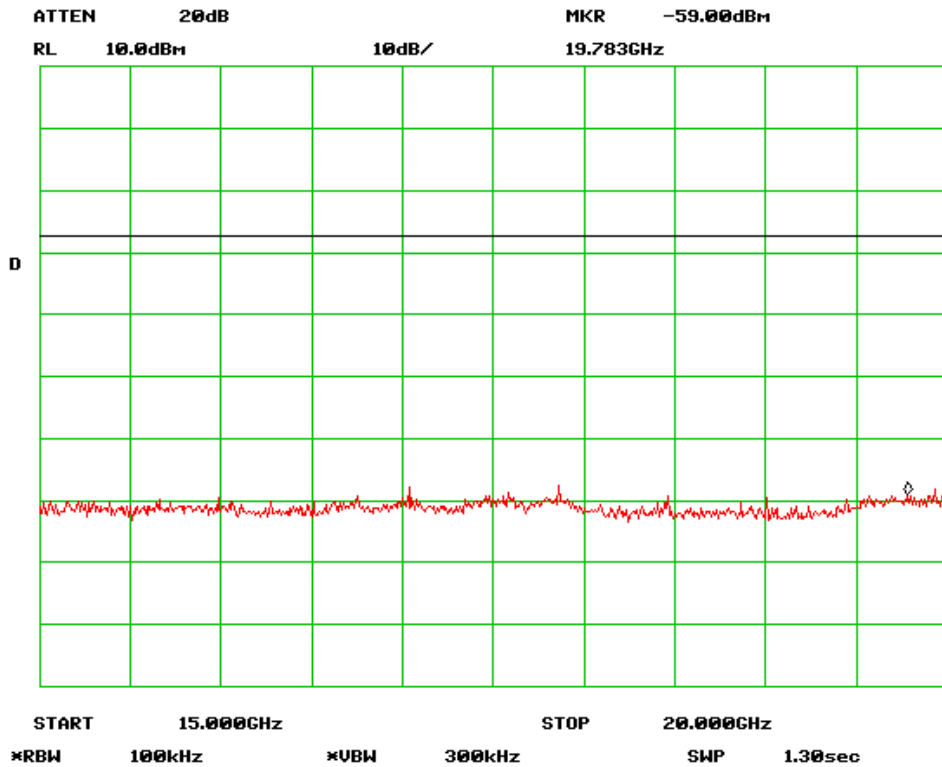

Antenna Port Emission Mid-5 Channel (802.11b)

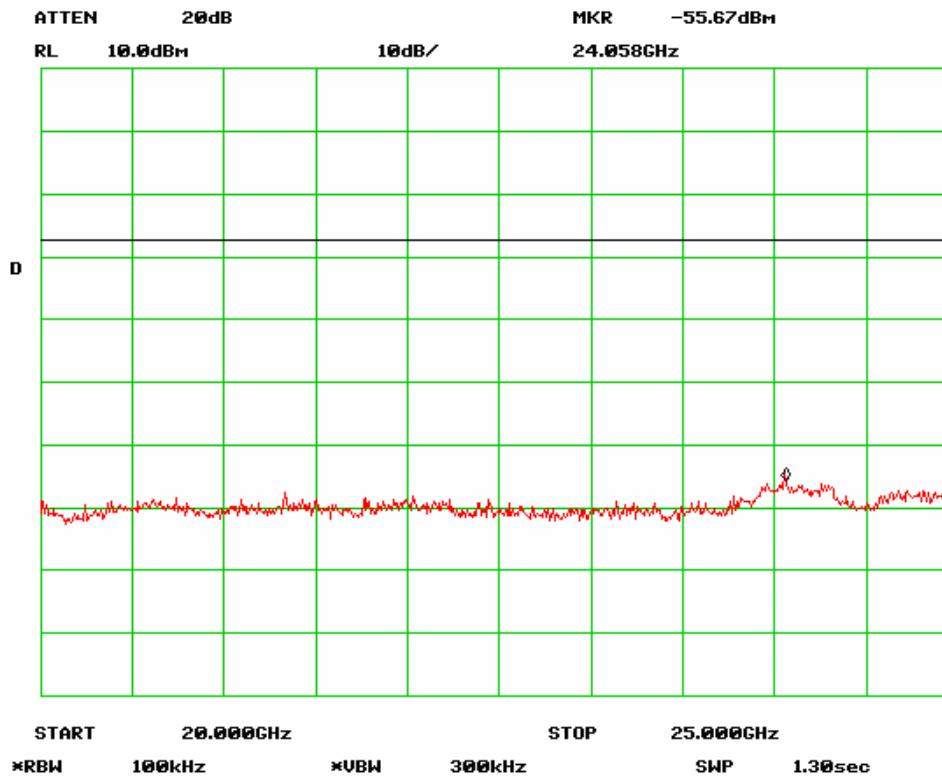

Antenna Port Emission Mid-6 Channel (802.11b)



SIEMIC, INC.

Accessing global markets

Title: RF Test Report for Wifi Modular
Model: MR100
To: FCC 15.247:2009

Serial#: 10021272
Issue Date: 13 January 2011
Page: 41 of 113
www.sieminc.com.cn

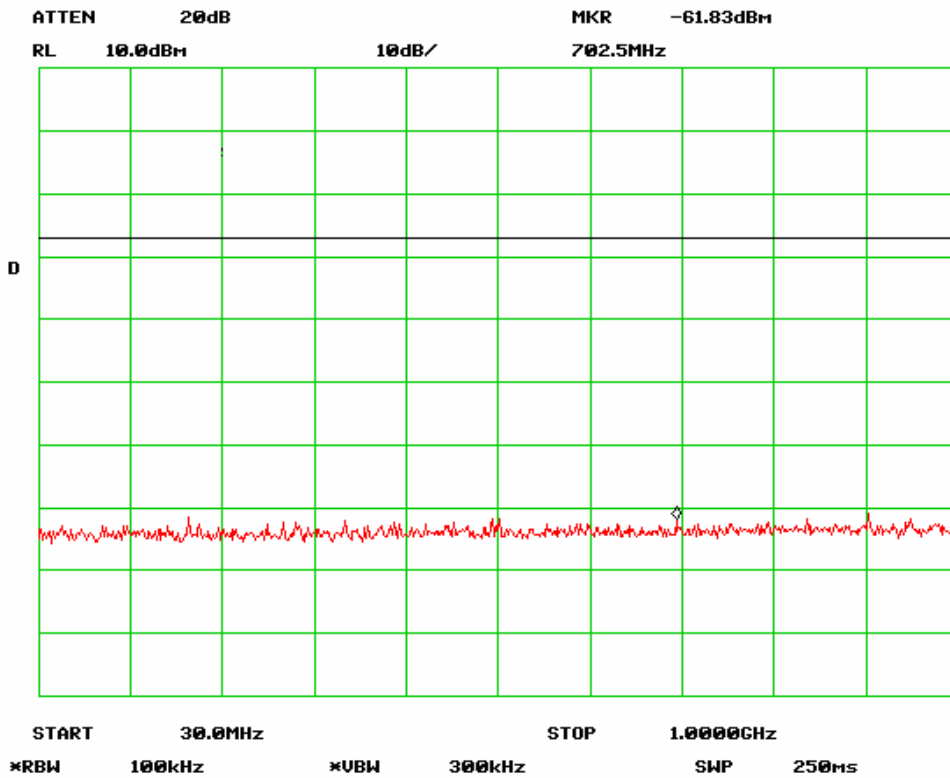

Antenna Port Emission High-1 Channel (802.11b)

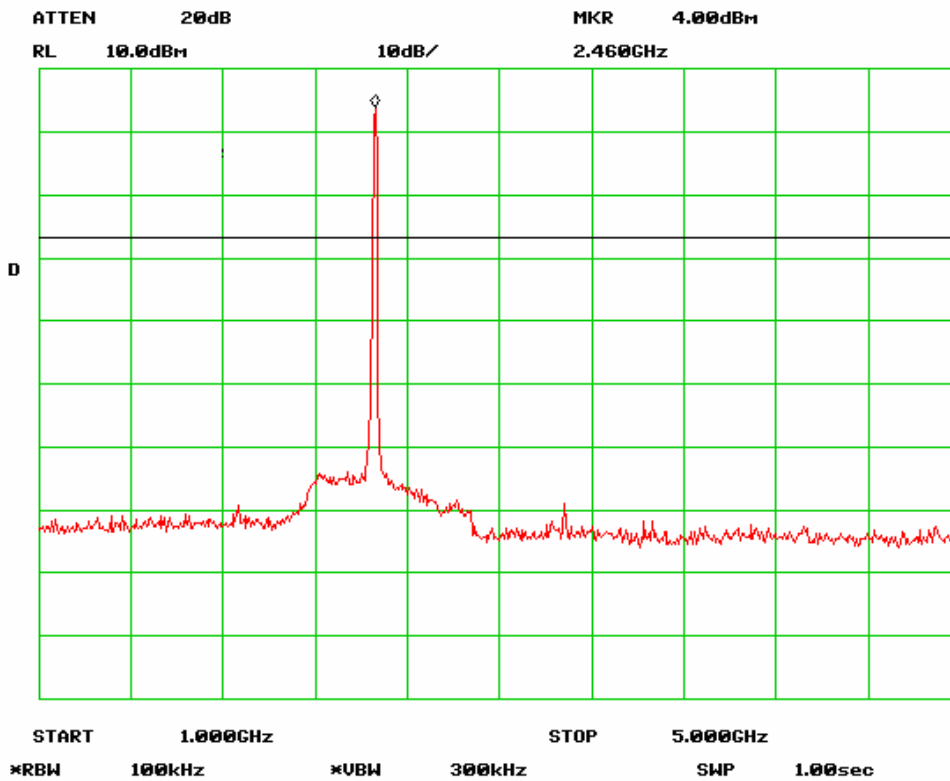

Antenna Port Emission High-2 Channel (802.11b)

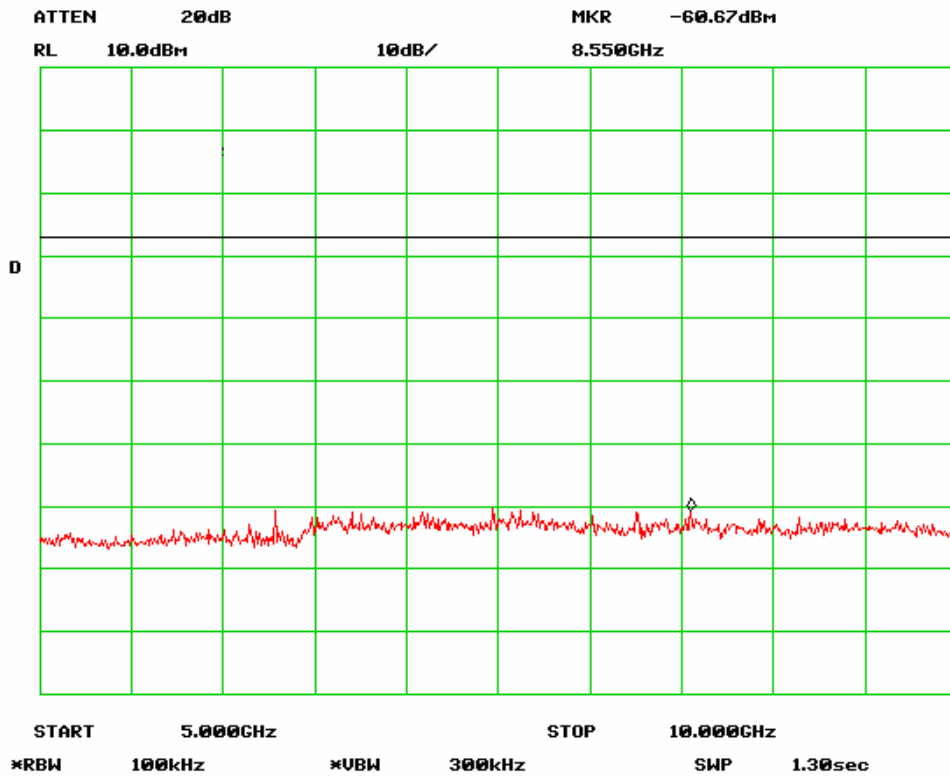

Antenna Port Emission High-3 Channel (802.11b)

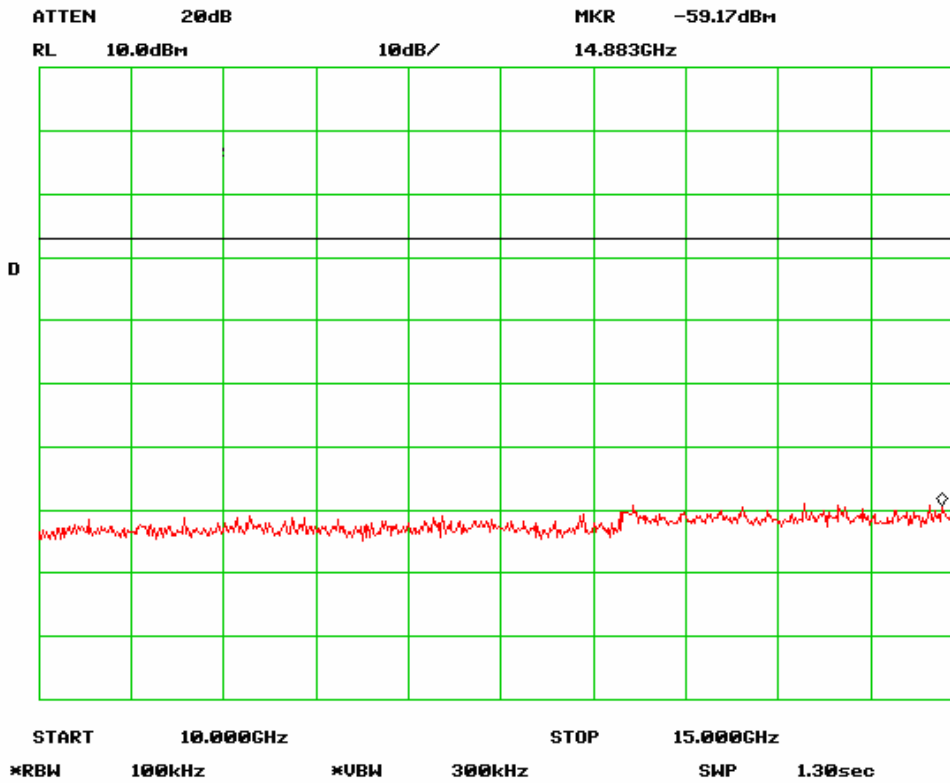

Antenna Port Emission High-4 Channel (802.11b)



SIEMIC, INC.

Accessing global markets

Title: RF Test Report for Wifi Modular
Model: MR100
To: FCC 15.247:2009

Serial#: 10021272
Issue Date: 13 January 2011
Page: 43 of 113
www.siemic.com.cn

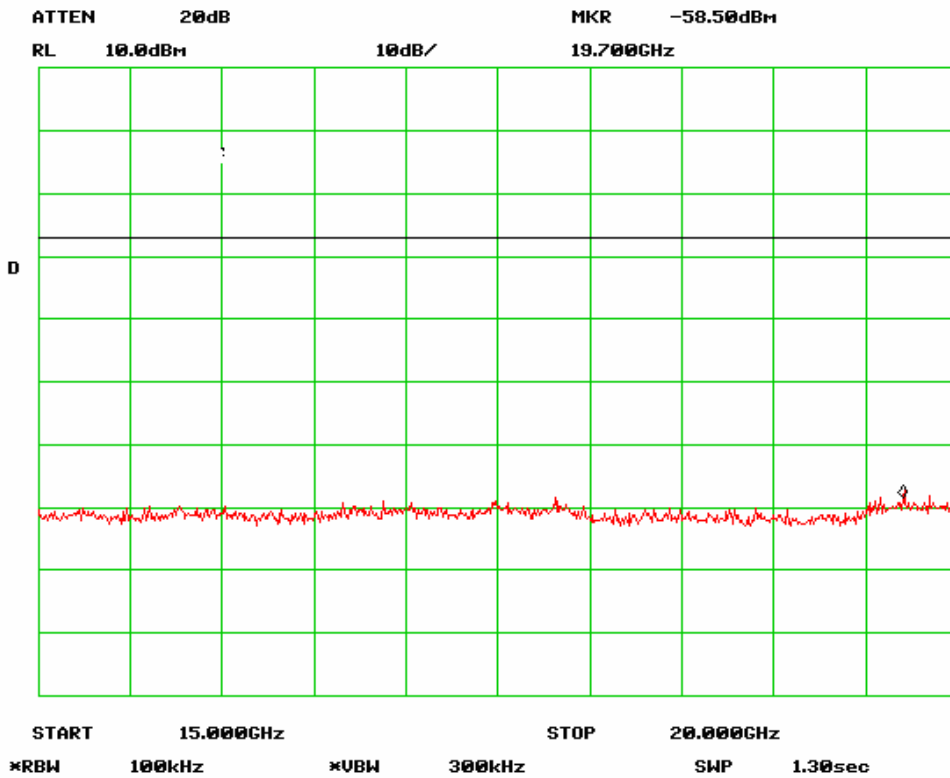

Antenna Port Emission High-5 Channel (802.11b)

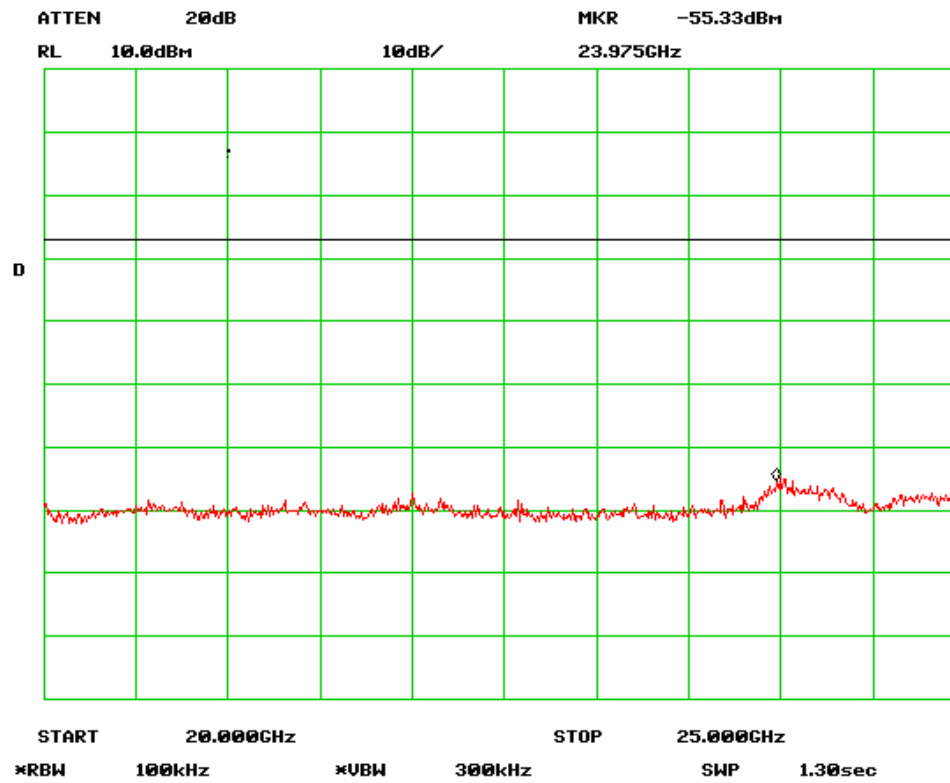

Antenna Port Emission High-6 Channel (802.11b)

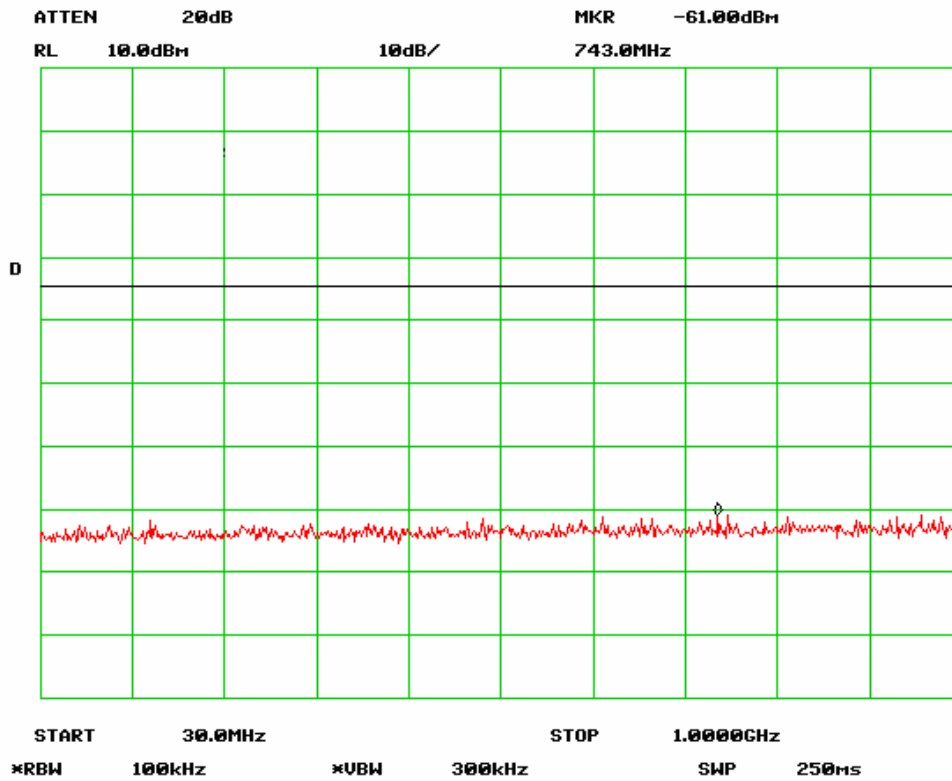

Antenna Port Emission Low-1 Channel (802.11g)

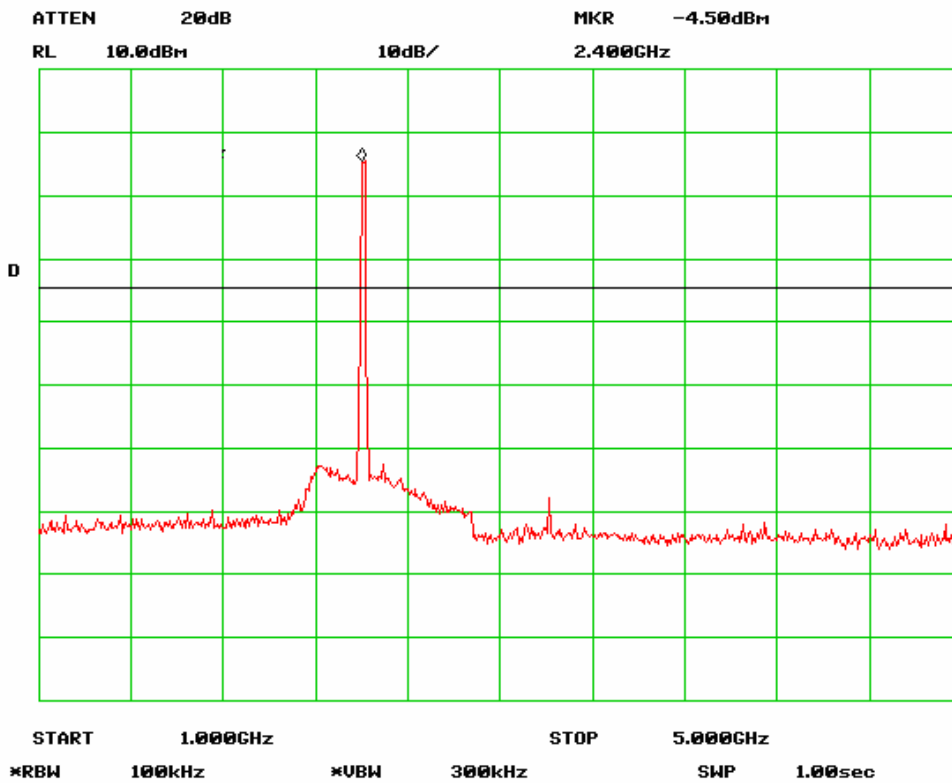

Antenna Port Emission Low-2 Channel (802.11g)



SIEMIC, Inc.

Accessing global markets

Title: RF Test Report for Wifi Modular
Model: MR100
To: FCC 15.247:2009

Serial#: 10021272
Issue Date: 13 January 2011
Page: 45 of 113
www.siemec.com.cn

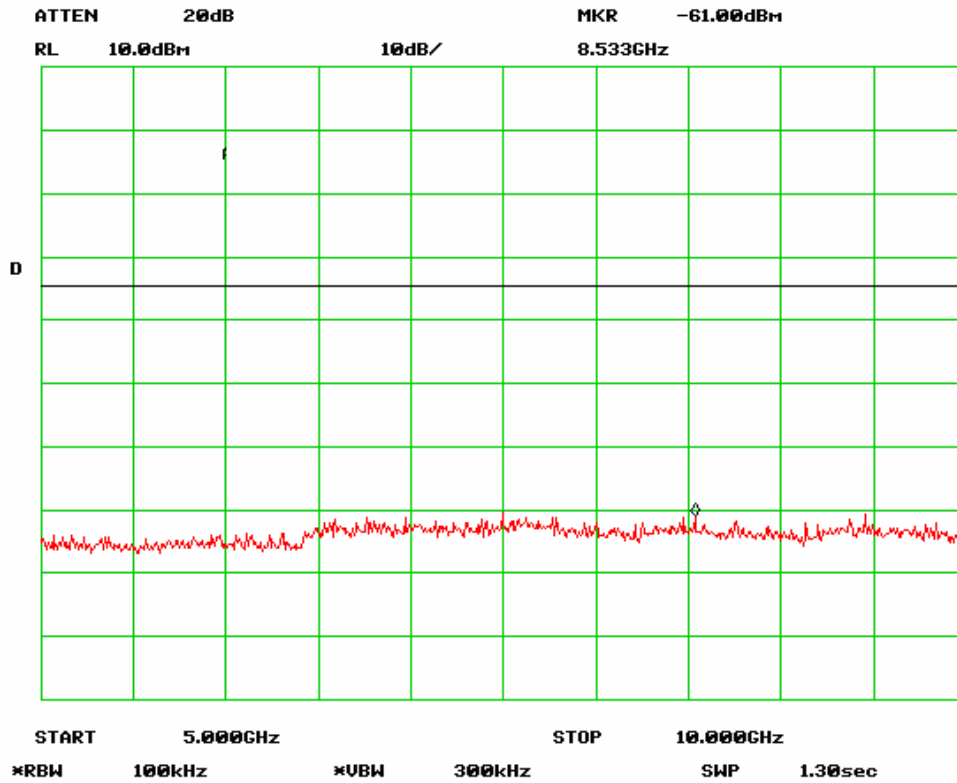

Antenna Port Emission Low-3 Channel (802.11g)

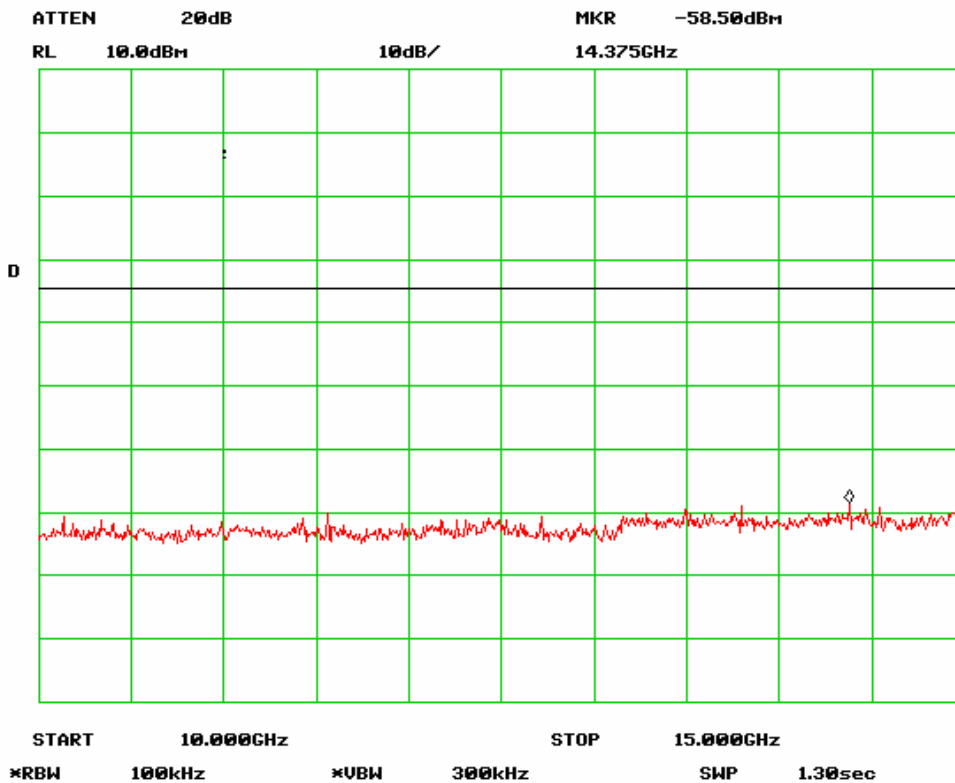

Antenna Port Emission Low-4 Channel (802.11g)

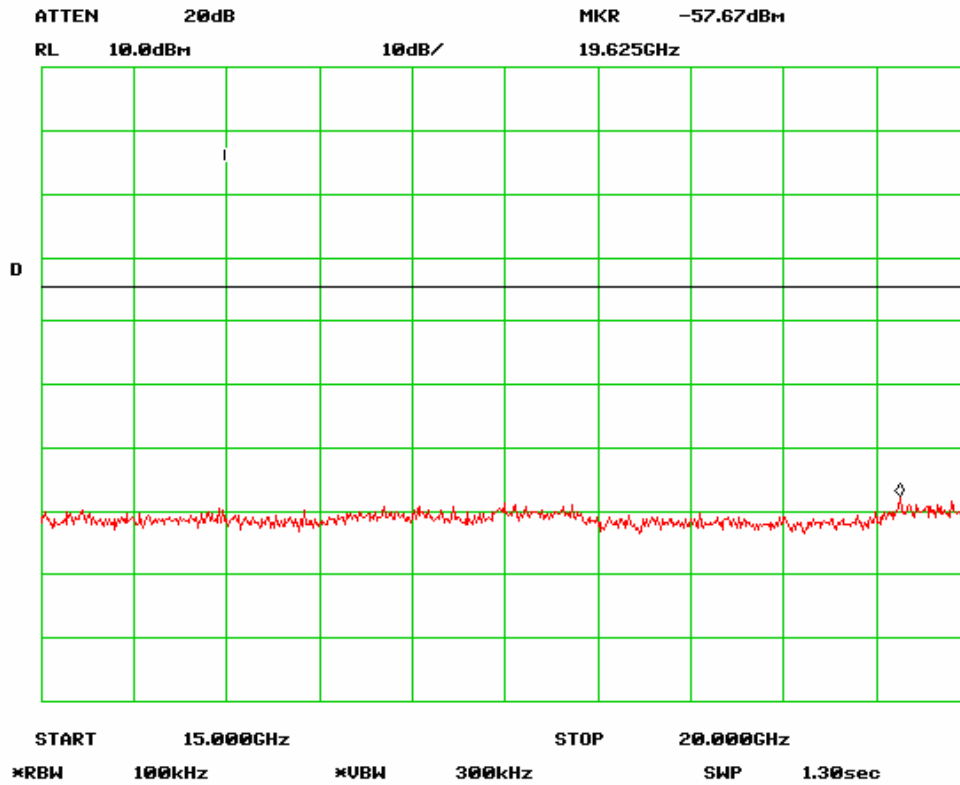

Antenna Port Emission Low-5 Channel (802.11g)

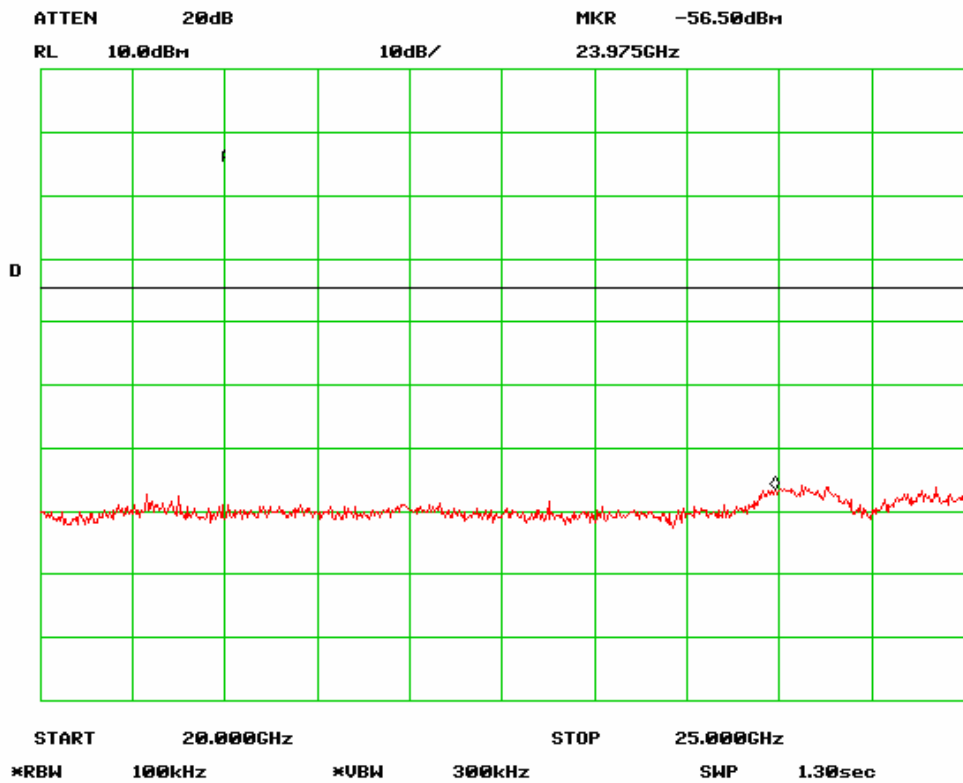

Antenna Port Emission Low-6 Channel (802.11g)



SIEMIC, INC.

Accessing global markets

Title: RF Test Report for Wifi Modular
Model: MR100
To: FCC 15.247:2009

Serial#: 10021272
Issue Date: 13 January 2011
Page: 47 of 113
www.siemic.com.cn

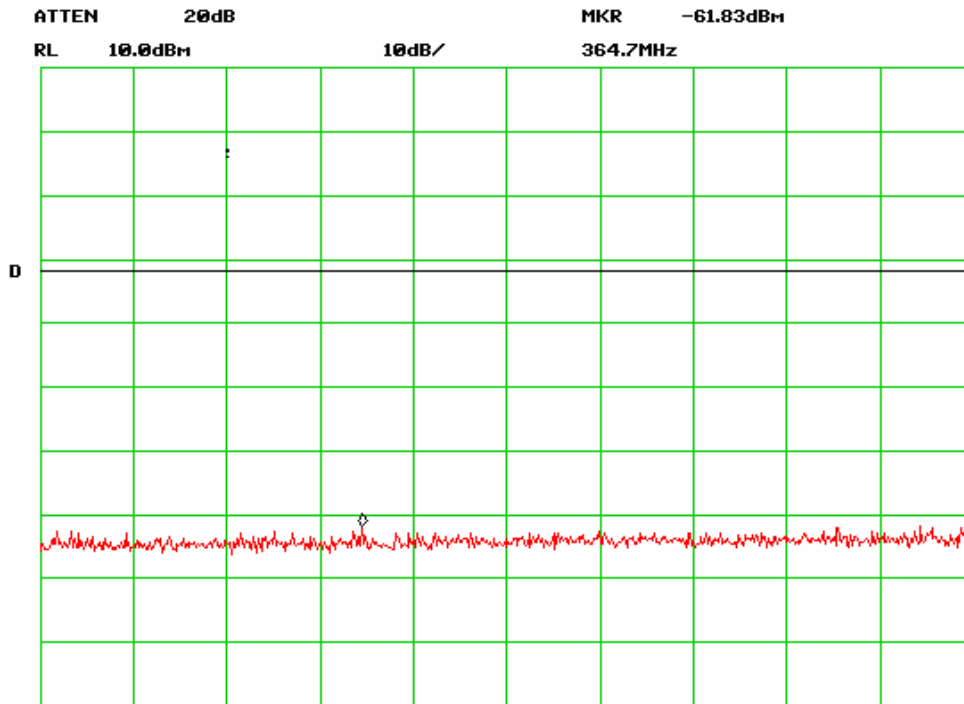

Antenna Port Emission Mid-1 Channel (802.11g)

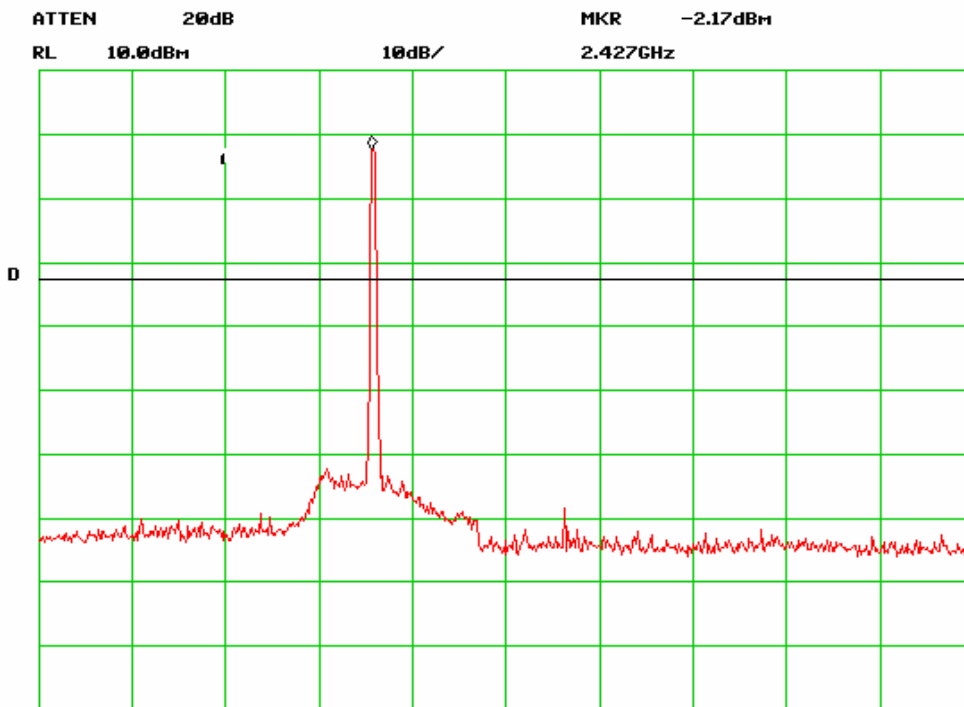

Antenna Port Emission Mid-2 Channel (802.11g)



SIEMIC, Inc.

Accessing global markets

Title: RF Test Report for Wifi Modular
Model: MR100
To: FCC 15.247:2009

Serial#: 10021272
Issue Date: 13 January 2011
Page: 48 of 113
www.siemec.com.cn

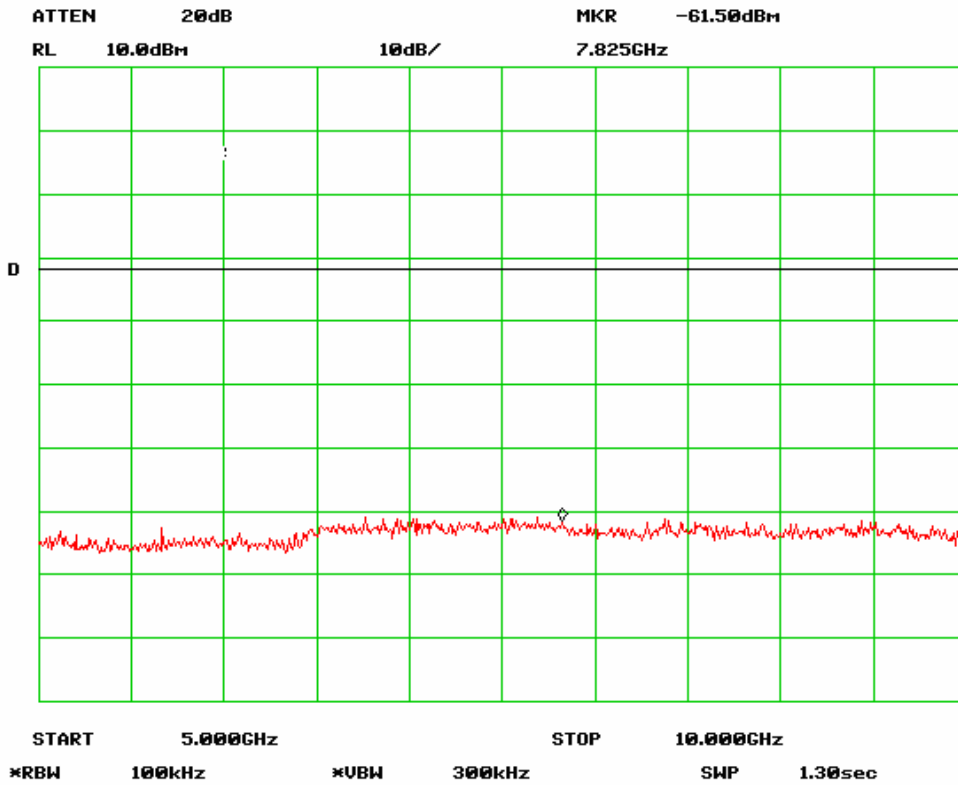

Antenna Port Emission Mid-3 Channel (802.11g)

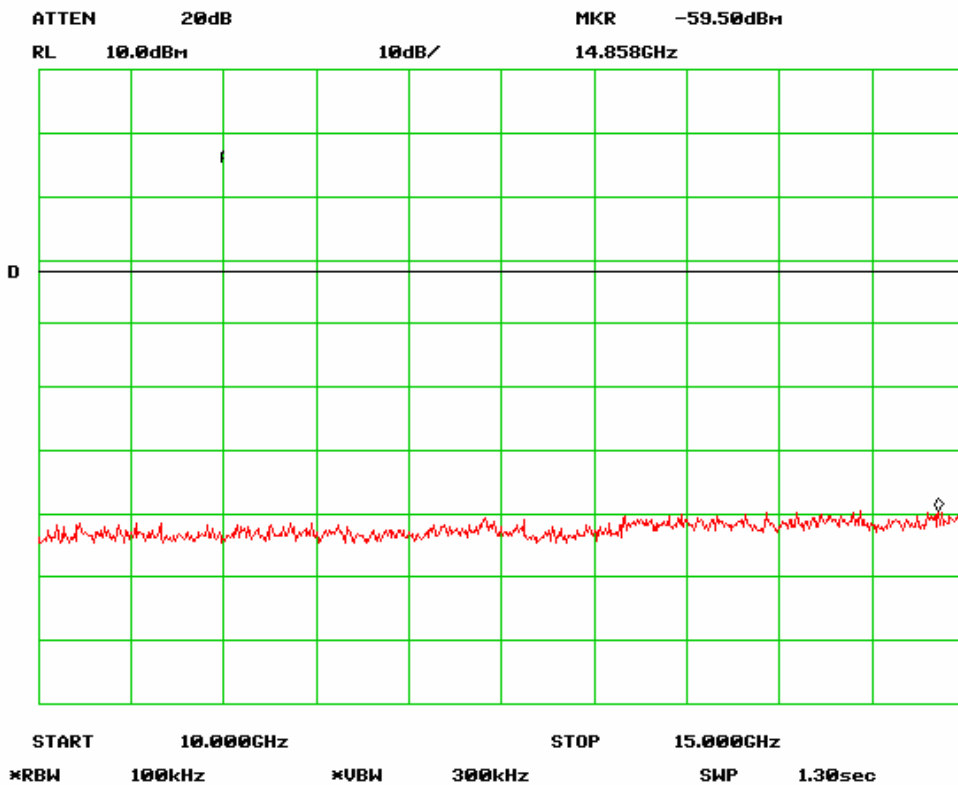

Antenna Port Emission Mid-4 Channel (802.11g)



SIEMIC, INC.

Accessing global markets

Title: RF Test Report for Wifi Modular
Model: MR100
To: FCC 15.247:2009

Serial#: 10021272
Issue Date: 13 January 2011
Page: 49 of 113
www.siemic.com.cn

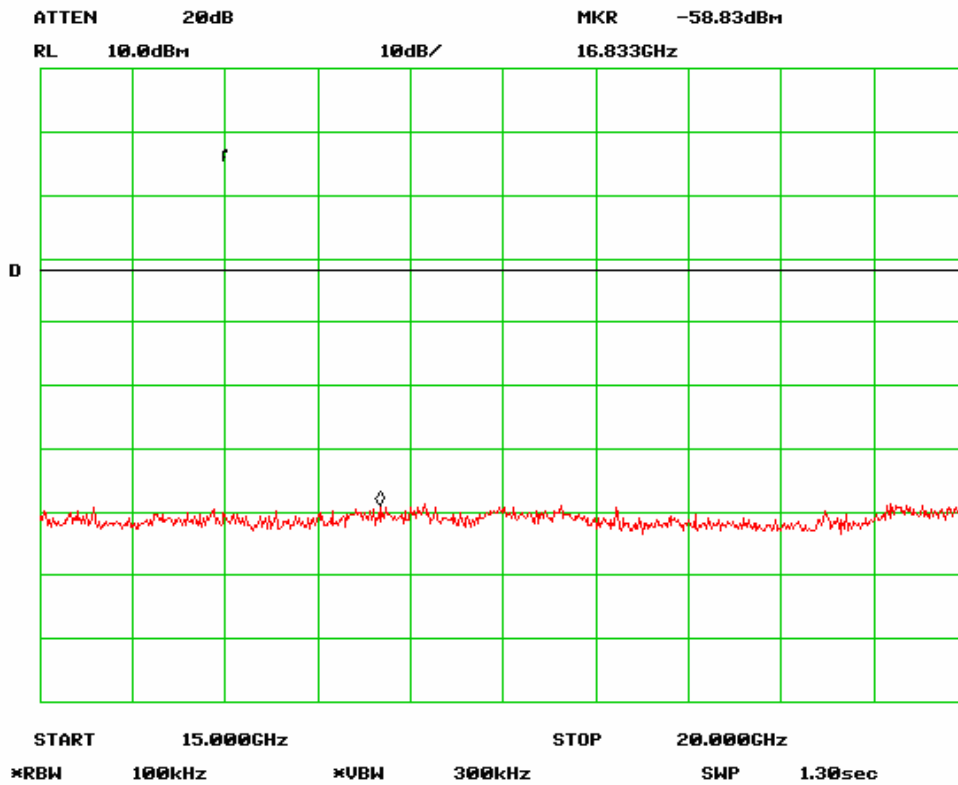

Antenna Port Emission Mid-5 Channel (802.11g)

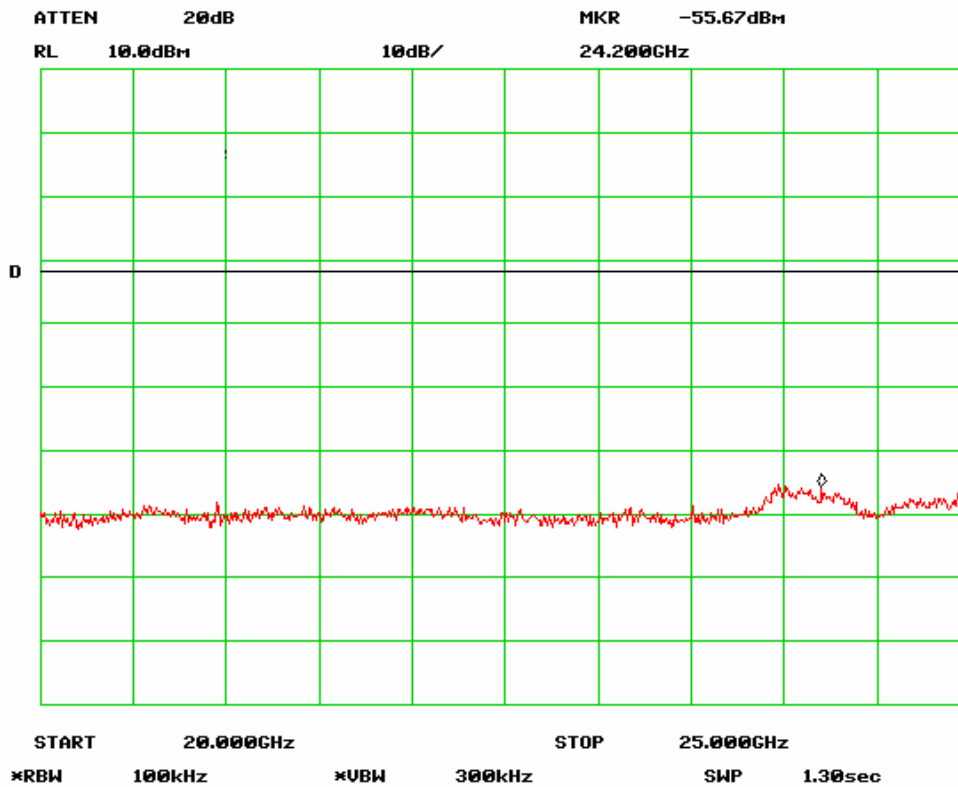

Antenna Port Emission Mid-6 Channel (802.11g)

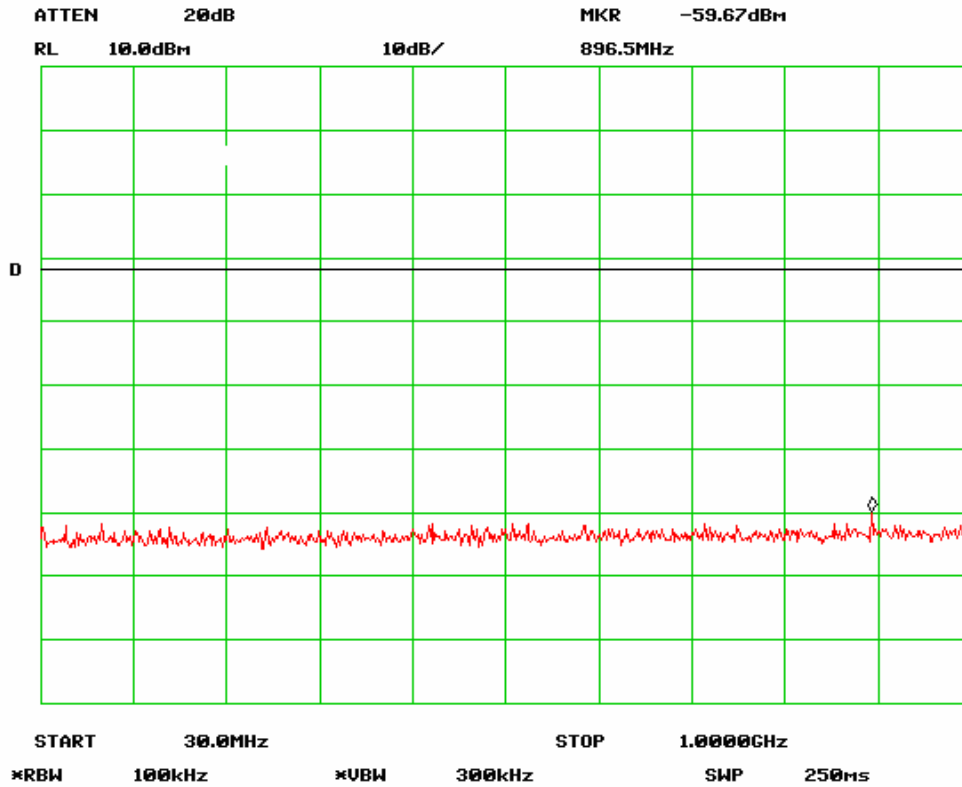

Antenna Port Emission High-1 Channel (802.11g)

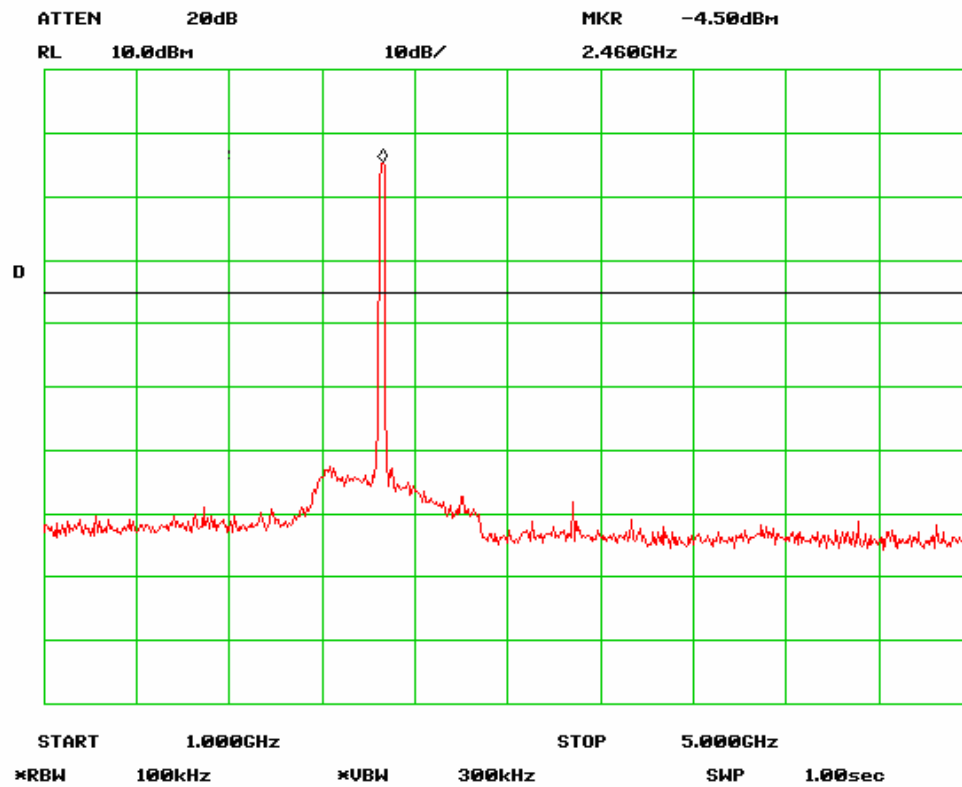

Antenna Port Emission High-2 Channel (802.11g)

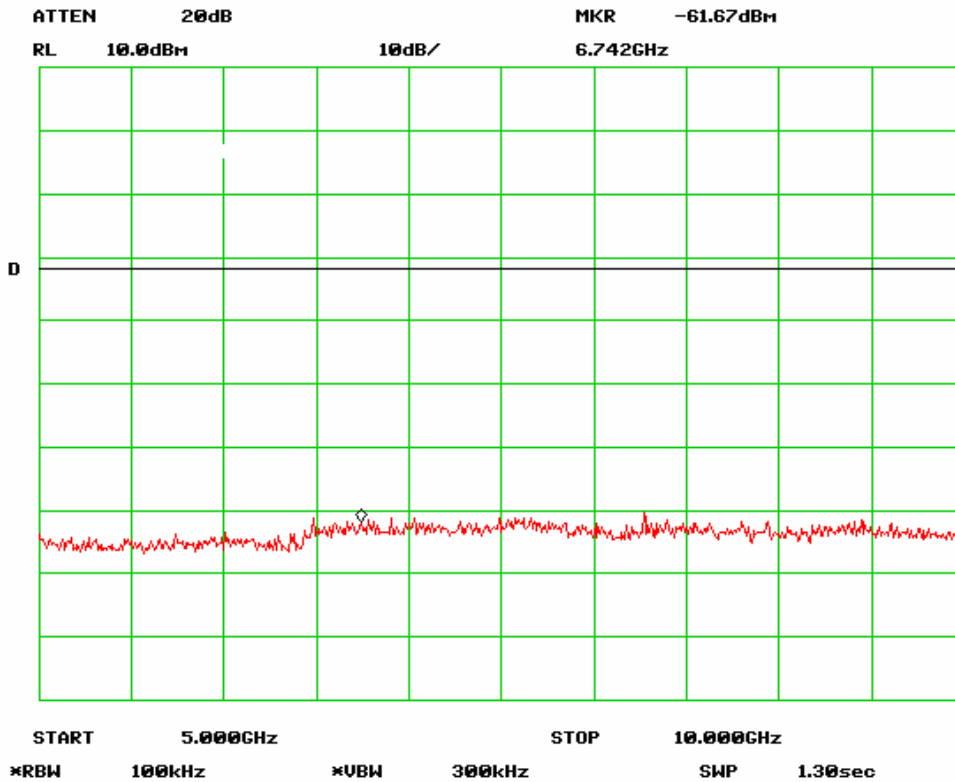

Antenna Port Emission High-3 Channel (802.11g)

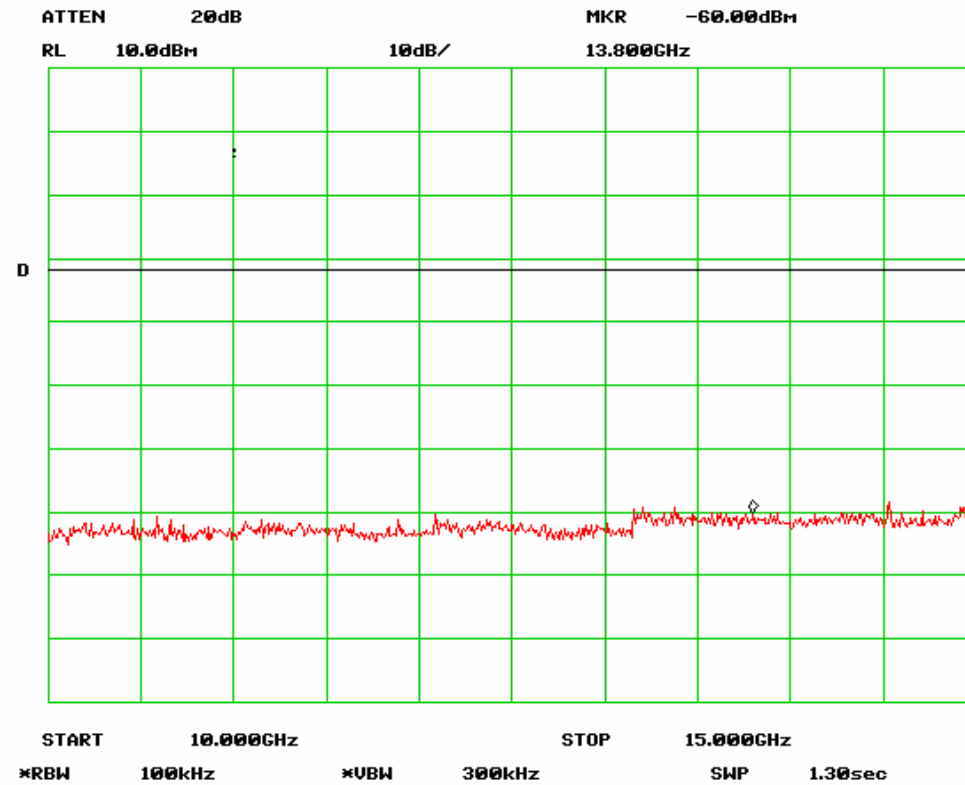

Antenna Port Emission High-4 Channel (802.11g)



SIEMIC, INC.

Accessing global markets

Title: RF Test Report for Wifi Modular
Model: MR100
To: FCC 15.247:2009

Serial#: 10021272
Issue Date: 13 January 2011
Page: 52 of 113
www.siemic.com.cn

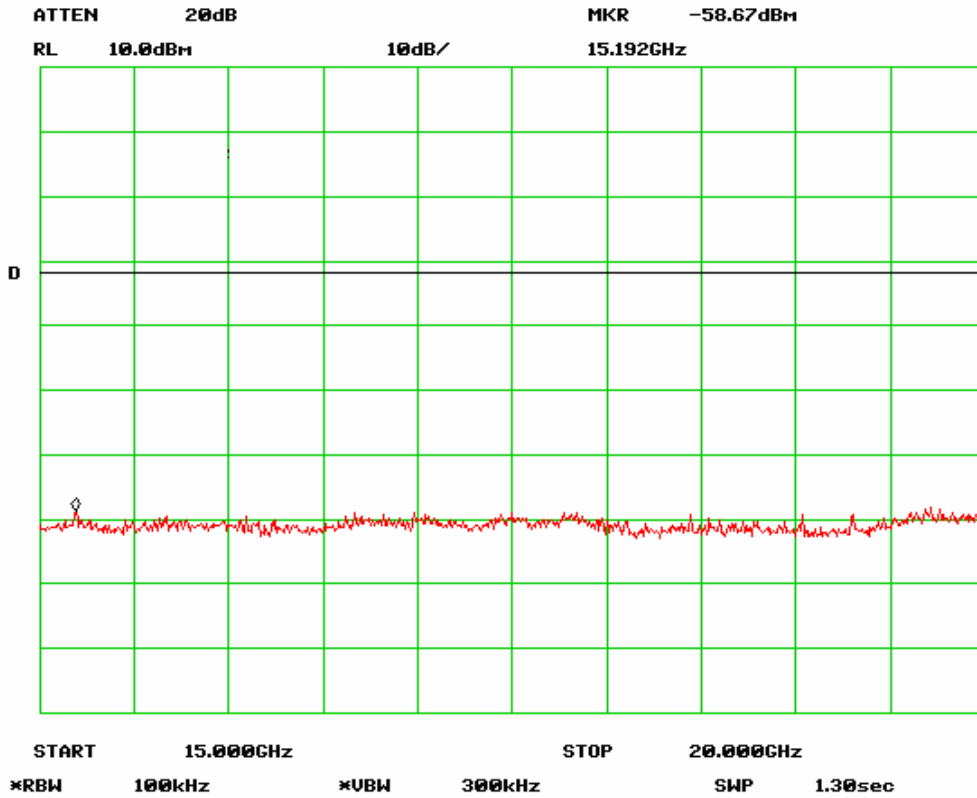

Antenna Port Emission High-5 Channel (802.11g)

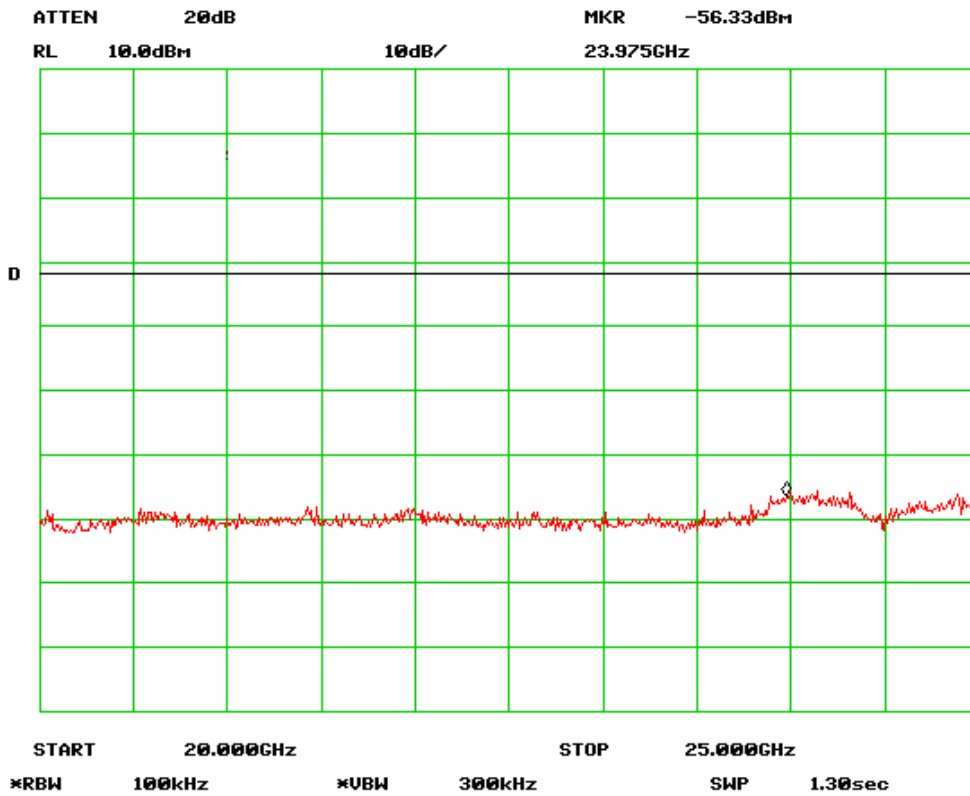

Antenna Port Emission High-6 Channel (802.11g)



SIEMIC, INC.

Accessing global markets

Title: RF Test Report for Wifi Modular
Model: MR100
To: FCC 15.247:2009

Serial#: 10021272
Issue Date: 13 January 2011
Page: 53 of 113
www.siemic.com.cn

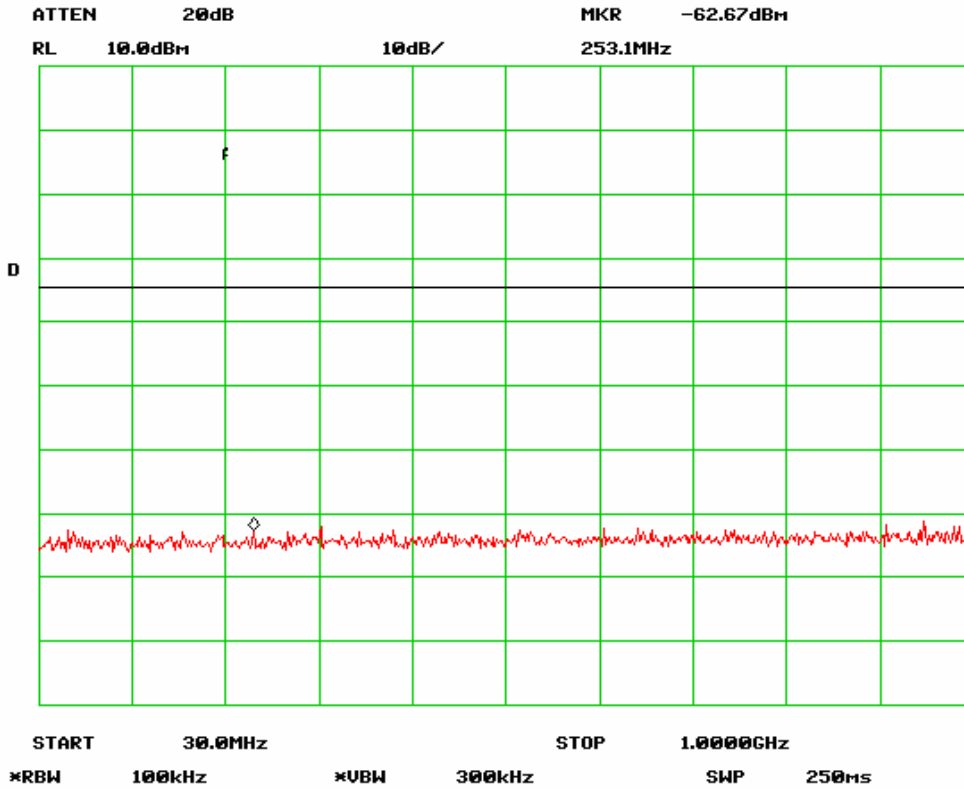

Antenna Port Emission Low-1 Channel (802.11n 20MHz)

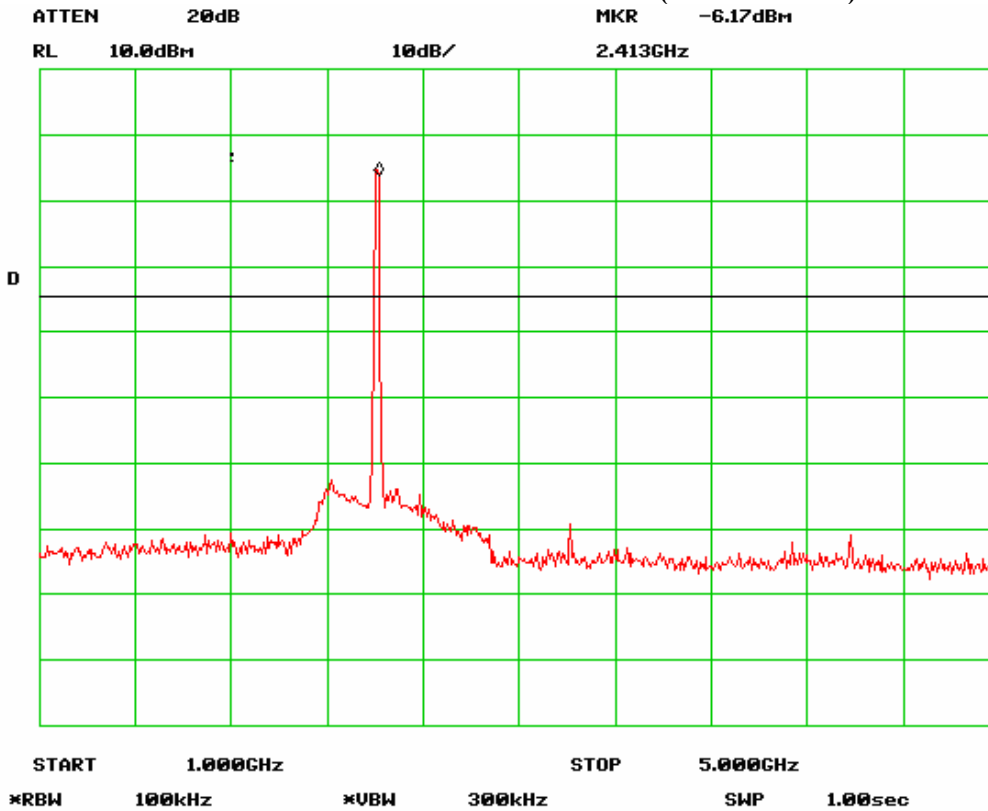

Antenna Port Emission Low-2 Channel (802.11n 20MHz)

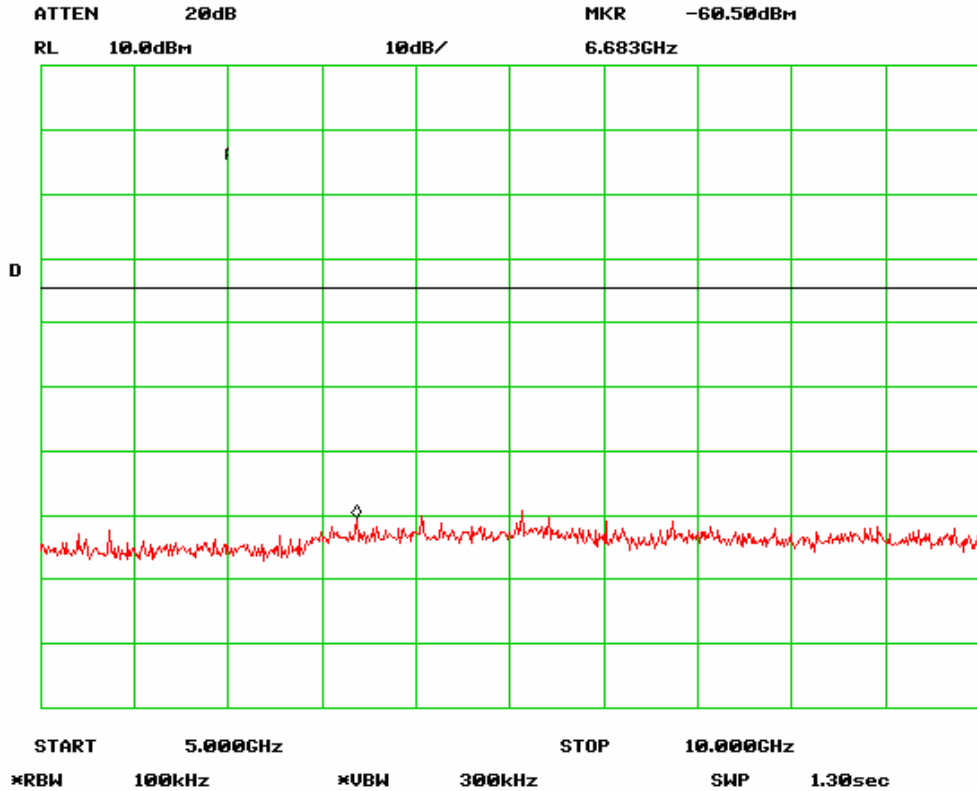

Antenna Port Emission Low-3 Channel (802.11n 20MHz)

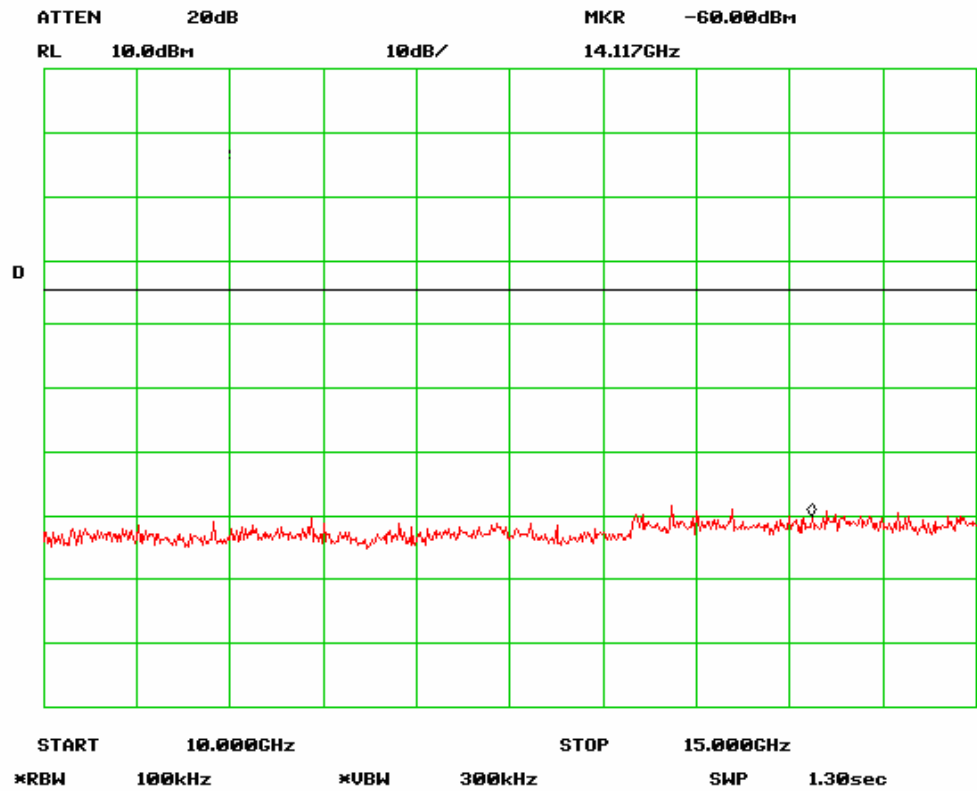

Antenna Port Emission Low-4 Channel (802.11n 20MHz)



SIEMIC, INC.

Accessing global markets

Title: RF Test Report for Wifi Modular
Model: MR100
To: FCC 15.247:2009

Serial#: 10021272
Issue Date: 13 January 2011
Page: 55 of 113
www.siemic.com.cn

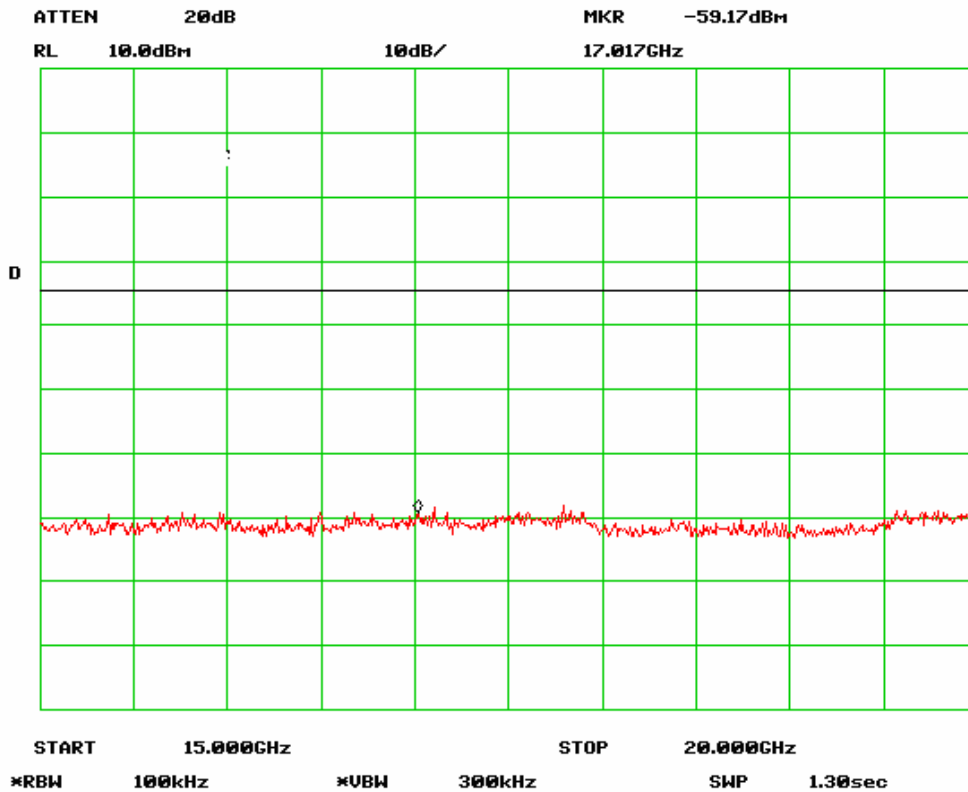

Antenna Port Emission Low-5 Channel (802.11n 20MHz)

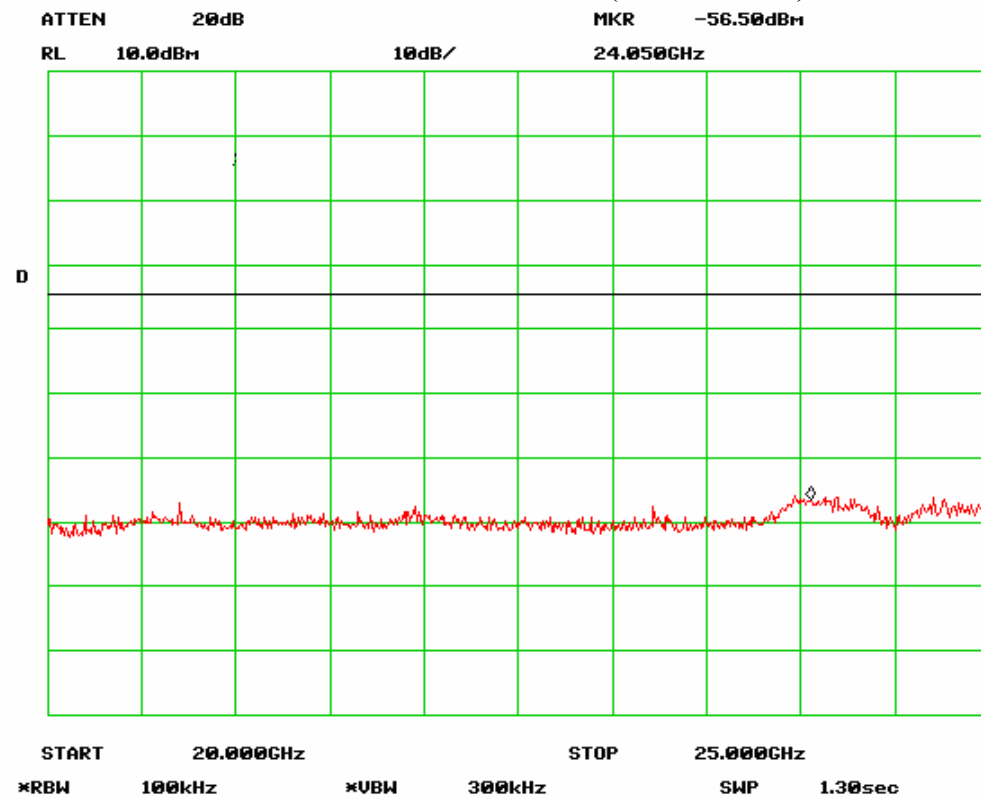

Antenna Port Emission Low-6 Channel (802.11n 20MHz)



SIEMIC, INC.

Accessing global markets

Title: RF Test Report for Wifi Modular
Model: MR100
To: FCC 15.247:2009

Serial#: 10021272
Issue Date: 13 January 2011
Page: 56 of 113
www.siemec.com.cn

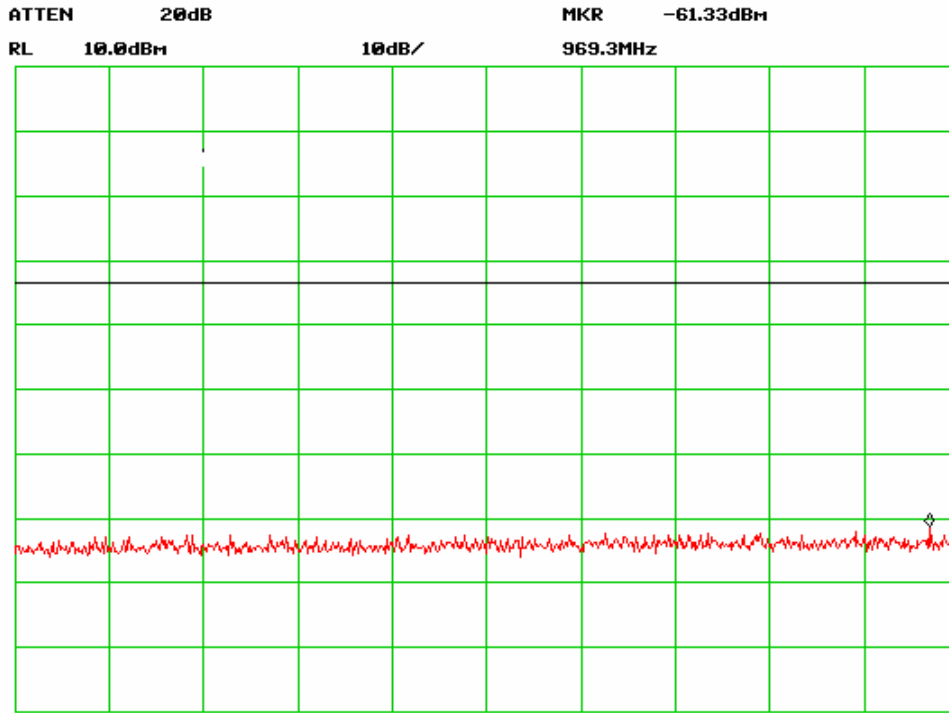

START 30.0MHz **STOP 1.0000GHz**
***RBW 100kHz** ***UBW 300kHz** **SWP 250ms**

Antenna Port Emission Mid-1 Channel (802.11n 20MHz)

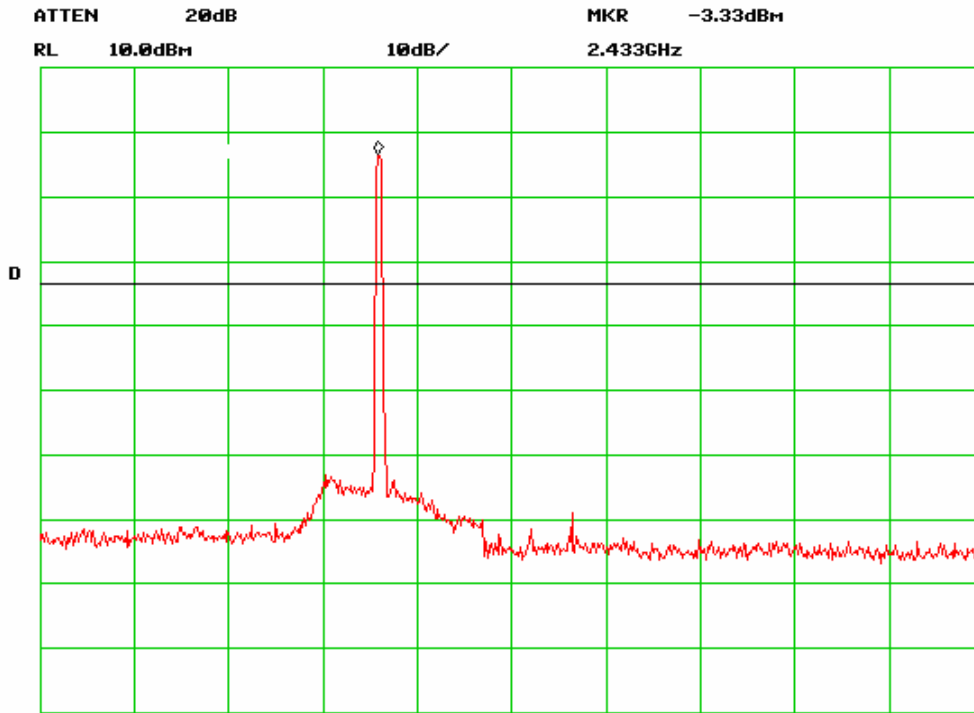

START 1.000GHz **STOP 5.000GHz**
***RBW 100kHz** ***UBW 300kHz** **SWP 1.00sec**

Antenna Port Emission Mid-2 Channel (802.11n 20MHz)



SIEMIC, INC.

Accessing global markets

Title: RF Test Report for Wifi Modular
Model: MR100
To: FCC 15.247:2009

Serial#: 10021272
Issue Date: 13 January 2011
Page: 57 of 113
www.siemic.com.cn

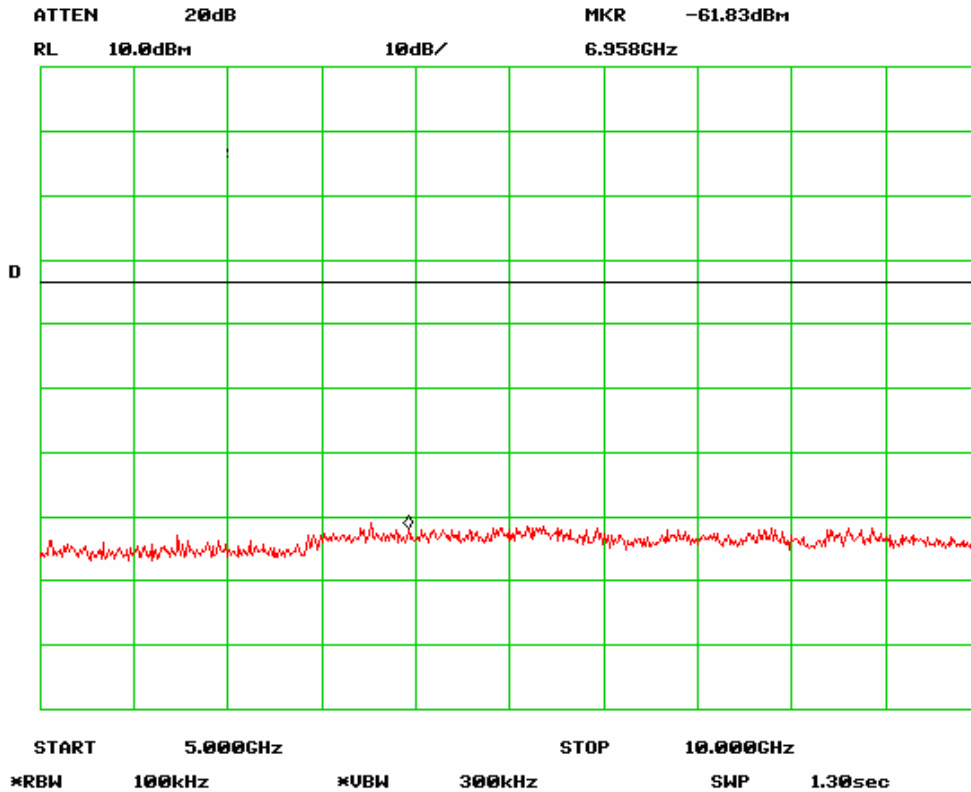

Antenna Port Emission Mid-3 Channel (802.11n 20MHz)

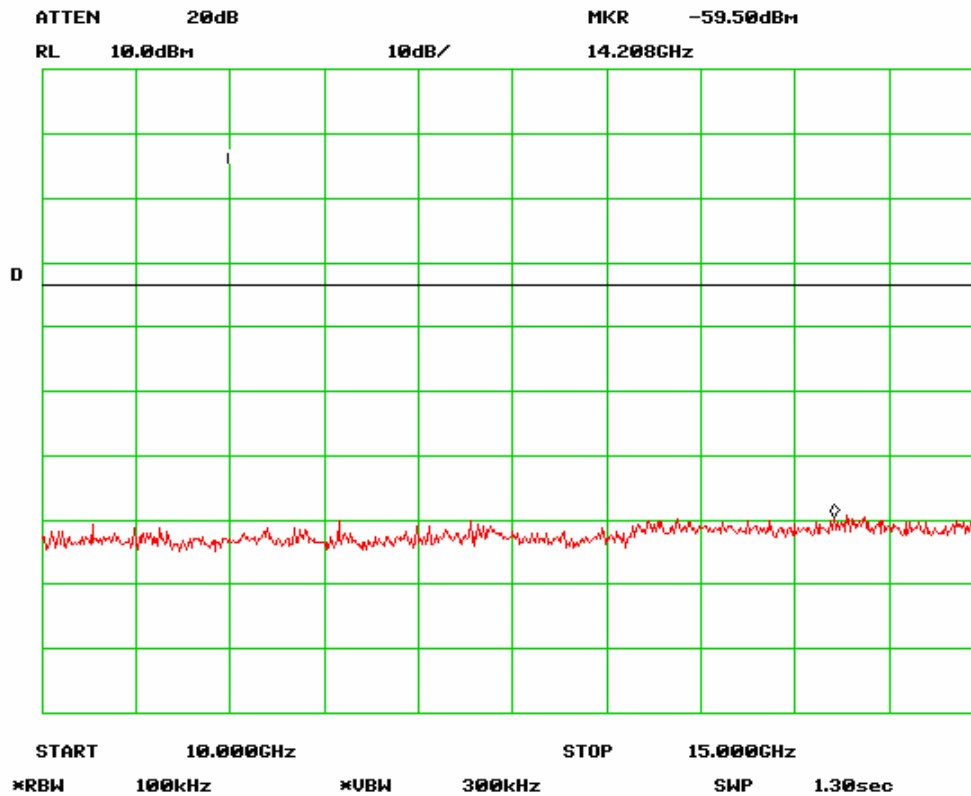

Antenna Port Emission Mid-4 Channel (802.11n 20MHz)



SIEMIC, INC.

Accessing global markets

Title: RF Test Report for Wifi Modular
Model: MR100
To: FCC 15.247:2009

Serial#: 10021272
Issue Date: 13 January 2011
Page: 58 of 113
www.siemic.com.cn

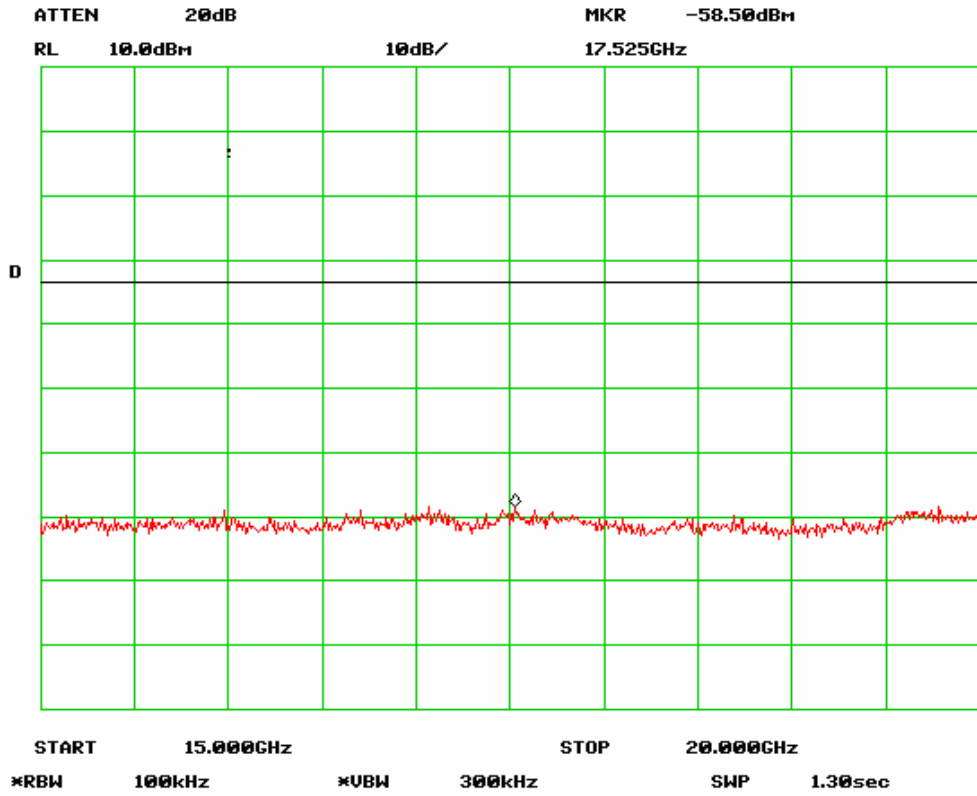

Antenna Port Emission Mid-5 Channel (802.11n 20MHz)

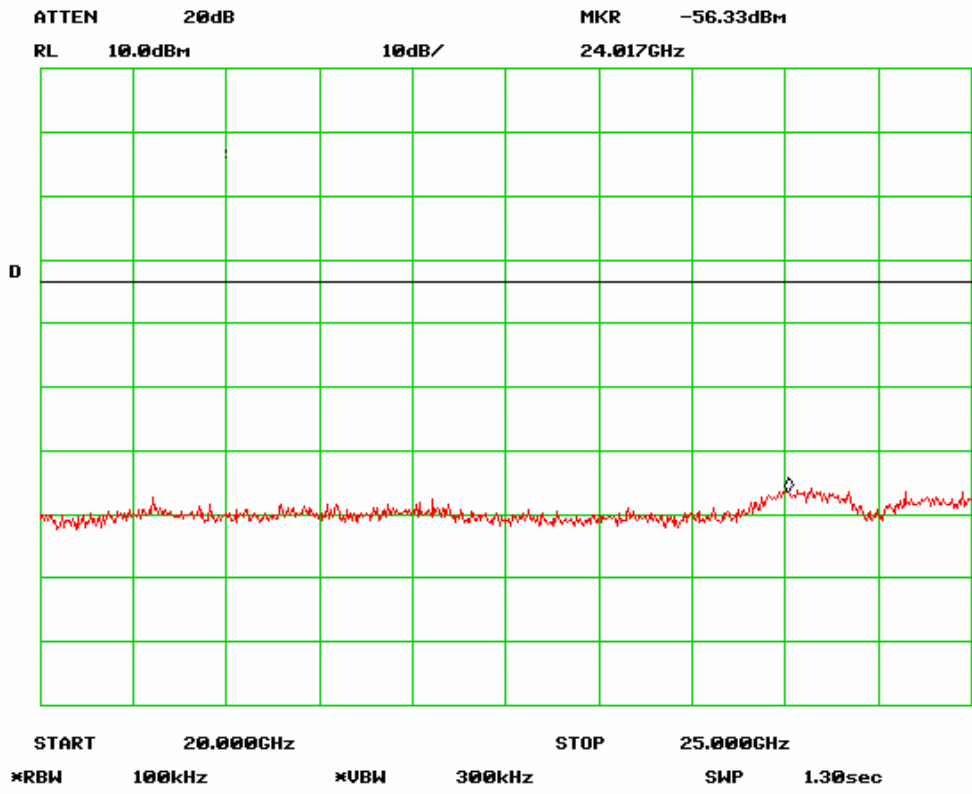

Antenna Port Emission Mid-6 Channel (802.11n 20MHz)



SIEMIC, INC.

Accessing global markets

Title: RF Test Report for Wifi Modular
Model: MR100
To: FCC 15.247:2009

Serial#: 10021272
Issue Date: 13 January 2011
Page: 59 of 113
www.siemec.com.cn

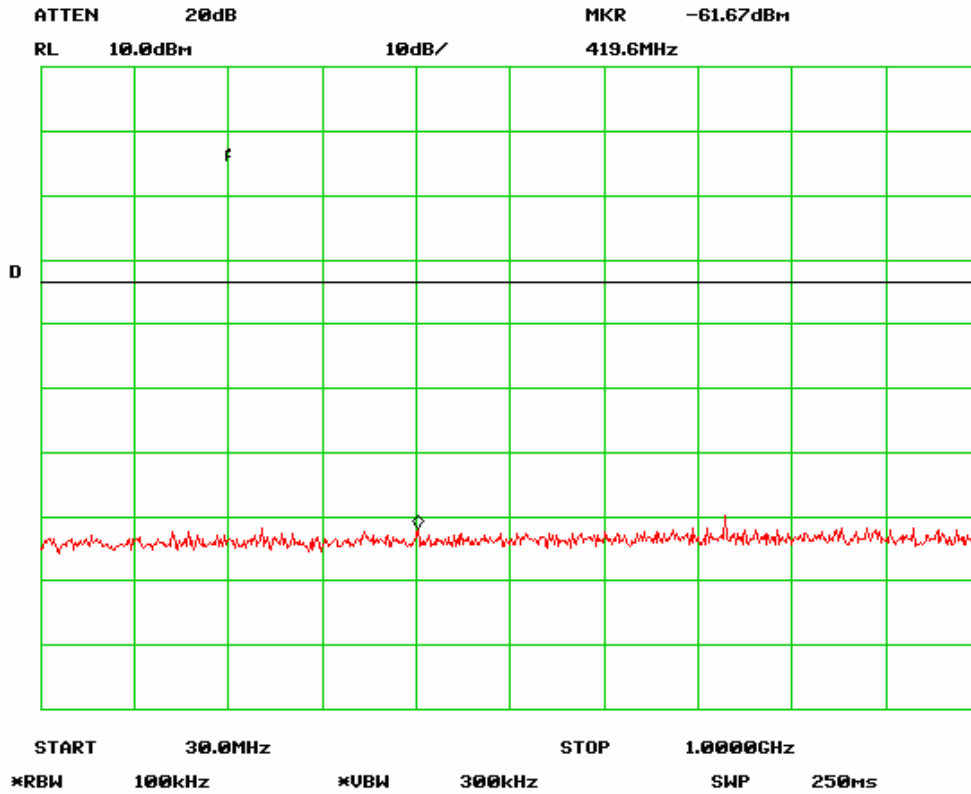

Antenna Port Emission High-1 Channel (802.11n 20MHz)

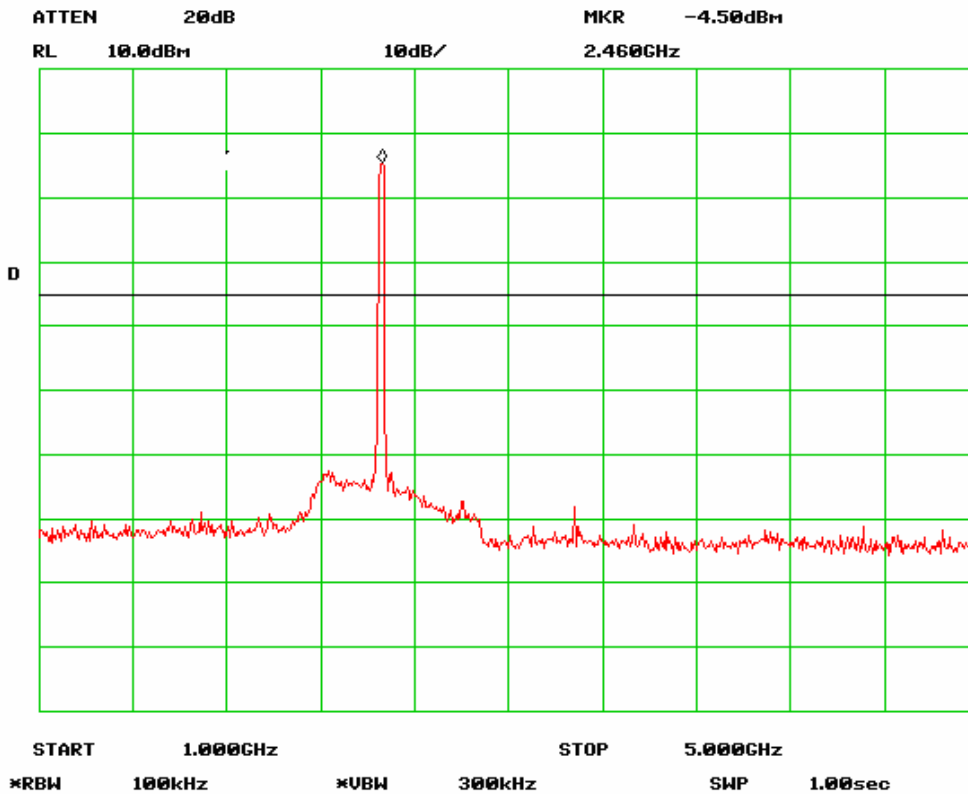

Antenna Port Emission High-2 Channel (802.11n 20MHz)

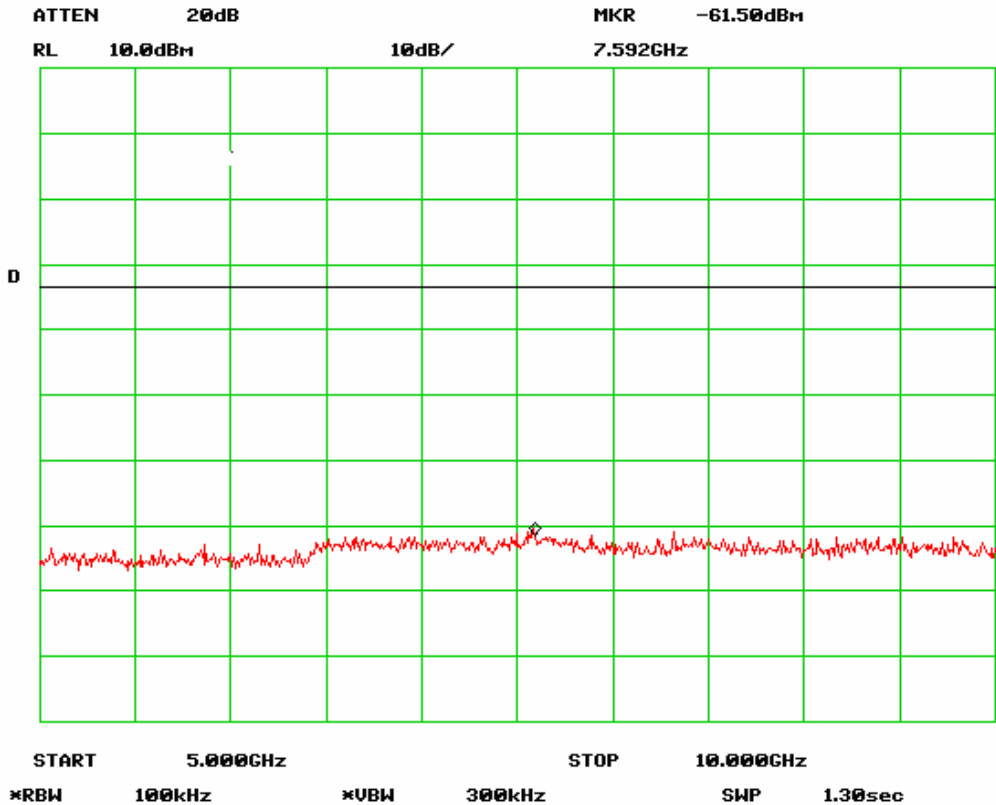

Antenna Port Emission High-3 Channel (802.11n 20MHz)

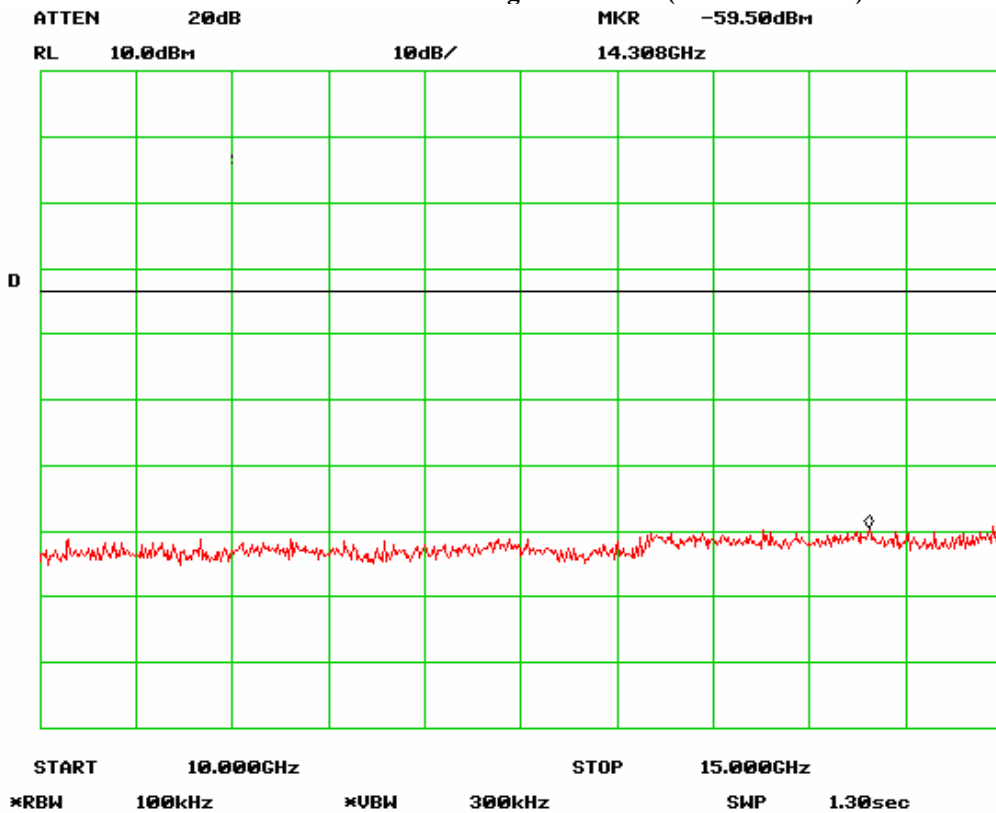

Antenna Port Emission High-4 Channel (802.11n 20MHz)



SIEMIC, INC.

Accessing global markets

Title: RF Test Report for Wifi Modular
Model: MR100
To: FCC 15.247:2009

Serial#: 10021272
Issue Date: 13 January 2011
Page: 61 of 113
www.siemic.com.cn

ATTEN 20dB **MKR -58.67dBm**
RL 10.0dBm **10dB/** **17.883GHz**

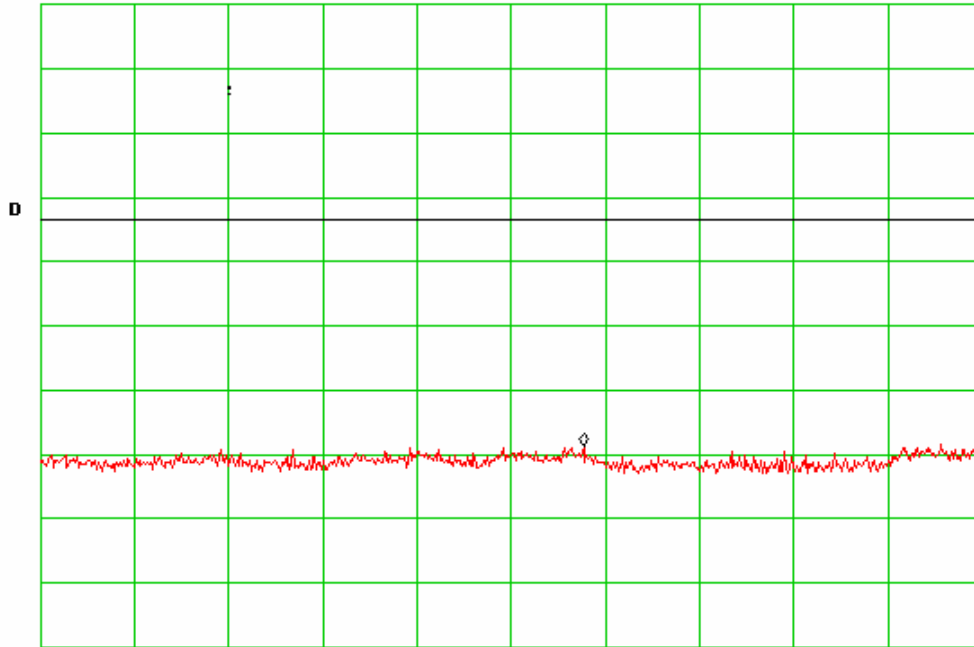

START 15.000GHz **STOP 20.000GHz**
***RBW 100kHz** ***VBW 300kHz** **SWP 1.30sec**

Antenna Port Emission High-5 Channel (802.11n 20MHz)

ATTEN 20dB **MKR -56.33dBm**
RL 10.0dBm **10dB/** **24.067GHz**

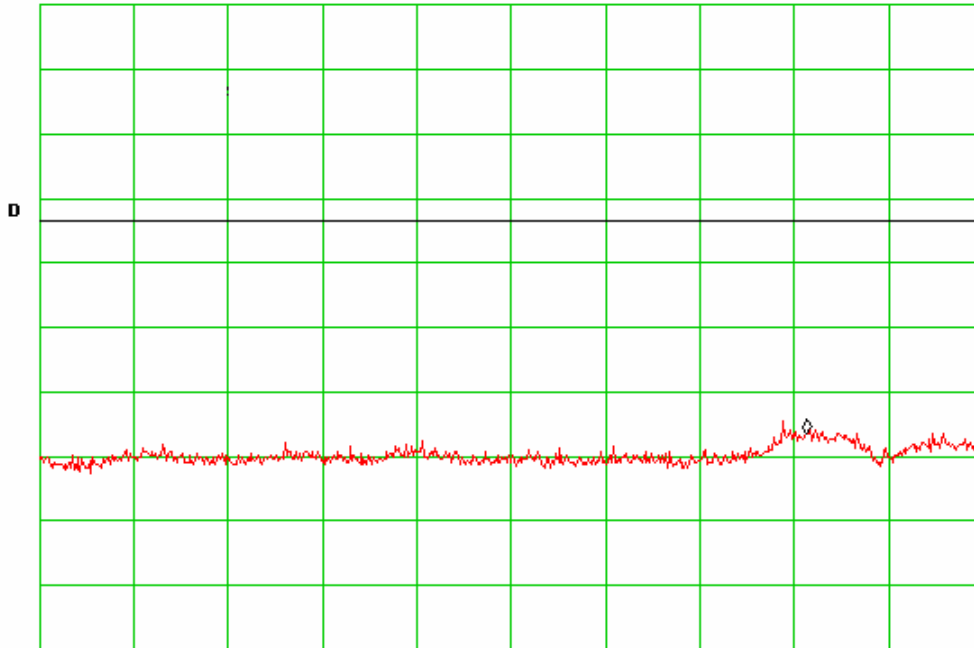

START 20.000GHz **STOP 25.000GHz**
***RBW 100kHz** ***VBW 300kHz** **SWP 1.30sec**

Antenna Port Emission High-6 Channel (802.11n 20MHz)



SIEMIC, Inc.

Accessing global markets

Title: RF Test Report for Wifi Modular
Model: MR100
To: FCC 15.247:2009

Serial#: 10021272
Issue Date: 13 January 2011
Page: 62 of 113
www.siemec.com.cn

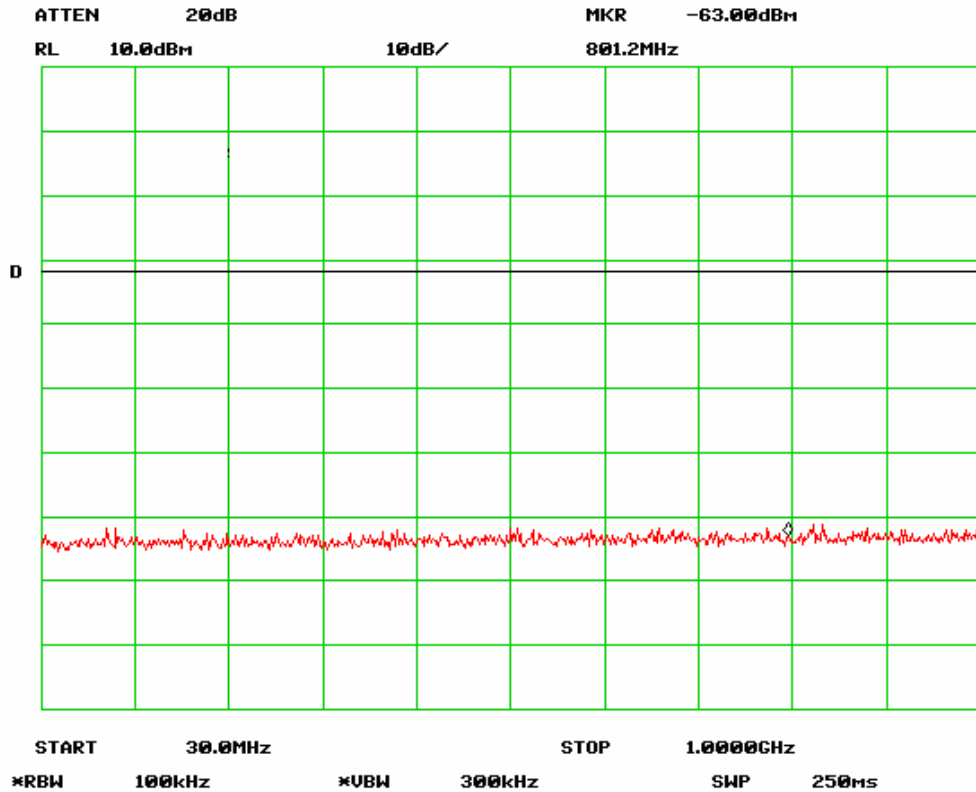

Antenna Port Emission Low-1 Channel (802.11n 40MHz)

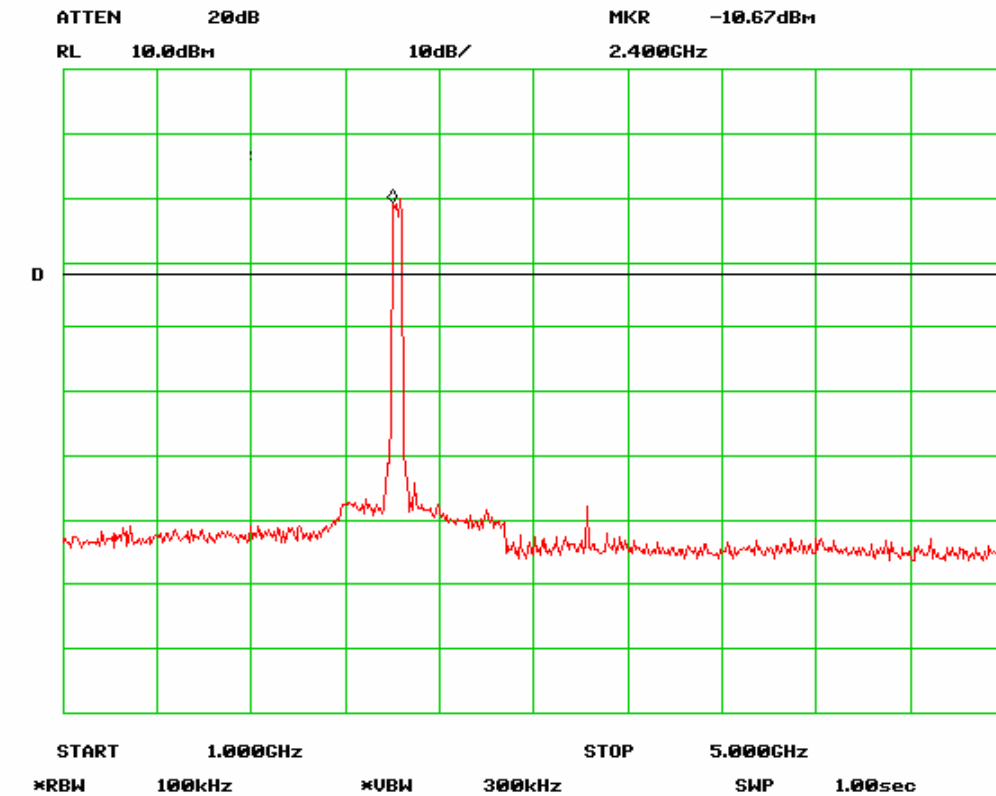

Antenna Port Emission Low-2 Channel (802.11n 40MHz)

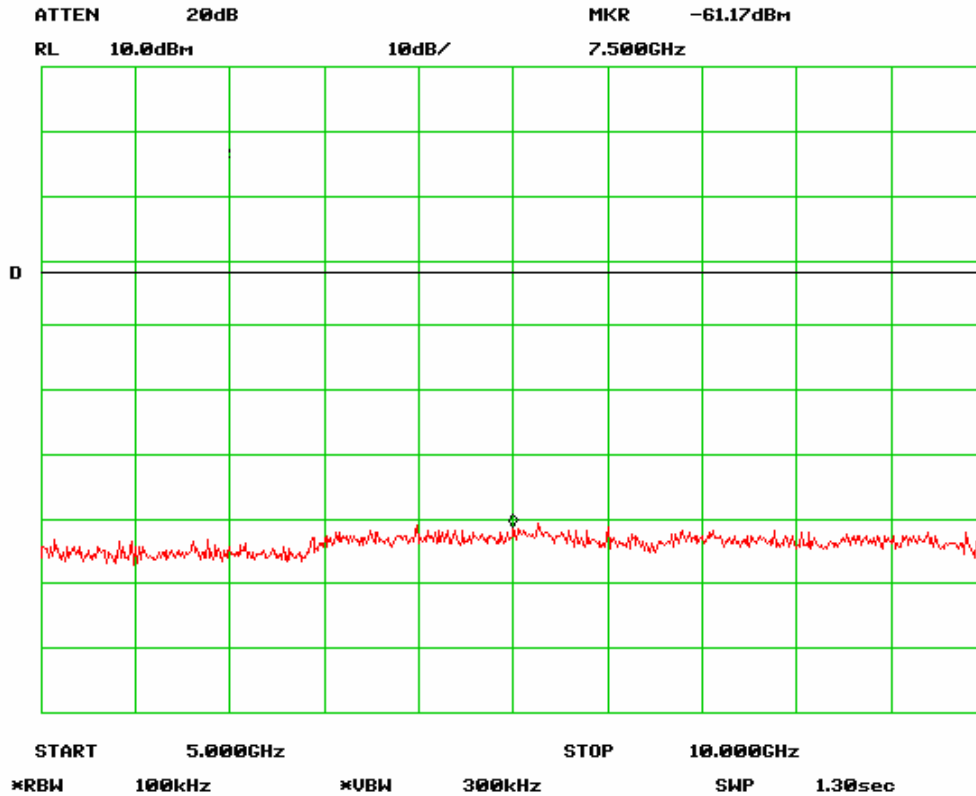

Antenna Port Emission Low-3 Channel (802.11n 40MHz)

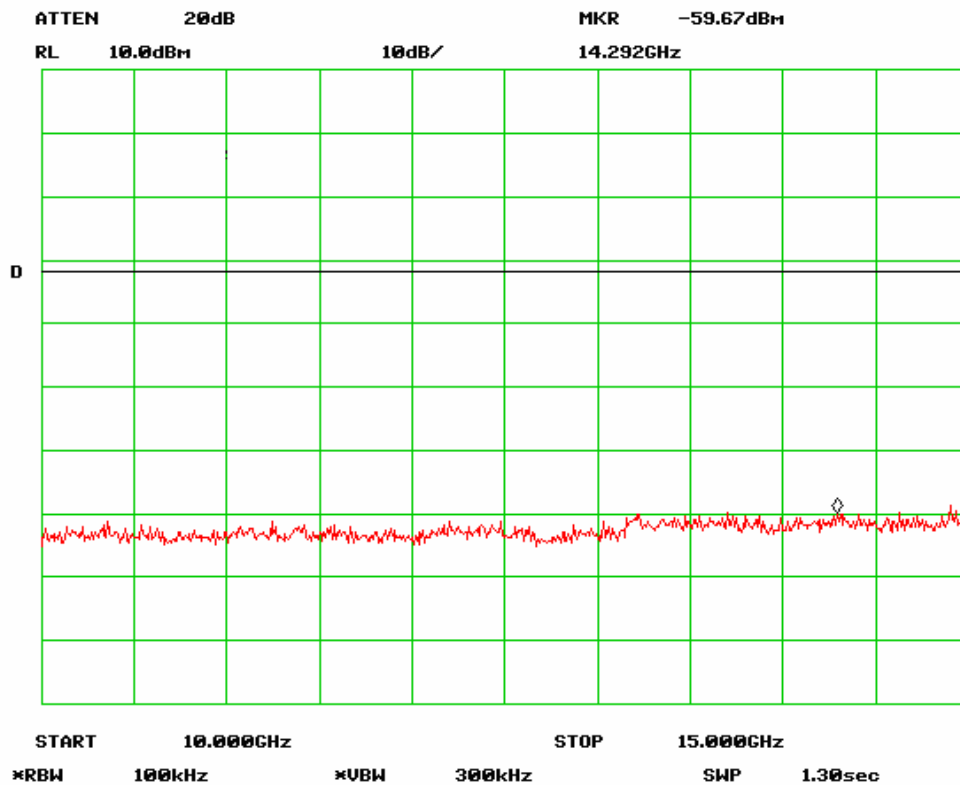

Antenna Port Emission Low-1 Channel (802.11n 40MHz)



ATTEN 20dB **MKR -58.17dBm**
RL 10.0dBm **10dB/** **17.542GHz**

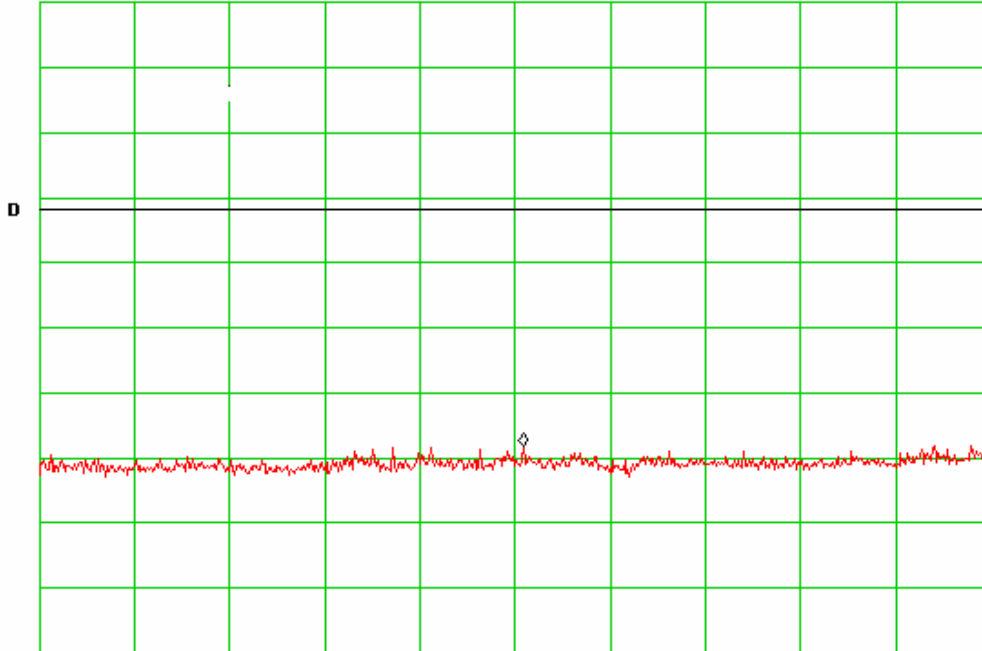

START 15.000GHz **STOP 20.000GHz**
***RBW 100kHz** ***UBW 300kHz** **SWP 1.30sec**

Antenna Port Emission Low-5 Channel (802.11n 40MHz)

ATTEN 20dB **MKR -58.17dBm**
RL 10.0dBm **10dB/** **22.542GHz**

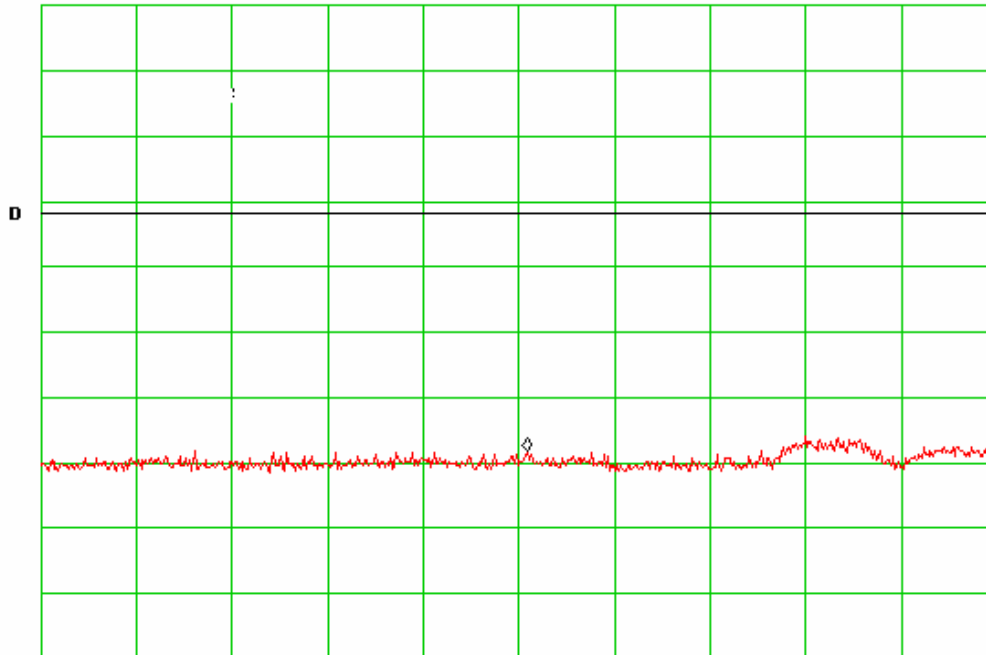

START 20.000GHz **STOP 25.000GHz**
***RBW 100kHz** ***UBW 300kHz** **SWP 1.30sec**

Antenna Port Emission Low-1 Channel (802.11n 40MHz)



SIEMIC, INC.

Accessing global markets

Title: RF Test Report for Wifi Modular
Model: MR100
To: FCC 15.247:2009

Serial#: 10021272
Issue Date: 13 January 2011
Page: 65 of 113
www.siemec.com.cn

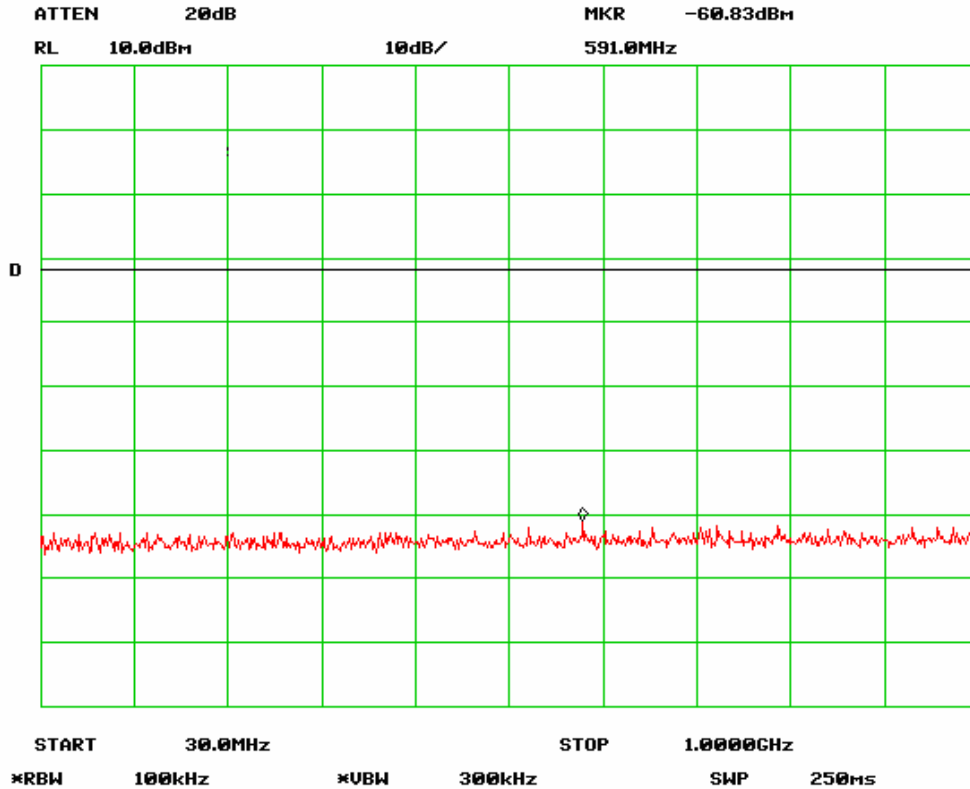

Antenna Port Emission Mid-1 Channel (802.11n 40MHz)

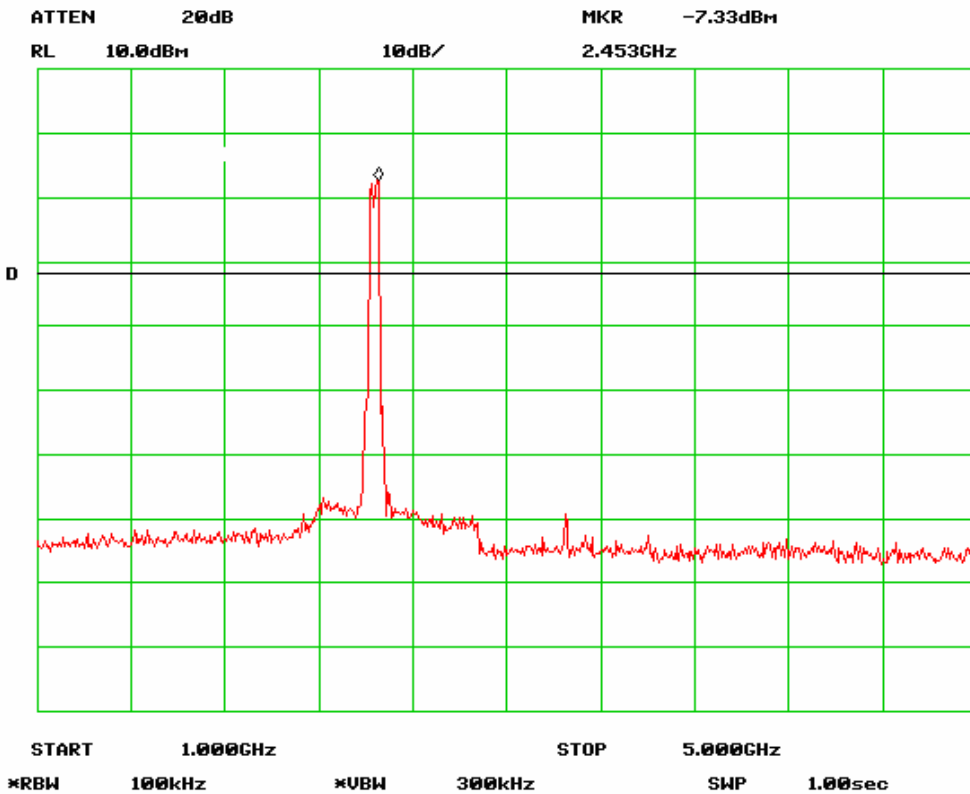

Antenna Port Emission Mid-2 Channel (802.11n 40MHz)



SIEMIC, INC.

Accessing global markets

Title: RF Test Report for Wifi Modular
Model: MR100
To: FCC 15.247:2009

Serial#: 10021272
Issue Date: 13 January 2011
Page: 66 of 113
www.siemic.com.cn

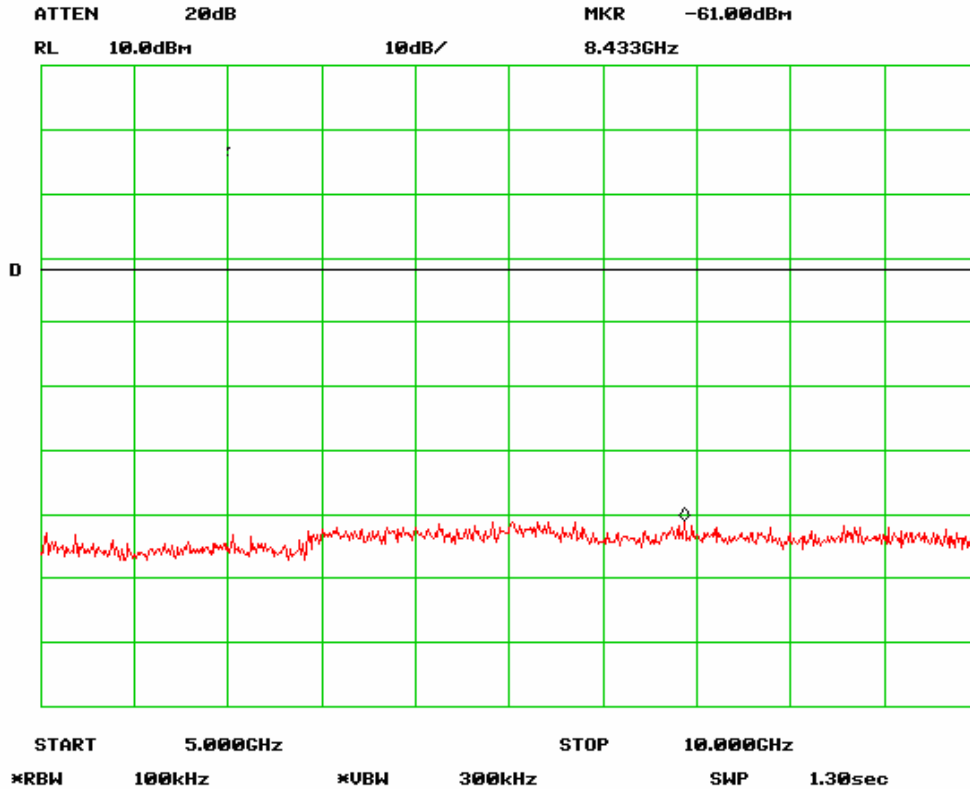

Antenna Port Emission Mid-3 Channel (802.11n 40MHz)

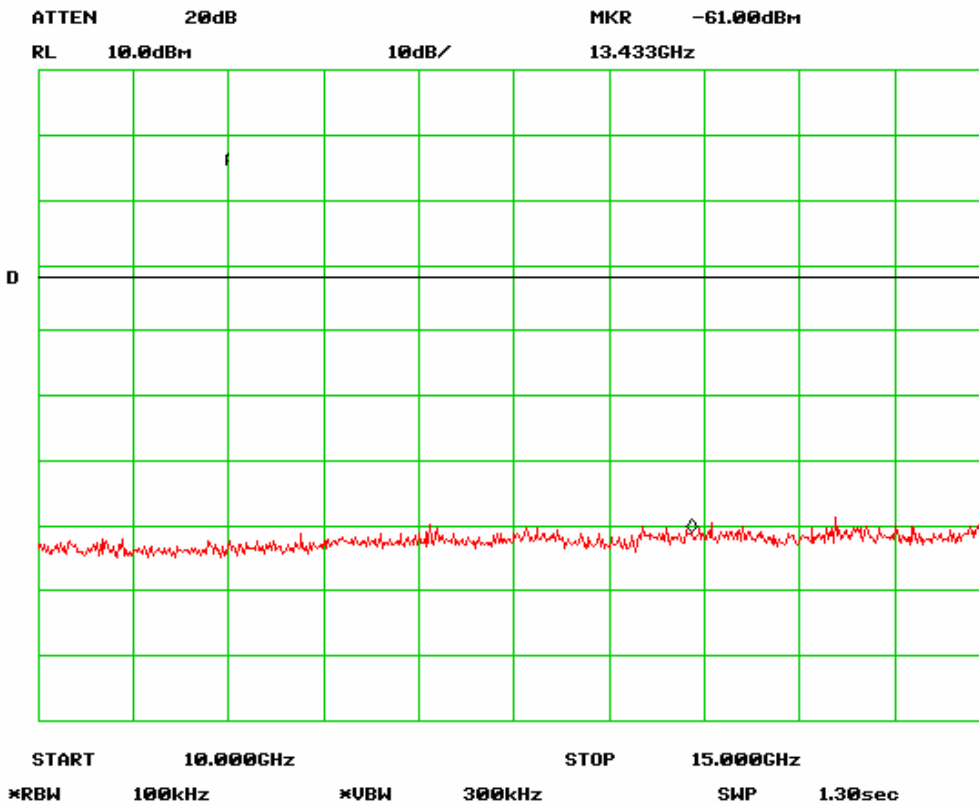

Antenna Port Emission Mid-4 Channel (802.11n 40MHz)

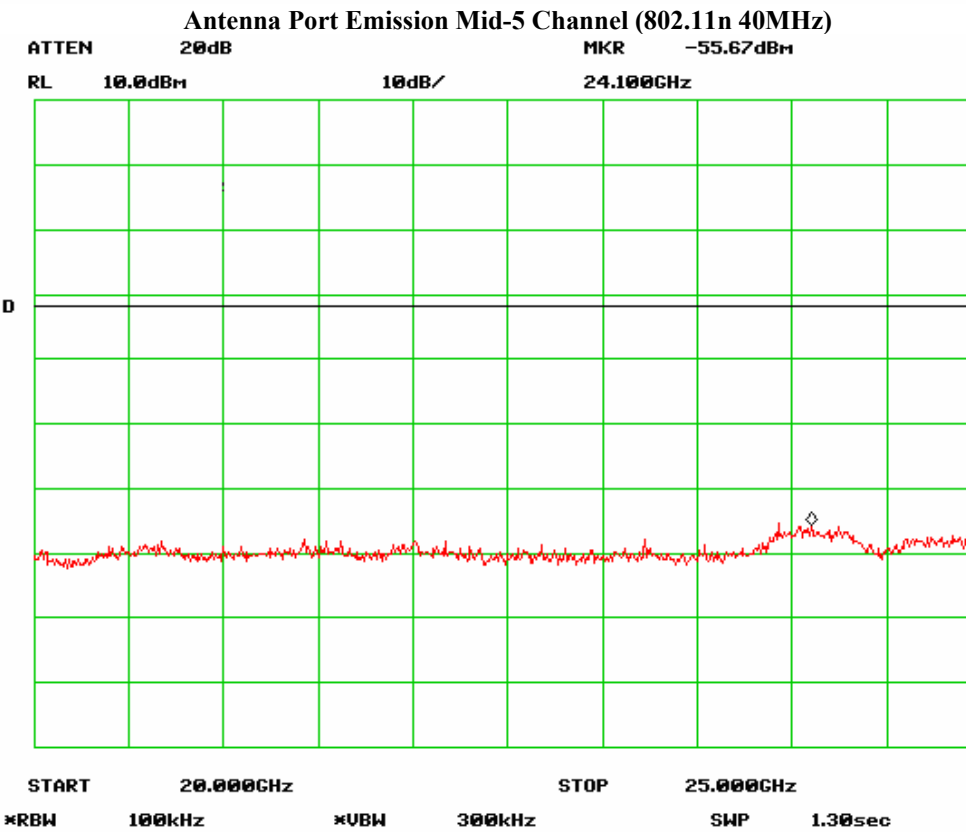
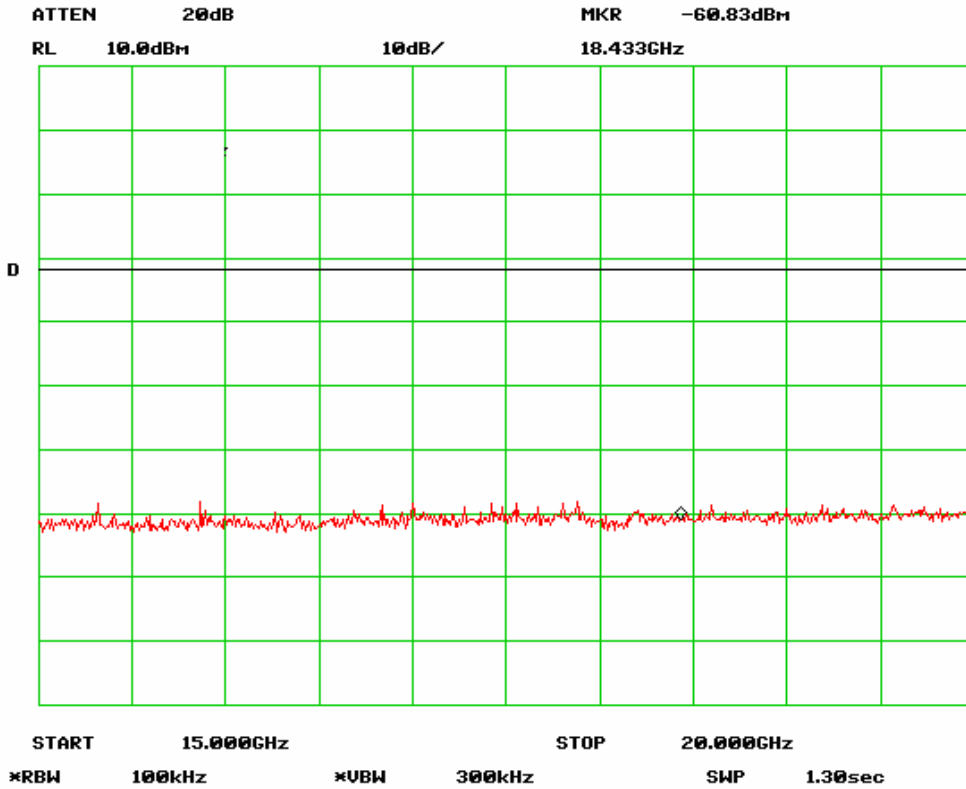

Antenna Port Emission Mid-6 Channel (802.11n 40MHz)



SIEMIC, INC.

Accessing global markets

Title: RF Test Report for Wifi Modular
Model: MR100
To: FCC 15.247:2009

Serial#: 10021272
Issue Date: 13 January 2011
Page: 68 of 113
www.siemec.com.cn

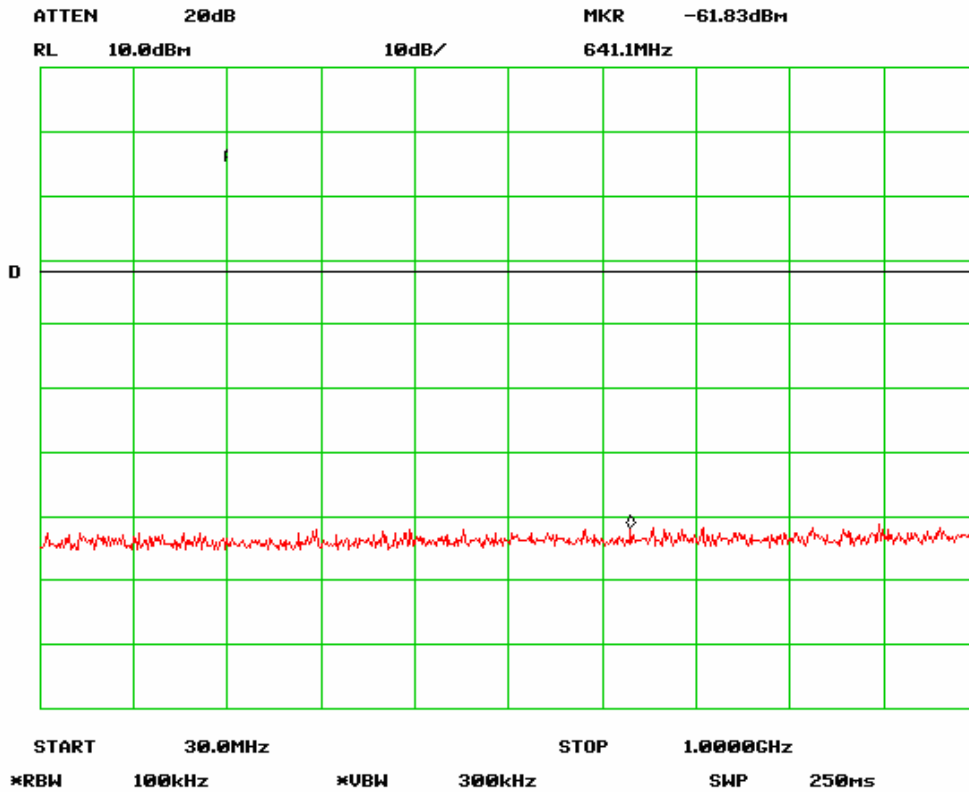

Antenna Port Emission High-1 Channel (802.11n 40MHz)

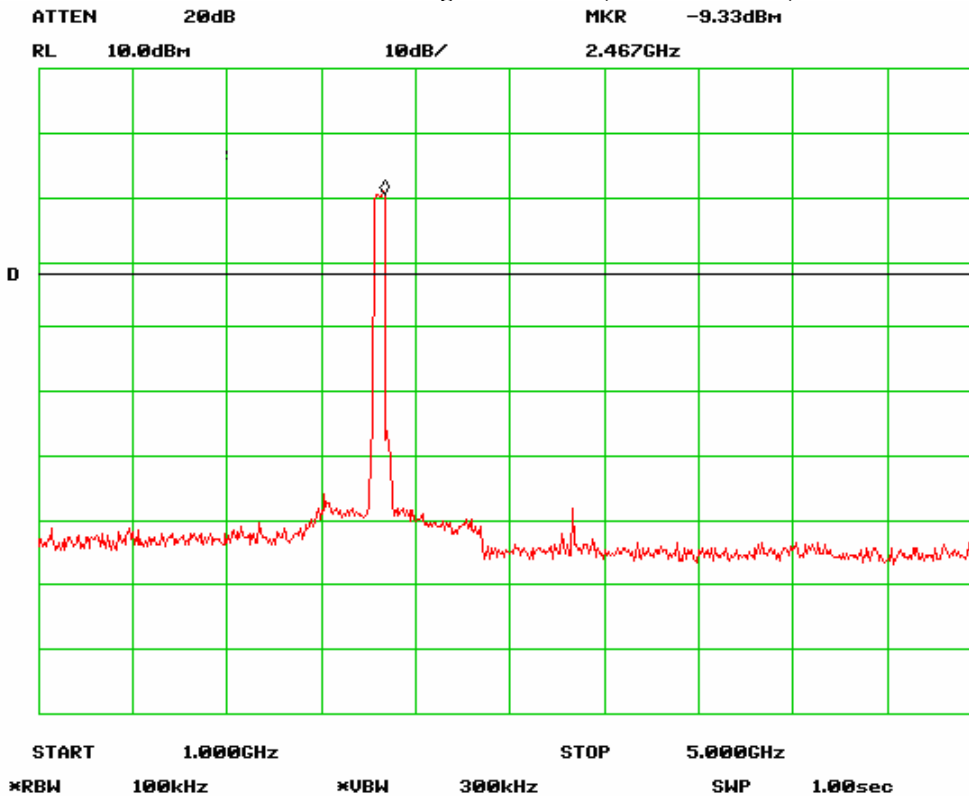

Antenna Port Emission High-2 Channel (802.11n 40MHz)



SIEMIC, INC.

Accessing global markets

Title: RF Test Report for Wifi Modular
Model: MR100
To: FCC 15.247:2009

Serial#: 10021272
Issue Date: 13 January 2011
Page: 69 of 113
www.siemic.com.cn

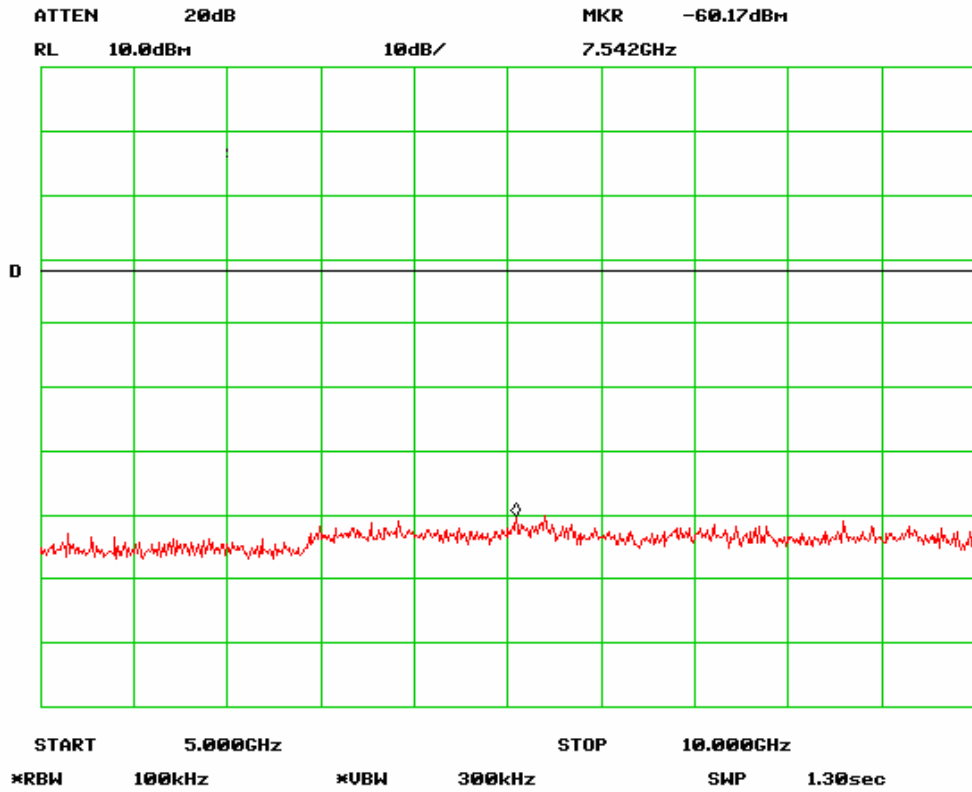

Antenna Port Emission High-3 Channel (802.11n 40MHz)

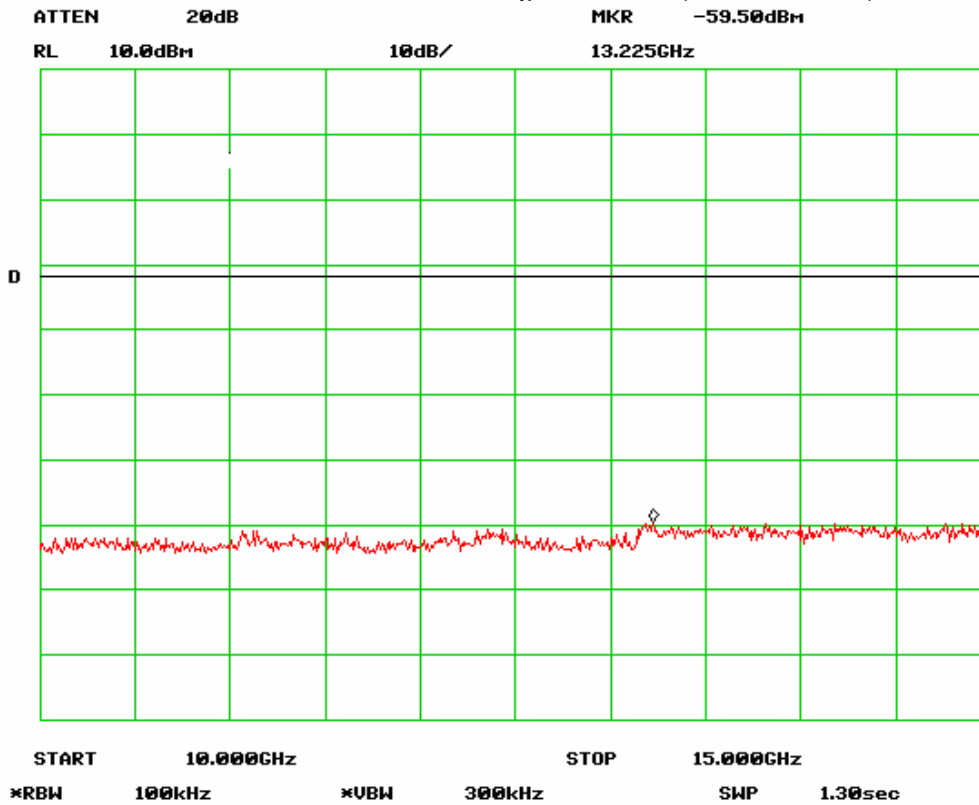

Antenna Port Emission High-4 Channel (802.11n 40MHz)



SIEMIC, INC.

Accessing global markets

Title: RF Test Report for Wifi Modular
Model: MR100
To: FCC 15.247:2009

Serial#: 10021272
Issue Date: 13 January 2011
Page: 70 of 113
www.siemec.com.cn

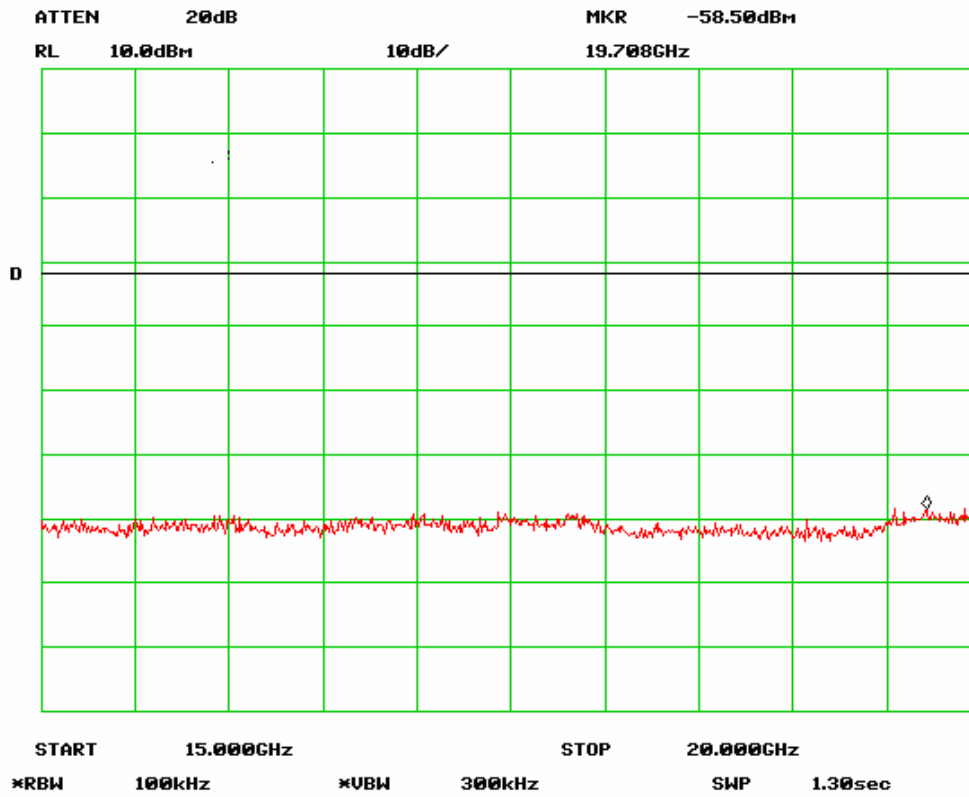

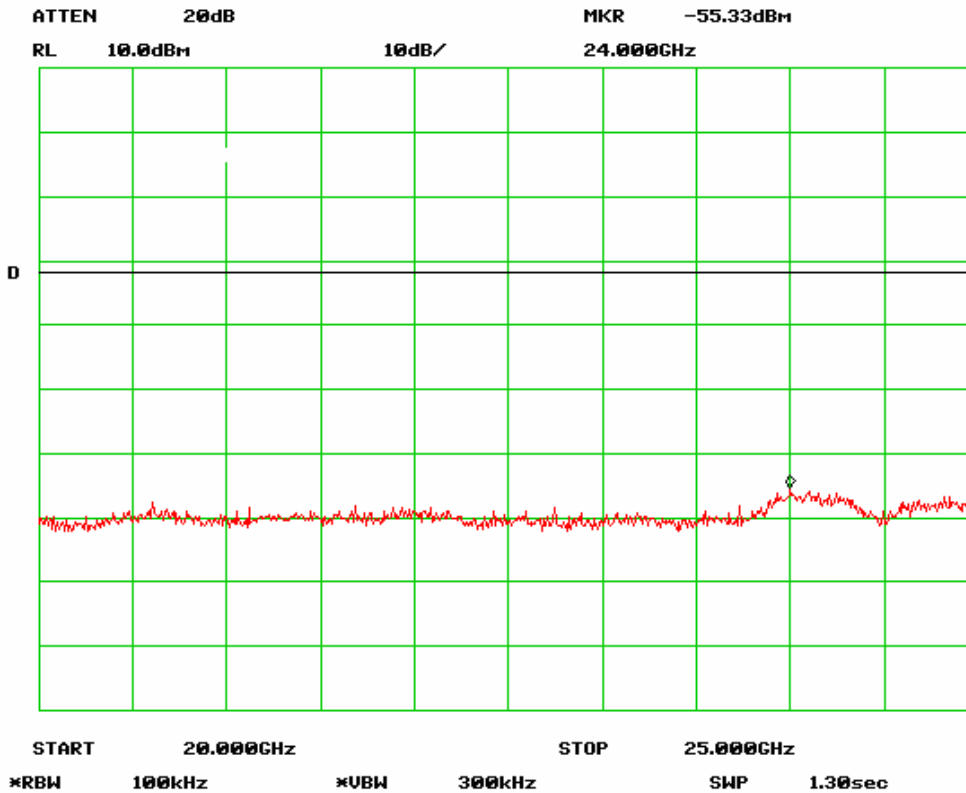

Antenna Port Emission High-5 Channel (802.11n 40MHz)



Antenna Port Emission High-6 Channel (802.11n 40MHz)

Radiated Emission Plot

Peak Detector 
 Quasi Peak Limit 

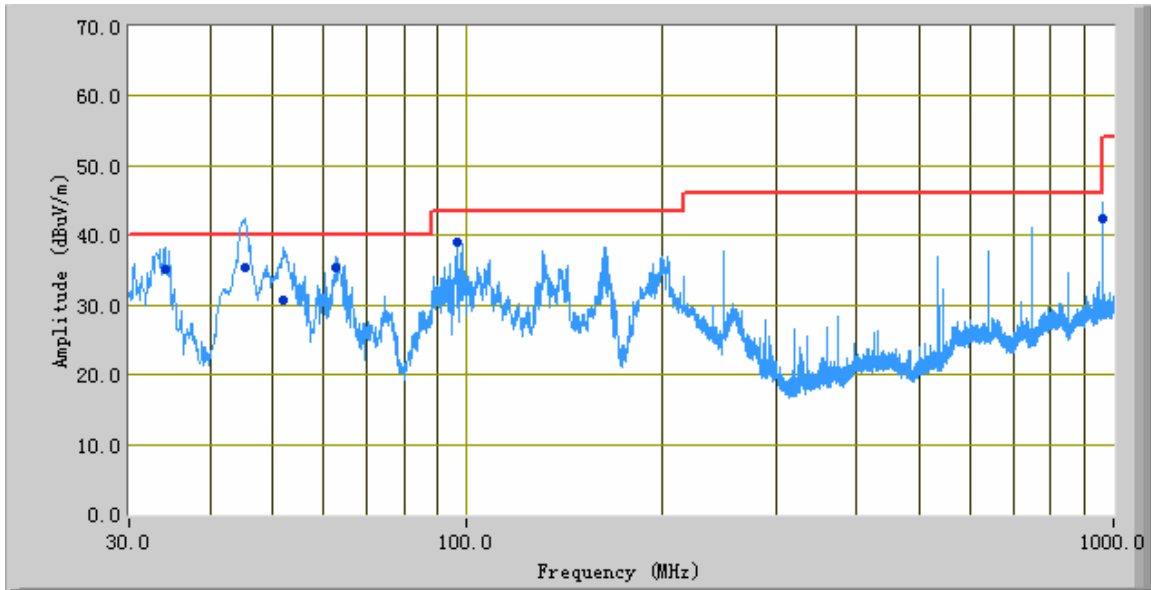

Test Data

| Frequency (MHz) | Quasi Peak (dBuV/m) | Azimuth | Polarity(H/V) | Height (cm) | Factors (dB) | Limit (dBuV/m) | Margin (dB) |
|-----------------|---------------------|---------|---------------|-------------|--------------|----------------|-------------|
| 45.34 | 35.38 | 225.00 | V | 148.00 | -33.87 | 40.00 | -4.62 |
| 34.11 | 35.16 | 40.00 | V | 224.00 | -25.99 | 40.00 | -4.84 |
| 52.21 | 30.69 | 309.00 | V | 116.00 | -36.60 | 40.00 | -9.31 |
| 62.77 | 35.32 | 27.00 | V | 231.00 | -38.40 | 40.00 | -4.68 |
| 960.00 | 42.46 | 313.00 | V | 196.00 | -19.50 | 46.00 | -3.54 |
| 96.68 | 38.98 | 48.00 | V | 154.00 | -36.09 | 43.50 | -4.52 |

Mode: 802.11b

@ 2412MHz @ 3 Meter

| Frequency | Direction | Height | Polar | Cable loss | Amplifier | Corrected Reading | 15.247/15.209 | 15.247/15.209 | |
|-----------|-----------|--------|-------|------------|-----------|-------------------|----------------|---------------|----------|
| GHz | Degree | Meter | H / V | (dB) | (dB) | (dBuV/m) | Limit (dBuV/m) | Margin | Comments |
| 4.824 | 9.00 | 1.07 | v | 5.15 | 55.00 | 55.4 | 74.00 | -18.6 | Peak |
| 4.824 | 12.00 | 1.10 | h | 5.15 | 55.00 | 51.8 | 74.00 | -22.2 | Peak |
| 4.824 | 9.00 | 1.07 | v | 5.15 | 55.00 | 42.6 | 54.00 | -11.4 | Ave |
| 4.824 | 12.00 | 1.10 | h | 5.15 | 55.00 | 40.6 | 54.00 | -13.4 | Ave |
| 7.236 | 5.30 | 1.12 | v | 7.23 | 55.00 | 65.6 | 74.00 | -8.4 | Peak |
| 7.236 | 6.11 | 1.15 | h | 7.23 | 55.00 | 63.7 | 74.00 | -10.3 | Peak |
| 7.236 | 5.30 | 1.12 | v | 7.23 | 55.00 | 49.5 | 54.00 | -4.5 | Ave |
| 7.236 | 6.11 | 1.15 | h | 7.23 | 55.00 | 47.9 | 54.00 | -6.1 | Ave |
| 9.678 | 31.0 | 1.26 | v | 8.56 | 55.00 | 55.1 | 74.00 | -18.9 | Peak |
| 9.678 | 3.0 | 1.34 | h | 8.56 | 55.00 | 54.3 | 74.00 | -19.7 | Peak |
| 9.678 | 31.0 | 1.26 | v | 8.56 | 55.00 | 44.3 | 54.00 | -9.7 | Ave |
| 9.678 | 3.0 | 1.34 | h | 8.56 | 55.00 | 43.2 | 54.00 | -10.8 | Ave |
| 12.06 | 0 | 1.06 | v | 11.03 | 55.00 | 51.1 | 74.00 | -22.9 | Peak |
| 12.06 | 12.0 | 1.24 | h | 11.03 | 55.00 | 50.7 | 74.00 | -23.3 | Peak |
| 12.06 | 0 | 1.06 | v | 11.03 | 55.00 | 42.2 | 54.00 | -11.8 | Ave |
| 12.06 | 12.0 | 1.24 | h | 11.03 | 55.00 | 40.6 | 54.00 | -13.4 | Ave |

Emission was scanned up to 25GHz.

@ 2437MHz @ 3Meter

| Frequency | Direction | Height | Polar | Cable loss | Amplifier | Corrected Reading | 15.247/15.209 | 15.247/15.209 | |
|-----------|-----------|--------|-------|------------|-----------|-------------------|----------------|---------------|----------|
| GHz | Degree | Meter | H / V | (dB) | (dB) | (dBuV/m) | Limit (dBuV/m) | Margin | Comments |
| 4.874 | 31.00 | 1.10 | v | 5.16 | 55.00 | 56.5 | 74.00 | -17.6 | Peak |
| 4.874 | 25.00 | 1.00 | h | 5.16 | 55.00 | 53.1 | 74.00 | -20.9 | Peak |
| 4.874 | 31.00 | 1.10 | v | 5.16 | 55.00 | 44.9 | 54.00 | -9.1 | Ave |
| 4.874 | 25.00 | 1.00 | h | 5.16 | 55.00 | 43.6 | 54.00 | -10.4 | Ave |
| 7.311 | 13.00 | 1.20 | v | 7.31 | 55.00 | 68.1 | 74.00 | -5.9 | Peak |
| 7.311 | 4.00 | 1.03 | h | 7.31 | 55.00 | 66.4 | 74.00 | -7.6 | Peak |
| 7.311 | 13.00 | 1.20 | v | 7.31 | 55.00 | 50.5 | 54.00 | -3.5 | Ave |
| 7.311 | 4.00 | 1.03 | h | 7.31 | 55.00 | 50.1 | 54.00 | -3.9 | Ave |
| 9.748 | 22.0 | 1.30 | v | 8.66 | 55.00 | 57.6 | 74.00 | -16.4 | Peak |
| 9.748 | 7.0 | 1.00 | h | 8.66 | 55.00 | 56.0 | 74.00 | -18.0 | Peak |
| 9.748 | 22.0 | 1.30 | v | 8.66 | 55.00 | 44.3 | 54.00 | -9.7 | Ave |
| 9.748 | 7.0 | 1.00 | h | 8.66 | 55.00 | 45.2 | 54.00 | -8.8 | Ave |
| 12.185 | 0 | 1.20 | v | 11.22 | 55.00 | 52.0 | 74.00 | -22.0 | Peak |
| 12.185 | 0 | 1.08 | h | 11.22 | 55.00 | 51.4 | 74.00 | -22.6 | Peak |
| 12.185 | 0 | 1.20 | v | 11.22 | 55.00 | 43.1 | 54.00 | -10.9 | Ave |
| 12.185 | 0 | 1.08 | h | 11.22 | 55.00 | 40.7 | 54.00 | -13.3 | Ave |

Emission was scanned up to 25GHz.

@ 2462MHz @ 3Meter

| Frequency | Direction | Height | Polar | Cable loss | Amplifier | Corrected Reading | 15.247/15.209 | 15.247/15.209 | |
|-----------|-----------|--------|-------|------------|-----------|-------------------|----------------|---------------|----------|
| GHz | Degree | Meter | H / V | (dB) | (dB) | (dBuV/m) | Limit (dBuV/m) | Margin | Comments |
| 4.924 | 15.00 | 1.07 | v | 5.17 | 55.00 | 54.3 | 74.00 | -19.7 | Peak |
| 4.924 | 25.00 | 1.10 | h | 5.17 | 55.00 | 53.1 | 74.00 | -20.9 | Peak |
| 4.924 | 15.00 | 1.07 | v | 5.17 | 55.00 | 44.5 | 54.00 | -9.5 | Ave |
| 4.924 | 25.00 | 1.10 | h | 5.17 | 55.00 | 42.6 | 54.00 | -11.4 | Ave |
| 7.386 | 0 | 1.20 | v | 7.36 | 55.00 | 66.4 | 74.00 | -7.6 | Peak |
| 7.386 | 3.00 | 1.00 | h | 7.36 | 55.00 | 64.4 | 74.00 | -9.6 | Peak |
| 7.386 | 0 | 1.20 | v | 7.36 | 55.00 | 48.9 | 54.00 | -5.1 | Ave |
| 7.386 | 3.00 | 1.00 | h | 7.36 | 55.00 | 48.2 | 54.00 | -5.8 | Ave |
| 9.848 | 6.00 | 1.10 | v | 8.74 | 55.00 | 55.3 | 74.00 | -18.7 | Peak |
| 9.848 | 21.00 | 1.08 | h | 8.74 | 55.00 | 54.8 | 74.00 | -19.2 | Peak |
| 9.848 | 6.00 | 1.10 | v | 8.74 | 55.00 | 43.3 | 54.00 | -10.7 | Ave |
| 9.848 | 21.00 | 1.08 | h | 8.74 | 55.00 | 45.2 | 54.00 | -8.8 | Ave |
| 12.31 | 4.00 | 1.34 | v | 11.39 | 55.00 | 51.0 | 74.00 | -23.0 | Peak |
| 12.31 | 9.00 | 1.27 | h | 11.39 | 55.00 | 50.5 | 74.00 | -23.5 | Peak |
| 12.31 | 4.00 | 1.34 | v | 11.39 | 55.00 | 42.7 | 54.00 | -11.3 | Ave |
| 12.31 | 9.00 | 1.27 | h | 11.39 | 55.00 | 40.3 | 54.00 | -13.7 | Ave |

Emission was scanned up to 25GHz.

Mode: 802.11g

@ 2412MHz @ 3 Meter

| Frequency | Direction | Height | Polar | Cable loss | Amplifier | Corrected Reading | 15.247/15.209 | 15.247/15.209 | |
|-----------|-----------|--------|-------|------------|-----------|-------------------|----------------|---------------|----------|
| GHz | Degree | Meter | H / V | (dB) | (dB) | (dBuV/m) | Limit (dBuV/m) | Margin | Comments |
| 4.824 | 9.00 | 1.07 | v | 5.15 | 55.00 | 54.7 | 74.00 | -19.3 | Peak |
| 4.824 | 12.00 | 1.10 | h | 5.15 | 55.00 | 51.6 | 74.00 | -22.4 | Peak |
| 4.824 | 9.00 | 1.07 | v | 5.15 | 55.00 | 41.4 | 54.00 | -12.6 | Ave |
| 4.824 | 12.00 | 1.10 | h | 5.15 | 55.00 | 40.0 | 54.00 | -14.0 | Ave |
| 7.236 | 5.30 | 1.12 | v | 7.23 | 55.00 | 64.2 | 74.00 | -9.8 | Peak |
| 7.236 | 6.11 | 1.15 | h | 7.23 | 55.00 | 62.8 | 74.00 | -11.2 | Peak |
| 7.236 | 5.30 | 1.12 | v | 7.23 | 55.00 | 48.1 | 54.00 | -5.9 | Ave |
| 7.236 | 6.11 | 1.15 | h | 7.23 | 55.00 | 47.4 | 54.00 | -6.6 | Ave |
| 9.678 | 31.0 | 1.26 | v | 8.56 | 55.00 | 54.6 | 74.00 | -19.4 | Peak |
| 9.678 | 3.0 | 1.34 | h | 8.56 | 55.00 | 53.5 | 74.00 | -20.5 | Peak |
| 9.678 | 31.0 | 1.26 | v | 8.56 | 55.00 | 42.8 | 54.00 | -11.2 | Ave |
| 9.678 | 3.0 | 1.34 | h | 8.56 | 55.00 | 41.9 | 54.00 | -12.1 | Ave |
| 12.06 | 0 | 1.06 | v | 11.03 | 55.00 | 50.9 | 74.00 | -23.1 | Peak |
| 12.06 | 12.0 | 1.24 | h | 11.03 | 55.00 | 49.7 | 74.00 | -24.3 | Peak |
| 12.06 | 0 | 1.06 | v | 11.03 | 55.00 | 41.8 | 54.00 | -12.2 | Ave |
| 12.06 | 12.0 | 1.24 | h | 11.03 | 55.00 | 40.4 | 54.00 | -13.6 | Ave |

Emission was scanned up to 25GHz.

@ 2437MHz @ 3Meter

| Frequency | Direction | Height | Polar | Cable loss | Amplifier | Corrected Reading | 15.247/15.209 | 15.247/15.209 | |
|-----------|-----------|--------|-------|------------|-----------|-------------------|----------------|---------------|----------|
| GHz | Degree | Meter | H / V | (dB) | (dB) | (dBuV/m) | Limit (dBuV/m) | Margin | Comments |
| 4.874 | 31.00 | 1.10 | v | 5.16 | 55.00 | 54.6 | 74.00 | -19.4 | Peak |
| 4.874 | 25.00 | 1.00 | h | 5.16 | 55.00 | 52.2 | 74.00 | -21.8 | Peak |
| 4.874 | 31.00 | 1.10 | v | 5.16 | 55.00 | 43.5 | 54.00 | -10.5 | Ave |
| 4.874 | 25.00 | 1.00 | h | 5.16 | 55.00 | 42.6 | 54.00 | -11.4 | Ave |
| 7.311 | 13.00 | 1.20 | v | 7.31 | 55.00 | 64.7 | 74.00 | -9.3 | Peak |
| 7.311 | 4.00 | 1.03 | h | 7.31 | 55.00 | 63.1 | 74.00 | -10.9 | Peak |
| 7.311 | 13.00 | 1.20 | v | 7.31 | 55.00 | 48.2 | 54.00 | -5.8 | Ave |
| 7.311 | 4.00 | 1.03 | h | 7.31 | 55.00 | 47.6 | 54.00 | -6.4 | Ave |
| 9.748 | 22.0 | 1.30 | v | 8.66 | 55.00 | 55.1 | 74.00 | -18.9 | Peak |
| 9.748 | 7.0 | 1.00 | h | 8.66 | 55.00 | 53.2 | 74.00 | -20.8 | Peak |
| 9.748 | 22.0 | 1.30 | v | 8.66 | 55.00 | 41.3 | 54.00 | -12.7 | Ave |
| 9.748 | 7.0 | 1.00 | h | 8.66 | 55.00 | 43.6 | 54.00 | -10.4 | Ave |
| 12.185 | 0 | 1.20 | v | 11.22 | 55.00 | 50.5 | 74.00 | -23.5 | Peak |
| 12.185 | 0 | 1.08 | h | 11.22 | 55.00 | 50.9 | 74.00 | -23.1 | Peak |
| 12.185 | 0 | 1.20 | v | 11.22 | 55.00 | 42.1 | 54.00 | -11.9 | Ave |
| 12.185 | 0 | 1.08 | h | 11.22 | 55.00 | 40.8 | 54.00 | -13.2 | Ave |

Emission was scanned up to 25GHz.

@ 2462MHz @ 3Meter

| Frequency | Direction | Height | Polar | Cable loss | Amplifier | Corrected Reading | 15.247/15.209 | 15.247/15.209 | |
|-----------|-----------|--------|-------|------------|-----------|-------------------|----------------|---------------|----------|
| GHz | Degree | Meter | H / V | (dB) | (dB) | (dBuV/m) | Limit (dBuV/m) | Margin | Comments |
| 4.924 | 15.00 | 1.07 | v | 5.17 | 55.00 | 51.9 | 74.00 | -22.1 | Peak |
| 4.924 | 25.00 | 1.10 | h | 5.17 | 55.00 | 52.8 | 74.00 | -21.2 | Peak |
| 4.924 | 15.00 | 1.07 | v | 5.17 | 55.00 | 45.6 | 54.00 | -8.4 | Ave |
| 4.924 | 25.00 | 1.10 | h | 5.17 | 55.00 | 43.1 | 54.00 | -10.9 | Ave |
| 7.386 | 0 | 1.20 | v | 7.36 | 55.00 | 63.6 | 74.00 | -10.4 | Peak |
| 7.386 | 3.00 | 1.00 | h | 7.36 | 55.00 | 62.0 | 74.00 | -12.0 | Peak |
| 7.386 | 0 | 1.20 | v | 7.36 | 55.00 | 47.7 | 54.00 | -6.3 | Ave |
| 7.386 | 3.00 | 1.00 | h | 7.36 | 55.00 | 46.4 | 54.00 | -7.6 | Ave |
| 9.848 | 6.00 | 1.10 | v | 8.74 | 55.00 | 54.3 | 74.00 | -19.7 | Peak |
| 9.848 | 21.00 | 1.08 | h | 8.74 | 55.00 | 52.8 | 74.00 | -21.2 | Peak |
| 9.848 | 6.00 | 1.10 | v | 8.74 | 55.00 | 41.5 | 54.00 | -12.5 | Ave |
| 9.848 | 21.00 | 1.08 | h | 8.74 | 55.00 | 43.1 | 54.00 | -10.9 | Ave |
| 12.31 | 4.00 | 1.34 | v | 11.39 | 55.00 | 50.3 | 74.00 | -23.7 | Peak |
| 12.31 | 9.00 | 1.27 | h | 11.39 | 55.00 | 49.6 | 74.00 | -24.4 | Peak |
| 12.31 | 4.00 | 1.34 | v | 11.39 | 55.00 | 42.7 | 54.00 | -11.3 | Ave |
| 12.31 | 9.00 | 1.27 | h | 11.39 | 55.00 | 41.7 | 54.00 | -12.3 | Ave |

Emission was scanned up to 25GHz.

Mode: 802.11n-20MHz

@ 2412MHz @ 3 Meter

| Frequency | Direction | Height | Polar | Cable loss | Amplifier | Corrected Reading | 15.247/15.209 | 15.247/15.209 | |
|-----------|-----------|--------|-------|------------|-----------|-------------------|----------------|---------------|----------|
| GHz | Degree | Meter | H / V | (dB) | (dB) | (dBuV/m) | Limit (dBuV/m) | Margin | Comments |
| 4.824 | 9.00 | 1.07 | v | 5.15 | 55.00 | 54.7 | 74.00 | -19.3 | Peak |
| 4.824 | 12.00 | 1.10 | h | 5.15 | 55.00 | 51.6 | 74.00 | -22.4 | Peak |
| 4.824 | 9.00 | 1.07 | v | 5.15 | 55.00 | 41.4 | 54.00 | -12.6 | Ave |
| 4.824 | 12.00 | 1.10 | h | 5.15 | 55.00 | 40.0 | 54.00 | -14.0 | Ave |
| 7.236 | 5.30 | 1.12 | v | 7.23 | 55.00 | 64.2 | 74.00 | -9.8 | Peak |
| 7.236 | 6.11 | 1.15 | h | 7.23 | 55.00 | 62.8 | 74.00 | -11.2 | Peak |
| 7.236 | 5.30 | 1.12 | v | 7.23 | 55.00 | 48.1 | 54.00 | -5.9 | Ave |
| 7.236 | 6.11 | 1.15 | h | 7.23 | 55.00 | 47.4 | 54.00 | -6.6 | Ave |
| 9.678 | 31.0 | 1.26 | v | 8.56 | 55.00 | 54.6 | 74.00 | -19.4 | Peak |
| 9.678 | 3.0 | 1.34 | h | 8.56 | 55.00 | 53.5 | 74.00 | -20.5 | Peak |
| 9.678 | 31.0 | 1.26 | v | 8.56 | 55.00 | 42.8 | 54.00 | -11.2 | Ave |
| 9.678 | 3.0 | 1.34 | h | 8.56 | 55.00 | 41.9 | 54.00 | -12.1 | Ave |
| 12.06 | 0 | 1.06 | v | 11.03 | 55.00 | 50.9 | 74.00 | -23.1 | Peak |
| 12.06 | 12.0 | 1.24 | h | 11.03 | 55.00 | 49.7 | 74.00 | -24.3 | Peak |
| 12.06 | 0 | 1.06 | v | 11.03 | 55.00 | 41.8 | 54.00 | -12.2 | Ave |
| 12.06 | 12.0 | 1.24 | h | 11.03 | 55.00 | 40.4 | 54.00 | -13.6 | Ave |

Emission was scanned up to 25GHz.

@ 2437MHz @ 3Meter

| Frequency | Direction | Height | Polar | Cable loss | Amplifier | Corrected Reading | 15.247/15.209 | 15.247/15.209 | |
|-----------|-----------|--------|-------|------------|-----------|-------------------|----------------|---------------|----------|
| GHz | Degree | Meter | H / V | (dB) | (dB) | (dBuV/m) | Limit (dBuV/m) | Margin | Comments |
| 4.874 | 31.00 | 1.10 | v | 5.16 | 55.00 | 51.6 | 74.00 | -22.4 | Peak |
| 4.874 | 25.00 | 1.00 | h | 5.16 | 55.00 | 51.3 | 74.00 | -22.7 | Peak |
| 4.874 | 31.00 | 1.10 | v | 5.16 | 55.00 | 44.1 | 54.00 | -9.9 | Ave |
| 4.874 | 25.00 | 1.00 | h | 5.16 | 55.00 | 43.4 | 54.00 | -10.6 | Ave |
| 7.311 | 13.00 | 1.20 | v | 7.31 | 55.00 | 62.0 | 74.00 | -12.0 | Peak |
| 7.311 | 4.00 | 1.03 | h | 7.31 | 55.00 | 60.8 | 74.00 | -13.2 | Peak |
| 7.311 | 13.00 | 1.20 | v | 7.31 | 55.00 | 47.5 | 54.00 | -6.5 | Ave |
| 7.311 | 4.00 | 1.03 | h | 7.31 | 55.00 | 46.4 | 54.00 | -7.6 | Ave |
| 9.748 | 22.0 | 1.30 | v | 8.66 | 55.00 | 54.3 | 74.00 | -19.7 | Peak |
| 9.748 | 7.0 | 1.00 | h | 8.66 | 55.00 | 51.8 | 74.00 | -22.2 | Peak |
| 9.748 | 22.0 | 1.30 | v | 8.66 | 55.00 | 40.6 | 54.00 | -13.4 | Ave |
| 9.748 | 7.0 | 1.00 | h | 8.66 | 55.00 | 41.7 | 54.00 | -12.3 | Ave |
| 12.185 | 0 | 1.20 | v | 11.22 | 55.00 | 51.2 | 74.00 | -23.8 | Peak |
| 12.185 | 0 | 1.08 | h | 11.22 | 55.00 | 52.7 | 74.00 | -21.3 | Peak |
| 12.185 | 0 | 1.20 | v | 11.22 | 55.00 | 43.4 | 54.00 | -10.6 | Ave |
| 12.185 | 0 | 1.08 | h | 11.22 | 55.00 | 42.5 | 54.00 | -11.5 | Ave |

Emission was scanned up to 25GHz.

@ 2462MHz @ 3Meter

| Frequency | Direction | Height | Polar | Cable loss | Amplifier | Corrected Reading | 15.247/15.209 | 15.247/15.209 | |
|-----------|-----------|--------|-------|------------|-----------|-------------------|----------------|---------------|----------|
| GHz | Degree | Meter | H / V | (dB) | (dB) | (dBuV/m) | Limit (dBuV/m) | Margin | Comments |
| 4.924 | 15.00 | 1.07 | v | 5.17 | 55.00 | 51.6 | 74.00 | -22.4 | Peak |
| 4.924 | 25.00 | 1.10 | h | 5.17 | 55.00 | 49.5 | 74.00 | -24.5 | Peak |
| 4.924 | 15.00 | 1.07 | v | 5.17 | 55.00 | 46.3 | 54.00 | -7.7 | Ave |
| 4.924 | 25.00 | 1.10 | h | 5.17 | 55.00 | 44.0 | 54.00 | -10.0 | Ave |
| 7.386 | 0 | 1.20 | v | 7.36 | 55.00 | 60.6 | 74.00 | -13.4 | Peak |
| 7.386 | 3.00 | 1.00 | h | 7.36 | 55.00 | 58.7 | 74.00 | -15.3 | Peak |
| 7.386 | 0 | 1.20 | v | 7.36 | 55.00 | 46.7 | 54.00 | -7.3 | Ave |
| 7.386 | 3.00 | 1.00 | h | 7.36 | 55.00 | 46.4 | 54.00 | -7.6 | Ave |
| 9.848 | 6.00 | 1.10 | v | 8.74 | 55.00 | 53.4 | 74.00 | -20.6 | Peak |
| 9.848 | 21.00 | 1.08 | h | 8.74 | 55.00 | 51.7 | 74.00 | -22.3 | Peak |
| 9.848 | 6.00 | 1.10 | v | 8.74 | 55.00 | 42.4 | 54.00 | -11.6 | Ave |
| 9.848 | 21.00 | 1.08 | h | 8.74 | 55.00 | 41.8 | 54.00 | -12.2 | Ave |
| 12.31 | 4.00 | 1.34 | v | 11.39 | 55.00 | 51.6 | 74.00 | -22.4 | Peak |
| 12.31 | 9.00 | 1.27 | h | 11.39 | 55.00 | 50.3 | 74.00 | -23.7 | Peak |
| 12.31 | 4.00 | 1.34 | v | 11.39 | 55.00 | 41.8 | 54.00 | -12.2 | Ave |
| 12.31 | 9.00 | 1.27 | h | 11.39 | 55.00 | 40.9 | 54.00 | -13.1 | Ave |

Emission was scanned up to 25GHz.

Mode: 802.11n-40MHz

@ 2412MHz @ 3 Meter

| Frequency | Direction | Height | Polar | Cable loss | Amplifier | Corrected Reading | 15.247/15.209 | 15.247/15.209 | |
|-----------|-----------|--------|-------|------------|-----------|-------------------|----------------|---------------|----------|
| GHz | Degree | Meter | H / V | (dB) | (dB) | (dBuV/m) | Limit (dBuV/m) | Margin | Comments |
| 4.824 | 9.00 | 1.07 | v | 5.15 | 55.00 | 54.7 | 74.00 | -19.3 | Peak |
| 4.824 | 12.00 | 1.10 | h | 5.15 | 55.00 | 51.6 | 74.00 | -22.4 | Peak |
| 4.824 | 9.00 | 1.07 | v | 5.15 | 55.00 | 41.4 | 54.00 | -12.6 | Ave |
| 4.824 | 12.00 | 1.10 | h | 5.15 | 55.00 | 40.0 | 54.00 | -14.0 | Ave |
| 7.236 | 5.30 | 1.12 | v | 7.23 | 55.00 | 64.2 | 74.00 | -9.8 | Peak |
| 7.236 | 6.11 | 1.15 | h | 7.23 | 55.00 | 62.8 | 74.00 | -11.2 | Peak |
| 7.236 | 5.30 | 1.12 | v | 7.23 | 55.00 | 48.1 | 54.00 | -5.9 | Ave |
| 7.236 | 6.11 | 1.15 | h | 7.23 | 55.00 | 47.4 | 54.00 | -6.6 | Ave |
| 9.678 | 31.0 | 1.26 | v | 8.56 | 55.00 | 54.6 | 74.00 | -19.4 | Peak |
| 9.678 | 3.0 | 1.34 | h | 8.56 | 55.00 | 53.5 | 74.00 | -20.5 | Peak |
| 9.678 | 31.0 | 1.26 | v | 8.56 | 55.00 | 42.8 | 54.00 | -11.2 | Ave |
| 9.678 | 3.0 | 1.34 | h | 8.56 | 55.00 | 41.9 | 54.00 | -12.1 | Ave |
| 12.06 | 0 | 1.06 | v | 11.03 | 55.00 | 50.9 | 74.00 | -23.1 | Peak |
| 12.06 | 12.0 | 1.24 | h | 11.03 | 55.00 | 49.7 | 74.00 | -24.3 | Peak |
| 12.06 | 0 | 1.06 | v | 11.03 | 55.00 | 41.8 | 54.00 | -12.2 | Ave |
| 12.06 | 12.0 | 1.24 | h | 11.03 | 55.00 | 40.4 | 54.00 | -13.6 | Ave |

Emission was scanned up to 25GHz.

@ 2437MHz @ 3Meter

| Frequency | Direction | Height | Polar | Cable loss | Amplifier | Corrected Reading | 15.247/15.209 | 15.247/15.209 | |
|-----------|-----------|--------|-------|------------|-----------|-------------------|----------------|---------------|----------|
| GHz | Degree | Meter | H / V | (dB) | (dB) | (dBuV/m) | Limit (dBuV/m) | Margin | Comments |
| 4.874 | 31.00 | 1.10 | v | 5.16 | 55.00 | 53.5 | 74.00 | -20.5 | Peak |
| 4.874 | 25.00 | 1.00 | h | 5.16 | 55.00 | 52.0 | 74.00 | -22.0 | Peak |
| 4.874 | 31.00 | 1.10 | v | 5.16 | 55.00 | 44.9 | 54.00 | -9.1 | Ave |
| 4.874 | 25.00 | 1.00 | h | 5.16 | 55.00 | 43.1 | 54.00 | -10.9 | Ave |
| 7.311 | 13.00 | 1.20 | v | 7.31 | 55.00 | 65.6 | 74.00 | -8.4 | Peak |
| 7.311 | 4.00 | 1.03 | h | 7.31 | 55.00 | 63.4 | 74.00 | -10.6 | Peak |
| 7.311 | 13.00 | 1.20 | v | 7.31 | 55.00 | 49.6 | 54.00 | -4.4 | Ave |
| 7.311 | 4.00 | 1.03 | h | 7.31 | 55.00 | 48.3 | 54.00 | -5.7 | Ave |
| 9.748 | 22.0 | 1.30 | v | 8.66 | 55.00 | 56.5 | 74.00 | -17.5 | Peak |
| 9.748 | 7.0 | 1.00 | h | 8.66 | 55.00 | 54.2 | 74.00 | -19.8 | Peak |
| 9.748 | 22.0 | 1.30 | v | 8.66 | 55.00 | 42.4 | 54.00 | -11.6 | Ave |
| 9.748 | 7.0 | 1.00 | h | 8.66 | 55.00 | 44.1 | 54.00 | -19.9 | Ave |
| 12.185 | 0 | 1.20 | v | 11.22 | 55.00 | 51.9 | 74.00 | -22.1 | Peak |
| 12.185 | 0 | 1.08 | h | 11.22 | 55.00 | 52.7 | 74.00 | -21.3 | Peak |
| 12.185 | 0 | 1.20 | v | 11.22 | 55.00 | 43.7 | 54.00 | -10.3 | Ave |
| 12.185 | 0 | 1.08 | h | 11.22 | 55.00 | 41.9 | 54.00 | -12.1 | Ave |

Emission was scanned up to 25GHz.

@ 2462MHz @ 3Meter

| Frequency | Direction | Height | Polar | Cable loss | Amplifier | Corrected Reading | 15.247/15.209 | 15.247/15.209 | |
|-----------|-----------|--------|-------|------------|-----------|-------------------|----------------|---------------|----------|
| GHz | Degree | Meter | H / V | (dB) | (dB) | (dBuV/m) | Limit (dBuV/m) | Margin | Comments |
| 4.924 | 15.00 | 1.07 | v | 5.17 | 55.00 | 55.8 | 74.00 | -18.2 | Peak |
| 4.924 | 25.00 | 1.10 | h | 5.17 | 55.00 | 54.3 | 74.00 | -19.7 | Peak |
| 4.924 | 15.00 | 1.07 | v | 5.17 | 55.00 | 46.4 | 54.00 | -7.6 | Ave |
| 4.924 | 25.00 | 1.10 | h | 5.17 | 55.00 | 44.3 | 54.00 | -9.7 | Ave |
| 7.386 | 0 | 1.20 | v | 7.36 | 55.00 | 64.8 | 74.00 | -9.2 | Peak |
| 7.386 | 3.00 | 1.00 | h | 7.36 | 55.00 | 63.1 | 74.00 | -10.9 | Peak |
| 7.386 | 0 | 1.20 | v | 7.36 | 55.00 | 48.2 | 54.00 | -5.8 | Ave |
| 7.386 | 3.00 | 1.00 | h | 7.36 | 55.00 | 47.0 | 54.00 | -7.0 | Ave |
| 9.848 | 6.00 | 1.10 | v | 8.74 | 55.00 | 56.9 | 74.00 | -17.1 | Peak |
| 9.848 | 21.00 | 1.08 | h | 8.74 | 55.00 | 53.4 | 74.00 | -20.6 | Peak |
| 9.848 | 6.00 | 1.10 | v | 8.74 | 55.00 | 43.6 | 54.00 | -10.4 | Ave |
| 9.848 | 21.00 | 1.08 | h | 8.74 | 55.00 | 44.0 | 54.00 | -10.0 | Ave |
| 12.31 | 4.00 | 1.34 | v | 11.39 | 55.00 | 52.1 | 74.00 | -21.9 | Peak |
| 12.31 | 9.00 | 1.27 | h | 11.39 | 55.00 | 50.9 | 74.00 | -23.1 | Peak |
| 12.31 | 4.00 | 1.34 | v | 11.39 | 55.00 | 43.4 | 54.00 | -10.6 | Ave |
| 12.31 | 9.00 | 1.27 | h | 11.39 | 55.00 | 42.0 | 54.00 | -12.0 | Ave |

Emission was scanned up to 25GHz.

Annex A. TEST INSTRUMENT & METHOD

Annex A.i. TEST INSTRUMENTATION & GENERAL PROCEDURES

| Instrument | Manufacturer | Model | CAL Due Date |
|---------------------------------|-----------------|----------------------------|--------------|
| Spectrum Analyzer | HP | 8564 E | 2011.04.26 |
| EMI Receiver | Rohde & Schwarz | ESPI 3 | 2011.02.19 |
| Antenna (30MHz~2GHz) | Sunol Sciences | JB1 | 2011.10.04 |
| Horn Antenna (1~18GHz) | A-INFOMW | JXTXLB-10180 | 2011.11.18 |
| Horn Antenna (1~18GHz) | N/A | N/A | 2011.10.04 |
| Pre-Amplifier(0.01 ~ 1.3GHz) | HP | 8447F | 2011.04.24 |
| Pre-Amplifier(0.1 ~ 18GHz) | MITEQ | AMF-7D-00101800-30- 10P | 2011.03.05 |
| Horn Antenna (18~40GHz) | Com Power | AH-840 | 2011.05.21 |
| Microwave Pre-Amp (18~40GHz) | Com Power | PA-840 | 2011.05.21 |

Annex A.ii. CONDUCTED EMISSIONS TEST DESCRIPTION

Test Set-up

1. The EUT and supporting equipment were set up in accordance with the requirements of the standard on top of a 1.5m x 1m x 0.8m high, non-metallic table, as shown in Annex B.
2. The power supply for the EUT was fed through a 50Ω/50μH EUT LISN, connected to filtered mains.
3. The RF OUT of the EUT LISN was connected to the EMI test receiver via a low-loss coaxial cable.
4. All other supporting equipments were powered separately from another main supply.

Test Method

1. The EUT was switched on and allowed to warm up to its normal operating condition.
2. A scan was made on the NEUTRAL line (for AC mains) or Earth line (for DC power) over the required frequency range using an EMI test receiver.
3. High peaks, relative to the limit line, were then selected.
4. The EMI test receiver was then tuned to the selected frequencies and the necessary measurements made with a receiver bandwidth setting of 10 KHz. For FCC tests, only Quasi-peak measurements were made; while for CISPR/EN tests, both Quasi-peak and Average measurements were made.
5. Steps 2 to 4 were then repeated for the LIVE line (for AC mains) or DC line (for DC power).

Sample Calculation Example

At 20 MHz limit = 250 μV = 47.96 dBμV

Transducer factor of LISN, pulse limiter & cable loss at 20 MHz = 11.20 dB

Q-P reading obtained directly from EMI Receiver = 40.00 dBμV
(Calibrated for system losses)

Therefore, Q-P margin = 47.96 – 40.00 = 7.96 i.e. **7.96 dB below limit**

Annex A. iii RADIATED EMISSIONS TEST DESCRIPTION

EUT Characterisation

EUT characterisation, over the frequency range from 30MHz to 10th Harmonic , was done in order to minimise radiated emissions testing time while still maintaining high confidence in the test results.

The EUT was placed in the chamber, at a height of about 0.8m on a turntable. Its radiated emissions frequency profile was observed, using a spectrum analyzer /receiver with the appropriate broadband antenna placed 3m away from the EUT. Radiated emissions from the EUT were maximised by rotating the turntable manually, changing the antenna polarisation and manipulating the EUT cables while observing the frequency profile on the spectrum analyzer / receiver. Frequency points at which maximum emissions occurred, clock frequencies and operating frequencies were then noted for the formal radiated emissions test at the Open Area Test Site (OATS).

Test Set-up

1. The EUT and supporting equipment were set up in accordance with the requirements of the standard on top of a 1.5m X 1.0m X 0.8m high, non-metallic table.
2. The filtered power supply for the EUT and supporting equipment were tapped from the appropriate power sockets located on the turntable.
3. The relevant broadband antenna was set at the required test distance away from the EUT and supporting equipment boundary.

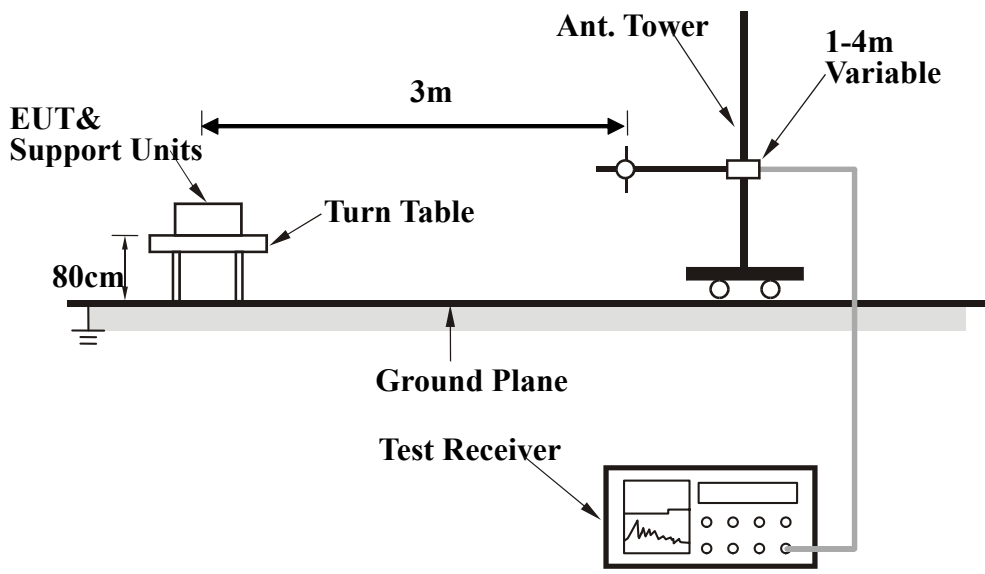

Test Method

The following procedure was performed to determine the maximum emission axis of EUT:

1. With the receiving antenna is H polarization, rotate the EUT in turns with three orthogonal axes to determine the axis of maximum emission.
2. With the receiving antenna is V polarization, rotate the EUT in turns with three orthogonal axes to determine the axis of maximum emission.
3. Compare the results derived from above two steps. So, the axis of maximum emission from EUT was determined and the configuration was used to perform the final measurement.

Final Radiated Emission Measurement

1. Setup the configuration according to figure 1. Turn on EUT and make sure that it is in normal function.
2. For emission frequencies measured below 1 GHz, a pre-scan is performed in a shielded chamber to determine the accurate frequencies of higher emissions will be checked on a open test site. As the same purpose, for emission frequencies measured above 1 GHz, a pre-scan also be performed with a 1 meter measuring distance before final test.
3. For emission frequencies measured below and above 1 GHz, set the spectrum analyzer on a 100 kHz and 1 MHz resolution bandwidth respectively for each frequency measured in step 2.
4. The search antenna is to be raised and lowered over a range from 1 to 4 meters in horizontally polarized orientation. Position the highness when the highest value is indicated on spectrum analyzer, then change the orientation of EUT on test table over a range from 0 ° to 360 ° with a speed as slow as possible, and keep the azimuth that highest emission is indicated on the spectrum analyzer. Vary the antenna position again and record the highest value as a final reading.
5. Repeat step 4 until all frequencies need to be measured were complete.
6. Repeat step 5 with search antenna in vertical polarized orientations.

During the radiated emission test, the Spectrum Analyzer was set with the following configurations:

| Frequency Band (MHz) | Function | Resolution bandwidth | Video Bandwidth |
|----------------------|----------|----------------------|-----------------|
| 30 to 1000 | Peak | 100 kHz | 100 kHz |
| Above 1000 | Peak | 1 MHz | 1 MHz |
| | Average | 1 MHz | 10 Hz |

Sample Calculation Example

The field strength is calculated by adding the Antenna Factor and Cable Factor, and subtracting the Amplifier Gain (if any) from the measured reading. For the limit is employed average value, therefore the peak value can be transferred to average value by subtracting the duty factor. The basic equation with a sample calculation is as follows:

$$\text{Peak} = \text{Reading} + \text{Corrected Factor}$$

where

$$\text{Corr. Factor} = \text{Antenna Factor} + \text{Cable Factor} - \text{Amplifier Gain (if any)}$$

And the average value is

$$\text{Average} = \text{Peak Value} + \text{Duty Factor or}$$

$$\text{Set RBW} = 1\text{MHz, VBW} = 10\text{Hz.}$$

Note :

If the measured frequencies are fall in the restricted frequency band, the limit employed must be quasi peak value when frequencies are below or equal to 1 GHz. And the measuring instrument is set to quasi peak detector function.



SIEMIC, INC.

Accessing global markets

Title: RF Test Report for Wifi Modular
Model: MR100
To: FCC 15.247:2009

Serial#: 10021272
Issue Date: 13 January 2011
Page: 84 of 113
www.siemic.com.cn

Annex B. EUT AND TEST SETUP PHOTOGRAPHS

Please see attachment

Annex C. TEST SETUP AND SUPPORTING EQUIPMENT

EUT TEST CONDITIONS

Annex C. i. SUPPORTING EQUIPMENT DESCRIPTION

The following is a description of supporting equipment and details of cables used with the EUT.

| Equipment Description (Including Brand Name) | Model & Serial Number | Cable Description (List Length, Type & Purpose) |
|---|-----------------------|--|
| PC | N/A | N/A |



Block Configuration Diagram for Radiated Emission

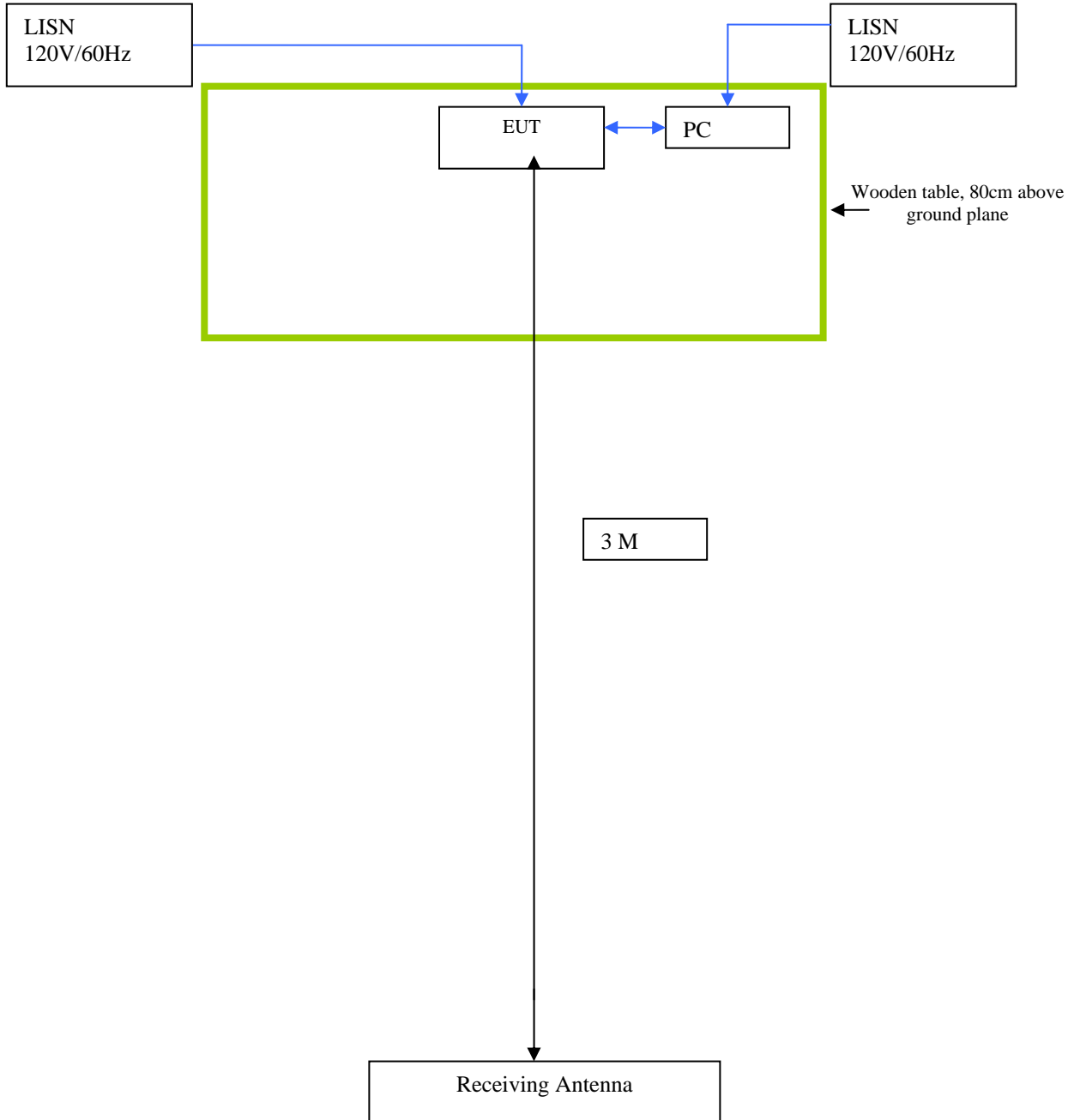

Block Configuration Diagram for Conducted Emission

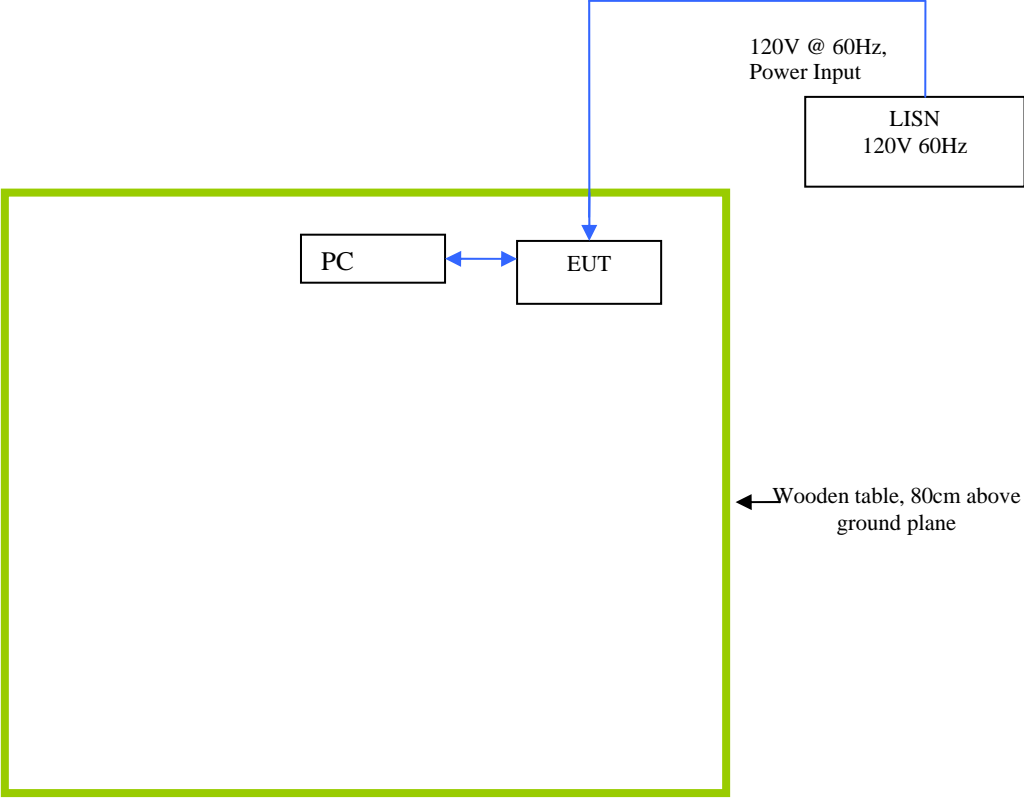

Annex C.ii. EUT OPERATING CONDITIONS

The following is the description of how the EUT is exercised during testing.

| Test | Description Of Operation |
|-----------|--|
| Emissions | The EUT was continuously transmitting to stimulate the worst case. |



SIEMIC, INC.

Accessing global markets

Title: RF Test Report for Wifi Modular
Model: MR100
To: FCC 15.247:2009

Serial#: 10021272
Issue Date: 13 January 2011
Page: 89 of 113
www.siemec.com.cn

Annex D. USER MANUAL / BLOCK DIAGRAM / SCHEMATICS / PART LIST

Please see attachment

Annex E SIEMIC ACCREDITATION

SIEMIC ACREDITATION DETAILS: A2LA 17025 & ISO Guide 65 : 2742.01 , 2742.2



The American Association for Laboratory Accreditation

World Class Accreditation

Accredited Laboratory

A2LA has accredited

SIEMIC LABORATORIES

San Jose, CA

for technical competence in the field of

Electrical Testing

This laboratory is accredited in accordance with the recognized International Standard ISO/IEC 17025:2005 *General Requirements for the Competence of Testing and Calibration Laboratories*. This accreditation demonstrates technical competence for a defined scope and the operation of a laboratory quality management system (refer to joint ISO-ILAC-LAF Communiqué dated 8 January 2009).

Presented this 23rd day of November 2010.



Peter Abney

President & CEO
For the Accreditation Council
Certificate Number 2742.01
Valid to September 30, 2012

For the tests or types of tests to which this accreditation applies, please refer to the laboratory's Electrical Scope of Accreditation.



The American Association for Laboratory Accreditation

SCOPE OF ACCREDITATION TO ISO/IEC 17025:2005

SIEMIC LABORATORIES ¹
2206 Ringwood Ave.
San Jose, CA 95131
Mr. Leslie Bai Phone: 408 526 1188 Email: leslie.bai@siemic.com
Mr. Snell Leong Phone: 408 526 1188 Email: snell.leong@siemic.com
www.siemic.com

ELECTRICAL

Valid to: September 30, 2012

Certificate Number: 2742.01

In recognition of the successful completion of the A2LA evaluation process, accreditation is granted to this laboratory to perform the following EMC, Product Safety, Radio and Telecommunication tests:

| Test Description: | Test Method: |
|---------------------------------|---|
| EN & IEC – Emissions & Immunity | IEC/CISPR 11; IEC/CISPR 12; EN 55011; IEC/CISPR 22; EN 55022; IEC/CISPR 20; EN 55020; EN 61000-6-1; EN 61000-6-2; EN 61000-6-3; EN 61000-6-4; EN 61204-3; EN 61326, EN 61326-1; EN 61000-3-2; EN 61000-3-3; EN 50081-1, EN 50081-2; EN 50082-1; IEC 61000-4-2; EN 61000-4-2; IEC 61000-4-3 (limited up to 2.7 GHz and 3V/m); EN 61000-4-3; (limited up to 2.7 GHz and 3V/m); IEC 61000-4-4; EN 61000-4-4; IEC 61000-4-5; EN 61000-4-5; IEC 61000-4-6; EN 61000-4-6; IEC 61000-4-8; EN 61000-4-8; IEC 61000-4-11; EN 61000-4-11; IEC/CISPR 24; EN 55024; EN 50412-2-1; EN 50083-2; EN 50090-2-2; EN 50091-2; EN 50130-4; EN 50130-4 +A12; IEC 60601-1-2; EN 12184; EN 55015; EN 61547; CISPR 16-1-4 |
| Korea – Emissions & Immunity | KCC Notice 2009-27, Nov. 5, 2009; RRA Announce 2009-9, Dec. 21, 2009; KN 22:2007-12; KCC Notice 2009-27, Nov. 5, 2009; RRA Notice 2009-10, Dec. 21, 2009; KN 24:2008-5; KN 61000-4-2:2008-5; KN 61000-4-3:2008-5; KN 61000-4-4:2008-5; KN 61000-4-5:2008-5; KN 61000-4-6:2008-5; KN 61000-4-8:2008-5; KN 61000-4-11:2008-5; RRL Notice 2008-3; RRL Notice 2008-4; RRL Notice 2005-131; RRL Notice 2007-99; RRL Notice 2007-101; RRL Notice 2008-4; RRA Notice No 2008-11(2008.12.16); RRA Notice No 2008-12(2008.12.16); KN 60601-1-2; KCC Notice 2009-27; KN 301 489-1(2008-05); KN 301 489-7(2008-05); KN 301 489-17(2008-05); KN 301 489-24(2008-05); KN 16-1-1(2008-05); KN 16-1-2(2008-05); KN 16-1-3(2008-05); KN 16-1-4(2008-05); KN 16-1-5(2008-05); KN 16-2-1(2008-05); KN 16-2-2(2008-05); KN 16-2-3(2008-05); KN 16-2-4(2008-05) |

(A2LA Certificate No. 2742.01) 11/23/2010

Page 1 of 7



| | |
|--|---|
| FCC – Emissions | ANSI C63.17:2006; ANSI C63.4(2003) with FCC Method 47 CFR Part 11; ANSI C63.4(2003) with FCC Method 47 CFR Part 15, Subpart E; ANSI C63.4(2003) with FCC Method 47 CFR Part 15, Subpart C; ANSI C63.4(2003) and DA 02-2138; ANSI C63.4(2003) with FCC Method 47 CFR Part 15, Subpart B; ANSI C63.4(2009); ANSI C63.10(2009); FCC Method 47 CFR Part 18, FCC OST/MP-5(1986); FCC Report and Order ET Docket 98-153 (FCC 02-48); FCC Method 47 CFR Part 15, Subpart G, using FCC Order 04-425; FCC Method 47 CFR Parts 11 (Emergency Alert System (EAS)), 15 (Radio Frequency Devices) and 18 (Industrial, Scientific, and Medical Equipment); SAE J1113-11, SAE J1113-12; SAE J1113-41; SAE J1113-4; SAE J1113-13 |
| Canada – Emissions | ICES-001; ICES-002; ICES-003 Issue 4; ICES-003 Issue 4 (2004); ICES-006 Issue 1 |
| Vietnam – Emission & Immunity | TCN 68-193:2003; TCN 68-196:2001; TCVN 7189:2002 |
| Australia / New Zealand – Emissions and Immunity | AS/NZS 1044; AS/NZS 4251.1; AS/NZS 4251.2; AS/NZS CISPR 22; AS/NZS 3548; AS/NZS 2279.3; AS/NZS 61000-3-3; AS/NZS CISPR 11; AS/NZS CISPR 24; AS/NZS 61000.6.3; AS/NZS 61000.6.4; AS/NZS CISPR 14.1; AS/NZS 61000.3.2 |
| Japan – Emissions | JEITA IT-3001; VCCI-V-3:2010.4 (up to 6 GHz) |
| China – Emissions | GB9254; GB17625.1 |
| Taiwan – Emissions | CNS 13438 (up to 6 GHz); CNS 13783-1; CNS 13803; CNS 13439 |
| Singapore – Emissions & Immunity | IDA TS EMC; CISPR 22; IEC 61000-4-2; IEC 61000-4-3; IEC 61000-4-4; IEC 61000-4-5; IEC 61000-4-6 |
| FCC – Radio TIA/EIA 603-C with 47 CFR Part 2 | Maritime and Aviation Radio Services in 47 CFR Parts 80 and 87; Personal Mobile Radio Services in 47 CFR Parts 22 (cellular), 24, 25, 26, and 27; Personal Mobile Radio Services in 47 CFR Part 22 (cellular) and Part 24 – [limited to TX conducted and radiated power and RX - TX radiated spurious emissions]; General Mobile Radio Services in 47 CFR Parts 22 (non-cellular), 74, 90, 95, and 97; General Mobile Radio Services in 47 CFR Part 90; Microwave Radio Services in 47 CFR Parts 21, 27, 74, and 101 |
| Canada – Radio | RSS 102; RSS 111; RSS 112; RSS 117; RSS 118; RSS 119; RSS 123; RSS 125; RSS 127; RSS 128; RSS 129; RSS 131; RSS 132; RSS 133; RSS 134; RSS 135; RSS 136; RSS 137; RSS 138; RSS 139; RSS 141; RSS 142; RSS 170; RSS 181; RSS 182; RSS 188; RSS 191; RSS 192; RSS 193; RSS 194; RSS 195; RSS 196; RSS 197; RSS 198; RSS 199; RSS 210; RSS 220; RSS 213; RSS 215; RSS 243; RSS 287; RSS 310; RSS Gen |



| | |
|-----------------|---|
| CE – Radio | <p>EN 301 502; EN 301 511; EN 301 526; EN 301 681; EN 301 721; EN 301 751; EN 301 753; EN 301 783-2; EN 301 796; EN 301 797; EN 301 840-2; EN 301 843-1; EN 301 843-4; EN 301 843-5; EN 301 893; EN 301 908-01; EN 301 908-02; EN 301 908-03; EN 301 908-04; EN 301 908-05; EN 301 908-06; EN 301 908-07; EN 301 908-08; EN 301 908-09; EN 301 908-10; EN 301 908-11; EN 301 929-2; EN 301 997-2; EN 302 018-2; EN 302 054-2; EN 302 064-2; EN 302 066-2; EN 302 077-2; EN 302 186; EN 302 195-2; EN 302 217-3; EN 302 245-2; EN 302 288-2; EN 302 291-2; EN 302 296; EN 302 297; EN 302 326-2; EN 302 326-3; EN 302 340; EN 302 372-2; EN 302 426; EN 302 454-2; EN 302 502; EN 302 510-2; EN 302 217-4-2; EN 300 224-1; EN 300 279; EN 300 339; EN 300 385; EN 301 839-2; EN 301 843-6; EN 302 017-2; EN 302 208-2; EN 302 217-2-2; ETS 300 329; ETS 300 445; ETS 300 446; ETS 300 683; ETS 300 826; ETS EN 300 328; ETSI EN 300 086-2; EN 302217-1; EN 302217-2-1; EN 302217-4-1; EN 302288-1; EN 302908-12; EN 302326-1; EN 301929-1; EN 301997-1; EN 300224-2; EN 301839-1; EN 301843-1; EN 301843-2; EN 301843-3; EN 301843-4; EN 301843-5; EN 302017-1; EN 302208-1; EN 300086-1; EN 300113-1; EN 300224-1; EN 300341-1; EN 302291-1; EN 302500-1; EN 302500-2; ETSI EN 300 113-2; ETSI EN 300 197; ETSI EN 300 198; ETSI EN 300 219-1; ETSI EN 300 219-2; ETSI EN 300 220-1; ETSI EN 300 220-2; ETSI EN 300 220-3; ETSI EN 300 224-2; ETSI EN 300 296-1; ETSI EN 300 296-2; ETSI EN 300 328-1; ETSI EN 300 328-2; ETSI EN 300 330; ETSI EN 300 330-1; ETSI EN 300 330-2; ETSI EN 300 341-2; ETSI EN 300 373-1; ETSI EN 300 373-2; ETSI EN 300 373-3; ETSI EN 300 390-1; ETSI EN 300 390-2; ETSI EN 300 422-1; ETSI EN 300 422-2; ETSI EN 300 431; ETSI EN 300 440-1; ETSI EN 300 440-2; ETSI EN 300 454-1; ETSI EN 300 454-2; ETSI EN 300 718-2; ETSI EN 301 021; ETSI EN 301 166-1; ETSI EN 301 166-2; ETSI EN 301 178-2; ETSI EN 301 213-1; ETSI EN 301 213-2; ETSI EN 301 213-3; ETSI EN 301 213-4; ETSI EN 301 213-5; ETSI EN 301 357-1; ETSI EN 301 357-2; ETSI EN 301 390; ETSI EN 301 459; ETSI EN 301 489-01(excluding section 9.6); ETSI EN 301 489-02; ETSI EN 301 489-03; ETSI EN 301 489-04; ETSI EN 301 489-05; ETSI EN 301 489-06; ETSI EN 301 489-07; ETSI EN 301 489-08; ETSI EN 301 489-09; ETSI EN 301 489-10; ETSI EN 301 489-11; ETSI EN 301 489-12; ETSI EN 301 489-13; ETSI EN 301 489-14; ETSI EN 301 489-15; ETSI EN 301 489-16; ETSI EN 301 489-17; ETSI EN 301 489-18; ETSI EN 301 489-19; ETSI EN 301 489-20; ETSI EN 301 489-22; ETSI EN 301 489-23; ETSI EN 301 489-24; ETSI EN 301 489-25; ETSI EN 301 489-26; ETSI EN 301 489-27; ETSI EN 301 489-28; ETSI EN 301 489-31; ETSI EN 301 489-32; IEC 60945</p> |
| IDA – Radio | <p>IDA TS 3G-BS; IDA TS 3G-MT; IDA TS AR; IDA TS CT-CTS; IDA TS GMPCS; IDA TS GSM-BS; IDA TS GSM-MT; IDA TS LMR; IDA TS RPG; IDA TS SRD; IDA TS UWB; IDA TS WBA</p> |
| Vietnam – Radio | <p>TCN 68-242:2006; TCN 68-243:2006; TCN 68-246:2006</p> |



| | |
|---------------------------------|---|
| Korea – Radio | KCC Notice 2009-13; KCC Notice 2008-26; RRL Notice 2008-2; RRL Notice 2005-105; RRL Notice 2008-17; RRL Notice 2005-127; RRL Notice 2005-24; RRL Notice 2005-25; RRL Notice 2005-179; RRL Notice 2008-10; RRL Notice 2007-49; RRL Notice 2007-20; RRL Notice 2007-11; RRL Notice 2007-80; RRL Notice 2004-68; KCC Notice 2009-36, Dec. 8, 2009; RRL Notice 2009-6, October 15, 2009; KCC Notice 2010-1; KCC Notice 2010-12; KCC Notice 2010-13 |
| Taiwan – Radio | LP0002; PLMN07; PLMN01; PLMN08 |
| Australia - New Zealand – Radio | AS 2772.2; AS/NZS 4281; AS/NZS 4268; AS/NZS 4280.1; AS/NZS 4583; AS/NZS 4280.2; AS/NZS 4281; AS/NZS 4295; AS/NZS 4582; AS/NZS 4769.1; AS/NZS 4769.2; AS/NZS 4770; AS/NZS 4771 |
| Hong Kong – Radio | HKTA 1002; HKTA 1007; HKTA 1008; HKTA 1010; HKTA 1015; HKTA 1016; HKTA 1020; HKTA 1022; HKTA 1026; HKTA 1027; HKTA 1029; HKTA 1030; HKTA 1031; HKTA 1032; HKTA 1033; HKTA 1034; HKTA 1035; HKTA 1036; HKTA 1037; HKTA 1039; HKTA 1041; HKTA 1042; HKTA 1043; HKTA 1044; HKTA 1046; HKTA 1047; HKTA 1048; HKTA 1049; HKTA 1051; HKTA1052; HKTA1053; HKTA 1054; HKTA 1055 |
| USA – Telecom | ANSI/TIA-968-A:03; ANSI/TIA-968-A-1:03; ANSI/TIA-968-A-2:04; ANSI/TIA-968-A-3:05; ANSI/TIA-968-A-4:07; ANSI/TIA-968-A-5:07; TIA-968-B; FCC Rule Part 68; 47 CFR Part 68.316; 47 CFR Part 68.317; ANSI/TIA/EIA-464-C; TIA-810-B; T1.TRQ6 (2002); TCB-31-B (1998); TIA-470.110-C; TIA-810-B; TIA-920 |
| Canada – Telecom | CS-03 Part V Issue 9:2009 Amendment 1; CS-03 Part VIII Issue 9:2009 Amendment 4; CS-03 Part I Issue 9:2006 Amendment 3; CS-03 Part II Issue 9:2004; CS-03 Part III Issue 9:2004; CS-03 Part V Issue 9:2004 ; CS-03 Part VI Issue 9:2004; CS-03 Part VII Issue 9:2006 Amendment 3; CS-03 Part VIII Issue 9:2007 Amendment 3; CS-03 Issue 9:04 + A2(06) + A3(06) |
| Europe – Telecom | TBR 2: 01-1997; TBR 004 Ed.1.95 + A1 (97); TBR 1; TBR 3; TBR 12:A1 01-1996; TBR 013 ed.1; TBR 024 ed.1; TBR 25; TBR 38 ed.1; ETSI ES 203 021-05 ; ETSI ES 203 021-2 ; ETSI ES 021-3; TBR 021; ETSI EG 201 121; ETSI EN 301 437; ETSI TS 101 270-1; ITU-T Recommendation Q.920; ITU-T Recommendation Q.920 – Amendment 1; ITU-T Recommendation Q.921; ITU-T Recommendation Q.921 – Amendment 1; ITU-T Recommendation Q.931; ITU-T Recommendation Q.931 – Amendment 1; Erratum 1 (02/2003) ITU-T Recommendation Q.931 (05/1998); ISDN User Network Interface Layer 3 Specification for Basic Call Control; ITU-T Recommendation P.300 |
| Australia –Telecom | AS/CA S003.1:2010; AS/CA S003.2:2010; AS/CA S003.3:2010; AS/CA S004:2010; AS/ACIF S006:2008; AS/ACIF S041.1:2009 |



| | |
|------------------------|---|
| Australia – Telecom | AS/ACIF S041.2:2009; AS/ACIF S041.3:2009; AS/ACIF S042.1:2008; AS/ACIF S043.2:2008; AS/ACIF S043.3:2008; AS/ACIF S002:05; AS/ACIF S003:06; AS/ACIF S004:06; AS/ACIF S006:01; AS/ACIF S016:01; AS/ACIF S031:01; AS/ACIF S038:01; AS/ACIF S040:01; AS/ACIF S041:05; AS/ACIF S043.2:06; AS ACIF S042.1 |
| New Zealand – Telecom | PTC200:2006; PTC200 Issue No.2:97 + A1(980); PTC220; PTC273:2007; TNA 115; TNA 117 |
| Singapore – Telecom | IDA TS ADSL, Issue 1, Rev. 1 (April 2006); IDA TS DLCN, Issue 1 (July 2005); IDA TS ISDN BA, Issue 1 (July 2005); IDA TS ISDN PRA, Issue 1 (July 2005); IDA TS ISDN 3 (Oct. 2000); IDA TS-PSTN, Issue 1 (March 2007); IDA TS ACLIP 07 |
| Hong Kong – Telecom | HKTA 2011; HKTA 2012; HKTA 2013; HKTA 2014; HKTA 2017; HKTA 2018; HKTA 2022; HKTA 2024; HKTA 2026; HKTA 2027; HKTA 2028; HKTA 2029; HKTA 2030; HKTA 2031; HKTA 2032; HKTA 2033 |
| Vietnam – Telecom | TCN 68-188:2000; TCN 68-193:2003; TCN 68-196:2001; TCN 68-143:2003; TCN 68-192:2003; TCN 68-189:2000; TCN 68-221:2004; TCN 68-222:2004; TCN 68-245:2004; TCN 68-223:2004 |
| Korea – Telecom | RRA Notice 2009-38, Sep. 11, 2009; RRA Notice 2009-7 (including attachments 1, 3, 5, 6); Presidential Decree 21098, RRL Notice 2007-30; RRL Notice 2008-10 (attachments 1, 3, 5, 6); RRL Notice 2009-25; RRL Notice 2008-59 |
| China – Telecom | YD/T 514-1:98; YD/T 1277.1-2003; GB/T 17904.1-1999; GB/T 17904.2-1999; GB/T 17154.1-1997; GB/T 17154.2-1997; YD/T1091-2000; YD/T1006-1999; GB/T 17789-1999 |
| Taiwan – Telecom | PSTN01:03; ADSL01:08; ID0002; IS6100: 93 |
| Japan – Telecom | JATE Blue Book, Green Book; Ministerial Ordinance of the Ministry of Posts and Telecommunications No. 31 of April 1, 1985 (last amended on March 22 2004); Ordinance Concerning Technical Conditions Compliance Approval etc. of Terminal Equipment |
| South Africa – Telecom | DPT-TE-001; TE-002; TE-003; TE-004; TE-005; TE-006; TE-007; TE-008; TE-009; TE-010; TE-012 (telephone interface); TE-013 (telephone interface); TE-014; TE-015; TE-018; SWS-001; SWS-002; SWS-003; SWS-004; SWS-005; SWS-006; SWS-007; SWS-008; SWS-009; SWS-010 |
| Israel – Telecom | Israel MoC Spe. 23/96 |



| | |
|---|--|
| Mexico – Telecom | NOM-151-SCT1-1999; NOM-152-SCT1-1999 |
| Argentina – Telecom | CNC-ST2-44-01 |
| Brazil – Telecom | Resolution 392-2005 |
| International Telecom Union | ITU-T-G.703.01; ITU-T-G.823-93; ITU-T G.824; ITU-T G.825; ITU-T-G.991.2; ITU-T-G.992.1; ITU-T-G.992.3; ITU-T-G.992.5; ITU-T-G.993.1 |
| Product Safety | IEC 60950-1; EN 60950-1; UL 60950-1; IEC 60601-1-1; CAN/CSA 22.2 NO. 60950-1-03; SS-EN 60950-1; AS/NZ 60950-1, (voltage surge testing up to 6kV, excluding Annex A and H); CNS 14336, CNS 14408; GB4943; President Notice 20664; RRL Notice 2008-10 (attachment 4); RRA Notice 2009-7 (attachment 4); TCN 68-190:2003; SABS IEC 60950; IEC/EN 61558; IEC/EN 61558-2-7; EN 62115; IEC 60215; EN 60958; EN 60598; IEC 215 (1987) + A1 (1992) + A2 (1994) |
| Japan - Radio | ARIB STD-T81; ARIB STD-T66; RCR STD-1; RCR STD-29; ARIB STD-T94 Fascicle 1; ARIB STD-T90; ARIB STD-T89; RCR STD-33 |
| SAR & HAC | IEEE P1528:2003 + Ad1; IEEE 1528A:2005; FCC OET Bulletin 65 Supplement C; FCC OET Bulletin 65; ANSI C95; ANSI C63.19; FCC 47 CFR 20.19; H46-2/99-273E; EN 50360; EN 50361; IEC62209-1; IEC 62209-2; EN 50371; EN 50383; EN 50357; EN 50364; RRL 2008-18; RRL 2008-16; KCC 2009-27; RRL 2004-67; CNS 14959; NZS 2772.1; NZS 6609.2; Resolution N 533 |
| Japan – Notification No. 88 of MIC 2004 | |
| Table No 13 | CB Radio |
| Table No 21 | Cordless Telephone |
| Table Nos 22-1 thru 22-17 | Low Power Radio Equipment |
| Table No 36 | Low Power Security System |
| Table No 43 | Low Power Data Communication in the 2.4 GHz Band |
| Table No 44 | Low Power Data Communication in the 2.4 GHz Band |
| Table No 45 | Low Power Data Communication in the 5.2, 5.3, 5.6 GHz Bands |
| Table No 46 | Low Power Data Communication in the 25 and 27 GHz Bands |
| Table No 47 | Base Station for 5 GHz Band Wireless Access System |
| Table No 47 | Base Station for 5 GHz Band Wireless Access System (low spurious type) |
| Table No 47 | Land Mobile Relay for 5 GHz Band Wireless Access System (limited for use in special zones) |



| | |
|-------------|---|
| Table No 47 | Land Mobile Relay for 5 GHz Band Wireless Access System (limited for use in special zones, low spurious type) |
| Table No 47 | Land Mobile Relay for 5 GHz Band Wireless Access System |
| Table No 47 | Land Mobile Relay for 5 GHz Band Wireless Access System (low spurious type) |
| Table No 47 | Land Mobile Relay for 5 GHz Band Wireless Access System (low power type) |
| Table No 50 | Digital Cordless Telephone |
| Table No 50 | PHS Base Station |
| Table No 50 | PHS Land Mobile Station |
| Table No 50 | PHS Relay Station |
| Table No 50 | PHS Test Station |
| Table No 64 | Mobile Station for Dedicated Short Range Communication Systems |
| Table No 64 | Base Station for Dedicated Short Range Communication Systems |
| Table No 64 | Test Station for Dedicated Short Range Communication Systems |
| Table No 70 | UWB (Ultra Wide Band) Radio System |

¹Note: This accreditation covers testing performed at the laboratory listed above and the OATS located at 44366 South Grimmer Blvd., Fremont CA 94538. At this site "Radiated Emissions" are tested at a measurement distance of 10m.

*Limitations for listed standards are indicated by italics and Scope excludes protocol sections of applicable standards.



SIEMIC, Inc.

Accessing global markets

Title: RF Test Report for Wifi Modular
Model: MR100
To: FCC 15.247:2009

Serial#: 10021272
Issue Date: 13 January 2011
Page: 98 of 113
www.siemic.com.cn



The American Association for Laboratory Accreditation

World Class Accreditation

Accredited Product Certification Body

A2LA has accredited

SIEMIC LABORATORIES

San Jose, CA

for technical competence as a

Product Certification Body

This product certification body is accredited in accordance with the recognized International Standard ISO/IEC Guide 65:1996 *General requirements for bodies operating product certification systems*. This accreditation demonstrates technical competence for a defined scope and the operation of a quality management system for a Telecommunications Certification Body (TCB) meeting FCC (U.S.), IDA (Singapore), IC (Canada) and OFTA Hong Kong requirements.



Presented this 23rd day of November 2010.

President & CEO
For the Accreditation Council
Certificate Number 2742.01
Valid to September 30, 2012

For the product certification schemes to which this accreditation applies, please refer to the organization's Product Certification Scope of Accreditation.



The American Association for Laboratory Accreditation

SCOPE OF ACCREDITATION TO ISO/IEC GUIDE 65:1996

SIEMIC INC.
2206 Ringwood Ave.
San Jose, CA 95131

Mr. Snell Leong (Authorized Representative) Phone: 408 526 1188
www.siemic.com

PRODUCT CERTIFICATION CONFORMITY ASSESSMENT BODY (CAB)

Valid to: September 30, 2012

Certificate Number: 2742.02

In recognition of the successful completion of the A2LA Certification Body Accreditation Program evaluation, including the US Federal Communications Commission (FCC), Industry Canada (IC), Singapore (IDA) and Hong Kong (OFTA) requirements for the indicated types of product certifications, accreditation is granted to this organization to perform the following product certification schemes:

| <u>Economy</u> | <u>Scope</u> |
|----------------|--------------|
|----------------|--------------|

Federal Communication Commission - (FCC)

| | |
|------------------------------------|----------------|
| Unlicensed Radio Frequency Devices | A1, A2, A3, A4 |
| Licensed Radio Frequency Devices | B1, B2, B3, B4 |
| Telephone Terminal Equipment | C |

*Please refer to FCC TCB Program Roles and Responsibilities, released July 22, 2010 detailing scopes, roles and responsibilities. <http://fjallfoss.fcc.gov/oetcf/kdb/forms/FTSSearchResultPage.cfm?id=44683&switch=P>

Industry Canada - (IC)

| | |
|-------|--|
| Radio | Scope 1-Licence-Exempt Radio Frequency Devices; Scope 2-Licensed Personal Mobile Radio Services; Scope 3-Licensed General Mobile & Fixed Radio Services; Scope 4-Licensed Maritime & Aviation Radio Services; Scope 5-Licensed Fixed Microwave Radio Services; |
|-------|--|

*Please refer to Industry Canada (IC) website at: <http://www.ic.gc.ca/eic/site/smt-gst.nsf/eng/sf09888.html>

IDA – Singapore

| | |
|-------------------------------|---|
| Line Terminal Equipment | All Technical Specifications for Line Terminal Equipment – Table 1 of IDA MRA Recognition Scheme: 2009, Annex 2 |
| Radio-Communication Equipment | All Technical Specifications for Radio-Communication Equipment – Table 2 of IDA MRA Recognition Scheme: 2009, Annex 2 |

*Please refer to Info-Communication Development Authority (IDA) Singapore website at: http://www.ida.gov.sg/doc/Policies%20and%20Regulation/Policies_and_Regulation_Level2/20060609145118/MRARecScheme.pdf

(A2LA Cert. No. 2742.02) 11/23/2010

Peter Noyes Page 1 of 2



OFTA – Hong Kong

Radio Equipment

HKTA 1001, 1002, 1003, 1004, 1005, 1006, 1007, 1008,
1009, 1010, 1015, 1016, 1019, 1020, 1022, 1026, 1027,
1029, 1030, 1031, 1032, 1033, 1034, 1035, 1036, 1037,
1038, 1039, 1041, 1042, 1043, 1044, 1045, 1046, 1047,
1048, 1049, 1050, 1051, 1052, 1053, 1054, 1055

**Please refer to the Office of the Telecommunications Authority's website at:
<http://www.ofta.gov.hk/en/standards/HKTASpec/hkta-10xx.html>*

Fixed Network Equipment

HKTA 2001, 2005, 2011, 2012, 2013, 2014, 2015, 2016,
2017, 2018, 2019, 2020, 2021, 2022, 2023, 2024, 2025,
2026, 2027, 2028, 2029, 2030, 2031, 2032, 2033, 2034,
2035, 2036, 2037, 2040, 2041, 2102, 2103,
2104, 2108, 2201, 2202, 2203, 2204

**Please refer to the Office of the Telecommunications Authority's website at:
<http://www.ofta.gov.hk/en/standards/HKTASpec/hkta-2xxx.html>*

SIEMIC ACREDITATION DETAILS: FCC Test Site Registration No. 783147

FEDERAL COMMUNICATIONS COMMISSION

**Laboratory Division
7435 Oakland Mills Road
Columbia, MD 21046**

December 20, 2007

Registration Number: 783147

SIEMIC Laboratories
2206 Ringwood Avenue,
San Jose, CA 95131

Attention: Leslie Bai

Re: Measurement facility located at San Jose
3 & 10 meter site
Date of Renewal: December 20, 2007

Dear Sir or Madam:

Your request for renewal of the registration of the subject measurement facility has been received. The information submitted has been placed in your file and the registration has been renewed. The name of your organization will remain on the list of facilities whose measurement data will be accepted in conjunction with applications for Certification under Parts 15 or 18 of the Commission's Rules. Please note that the file must be updated for any changes made to the facility and the registration must be renewed at least every three years.

Measurement facilities that have indicated that they are available to the public to perform measurement services on a fee basis may be found on the FCC website www.fcc.gov under E-Filing, OET Equipment Authorization Electronic Filing, Test Firms.

Sincerely,

Phyllis Parrish
Industry Analyst

SIEMIC ACREDITATION DETAILS: Industry of Canada CAB ID : US0160



UNITED STATES DEPARTMENT OF COMMERCE
National Institute of Standards and Technology
Gaithersburg, Maryland 20899

March 4, 2009

Mr. Leslie Bai
SIEMIC, Inc.
2206 Ringwood Avenue
San Jose, CA 95131

Dear Mr. Bai:

NIST is pleased to inform you that your laboratory has been recognized by Industry Canada (IC), under the Asia Pacific Economic Cooperation for Telecommunications Equipment Mutual Recognition Arrangement (APEC Tel MRA). Your laboratory is now designated to act as a Conformity Assessment Body (CAB) under Appendix B, **Phase I** Procedures, of the APEC Tel MRA. The pertinent information about your laboratory's designation is as follows:

CAB Name: SIEMIC, Inc.
Physical Location: 2206 Ringwood Avenue, San Jose, CA 95131 USA
Identification No.: US0160
Recognized Scope: CS-03 Part I, II, V, VI, VII and VIII

You may submit test data to IC to verify that the equipment to be imported into Canada satisfies the applicable requirements. The designation of your organization will remain in force as long as its accreditation for the designated scope remains valid and comply with the designation requirements.

Recognized CABs are listed on the NIST website at <http://ts.nist.gov/mra>. Please contact Ms. Ramona Saar at (301) 975-5521 or ramona.saar@nist.gov if you have any questions.

Sincerely,

David F. Alderman
Group Leader, Standards Coordination and Conformity Group
Standards Services Division

Enclosure

cc: CAB Program Manager



SIEMIC ACREDITATION DETAILS: Industry of Canada Test Site Registration No. 4842-1



May 23rd, 2008

OUR FILE: 46405-4842
 Submission No: 126429

Siemic Inc.
 2206 Ringwood Ave.
 San Jose CA 95131
 USA

Attention: Leslie Bai

Dear Sir/Madame:

The Bureau has received your application for the registration / renewal of a 3/10m OATS. Be advised that the information received was satisfactory to Industry Canada. The following number(s) is now associated to the site(s) for which registration / renewal was sought (**4842A-1**). Please reference the appropriate site number in the body of test reports containing measurements performed on the site. In addition, please be informed that the Bureau is now utilizing a **new site numbering scheme** in order to simplify the electronic filing process. Our goal is to reduce the number of secondary codes associated to one particular company. The following changes have been made to your record.

- Your primary code is: **4842**
- The company number associated to the site(s) located at the above address is: **4842A**
- The table below is a summary of the changes made to the unique site registration number(s):

| New Site Number | Obsolete Site Number | Description of Site | Expiry Date (YYYY-MM-DD) |
|-----------------|----------------------|---------------------|--------------------------|
| 4842A-1 | 4842-1 | 3m Chamber | 2010-05-23 |

Furthermore, to obtain or renew a unique site number, the applicant shall demonstrate that the site has been accredited to ANSI C63.4-2003 or later. A scope of accreditation indicating the accreditation by a recognized accreditation body to ANSI C63.4-2003 shall be accepted. Please indicate in a letter the previous assigned site number if applicable and the type of site (example: 3 meter OATS or 3 meter chamber). If the test facility is not accredited to ANSI C63.4-2003 or later, the test facility shall submit test data demonstrating full compliance with the ANSI standard. The Bureau will evaluate the filing to determine if recognition shall be granted.

The frequency for re-validation of the test site and the information that is required to be filed or retained by the testing party shall comply with the requirements established by the accrediting organization. However, in all cases, test site re-validation shall occur on an interval not to exceed two years. There is no fee or form associated with an OATS filing. OATS submissions are encouraged to be submitted electronically to the Bureau using the following URL;
http://strategis.ic.gc.ca/epic/internet/inceb-bhst.nsf/en/h_tt00052e.html.

If you have any questions, you may contact the Bureau by e-mail at certification.bureau@ic.gc.ca
 Please reference our file and submission number above for all correspondence.

Yours sincerely,

 S. Proulx
 Test & Measurement Specialist
 Certification and Engineering Bureau
 3701 Carling Ave., Building 94
 Ottawa, Ontario K2H 8S2



SIEMIC, INC.

Accessing global markets

Title: RF Test Report for Wifi Modular
Model: MR100
To: FCC 15.247:2009

Serial#: 10021272
Issue Date: 13 January 2011
Page: 104 of 113
www.siemic.com.cn

SIEMIC ACREDITATION DETAILS: FCC DOC CAB Recognition : US1109

FEDERAL COMMUNICATIONS COMMISSION

**Laboratory Division
7435 Oakland Mills Road
Columbia, MD 21046**

August 28, 2008

Siemic Laboratories
2206 Ringwood Ave.,
San Jose, CA 95131

Attention: Leslie Bai

Re: Accreditation of Siemic Laboratories
Designation Number: US1109
Test Firm Registration #: 540430

Dear Sir or Madam:

We have been notified by American Association for Laboratory Accreditation that Siemic Laboratories has been accredited as a Conformity Assessment Body (CAB).

At this time Siemic Laboratories is hereby designated to perform compliance testing on equipment subject to Declaration Of Conformity (DOC) and Certification under Parts 15 and 18 of the Commission's Rules.

This designation will expire upon expiration of the accreditation or notification of withdrawal of designation.

Sincerely,

George Tannahill
Electronics Engineer

SIEMIC ACREDITATION DETAILS: Australia CAB ID : US0160



UNITED STATES DEPARTMENT OF COMMERCE
National Institute of Standards and Technology
Gaithersburg, Maryland 20899

November 20, 2008

Mr. Leslie Bai
SIEMIC, Inc.
2206 Ringwood Avenue
San Jose, CA 95131

Dear Mr. Bai:

NIST is pleased to inform you that your laboratory has been recognized by the Australian Communications and Media Authority (ACMA) under the Asia Pacific Economic Cooperation for Telecommunications Equipment Mutual Recognition Arrangement (APEC Tel MRA). Your laboratory is now designated to act as a Conformity Assessment Body (CAB) under Appendix B, **Phase I** Procedures, of the APEC Tel MRA. The pertinent information about your laboratory's designation is as follows:

CAB Name: Siemic, Inc.
Physical Location: 2206 Ringwood Avenue, San Jose, CA 95131
Identification No.: US0160
Recognized Scope: EMC: AS/NZS 4251.1 (until 5/31/2009), AS/NZS 4251.2 (until 5/31/2009), AS/NZS CISPR 11, AS/NZS CISPR 14.1, AS/NZS CISPR 22, AS/NZS 61000.6.3, AS/NZS 61000.6.4
Radiocommunications: AS/NZS 4281, AS/NZS 4268, AS/NZS 4280.1, AS/NZS 4280.2, AS/NZS 4295, AS/NZS 4582, AS/NZS 4583, AS/NZS 4769.1, AS/NZS 4769.2, AS/NZS 4770, AS/NZS 4771
Telecommunications: AS/ACIF S002:05, AS/ACIF S003:06, AS/ACIF S004:06, AS/ACIF S006:01, AS/ACIF S016:01, AS/ACIF S031:01, AS/ACIF S038:01, AS/ACIF S040:01, AS/ACIF S041:05, AS/ACIF S043.2:06, AS/NZS 60950.1

You may submit test data to ACMA to verify that the equipment to be imported into Australia satisfies the applicable requirements. The designation of your organization will remain in force as long as its accreditation for the designated scope remains valid and comply with the designation requirements. Recognized CABs are listed on the NIST website at <http://ts.nist.gov/mra>. Please contact Ms. Ramona Saar, at (301) 975-5521 or ramona.saar@nist.gov if you have questions.

Sincerely,

David F. Alderman
Group Leader, Standards Coordination and Conformity Group
Standards Services Division

Enclosure

cc: Snell Leong, Siemic, Inc.; Ramona Saar, NIST

SIEMIC ACREDITATION DETAILS: Korea CAB ID: US0160



UNITED STATES DEPARTMENT OF COMMERCE
National Institute of Standards and Technology
Gaithersburg, Maryland 20899

October 1, 2008

Mr. Leslie Bai
SIEMIC, Inc.
2206 Ringwood Avenue
San Jose, CA 95131

Dear Mr. Bai:

NIST is pleased to inform you that your laboratory has been recognized by the Radio Research Agency (RRA) Korea Communications Commission (KCC) under the Asia Pacific Economic Cooperation for Telecommunications Equipment Mutual Recognition Arrangement (APEC Tel MRA). Your laboratory is now designated to act as a Conformity Assessment Body (CAB) under Appendix B, **Phase I** Procedures, of the APEC Tel MRA. The pertinent information about your laboratory's designation is as follows:

- CAB Name: SIEMIC, Inc.
- Physical Location: 2206 Ringwood Avenue, San Jose, CA 95131
- Identification No.: US0160
- Recognized Scope: **EMI:** KCC Notice 2008-39, RRL Notice 2008-3: CA Procedures for EMI
KN22: Test Method for EMI
EMS: KCC Notice 2008-38, RRL Notice 2008-4: CA Procedures for EMS
KN24, KN-61000-4-2, -4-3, -4-4, -4-5, -4-6, -4-8, -4-11: Test Method for EMS
Wireless: RRL Notice 2008-26, RRL Notice 2008-2, RRL Notice 2008-10,
RRL Notice 2007-49, RRL Notice 2007-20, RRL Notice 2007-21,
RRL Notice 2007-80, RRL Notice 2004-68
Wired: President Notice 20664, RRL Notice 2007-30,
RRL Notice 2008-7 with attachments 1, 3, 5, 6
President Notice 20664, RRL Notice 2008-7 with attachment 4

You may submit test data to RRA/KCC to verify that the equipment to be imported into Korea satisfies the applicable requirements. The designation of your organization will remain in force as long as its accreditation for the designated scope remains valid and comply with the designation requirements.

Recognized CABs are listed on the NIST website at <http://ts.nist.gov/mra>. If you have any questions please contact Ramona Saar at (301) 975-5521 or ramona.saar@nist.gov.

Sincerely,

David F. Alderman
Group Leader, Standards Coordination and Conformity Group
Standards Services Division

Enclosure

cc: Ramona Saar





SIEMIC, Inc.

Accessing global markets

Title: RF Test Report for Wifi Modular
Model: MR100
To: FCC 15.247:2009

Serial#: 10021272
Issue Date: 13 January 2011
Page: 107 of 113
www.siemic.com.cn

SIEMIC ACREDITATION DETAILS: Taiwan BSMI Accreditation No. SL2-IN-E-1130R



UNITED STATES DEPARTMENT OF COMMERCE
National Institute of Standards and Technology
Gaithersburg, Maryland 20899

May 3, 2006

Mr. Leslie Bai
SIEMIC Laboratories
2206 Ringwood Avenue
San Jose, CA 95131

Dear Mr. Bai:

I am pleased to inform you that your laboratory has been recognized by the Chinese Taipei's Bureau of Standards, Metrology, and Inspection (BSMI) under the Asia Pacific Economic Cooperation (APEC) Mutual Recognition Arrangement (MRA). Your laboratory is now designated to act as a Conformity Assessment Body (CAB) under Appendix B, **Phase I** Procedures, of the APEC Tel MRA. You may submit test data to BSMI to verify that the equipment to be imported into Chinese Taipei satisfies the applicable requirements. The designation of your organization will remain in force as long as its accreditation for the designated scope remains valid and comply with the designation requirements. The pertinent designation information is as follows:

- BSMI number: **SL2-IN-E-1130R** (Must be applied to the test reports)
- U.S. Identification No: **US0160**
- Scope of Designation: **CNS 13438**
- Authorized signatory: **Mr. Leslie Bai**

The names of all recognized CABs will be posted on the NIST website at <http://ts.nist.gov/mra>. If you have any questions, please contact Mr. Dhillon at 301-975-5521. We appreciate your continued interest in our international conformity assessment activities.

Sincerely,

David F. Alderman
Group Leader, Standards Coordination and Conformity Group

cc: Jogindar Dhillon

NIST

SIEMIC ACREDITATION DETAILS: Taiwan NCC CAB ID: US0160



UNITED STATES DEPARTMENT OF COMMERCE
National Institute of Standards and Technology
Gaithersburg, Maryland 20899

November 25, 2008

Mr. Leslie Bai
SIEMIC, Inc.
2206 Ringwood Avenue
San Jose, CA 95131

Dear Mr. Bai:

NIST is pleased to inform you that your laboratory has been recognized by the National Communications Commission (NCC) for the requested scope expansion under the Asia Pacific Economic Cooperation for Telecommunications Equipment Mutual Recognition Arrangement (APEC Tel MRA). Your laboratory is designated to act as a Conformity Assessment Body (CAB) under Appendix B, **Phase I** Procedures, of the APEC Tel MRA. The pertinent information about your laboratory's designation is as follows:

CAB Name: SIEMIC, Inc.
Physical Location: 2206 Ringwood Avenue, San Jose, CA 95131
Identification No.: US0160
Current Scope: LP0002
Additional Scope: PSTN01, ADSL01, ID0002, IS6100 and CNS 14336

You may submit test data to NCC to verify that the equipment to be imported into China satisfies the applicable requirements. The designation of your organization will remain in force as long as its accreditation for the designated scope remains valid and comply with the designation requirements.

Recognized CABs are listed on the NIST website at <http://ts.nist.gov/mra>. If you have any questions please contact Ramona Saar at (301) 975-5521 or ramona.saar@nist.gov.

Sincerely,

David F. Alderman
Group Leader, Standards Coordination and Conformity Group
Standards Services Division

Enclosure

cc: Ramona Saar



SIEMIC, INC.

Accessing global markets

Title: RF Test Report for Wifi Modular
Model: MR100
To: FCC 15.247:2009

Serial#: 10021272
Issue Date: 13 January 2011
Page: 109 of 113
www.siemic.com.cn

SIEMIC ACREDITATION DETAILS: Mexico NOM Recognition



CAMARA NACIONAL
DE LA INDUSTRIA
ELECTRONICA, DE
TELECOMUNICACIONES
E INFORMÁTICA

Laboratorio Valentín V. Rivero

México D.F. a 18 de octubre de 2006.

**LESLIE BAI
DIRECTOR OF CERTIFICATION
SIEMIC LABORATORIES, INC.
ACCESSING GLOBAL MARKETS
P R E S E N T E**

En contestación a su escrito de fecha 5 de septiembre del año en curso, le comento que estamos muy interesados en su intención de firmar un Acuerdo de Reconocimiento Mutuo, para lo cual adjunto a este escrito encontrara el Acuerdo en idioma ingles y español prellenado de los cuales le pido sea revisado y en su caso corregido, para que si este de acuerdo poder firmarlo para mandarlo con las autoridades Mexicanas para su visto bueno y así poder ejercer dicho acuerdo.

Aprovecho este escrito para mencionarle que nuestro intermediario gestor será la empresa Isabel de México, S. A. de C. V., empresa que ha colaborado durante mucho tiempo con nosotros en lo relacionado a la evaluación de la conformidad y que cuenta con amplia experiencia en la gestión de la certificación de cumplimiento con Normas Oficiales Mexicanas de producto en México.

Me despido de usted enviándole un cordial saludo y esperando sus comentarios al Acuerdo que nos ocupa.

Atentamente:

**Ing. Faustino Bortez González
Gerente Técnico del Laboratorio de
CANIETI.**

Calle 71
Hidrovia Condésa
08100 México, D.F.
Tel. 5264-6808 con 12 líneas
Fax 5264-0495
www.canieti.org

SIEMIC ACREDITATION DETAILS: Hong Kong OFTA CAB ID : US0160



UNITED STATES DEPARTMENT OF COMMERCE
National Institute of Standards and Technology
Gaithersburg, Maryland 20899-

December 8, 2008

Mr. Leslie Bai
SIEMIC, Inc.
2206 Ringwood Avenue
San Jose, CA 95131

Dear Mr. Bai:

NIST is pleased to inform you that your laboratory has been recognized by the Office of the Telecommunications Authority (OFTA) under the Asia Pacific Economic Cooperation for Telecommunications Equipment Mutual Recognition Arrangement (APEC Tel MRA). Your laboratory is now designated to act as a Conformity Assessment Body (CAB) under Appendix B, **Phase I** Procedures, of the APEC Tel MRA. The pertinent information about your laboratory's designation is as follows:

CAB Name: SIEMIC, Inc.
Physical Location: 2206 Ringwood Avenue, San Jose, California 95131 USA
Identification No.: US0160
Recognized Scope: **Radio:** HKTA 1002, 1007, 1008, 1010, 1015, 1016, 1020, 1022, 1026, 1027, 1029, 1030, 1031, 1032, 1033, 1034, 1035, 1036, 1037, 1039, 1041, 1042, 1043, 1044, 1046, 1047, 1048, 1049, 1051
Telecom: HKTA 2011, 2012, 2013, 2014, 2017, 2018, 2022, 2024, 2026, 2027, 2028, 2029, 2030, 2031, 2032, 2033

You may submit test data to OFTA to verify that the equipment to be imported into Hong Kong satisfies the applicable requirements. The designation of your organization will remain in force as long as its accreditation for the designated scope remains valid and comply with the designation requirements.

Recognized CABs are listed on the NIST website at <http://ts.nist.gov/mra>. If you have any questions please contact Ramona Saar at (301) 975-5521 or ramona.saar@nist.gov.

Sincerely,

David F. Alderman
Group Leader, Standards Coordination and Conformity Group
Standards Services Division

Enclosure

cc: Ramona Saar





SIEMIC, INC.

Accessing global markets

Title: RF Test Report for Wifi Modular
Model: MR100
To: FCC 15.247:2009

Serial#: 10021272
Issue Date: 13 January 2011
Page: 111 of 113
www.siemic.com.cn

SIEMIC ACREDITATION DETAILS: VCCI Radiated Test Site Registration No. R-3083



VCCI Council

CERTIFICATE

Company: SIEMIC Inc.

<Member No. 3081 >

Facility: SIEMIC Inc.

(Radiation 3 meter site)

Location of Facility:

2206 Ringwood Avenue, San Jose, CA 95131 USA

*This is to certify that the following measuring facility
has been registered in accordance with the Rules
for Voluntary Control Measures*

Registration No.: R-3083

Date of Registration: June 12 , 2009

This Certificate is valid until September 30 , 2010

VCCI Council





SIEMIC, Inc.

Accessing global markets

Title: RF Test Report for Wifi Modular
Model: MR100
To: FCC 15.247:2009

Serial#: 10021272
Issue Date: 13 January 2011
Page: 112 of 113
www.siemic.com.cn

SIEMIC ACREDITATION DETAILS: VCCI Conducted (Main Port) Test Site Registration No. C-3421



VCCI Council

CERTIFICATE

Company: SIEMIC Inc.

<Member No. 3081 >

Facility: SIEMIC Inc.

(Main Ports Conducted Interference Measurement)

Location of Facility:

2206 Ringwood Avenue, San Jose, CA 95131 USA

*This is to certify that the following measuring facility
has been registered in accordance with the Rules
for Voluntary Control Measures*

Registration No.: C-3421

Date of Registration: June 12 , 2009

This Certificate is valid until September 30 , 2010

VCCI Council





SIEMIC, INC.

Accessing global markets

Title: RF Test Report for Wifi Modular
Model: MR100
To: FCC 15.247:2009

Serial#: 10021272
Issue Date: 13 January 2011
Page: 113 of 113
www.sieminc.com.cn

SIEMIC ACREDITATION DETAILS: VCCI Conducted (Telecom Port) Test Site Registration No. T-1597



VCCI Council

CERTIFICATE

Company: SIEMIC Inc.

<Member No. 3081 >

Facility: SIEMIC Inc.

(Telecommunication Ports Conducted Interference Measurement)

Location of Facility:

2206 Ringwood Avenue, San Jose, CA 95131 USA

*This is to certify that the following measuring facility
has been registered in accordance with the Rules
for Voluntary Control Measures*

Registration No.: T-1597

Date of Registration: June 12 , 2009

This Certificate is valid until September 30 , 2010

VCCI Council

