

# Instruction Manual

## DR7800S DR7810S DR7600S DR7610S DR7500S DR7510S

### DMR/FM Portable Radio

Thank you for purchasing a **COVALUE** two-way radio. This simple to use radio adopts the latest advances in technology, providing reliable communication in today's demanding communication environment.

#### Notice to the User:

- Please read this instruction manual before operating this radio.
- It's prohibited to use the radio or charge it at any area with a potentially explosive atmosphere (where the air contains gas, dust and smog, etc.), as well as while taking on fuel, or while parking at a gasoline service station; or any area where radio communication is prohibited (such as a hospital or a airport.)
- It's prohibited to operate the radio without permission in areas where the government laws prohibit radio communication.
- Please don't expose the radio to direct sunlight for a long time; don't place the radio near any heating devices, either.
- Please don't put the radio in extremely dusty, moist humid areas or unstable surfaces.
- Only qualified personal, with proper tools and instruments are allowed to service and repair the radios, do not disassemble the radio by yourself to avoid damages.

#### FCCWarning:

Any Changes or modifications not expressly approved by the party responsible for compliance could void the user's authority to operate the equipment.

This device complies with part 15 of the FCC Rules. Operation is subject to the following two conditions: (1) This device may not cause harmful interference , and (2) this device must accept any interference received , including interference that may cause undesired operation .

Note: This equipment has been tested and found to comply with the limits for a Class B digital device, pursuant to part 15 of the FCC Rules.

These limits are designed to provide reasonable protection against harmful interference in a residential installation. This equipment generates uses and can radiate radio frequency energy and, if not installed and used in accordance with the instructions, may cause harmful interference to radio communications. However, there is no guarantee that interference will not occur in a particular installation. If this equipment does cause harmful interference to radio or television reception, which can be determined by turning the equipment off and on, the user is encouraged to try to correct the interference by one or more of the following measures:

- Reorient or relocate the receiving antenna.
- Increase the separation between the equipment and receiver .
- Connect the equipment into an outlet on a circuit different from that to which the receiver is connected .
- Consult the dealer or an experienced radio / TV technician for help.

## **ISED warning:**

NOTICE: This radio is intended for use in occupational/controlled conditions where users have full knowledge of their exposure and can exercise control over their exposure to meet the occupational limits in FCC/ISED and International standards. This radio device is not authorized for general population consumer use.

### RF Exposure Requirements:

. To control your exposure and ensure compliance with the occupational/controlled environmental exposure limits, always adhere to the following procedures.

#### Guidelines:

Do not remove the RF Exposure Label from the device.

User awareness instructions should accompany device when transferred to other users.

Do not use this device if the operational requirements described herein are not met.  
Operating Instructions:

Transmit no more than the rated duty factor of 50% of the time. To transmit (talk), push the Push-To-Talk (PTT) key. To receive calls, release the PTT key. Transmitting 50% of the time, or less, is important because the radio generates measurable RF energy only when transmitting (in terms of measuring for standards compliance).

Keep the radio unit at least 2.5 cm away from the face. Keeping the radio at the proper distance is important as RF exposure decreases with distance from the antenna. The antenna should be kept away from the face and eyes.

When worn on the body, always place the radio in a COVALUE approved holder, holster, case, or body harness or by use of the correct clip for this product. Use of non-approved accessories may result in exposure levels which exceed the FCC's occupational/controlled environmental RF exposure limits.

Use of non-approved antennas, batteries, and accessories causes the radio to exceed the FCC RF exposure guidelines.

Respectez toujours les procédures suivantes pour contrôler votre exposition et vous assurer de la conformité avec les limites d'exposition professionnelle en milieu de travail / environnementales contrôlées.

Des lignes directrices: Ne retirez pas l'étiquette d'exposition RF de l'appareil. Les instructions de sensibilisation des utilisateurs doivent accompagner l'appareil lors de son transfert à d'autres utilisateurs. N'utilisez pas cet appareil si les exigences opérationnelles décrites ici ne sont pas satisfaites. Mode d'emploi: Ne transmettez pas plus que le facteur de droit nominal de 50% du temps. Pour transmettre (parler), appuyez sur la touche Push-To-Talk (PTT). Pour recevoir des appels, relâchez la touche PTT. La transmission de 50% du temps, ou moins, est importante car la radio génère une énergie RF mesurable uniquement lors de la transmission (en termes de mesure pour la conformité aux normes). Maintenez l'unité radio à au moins 2,5 cm du visage. Le maintien de la radio à la distance appropriée est important car l'exposition aux radiofréquences diminue avec la distance de l'antenne. L'antenne doit être éloignée du visage et des yeux. Lorsqu'il est porté sur le corps, placez toujours la radio dans un support, un étui, un étui ou un harnais de sécurité approuvé par COVALUE ou utilisez le clip approprié pour ce produit. L'utilisation d'accessoires non approuvés peut engendrer des niveaux d'exposition supérieurs aux limites d'exposition aux RF professionnelles / environnementales contrôlées de la FCC. L'utilisation d'antennes, de piles et d'accessoires non approuvés a pour conséquence que la radio dépasse les consignes d'exposition RF de la FCC.

Any changes or modifications not expressly approved by the party responsible for compliance could void the user's authority to operate the equipment.

This device complies with Innovation, Science and Economic Development Canada licence-exempt RSS standard (s). Operation is subject to the following two conditions: (1) this device may not cause interference, and (2) this device must accept any interference, including interference that may cause undesired operation of the device.

Tout changement ou modification non expressément approuvé par la partie responsable de la conformité pourrait annuler l'autorité de l'utilisateur à faire fonctionner l'équipement. Cet appareil est conforme aux normes RSS exemptes de licence d'Innovation, Sciences et Développement économique Canada. Le fonctionnement est soumis aux deux conditions suivantes : (1) cet appareil ne doit pas causer d'interférences, et (2) cet appareil doit accepter toute interférence, y compris les interférences pouvant entraîner un fonctionnement indésirable de l'appareil.

## PROFESSIONAL DIGITAL TWO-WAY RADIO

DR7800S SERIES DR7800S/7810S/7600S/7610S/7500S/7510S

DIGITAL PORTABLE RADIOS

QUICK REFERENCE GUIDE

DR7800S SERIES

Digital Portable Radios

Quick Reference Guide

NOTE: Refer to User Guide for more details on your radio's operations/features.

Radio Controls

Full Keypad Radio

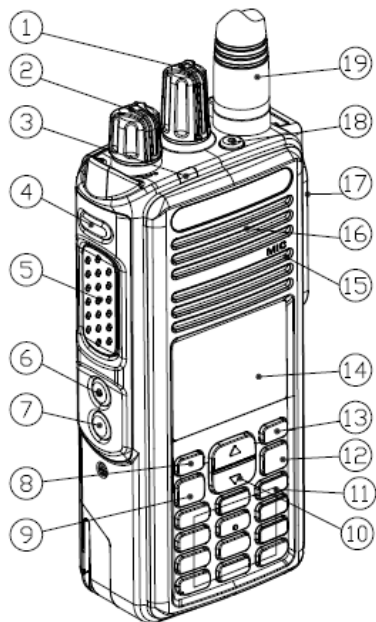

Limited Keypad Radio

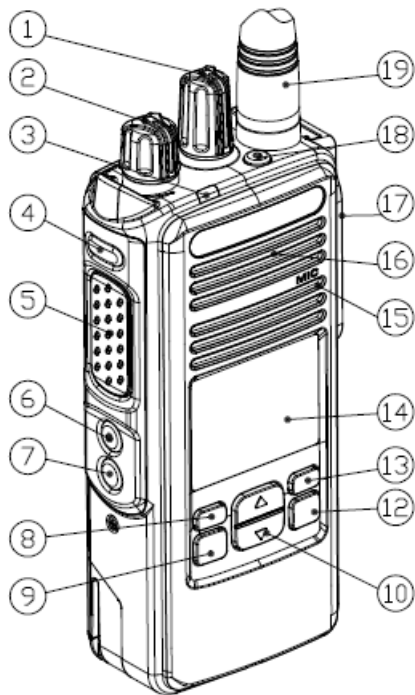

Non-Keypad Radio

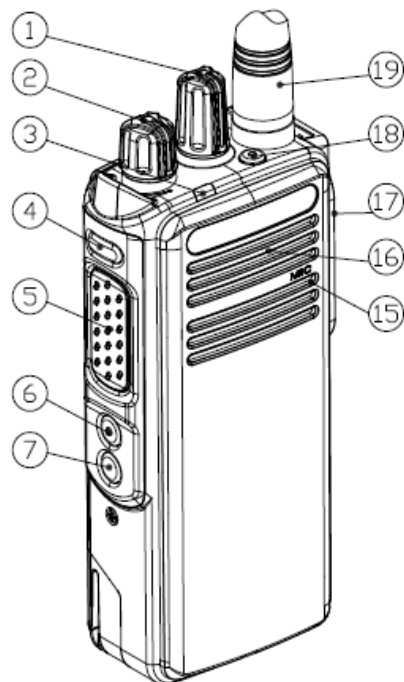

Record your radio's programmable button functions in the blanks provided. SP represents short press, LP represents long press.

① Channel Selector Knob

- ② On/Off/Volume Control Knob
- ③ LED Indicator
- ④ Side Button 1 (Programmable)  
SP: \_\_\_\_\_ LP: \_\_\_\_\_
- ⑤ Push-to-Talk (PTT) Button
- ⑥ Side Button 2 (Programmable)  
SP: \_\_\_\_\_ LP: \_\_\_\_\_
- ⑦ Side Button 3 (Programmable)  
SP: \_\_\_\_\_ LP: \_\_\_\_\_
- ⑧ Front Button P1 (Programmable)  
SP: \_\_\_\_\_ LP: \_\_\_\_\_
- ⑨ OK/Menu Button
- ⑩ 2-Way Navigation Button
- ⑪ Keypad
- ⑫ Return/Home Button
- ⑬ . Front Button P2 (Programmable)  
SP: \_\_\_\_\_ LP: \_\_\_\_\_
- ⑭ . Display
- ⑮ . Microphone
- ⑯ . Speaker
- ⑰ . Universal Connector for Accessories
- ⑱ . Emergency Button (Programmable)
- ⑲ . Antenna

#### Display Icons

The following are the icons that appear on the radio's display.

 No Signal

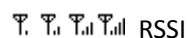
 RSSI

Received Signal Strength Indicator (RSSI)

The number of bars displayed represents the radio signal strength. Four bars indicate the strongest signal. This icon is only displayed while receiving.

    Battery

The number of bars (0 – 3) shown indicates the charge remaining in the battery.

 Bluetooth

The Bluetooth feature is enabled but there is no remote Bluetooth device connected.

 Bluetooth Connected

The Bluetooth feature is enabled. The icon stays lit when one or more remote Bluetooth devices are connected.

 Scanning

 Scan land on

Scan feature is enabled.

 Encryption Enable

The Privacy feature is enabled.

 GPS Available

The GPS feature is enabled. The icon stays lit when a position fix is available.

 GPS Not Available/Out of Range

The GPS feature is enabled. The icon stays lit when a position fix is available.

 Accessories Connected

 Power Level

Radio is set at Low power.

 Radio is set at High power.

**DM**: Direct Mode (Talkaround Mode)

**RM**: Repeater Mode

 :Unread Message

 :Missed Call

 : VOX Enable

 : Speaker Open

 Call Icons

The following icons appear during a call, and in the Contacts list to indicate ID type.

 Private Call

Indicates a Private Call in progress. In the Contacts list, it indicates a subscriber alias (name) or ID (number).

 Group Call/All Call

Indicates a Group Call or All Call in progress. In the Contacts list, it indicates a group alias (name) or ID (number).

■ Bluetooth Device Found List

 Bluetooth Audio Device

Bluetooth-enabled audio device, such as a headset.

■ Sent Items Icons

The following icons appear at the top right corner of the radio's display in the Sent Items folder.

 Sent Successfully

 Send Failed

•The text message to a subscriber alias or ID is pending transmission, followed by waiting for acknowledgement.

Or •The text message to a group alias or ID is pending transmission.

■ Switch Input Method:

Long press # key to switch input method between,

 Lowercase

 Uppercase

 Digit

■ LED Indicator

Blinking red – Radio is at low battery condition

Solid Orange – Powering up

Solid green – Radio is receiving, or detecting activity over the air.

Solid RED – Radio is transmitting

Blinking Orange – Radio is scanning, or in selective call, or emergency state

■ Powering Up and Turning Off the Radio

Rotate the On/Off/Volume Control Knob clockwise until you hear a click. You see a welcome message or welcome image.

The LED lights up solid orange and the Home screen lights up if the backlight setting is set to turn on automatically.

To turn off the radio, rotate this knob counterclockwise until you hear a click. You see a brief *Powering Down* on the radio's display.



### ■ Adjusting the Volume

To increase the volume, turn the On/Off Volume Control Knob clockwise.

To decrease the volume, turn this knob counterclockwise.

### ■ Accessing the Radio from Password

1. Power up the radio.
2. You hear a continuous tone.
3. Enter your current six-digit password with the radio's keypad. The display shows **\*\*\*\*\*** . Press OK to proceed.

You hear a positive indicator tone for every digit pressed. Press  to remove the each \* on the display.

4. If the password is correct:

Your radio proceeds to power up. See **Powering Up and Turning Off the Radio** part

OR

If the password is incorrect:

The display shows **Password Input Error**. Repeat Step 3.

### ■ Selecting a Zone

A zone is a group of channels. The full keypad and limited keypad radio supports up to 2000 channels and 250 zones, with a maximum of 160 channels per zone.





Use the following procedure to select a zone.

#### Full Keypad Radio

Press the programmed Zone button and proceed to Step 2.





OR

Follow the procedure below.

1. OK to access the menu.
2.  or  to Zone and press  to select.
3. The current zone is displayed and indicated by a .

#### Limited Keypad Radio

Press the programmed Zone button and proceed to Step 2.

1. OK to access the menu.
2.  or  to Zone and press  to select.
3. The current zone is displayed and indicated by a .

#### Non-Keypad Radio

The non-keypad radio supports up to 32 channels and 2 zones, with a maximum of 16 channels per zone.

1. Press the programmed Zone button.
2. You hear a positive indicator tone, indicating the radio has switched from Zone 1 to Zone 2.

OR

You hear a negative indicator tone, indicating the radio has switched from Zone 2 to Zone 1.

#### ■ Selecting a Channel

Once the required zone is displayed (if you have multiple zones in your radio), turn the programmed Channel Selector Knob to select the channel.

#### ■ Making a Group Call

1. Turn the Channel Selector Knob to select the channel with the active group alias or ID.
2. Hold the radio vertically 1 to 2 inches (2.5 to 5.0 cm) from your mouth.
3. Press the PTT button to make the call. The LED lights up solid red. The Group Call icon appears. The first text line shows the group call alias.
4. Wait for the Talk Permit Tone to finish (if enabled) and speak clearly into the microphone.

OR

Wait for the PTT Sidetone to finish (if enabled) and speak clearly into the microphone.

5. Release the PTT button to listen. When the target radio responds, the LED lights up green. You see the Group Call icon, the group alias or ID, and transmitting radio alias or ID on your display.
6. If the Channel Free Indication feature is enabled, you will hear a short alert tone the moment the target radio releases the PTT button, indicating the channel is free for you to respond. Press the PTT button to respond.

OR

If there is no voice activity for a predetermined period of time, the call ends.

7. Radio returns to the screen you were on prior to initiating the call.

#### ■ Making a Private Call

1. Turn the Channel Selector Knob to select the channel with the active subscriber alias or ID.
2. Hold the radio vertically 1 to 2 inches (2.5 to 5.0 cm) from your mouth.
3. Press the PTT button to make the call. The LED lights up red. The Private Call icon appears. The first text line shows the subscriber alias. The second text line displays the call status.
4. Wait for the Talk Permit Tone to finish (if enabled) and speak clearly into the microphone.
5. Release the PTT button to listen. When the target radio responds, the LED lights up green.
6. If the Channel Free Indication feature is enabled, you will hear a short alert tone the moment the target radio releases the PTT button, indicating the channel is free for you to respond. Press the PTT button to respond.

OR

If there is no voice activity for a predetermined period of time, the call ends.

7. You hear a short tone. The display shows Call Ended.

#### ■ Scanning Channels

Press the programmed Scan button to turn scan on or off.

During scan, the LED blinks orange and the scan icon is displayed .







#### ■ Making a Call Alert

- Full Keypad Radio and Limited Keypad Radio



Press the programmed One Touch Access button and proceed to Step 5.

OR

Follow the procedure below.



1.  to access the menu.
2.  or  to Contacts and press  to select.
3.  or  to the required subscriber alias or ID and press  to select.

OR

 or  to Manual Dial and press  to select.

Enter the subscriber ID you want to page and press .

*NOTE: Not applicable for Limited Keypad Radio*

4.  or  to Call Alert and press  to select.
5. The display shows Call Alert and the subscriber alias or ID, indicating that the Call Alert has been sent.
6. The LED lights up solid red when your radio is sending the Call Alert.
7. If the Call Alert acknowledgement is received, the display shows positive mini notice.

OR

If the Call Alert acknowledgement is not received, the display shows negative mini notice.

#### Non-Keypad Radio

1. Press the programmed One Touch Access button to make a Call Alert to the predefined ID.
2. The LED lights up solid red when your radio is sending the Call Alert.
3. If the Call Alert acknowledgement is received, two chirps sound.

OR

If the Call Alert acknowledgement is not received, a low-pitched tone sounds.

#### Sending a Quick Text Message

##### Full Keypad Radio







Press the programmed Text Message button and proceed to Step 3.



OR

Press the programmed One Touch Access button to send a predefined Quick Text message to a predefined alias or ID and proceed to Step 6.

OR

Follow the procedure below.

1.  to access the menu.
2.  or  to Messages and press  to select.
3.  or  to Quick Text and press  to select.

4.  or  to the required Quick Text and press  to select.

5. A blinking cursor appears.

Use the keypad to edit the message, if required.



Press  to move to the left.

Press  to move to the right.



Press the \*DEL key to delete any unwanted characters.

Press the # key to input one space to the right.

6. Press  once message is composed.

7.  or  to the required alias or ID and press  to select.

OR

 or  to Manual Dial and press  to select.

Key in the subscriber alias or ID and press  .

OR

 to edit the message.

 again to discard the message or save it to the Drafts folder.

8. The display shows transitional mini notice, confirming your message is being sent.

9. If the message is sent, a tone sounds and the display shows positive mini notice.

OR

If the message is not sent, a low tone sounds and the display shows negative mini notice.

Limited Keypad Radio

Press the programmed Text Message button and proceed to Step 3.

OR



Follow the procedure below.

1.  to access the menu.

2.  or  to Messages and press  to select.

3.  or  to Quick Text and press  to select.

4.  or  to the required Quick Text and press  to select.

5.  or  to the required alias or ID and press  to select.

The display shows transitional mini notice, confirming your message is being sent.

6. If the message is sent, a tone sounds and the display shows positive mini notice.

OR

If the message is not sent, a low tone sounds and the display shows negative mini notice.

#### Non-Keypad Radio

You can send Quick Text messages, programmed by your dealer, via the programmable button.

1. Press the programmed One Touch Access button to send a predefined Quick Text message to a predefined ID.
2. The LED lights up solid red.
3. Two chirps indicate that the message is sent successfully.

OR

A low-pitched tone indicates that the message cannot be sent.

#### ■ Sending an Emergency Alarm

NOTE: If your radio is set to Silent, it will not display any audio or visual indicators during Emergency mode.

1. Press the programmed Emergency On button.
2. The display shows Tx Alarm and the destination alias.

The LED blinks red and the Emergency icon appears.

OR

The display shows Tx Telegram and the destination alias. The LED blinks red and the Emergency icon appears.

3. When an Emergency Alarm acknowledgment is received, the Emergency tone sounds and the LED lights off. The display shows Alarm Sent.

OR

If your radio does not receive an Emergency Alarm acknowledgement, and after all retries have been exhausted, a tone sounds and the display shows Alarm Failed.

4. Radio exits the Emergency Alarm mode and returns to the Home screen.

#### ■ Privacy

Press the programmed Privacy button to toggle privacy on or off.

#### ■ Finding and Connecting to a Bluetooth Device

NOTE: Do not turn off your Bluetooth-enabled device or press  during the finding and connecting operation as this cancels the operation.

A pin code may be required to be programmed in your radio before it can pair with some devices. Contact your dealer for more information.

#### Full Keypad Radio

#### Limited Keypad Radio



1. Turn on your Bluetooth-enabled device and place it in pairing mode. Refer to respective Bluetooth-enabled device's user manual.

2. On your radio, press  to access the menu.

3.  or  to Bluetooth and press  to select.



4.  or  to My Devices and press  to select.

If you could not see “My Devices”, you could turn on “BT Switch” to get it.

5.  or  to the required device and press  to select.

OR

 or  to Search Devices to locate available devices.

 or  to the required device and press  to select.

6.  or  to Connect and press  to select. Display shows Connecting to <device>.

Your Bluetooth-enabled device may require additional steps to complete the pairing. Refer to respective Bluetooth-enabled device’s user manual.

7. If successful, the radio display shows <Device> Connected. A tone sounds and  appears beside the connected device. The Bluetooth Connected icon appears on the status bar.

OR

If unsuccessful, the radio display shows Connecting Failed.

Non-Keypad Radio

1. Turn on your Bluetooth-enabled device and place it in pairing mode. Refer to respective Bluetooth-enabled device’s user manual.

2. On your radio, press the programmed Bluetooth Connect button.

3. A tone sounds and LED blinks orange.

4. Your Bluetooth-enabled device may require additional steps to complete the pairing. Refer to respective Bluetooth-enabled device’s user manual.

5. If successful, a positive tone sounds.

OR

If unsuccessful, a negative indicator tone sounds.