

Instruction Manual

Two way radio

Thank you for purchasing a **COVALUE** two-way radio. This simple to use radio adopts the latest advances in technology, providing reliable communication in today's demanding communication environment.

Notice to the User:

- Please read this instruction manual before operating this radio.
- It's prohibited to use the radio or charge it at any area with a potentially explosive atmosphere (where the air contains gas, dust and smog, etc.), as well as while taking on fuel, or while parking at a gasoline service station; or any area where radio communication is prohibited (such as a hospital or a airport.)
- It's prohibited to operate the radio without permission in areas where the government laws prohibit radio communication.
- Please don't expose the radio to direct sunlight for a long time; don't place the radio near any heating devices, either.
- Please don't put the radio in extremely dusty, moist humid areas or unstable surfaces.
- Only qualified personal, with proper tools and instruments are allowed to service and repair the radios, do not disassemble the radio by yourself to avoid damages.

Product Safety and RF Exposure for Portable Two-Way Radios Compliance with RF Energy Exposure Standards

NOTICE: This radio is intended for use in occupational/controlled applications where users have been made aware of the potential for exposure and can exercise control over their exposure. This radio device is NOT authorized for general population, consumer or similar use.

BEFORE USING THIS RADIO, READ THE TRAINING MATERIAL BELOW WHICH CONTAINS IMPORTANT OPERATING INSTRUCTIONS FOR SAFE USAGE AND RF ENERGY AWARENESS AND CONTROL INFORMATION FOR COMPLIANCE WITH RF ENERGY EXPOSURE LIMITS IN APPLICABLE NATIONAL AND INTERNATIONAL STANDARDS.

Federal Communication Commission (FCC) Regulations

The FCC has established limits for safe exposure to radio frequency (RF) emissions from portable two-way radios. The FCC requires manufacturers to demonstrate compliance with RF exposure limits before portable two-way radios can be marketed in the U.S. When two-way radios are approved for occupational/controlled environment exposure limits, the FCC requires users to be fully aware of, and exercise control over, their exposure. Awareness and control of RF exposure can be accomplished by the use of labels, or by education and training through appropriate means such as information and instructions in user manuals or safety booklets. Your two-way radio has an RF exposure information label in the battery compartment. The training material below includes useful information about RF exposure and helpful instructions on how to control your RF exposure. Your two-way radio is designed and tested to comply with a number of national and international standards and guidelines (listed below) regarding human exposure to RF electromagnetic energy.

In terms of measuring RF energy for compliance with FCC exposure guidelines, your radio radiates measurable RF energy only while it is transmitting (during talking), not when it is receiving (listening) or in standby mode.

Compliance and Control Guidelines and Operating Instructions for Portable Two-Way Radios To control your exposure and ensure compliance with the occupational/controlled environment exposure limits, always adhere to the following procedures:

*Transmit no more than 50% of the time. To transmit (talk), push the PushTo-Talk (PTT) button. To receive calls, release the PTT button. Transmitting 50% of the time or less is important since the radio generates measurable RF energy exposure only when transmitting (in terms of measuring standards compliance).

* Hold the radio in a vertical position in front of face with the microphone (and the other parts of the radio, including the antenna) at least one inch (2.5 cm) away from the mouth. Keeping the radio at the proper distance is important because RF exposures decrease with distance from the antenna. Antenna should be kept away from eyes.

* For body-worn operation, always use the COVALUE approved belt-clip, holder or holster case, etc. accessories.

*Use only FCC-approved, supplied or replacement headsets, batteries, and accessories intended for use with this radio. Use of non-FCC/IC approved accessories may exceed the FC/IC RF exposure guidelines.

FCC Warning:

This device complies with part 15 of the FCC Rules. Operation is subject to the following two conditions: (1) This device may not cause harmful interference, and (2) this device must accept any interference received, including interference that may cause undesired operation. Any Changes or modifications not expressly approved by the party responsible for compliance could void the user's authority to operate the equipment.

ISED Warning :

The device has been tested and compliance with SAR limits, users can obtain Canadian information on RF exposure and compliance

Après examen de ce matériel aux conformité aux limites DAS et/ou aux limites d'intensité de champ RF, les utilisateurs peuvent sur l'exposition aux radiofréquences et la conformité and compliance d'acquérir les informations correspondantes

This device complies with ISED licence RSS standard(s). Operation is subject to the following two conditions:

- (1) this device may not cause interference, and
- (2) this device must accept any interference, including interference that may cause undesired operation of the device.

Le présent appareil est conforme aux CNR d'ISED applicables aux appareils radio de licence. L'exploitation est autorisée aux deux conditions suivantes :

- (1) l'appareil ne doit pas produire de brouillage, et
- (2) l'utilisateur de l'appareil doit accepter tout brouillage radioélectrique subi, même si le brouillage est susceptible d'en compromettre le fonctionnement.

SHENZHEN COVALUE COMMUNICATIONS CO., LTD.

PROFESSIONAL DIGITAL TWO-WAY RADIO

DR7800 SERIES DR7800/7810/7820/7600/7610/7620/7500/7510/7520

DIGITAL PORTABLE RADIOS

QUICK REFERENCE GUIDE

DR7800 SERIES

Digital Portable Radios

Quick Reference Guide

NOTE: Refer to User Guide for more details on your radio's operations/features.

Radio Controls

Full Keypad Radio

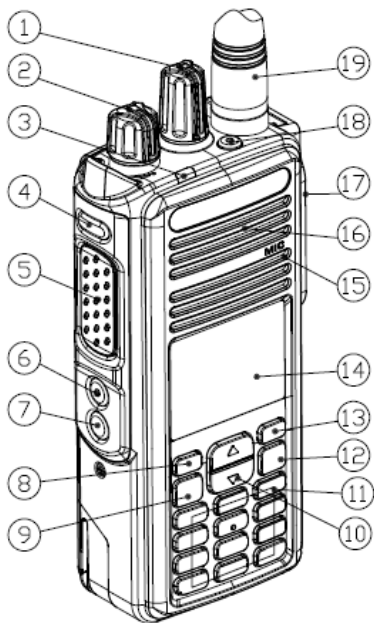

Limited Keypad Radio

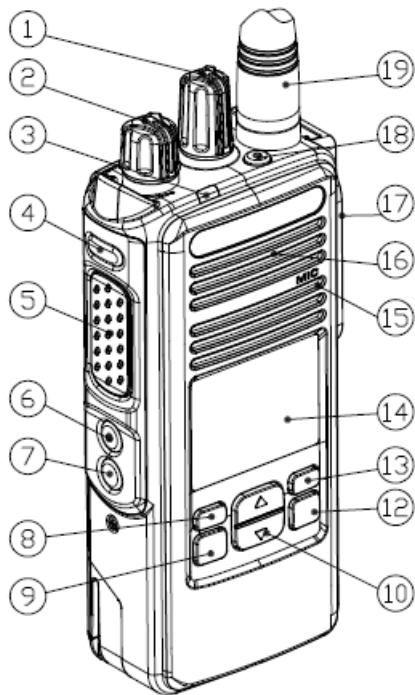

Non-Keypad Radio

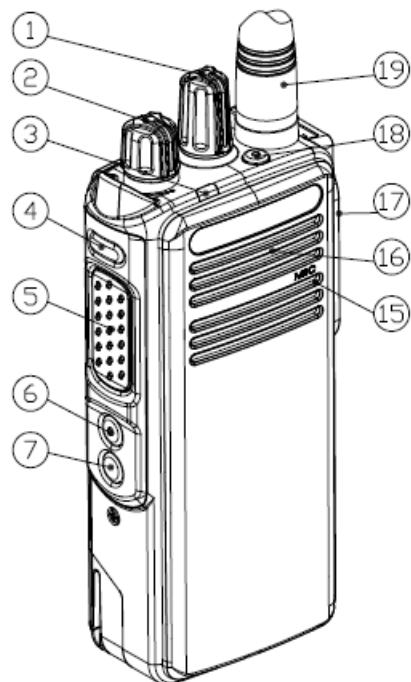

Record your radio's programmable button functions in the blanks provided. SP represents short press, LP represents long press.

- ① Channel Selector Knob
- ② On/Off/Volume Control Knob
- ③ LED Indicator
- ④ Side Button 1 (Programmable)
SP: _____ LP: _____
- ⑤ Push-to-Talk (PTT) Button
- ⑥ Side Button 2 (Programmable)
SP: _____ LP: _____
- ⑦ Side Button 3 (Programmable)
SP: _____ LP: _____
- ⑧ Front Button P1 (Programmable)
SP: _____ LP: _____
- ⑨ OK/Menu Button
- ⑩ 2-Way Navigation Button
- ⑪ Keypad
- ⑫ Return/Home Button
- ⑬ Front Button P2 (Programmable)
SP: _____ LP: _____
- ⑭ Display
- ⑮ Microphone
- ⑯ Speaker
- ⑰ Universal Connector for Accessories
- ⑱ Emergency Button (Programmable)
- ⑲ Antenna

Display Icons

The following are the icons that appear on the radio's display.

 No Signal

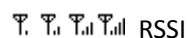
 RSSI

Received Signal Strength Indicator (RSSI)

The number of bars displayed represents the radio signal strength. Four bars indicate the strongest signal. This icon is only displayed while receiving.

    Battery

The number of bars (0 – 3) shown indicates the charge remaining in the battery.

 Scanning

 Scan land on

Scan feature is enabled.

 Encryption Enable

The Privacy feature is enabled.

 Accessories Connected

 Power Level

Radio is set at Low power.

 Radio is set at High power.

 :Unread Message

 :Missed Call

 :VOX Enable

 :Speaker Open

 Call Icons

The following icons appear during a call, and in the Contacts list to indicate ID type.

 Private Call

Indicates a Private Call in progress. In the Contacts list, it indicates a subscriber alias (name) or ID (number).

 Group Call/All Call

Indicates a Group Call or All Call in progress. In the Contacts list, it indicates a group alias (name) or ID (number).

■ Sent Items Icons

The following icons appear at the top right corner of the radio's display in the Sent Items folder.

 Sent Successfully

 Send Failed

- The text message to a subscriber alias or ID is pending transmission, followed by waiting for acknowledgement.

Or •The text message to a group alias or ID is pending transmission.

■ Switch Input Method:

Long press # key to switch input method between,

 Lowercase

 Uppercase

 Digit

■ LED Indicator

Blinking red – Radio is at low battery condition

Solid Orange – Powering up

Solid green – Radio is receiving, or detecting activity over the air.

Solid RED – Radio is transmitting

Blinking Orange – Radio is scanning, or in selective call, or emergency state

■ Powering Up and Turning Off the Radio

Rotate the On/Off/Volume Control Knob clockwise until you hear a click. You see a welcome message or welcome image.

The LED lights up solid orange and the Home screen lights up if the backlight setting is set to turn on automatically.

To turn off the radio, rotate this knob counterclockwise until you hear a click. You see a brief *Powering Down* on the radio's display.

■ Adjusting the Volume

To increase the volume, turn the On/Off Volume Control Knob clockwise.

To decrease the volume, turn this knob counterclockwise.

■ Accessing the Radio from Password

1. Power up the radio.
2. You hear a continuous tone.
3. Enter your current six-digit password with the radio's keypad. The display shows ********* . Press OK to proceed.

You hear a positive indicator tone for every digit pressed. Press  to remove the each * on the display.

4. If the password is correct:

Your radio proceeds to power up. See **Powering Up and Turning Off the Radio** part

OR

If the password is incorrect:

The display shows **Password Input Error**. Repeat Step 3.

■ Selecting a Zone

A zone is a group of channels. The full keypad and limited keypad radio supports up to 2000 channels and 250 zones, with a maximum of 160 channels per zone.





Use the following procedure to select a zone.

Full Keypad Radio

Press the programmed Zone button and proceed to Step 2.





OR

Follow the procedure below.

1. OK to access the menu.
2.  or  to Zone and press  to select.
3. The current zone is displayed and indicated by a .

Limited Keypad Radio

Press the programmed Zone button and proceed to Step 2.

1. OK to access the menu.
2.  or  to Zone and press  to select.
3. The current zone is displayed and indicated by a .

Non-Keypad Radio

The non-keypad radio supports up to 32 channels and 2 zones, with a maximum of 16 channels per zone.

1. Press the programmed Zone button.
2. You hear a positive indicator tone, indicating the radio has switched from Zone 1 to Zone 2.

OR

You hear a negative indicator tone, indicating the radio has switched from Zone 2 to Zone 1.

■ Selecting a Channel

Once the required zone is displayed (if you have multiple zones in your radio), turn the programmed Channel Selector Knob to select the channel.

■ Making a Group Call

1. Turn the Channel Selector Knob to select the channel with the active group alias or ID.
2. Hold the radio vertically 1 to 2 inches (2.5 to 5.0 cm) from your mouth.
3. Press the PTT button to make the call. The LED lights up solid red. The Group Call icon appears. The first text line shows the group call alias.
4. Wait for the Talk Permit Tone to finish (if enabled) and speak clearly into the microphone.

OR

Wait for the PTT Sidetone to finish (if enabled) and speak clearly into the microphone.

5. Release the PTT button to listen. When the target radio responds, the LED lights up green. You see the Group Call icon, the group alias or ID, and transmitting radio alias or ID on your display.
6. If the Channel Free Indication feature is enabled, you will hear a short alert tone the moment the target radio releases the PTT button, indicating the channel is free for you to respond. Press the PTT button to respond.

OR

If there is no voice activity for a predetermined period of time, the call ends.

7. Radio returns to the screen you were on prior to initiating the call.

■ Making a Private Call

1. Turn the Channel Selector Knob to select the channel with the active subscriber alias or ID.
2. Hold the radio vertically 1 to 2 inches (2.5 to 5.0 cm) from your mouth.
3. Press the PTT button to make the call. The LED lights up red. The Private Call icon appears. The first text line shows the subscriber alias. The second text line displays the call status.
4. Wait for the Talk Permit Tone to finish (if enabled) and speak clearly into the microphone.
5. Release the PTT button to listen. When the target radio responds, the LED lights up green.
6. If the Channel Free Indication feature is enabled, you will hear a short alert tone the moment the target radio releases the PTT button, indicating the channel is free for you to respond. Press the PTT button to respond.

OR

If there is no voice activity for a predetermined period of time, the call ends.

7. You hear a short tone. The display shows Call Ended.

■ Scanning Channels

Press the programmed Scan button to turn scan on or off.

During scan, the LED blinks orange and the scan icon is displayed .







■ Making a Call Alert

- Full Keypad Radio and Limited Keypad Radio



Press the programmed One Touch Access button and proceed to Step 5.

OR

Follow the procedure below.



1.  to access the menu.
2.  or  to Contacts and press  to select.
3.  or  to the required subscriber alias or ID and press  to select.

OR

 or  to Manual Dial and press  to select.

Enter the subscriber ID you want to page and press .

NOTE: Not applicable for Limited Keypad Radio

4.  or  to Call Alert and press  to select.
5. The display shows Call Alert and the subscriber alias or ID, indicating that the Call Alert has been sent.
6. The LED lights up solid red when your radio is sending the Call Alert.
7. If the Call Alert acknowledgement is received, the display shows positive mini notice.

OR

If the Call Alert acknowledgement is not received, the display shows negative mini notice.

Non-Keypad Radio

1. Press the programmed One Touch Access button to make a Call Alert to the predefined ID.
2. The LED lights up solid red when your radio is sending the Call Alert.
3. If the Call Alert acknowledgement is received, two chirps sound.

OR

If the Call Alert acknowledgement is not received, a low-pitched tone sounds.

Sending a Quick Text Message

Full Keypad Radio







Press the programmed Text Message button and proceed to Step 3.



OR

Press the programmed One Touch Access button to send a predefined Quick Text message to a predefined alias or ID and proceed to Step 6.

OR

Follow the procedure below.

1.  to access the menu.
2.  or  to Messages and press  to select.
3.  or  to Quick Text and press  to select.

4.  or  to the required Quick Text and press  to select.

5. A blinking cursor appears.

Use the keypad to edit the message, if required.



Press  to move to the left.

Press  to move to the right.



Press the *DEL key to delete any unwanted characters.

Press the # key to input one space to the right.

6. Press  once message is composed.

7.  or  to the required alias or ID and press  to select.

OR

 or  to Manual Dial and press  to select.

Key in the subscriber alias or ID and press  .

OR

 to edit the message.

 again to discard the message or save it to the Drafts folder.

8. The display shows transitional mini notice, confirming your message is being sent.

9. If the message is sent, a tone sounds and the display shows positive mini notice.

OR

If the message is not sent, a low tone sounds and the display shows negative mini notice.

Limited Keypad Radio

Press the programmed Text Message button and proceed to Step 3.

OR



Follow the procedure below.

1.  to access the menu.

2.  or  to Messages and press  to select.

3.  or  to Quick Text and press  to select.

4.  or  to the required Quick Text and press  to select.

5.  or  to the required alias or ID and press  to select.

The display shows transitional mini notice, confirming your message is being sent.

6. If the message is sent, a tone sounds and the display shows positive mini notice.

OR

If the message is not sent, a low tone sounds and the display shows negative mini notice.

Non-Keypad Radio

You can send Quick Text messages, programmed by your dealer, via the programmable button.

1. Press the programmed One Touch Access button to send a predefined Quick Text message to a predefined ID.
2. The LED lights up solid red.
3. Two chirps indicate that the message is sent successfully.

OR

A low-pitched tone indicates that the message cannot be sent.

■ Sending an Emergency Alarm

NOTE: If your radio is set to Silent, it will not display any audio or visual indicators during Emergency mode.

1. Press the programmed Emergency On button.
2. The display shows Tx Alarm and the destination alias.

The LED blinks red and the Emergency icon appears.

OR

The display shows Tx Telegram and the destination alias. The LED blinks red and the Emergency icon appears.

3. When an Emergency Alarm acknowledgment is received, the Emergency tone sounds and the LED lights off. The display shows Alarm Sent.

OR

If your radio does not receive an Emergency Alarm acknowledgement, and after all retries have been exhausted, a tone sounds and the display shows Alarm Failed.

4. Radio exits the Emergency Alarm mode and returns to the Home screen.

■ Privacy

Press the programmed Privacy button to toggle privacy on or off.