

# Instruction Manual

## DR5500S/5510S/5600S/5610S/5800S/5810S

### DMR/FM Portable Radio

Thank you for purchasing a **COVALUE** two-way radio. This simple to use radio adopts the latest advances in technology, providing reliable communication in today's demanding communication environment.

#### Notice to the User:

- Please read this instruction manual before operating this radio.
- It's prohibited to use the radio or charge it at any area with a potentially explosive atmosphere (where the air contains gas, dust and smog, etc.), as well as while taking on fuel, or while parking at a gasoline service station; or any area where radio communication is prohibited (such as a hospital or an airport.)
- It's prohibited to operate the radio without permission in areas where the government laws prohibit radio communication.
- Please don't expose the radio to direct sunlight for a long time; Don't place the radio near any heating devices, either.
- Please don't put the radio in extremely dusty, moist humid areas or unstable surfaces.
- Only qualified personal, with proper tools and instruments are allowed to service and repair the radios, do not disassemble the radio by yourself to avoid damages.

#### FCC Warning:

Any Changes or modifications not expressly approved by the party responsible for compliance could void the user's authority to operate the equipment.

This device complies with part 15 of the FCC Rules. Operation is subject to the following two conditions: (1) This device may not cause harmful interference , and (2) this device must accept any interference received , including interference that may cause undesired operation .

Note: This equipment has been tested and found to comply with the limits for a Class B digital device, pursuant to part 15 of the FCC Rules.

These limits are designed to provide reasonable protection against harmful interference in a residential installation. This equipment generates uses and can radiate radio frequency energy and, if not installed and used in accordance with the instructions, may cause harmful interference to radio communications. However, there is no guarantee that interference will not occur in a particular installation. If this equipment does cause harmful interference to radio or television reception, which can be determined by turning the equipment off and on, the user is encouraged to try to correct the interference by one or more of the following measures:

- Reorient or relocate the receiving antenna.
- Increase the separation between the equipment and receiver .
- Connect the equipment into an outlet on a circuit different from that to which the receiver is connected .
- Consult the dealer or an experienced radio / TV technician for help.

## **ISED warning:**

NOTICE: This radio is intended for use in occupational/controlled conditions where users have full knowledge of their exposure and can exercise control over their exposure to meet the occupational limits in FCC/ISED and International standards. This radio device is not authorized for general population consumer use.

### RF Exposure Requirements:

. To control your exposure and ensure compliance with the occupational/controlled environmental exposure limits, always adhere to the following procedures.

#### Guidelines:

Do not remove the RF Exposure Label from the device.

User awareness instructions should accompany device when transferred to other users.

Do not use this device if the operational requirements described herein are not met.  
Operating Instructions:

Transmit no more than the rated duty factor of 50% of the time. To transmit (talk), push the Push-To-Talk (PTT) key. To receive calls, release the PTT key. Transmitting 50% of the time, or less, is important because the radio generates measurable RF energy only when transmitting (in terms of measuring for standards compliance).

Keep the radio unit at least 2.5 cm away from the face. Keeping the radio at the proper distance is important as RF exposure decreases with distance from the antenna. The antenna should be kept away from the face and eyes.

When worn on the body, always place the radio in a COVALUE approved holder, holster, case, or body harness or by use of the correct clip for this product. Use of non-approved accessories may result in exposure levels which exceed the FCC's occupational/controlled environmental RF exposure limits.

Use of non-approved antennas, batteries, and accessories causes the radio to exceed the FCC RF exposure guidelines.

Respectez toujours les procédures suivantes pour contrôler votre exposition et vous assurer de la conformité avec les limites d'exposition professionnelle en milieu de travail / environnementales contrôlées.

Des lignes directrices: Ne retirez pas l'étiquette d'exposition RF de l'appareil. Les instructions de sensibilisation des utilisateurs doivent accompagner l'appareil lors de son transfert à d'autres utilisateurs. N'utilisez pas cet appareil si les exigences opérationnelles décrites ici ne sont pas satisfaites. Mode d'emploi: Ne transmettez pas plus que le facteur de droit nominal de 50% du temps. Pour transmettre (parler), appuyez sur la touche Push-To-Talk (PTT). Pour recevoir des appels, relâchez la touche PTT. La transmission de 50% du temps, ou moins, est importante car la radio génère une énergie RF mesurable uniquement lors de la transmission (en termes de mesure pour la conformité aux normes). Maintenez l'unité radio à au moins 2,5 cm du visage. Le maintien de la radio à la distance appropriée est important car l'exposition aux radiofréquences diminue avec la distance de l'antenne. L'antenne doit être éloignée du visage et des yeux. Lorsqu'il est porté sur le corps, placez toujours la radio dans un support, un étui, un étui ou un harnais de sécurité approuvé par COVALUE ou utilisez le clip approprié pour ce produit. L'utilisation d'accessoires non approuvés peut engendrer des niveaux d'exposition supérieurs aux limites d'exposition aux RF professionnelles / environnementales contrôlées de la FCC. L'utilisation d'antennes, de piles et d'accessoires non approuvés a pour conséquence que la radio dépasse les consignes d'exposition RF de la FCC.

Any changes or modifications not expressly approved by the party responsible for compliance could void the user's authority to operate the equipment.

Tout changement ou modification non expressément approuvé par la partie responsable de la conformité pourrait annuler l'autorité de l'utilisateur à faire fonctionner l'équipement.

# **PROFESSIONAL DIGITAL TWO-WAY RADIO**

**DR5800S**

**SERIES**

**DR5800S/5810S/5600S/5610S/5500S/5510S**

**DIGITAL PORTABLE RADIOS**

**QUICK REFERENCE GUIDE**

## **DR5800S SERIES**

Digital Portable Radios

Quick Reference Guide

NOTE: Refer to User Guide for more details on your

radio's operations/features.

## Radio Controls

Full Keypad Radio

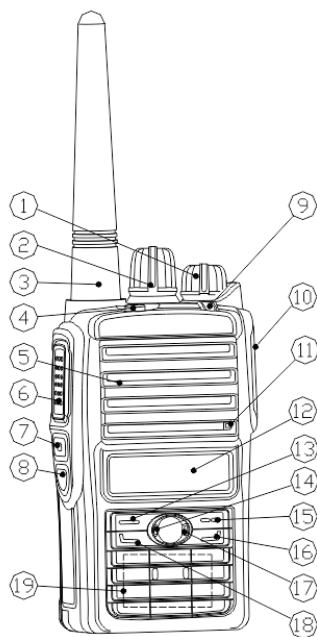

Limited Keypad Radio

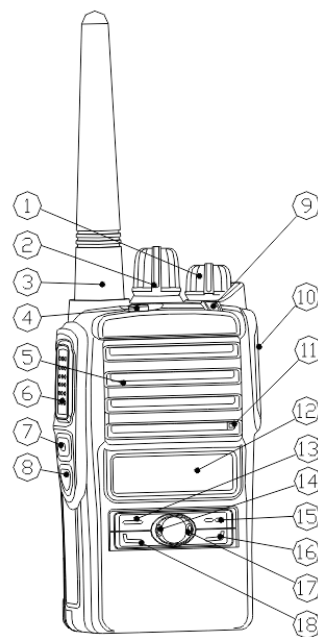

Non-Keypad Radio

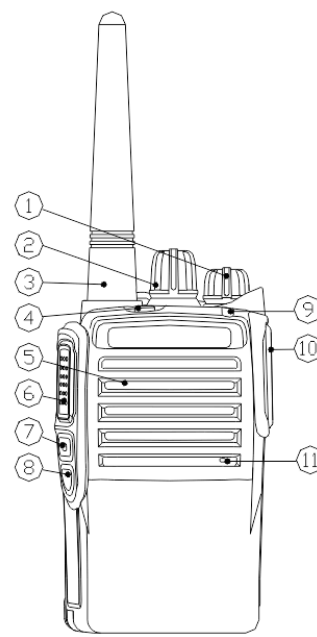

Record your radio's programmable button functions in the blanks provided. SP represents short press, LP represents long press.

- ① On/Off/Volume Control Knob
- ② Channel Selector Knob
- ③ Antenna
- ④ Emergency Button (Programmable)
- ⑤ Speaker
- ⑥ Push-to-Talk (PTT) Button
- ⑦ Side Button 1 (Programmable)

SP: \_\_\_\_\_ LP: \_\_\_\_\_

⑧ Side Button 2 (Programmable)

SP: \_\_\_\_\_ LP: \_\_\_\_\_

⑨ LED Indicator

⑩ Universal Connector for Accessories

⑪ Microphone

⑫ Display

⑬ OK/Menu Button

⑭ Left Navigation Button

⑮ Return/Home Button

⑯ Front Button F2 (Programmable)

SP: \_\_\_\_\_ LP: \_\_\_\_\_

⑰ Right Navigation Button













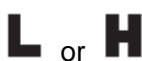



⑱ Front Button F1 (Programmable)

SP: \_\_\_\_\_ LP: \_\_\_\_\_

⑲ Keypad

## Display Icons (LCD model only)

The following are the icons that appear on the radio's display.

ICON	Description
	RSSI: Received Signal Strength Indicator
	Monitor: Selected channel is being monitored
	RF Power Level: Radio is currently set at Low Power(L) or High Power(H)
	Tones Disable: Tones are turned off
	Scan: Scan feature is enabled
	Priority Scan: Radio recognizes activity on the channel/group; designated as Priority 1(if • is blinking) or as Priority 2(if •is steady)
	Unread Message: Unread message in the Inbox
	Inbox Full: User's Inbox is full
	Emergency: Radio is in Emergency mode
	Secure: The Privacy feature is enabled
	Unsecure: The Privacy feature is disabled
	Talk Around: In the absence of a repeater, radio is currently configured for direct radio to radio communication
	Battery Meter
	Private Call: Indicates a Private Call in progress. In Contacts list, it indicates a subscriber alias or ID
	Group Call/All Call: Indicates a Group Call or All Call in progress. In Contacts list, it indicates a group alias or ID
	Sent Successfully: The text message is sent successfully
	Send Failed: The text message cannot be sent



#### In-Progress:

- The text message to a group alias or ID is pending transmission
- The text message to a subscriber alias or ID is pending transmission, followed by waiting for acknowledgement

#### ■ LED Indicator

Blinking red – Radio is at low battery condition

Solid Orange – Powering up

Solid green – Radio is receiving, or detecting activity over the air.

Solid RED – Radio is transmitting

Blinking Orange – Radio is scanning, or in selective call, or emergency state

#### ■ Powering Up and Turning Off the Radio

Rotate the On/Off/Volume Control Knob clockwise until you hear a click. You see a welcome message.

The LED lights up solid orange and the Home screen lights up if the backlight setting is set to turn on automatically.

To turn off the radio, rotate this knob counterclockwise until you hear a click. You see a brief *Powering Down* on the radio's display.

#### ■ Adjusting the Volume

To increase the volume, turn the On/Off Volume Control Knob clockwise.

To decrease the volume, turn this knob counterclockwise.

#### ■ Accessing the Radio from Password

1. Power up the radio.

2. Enter your current six-digit password with the radio's keypad. The display shows **\*\*\*\*\*** . Press OK to proceed.

You hear a positive indicator tone for every digit pressed. Press  to remove the each \* on the display.

3. If the password is correct:

Your radio proceeds to power up. See **Powering Up and Turning Off the Radio** part

OR

If the password is incorrect:

The display shows **Password Input Error**. Repeat Step 2.

#### ■ Selecting a Zone

A zone is a group of channels. The full keypad and limited keypad radio supports up to 2000 channels and 250 zones, with a maximum of 999 channels per zone.

Use the following procedure to select a zone.





#### □ Full Keypad Radio and Limited Keypad Radio



Press the programmed Zone button and proceed to Step 2.

OR

Follow the procedure below.

1.  to access the menu.
2.  or  to Zone and press  to select.
3. The current zone is displayed and indicated by a .

#### Non-Keypad Radio

The non-keypad radio supports up to 32 channels and 2 zones, with a maximum of 16 channels per zone.

1. Press the programmed Zone button.
2. You hear a positive indicator tone, indicating the radio has switched from Zone 1 to Zone 2.

OR

You hear a negative indicator tone, indicating the radio has switched from Zone 2 to Zone 1.

#### Selecting a Channel

Once the required zone is displayed (if you have multiple zones in your radio), turn the programmed Channel Selector Knob to select the channel.

#### Making a Group Call

1. Turn the Channel Selector Knob to select the channel with the active group alias or ID.
2. Hold the radio vertically 1 to 2 inches (2.5 to 5.0 cm) from your mouth.
3. Press the PTT button to make the call. The LED lights up solid red. The Group Call icon appears. The first text line shows the group call alias.
4. Wait for the Talk Permit Tone to finish (if enabled) and speak clearly into the microphone.

OR

Wait for the PTT Sidetone to finish (if enabled) and speak clearly into the microphone.

5. Release the PTT button to listen. When the target radio responds, the LED lights up green. You see the Group Call icon, the group alias or ID, and transmitting radio alias or ID on your display.
6. If the Channel Free Indication feature is enabled, you will hear a short alert tone the moment the target radio releases the PTT button, indicating the channel is free for you to respond. Press the PTT button to respond.

OR

If there is no voice activity for a predetermined period of time, the call ends.

7. Radio returns to the screen you were on prior to initiating the call.

#### Making a Private Call

1. Turn the Channel Selector Knob to select the channel with the active subscriber alias or ID.
2. Hold the radio vertically 1 to 2 inches (2.5 to 5.0 cm) from your mouth.
3. Press the PTT button to make the call. The LED lights up red. The Private Call icon appears. The first text line shows the subscriber alias. The second text line displays the call status.
4. Wait for the Talk Permit Tone to finish (if enabled) and speak clearly into the microphone.

5. Release the PTT button to listen. When the target radio responds, the LED lights up green.
6. If the Channel Free Indication feature is enabled, you will hear a short alert tone the moment the target radio releases the PTT button, indicating the channel is free for you to respond. Press the PTT button to respond.

OR

If there is no voice activity for a predetermined period of time, the call ends.

7. You hear a short tone. The display shows Call Ended.

#### ■ Scanning Channels

Press the programmed Scan button to turn scan on or off.

During scan, the LED blinks orange and the scan icon is displayed .

#### ■ Making a Call Alert

- Full Keypad Radio and Limited Keypad Radio



Press the programmed One Touch Access button and proceed to Step 5.

OR

Follow the procedure below.



1.  to access the menu.
2.  or  to Contacts and press  to select.
3.  or  to the required subscriber alias or ID and press  to select.

OR

 or  to Manual Dial and press  to select.

Enter the subscriber ID you want to page and press .

*NOTE: Not applicable for Limited Keypad Radio*

4.  or  to Call Alert and press  to select.
5. The display shows Call Alert and the subscriber alias or ID, indicating that the Call Alert has been sent.
6. The LED lights up solid red when your radio is sending the Call Alert.
7. If the Call Alert acknowledgement is received, the display shows positive mini notice.

OR

If the Call Alert acknowledgement is not received, the display shows negative mini notice.

- Non-Keypad Radio

1. Press the programmed One Touch Access button to make a Call Alert to the predefined ID.
2. The LED lights up solid red when your radio is sending the Call Alert.
3. If the Call Alert acknowledgement is received, two chirps sound.

OR

If the Call Alert acknowledgement is not received, a low-pitched tone sounds.

#### ■ Sending a Quick Text Message

Full Keypad Radio











Press the programmed Text Message button and proceed to Step 3.

OR

Press the programmed One Touch Access button to send a predefined Quick Text message to a predefined alias or ID and proceed to Step 6.

OR

Follow the procedure below.

1.  to access the menu.
2.  or  to Messages and press  to select.
3.  or  to Quick Text and press  to select.
4.  or  to the required Quick Text and press  to select.

5. A blinking cursor appears.





Use the keypad to edit the message, if required.

Press  to move to the left.



Press  to move to the right.

Press the \*DEL key to delete any unwanted characters.

Press the # key to input one space to the right.

6. Press  once message is composed.
7.  or  to the required alias or ID and press  to select.

OR

 or  to Manual Dial and press  to select.

Key in the subscriber alias or ID and press  .

OR

 to edit the message.

 again to discard the message or save it to the Drafts folder.

8. The display shows transitional mini notice, confirming your message is being sent.

9. If the message is sent, a tone sounds and the display shows positive mini notice.

OR

If the message is not sent, a low tone sounds and the display shows negative mini notice.













Limited Keypad Radio

Press the programmed Text Message button and proceed to Step 3.

OR

Follow the procedure below.

1.  to access the menu.

2.  or  to Messages and press  to select.
3.  or  to Quick Text and press  to select.
4.  or  to the required Quick Text and press  to select.
5.  or  to the required alias or ID and press  to select.

The display shows transitional mini notice, confirming your message is being sent.

6. If the message is sent, a tone sounds and the display shows positive mini notice.

OR

If the message is not sent, a low tone sounds and the display shows negative mini notice.

#### Non-Keypad Radio

You can send Quick Text messages, programmed by your dealer, via the programmable button.

1. Press the programmed One Touch Access button to send a predefined Quick Text message to a predefined ID.
2. The LED lights up solid red.
3. Two chirps indicate that the message is sent successfully.

OR

A low-pitched tone indicates that the message cannot be sent.

#### Sending an Emergency Alarm

NOTE: If your radio is set to Silent, it will not display any audio or visual indicators during Emergency mode.

1. Press the programmed Emergency On button.
2. The display shows Tx Alarm and the destination alias.

The LED blinks red and the Emergency icon appears.

OR

The display shows Tx Telegram and the destination alias. The LED blinks red and the Emergency icon appears.

3. When an Emergency Alarm acknowledgment is received, the Emergency tone sounds and the LED lights off. The display shows Alarm Sent.

OR

If your radio does not receive an Emergency Alarm acknowledgement, and after all retries have been exhausted, a tone sounds and the display shows Alarm Failed.

4. Radio exits the Emergency Alarm mode and returns to the Home screen.

#### Privacy

Press the programmed Privacy button to toggle privacy on or off.