



TESTING LABORATORY
CERTIFICATE #4820.01



SAR EVALUATION REPORT

For

SHENZHEN COVALUE COMMUNICATIONS CO.,LTD.

2/F., Bldg. 24, XiLi Industrial Park, No.119 Xinguang Rd, Xili, Nanshan Shenzhen China

FCC ID: Y4GDR5810-1

Report Type: Original Report	Product Type: Two Way Radio
Report Number: RDG191211001-20A	
Report Date: 2020-01-16	
Reviewed By: Rocky Xiao RF Engineer	<i>Rocky Xiao</i>
Prepared By: Bay Area Compliance Laboratories Corp. (Dongguan) No.69 Pulongcun, Puxinhu Industry Area, Tangxia, Dongguan, Guangdong, China Tel: +86-769-86858888 Fax: +86-769-86858891 www.baclcorp.com.cn	

Attestation of Test Results			
EUT Information	EUT Description	Two Way Radio	
	Tested Model	DR5810-1; DR5510-1; DR5610-1	
	Multiple Models	DR5800-1;DR5600-1;DR5500-1	
	FCC ID	Y4GDR5810-1	
	Serial Number	RDG191211001-SA-S1(model: DR5810-1) RDG191211001-SA-S2(model:DR5510-1) RDG191211001-SA-S3(model: DR5610-1)	
	Test Date	2019-08-10	
Mode	Test Model	Max. SAR Level(s) Reported(W/kg)	Limit
PTT (136-174MHz)	1g Head SAR (Face Up)	1.18	8.0 (W/kg)
	1g Body SAR (Body Back)	3.55	
Applicable Standards	FCC 47 CFR part 2.1093 Radiofrequency radiation exposure evaluation: portable devices		
	IEEE1528:2013 IEEE Recommended Practice for Determining the Peak Spatial-Average Specific Absorption Rate (SAR) in the Human Head from Wireless Communications Devices: Measurement Techniques		
	IEC 62209-2:2010 Human exposure to radio frequency fields from hand-held and body-mounted wireless communication devices-Human models, instrumentation, and procedures-Part 2: Procedure to determine the specific absorption rate (SAR) for wireless communication devices used in close proximity to the human body (frequency range of 30 MHz to 6 GHz)		
	KDB procedures KDB 447498 D01 General RF Exposure Guidance v06 KDB 865664 D01 SAR Measurement 100 MHz to 6 GHz v01r04 KDB 865664 D02 RF Exposure Reporting v01r02 KDB 643646 D01 SAR Test for PTT Radios v01r03		
<p>Note: This wireless device has been shown to be capable of compliance for localized specific absorption rate (SAR) for Occupational/Controlled Exposure limits specified in FCC 47 CFR part 2.1093 and has been tested in accordance with the measurement procedures specified in IEEE 1528-2013 and RF exposure KDB procedures.</p> <p>The results and statements contained in this report pertain only to the device(s) evaluated.</p>			

TABLE OF CONTENTS

DOCUMENT REVISION HISTORY	4
EUT DESCRIPTION	5
TECHNICAL SPECIFICATION	5
REFERENCE, STANDARDS, AND GUIDELINES.....	6
SAR LIMITS	6
FACILITIES.....	7
DESCRIPTION OF TEST SYSTEM	8
EQUIPMENT LIST AND CALIBRATION	13
EQUIPMENTS LIST & CALIBRATION INFORMATION	13
SAR MEASUREMENT SYSTEM VERIFICATION	14
LIQUID VERIFICATION	14
SYSTEM ACCURACY VERIFICATION	16
SAR SYSTEM VALIDATION DATA	17
EUT TEST STRATEGY AND METHODOLOGY	19
TEST POSITIONS FOR DEVICE OPERATING NEXT TO A PERSON’S EAR.....	19
CHEEK/TOUCH POSITION	20
EAR/TILT POSITION	20
TEST POSITIONS FOR BODY-WORN AND OTHER CONFIGURATIONS	21
TEST DISTANCE FOR SAR EVALUATION	21
SAR EVALUATION PROCEDURE.....	22
CONDUCTED OUTPUT POWER MEASUREMENT	23
PROVISION APPLICABLE	23
TEST PROCEDURE	23
MAXIMUM TARGET OUTPUT POWER	23
TEST RESULTS:	24
SAR MEASUREMENT RESULTS.....	27
SAR TEST DATA.....	27
TEST RESULT:	28
SAR MEASUREMENT VARIABILITY	31
CORRECTED SAR EVALUATION.....	32
SAR PLOTS.....	34
APPENDIX A MEASUREMENT UNCERTAINTY	35
APPENDIX B EUT TEST POSITION PHOTOS	37
APPENDIX C CALIBRATION CERTIFICATES	38

DOCUMENT REVISION HISTORY

Revision Number	Report Number	Description of Revision	Date of Revision
1.0	RDG191211001-20A	Original Report	2020-01-16

EUT DESCRIPTION

The **SHENZHEN COVALUE COMMUNICATIONS CO.,LTD.**'s product, model number: **DR5810-1** (FCC ID: **Y4GDR5810-1**) in this report is a **Two Way Radio**.

Note: The series products models DR5800-1; DR5600-1; DR5500-1 and DR5810-1; DR5510-1; DR5610-1 are electrically identical, we selected DR5810-1; DR5510-1; DR5610-1 for fully testing, the details of the difference between them were explained in the attached declaration letter.

* All measurement and test data in this report was gathered from production sample serial number:

RDG191211001-SA-S1(model: DR5810-1)

RDG191211001-SA-S2(model:DR5510-1)

RDG191211001-SA-S3(model: DR5610-1) (Assigned by BACL, Dongguan).

The EUT supplied by the applicant was received on 2019-08-05.

Technical Specification

Device Type:	Portable
Exposure Category:	Occupational/Controlled Exposure
Antenna Type(s):	External Antenna
Body-Worn Accessories:	Belt Clip
Face-Head Accessories:	None
Operation Mode :	PTT_FM, PTT_4FSK
Frequency Band:	136-174MHz
Conducted RF Power:	5.39 W
Power Source:	7.4 VDC Rechargeable Battery
Normal Operation:	Face Up and Body-worn

REFERENCE, STANDARDS, AND GUIDELINES

FCC:

The Report and Order requires routine SAR evaluation prior to equipment authorization of portable transmitter devices, including portable telephones. For consumer products, ANSI/IEEE standard C95.1-1992 [6], limit the whole-body-averaged SAR to 0.4 and 0.08 W/kg for the controlled and uncontrolled environments. According to the Supplement C of OET Bulletin 65 "Evaluating Compliance with FCC Guide-lines for Human Exposure to Radio frequency Electromagnetic Fields", released on Jun 29, 2001 by the FCC, the device should be evaluated at maximum output power (radiated from the antenna) under "worst-case" conditions for normal or intended use, incorporating normal antenna operating positions, device peak performance frequencies and positions for maximum RF energy coupling.

This report describes the methodology and results of experiments performed on wireless data terminal. The objective was to determine if there is RF radiation and if radiation is found, what is the extent of radiation with respect to safety limits. SAR (Specific Absorption Rate) is the measure of RF exposure determined by the amount of RF energy absorbed by human body (or its parts) – to determine how the RF energy couples to the body or head which is a primary health concern for body worn devices. The limit below which the exposure to RF is considered safe by regulatory bodies in North America.

SAR Limits

FCC/IC Limit

EXPOSURE LIMITS	SAR (W/kg)	
	(General Population / Uncontrolled Exposure Environment)	(Occupational / Controlled Exposure Environment)
Spatial Average (averaged over the whole body)	0.08	0.4
Spatial Peak (averaged over any 1 g of tissue)	1.60	8.0
Spatial Peak (hands/wrists/feet/ankles averaged over 10 g)	4.0	20.0

Population/Uncontrolled Environments are defined as locations where there is the exposure of individual who have no knowledge or control of their exposure.

Occupational/Controlled Environments are defined as locations where there is exposure that may be incurred by people who are aware of the potential for exposure (i.e. as a result of employment or occupation).

FACILITIES

The Test site used by Bay Area Compliance Laboratories Corp. (Dongguan) to collect test data is located on the No.69 Pulongcun, Puxinhu Industry Area, Tangxia, Dongguan, Guangdong, China.

The test site has been approved by the FCC under the KDB 974614 D01 and is listed in the FCC Public Access Link (PAL) database, FCC Registration No. : 897218, the FCC Designation No. : CN1220.

The lab has been recognized by Innovation, Science and Economic Development Canada to test to Canadian radio equipment requirements, the CAB identifier : CN0022.

The test sites and measurement facilities used to collect data are located at:

<input checked="" type="checkbox"/> SAR Lab 1	<input type="checkbox"/> SAR Lab 2
---	------------------------------------

DESCRIPTION OF TEST SYSTEM

These measurements were performed with the automated near-field scanning system DASY5 from Schmid & Partner Engineering AG (SPEAG) which is the Fifth generation of the system shown in the figure hereinafter:



DASY5 System Description

The DASY5 system for performing compliance tests consists of the following items:

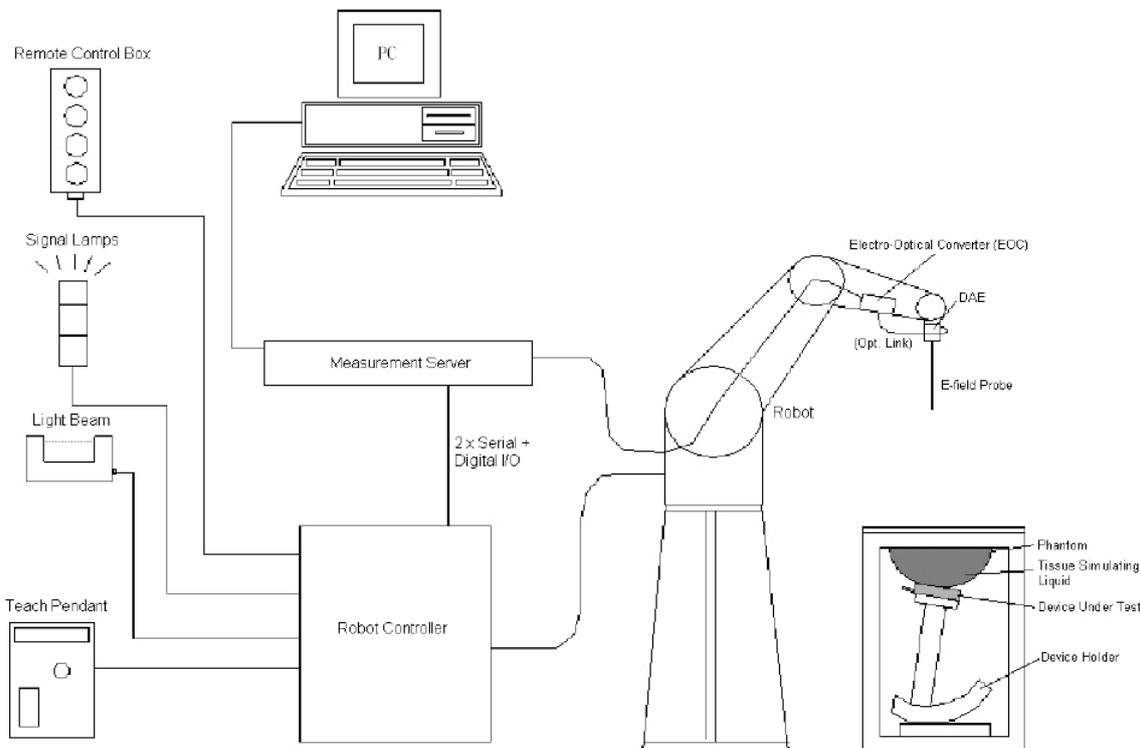

- A standard high precision 6-axis robot with controller, teach pendant and software. An arm extension for accommodating the data acquisition electronics (DAE).
- An isotropic field probe optimized and calibrated for the targeted measurement.
- A data acquisition electronics (DAE) which performs the signal application, signal multiplexing, AD-conversion, offset measurements, mechanical surface detection, collision detection, etc. The unit is battery powered with standard or rechargeable batteries. The signal is optically transmitted to the EOC.
- The Electro-optical converter (EOC) performs the conversion from optical to electrical signals for the digital communication to the DAE. To use optical surface detection, a special version of the EOC is required. The EOC signal is transmitted to the measurement server.
- The function of the measurement server is to perform the time critical tasks such as signal filtering, control of the robot operation and fast movement interrupts.
- The Light Beam used is for probe alignment. This improves the (absolute) accuracy of the probe positioning.
- A computer running Win7 professional operating system and the DASY52 software.
- Remote control and teach pendant as well as additional circuitry for robot safety such as warning lamps, etc.
- The phantom, the device holder and other accessories according to the targeted measurement.

DASY5 Measurement Server

The DASY5 measurement server is based on a PC/104 CPU board with a 400MHz Intel ULV Celeron, 128MB chip-disk and 128MB RAM. The necessary circuits for communication with the DAE4 (or DAE3) electronics box, as well as the 16 bit AD-converter system for optical detection and digital I/O interface are contained on the DASY5 I/O board, which is directly connected to the PC/104 bus of the CPU board.



The measurement server performs all real-time data evaluation of field measurements and surface detection, controls robot movements and handles safety operation. The PC operating system cannot interfere with these time critical processes. All connections are supervised by a watchdog, and disconnection of any of the cables to the measurement server will automatically disarm the robot and disable all program-controlled robot movements. Furthermore, the measurement server is equipped with an expansion port which is reserved for future applications. Please note that this expansion port does not have a standardized point out, and therefore only devices provided by SPEAG can be connected. Devices from any other supplier could seriously damage the measurement server.

Data Acquisition Electronics

The data acquisition electronics (DAE4) consist of a highly sensitive electrometer-grade preamplifier with auto-zeroing, a channel and gain-switching multiplexer, a fast 16 bit AD-converter and a command decoder with a control logic unit. Transmission to the measurement server is accomplished through an optical downlink for data and status information, as well as an optical uplink for commands and the clock.

The mechanical probe mounting device includes two different sensor systems for frontal and sideways probe contacts. They are used for mechanical surface detection and probe collision detection.

The input impedance of both the DAE4 as well as of the DAE3 box is 200M Ω ; the inputs are symmetrical and floating. Common mode rejection is above 80 dB.

ES3DV2 E-Field Probes

Frequency	10 MHz to > 4 GHz Linearity: ± 0.2 dB (30 MHz to 4 GHz)
Directivity	± 0.2 dB in TSL (rotation around probe axis) ± 0.3 dB in TSL (rotation normal to probe axis)
Dynamic Range	5 μ W/g to > 100 mW/g Linearity: ± 0.2 dB (noise: typically < 1 μ W/g)
Dimensions	Overall length: 337 mm (Tip: 10 mm) Tip diameter: 4 mm (Body: 10 mm) Typical distance from probe tip to dipole centers: 4.0 mm
Application	General dosimetry up to 4 GHz Dosimetry in strong gradient fields Compliance tests of mobile phones
Compatibility	DASY3, DASY4, DASY52 SAR and higher, EASY4/MRI

Calibration Frequency Points for ES3DV2 E-Field Probes SN: 3019 Calibrated: 2018/8/20

Calibration Frequency Point(MHz)	Frequency Range(MHz)		Conversion Factor		
	From	To	X	Y	Z
150 Head	100	200	7.67	7.67	7.67
150 Body	100	200	7.30	7.30	7.30
450 Head	350	550	7.18	7.18	7.18
450 Body	350	550	7.10	7.10	7.10

Robots

The DASY5 system uses the high precision industrial robot. The robot offers the same features important for our application:

- High precision (repeatability 0.02mm)
- High reliability (industrial design)
- Low maintenance costs (virtually maintenance free due to direct drive gears; no belt drives)
- Jerk-free straight movements (brushless synchrony motors; no stepper motors)
- Low ELF interference (motor control fields shielded via the closed metallic construction shields)

The above mentioned robots are controlled by the Staubli CS8c robot controllers. All information regarding the use and maintenance of the robot arm and the robot controller is contained on the CDs delivered along with the robot. Paper manuals are available upon request direct from Staubli.

Area Scans

Area scans are defined prior to the measurement process being executed with a user defined variable spacing between each measurement point (integral) allowing low uncertainty measurements to be conducted. Scans defined for FCC applications utilize a 15mm 2 step integral, with 1.5mm interpolation used to locate the peak SAR area used for zoom scan assessments.

Where the system identifies multiple SAR peaks (which are within 25% of peak value) the system will provide the user with the option of assessing each peak location individually for zoom scan averaging.

Zoom Scan (Cube Scan Averaging)

The averaging zoom scan volume utilized in the DASY5 software is in the shape of a cube and the side dimension of a 1 g or 10 g mass is dependent on the density of the liquid representing the simulated tissue. A density of 1000 kg/m³ is used to represent the head and body tissue density and not the phantom liquid density, in order to be consistent with the definition of the liquid dielectric properties, i.e. the side length of the 1g cube is 10mm, with the side length of the 10g cube is 21.5mm.

When the cube intersects with the surface of the phantom, it is oriented so that 3 vertices touch the surface of the shell or the center of a face is tangent to the surface. The face of the cube closest to the surface is modified in order to conform to the tangent surface.

The zoom scan integer steps can be user defined so as to reduce uncertainty, but normal practice for typical test applications (including FCC) utilize a physical step of 7 x 7 x 7 (5mmx5mmx5mm) providing a volume of 30 mm in the X & Y & Z axis.

Tissue Dielectric Parameters for Head and Body Phantoms

The head tissue dielectric parameters recommended by the IEEE SCC-34/SC-2 in P1528 have been incorporated in the following table. These head parameters are derived from planar layer models simulating the highest expected SAR for the dielectric properties and tissue thickness variations in a human head. Other head and body tissue parameters that have not been specified in P1528 are derived from the tissue dielectric parameters computed from the 4-Cole-Cole equations described in Reference [12] and extrapolated according to the head parameters specified in P1528.

Recommended Tissue Dielectric Parameters for Head and Body

Frequency (MHz)	Head Tissue		Body Tissue	
	ϵ_r	σ (S/m)	ϵ_r	σ (S/m)
150	52.3	0.76	61.9	0.80
300	45.3	0.87	58.2	0.92
450	43.5	0.87	56.7	0.94
835	41.5	0.90	55.2	0.97
900	41.5	0.97	55.0	1.05
915	41.5	0.98	55.0	1.06
1450	40.5	1.20	54.0	1.30
1610	40.3	1.29	53.8	1.40
1800-2000	40.0	1.40	53.3	1.52
2450	39.2	1.80	52.7	1.95
3000	38.5	2.40	52.0	2.73
5800	35.3	5.27	48.2	6.00

EQUIPMENT LIST AND CALIBRATION

Equipments List & Calibration Information

Equipment	Model	S/N	Calibration Date	Calibration Due Date
DASY5 Test Software	DASY52.10	N/A	NCR	NCR
DASY5 Measurement Server	DASY5 4.5.12	1470	NCR	NCR
Data Acquisition Electronics	DAE3	471	2018/12/3	2019/12/3
E-Field Probe	ES3DV2	3019	2018/8/20	2019/8/20
CLA150	Loop, 150 MHz	4020	2016/11/08	2019/11/07
Mounting Device	MD4HHTV5	SD 000 H01 KA	NCR	NCR
Oval Flat Phantom	ELI V8.0	2051	NCR	NCR
Simulated Tissue 150 MHz Head	TS-150-H	1709015001	Each Time	/
Simulated Tissue 150 MHz Body	TS-150-B	1709015002	Each Time	/
Network Analyzer	8753C	3033A02857	2019/8/3	2020/8/3
Dielectric assessment kit	1253	SM DAK 040 CA	NCR	NCR
Signal Generator	E8247C	MY43321350	2018/12/10	2019/12/10
Power Meter	E4419B	MY45103907	2019/5/9	2020/5/8
Power Amplifier	ZVA-213-S+	SN054 201245	NCR	NCR
Directional Coupler	53dB	488Z	NCR	NCR
Attenuator	20dB, 100W	LN749	NCR	NCR
Attenuator	6dB, 150W	2754	NCR	NCR

SAR MEASUREMENT SYSTEM VERIFICATION

Liquid Verification

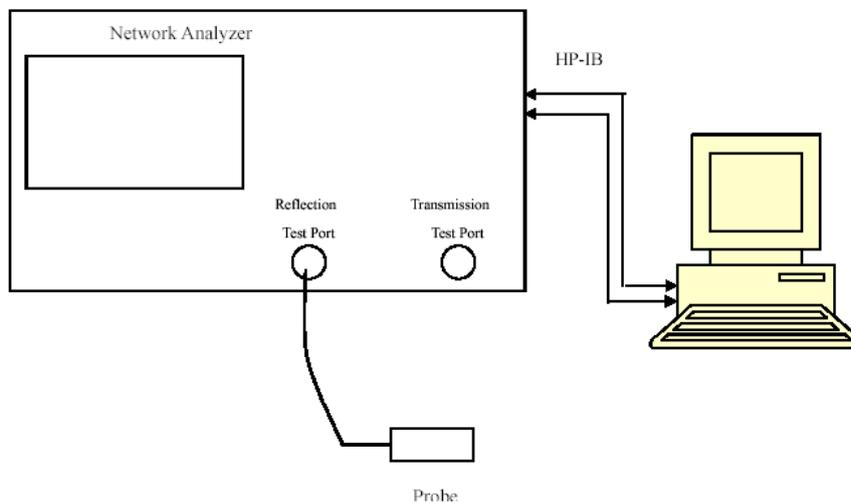

Liquid Verification Setup Block Diagram

Liquid Verification Results

Frequency (MHz)	Liquid Type	Liquid Parameter		Target Value		Delta (%)		Tolerance (%)
		ϵ_r	σ (S/m)	ϵ_r	σ (S/m)	$\Delta\epsilon_r$	$\Delta\sigma$ (S/m)	
136.0125	Simulated Tissue 150 MHz Head	53.034	0.764	52.95	0.75	0.16	1.87	± 5
143.0125	Simulated Tissue 150 MHz Head	52.077	0.763	52.63	0.75	-1.05	1.73	± 5
149.9875	Simulated Tissue 150 MHz Head	52.959	0.769	52.3	0.76	1.26	1.18	± 5
150	Simulated Tissue 150 MHz Head	51.214	0.781	52.3	0.76	-2.08	2.76	± 5
150.0125	Simulated Tissue 150 MHz Head	52.271	0.787	52.3	0.76	-0.06	3.55	± 5
156.0125	Simulated Tissue 150 MHz Head	51.924	0.777	52.02	0.76	-0.18	2.24	± 5
162.0125	Simulated Tissue 150 MHz Head	51.31	0.79	51.74	0.77	-0.83	2.6	± 5
167.9875	Simulated Tissue 150 MHz Head	51.475	0.801	51.46	0.77	0.03	4.03	± 5
173.9875	Simulated Tissue 150 MHz Head	50.663	0.807	51.18	0.78	-1.01	3.46	± 5

*Liquid Verification above was performed on 2019/8/10.

Frequency (MHz)	Liquid Type	Liquid Parameter		Target Value		Delta (%)		Tolerance (%)
		ϵ_r	σ (S/m)	ϵ_r	σ (S/m)	$\Delta\epsilon_r$	$\Delta\sigma$ (S/m)	
136.0125	Simulated Tissue 150 MHz Body	62.292	0.786	62.07	0.79	0.36	-0.51	±5
143.0125	Simulated Tissue 150 MHz Body	61.663	0.794	61.99	0.8	-0.53	-0.75	±5
149.9875	Simulated Tissue 150 MHz Body	61.119	0.799	61.9	0.8	-1.26	-0.13	±5
150	Simulated Tissue 150 MHz Body	61.193	0.802	61.9	0.8	-1.14	0.25	±5
150.0125	Simulated Tissue 150 MHz Body	61.368	0.797	61.9	0.8	-0.86	-0.38	±5
156.0125	Simulated Tissue 150 MHz Body	61.374	0.833	61.83	0.8	-0.74	4.12	±5
162.0125	Simulated Tissue 150 MHz Body	61.063	0.837	61.75	0.8	-1.11	4.62	±5
167.9875	Simulated Tissue 150 MHz Body	61.265	0.829	61.68	0.81	-0.67	2.35	±5
173.9875	Simulated Tissue 150 MHz Body	60.45	0.84	61.6	0.81	-1.87	3.7	±5

*Liquid Verification above was performed on 2019/8/10.

System Accuracy Verification

Prior to the assessment, the system validation kit was used to test whether the system was operating within its specifications of $\pm 10\%$. The validation results are tabulated below. And also the corresponding SAR plot is attached as well in the SAR plots files.

The spacing distance s in the **System Verification Setup Block Diagram** is given by the following:

- a) $s = 15 \text{ mm} \pm 0,2 \text{ mm}$ for $300 \text{ MHz} \leq f \leq 1\,000 \text{ MHz}$;
- b) $s = 10 \text{ mm} \pm 0,2 \text{ mm}$ for $1\,000 \text{ MHz} < f \leq 3\,000 \text{ MHz}$;
- c) $s = 10 \text{ mm} \pm 0,2 \text{ mm}$ for $3\,000 \text{ MHz} < f \leq 6\,000 \text{ MHz}$.
- d) $s = 0 \text{ mm}$ for $f = 150 \text{ MHz}$ (Loop Antenna).

System Verification Setup Block Diagram

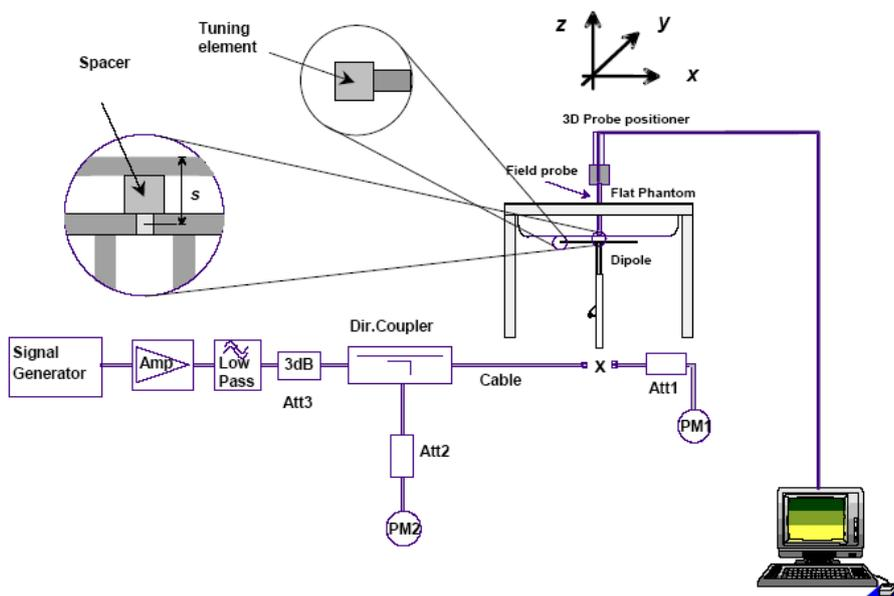

System Accuracy Check Results

Date	Frequency Band	Liquid Type	Input Power (mW)	Measured SAR (W/kg)		Normalized to 1W (W/kg)	Target Value (W/kg)	Delta (%)	Tolerance (%)
2019/8/10	150 MHz	Simulated Tissue 150 MHz Head	100	1g	0.371	3.71	3.64	1.92	± 10
2019/8/10	150 MHz	Simulated Tissue 150 MHz Body	100	1g	0.365	3.65	3.73	-2.14	± 10

*The SAR values above are normalized to 1 Watt forward power.

SAR SYSTEM VALIDATION DATA

System Performance 150 MHz Head

DUT: CLA-150; Type: Loop, 150MHz; Serial: 4020

Communication System: CW; Frequency: 150 MHz; Duty Cycle: 1:1

Medium parameters used: $f = 150 \text{ MHz}$; $\sigma = 0.781 \text{ S/m}$; $\epsilon_r = 51.214$; $\rho = 1000 \text{ kg/m}^3$

Phantom section: Flat Section

DASY5 Configuration:

- Probe: ES3DV2 - SN3019; ConvF(7.67, 7.67, 7.67) @ 150 MHz; Calibrated: 2018/8/20
- Sensor-Surface: 4mm (Mechanical Surface Detection)
- Electronics: DAE3 Sn471; Calibrated: 2018/12/3
- Phantom: ELI v8.0; Type: QDOVA002AA; Serial: TP:2051
- Measurement SW: DASY52, Version 52.10 (2); SEMCAD X Version 14.6.12 (7470)

Area Scan (101x161x1): Interpolated grid: $dx=1.500 \text{ mm}$, $dy=1.500 \text{ mm}$

Maximum value of SAR (interpolated) = 0.399 W/kg

Zoom Scan (5x5x7)/Cube 0: Measurement grid: $dx=8\text{mm}$, $dy=8\text{mm}$, $dz=5\text{mm}$

Reference Value = 23.72 V/m; Power Drift = 0.06 dB

Peak SAR (extrapolated) = 0.548 W/kg

SAR(1 g) = 0.371 W/kg; SAR(10 g) = 0.257 W/kg

Maximum value of SAR (measured) = 0.395 W/kg

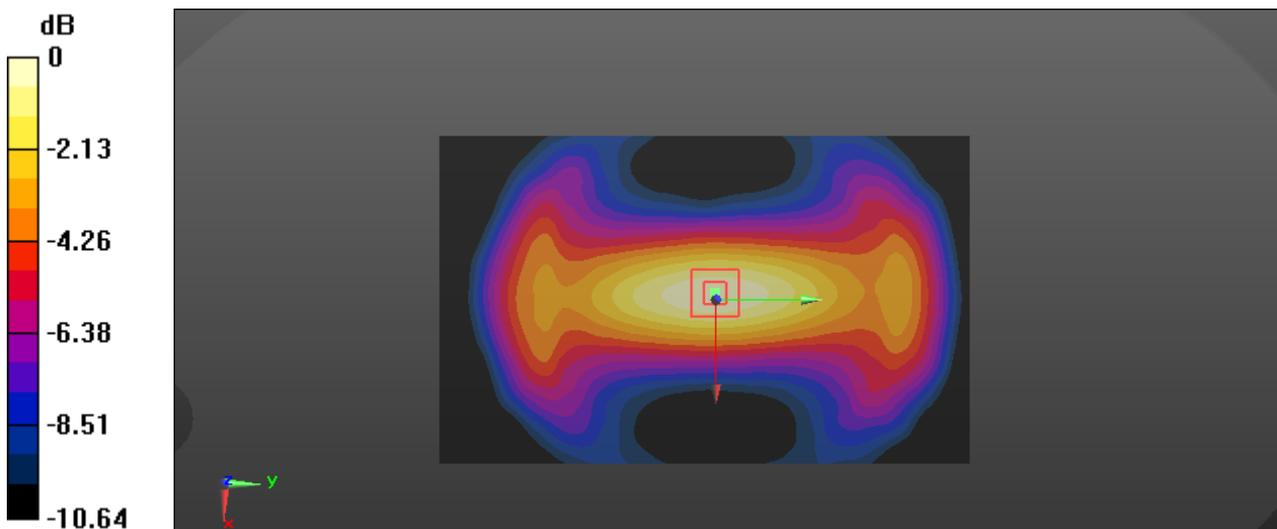

0 dB = 0.395 W/kg = -4.03 dBW/kg

System Performance 150 MHz Body

DUT: CLA-150; Type: Loop, 150 MHz; Serial: 4020

Communication System: CW; Frequency: 150 MHz; Duty Cycle: 1:1

Medium parameters used: $f = 150 \text{ MHz}$; $\sigma = 0.802 \text{ S/m}$; $\epsilon_r = 61.193$; $\rho = 1000 \text{ kg/m}^3$

Phantom section: Flat Section

DASY5 Configuration:

- Probe: ES3DV2 - SN3019; ConvF(7.3, 7.3, 7.3) @ 150 MHz; Calibrated: 2018/8/20
- Sensor-Surface: 4mm (Mechanical Surface Detection)
- Electronics: DAE3 Sn471; Calibrated: 2018/12/3
- Phantom: ELI v8.0; Type: QDOVA002AA; Serial: TP:2051
- Measurement SW: DASY52, Version 52.10 (2); SEMCAD X Version 14.6.12 (7470)

Area Scan (101x161x1): Interpolated grid: $dx=1.500 \text{ mm}$, $dy=1.500 \text{ mm}$

Maximum value of SAR (interpolated) = 0.389 W/kg

Zoom Scan (5x5x7)/Cube 0: Measurement grid: $dx=8\text{mm}$, $dy=8\text{mm}$, $dz=5\text{mm}$

Reference Value = 22.77 V/m; Power Drift = 0.06 dB

Peak SAR (extrapolated) = 0.542 W/kg

SAR(1 g) = 0.365 W/kg; SAR(10 g) = 0.259 W/kg

Maximum value of SAR (measured) = 0.392 W/kg

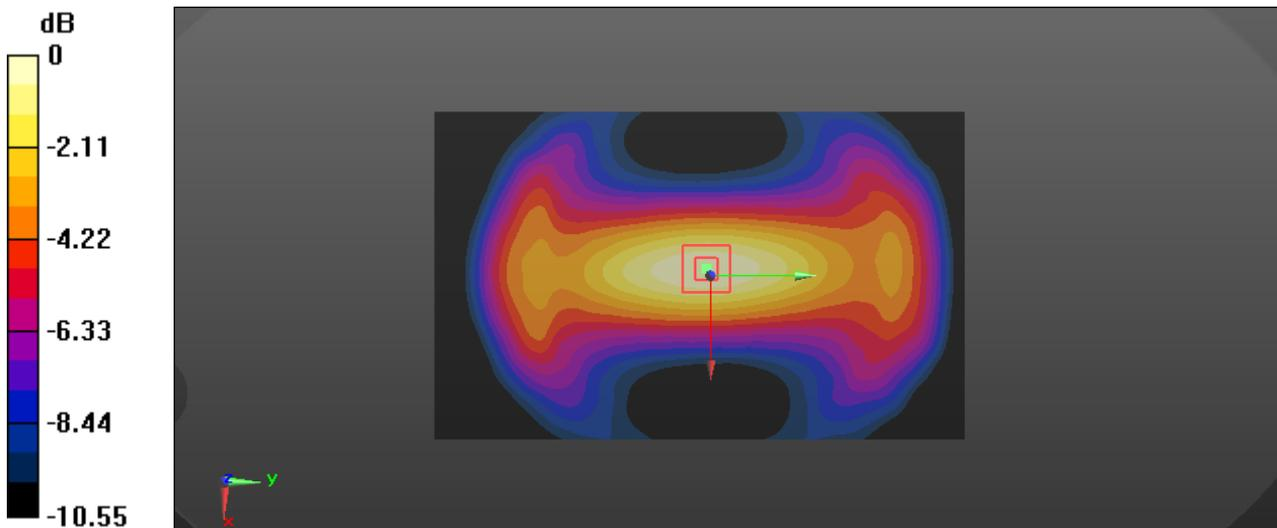

0 dB = 0.392 W/kg = -4.07 dBW/kg

EUT TEST STRATEGY AND METHODOLOGY

Test Positions for Device Operating Next to a Person’s Ear

This category includes most wireless handsets with fixed, retractable or internal antennas located toward the top half of the device, with or without a foldout, sliding or similar keypad cover. The handset should have its earpiece located within the upper ¼ of the device, either along the centerline or off-centered, as perceived by its users. This type of handset should be positioned in a normal operating position with the “test device reference point” located along the “vertical centerline” on the front of the device aligned to the “ear reference point”. The “test device reference point” should be located at the same level as the center of the earpiece region. The “vertical centerline” should bisect the front surface of the handset at its top and bottom edges. A “ear reference point” is located on the outer surface of the head phantom on each ear spacer. It is located 1.5 cm above the center of the ear canal entrance in the “phantom reference plane” defined by the three lines joining the center of each “ear reference point” (left and right) and the tip of the mouth.

A handset should be initially positioned with the earpiece region pressed against the ear spacer of a head phantom. For the SCC-34/SC-2 head phantom, the device should be positioned parallel to the “N-F” line defined along the base of the ear spacer that contains the “ear reference point”. For interim head phantoms, the device should be positioned parallel to the cheek for maximum RF energy coupling. The “test device reference point” is aligned to the “ear reference point” on the head phantom and the “vertical centerline” is aligned to the “phantom reference plane”. This is called the “initial ear position”. While maintaining these three alignments, the body of the handset is gradually adjusted to each of the following positions for evaluating SAR:

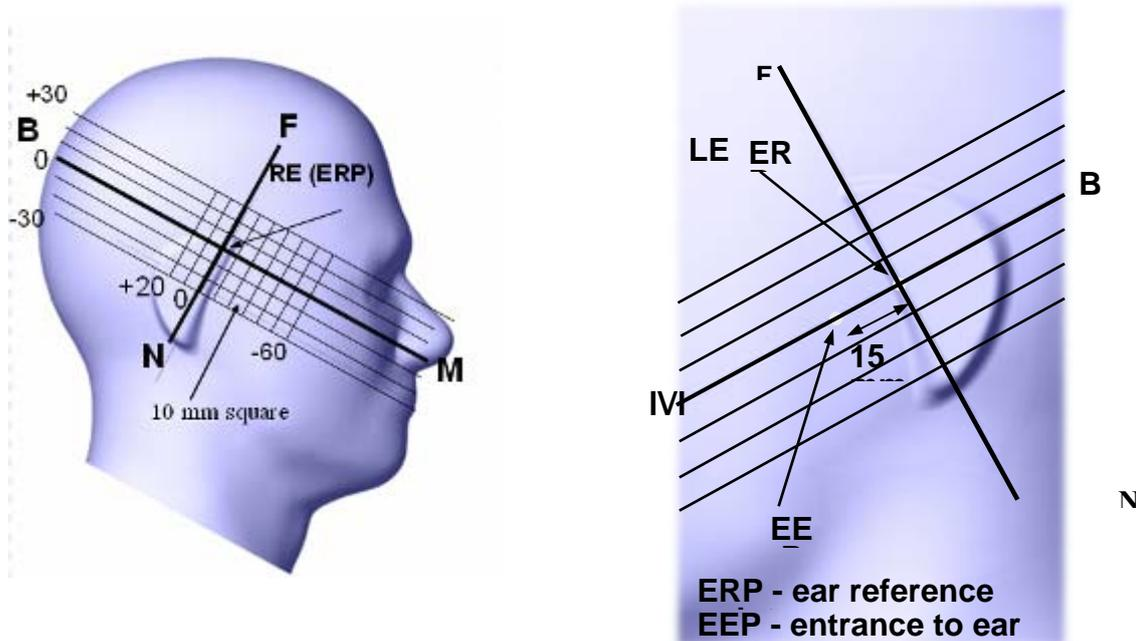

Cheek/Touch Position

The device is brought toward the mouth of the head phantom by pivoting against the “ear reference point” or along the “N-F” line for the SCC-34/SC-2 head phantom.

This test position is established:

When any point on the display, keypad or mouthpiece portions of the handset is in contact with the phantom.

(or) When any portion of a foldout, sliding or similar keypad cover opened to its intended self-adjusting normal use position is in contact with the cheek or mouth of the phantom.

For existing head phantoms – when the handset loses contact with the phantom at the pivoting point, rotation should continue until the device touches the cheek of the phantom or breaks its last contact from the ear spacer.

Cheek /Touch Position

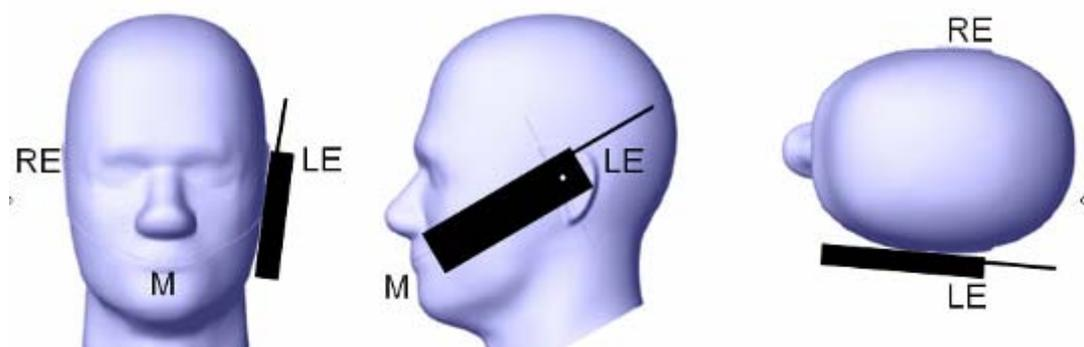

Ear/Tilt Position

With the handset aligned in the “Cheek/Touch Position”:

1) If the earpiece of the handset is not in full contact with the phantom’s ear spacer (in the “Cheek/Touch position”) and the peak SAR location for the “Cheek/Touch” position is located at the ear spacer region or corresponds to the earpiece region of the handset, the device should be returned to the “initial ear position” by rotating it away from the mouth until the earpiece is in full contact with the ear spacer.

2) (otherwise) The handset should be moved (translated) away from the cheek perpendicular to the line passes through both “ear reference points” (note: one of these ear reference points may not physically exist on a split head model) for approximate 2-3 cm. While it is in this position, the device handset is tilted away from the mouth with respect to the “test device reference point” until the inside angle between the vertical centerline on the front surface of the phone and the horizontal line passing through the ear reference point is by 15° to 80° . After the tilt, it is then moved (translated) back toward the head perpendicular to the line passes through both “ear reference points” until the device touches the phantom or the ear spacer. If the antenna touches the head first, the positioning process should be repeated with a tilt angle less than 15° so that the device and its antenna would touch the phantom simultaneously. This test position may require a device holder or positioner to achieve the translation and tilting with acceptable positioning repeatability.

If a device is also designed to transmit with its keypad cover closed for operating in the head position, such positions should also be considered in the SAR evaluation. The device should be tested on the left and right side of the head phantom in the “Cheek/Touch” and “Ear/Tilt” positions. When applicable, each configuration should be tested with the antenna in its fully extended and fully retracted positions. These test configurations should be tested at the high, middle and low frequency channels of each operating mode; for example, AMPS, CDMA, and TDMA. If the SAR measured at the middle channel for each test configuration (left, right, Cheek/Touch, Tilt/Ear, extended and retracted) is at least 2.0 dB lower than the SAR limit, testing at the high and low channels is optional for such test configuration(s). If the transmission band of the test device is less than 10 MHz, testing at the high and low frequency channels is optional.

Ear /Tilt 15° Position

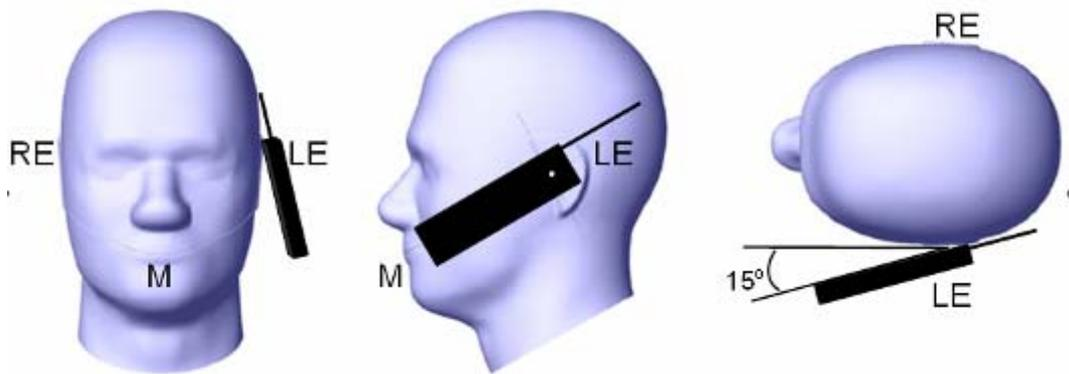

Test positions for body-worn and other configurations

Body-worn operating configurations should be tested with the belt-clips and holsters attached to the device and positioned against a flat phantom in normal use configurations. Devices with a headset output should be tested with a headset connected to the device. When multiple accessories that do not contain metallic components are supplied with the device, the device may be tested with only the accessory that dictates the closest spacing to the body. When multiple accessories that contain metallic components are supplied with the device, the device must be tested with each accessory that contains a unique metallic component. If multiple accessories share an identical metallic component (e.g., the same metallic belt-clip used with different holsters with no other metallic components), only the accessory that dictates the closest spacing to the body must be tested.

Body-worn accessories may not always be supplied or available as options for some devices that are intended to be authorized for body-worn use. A separation distance of 1.5 cm between the back of the device and a flat phantom is recommended for testing body-worn SAR compliance under such circumstances. Other separation distances may be used, but they should not exceed 2.5 cm. In these cases, the device may use body-worn accessories that provide a separation distance greater than that tested for the device provided however that the accessory contains no metallic components.

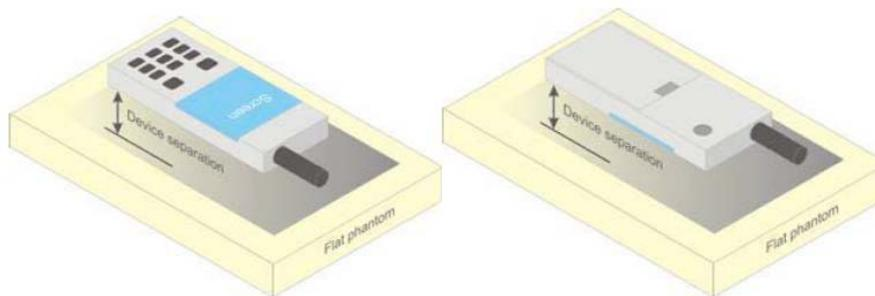

Figure 5 – Test positions for body-worn devices

Test Distance for SAR Evaluation

In this case the DUT(Device Under Test) is set directly against the phantom, the test distance is 0mm for Body Back mode; for Face Up mode the distance is 25mm.

SAR Evaluation Procedure

The evaluation was performed with the following procedure:

Step 1: Measurement of the SAR value at a fixed location above the ear point or central position was used as a reference value for assessing the power drop. The SAR at this point is measured at the start of the test and then again at the end of the testing.

Step 2: The SAR distribution at the exposed side of the head was measured at a distance of 4 mm from the inner surface of the shell. The area covered the entire dimension of the head or radiating structures of the EUT, the horizontal grid spacing was 15 mm x 15 mm, and the SAR distribution was determined by integrated grid of 1.5mm x 1.5mm. Based on these data, the area of the maximum absorption was determined by spline interpolation. The first Area Scan covers the entire dimension of the EUT to ensure that the hotspot was correctly identified.

Step 3: Around this point, a volume of 30 mm x 30 mm x 30 mm was assessed by measuring 7x 7 x 7 points. On the basis of this data set, the spatial peak SAR value was evaluated under the following procedure:

- 1) The data at the surface were extrapolated, since the center of the dipoles is 1.2 mm away from the tip of the probe and the distance between the surface and the lowest measuring point is 1.3 mm. The extrapolation was based on a least square algorithm. A polynomial of the fourth order was calculated through the points in z-axes. This polynomial was then used to evaluate the points between the surface and the probe tip.

- 2) The maximum interpolated value was searched with a straightforward algorithm. Around this maximum the SAR values averaged over the spatial volumes (1 g or 10 g) were computed by the 3D-Spline interpolation algorithm. The 3D-Spline is composed of three one dimensional splines with the "Not a knot"-condition (in x, y and z-directions). The volume was integrated with the trapezoidal-algorithm. One thousand points (10 x 10 x 10) were interpolated to calculate the averages.

All neighboring volumes were evaluated until no neighboring volume with a higher average value was found.

Step 4: Re-measurement of the SAR value at the same location as in Step 1. If the value changed by more than 5%, the evaluation was repeated.

CONDUCTED OUTPUT POWER MEASUREMENT

Provision Applicable

The measured peak output power should be greater and within 5% than EMI measurement.

Test Procedure

The RF output of the transmitter was connected to the input of the EMI Test Receiver through sufficient attenuation.

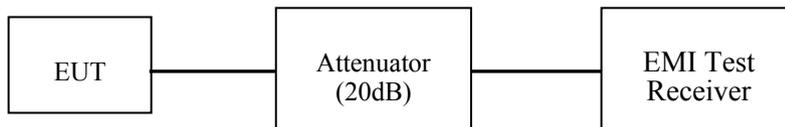

The EMI Test Receiver setting:

RBW	VBW
100 kHz	300 kHz

Maximum Target Output Power

Mode		Max. tune-up tolerance power limit for Production
PTT (136-174MHz)	FM_12.5kHz	5.5 (W)
	FM_25kHz	5.5 (W)
	4FSK_12.5kHz	5.5 (W)

Test Results:

EUT Model	Test Mode	Frequency (MHz)	Output Power(W)	Power level
DR5510-1	FM 12.5 kHz	136.0125	5.18	High
		143.0125	5.25	High
		149.9875	5.11	High
		150.0125	5.2	High
		156.0125	5.28	High
		162.0125	5.2	High
		167.9875	5.15	High
		173.9875	5.15	High
	FM 25 kHz	136.0125	5.27	High
		143.0125	5.26	High
		149.9875	5.25	High
		150.0125	5.19	High
		156.0125	5.13	High
		162.0125	5.18	High
		167.9875	5.27	High
		173.9875	5.24	High
	4FSK 12.5 kHz	136.0125	5.24	High
		143.0125	5.21	High
		149.9875	5.18	High
		150.0125	5.17	High
		156.0125	5.14	High
		162.0125	5.18	High
		167.9875	5.18	High
		173.9875	5.29	High
DR5610-1	FM 12.5 kHz	136.0125	5.11	High
		143.0125	5.18	High
		149.9875	5.15	High
		150.0125	5.23	High
		156.0125	5.22	High
		162.0125	5.13	High
		167.9875	5.24	High
		173.9875	5.15	High
	FM 25 kHz	136.0125	5.16	High
		143.0125	5.12	High
		149.9875	5.19	High
		150.0125	5.22	High
		156.0125	5.28	High
		162.0125	5.27	High
		167.9875	5.16	High
		173.9875	5.14	High
	4FSK 12.5 kHz	136.0125	5.16	High
		143.0125	5.22	High
149.9875		5.17	High	

DR5810-1		150.0125	5.26	High	
		156.0125	5.19	High	
		162.0125	5.23	High	
		167.9875	5.27	High	
		173.9875	5.24	High	
	FM 12.5 kHz	136.0125	5.11	High	
		143.0125	5.23	High	
		149.9875	5.18	High	
		150.0125	5.2	High	
		156.0125	5.18	High	
		162.0125	5.21	High	
		167.9875	5.39	High	
		173.9875	5.35	High	
		FM 25 kHz	136.0125	5.14	High
			143.0125	5.11	High
			149.9875	5.21	High
			150.0125	5.26	High
			156.0125	5.31	High
	162.0125		5.38	High	
	167.9875		5.32	High	
	173.9875	5.31	High		
	4FSK 12.5 kHz	136.0125	5.39	High	
		143.0125	5.23	High	
		149.9875	5.39	High	
		150.0125	5.35	High	
		156.0125	5.16	High	
		162.0125	5.19	High	
		167.9875	5.13	High	
173.9875	5.22	High			

Antennas Location:

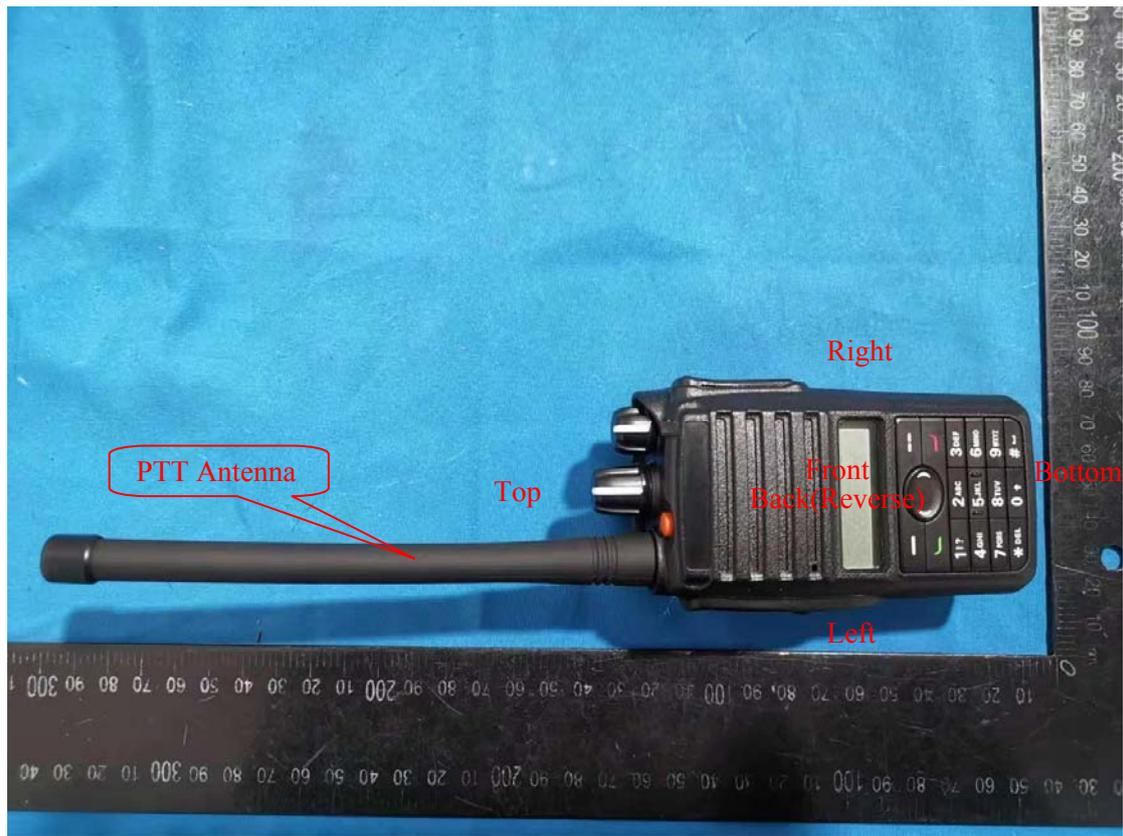

SAR MEASUREMENT RESULTS

This page summarizes the results of the performed dosimetric evaluation.

SAR Test Data

Environmental Conditions

Temperature:	22.9-23.7 °C
Relative Humidity:	45 %
ATM Pressure:	100.6 kPa
Test Date:	2019/8/10

Testing was performed by Steve Zhou, Brave Lu, Harvey Lei.

Test Result:

Antenna 1(136-150 MHz):

Pre-Scan all 3 Channels of antenna 1, the peak SAR located on 149.9875MHz for Face Up and Body Back mode.

Test Mode		EUT Model	Frequency (MHz)	Max. Meas. Power (W)	Maximum output Power(W)	1 g SAR Value(W/kg)					
						Scaled Factor	Meas. SAR	50%	Scaled SAR	Corrected SAR	Plot
Head Face Up (25 mm)	FM 12.5 kHz	DR5810-1	136.0125	5.11	5.5	1.076	0.065	0.033	0.036	0.04	1#
			143.0125	5.23	5.5	1.052	0.63	0.315	0.331	0.34	2#
			149.9875	5.18	5.5	1.062	1.25	0.625	0.664	0.67	3#
		DR5510-1	149.9875	5.11	5.5	1.076	0.858	0.429	0.462	0.47	4#
		DR5610-1	149.9875	5.15	5.5	1.068	0.982	0.491	0.524	0.53	5#
	FM 25 kHz	DR5810-1	136.0125	/	/	/	/	/	/	/	/
			143.0125	/	/	/	/	/	/	/	/
			149.9875	5.21	5.5	1.056	1.02	0.51	0.539	0.54	6#
	4FSK 12.5 kHz	DR5810-1	136.0125	/	/	/	/	/	/	/	/
			143.0125	/	/	/	/	/	/	/	/
			149.9875	5.39	5.5	1.02	0.483	0.242	0.247	0.25	7#

Test Mode		EUT Model	Frequency (MHz)	Max. Meas. Power (W)	Maximum output Power(W)	1 g SAR Value(W/kg)					
						Scaled Factor	Meas. SAR	50%	Scaled SAR	Corrected SAR	Plot
Body Back (25 mm)	FM 12.5 kHz	DR5810-1	136.0125	5.11	5.5	1.076	0.696	0.348	0.374	0.38	8#
			143.0125	5.23	5.5	1.052	3.76	1.88	1.978	1.98	9#
			149.9875	5.18	5.5	1.062	6.58	3.29	3.494	3.50	10#
		DR5510-1	149.9875	5.11	5.5	1.076	6.38	3.19	3.432	3.44	11#
		DR5610-1	149.9875	5.15	5.5	1.068	6.18	3.09	3.3	3.30	12#
	FM 25 kHz	DR5810-1	136.0125	/	/	/	/	/	/	/	/
			143.0125	/	/	/	/	/	/	/	/
			149.9875	5.21	5.5	1.056	6.37	3.185	3.363	3.37	13#
	4FSK 12.5 kHz	DR5810-1	136.0125	/	/	/	/	/	/	/	/
			143.0125	/	/	/	/	/	/	/	/
			149.9875	5.39	5.5	1.02	3.28	1.64	1.673	1.68	14#

Antenna 2(150-174 MHz):

Pre-Scan all 5 Channels of antenna 2, the peak SAR located on 156.0125MHz for Face Up and Body Back mode

Test Mode	EUT Model	Frequency (MHz)	Max. Meas. Power (W)	Maximum output Power(W)	1 g SAR Value(W/kg)								
					Scaled Factor	Meas. SAR	50%	Scaled SAR	Corrected SAR	Plot			
Head Face Up (25 mm)	FM 12.5 kHz	DR5810-1	150.0125	5.2	5.5	1.058	0.859	0.43	0.455	0.46	15#		
			156.0125	5.18	5.5	1.062	2.21	1.105	1.174	1.18	16#		
			162.0125	5.21	5.5	1.056	1.84	0.92	0.972	0.98	17#		
			167.9875	5.39	5.5	1.02	1.41	0.705	0.719	0.72	18#		
			173.9875	5.35	5.5	1.028	0.667	0.334	0.343	0.35	19#		
	DR5510-1	156.0125	5.28	5.5	1.042	2.02	1.01	1.052	1.06	20#			
		DR5610-1	156.0125	5.22	5.5	1.054	1.94	0.97	1.022	1.03	21#		
			FM 25 kHz	DR5810-1	150.0125	/	/	/	/	/	/	/	/
					156.0125	5.31	5.5	1.036	1.79	0.895	0.927	0.93	22#
					162.0125	/	/	/	/	/	/	/	/
	167.9875				/	/	/	/	/	/	/	/	
	173.9875	/			/	/	/	/	/	/	/		
	4FSK 12.5 kHz	DR5810-1	150.0125	/	/	/	/	/	/	/	/		
			156.0125	5.16	5.5	1.066	1.14	0.57	0.608	0.61	23#		
			162.0125	/	/	/	/	/	/	/	/		
			167.9875	/	/	/	/	/	/	/	/		
			173.9875	/	/	/	/	/	/	/	/		

Test Mode	EUT Model	Frequency (MHz)	Max. Meas. Power (W)	Maximum output Power(W)	1 g SAR Value(W/kg)								
					Scaled Factor	Meas. SAR	50%	Scaled SAR	Corrected SAR	Plot			
Body Back (25 mm)	FM 12.5 kHz	DR5810-1	150.0125	5.2	5.5	1.058	6.47	3.235	3.423	3.43	24#		
			156.0125	5.18	5.5	1.062	6.67	3.335	3.542	3.55	25#		
			162.0125	5.21	5.5	1.056	4.61	2.305	2.434	2.44	26#		
			167.9875	5.39	5.5	1.02	1.53	0.765	0.78	0.78	27#		
			173.9875	5.35	5.5	1.028	1.01	0.505	0.519	0.52	28#		
	DR5510-1	156.0125	5.28	5.5	1.042	6.62	3.31	3.449	3.45	29#			
		DR5610-1	156.0125	5.22	5.5	1.054	6.35	3.175	3.346	3.35	30#		
			FM 25 kHz	DR5810-1	150.0125	/	/	/	/	/	/	/	/
					156.0125	5.31	5.5	1.036	6.49	3.245	3.362	3.37	31#
					162.0125	/	/	/	/	/	/	/	/
	167.9875				/	/	/	/	/	/	/	/	
	173.9875	/			/	/	/	/	/	/	/		
	4FSK 12.5 kHz	DR5810-1	150.0125	/	/	/	/	/	/	/	/		
			156.0125	5.16	5.5	1.066	4.41	2.205	2.351	2.36	32#		
			162.0125	/	/	/	/	/	/	/	/		
			167.9875	/	/	/	/	/	/	/	/		
			173.9875	/	/	/	/	/	/	/	/		

Note:

1. When the 1-g SAR is $\leq 3.5\text{W/kg}$, testing for other channels are optional.
2. KDB 447498 D01 - A duty factor of 50% should be applied to determine compliance for radios with maximum operating duty factors $\leq 50\%$. The 50% duty factor only applies to exposure conditions where the radio operates with a mechanical PTT button.
3. The whole antenna and radiating structures that may contribute to the measured SAR or influence the SAR distribution has been included in the area scan.
4. According to EN 62209-2:2010 ,If the correction ΔSAR has a positive sign, the measured SAR results shall not be corrected.

SAR Measurement Variability

In accordance with published RF Exposure KDB procedure 865664 D01 SAR measurement 100 MHz to 6 GHz v01. These additional measurements are repeated after the completion of all measurements requiring the same head or body tissue-equivalent medium in a frequency band.. The test device should be returned to ambient conditions (normal room temperature) with the battery fully charged before it is re-mounted on the device holder for the repeated measurement(s) to minimize any unexpected variations in the repeated results

- 1) Repeated measurement is not required when the original highest measured SAR is < 0.80 W/kg.
- 2) When the original highest measured SAR is ≥ 0.80 W/kg, repeat that measurement once.
- 3) Perform a second repeated measurement only if the ratio of largest to smallest SAR for the original and first repeated measurements is > 1.20 or when the original or repeated measurement is ≥ 1.45 W/kg (~ 10% from the 1-g SAR limit).
- 4) Perform a third repeated measurement only if the original, first or second repeated measurement is ≥ 1.5 W/kg and the ratio of largest to smallest SAR for the original, first and second repeated measurements is > 1.20.
- 5) The same procedures should be adapted for measurements according to occupational exposure limits by applying a factor of 2.5 for extremity exposure and a factor of 5 for occupational exposure to the corresponding SAR thresholds.

Note: The same procedures should be adapted for measurements according to extremity and occupational exposure limits by applying a factor of 2.5 for extremity exposure and a factor of 5 for occupational exposure to the corresponding SAR thresholds.

The Highest Measured SAR Configuration in Each Frequency Band

Head(Face Up)

SAR probe calibration point	Frequency Band	Freq.(MHz)	EUT Position	Meas. SAR (W/kg)		Largest to Smallest SAR Ratio
				Original	Repeated	
/	/	/	/	/	/	/

Body(Body Back)

SAR probe calibration point	Frequency Band	Freq.(MHz)	EUT Position	Meas. SAR (W/kg)		Largest to Smallest SAR Ratio
				Original	Repeated	
150MHz (100-200 MHz)	Ant1_FM12.5 kHz	149.8875	Body Back	6.58	6.27	1.05
150MHz (100-200 MHz)	Ant2_FM12.5 kHz	149.8875	Body Back	6.67	6.54	1.02

Note:

1. Second Repeated Measurement is not required since the ratio of the largest to smallest SAR for the original and first repeated measurement is not > 1.20.
2. The measured SAR results **do not** have to be scaled to the maximum tune-up tolerance to determine if repeated measurements are required.
3. SAR measurement variability must be assessed for each frequency band, which is determined by the **SAR probe calibration point and tissue-equivalent medium** used for the device measurements.

Corrected SAR Evaluation

Corrected SAR Evaluation

62209-2 © IEC:2010

– 89 –

Annex F (normative)

SAR correction for deviations of complex permittivity from targets

F.2 SAR correction formula

From [13] and [14], a linear relationship was found between the percent change in SAR (denoted ΔSAR) and the percent change in the permittivity and conductivity from the target values in Table 1 (denoted $\Delta \epsilon_r$ and $\Delta \sigma$, respectively). This linear relationship agrees with the results of Kuster and Balzano [48] and Bit-Babik et al. [2]. The relationship is given by:

$$\Delta SAR = c_\epsilon \Delta \epsilon_r + c_\sigma \Delta \sigma \quad (F.1)$$

where

$c_\epsilon = \partial(\Delta SAR)/\partial(\Delta \epsilon)$ is the coefficients representing the sensitivity of SAR to permittivity where SAR is normalized to output power;

$c_\sigma = \partial(\Delta SAR)/\partial(\Delta \sigma)$ is the coefficients representing the sensitivity of SAR to conductivity, where SAR is normalized to output power.

The values of c_ϵ and c_σ have a simple relationship with frequency that can be described using polynomial equations. For the 1 g averaged SAR c_ϵ and c_σ are given by

$$c_\epsilon = -7,854 \times 10^{-4} f^3 + 9,402 \times 10^{-3} f^2 - 2,742 \times 10^{-2} f - 0,2026 \quad (F.2)$$

$$c_\sigma = 9,804 \times 10^{-3} f^3 - 8,661 \times 10^{-2} f^2 + 2,981 \times 10^{-2} f + 0,7829 \quad (F.3)$$

where

f is the frequency in GHz.

For the 10 g averaged SAR, the variables c_ϵ and c_σ are given by:

$$c_\epsilon = 3,456 \times 10^{-3} f^3 - 3,531 \times 10^{-2} f^2 + 7,675 \times 10^{-2} f - 0,1860 \quad (F.4)$$

$$c_\sigma = 4,479 \times 10^{-3} f^3 - 1,586 \times 10^{-2} f^2 - 0,1972 f + 0,7717 \quad (F.5)$$

$$\Delta SAR = c_{\epsilon} \Delta \epsilon_r + c_{\delta} \Delta \delta$$

$$c_{\epsilon} = -7,854 \times 10^{-4} f^3 + 9,402 \times 10^{-3} f^2 - 2,742 \times 10^{-2} f - 0,2026 \tag{F.2}$$

$$c_{\delta} = 9,804 \times 10^{-3} f^3 - 8,661 \times 10^{-2} f^2 + 2,981 \times 10^{-2} f + 0,7829 \tag{F.3}$$

Corrected SAR = Measured SAR * ((100 + (ΔSAR x -1)) /100)

Corrected SAR Evaluation Table:

Frequency (MHz)	Liquid Type	C ε	Δ ε r	C δ	Δ δ	ΔSAR (%)
136.0125	1g Head	-0.206	0.16	0.785	1.87	1.44
143.0125	1g Head	-0.206	-1.05	0.785	1.73	1.58
149.9875	1g Head	-0.206	1.26	0.785	1.18	0.67
150	1g Head	-0.207	-2.08	0.785	2.76	2.60
150.0125	1g Head	-0.207	-0.06	0.785	3.55	2.80
156.0125	1g Head	-0.207	-0.18	0.785	2.24	1.80
162.0125	1g Head	-0.207	-0.83	0.785	2.6	2.21
167.9875	1g Head	-0.207	0.03	0.786	4.03	3.16
173.9875	1g Head	-0.207	-1.01	0.786	3.46	2.93
136.0125	1g Body	-0.206	0.36	0.785	-0.51	-0.47
143.0125	1g Body	-0.206	-0.53	0.785	-0.75	-0.48
149.9875	1g Body	-0.206	-1.26	0.785	-0.13	0.16
150	1g Body	-0.207	-1.14	0.785	0.25	0.43
150.0125	1g Body	-0.207	-0.86	0.785	-0.38	-0.12
156.0125	1g Body	-0.207	-0.74	0.785	4.12	3.39
162.0125	1g Body	-0.207	-1.11	0.785	4.62	3.86
167.9875	1g Body	-0.207	-0.67	0.786	2.35	1.98
173.9875	1g Body	-0.207	-1.87	0.786	3.7	3.29

SAR Plots

Please Refer to the Attachment.

APPENDIX A MEASUREMENT UNCERTAINTY

The uncertainty budget has been determined for the measurement system and is given in the following Table.

Measurement uncertainty evaluation for IEEE1528-2013 SAR test

Source of uncertainty	Tolerance/ uncertainty ± %	Probability distribution	Divisor	ci (1 g)	ci (10 g)	Standard uncertainty ± %, (1 g)	Standard uncertainty ± %, (10 g)
Measurement system							
Probe calibration	6.55	N	1	1	1	6.6	6.6
Axial Isotropy	4.7	R	$\sqrt{3}$	1	1	2.7	2.7
Hemispherical Isotropy	9.6	R	$\sqrt{3}$	0	0	0.0	0.0
Boundary effect	1.0	R	$\sqrt{3}$	1	1	0.6	0.6
Linearity	4.7	R	$\sqrt{3}$	1	1	2.7	2.7
Detection limits	1.0	R	$\sqrt{3}$	1	1	0.6	0.6
Readout electronics	0.3	N	1	1	1	0.3	0.3
Response time	0.0	R	$\sqrt{3}$	1	1	0.0	0.0
Integration time	0.0	R	$\sqrt{3}$	1	1	0.0	0.0
RF ambient conditions – noise	1.0	R	$\sqrt{3}$	1	1	0.6	0.6
RF ambient conditions–reflections	1.0	R	$\sqrt{3}$	1	1	0.6	0.6
Probe positioner mech. Restrictions	0.8	R	$\sqrt{3}$	1	1	0.5	0.5
Probe positioning with respect to phantom shell	6.7	R	$\sqrt{3}$	1	1	3.9	3.9
Post-processing	2.0	R	$\sqrt{3}$	1	1	1.2	1.2
Test sample related							
Test sample positioning	2.8	N	1	1	1	2.8	2.8
Device holder uncertainty	6.3	N	1	1	1	6.3	6.3
Drift of output power	5.0	R	$\sqrt{3}$	1	1	2.9	2.9
Phantom and set-up							
Phantom uncertainty (shape and thickness tolerances)	4.0	R	$\sqrt{3}$	1	1	2.3	2.3
Liquid conductivity target)	5.0	R	$\sqrt{3}$	0.64	0.43	1.8	1.2
Liquid conductivity meas.)	2.5	N	1	0.64	0.43	1.6	1.1
Liquid permittivity target)	5.0	R	$\sqrt{3}$	0.6	0.49	1.7	1.4
Liquid permittivity meas.)	2.5	N	1	0.6	0.49	1.5	1.2
Combined standard uncertainty		RSS				12.2	12.0
Expanded uncertainty 95 % confidence interval)						24.3	23.9

Measurement uncertainty evaluation for IEC62209-2 SAR test

Source of uncertainty	Tolerance/uncertainty ± %	Probability distribution	Divisor	ci (1 g)	ci (10 g)	Standard uncertainty ± %, (1 g)	Standard uncertainty ± %, (10 g)
Measurement system							
Probe calibration	6.55	N	1	1	1	6.6	6.6
Axial Isotropy	4.7	R	√3	1	1	2.7	2.7
Hemispherical Isotropy	9.6	R	√3	0	0	0.0	0.0
Linearity	4.7	R	√3	1	1	2.7	2.7
Modulation Response	0.0	R	√3	1	1	0.0	0.0
Detection limits	1.0	R	√3	1	1	0.6	0.6
Boundary effect	1.0	R	√3	1	1	0.6	0.6
Readout electronics	0.3	N	1	1	1	0.3	0.3
Response time	0.0	R	√3	1	1	0.0	0.0
Integration time	0.0	R	√3	1	1	0.0	0.0
RF ambient conditions – noise	1.0	R	√3	1	1	0.6	0.6
RF ambient conditions–reflections	1.0	R	√3	1	1	0.6	0.6
Probe positioner mech. Restrictions	0.8	R	√3	1	1	0.5	0.5
Probe positioning with respect to phantom shell	6.7	R	√3	1	1	3.9	3.9
Post-processing	2.0	R	√3	1	1	1.2	1.2
Test sample related							
Device holder Uncertainty	6.3	N	1	1	1	6.3	6.3
Test sample positioning	2.8	N	1	1	1	2.8	2.8
Power scaling	4.5	R	√3	1	1	2.6	2.6
Drift of output power	5.0	R	√3	1	1	2.9	2.9
Phantom and set-up							
Phantom uncertainty (shape and thickness tolerances)	4.0	R	√3	1	1	2.3	2.3
Algorithm for correcting SAR for deviations in permittivity and conductivity	1.9	N	1	1	0.84	1.1	0.9
Liquid conductivity (meas.)	2.5	N	1	0.64	0.43	1.6	1.1
Liquid permittivity (meas.)	2.5	N	1	0.6	0.49	1.5	1.2
Temp. unc. - Conductivity	1.7	R	√3	0.78	0.71	0.8	0.7
Temp. unc. - Permittivity	0.3	R	√3	0.23	0.26	0.0	0.0
Combined standard uncertainty		RSS				12.2	12.1
Expanded uncertainty 95 % confidence interval)						24.5	24.2

APPENDIX B EUT TEST POSITION PHOTOS

Please Refer to the Attachment.

APPENDIX C CALIBRATION CERTIFICATES

Please Refer to the Attachment.

Declarations

1. BACL is not responsible for the authenticity of any test data provided by the applicant. Data included from the applicant that may affect test results are marked with a triangle symbol “ Δ ”. Customer model name, addresses, names, trademarks etc. are not considered data.
2. Unless otherwise stated the results shown in this test report refer only to the sample(s) tested.
3. Otherwise required by the applicant or Product Regulations, Decision Rule in this report did not consider the uncertainty.
4. The extended uncertainty given in this report is obtained by combining the standard uncertainty times the coverage factor K with the 95% confidence interval.
5. This report cannot be reproduced except in full, without prior written approval of the Company.
6. This report is valid only with a valid digital signature. The digital signature may be available only under the Adobe software above version 7.0.
7. This report must not be used by the customer to claim product certification, approval, or endorsement by A2LA, or any agency of the U.S. Government.
8. This report may contain data that are not covered by the accreditation scope and shall be marked with an asterisk “★” .

******* END OF REPORT *******