

# Instruction Manual

DM6000-1 / DM6100-1

## Mobile Radio

Thank you for purchasing a COVALUE mobile radio.

This simple to use radio adopts the latest advances in technology, providing reliable communication in today's demanding communication environment.

### Notices to the User:

When condensation occurs inside the transceiver:

• Condensation may occur inside the transceiver when the room is warmed using a heater on a cold day or when the transceiver is quickly moved from a cold location to a warm location.

• When condensation occurs, the microcomputer and /or the transmit/receive circuits may become unstable, resulting in transceiver malfunction.

• If this happens, turn OFF the transceiver and wait for a while.

• When the condensed droplets disappear, the transceiver will function normally.

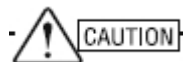

Do not touch the metal surface of the transceiver while it is in use.

Do not mount the transceiver such that the chassis can come in contact with skin.

High temperatures may burn your skin.

### PRECAUTIONS

Please observe the following precautions to prevent fire, personal injury, and/or

transceiver damage:

- Do not attempt to configure your transceiver while driving; it is simply too dangerous.
- Be aware of local laws pertaining to the use of headphones/headsets while driving on public roads.

If in doubt, do not wear headphones while mobiling.

- Do not transmit with high output power for extended periods; the transceiver may overheat.
- Do not modify the transceiver unless instructed by this manual or other **COVALUE** documentation.
- Do not expose the transceiver to long periods of direct sunlight nor place it close to heating appliances.
- Do not place the transceiver in excessively dusty, humid or wet areas, nor on unstable surfaces.
- If an abnormal odor or smoke is detected coming from the transceiver, turn OFF the power immediately. Contact a **COVALUE** service station or your dealer.
- This transceiver is designed for a 12 V power source. Never use a 24 V battery to power the transceiver.

## SUPPLIED ACCESSORIES

After carefully unpacking the transceiver, identify the items listed in the table below. We recommend you keep the box and packaging for shipping.

Accessory	Qty
Microphone (DTMF Mic)	1
DC power cable(Blade)	1
Fuse(Blade)	1
Mounting bracket	1
Screw set	1
Microphone hanger	1
Instruction manual	1

## CHAPTER 1 PREPARATION

### MOBILE INSTALLATION

To install the transceiver, select a safe, convenient location inside your vehicle that minimizes danger to your passengers and yourself while the vehicle is in motion. Consider installing the unit at an appropriate position so that knees or legs will not strike it during sudden braking of your vehicle. Try to pick a well ventilated location that is shielded from direct sunlight.

**1** Install the mounting bracket in the vehicle using the supplied self-tapping screws (4), flat washers (4), and Spring washers (4).

The bracket must be installed so that the 3 screw long hole positions on the side of the mounting bracket are towards the rear of the bracket.

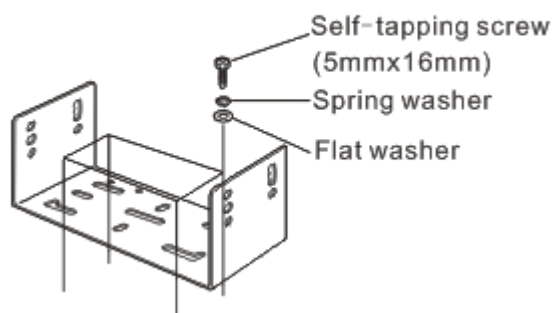

**2** Position the transceiver, then insert and tighten the supplied hexagon SEMS screws (4) and flat washers (4).

Double check that all hardware is tightened to prevent

vehicle vibration from loosening the bracket or transceiver.

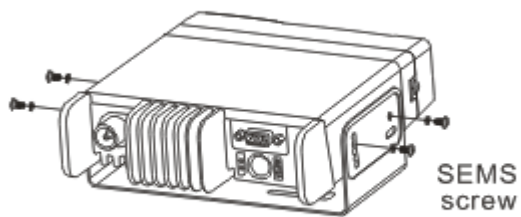

Determine the appropriate angle of the transceiver, using the 3 screw hole positions on the side of the mounting bracket.

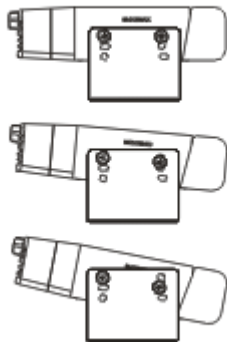

## DC POWER CABLE CONNECTION



Locate the power input connector as close to the transceiver as possible.

### MOBILE OPERATION

The vehicle battery must have a nominal rating of 12 V.

Never connect the transceiver to a 24 V battery. Be sure to use a 12 V vehicle battery that has sufficient current capacity. If the current to the transceiver is insufficient, the display may darken during transmission, or transmit output power may drop excessively.

**1** Route the DC power cable supplied with the transceiver directly to the vehicle's battery terminals using the shortest path from the transceiver.

If using a noise filter, it should be installed with an insulator to prevent it from touching metal on the vehicle.

We recommend you do not use the cigarette lighter socket as some cigarette lighter sockets introduce an unacceptable voltage drop.

The entire length of the cable must be dressed so it is isolated from heat, moisture, and the engine secondary (high voltage) ignition system/ cables.

**2** After the cable is in place, wrap heat-resistant tape around the fuse holder to protect it from moisture and tie down the full run of cable.

**3** To prevent the risk of short circuits, disconnect other wiring from the negative ( - ) battery terminal before connecting the transceiver.

**4** Confirm the correct polarity of the connections, then attach the power cable to the battery terminals; red connects to the positive (+) terminal and black connects to the negative ( - ) terminal.

Use the full length of the cable without cutting off excess even if the cable is longer than required. In particular, never remove the fuse holders from the cable.

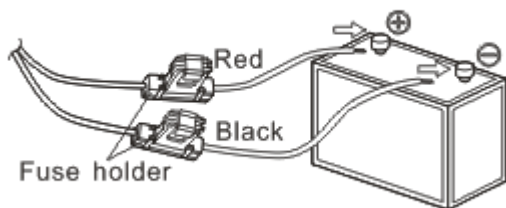

**5** Reconnect any wiring removed from the negative terminal.

**6** Connect the DC power cable to the transceiver's power supply connector.

Press the connectors firmly together until the locking tab clicks

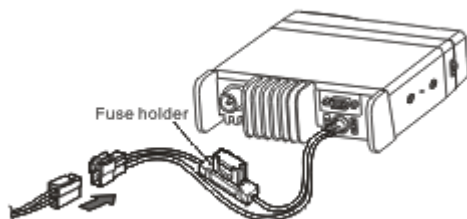

## REPLACING FUSES

If the fuse blows, determine the cause, then correct the problem. After the problem is resolved, replace the fuse.

If newly installed fuses continue to blow, disconnect the power cable and contact your authorized CSI Dealer or an authorized CSI service center for assistance.

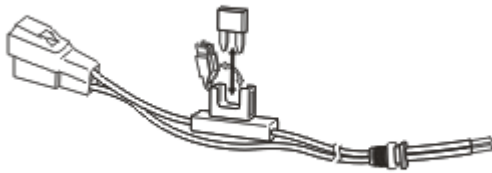

Fuse Location	Fuse Current Rating
Transceiver	15 A
Supplied Accessory DC Power Cable	20 A

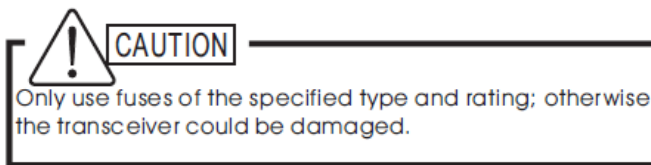

### Note:

If you use the transceiver for a long period when the vehicle battery is not fully charged, or when the engine is OFF, the battery may become discharged, and will not have sufficient reserves to start the vehicle. Avoid using the transceiver under these conditions.

### ANTENNA CONNECTION

Before operating, install an efficient, well-tuned antenna.

The success of your installation will depend largely on the type of antenna and its correct installation. The transceiver can give excellent results if the antenna system and its installation are given careful attention.

Use a 50 $\Omega$  impedance antenna and low-loss coaxial feed

Line that has a characteristic impedance of 50 $\Omega$ , to

match the transceiver input impedance. Coupling the

antenna to the transceiver via feed lines having an impedance other than 50  $\Omega$  reduces the efficiency of the antenna system and can cause interference to nearby broadcast television receivers, radio receivers, and other electronic equipment.

 **CAUTION**

- ◆ Transmitting without first connecting an antenna or other matched load may damage the transceiver. Always connect the antenna to the transceiver before transmitting.
- ◆ All fixed stations should be equipped with a lightning arrester to reduce the risk of fire, electric shock, and transceiver damage.

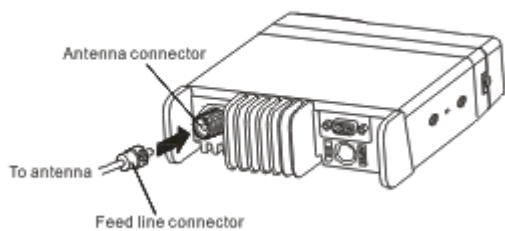

## ACCESSORY CONNECTIONS

### EXTERNAL SPEAKER

If you plan to use an external speaker, choose a speaker with an impedance of 8  $\Omega$ . The external speaker jack accepts a 3.5 mm (1/8") mono (2-conductor) plug.

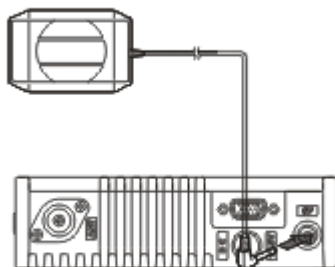

### MICROPHONE

For voice communications, connect a 600  $\Omega$  microphone equipped with an 8-pin modular plug into the modular

socket on the front of the main unit. Press firmly on the plug until the locking tab clicks.

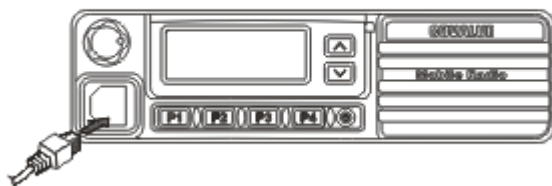

Attach the supplied microphone hanger in an appropriate location using the screws included in the screw set.

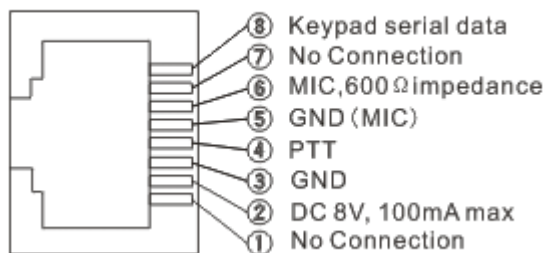
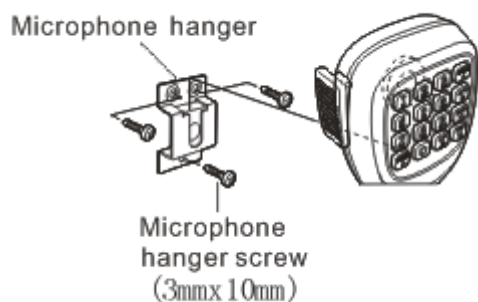

#### PC CONNECTION 1

To utilize the optional PC programming software, you must first connect the transceiver to your PC using an optional Programming Cable (via the rear DB15 connector).

**Note:** Ask your dealer about purchasing a Programming Cable.

#### YOUR FIRST QSO

Are you ready to give your transceiver a quick try? Reading this section should get your voice on the air right away. The instructions below are intended only as a quick guide. If you encounter problems or there is something you would like to know more, read the detailed explanations given later in this manual.



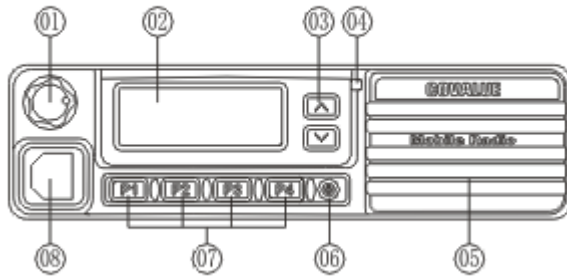

1 Press  (Power) briefly to switch the transceiver power ON.

A power on beep sounds and a Power-on message appears momentarily. The various indicators and the current operating channel alias appear on the LCD.

The transceiver stores the current parameters when it is turned OFF and automatically recalls those parameters the next time you turn the transceiver ON.

2 Turn the **Volume**  control clockwise to increase the volume or reverse.

The transceiver stores the current parameters when it is turned OFF and automatically recalls those parameters the next time you turn the transceiver ON.

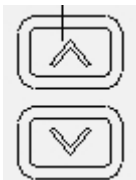
3 Turn the **Up/Down**  control to select a reception channel.

You may further turn the Volume control to adjust the

volume level of the signal.

4 To transmit, hold the microphone approximately 5 cm (2 inches) from your mouth.

5 Press and hold Mic [PTT], then speak in your normal tone of voice.

6 Release Mic [PTT] to receive.

7 Repeat steps 4, 5, and 6 to continue communication.

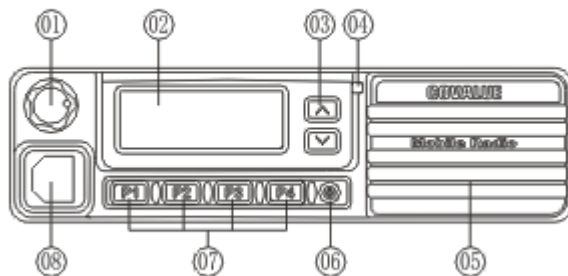

## FRONT PANEL

Note: This section describes only the main functions of the front panel controls. Explanations for functions not described here are provided in the appropriate sections of this instruction manual.



### 1 (Power) switch

Press to switch the transceiver power ON or OFF

2 **MENU key could be programmed to press**  or  by your dealer

Note: To brief, this manual just uses  as the MENU/OK key later

3 Navigation Key could be programmed to turn  or press   or 

 in menu mode

Note: To brief, this manual just uses   as the navigation key in menu later

4 Cancel Key only could be programmed to press , if Menu key enabled.

5 Channel UP/DOWN or Zone UP/DOWN or volume UP/DOWN could be programmed to turn

 or press  

## REAR PANEL

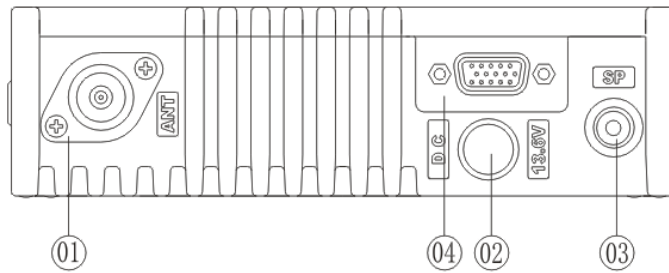

### ① Antenna connector

Connect an external antenna here. When making test transmissions, connect a dummy load in place of the antenna. The antenna system or load should have an impedance of 50  $\Omega$ .

### ② Power Input 13.6 V DC cable

Connect a 13.6 V DC power source here. Use the supplied DC power cable.

### ③ SP (speaker) Jack

If desired, connect an optional external speaker for clearer audio. This jack accepts a 3.5 mm (1/8") mono (2-conductor) plug.

### ④ DB15 Connector

This connector is used for an extension feature, such as GPS, control line etc.

## MICROPHONE



1 PTT(Push-to-Talk) Switch

Press and hold to transmit. Release to receive.

2 D key (Menu/OK key)

3 A key(Cancel Key)

4 B,C(Navigation Key)

5 1,2,3,4,5,6,7,8,9,\*,0,#(Number Key)

### ▲ Make a Call

#### Selecting a Zone





A zone is a group of channels. Your radio supports up to 250 zones, with a maximum of 16 channels per zone.

Use the following procedure to select a zone.

Procedure:

Press the programmed Zone button and proceed to step 2.

OR Follow the procedure below.

1. Press  to enter menu, and press  to Zone and press  to select.
2. The current zone is displayed and indicated by a ✓.
3. Press  to the required zone and press  to select.
4. The display shows <Zone> Selected momentarily.

## ▲ Selecting a Radio Channel, Subscriber ID, or Group ID

**Procedure:**

Once the required zone is displayed, if you have multiple zones in your radio, turn the programmed channel Selector Knob to select the channel, subscriber alias or ID, or group alias or ID.

## ▲ Receiving and Responding to a Radio Call

Once the channel, subscriber ID or group ID is displayed, you can proceed to receive and respond to calls.

To unscramble a privacy-enabled call, your radio must have the same Privacy Key, OR the same Key Value and Key ID (programmed by your dealer), as the transmitting radio (the radio you are receiving the call from)

## ▲ Receiving and Responding to a Group Call

To receive a call from a group of users, your radio must be configured as part of that group.

Procedure:

When you receive a Group Call (while on the Home screen);

1. The green LED lights.
2. The first line of the display shows the caller alias and the RSSI icon. The second line displays the group alias and the Group Call icon (in Digital mode only).

3. Hold the radio vertically 1 to 2 inches(2.5 to 5.0 cm) from your mouth.

If the Channel Free Indication feature is enabled, you will hear a short alert tone the moment the transmitting radio releases the PTT button, indicating the channel is free for you to respond.

4. Press the PTT button to respond to the call and the RED LED turns on.

5. Wait for the Talk Permit Tone to finish (if enabled) and speak clearly into the microphone.

6. Release the PTT button to listen.

7. If there is no voice activity for a predetermined period of time, the call ends.

### ▲ Receiving and Responding to a Private Call

A Private Call is a call from an individual radio to another individual radio.

There are two types of Private Calls. The first type is where a radio presence check is performed prior to setting up the call. The other type sets up the call immediately.

Procedure:

1. The green LED turns on.

2. The first line of the display shows the subscriber alias or ID, and the RSSI icon. The second line displays Private Call and the Private Call icon.

3. Hold the radio vertically 1 to 2 inches(2.5 to 5.0 cm) from your mouth. If the Channel Free Indication feature is enabled, you will hear a short alert tone the moment the transmitting radio releases the PTT button, indicating the channel is free for you to respond.

4. Press the PTT button to respond to the call. The RED LED turns on.

5. Wait for the Talk Permit Tone to finish (if enabled) and speak clearly into the microphone.

6. Release the PTT button to listen.

7. If there is no voice activity for a predetermined period of time, the call ends.

8. You hear a short tone. The display shows Call Ended.

### ▲ Receiving an All Call

An All Call is a call from an individual radio to every radio on the channel. It is used to make important announcements requiring the user's full attention.

Procedure:

When you receive an All Call:

1. A Tone sounds and the Green LED turns on.
2. The first line of the display shows the caller alias and the RSSI icon. The second line displays All Call and the All Call icon.
3. Once the All Call ends, the radio returns to the previous screen before receiving the call.

If the Channel Free Indication feature is enabled, you will hear a short alert tone the moment the transmitting radio releases the PTT button, indicating the channel is now available for use.

You cannot respond to an All Call.

NOTE: the radio stops receiving the All Call if you switch to a different channel while receiving the call.

During an All Call, you will not be able to use any programmed button functions until the call ends.

## ▲ Making a Radio Call

You can select a channel, subscriber ID, or group by using:

- The Channel Selector Knob
- A programmed One Touch Call button
- The Contacts list
- Manual Dial (Via Contacts) —This method is for Private Calls only and is dialed using the keypad.

NOTE: Your radio must have the Privacy feature enabled on the channel to send a privacy-enabled transmission. Only target radios with the same Privacy Key OR the same Key Value and Key ID as your radio will be able to unscramble the transmission.

## ▲ Making a Call with the Channel Selector Knob

### □ Making a Group Call

To make a call to a group of users, your radio must be configured as part of that group.

Procedure:

1. Turn the Channel Selector Knob to select the channel with the active group alias or ID.
2. Hold the radio vertically 1 to 2 inches (2.5 to 5.0cm) from your mouth.

3. Press the PTT button to make the call. The RED LED turns on. The display shows the group alias or ID and the Group Call icon.
4. Wait for the Talk Permit Tone to finish (if enabled) and speak clearly into the microphone.
5. Release the PTT button to listen. When the target radio responds, the LED blinks green. You see the Group Call icon, the group alias or ID, and transmitting radio alias or ID on your display.
6. If the Channel Free Indication feature is enabled, you will hear a short alert tone the moment the target radio releases the PTT button, indicating the channel is free for you to respond. Press the PTT button to respond.

OR

If there is no voice activity for a predetermined period of time, the call ends.

7. Radio returns to the previous screen you were on prior to receiving the call.

You can also make a Group Call via Contacts.

#### □ *Making a Private Call*

Procedure:

1. Turn the Channel Selector Knob to select the channel with the active subscriber alias or ID.
2. Hold the radio vertically 1 to 2 inches (2.5 to 5.0 cm)  
from your mouth.
3. Press the PTT button to make the call. The RED LED turns on. The first line displays the subscriber alias or ID. The second line displays Private Call and the Private Call icon.
4. Wait for the Talk Permit Tone to finish (if enabled) and speak clearly into the microphone.
5. Release the PTT button to listen. When the target radio responds, the Green LED turns on.
6. If the Channel Free Indication feature is enabled, you will hear a short alert tone the moment the target radio releases the PTT button, indicating the channel is free for you to respond. Press the PTT button to respond.

OR

If there is no voice activity for a predetermined period of time, the call ends.

7. You hear a short tone. The display shows Call Ended.

You can also make a Private Call via Contacts or perform a quick alphanumeric search for the required alias via a keypad entry.

## □ *Making a All Call*

This feature allows you to transmit to all users on the channel. Your radio must be programmed to allow you to use this feature.

Procedure:

1. Turn the Channel Selector Knob to select the channel with the active All Call group alias or ID.
2. Hold the radio vertically 1 to 2 inches (2.5 to 5.0 cm) from your mouth.
3. Press the PTT button to make the call. The RED LED turns on. The display shows the All Call group alias or ID and the All Call icon.
4. Wait for the Talk Permit Tone to finish (if enabled) and speak clearly into the microphone.

NOTE: Users on the channel cannot respond to an All Call.

## ▲ **Making a Group or Private Call with the One Touch Call Button**

The One Touch Call feature allows you to make a Group or Private Call to a predefined alias or ID easily. This feature can be assigned to a short or long programmable button press.

You can ONLY have one alias or ID assigned to a One Touch Call button. Your radio can have multiple One Touch Call buttons programmed.

Procedure:

1. Press the programmed One Touch Call button to make a Group or Private Call to the predefined alias or ID.
2. Hold the radio vertically 1 to 2 inches (2.5 to 5.0 cm) from your mouth.
3. Press the PTT button to make the call. The RED LED turns on. The display show the group/subscriber alias or ID, and the Group/Private Call icon.
4. Wait for the Talk Permit Tone to finish (if enabled) and speak clearly into the microphone.
5. Release the PTT button to listen. When the target radio responds, the Green LED turns on.
6. If the Channel Free Indication feature is enabled, you will hear a short alert tone the moment the target radio releases the PTT button, indicating the channel is free for you to respond. Press the PTT button to respond.

OR

If there is no voice activity for a predetermined period of time, the call ends.



## ▲ Talkaround

You can continue to communicate when your repeater is not operating, or when your radio is out of the repeater's range but within talking range of other radios. This is called "talkaround".

Procedure:

Press the programmed Repeater/Talkaround button to toggle between talkaround and repeater modes.

OR

Follow the procedure below.

1. Press **[P4]** to access the menu.
2. Press **[▲]/[▼]** to Utilities and press **[P4]** to select
3. Press **[▲]/[▼]** to Radio Settings and press **[P4]** to select
4. Press **[▲]/[▼]** to Talkaround and press **[P4]** to confirm or press **[P1]** to cancel.
5. After confirmation, the display shows "Talkaround On" OR "Talkaround Off"
6. Press **[P1]** or wait the presetting time to exit the menu state.

The Talkaround setting is retained even after powering down.

## ▲ Monitoring Features (Analog)

### □ *Monitoring a Channel*

Use the Monitor feature to make sure a channel is clear before transmitting by listening for activity on the channel.

Procedure:

1. Press the programmed Monitor button and listen for activity. The monitor icon appears on the display.
2. If you hear activity on the channel the channel is busy. If you hear "white noise" on the channel the channel is free.

## ▲ Advanced Features

### **Radio Check**





If enabled, this feature allows you to determine if another radio is active in a system without disturbing the user of that radio. No audible or visual notification is shown on the target radio.

This feature is only applicable for subscriber aliases or Ids.



## *Sending a Radio Check*



Procedure:

Use the menu.

1. Press  to access the menu.
2. Press  to Contacts and press  to select
3. Press  to the required subscriber alias or ID and press  to select

OR

Press  to Manual Dial and press  to select. Key in the subscriber alias or ID and Press.

4. Press  to Radio Check and press  to select.
5. Wait for acknowledgement
6. If the target radio is active in the system, a tone sounds and the display briefly shows Target Radio Available.

OR

If the target radio is not active in the system, a tone sounds to show Target Radio Not Available.

7. Radio returns to the subscriber alias or ID screen.

## **▲ Remote Monitor**

Use the Remote Monitor feature to turn on the microphone of a target radio(subscriber alias or IDs only). No audible or visual indication is given to the target radio. You can use this feature to monitor, remotely, any audible activity surrounding the target radio.

Your radio must be programmed to allow you to use this feature.







## *Initiating Remote Monitor*

Procedure:





Use the programmed Remote Monitor button.



Use the menu.

1. Press  to access the menu.

2. Press / to Contacts and press  to select
3. Press / to the required subscriber alias or ID and press  to select

OR

Press / to Manual Dial and press  to select. Key in the subscriber alias or ID and Press  to select.

4. Press / to Remote Mon. and press  to select.
5. Wait for acknowledgement

6. The display shows Remote Monitor Successful.

OR

The display shows Remote Monitor Failed.

7. If successful:

The radio starts receiving audio from the monitored radio for a programmed duration.

Once the timer expires, the radio sounds an alert tone. The display shows Remote Monitor Ended.

OR

If unsuccessful:

The radio repeats the attempt until the programmed number of tries expires.

## ▲ Scan Lists







Scan lists are created and assigned to individual channels/groups. Your radio scans for voice activity by cycling through the channel/group sequence specified in the scan list for the current channel/group.

Your radio can support up to 250 scan lists, with a maximum of 16 members in a list. Each scan list supports

a mixture of both analog and digital entries.

You can add, delete, or prioritize channels by editing a scan list.

Procedure:

1. Press  to access the menu.
2. Press / to Scan and press  to select
3. Press / to View/Edit List and press  to select

4. Press / to view each member on the list.

## ▲ Scan

When you start a scan, your radio cycles through the programmed scan list looking for voice activity. The LED blinks Orange while in scan mode. During a dual mode scan, if you are on a digital channel, and your radio locks onto an analog channel, it automatically switches from digital mode to analog mode for the duration of the call. This is also true for the reverse.

There are two ways of initiating scan:

- Main Channel Scan (Manual): Your radio scans all the channels/groups in your scan list. On entering scan, your radio may, depending on the settings, automatically start on the last scanned "active" channel/group or on the channel where scan was initiated.
- Auto Scan(Automatic): Your radio automatically starts scanning when you select a channel/group that has Auto Scan enabled.

### *Starting and Stopping Scan*

Procedure:



Press the programmed Scan button to start or stop Scan.

OR

Follow the procedure below.

1. Use the Channel Selector Knob to select a channel programmed with a scan list.

2. Press  to access the menu.

3. Press / to Scan and press  to select

4. The display shows Turn On if scan is disabled.

OR

The display shows Turn Off if scan is enabled.

5. Press  to select. The LED blinks orange when Scan is enabled. Or the LED turns off when Scan is disabled.

### *Responding to a Transmission During a Scan*

During scanning, your radio stops on a channel/group where activity is detected. The radio stays on that channel for a

programmed time period known as “hang time”

Procedure:

1. Hold the radio vertically 1 to 2 inches (2.5 to 5.0 cm) from your mouth.

If digital channel and the Channel Free Indication feature is enabled, you will hear a short alert tone the moment the transmitting radio releases the PTT button, indicating the channel is free for you to respond.

2. Press the PTT button during hang time. The RED LED turns on.

3. Wait for the Talk Permit Tone to finish if enabled and speak clearly into the microphone.

4. Release the PTT button to listen.

5. If you do not respond within the hang time, the radio returns to scanning other channels/groups.

#### *Deleting a Nuisance Channel*

If a channel continually generates unwanted calls or noise (termed a “nuisance” channel), you can temporarily remove the unwanted channel from the scan list.

This capability does not apply to the channel designated as the Selected Channel.

Procedure:

1. When your radio locks on to an unwanted or nuisance channel, press the programmed Nuisance Channel Delete button until you hear a tone.

2. Release the Nuisance Channel Delete button. The nuisance channel is deleted.

Deleting a “nuisance” channel is only possible through the programmed Nuisance Channel Delete button. This feature is not accessible through the menu.

#### *Restoring a Nuisance Channel*

Procedure:

To restore the deleted nuisance channel, do ONE of the following:

- Turn the radio off and then powering it on again.
- Stop and restart a scan via the programmed Scan button or menu.
- Change the channel via the Channel Selector Knob.

## **▲ Contacts Settings**

Contacts provides “address-book” capabilities on your radio. Each entry corresponds to an alias or ID that you use to initiate a call.

Additionally, each entry, depending on context, associates with ONE of five types of calls: Group Call, Private Call, All Call, PC Call or Dispatch Call.

PC Call and Dispatch Call are data-related. They are only available with the applications. Refer to the data applications documentation for more information.

NOTE: If the Privacy feature is enabled on a channel, you can make privacy-enabled Group Call, Private Call, and All Call on that channel. Only target radios with the same Privacy Key OR the same Key Value and Key ID as your radio will be able to unscramble the transmission.





Each entry within Contacts displays the following information:

- Call Type
- Call Alias
- Call ID

NOTE: You can add, delete, or edit subscriber IDs for the Digital Contacts list.





#### *Making a Group Call from Contacts*

Procedure:

1. Press  to access the menu.
2. Press  to Contacts and press  to select. The entries are alphabetically sorted.
3. Press  to the required group alias or ID.
4. Press the PTT button to make the call.

#### *Making a Private Call from Contacts*

Procedure:

1. Press  to access the menu.
2. Press  to Contacts and press  to select. The entries are alphabetically sorted.
3. Press  to the required subscriber alias or ID.

OR

Press / to Manual Dial and press  to select. Use the keypad to enter a new subscriber alias or ID.

















Press the PTT button to make the call

## ▲ Call Indicator Settings

### *Activating and Deactivating Call Ringers for Private Calls*

You can turn on or off the ringing tones for a received Private Call.

Procedure:

1. Press  to access the menu.
2. Press / to Utilities and press  to select.
3. Press / to Radio Settings and press  to select.
4. Press / to Tone/Alerts and press  to select.
5. Press / to Call Ringers and press  to select.
6. Press / to Private Call and press  to select.
7. The display shows Turn On. Press  to enable Call Ringers for Private Calls. The display shows Private Call Ringer On.











OR

The display shows Turn Off. Press  to disable Call Ringers for Private Calls. The display shows Private Call Ringer Off.

### *Activating and Deactivating Call Ringers for Text Message*

You can turn on or off the ringing tones for a received Text Message.

Procedure:

1. Press  to access the menu.
2. Press / to Utilities and press  to select.
3. Press / to Radio Settings and press  to select.
4. Press / to Tone/Alerts and press  to select.

5. Press / to Call Ringers and press to select.
6. Press / to Text Message and press to select.
7. The current tone is indicated by a ✓.
8. Press / to the preferred tone and press to select. The display shows Tone <Number> Selected and a ✓ appears left of the selected tone.

OR

Press / to Turn Off and press to select. The display shows Text Message Ringer Off and a ✓ appears left or Turn Off.

#### *Assigning Ring Styles (Available after Version 2)*

You can program your radio to sound one of then predefined ringing tones when receiving a Call Alert or a Text Message from a particular contact.

Procedure:

1. Press to access the menu.
2. Press / to Contacts and press to select. The entries are alphabetically sorted.
3. Press / to the required alias or ID and press to select.
4. Press / to Ring Style and press to select.
5. A ✓ indicates the current selected tone.
6. Press / to the required tone and press to select.
7. The display shows Tone <Number> Selected and a ✓ appears left of the selected tone.

OR

Press / to Turn Off and press to select. The display shows Text Message Ringer Off and a ✓ appears left or Turn Off.













#### *Escalating Alarm Tone Volume (Available after Version 2)*

You can program your radio to continually alert you when a radio call remains unanswered. This is done by automatically increasing the alarm tone volume over time. This feature is known as Escalart.

Procedure:

1. Press to access the menu.



2. Press / to Utilities and press  to select.
3. Press / to Radio Settings and press  to select.
4. Press / to Tones/Alerts and press  to select.
5. Press / to Escalert and press  to select.
6. The display shows Turn On. Press  to enable Escalert. The display shows Escalert On.

OR

The display shows Turn Off. Press  to disable Escalert. The display shows Escalert Off.

## ▲ Call Log Features

Your radio keeps track of all recent outgoing, answered, and missed Private Calls. Use the Call log feature to view and manage recent calls.









You can perform the following tasks in each of your call lists:

- Store ID to Contacts
- Delete

### *Viewing Recent Calls*

The lists are Missed, Answered, and Outgoing.

Procedure:

1. Press  to access the menu.
2. Press / to Call Log and press  to select.
3. Press / to preferred list and press  to select.
4. The display shows the most recent entry at the top of the list.
5. Press / to view the list.

Press the PTT button to start a Private Call with the current selected alias or ID.

### *Missed Call Screen*

Whenever a call is missed, your radio displays a missed call message. Select View to view it immediately or View Later to view at a later time.

NOTE: The radio exits the Missed Call screen and sets up a Private Call if you press the PTT button while viewing a missed call number.

1. The display shows Missed Calls, along with the number of calls missed and View?
2. Press  to view the missed call ID. The missed call log list appears on display.









Press  to store or delete the entry.

OR

Press  to view Later and press  to select. You return to the Home screen.

#### *Storing an Alias or ID from the Missed Call List*





Procedure:

1. Press  to access the menu.
2. Press  to Call Log and press  to select.
3. Press  to Missed and press  to select.
4. Press  to the required missed call alias or ID and press  to select.
5. Press  to Store and press  to select.
6. A blinking cursor appears. If needed, key in the alias for that ID and press
7. The display shows Contact Saved.

You can also store an ID without an alias.

#### *Deleting a Call from a Call List*

Procedure:

1. Press  to access the menu.
2. Press  to Call Log and press  to select.
3. Press  to the required list and press  to select.

4. Press / to the required alias or ID and press to select.
5. Press / to Delete Entry? And press to select. The display show Entry Deleted.

OR

6. Press / to No to return to the previous screen.

When you select a call list and it contains no entries, the display shows List Empty, and sounds a low tone if Keypad Tones are turned on.

## ▲ Call Alert Operation

Call Alert paging enables you to alert a specific radio user to call you back when they are able to do so.

This feature is applicable for subscriber aliases or IDs only and is accessible through the menu via Contacts or manual dial.

### *Receiving and Acknowledging a Call Alert.*

Procedure:

1. You hear a repetitive tone.
2. Press and release the PTT button to acknowledge the alert.

OR

Press to select Ignore and to exit the Call Alert.

Making a Call Alert from the Contacts List

1. Press to access the menu.
2. Press / to Contacts and press to select.
3. Press / to the required subscriber alias or ID and press to select.

OR

Press / to Manual Dial and press to select. A blinking cursor appears.

Enter the subscriber ID you want to page and press .

4. Press / to Call Alert and press to select.
5. The display shows Call Alert: <Subscriber Alias or ID>, indicating that the Call Alert has been sent.

6. The RED LED turns on when your radio is sending the Call Alert.

7. If the Call Alert acknowledgement is received, a tone sounds and the display shows Call Alert Successful.

OR

If the Call Alert acknowledgement is not received, a tone sounds and the display shows Call Alert Failed.

## ▲ Emergency Operation

An Emergency Alarm is used to indicate a critical situation. You are able to initiate an Emergency at any time on any screen display even when there is activity on the current channel.

Your radio supports 3 Emergency Alarms:

- Emergency Alarm
- Emergency Alarm with Call
- Emergency Alarm with Voice to Follow

In addition, each alarm has the following types:

- Regular —Radio transmits an alarm signal and shows audio and/or visual indicators.
- Silent - Radio transmits an alarm signal without any audio or visual indicators. There will be no response (call) from the target radio until you press the PTT button to initiate the call.
- Silent with Voice —Radio transmits an alarm signal and is able to receive an incoming call without any audio or visual indicators until you press the PTT button to initiate or respond to the call.

Only ONE of the Emergency Alarms above can be assigned to the programmed Emergency button.

### *Receiving an Emergency Alarm*

Procedure:

1. When receiving an Emergency Alarm, the display shows the Emergency icon, the number of alarms received, and Alarm Rcvd, which alternates with alias ID of the sender.
2. A tone sounds.
3. If enabled, your radio automatically acknowledges the Emergency Alarm.

When your radio receives an Emergency Alarm, it displays the Emergency Alarm received indications until acknowledgement is sent and you exit the Emergency mode.

You will not be able to receive any other indications or displays for any other calls until you exit the Emergency Alarm received screen.

NOTE: Short press, then long press the programmed Emergency button to clear the Emergency Alarm received indications and exit Emergency mode.

### *Responding to an Emergency Alarm*

Procedure:

When receiving an Emergency Alarm:

1. Press any button to stop all Emergency Alarm received indications.
2. Hold the radio vertically 1 to 2 inches (2.5 to 5.0cm) from your mouth.

If the Channel Free Indication feature is enabled, you will hear a short alert tone the moment the transmitting radio releases the PTT button, indicating the channel is now available for use.

3. Press PTT button to initiate a call with the emergency initiating radio. The RED LED turns on. Your radio remains in the Emergency mode.
4. Wait for the Talk Permit Tone to finish (if enabled) and speak clearly into the microphone.
5. Release the PTT button to listen. When the emergency initiating radio responds, you see the Group Call icon, the group ID, and transmitting radio ID on your display.
6. Once your call ends, short press , then long press the programmed Emergency button to clear the Emergency Call received indications and exit Emergency mode.
7. The radio returns to the Home screen.

### *Sending an Emergency Alarm*

This feature allows you to send an Emergency Alarm, a non-voice signal, which triggers an alert indication on another radio.

Procedure:

1. Press the programmed Emergency button.
2. The display shows "Sending Alarm", which alternates with your radio ID. The RED LED turns on and the Emergency icon appears on the Home screen display.
3. When an Emergency Alarm acknowledgment is received, the Emergency tone sounds and the GREEN LED turns on. The display shows Emergency Alarm Successful.

OR

If your radio does not receive an Emergency Alarm acknowledgment, and after all retries have been exhausted, a tone sounds and the display shows Emergency Alarm Failed.

4. Radio exits the Emergency Alarm mode and returns to the Home screen.

If your radio is set to Silent, it will not display any audio or visual indicators during Emergency mode.

#### *Sending an Emergency Alarm with Call*

This feature allows you to send an Emergency Alarm to another radio. Upon acknowledgment, both radios can communicate over a programmed Emergency channel.

Procedure:

1. Press the programmed Emergency button.
2. The display shows "Sending Alarm", which alternates with your radio ID. The RED LED turns on and the Emergency icon appears on the Home screen display.
3. When an Emergency Alarm acknowledgment is received, the Emergency tone sounds and the GREEN LED turns on. The display shows "Emergency Alarm Successful".
4. Hold the radio vertically 1 to 2 inches(2.5 to 5.0cm) from your mouth.
5. Press PTT button to make the call. The RED LED lights turns on and the group icon appears on the display.
6. Wait for the Talk Permit Tone to finish if enabled and speak clearly into the microphone.
7. Release the PTT button to listen.
8. If the Channel Free Indication feature is enabled, you will hear a short alert tone the moment the target radio releases the PTT button, indicating the channel is free for you to respond

OR

Long press the programmed Emergency button to exit the Emergency mode.

9. The radio returns to the Home screen.

If your radio is set to Silent, it will not display any audio or visual indicators during Emergency mode, or receive a response (Call) from the target radio until you press the PTT button to initiate the call.

If your radio is set to Silent with Voice, it will not display any audio or visual indicators during Emergency mode, or when you are receiving a call from the target radio. The indicators will only appear once you press the PTT button to initiate or respond to the call.

## *Sending an Emergency Alarm with Voice to Follow*

This feature allows you to send an Emergency Alarm to another radio. Upon acknowledgment, your radio's microphone is automatically activated, allowing you to communicate with the other radio without pressing the PTT button.

This activated microphone state is also known as "hot mic". If you press the PTT button during the programmed

hot mic transmission period, the radio ignores the PTT press and remains in Emergency mode.

Procedure:

1. Press the programmed Emergency button.
2. The display shows Sending Alarm. The RED LED turns on and the Emergency icon is displayed.
3. Once the display shows Emergency Alarm successful, speak clearly into the microphone. When hot mic has been enabled, the radio automatically transmits without a PTT press until the hot mic duration expires.
4. While transmitting, the RED LED turns on and the Emergency icon appears on the display.
5. Once the hot mic duration expires, the radio automatically stops transmitting. To transmit again, press the PTT button.

If your radio is set to Silent, it will not display any audio or visual indicators during Emergency mode, or receive any response from the target radio until the programmed hot mic transmission period is over, and you press the PTT button.

If your radio is set to Silent with Voice, it will not display

any audio or visual indicators during Emergency mode when you are making the call with hot mic or when the target radio responds after the programmed hot mic transmission period is over. The indicators will only appear when you press the PTT button.

NOTE: If the Emergency Alarm request fails, the radio returns to the Home screen.

## *Exiting an Emergency Mode*

Your radio exits Emergency mode when one of the following occurs:



- Emergency Alarm acknowledgement is received. (for Emergency Alarm only), OR
- All retries to send the alarm have been exhausted, OR
- The programmed Emergency button is long pressed.

NOTE: If your radio is powered off, it exits the Emergency mode. The radio will not reinitiate the Emergency mode automatically when it is turned on again.

## ▲ Text Message Features





Your radio is able to receive data, for example a text message, from another radio or an e-mail application.

The maximum length of characters for a text message, including the subject line is 138

NOTE: press  at any time to return to the previous screen or long press  to return to the Home screen.

### *Writing and Sending a Text Message*

Procedure:



1. Press  to access the menu.
2. Press  to Messages and press  to select.
3. Press  to Write and press  to select.
4. A blinking cursor appears.

Use the keypad to type your message.

Press  to move one space to the left.

Press  or the # key to move one space to the right.

Press the \*DEL key to delete any unwanted characters.

5. Press  once message is composed..
6. Press  to the required alias or ID and press  to select.

OR

Press  to Manual Dial and press  to select.

Key in the subscriber ID and press  .

7. The display shows Text Message: <Subscriber/Group Alias or ID>, confirming your message is being sent.
8. If the message is sent, a tone sounds and the display shows Message Sent.

OR

If the message is not sent, a low tone sounds and the display shows Message Send Failed.









If the message fails to send, the radio returns you to the Resend option screen.

## *Sending a Quick Text Message*

Procedure:

Your radio supports a maximum of ten (10) Quick Text messages as programmed by your dealer.

While Quick Text messages are predefined, you can edit each message before sending it.



1. Press  to access the menu.
2. Press  to Messages and press  to select.
3. Press  to Quick Text and press  to select.
4. Press  to the required Quick Text and press  to select.
5. A blinking cursor appears.

Use the keypad to edit the message, if required.

Press  to move one space to the left.

Press  or the # key to move one space to the right.

Press the \*DEL key to delete any unwanted characters.

6. Press  once message is composed.
7. Press  to the required alias or ID and press  to select.

OR

Press  to Manual Dial and press  to select.

Key in the subscriber ID and press  .

8. The display shows Text Message: <Subscriber/Group Alias or ID>, confirming your message is being sent.
9. If the message is sent, a tone sounds and the display shows Message Sent.

OR

If the message is not sent, a low tone sounds and the display shows Message Send Failed.

If the message fails to send, the radio returns you to

the Resend option screen.

### *Sending a Quick Text Message with the One Touch Call Button*

Procedure:

1. Press the programmed One Touch Call button to send a predefined Quick Text message to a predefined alias or ID.
2. The display shows Text Message: <Subscriber/Group Alias or ID>, confirming your message is being sent.
3. If the message is sent, a tone sounds and the display shows Message Sent.

OR

If the message is not sent, a low tone sounds and the display shows Message Send Failed.

If the message fails to send, the radio returns you to the Resend option screen.

### *Managing Fail-to-Send Text Messages*

You can select one of the following options while at the Resend Option screen:◦

- Resend
- Forward
- Edit

### *Resending a Text Messages*

Procedure:

1. Press  to resend the same message to the same subscriber/group alias or ID.
2. If the message is sent, a tone sounds and the display shows Message Sent.













OR

If the message is not sent, a low tone sounds and the display shows Message Send Failed.

### *Forwarding a Text Message*

Select Forward to send the message to another subscriber/group alias or ID.

Procedure:

1. Press  to access the menu.
2. Press  to Messages and press  to select.
3. Press  to Inbox and press  to select.
4. Press  to the required Message and press  to select.
5. Press  and press  to Forward and press  to select.
6. Press  to the required alias or ID and press  to select.

OR

Press  to Manual Dial and press  to select.

Key in the subscriber ID and press.

7. The display shows Text Message: <Subscriber/Group Alias or ID>, confirming your message is being sent.
8. If the message is sent, a tone sounds and the display shows Message Sent.

OR

If the message is not sent, a low tone sounds and the display shows Message Send Failed.







### *Managing Sent Text Messages*

Once a message is sent to another radio, it is saved in Sent Items. The most recent sent text message is always added to the top of the Sent Items list.◦

The Sent Items folder is capable of storing a maximum of thirty last sent messages. When the folder is full, the next sent text message automatically replaces the oldest text message in the folder.

### *Viewing a Sent Text Message*

Procedure:

1. Press  to access the menu.
2. Press  to Messages and press  to select.
3. Press  to Sent Items and press  to select.
4. Press  to the required Message and press  to select.

## *Sending a Sent Text Message*

You can select one of the following options while viewing a sent text message:

- Resend
- Forward
- Edit
- Delete

## *Deleting all Sent Text Messages from Sent Items*

Procedure:

1. Press **P4** to access the menu.
2. Press **▲/▼** to Messages and press **P4** to select.
3. Press **▲/▼** to Sent Items and press **P4** to select.
4. Press **▲/▼** to Delete All and press **P4** to select.
5. At Delete Message?, press **P4** to select Yes. The display shows Sent Items Cleared.

OR

At Delete Message? , Press **▲/▼** to No and press **P4** to return to the previous screen.

When you select Sent Items and it contains no text messages, the display shows List Empty.

## *Receiving a Text Message*





When your radio receives a message, the display shows the alias or ID of the sender and the message icon at the far left of the screen.

You can select one of the following options when receiving a text message:

- Read?
- Read Later
- Delete

## *Reading a Text Message*

Procedure:

1. Press / to Read? And press  to select.
2. Press  to Reply, forward, or delete the text message.

OR

Press / to access the Read Later or Delete option screen:

- Select Read Later to return to the screen you were on prior to receiving the text message.
- Select Delete to delete the text message.

### *Managing Received Text Messages*

Use the Inbox to manage your text messages. The Inbox is capable of storing a maximum of 50 messages.

Your radio supports the following options for text messages:









- Reply
- Forward
- Delete
- Delete All

Text messages in the Inbox are sorted according to the most recently received.

NOTE:

### *Viewing a Text Message from the Inbox*

Procedure:

1. Press  to Messages and press  to select.
2. Press / to Inbox and press  to select.
3. Press / to view the messages.
4. Press  to select the current message, and press  again to reply, forward, or delete that message.

Unread messages are indicated with an exclamation mark(!).

### *Viewing a Text Message from the Inbox*

Procedure:

1. Press / to Messages and press to select.
2. Press / to Inbox and press to select.
3. Press / to the required message and press to select .
4. Press once more to access the sub-menu.
5. Press / to Reply and press to select.
6. Press / to Write and press to select.

A blinking cursor appears. Use the keypad to write your message.

OR

Press / to Quick Text and press to select.

A blinking cursor appears. Use the keypad to edit your message, if required.

7. Press once message is composed.
8. The display shows Text Message: <Subscriber/Group Alias or ID>, confirming your message is being sent.











#### *Deleting a Text Message from the Inbox*

Procedure:

1. Press / to Messages and press to select.
2. Press / to Inbox and press to select.
3. Press / to the required message and press to select .
4. Press once more to access the sub-menu.
5. Press / to Delete and press to select.
6. At Delete Message?, Press / to Yes and press to select.
7. The Display shows message Deleted.
8. The screen returns to the Inbox.

## □ *Deleting All Text Messages from the Inbox*

Procedure:

1. Press / to Messages and press  to select.
2. Press / to Inbox and press  to select.
3. Press / to Delete All and press  to select .
4. At Delete Message?, Press / to Yes and press  
to select.
5. The Display shows Inbox Cleared.

When you select the Inbox and it contains no text messages, the display shows List Empty.

## ▲ **Privacy**

If enabled, this feature helps to prevent eavesdropping by unauthorized users on a channel by the use of a software based scrambling solution. The signaling and user identification portions of a transmission are not scrambled.

Your radio must have privacy enabled on the channel to send a privacy-enabled transmission, although this is not a necessary requirement for receiving a transmission. While on a privacy-enabled channel, the radio is still able to receive clear (unscrambled) transmissions.

Your radio supports two types of privacy:









- Basic Privacy
- Enhanced Privacy

Only ONE of the privacy types above can be assigned to the radio.

To unscramble a privacy-enabled call or data transmission, your radio must be programmed to have the same Privacy Key (for Basic Privacy), OR the same Key Value and Key ID (for Enhanced Privacy) as the transmitting radio.

If your radio receives a scrambled call that is of a different Privacy Key, OR a different Key Value and Key ID, you will either hear a garbled transmission (Basic Privacy) or nothing at all(Enhanced Privacy).

Procedure:

1. Press / to Utilities and press  to select.
2. Press / to Radio Settings and press  to select.
3. Press / to Privacy and press  to select .

4. The display shows Privacy and Turn On. press **P4** to enable privacy. The display shows the secure icon and Privacy On.

OR

The display shows Privacy and Turn Off. press **P4** to disable privacy. The display shows the unsecure icon and Privacy Off.

### *Dual Tone Multi Frequency (DTMF) (Analog)*

The Dual Tone Multi Frequency (DTMF) feature allows the radio to operate in a radio system with an interface to telephone systems.

Procedure:

To initiate a DTMF call.

1. Press and hold PTT button.
2. Enter the desired number.

You can turn off the DTMF tone by disabling all radio tones and alerts.◦

## ▲ Security

You can enable or disable any radio in the system. For example, you might want to disable a stolen radio, to prevent the thief from using it, and enable that radio, when it is recovered.

NOTE: Performing Radio Disable and Enable is limited to radios with these functions enabled. Check with your dealer or system administrator for more information.

### *Radio Disable*

Procedure:

1. Press **▲/▼** to Contacts and press **P4** to select. The entries are alphabetically sorted.
2. Press **▲/▼** to the required alias or ID and press **P4** to select.

OR

Press **▲/▼** to Manual Dial and press **P4** to select .

Key in the subscriber alias or ID and press .

3. Press **▲/▼** to Radio Disable and press **P4** to select.



4. The display shows Radio Disable: <Subscriber Alias or ID> and the LED lights up RED.

5. Wait for acknowledgment.

6. If successful, a tone sounds and the display shows Radio Disable Successful.



OR

If not successful, a tone sounds and the display shows Radio Disable Failed.

#### *Radio Enable*

Procedure:



1. Press / to Contacts and press  to select. The entries are alphabetically sorted.

2. Press / to the required alias or ID and press  to select.

OR

Press / to Manual Dial and press  to select .

Key in the subscriber alias or ID and press .

3. Press / to Radio Enable and press  to select.

4. The display shows Radio Enable: <Subscriber Alias or ID> and the LED lights up RED.

5. Wait for acknowledgment.

6. If successful, a tone sounds and the display shows ◦

Radio Enable Successful.

OR

If not successful, a tone sounds and the display shows











Radio Enable Failed.

#### **▲ Utilities**

##### *Locking and Unlocking the Keypad*

You can lock your radio's keypad to avoid inadvertent key entry.













Procedure:

1. Press / to Utilities and press  to select.
2. Press / to Radio Settings and press  to select.
3. Press / to Keypad Lock and press  to select.
4. The display shows Keypad Locked and returns to the Home screen.
5. To unlock the keypad, press  followed by \*.
6. The display shows Keypad Unlocked and returns to the Home screen.

### *Turning Keypad Tones On or Off*

You can enable and disable keypad tones if needed.

Procedure:

1. Press / to Utilities and press  to select.
2. Press / to Radio Settings and press  to select.
3. Press / to Tones/Alerts and press  to select.
4. Press / to Keypad Tones and press  to select.
5. The display shows Turn On. Press  to enable keypad tones. The display shows Keypad Tone On.

OR

The display shows Turn Off. Press  to disable keypad tones. The display shows Keypad Tone Off.

### *Setting the Squelch Level (Analog)*

You can adjust your radio's squelch level to filter out unwanted calls with low signal strength or channels that have a higher than normal background noise.

Settings: Normal is the default. Tight filters out (unwanted) calls and/or background noise. However, calls from remote locations may also be filtered out.

Procedure:

Press the programmed Squelch button to toggle squelch level between normal and tight.

OR

1. Press / to Utilities and press  to select.

2. Press / to Radio Settings and press  to select.

3. Press / to Squelch and press  to select.

4. Choose either Tight or Normal and press  to select.

Screen returns to the previous menu.

### *Setting the Power Level*

You can customize your radio's power setting to high or low for each channel.

Settings: High enables communication with radios located at a considerable distance from you. Low enables communication with radios in closer proximity.



Procedure:

Press the programmed Power Level button to toggle transmit power level between high and low.

OR

1. Press / to Utilities and press  to select.

2. Press / to Radio Settings and press  to select.

3. Press / to Power and press  to select.

4. Change your current setting as prompted on the

display.

5. Press  to select a new power level.

Screen returns to the previous menu.

### *Turning the Voice Operating Transmission (VOX) Feature On or Off*

This feature allows you to initiate a hands-free voice activated call on a programmed channel. The radio automatically transmits, for a programmed period, whenever the microphone on the VOX-capable accessory detects voice.

Pressing the PTT button during radio operation will disable VOX. To re-enable VOX, do one of the following:











- Turn the radio off and powering it on again, OR
- Change the channel via the Channel Selector Knob, OR
- Follow the procedure below.

NOTE: Turning this feature on or off is limited to radios with this function enabled. Check with your dealer or system administrator for more information.

Procedure:

Press the programmed VOX button to toggle the feature on or off.

OR

1. Press / to Utilities and press  to select.
2. Press / to Radio Settings and press  to select.
3. Press / to VOX and press  to select.
4. The display shows VOX On. Press  to disable VOX. The display shows VOX Off.

OR

The display shows VOX Off. Press  to enable VOX. The display shows VOX On.











#### *Controlling the Display Backlight*

You can enable or disable the radio's display backlight as needed. The setting also affects keypad backlighting accordingly.

Procedure:

Press the programmed Backlight button to toggle the backlight settings.

OR

1. Press / to Utilities and press  to select.
2. Press / to Radio Settings and press  to select.
3. Press / to Backlight and press  to select.
4. The display shows Auto On. Press  to enable the display backlight. The display shows Backlight Auto On.

OR

The display shows Turn Off. Press  to disable the display backlight. The display shows Backlight Turn Off.

The display backlight and keypad backlighting are automatically turned off if the LED indicator is disabled.













#### *Turning the Radio Tones/Alerts On or Off*

You can enable or disable the radio tones and alerts(except for the incoming Emergency alert tone) if needed.

Procedure:

Press the programmed All Tones/Alerts button to toggle all tones on or off.

OR

1. Press / to Utilities and press  to select.
2. Press / to Radio Settings and press  to select.
3. Press / to Tones/Alerts and press  to select.◦
4. Press / to All Tones and press  to select.
5. The display shows Turn On. Press  to enable all tones and alerts. The display shows All Tones On.













OR

The display shows Turn Off. Press  to disable all tones and alerts. The display shows All Tones Off.

#### *Turning the Talk Permit Tone On or Off*

You can enable or disable the Talk Permit Tone if needed.

Procedure:

1. Press / to Utilities and press  to select.
2. Press / to Radio Settings and press  to select.
3. Press / to Tones/Alerts and press  to select.
4. Press / to Talk Permit and press  to select.
5. The display shows Turn On. Press  to enable the Talk Permit Tone. The display shows Talk Permit Tone On.











OR

The display shows Turn Off. Press  to disable the Talk Permit Tone. The display shows Talk Permit Tone Off.

#### *Turning the LED Indicator On or Off*

You can enable or disable the LED Indicator if needed.

Procedure:

1. Press / to Utilities and press  to select.
2. Press / to Radio Settings and press  to select.
3. Press / to LED Indicator and press  to select.
4. The display shows Turn On. Press  to enable the LED Indicator. The display shows All LEDs On.

OR











The display shows Turn Off. Press  to disable the LED Indicator. The display shows All LEDs Off.

The display backlight, buttons, and keypad backlighting are automatically turned off if the LED indicator is disabled.

### *Turning the Introduction Screen On or Off*

You can enable or disable the Introduction Screen if needed.

Procedure:

1. Press / to Utilities and press  to select.
2. Press / to Radio Settings and press  to select.
3. Press / to Intro Screen and press  to select.
4. The display shows Turn On. Press  to enable the Introduction Screen. The display shows Intro Screen On.

OR

The display shows Turn Off. Press  to disable the Introduction Screen. The display shows Intro Screen Off.

The display backlight, buttons, and keypad backlighting are automatically turned off if the LED indicator is disabled.

### *Accessing General Radio Information*

Your radio contains information on the following:

- Radio ID
- Software Version
- Codeplug Version

Procedure:

1. Press / to Utilities and press  to select.

2. Press / to Radio Info and press to select.

3. Press / to My Number or Firmware Ver. Or CP Ver. and press to select.

4. The display shows the radio ID or the current firmware version or codeplug version.

## ■ Troubleshooting

No.	Problems	Solutions
1	<p>The transceiver will not power up after connecting a 12VDC power supply and pressing the  (Power) switch. Nothing appears on the display.</p>	<ul style="list-style-type: none"> <li>·The power cable was connected backwards.</li> <li>·Connect the supplied DC power cable correctly: Red→(+);Black→(-).</li> <li>·One or more of the power cable fuses are open.</li> <li>·Look for the cause of the blown fuse(s).After inspecting and correcting any problems, install a new fuse(s) with the same ratings.</li> </ul>
2	<p>The display is too dim,even though you selected a high brightness level.</p>	<ul style="list-style-type: none"> <li>·The supply voltage is too low.</li> <li>·The supply voltage requirement is 12VDC ±15% (11.7 V to 15.8 V DC).If the input voltage is outside this range,adjust your regulated power supply and/or check all power cable connections.</li> </ul>
3	<p>Cannot talk to or hear other members in your group.</p>	<ul style="list-style-type: none"> <li>·Digital: Make sure the CC, ID Time Slot is set right.</li> <li>·Analog: Make sure the signaling is set right.</li> <li>·Beyond the radio efficient communication range.</li> </ul>

4	Other voices from non-group members are heard on the channel.	Analog: Change the CTCSS/DCS tone, and make sure change the tone on all radios in your group
5	Communication range is too small.	<ul style="list-style-type: none"> <li>·Make sure the antenna is well connected.</li> <li>·Make sure the antenna is the originally supplied one.</li> <li>·Ask your local dealer to adjust the squelch level.</li> </ul>
6	You cannot transmit even though you press Mic <b>[PTT]</b> .	<ul style="list-style-type: none"> <li>• The microphone plug was not inserted completely into the front panel connector.</li> <li>• Switch OFF the power, then insert the microphone plug until the locking tab clicks in place.</li> <li>• You selected a transmit offset that places the transmit frequency outside the allowable transmit frequency range.</li> </ul>
7	Noise is too loud.	<ul style="list-style-type: none"> <li>• Beyond the efficient communication range.</li> </ul>



## NOTICES TO THE USER

- ◆ Government law prohibits the operation of unlicensed transmitters within the territories under government control.
- ◆ Illegal operation is punishable by fine and/or imprisonment.
- ◆ Refer service to qualified technicians only.

**SAFETY:** It is important that the operator is aware of, and understands, hazards common to the operation of any transceiver.



- ◆ **EXPLOSIVE ATMOSPHERES (GASES, DUST, FUMES, etc.)**  
Turn OFF your transceiver while taking on fuel or while parked in gasoline service stations. Do not carry spare fuel containers in the trunk of your vehicle if your transceiver is mounted in the trunk area.
- ◆ **INJURY FROM RADIO FREQUENCY TRANSMISSIONS**  
Do not operate your transceiver when somebody is either standing near to or touching the antenna, to avoid the possibility of radio frequency burns or related physical injury.
- ◆ **DYNAMITE BLASTING CAPS**  
Operating the transceiver within 500 feet (150 m) of dynamite blasting caps may cause them to explode. Turn OFF your transceiver when in an area where blasting is in progress, or where "TURN OFF TWO-WAY RADIO" signs have been posted. If you are transporting blasting caps in your vehicle, make sure they are carried in a closed metal box with a padded interior. Do not transmit while the caps are being placed into or removed from the container.

**One or more of the following statements may be applicable:**

### FCC WARNING

This equipment generates or uses radio frequency energy. Changes or modifications to this equipment may cause harmful interference unless the modifications are expressly approved in the instruction manual. The user could lose the authority to operate this equipment if an unauthorized change or modification is made.

### INFORMATION TO THE DIGITAL DEVICE USER REQUIRED BY THE FCC

This equipment has been tested and found to comply with the limits for a Class B digital device, pursuant to Part 15 of the FCC Rules. These limits are designed to provide reasonable protection against harmful interference in a residential installation.

This equipment generates, uses and can generate radio frequency energy and, if not installed and used in accordance with the instructions, may cause harmful interference to radio communications. However, there is no guarantee that the interference will not occur in a particular installation. If this equipment does cause harmful interference to radio or television reception, which can be determined by turning the equipment off and on, the user is encouraged to try to correct the interference by one or more of the following measures:

- Reorient or relocate the receiving antenna.
- Increase the separation between the equipment and receiver.
- Connect the equipment to an outlet on a circuit different from that to which the receiver is connected.
- Consult the dealer for technical assistance.

## PRECAUTIONS

Observe the following precautions to prevent fire, personal injury, and transceiver damage.

- Do not attempt to configure the transceiver while driving; it is too dangerous.
- Do not disassemble or modify the transceiver for any reason.
- Do not expose the transceiver to long periods of direct sunlight, nor place it near heating appliances.
- If an abnormal odor or smoke is detected coming from the transceiver, switch the transceiver power off immediately, and contact your **COVALUE** dealer.
- Use of the transceiver while you are driving may be against traffic laws. Please check and observe the vehicle regulations in your area.
- Do not use options not specified by **COVALUE**.



- ◆ The transceiver operates in 12 V negative ground systems only! Check the battery polarity and voltage of the vehicle before installing the transceiver.
- ◆ Use only the supplied DC power cable or a **COVALUE** optional DC power cable.
- ◆ Do not cut and/or remove the fuse holder on the DC power cable.



For passenger safety, install the transceiver securely using the supplied mounting bracket and screw set so the transceiver will not break loose in the event of a collision.

Antenna substitution: Do not substitute any antenna for the one supplied or recommended by the manufacturer or radiodealer.

You may be exposing person or persons to excess radio frequency radiation.

You may contact your radio dealer or the manufacturer for further instructions.



Maintain a separation distance from the antenna to person(s) of at least **80 cm, 50% duty Cycle.**

This transmitter is authorized to operate with a maximum duty factor of 50, in typical push-to-talk mode, for satisfying FCC RF exposure compliance requirements.

To comply with RF exposure requirements, a minimum separation distance of 80cm and with a 2dB cable loss is required between antenna and all public persons.

**IC RSS warning**

The term "IC:" before the certification/registration number only signifies that the Industry Canada technical specifications were met.

Le terme "IC:" devant le numéro de certification / enregistrement signifie seulement que les spécifications techniques d'Industrie Canada ont été respectées.

Nominal antenna port impedance / Impédance nominale antenne Port 50  $\Omega$ .

**IC radiation exposure statement**

This radio is intended for use in occupational/controlled applications where users have been made aware of the potential for exposure and can exercise control over their exposure. This radio device is not authorised for general population, consumer or similar use. This transmitter must not be co-located or operating in conjunction with any other antenna or transmitter.

The antenna should be installed and operated with a minimum distance of 0.8m to any person.

Cette radio a été conçue pour un usage professionnel dans un environnement contrôlé, où les utilisateurs sont pleinement conscients du danger potentiel de l'exposition à laquelle ils sont soumis et peuvent exercer un contrôle sur cette exposition. Ce dispositif radio N'EST PAS autorisé pour l'ensemble de la population, les consommateurs en général, ni pour une utilisation similaire. Cet émetteur ne doit pas être co-localisés ou fonctionner en conjonction avec une autre antenne ou émetteur.

L'antenne doit être installé et utilisé avec un minimum de 0.8m de distance de toute personne.