

# **Instruction Manual**

## **CU780-2**

### **FM Portable Radio**

Thank you for purchasing a **COVALUE** two-way radio. This simple to use radio adopts the latest advances in technology, providing reliable communication in today's demanding communication environment.

#### **Notice to the User:**

- Please read this instruction manual before operating this radio.
- It's prohibited to use the radio or charge it at any area with a potentially explosive atmosphere (where the air contains gas, dust and smog, etc.), as well as while taking on fuel, or while parking at a gasoline service station; or any area where radio communication is prohibited (such as a hospital or a airport.)
- It's prohibited to operate the radio without permission in areas where the government laws prohibit radio communication.
- Please don't expose the radio to direct sunlight for a long time; don't place the radio near any heating devices, either.
- Please don't put the radio in extremely dusty, moist humid areas or unstable surfaces.
- Only qualified personal, with proper tools and instruments are allowed to service and repair the radios, do not disassemble the radio by yourself to avoid damages.

#### **FCC & IC Warning:**

Operation is subject to the following two conditions:

(1) this device may not cause interference, and (2) this device must accept any interference, including interference that may cause undesired operation of the device.

Any Changes or modifications not expressly approved by the party responsible for compliance could void the user's authority to operate the equipment.

#### **FCC Radiation Exposure Statement:**

This equipment complies with FCC radiation exposure limits set forth for an uncontrolled environment.

This transmitter must not be co-located or operating in conjunction with any other antenna or transmitter.

Under Industry Canada regulations, this radio transmitter may only operate using an antenna of a type and maximum (or lesser) gain approved for the transmitter by Industry Canada. To reduce potential radio interference to other users, the antenna type and its gain should be so chosen that , the equivalent isotropically radiated power (e.i.r.p.) is not more than that necessary for successful communication.

# CONTENTS

- Unpacking and Checking the Equipment -----
  - Supplied Accessories-----
- Preparation -----
  - Charging the Battery
  - Installing/Removing the Battery Pack
  - Installing the Antenna
  - Installing the Optional Speaker/Microphone
  - Installing/Removing the Belt Clip
- Radio Overview
- Basic Operations
- Programmable Button Function
- VOX (Voice Operated Transmission)
- Radio Setting
  - TOT (Time-out Timer)
  - Battery Save
  - Low Power Warning
  - CTCSS/DCS
- User Template
  - RX Squelch Mode
  - DTMF
  - 5-Tone Signaling
  - 2-Tone Signaling
  - MDC Signaling
- Troubleshooting
- Major Specifications
- Settings

## ■ Unpacking and Checking the Equipment

Unpack the radio carefully. We recommend that you identify the items listed in the following table before discarding the packing material. If any items are missing or have been damaged during shipment, please contact the carrier or the dealer immediately.

### Supplied Accessories

Item	Quantity
Antenna	1
Battery	1
Hand Strap	1
Charger	1
Power Adapter	1
Belt Clip	1
Instruction Manual	1

### 1、 Open Package Inspection

First, take the radio out of the package box carefully. We recommend checking the radio and the supplied accessories in the following table carefully. If any article is missing or damaged, please contact your reseller without delay.

### Package List

	Accessories	Quantity
1	Radio	1
2	Antenna	1
3	Battery	1
4	Hand Strap	1
5	Charger	1
6	Power Adapter	1
7	Belt Clip	1
8	Instruction Manual	1

## 2、 Getting started

### 2.1 Charging the Battery

Plug the power adapter into the proper AC wall outlet; and insert the DC plug in the charger coup. The Red LED flashes after it enters normal work. (Red LED lights per 4.5 seconds)

Insert the battery or the radio to be charged into the charger slot. Please turn off the radio before

insert it into the charger.

Make sure the battery is in good contact with the charger terminals. When the red indicator is lighted, the charger begins to charge the battery.

After charging for about 3 hours, the red LED will turn OFF and the green LED will light indicating the battery has been fully charged.

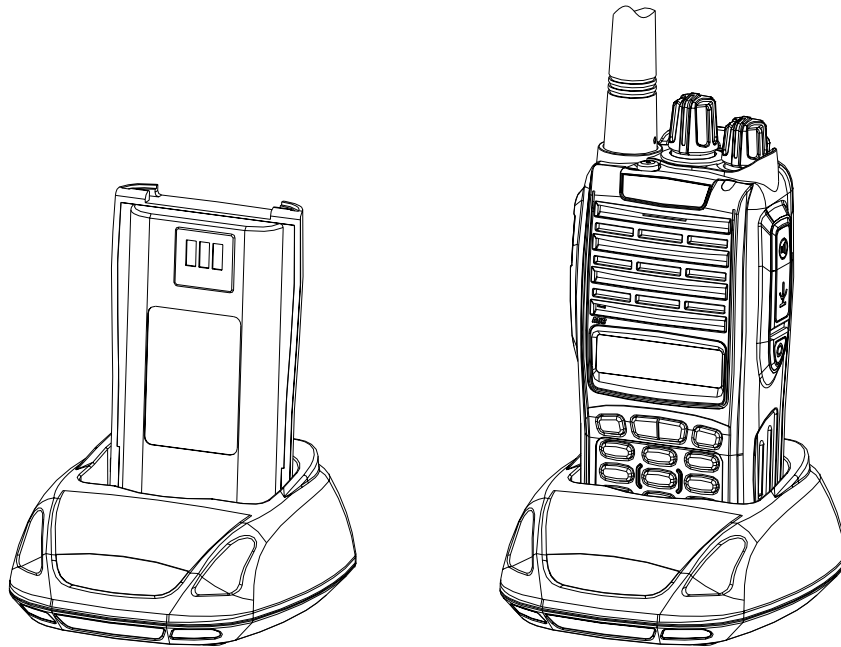

On the first charge, please leave the battery in that state of green indicator for 1~2 hours before you remove it from the charger to achieve the best performance of the battery. Then you can disconnect the power adapter from the AC outlet.

If the Red LED flashes quickly (0.2s on 0.2s off), this means the charging process stopped, This could be because the charging temperature is too high or the battery has a problem, the charger enters a protective state and no more charge is delivered to the battery. Please stop charging in such situation and remove the battery from the charger.

**Notice:**

- \* The new battery is not fully charged in the factory, and needs to be fully charged when you use the radio for the first time.
- \* The radio is supplied with a standard battery manufactured by the factory.
- \* When you charge the battery for the first time after purchasing or after a long time storage (over 2 months), you should repeat charging it several times to achieve the normal battery capacity.
- \* Do not recharge the battery after it has been fully charged or it is partially discharged, otherwise it might affect the battery life or performance. Remove the battery from the charger after charging is finished.
- \* If the radio enters low Battery warning state, please recharge the battery. Do not use the radio in low power state, which will affect the battery life and performance.

# Installing/Removing the Battery Pack

## Installing/Removing the Battery Pack

To install the battery, please place it into the groove on the top of the radio chassis about 5mm away from latch.

If the radio has the belt clip installed, you will have to press one side of the clip, to raise it and slide the battery in proper position.

Press the battery with your fingers and push the battery until you hear a latch click, the battery is now installed.

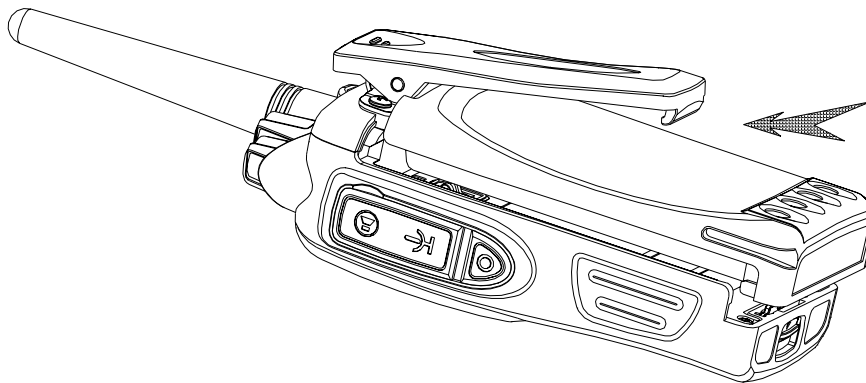

## Removing the battery pack:

If you want to remove the battery from the radio, first press the battery latch located on the bottom of the radio, and then press down to slide the battery about 5mm to release the latch.

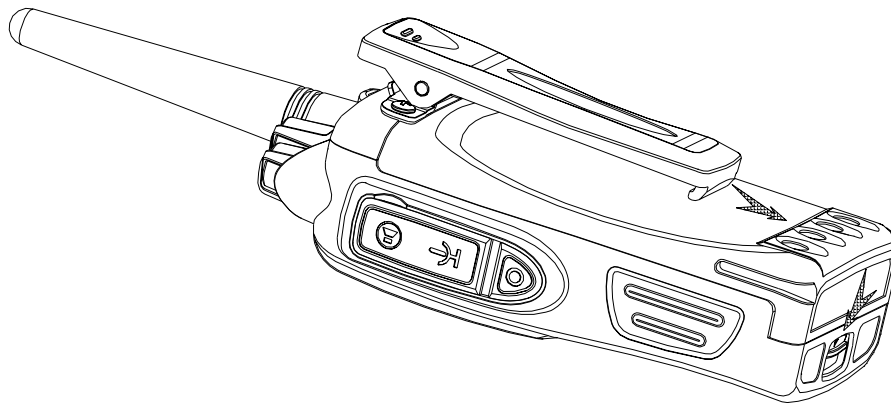

### Notice:

- \* Do not short-circuit the battery terminals or dispose the battery in fire.
- \* Do not disassemble the battery case.

## 2.3 Installing the Antenna

Screw the antenna into the connector at the top of the radio by holding the bottom of the antenna and turn it clockwise until secure.

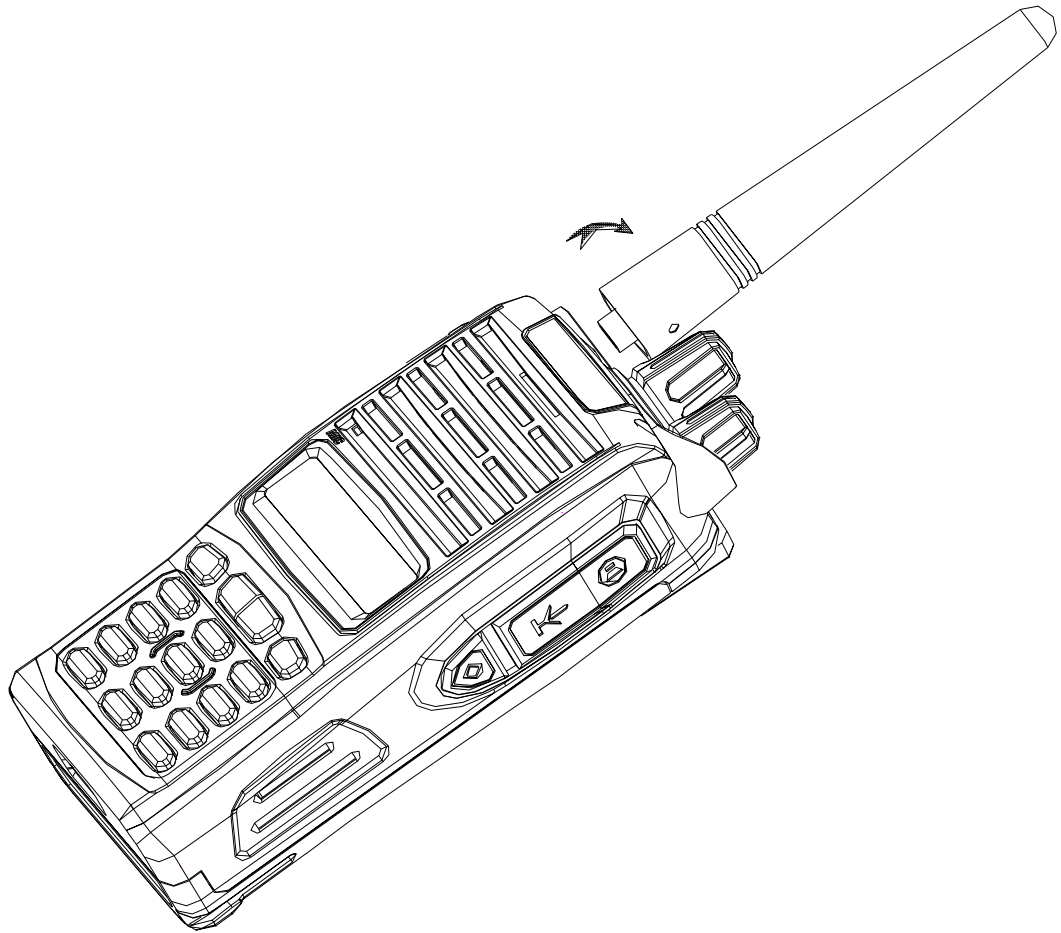

## **2.4 Install external speaker/MIC**

Open the cover of the jack for external speaker/MIC, and then insert the plug of the external speaker or microphone into the jack on the radio. When inserting the accessory plug, make sure it is properly aligned ( straight) to avoid internal damage to the connector in the radio.

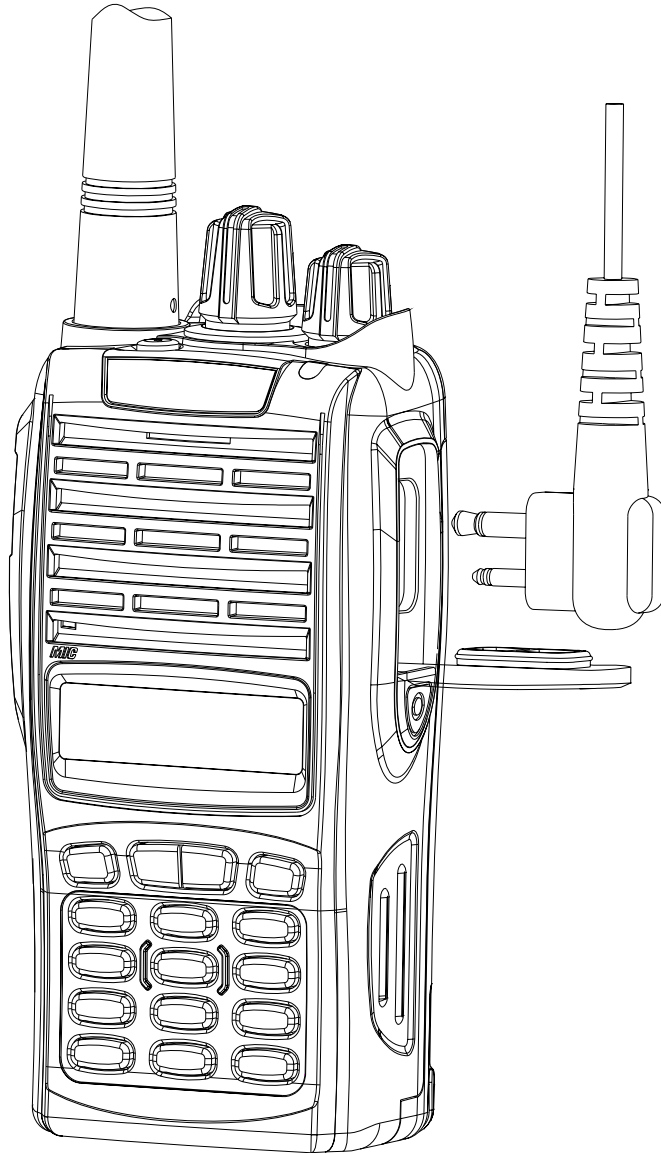

## 2.5 Installing/Removing the Belt Clip

Use the 2 screws (M2.5x8.0) supplied with the radio and fix these screws on the holes in the radio clip and into the holes in the aluminum case. If you want to remove the clip from the radio, just unscrew them, and remove the clip, you can put the screws back to make sure you do no loose

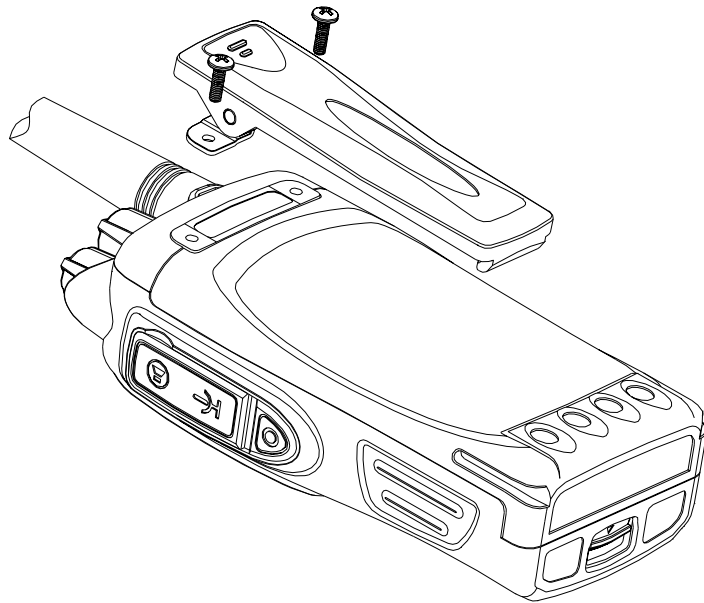

them.

### 3. Radio Overview

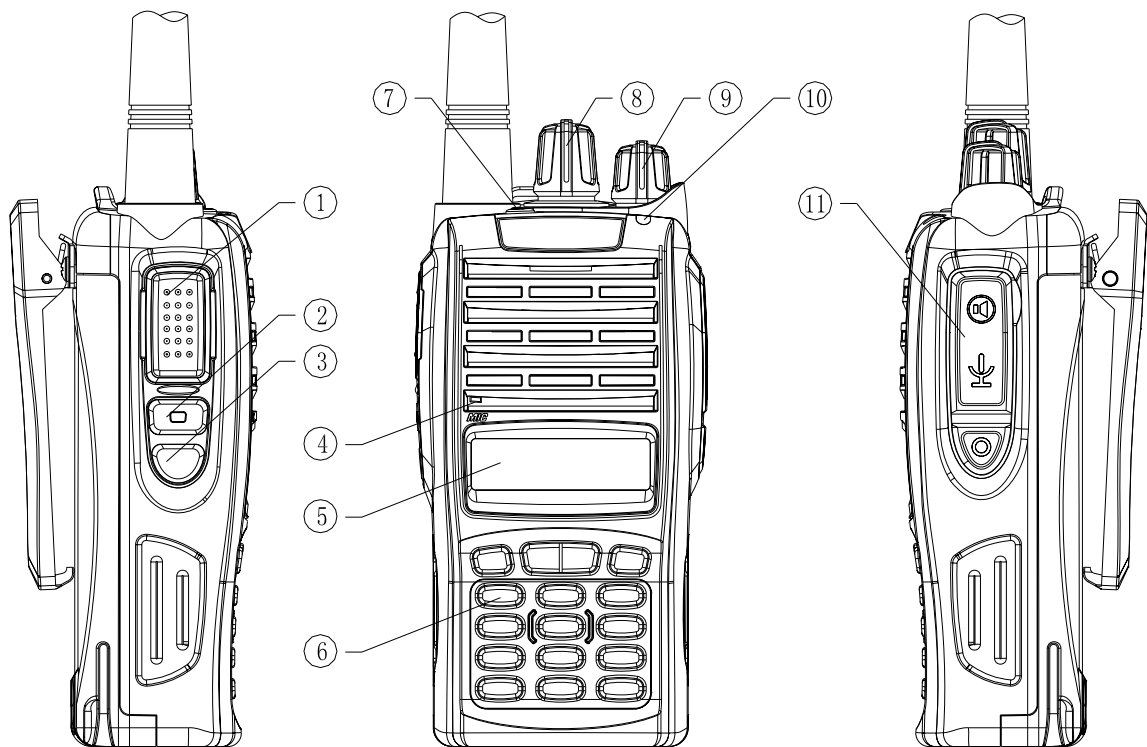

**① PTT ( PUSH-TO-TALK) Button**

To make a call, press and hold the PTT button, then speak into the microphone in normal voice. Release the PTT button to receive signals.

**② Side Button 1 (Programmable Button)**

**③ Side Button 2(Programmable Button)**



④ **MIC Input**

Please keep your mouth about 10 cm (3-4 inches) away from the microphone input to achieve the best voice quality. If the distance is too far or too close to the radio, it will affect the voice quality.

⑤ **LCD**

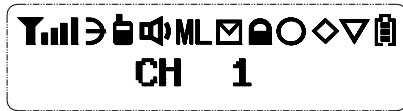

ICON	Description
	Received Signal Strength Indicator
	Scan
	Talk Around
	Monitor
	Squelch Open
	TX Middle Power
	TX Low Power
	New Message
	Key Locked
	Select Staus
	Programmable Icon
	Scrambler
	Battery Meter

⑥ **Key Pad**

⑦ **Top Button** (Programmable Button)

⑧ **Channel Selector**

Rotate to select channel 1~512.

⑨ **Power/Volume Knob**

Turn clockwise to switch on the radio.

Turn counterclockwise till a click is heard to switch off the radio.

Rotate to adjust the volume after turning on the radio.

⑩ **LED Indicator**

LED Indicator Status/Alert. Green LED lights when a carrier is detected in the current channel. Red LED lights during transmission. Flashes orange when receiving 5-Tone signaling or 2-Tone signaling or MDC signaling. Green LED flashes when scanning or Red LED flashes when low battery.

⑪ **Speaker/Microphone Jacks**

Used to connect the optional speaker/microphone.

## 4. Basic Operations

### 1. Power on the radio

Turn on the radio by turning the Power/Volume switch clockwise till a click is heard, and you will hear a Power up beep if the dealer has set it. The radio is now in Rx mode.

### 2. Adjust Volume:

Rotate the Power/Volume knob to adjust the volume with the monitor key pressed.

Turn clockwise to increase the volume and counterclockwise to decrease the volume.

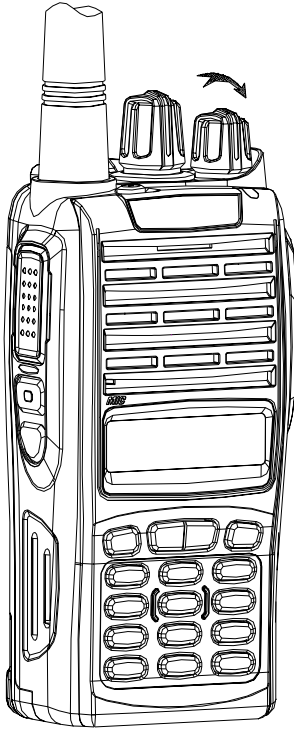

### 3. Select a Channel:

Rotate the channel selector to the desired channel. When a signal is received, it will be heard in the speaker.

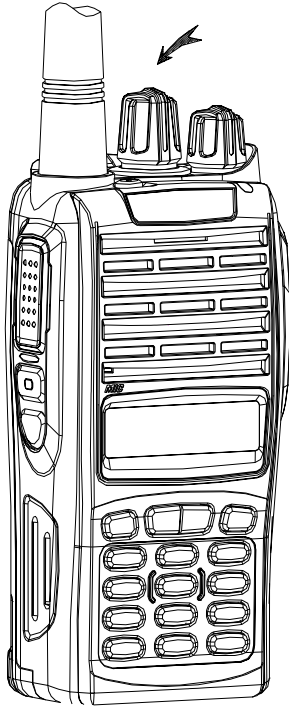

**4. Make a Call:**

To make a call, press the PTT, and speak in normal voice and please keep your mouth about 10 cm (3-4 inches) away from the microphone to achieve optimal voice quality.

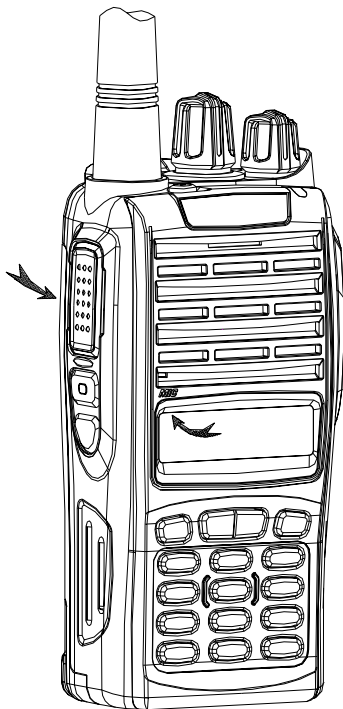



**5. Receive a Call:**



Release the PTT button and adjust the volume at the proper position to receive calls.  
The dealer can set CTCSS/DCS, 5-Tone or 2-Tone DTMF or MDC on your radio. On the channels programmed with Selective Signaling, you will not hear calls except those from the radios in the same group and sending the proper ID.

## ■ Programmable Button Function

The dealer can program the Side Button 1, Side Button 2 and the Top Button with the following Optional functions:

Buttons	Function Description
None	No function
Channel Up	Select the next channel
Channel Down	Select the previous channel
Zone Up	Select the next zone
Zone Down	Select the previous zone
Display Channel Frequency	Press this button and the LCD will show the frequency of the current channel.
Display Channel Name	Press this button and the LCD will show the name of the current channel.
Display Mode Switch	Press this button and the LCD will show "Channel Number", "Channel Name", "Zone Number, Zone Name" and "Channel Frequency" alternately.
OST	Change the setup of preset CTCSS/DCS for the current channel.
Power level Selection	Press this button to make selection among the high, medium and low transmission power, and "H", "M" and "L" will be shown on the LCD to represent the current transmission power.
Squelch Level Selection	Press this button to enter the "Squelch Level Adjustment Mode" first, and then press the  /  button to adjust the level. Press the  button to save the selected squelch level and quit this mode.
Key lock	To toggle between locking/unlocking your radio' keypad.
Scan	<p><b>Scan</b></p> <p>a) Press the button set as "Scan" to start or stop scanning. If scan beep tone enabled, 4 high beeps will indicate entering scanning state, or 4 low beeps indicate exiting scanning state. If scan LED enabled, (the GREEN LED will blink while scanning).</p> <p>b) The working channel of the radio will revert to the defined channels automatically when you press PTT button during scanning.</p>
Nuisance Delete	When one channel continually generated unwanted noise. this allow you temporary remove the channel from the current active scan.
Voice Companding	Start/end the voice compression/expansion function.
Public Address	Start/end the public address function. Press this button and the function will be activated. Press the PTT button and speak to the microphone so that you can hear your voice through the external speaker . Press this button once again and return to the normal user mode.
Scrambler	Enable or Disable voice scrambler function.

Home Channel	Changes to the home channels.
Talk around	Switch the radio between talk around and repeater mode.
VOX Selection	Enable or disable the VOX function.
Monitor momentary/ Call Cancel	Hold this button to close CTCSS, DCS, 2Tone/DTMF signaling according to the set data. Loosen this button to return to the normal operation. Press this button in the selective call state to quit such a state.
Monitor/Call Cancel	Press this button to trigger this function and the CTCSS, DCS, 2Tone/DTMF signaling will be closed, so you can receive the signal that can't be heard in the normal operation. Press this button again to return to the normal operation. Press this button in the selective call state to quit such a state.
Squelch off momentary/ Call Cancel	Hold this button to open the squelch. loosen this button to return to the normal operation. Press this button in the selective call state to quit such a state.
Squelch off/Call Cancel	Press this button to open squelch, press it again to return to normal operation. Press the button in the selective call state to quit such a state
Emergency Alarm	When you press the top button set as "Emergency Call", the radio will enter emergency state, the radio can sound alarm tone or transmit ID code or background tone to your partners or the system, the detail setting is programmed by your dealer.
<b>Cancel Emergency Call</b>	Press the top button set as "Cancel Emergency Call" to cancel Emergency function.
Man-down	Press this key to enable or disable man-down function, which is an optional function. If being in "man-down status" for a setting time, the radio will sound pre-alert tones. If not being set straight in another setting time, the radio will enter "Emergency state."
Radio Call	Press this button and to enter the fast menu mode of "Radio Call". For detailed operation, see "Menu Operation".
Call Button 1	Sends the DTMF/2Tone/5Tone code assigned to call 1 key.
Call Button 2	Sends the DTMF/2Tone/5Tone code assigned to call 2 key.
Call Button 3	Sends the DTMF/2Tone/5Tone code assigned to call 3 key.
Call Button 4	Sends the DTMF/2Tone/5Tone code assigned to call 4 key.
Menu Select /Enter	To enter the menu mode or make menu selections.
Horn Alert	Enables the Horn Alert
Lone worker	When the radio is set in lone work, it will sounds pre-alert tones before the Lone Work time expires, and the user should press any key on the radio within the Reset Time, indicating the user is safe, otherwise, the radio will enter emergency state automatically.
Scan List Edit	Press this button and the radio will enter the fast menu mode for scan list edit. For details, see "Menu Operation".
GPS Information View	Press this button and the radio will enter the menu mode of GPS Information Menu.

VOX Level Selection	Press this button to enter the VOX Level Adjustment Mode". Press  /  button to adjust VOX level. Press  button to save the selected VOX level and quit this mode.
---------------------	--

### When pressing a Key, notice the different beeps you will hear

No beep, key pressed not acknowledge

one beep, feature enable







two beeps, feature disable

“Error” beep, key pressed invalid

## 5. Radio Call

### 5.1. Selective Call

#### 5.1.1 Send Selective Call

- A. Press “Menu Select/Enter” button to enter the menu mode.
- B. Press  /  button until “RADIOCAL”.
- C. Press  button to select “SEL CALL”.
- D. Press  /  button until the required call list appears.
- E. Press “PTT” button to send the selective call.
- F. Press “PTT” button and speak to the microphone in normal voice. Please keep the microphone about 3 to 4 cm far from your mouth. After speaking, please loosen the “PTT”.
- G. Press  button to return to the previous operation.

#### 5.1.2 Receive Selective Call







Receiving a selective call, you will hear the alert tone and the LED indicator will blink orange.  Icon flashes and the caller’s ID or name displays.

Press PPT button for callback.

### 5.2 Call Alert







After the radio receives the call alert, the alert tone will sound and the orange indicator flicker.  icon flashes and the caller’s ID code or name shows until someone answers.

Press the “PTT” button for callback or other buttons for cancellation.

- A. Press “Menu Selection/Enter” button to enter the menu mode.
- B. Press  /  button until “RADIOCAL”.
- C. Press  button to select “CALL ALT”.
- D. Press  /  button until the required call list is showed.
- E. Press “PTT” button to send the call.
- F. After calling, press  button to return the previous operation.







## 6. Select Zone

According to the setup of the communication network, the radio can be distributed to different zones. Select the proper zone to realize communicating with the radio from a different zone.

1. Select the zone through menu.
  - A Press the "Menu Selection/Enter" button to enter the menu mode.
  - B Press  /  button until "ZONE".
  - C Press  button for selection.
  - D Press  /  button until the group name you require is appeared.
  - E Press  button for selection.
- 1 Select the group through "ZONE UP" or "ZONE DOWN" button.

## 7. Talkaround











In the communication network, you can expand communication range through the repeater, but when the mobile radio is out of the communication range, you can connect with other radio in the talkaround method. The talkaround function can be showed by .

1. Select the talk around by menu.
  - A. Press the "Menu Selection/Enter" button to enter the menu mode.
  - B. Press  /  button until "RPTRTALK".
  - C. Press  button for selection.
  - D. Press  /  button until "REPEATE" or "TALKRND".
  - E. Press  button for confirmation.
2. Switch the talkaround or repeater mode through "talkaround" button.

## 8. Utilities

The item can help you customize some setups of the radio.

The operating steps go as follows:

- A. Press the "Menu Selection/Enter" button to enter the menu mode.
- B. Press  /  button until "UTILITY".
- C. Press  button for selection.
- D. Press  /  button until the items you require are showed.
- E. Press  button for select. The radio will show the current setup.
- F. Press  /  button to show all items that can be set with this item.
- G. Press  button to select this setup
- H. Press  button to return to the previous operation.

Change the setup items in the following table as per the previous steps.

Items	Selectable Setups	Functions
Squelch Level "SQL LEV "	SQL 0 ~ 9	Change the squelch level of the radio.
Transmission Power "PWR LEV "	"PWR LOW " "PWR MID ", "PWR HI "	Select transmission power among high, medium and low levels.
VOX Level "VOX LEV "	VOX 0 ~ 9	Change the VOX level of the radio.
Backlight "BACK LED"	"BLED OFF" "BLED ON " "BL AUTO "	Select among such modes of backlight as "turnoff", "normal turn-on" or "auto".
MCU software version	.....	Show the software version.

display "SOFT VER"	Eg. "V1.1.00"	
-----------------------	---------------	--







## 9. Scan

In order to receive the calls from many channels, the radio can be programmed to scan these channels. At most there are 16 channels in each scan list. Each channel can use a scan list together with others or alone.

### 9.1 Start/End Scan Function

You can press "SCAN" button directly or enable the scan through the menu.

When the scan function is started,  icon and your revert channel will display .

1. Enter the scan state through menu mode.
  - A. Press the "Menu Selection/Enter" button to enter the menu mode.
  - B. Press  /  button until "SYS SCAN".
  - C. Press  button for selection.
  - D. Press  /  button until "SCAN ON?" or "SCAN OF?"
  - E. Press  button for select.
2. Use the scan button.
  - A. Press "SCAN" button to activate the scan function.
  - B. Press "SCAN" button again to disable the scan function.











### 9.2 Nuisance Delete

If a channel continuously generates noise or interference, press the  button to remove this channel from the scan list temporarily.







Note: the priority channel can't be removed and the last one in the scan list, either.

### 9.3 Edit Scan List







#### 9.3.1 Add or Delete the Channels in the Scan List

- A. Press the "Menu Selection/Enter" button to enter the menu mode.
- B. Press  /  button until "PROG LST".
- C. Press  button to select "SCAN LIST".
- D. Press  /  button until "ADD LST?" or "DEL LST?".
- E. Press  button for selection.
- F. Press  /  button until the channel you want to add or delete.
- G. Press  button to complete operation you will see "CHNSAVE" (If you added a channel) or "CHN DEL".
- H. Press  button to return to the previous operation.

#### 9.3.2 Set Priority Channel

1. Press the "Menu Selection/Enter" button to enter the menu mode.
2. Press  /  button until "PROG LST".
3. Press  button to select "SCAN LIST".
4. Press  /  button until "ED PRIO?".
5. Press  button for selection.





6. Press  /  button until "PRIO#1?" or "PRIO#2?".
7. Press  button to select the type of the required priority channel.  
For example, in Step 7, the type of priority channel is "DES?".  
Press  /  button to select the required priority channel.
8. Press  button to complete operation.
9. Press  button to return to the previous operation.

## 10. OST

In a certain specific channel, you can revise the CTCSS/DCS encode/decode setup of current channel.

The operating steps go as follows:







- A. Press the "OST" button to enter the OST menu mode.
- B. Press  /  button until the CTCSS/DCS encode/decode you want.
- C. Press  button to select.

### Note:

- When the OST backup function is enabled, the radio retains the OST code of each channel even if the channel is changed or the radio is shut down
- In the OST state, P2" icon will display.
- Press "OST" button again to return to normal operation.

## 11. GPS Information View

If the radio starts the GPS function, you can view the current GPS information. The specific operating steps go as follows:

- A. Press "GPS Information View" button to enter the GPS information display mode.
- B. Press  /  button until the items you require displays.
- C. Press  button for selection.
- D. Press  /  button for page up of the following content.
- E. Press  button to return to the previous operation.

The specific content can be shown as follows:

1. Positioning star number: "STAR NUM"
2. Longitude "LONGITUD"
3. Latitude "LATITUDE"
4. Altitude "ALTITUDE"
5. Speed "SPEED"
6. Time "TIME"

## ■ VOX (Voice Operated Transmission)

VOX allows hands-free transmission on the radio when using the appropriate earphone/headset.

Two types of VOX are available: built-in and external.

If VOX has been set, when speaking voice reach the preset volume, VOX will activate the radio to transmit automatically.

## ■ Radio Setting

### **TOT (Time-out Timer)**

#### **1) TOT dispatch time**

The TOT Dispatch Time is the maximum period of time that the radio is allowed to transmit continuously in normal dispatch mode. When the programmed time expires, the radio generates a warning tone and stops transmitting. The range for the TOT Dispatch Time is from 5 seconds to 600 seconds in step of 5 seconds..

#### **2) TOT Re-key**

a) TOT re-key specifies the time when transmission is prohibited after the time-out timer is activated.

b) During the time of transmitting prohibition, if you press the PTT button, warning tone sounds and transmitting is prohibited.

#### **3) TOT Pre-alert**

a) Before the time-out timer stops transmitting, the radio sounds pre-alert tone.

b) After the alarm tone, if the transmitting time is longer than the preset time limit, the time-out timer will be activated.

#### **4) TOT Reset**

a) TOT Reset is the delay time between releasing the PTT button and resetting the time-out timer.

b) If the time of releasing the PTT button is shorter than the TOT Reset, the countdown of transmitting prohibition will continue.

### **Battery Save**

The dealer can program the battery save type.

If the battery save function has been set, 10 seconds after no signals being received or no operations being conducted, the radio enters the battery save mode. It will exit the battery save mode automatically after receiving signals or being conducted.

Battery Save Types: Short, Middle, Long and OFF.

Battery save function can increase battery active time.

### **Low Battery Warning**

Low Battery warning tone sounds and RED LED flashes when the battery power goes below the preset value and you need to recharge the battery. If the battery voltage is too low, transmission is prohibited.

## **CTCSS/DCS**

The dealer can set CTCSS/DCS on the radio channels to ignore calls on the same channel from irrelevant radios.

If a channel has been set with CTCSS/DCS, the squelch will be activated only when it receives the proper CTCSS/DCS signals. And only the radios set with the same CTCSS/DCS signaling as those on yours can hear your call.

Note: Using a CTCSS/DCS channel doesn't mean your calls are private. If the CTCSS/DCS tones of other radios are identical with those on yours, they can hear your calls.

## **■ User Template**

A user template includes PTT code-transmitting, encoding, decoding, Busy Channel Lockout, Call 1/2/3/4, RX squelch mode, TX conditions and decoding conditions, etc. Maximum 16 user templates are available on this radio.

### **RX Squelch Mode**

The dealer can set conditions under which the speaker will be activated from the following 4 options:

- 1) CTCSS/DCS and Audio Squelch: The speaker will be activated only when both CTCSS/DCS and the selective signaling matched.
- 2) Audio Squelch: The speaker will be activated when the selective signaling matched.
- 3) CTCSS/DCS Squelch: The speaker will be activated when CTCSS/DCS matched.
- 4) Carrier Squelch: The speaker will be activated when carrier wave presents

## **Scan**

When in scanning, the radio checks signals on each channel; it stops scanning and pauses on the channel on which signals are detected until the signals disappear. If a delay time has been set between the interval of signal disappearing and scanning restarting, the radio will stay on that channel if it receives any signals during the delay time.

The operating channel of the radio will revert to the following channels automatically when you press PTT button during scanning. The dealer can select one among the following six options.:

- 1) Start channel

When pressing PTT button, the radio will transmit from the channel described in the Start.

- 2) Selected channel

When pressing PTT button, the radio will transmit from the channel selected.

- 3) Last called

When pressing PTT button, the radio will transmit from the last channel that received a call.

- 4) Last used

When pressing PTT button during the scanning, the radio will transmit from the last channel you used to talk.

- C) Priority Scan

During scanning, if the priority channel has been set on the radio, when the priority channel receives signals the radio will automatically switch to the priority channel even the normal channel is receiving signals at that time. And the radio will stay on the priority channel till the signals disappear. The dealer can set the delay time between signal disappearing and continuing scanning.

Temporarily Delete Noise Channel When scanning pauses on a channel, press and hold the button Programmed as “Temporarily Delete Noise Channel” to delete this channel temporarily from the scanning list.

Note: The priority channel cannot be deleted.

## **DTMF**

The dealer can set DTMF signaling in the Personality Template. The Call Alert / Selective Call, Message , ANI feature and so on can be set by your dealer.

## **5-Tone Signaling**

The dealer can activate or inactivate this function by programming.

5-Tone has 9 encoding formats: CCIR1, CCIR2, ZVEI1, ZVEI2, SVEI3, EEA, EIA, USER DEFINED 1, and USER DEFINED 2. The last two formats are user defined.

### **1) 5-Tone Decode**

The decoding template is 5-tone decoding. If the decoding template matches the encoding template, decoding succeeds.

When receiving proper 5-tone signaling, squelch will be activated according to the “RX Squelch Mode” defined by the user. You can receive the call and LED flashes orange.

After the radio decoding succeeds, the radio will work according to the decoding call response set by the dealer.

### **2) 5-Tone Encode**

Encoding template consists of at least one and at most three encoding sequences and each decoding sequence can be set with 5-Tone, and DTMF. If it is set with 5-Tone, you need to program its content.

If the PTT ID on the channel you select has been set with 5-Tone, 5-Tone signaling will be transmitted when making a call.

Or transmit 5-Tone signal by pressing the Call 1/2/3/4 button,, which can be set by the dealer.

## **2-Tone Signaling**

This function can be enabled or disabled by dealers through programming software.

2Tone has 4 systems; the single tone continuous time, such as first tone or second tone, could be set by the dealer.

### **1) 2Tone decode**

If the received 2 tone is same as the template chosen then it can decode successfully. After the radio received the correct 2 tone signaling, according to the Receive squelch mode set by the user, the squelch will be ON. Then, the radio can receive the call and the orange LED light flashes.

After decoding successfully, the radio can work according to the decode call response set by the

dealer.

## 2) 2Tone encode

The encoding template is set in the 2 tone call list. The details must be set if encoding is ON. The radio transmits the 2 tone signaling when the programmed call button is pressed. (The side button could be programmed as Call1/2/3/4). This function is programmed by the dealer.

## MDC Signaling

This function can be enabled or disabled by the dealers through programming software.

MDC has 4 systems, in which different main ID, group ID, etc., could be set by the dealer.

### 1) MDC decode

The option MDC system can be set through the RX signaling system in the personal template. If the received MDC code is same as the one set in the system, it can decode successfully. After the radio received the correct MDC signaling, according to the Receive squelch mode set by the user, the squelch will be ON. Then, the radio can receive the call and the orange LED light flashes.

### 2) MDC encode

If the PTT ID of the chosen channel is set as MDC, the MDC code will be transmitted when calling.

## ■ Troubleshooting

No.	Problems	Solutions
1	The radio cannot be switched on or no display after switched on.	<ul style="list-style-type: none"><li>● Battery pack may not be installed properly. Remove the battery pack and install it again.</li><li>● Battery power may be insufficient. Recharge or replace the battery pack.</li></ul>
2	The battery power consume quickly after charging.	<ul style="list-style-type: none"><li>● The battery life is finished; please replace it with a new battery pack.</li></ul>
3	Cannot talk to or hear other members in your group.	<ul style="list-style-type: none"><li>● The frequency or CTCSS/DCS signaling are not identical and please reprogram it.</li><li>● Make sure the setting of the selective signaling 5-Tone in the RX Squelch Mode is proper.</li><li>● Beyond the radio efficient communication range.</li></ul>
4	Other voices from non-group members are heard on the channel.	<ul style="list-style-type: none"><li>● Change the CTCSS/DCS tone, and make sure change the tone on all radios in your group.</li><li>● Please set 5-Tone selective signaling on the channel.</li></ul>
5	Communication range is too small.	<ul style="list-style-type: none"><li>● Make sure the antenna is well connected.</li><li>● Make sure the antenna is the originally supplied one.</li><li>● Check if the battery power is in the normal state.</li><li>● Ask your local dealer to adjust the squelch level.</li></ul>
6	Unable to transmit.	<ul style="list-style-type: none"><li>● Make sure the PTT button has been pressed completely.</li><li>● Battery power may be insufficient. Recharge or replace the battery pack.</li></ul>

		<ul style="list-style-type: none"> <li>● Transmitting frequency has not been set on the channel and the radio has been remote killed.</li> </ul>
7	Noise is too loud.	<ul style="list-style-type: none"> <li>● Battery power may be insufficient. Recharge or replace the battery pack.</li> <li>● Beyond the efficient communication range.</li> </ul>

## ■ Settings (by the Dealer)

Model: \_\_\_\_\_

Serial No.: \_\_\_\_\_

### 1) Channels List

Channel	Type	Receiving Frequency	Transmitting Frequency	CTCSS /DCS Decode	CTCSS /DCS Encode	Power	Bandwidth	Scan List
1								
2								
3								
4								
5								
6								
7								
8								
9								
10								
11								
12								
13								
14								
15								
16								

### 2) Optional Functions

Time-out Time (TOT)

5-600s

Squelch Level

0-9

Voice Annunciation

ON  OFF

Battery Save

OFF  Short

Middle       Long

### 3) Auxiliary Function Button Settings

**Note:**

---

---