



Cisco USC 8718/8818 Installation Guide

[Cisco USC 8718/8818 Dual-Mode Small Cell Module Installation](#) 2

[Before You Begin](#) 2

[Install Your Small Cell Module](#) 5

[Antenna Patterns](#) 13

[Safety Instructions](#) 19

Revised: October 26, 2015,

Cisco USC 8718/8818 Dual-Mode Small Cell Module Installation

Before You Begin

The Cisco Universal Small Cell (USC) 8718 dual-mode small cell module provides either 3G or 4G cellular coverage in an indoor environment where improved coverage and capacity is desired for cellular services. The USC 8818 small cell module provides LTE cellular coverage on a software-selectable LTE band. The small cell modules are specifically designed to work with Cisco Aironet 3600/3700 series Wi-Fi access points (APs) or the USC 5030 small cell chassis. Each small cell module is capable of supporting either Universal Mobile Telecommunications System (UMTS), where applicable, or Long Term Evolution (LTE) radio protocols in a single platform, is 3GPP compliant and supports UMTS Release 7 and LTE Release 9 standards.

Each USC 8718 module can support either:

- up to 32 simultaneous UMTS voice and data channels, a peak downlink rate of 21 Mbps and a peak uplink rate of 5 Mbps
- up to 32 active LTE users per radio, a peak download rate of 100 Mbps, and a peak upload of 50 Mbps when used with 20 MHz channel bandwidth

The USC 8818 is a dual-band, LTE-only, software-switchable module that can support up to 32 simultaneous LTE channels on either LTE cell, a peak download rate of 100 Mbps, and uplink of 50 Mbps when used with 20 MHz channel bandwidth.

These small cell modules enable mobile operators to offer dedicated, in-building coverage and capacity for UMTS and LTE services. They are managed by the Cisco USC 8088 controller installed in the enterprise.

Figure 1: Small Cell Relationship to Enterprise and Mobile Operator Core Networks

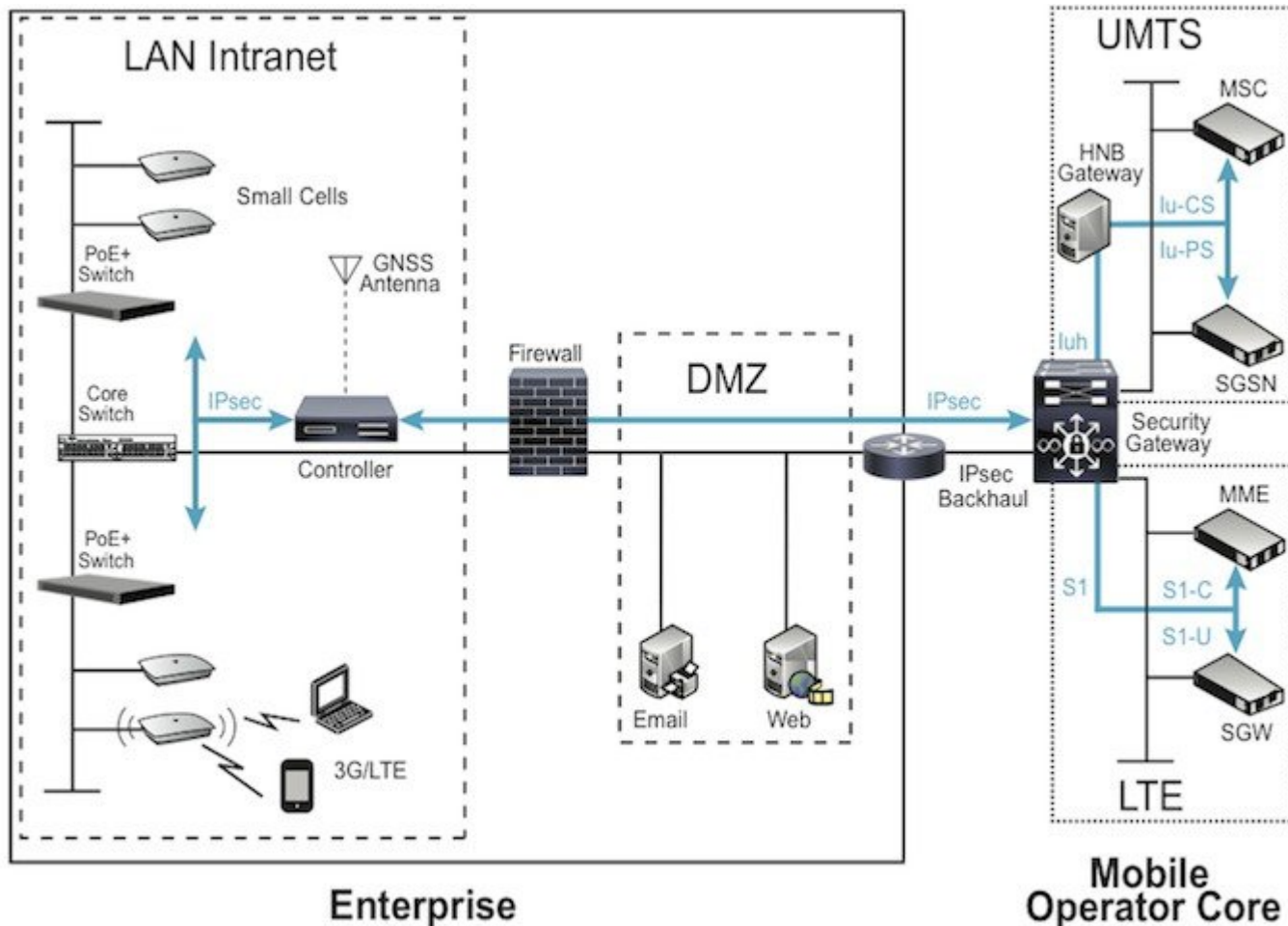

System Requirements

The various small cell modules are designed for use with the following hardware:

Table 1: Small Cell Modules and Supported Hardware

Small Cell Module	Transmit Bands	Monitor Bands	Supported Hardware
USC8718-M17-K9	UMTS Band 1 LTE Band 7	UMTS Bands 1, 8 LTE Bands 3, 7, 20 GSM 925-960 MHz and 1805-1880 MHz	Aironet 3700 AP Rev 2 USC 5030

Small Cell Module	Transmit Bands	Monitor Bands	Supported Hardware
USC 8718-M24-K9	UMTS Band 2 LTE Band 4	UMTS Bands 2, 5 LTE Bands 2, 4 GSM 869-894 MHz	Aironet 3600 AP Aironet 3700 AP USC 5030
USC8718-M13-K9	UMTS Band 1 LTE Band 3	UMTS Bands 1, 8 LTE Bands 3, 7, 20 GSM 925-960 MHz and 1805-1880 MHz	Aironet 3600 AP Aironet 3700 AP USC 5030
USC8818-C13-K9	LTE Band 1 LTE Band 3	UMTS Bands 1, 5, 8 LTE Bands 1, 3, 7 GSM 925-960MHz and 1805-1880MHz	Aironet 3600 AP Aironet 3700 AP USC 5030



Note USC 8000 series modules are compatible with the Cisco Aironet –i variants with internal antennas when they are ceiling mounted (for example, Cisco 3700i). They are not compatible with Cisco Aironet –e variants when horizontal mounted or with external antennas (for example, Cisco 3700e).

The small cell modules are not designed for use with other access points. The small cell modules are managed by the Cisco USC 8088 controller installed in the enterprise. The controller has two variants, one for high capacity and another for low capacity. These two variants differ in relation to the access modules installed in the hardware.

Software Requirements

The small cell modules are supported on Release 4.1.5 and above.

The small cell modules are compatible with software release 8.1 MR or beyond of the wireless LAN controller. Please verify that the proper release version is available on the wireless LAN controller at the time of installation.

Power Considerations

Installation of your small cell module can require an additional 10 watts to power the Cisco Aironet access point. With a small cell module installed, the access point requires the full Power over Ethernet Plus (PoE+) of 25.5 Watts at the egress switch port and a cable run of less than 300 feet (100 meters).

Power options for the access point include:

- IEEE 802.3at POE+ 25.5 W delivered from the upstream Ethernet switch
- Cisco 3600 Series Power Injector (AIR-PWRINJ4=)
- Cisco 3600 Series local power supply (AIR-PWR-B=)

The small cell module has a power limit circuitry that shuts down the module if it draws more power than allowed.

Installation Considerations

Install your small cell:

- in a central location, in an area where people are most likely to make calls
- away from windows, to avoid the signal leaking outside or external signals leaking in
- in an open area with airflow; not in a closed cabinet which reduces the signal strength
- at least 5 meters (16 feet) from an external wall. This distance maximizes indoor coverage and minimizes RF leakage outside the building. Refer to the Cisco USC 8000 Series Deployment Planning Guide for Dual-Mode Systems and Cisco USC 8000 Series Deployment Planning Guide for LTE Systems for more information about small cell placement.

If you have thick internal walls, or metal, fire or rotating doors, plan to place units at either side of the obstruction at a distance shorter than 49 feet (15 m). Install a unit across from a corner to provide coverage on both sides of the corner.

For more information, refer to the "Cisco Aironet AP Module for Wireless Security and Spectrum Intelligence (WSSI) Deployment Guide" at the following URL: http://www.cisco.com/en/US/products/ps11983/products_tech_note09186a0080bed15d.shtml.

Install Your Small Cell Module

The small cell module can be installed in either a Cisco Aironet 3600 series access point (AP), a Cisco Aironet 3700 series AP or the Cisco USC 5030 chassis according to these instructions:

Procedure

- Step 1** Remove the module from the packaging.
- Step 2** Power down the access point if you are installing the small cell module into an operational access point.
- Step 3** Peel off the label from the back of the AP to reveal the module port connector.

Figure 2: Backside of Cisco Aironet 3600 Access Point

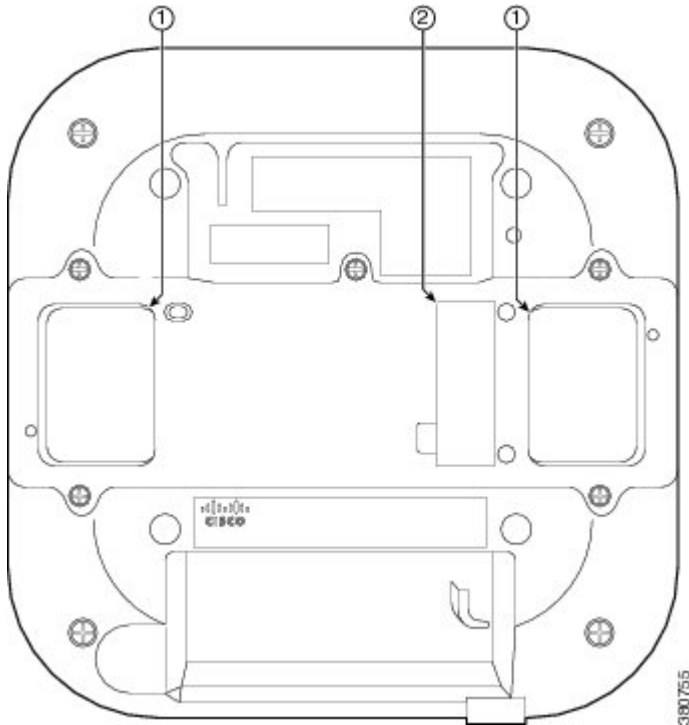

1	Openings for module's antennas
2	Label covering port connector

Step 4 Align the module connector with the connector on the back of the AP or USC 5030 chassis such that the male and female 100-pin mezzanine connectors mate.

Figure 3: Installing Module in the Cisco 5030 Chassis

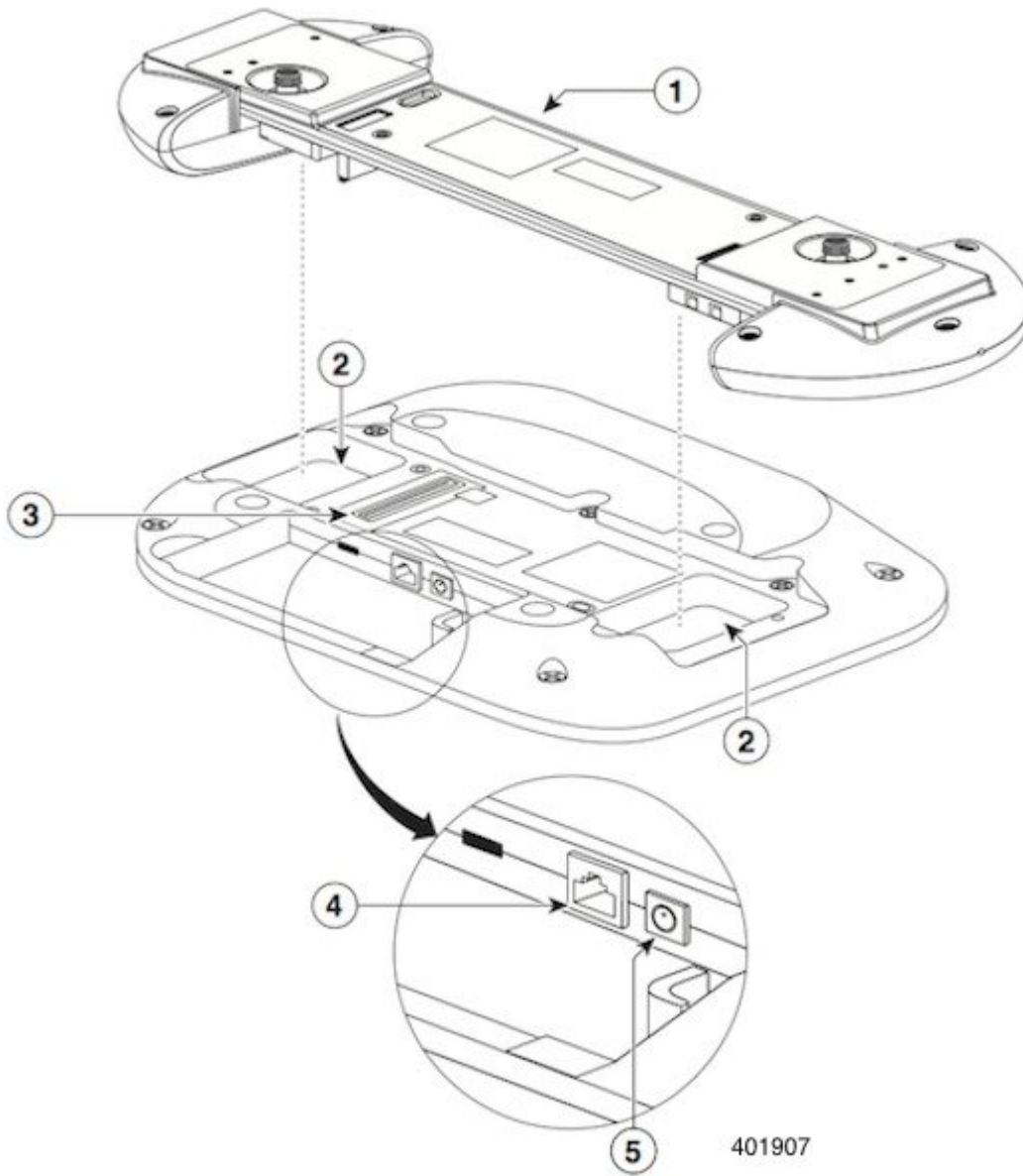

1	Small cell module	4	10/100 Base-T Ethernet port
2	Openings for module antennas	5	Power port for DC power source
3	Port connector		

Step 5 Hold both units in your hands and firmly join the module to the AP or USC 5030 chassis to fully attach the two units.

Note Because the small cell module is thicker than the AP, you must hold both units together when attaching them.

Step 6 Screw down the thumb screws on the module.

Note If the screws are not tightened, the module will not be recognized and may not operate correctly. Make sure not to over-tighten the screws; they should be only hand-tightened.

Step 7 Power up the access point.

Step 8 If necessary, mount the access point or USC 5030 chassis, with the small cell module installed, using the universal bracket (AIR-AP-BRACKET-2).

Note The universal bracket works with electrical boxes, can be used for wall mounting, and adapts to ceiling installations. It leaves a larger gap between the mounting surface and the access point, which allows space for the small cell module.

For more information, refer to "Access Point Mounting Instructions" at the following URL:
http://www.cisco.com/en/US/docs/wireless/access_point/mounting/guide/apmount.html

Boot Sequence and USC 8088 Controller Communication

On initial boot, the small cell module performs the following boot sequence. When finished, the module is reachable.

Figure 4: Small Cell Boot Sequence

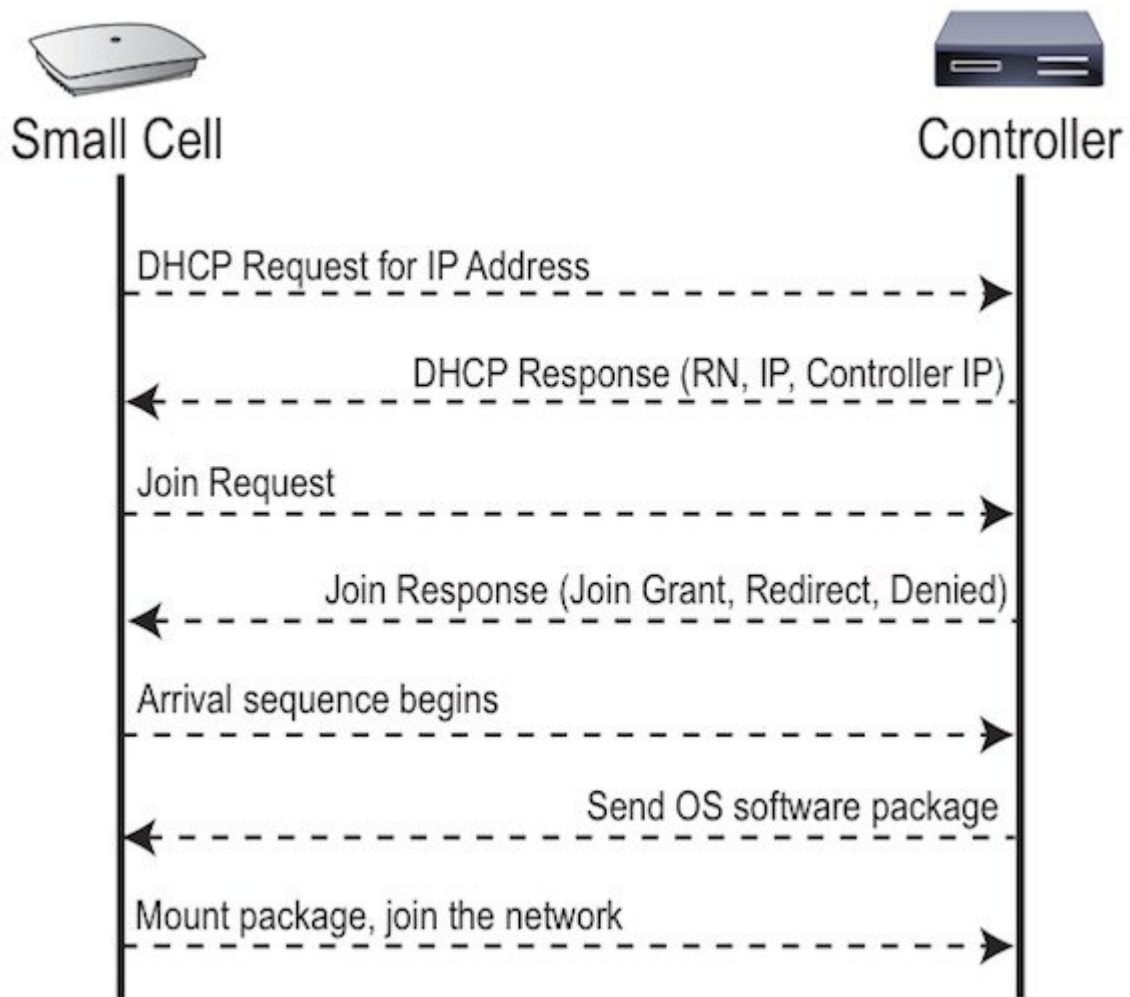

Boot Sequence:

- 1 When the small cell is powered on, the device sends a DHCP Request to the controller DHCP server to get IP information. The DHCP server is configured on the controller to respond only to DHCP requests from Cisco Systems small cells. Refer to the Cisco USC 8000 Series OS Administrator Guide for more information about the controller DHCP server configuration.
- 2 The server responds with the IP addresses of the small cell and the controller (the master of the small cell).
- 3 Using its own IP address, the small cell sends a Join Request message to the controller. The small cell seeks to join the cellular network.
- 4 The controller responds with a Join Response message indicating whether the small cell is allowed to join the network or not.

- 5 The arrival sequence begins. The controller sends the software image to the small cell.
- 6 The small cell boots up the received software package.
- 7 The small cell establishes an IPsec tunnel with the controller. Based upon the radio configuration, the small cell loads the appropriate protocol elements and joins the network.

Small Cell LED Boot Sequence

The small cell state machine is sequential and progresses in the following order:

State 0 -> State 1 -> State 2 -> State 3 -> State 4 -> State 5

A normal boot sequence transitions through all these states sequentially and the LED state transitions accordingly. If the small cell fails to transition to the next state, the system restarts the boot sequence, starting with State 0. You can determine the progress during the booting stages by observing the LED color transitions. On failure, the last LED state will display the state that encountered the failure. This table shows the small cell boot sequence and corresponding LED behavior:

Table 2: Small Cell LED Boot Sequence

State	LED Color	Description	Possible Failures and Actions
0. Power On/Reset	Flashing Green	Initial state on startup. The small cell bootup is controlled by firmware in this state. It goes through a lamp test in this state, meaning that it cycles through all LED colors.	Short lived state; small cell should transition to the next state immediately and should not remain in this state indefinitely. Note Flashing Green is also used to indicate a small cell that has been administratively disabled. This can be determined from the CLI.
1. DHCP	Solid Red	Small cell sends DHCP Request. The small cell moves to the next state (State 2) upon receiving a DHCP response and an IP Address.	No DHCP Response, IP Address not allocated. Check cabling, DHCP Server configuration.
2. Join	Solid Blue	The small cell has an IP Address and sends a UDP Join request to the Serving controller. The small cell moves to the next state (State 3) upon getting a JOIN GRANT from the controller.	No IP reachability to the controller. Check IP network between small cell and controller for routing issues.
3. TFTP	Flashing Blue	The small cell proceeds next to download the operating system image from the controller. The small cell moves to the next state (State 4) after the image has been downloaded.	Failure to download TFTP image. Check firewall between small cell and controller.

State	LED Color	Description	Possible Failures and Actions
4. Operating System Booting	Flashing Green	The small cell loads the operating system and starts the default platform applications. The small cell moves to the next state (State 5) when it establishes connectivity with the service node.	Failure to start the operating system. This normally points to a software/build issue. Please contact Cisco support.
5. Running	Solid Green	The operating system is running. The small cell continues the startup sequence, but is now controlled by the controller. The operating system is up and running on the small cell.	Any subsequent state transitions can now be tracked from events and logs on the controller.

Verify Your Small Cell Module Installation

After the small cell module is installed and powered up, it takes approximately one minute for the module to perform the boot sequence and be reachable by the controller. Take note of the initialization sequence by noting the color and activity of the LEDs on either side of the module. The module is ready to use when the LEDs change to solid green.

Figure 5: Cisco Small Cell Module

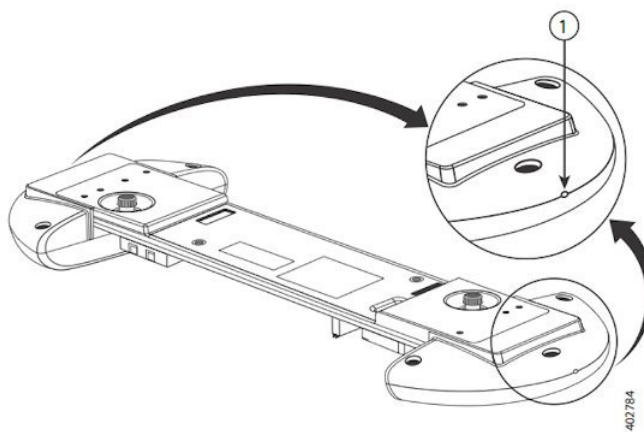

1	LED—the same LED indication displays on both sides of the module
---	--

The LED display is active by default, but can be deactivated in light-sensitive environments as needed. Even when the display is disabled, the LED will be lighted during the following conditions:

- while the small cell is booting
- if the small cell or cell is in fault state
- if there is an active emergency call
- if the locate small cell feature is active

- if the follow IMSI feature is active

This table shows the default LED behavior of the USC 8718:

Table 3: Cisco USC 8718 LED Behavior

LED	Status	Flash Rate
Green: slow flashing	Administratively disabled	Approximately ½ second on, 1½ sec. off
Green: fast flashing	Booting	Approximately 1.4 second on/off cycle
Green: solid	Operational	
Red: solid	Fault	
Red: fast flashing	One or more emergency calls active	Approximately 1 second on/off cycle
Blue: fast flashing	Locate small cell enabled ¹	Approximately 1 second on/off cycle
Blue: solid	Follow IMSI enabled ¹	
Off	Powered off or LED disabled	

¹ Refer to the Cisco USC 8000 Series OS Administrator Guide for information about "locate small cell" and "follow IMSI".

To disable the LED display:

- 1 From the Configuration Mode, use the **set System RadioNode LED DefaultMode Dark** command.
- 2 To verify the configuration, use the **show System RadioNode LED** command.

```
show System RadioNode LED
DefaultMode Dark;
```

To re-enable the LED display:

- 1 From the Configuration Mode, use the **set System RadioNode LED DefaultMode Standard** command.
- 2 To verify the configuration, use the **show System RadioNode LED** command.

```
show System RadioNode LED
DefaultMode Standard;
```

Antenna Patterns

This illustration shows the USC 8718 antenna locations when situated on the AP. Refer to the orientation when assessing the radio band patterns in this section.

Figure 6: Orientation and Antenna Locations



This illustration shows the vertical and horizontal alignment positions used in the band patterns in this section.

Figure 7: Vertical and Horizontal Alignment Orientations

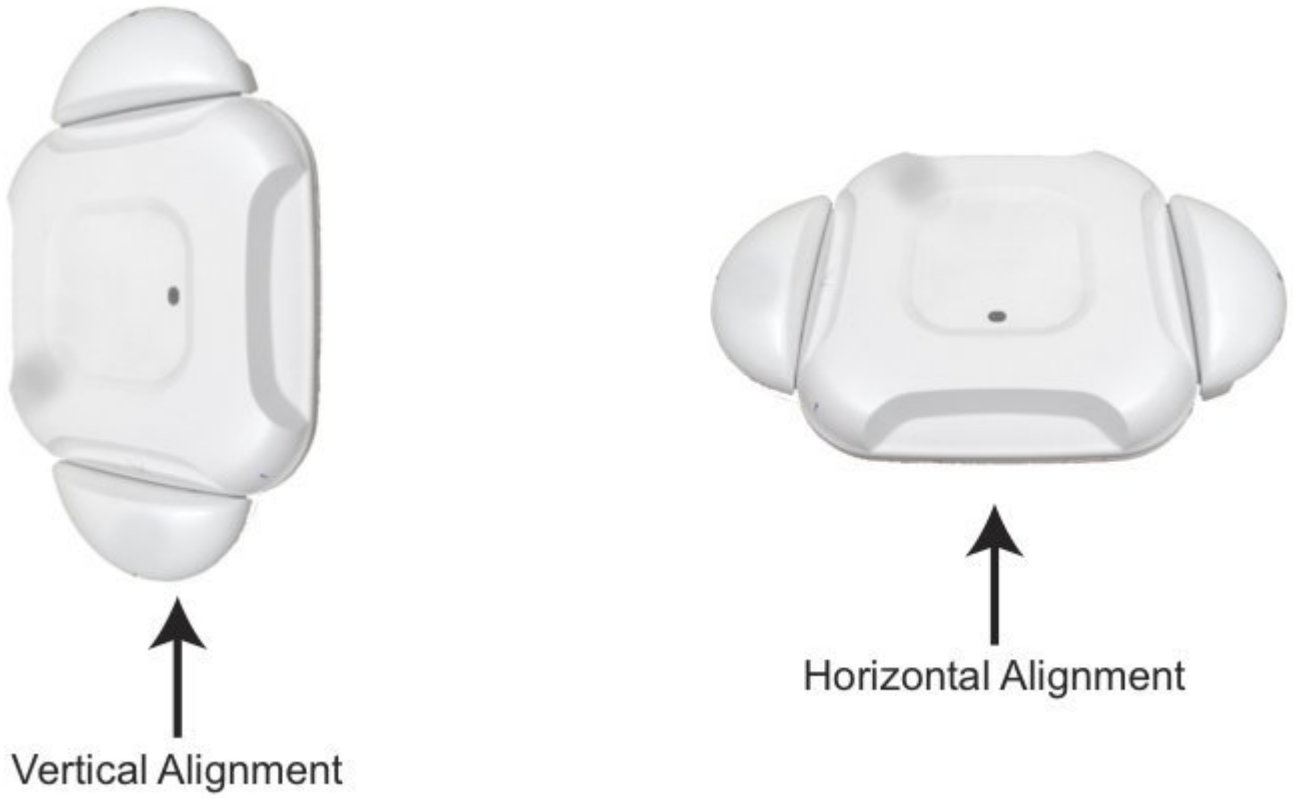

Band 1

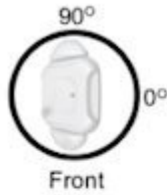

Frequency: 2140 MHz. Peak Gain: 2.47 dBi.

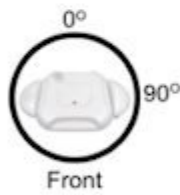
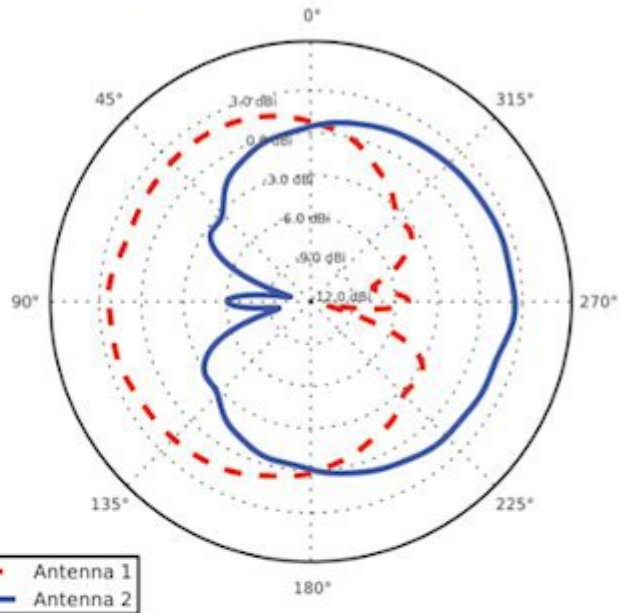

Frequency: 2140 MHz. Peak Gain: 1.52 dBi.

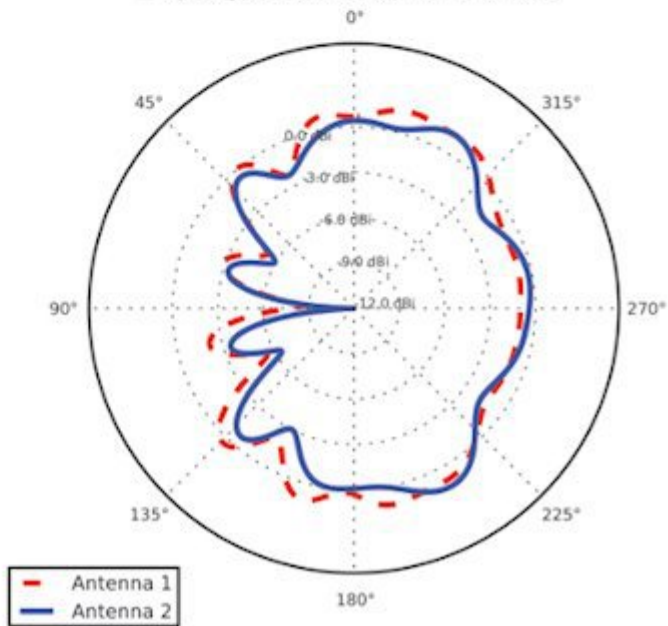

Band 2

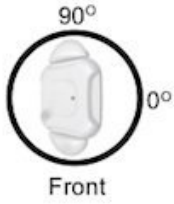

Frequency: 1960 MHz. Peak Gain: 1.50 dBi.

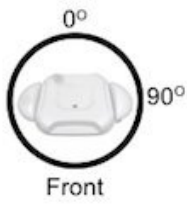
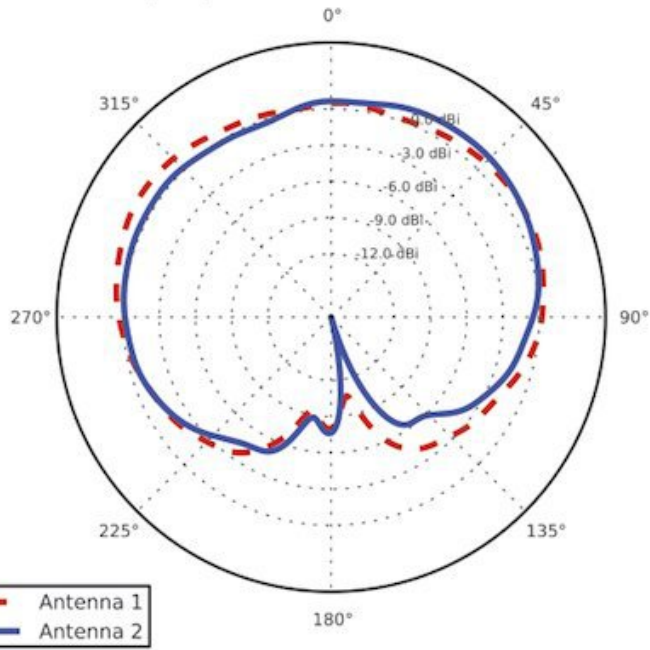

Frequency: 1960 MHz. Peak Gain: 1.85 dBi.

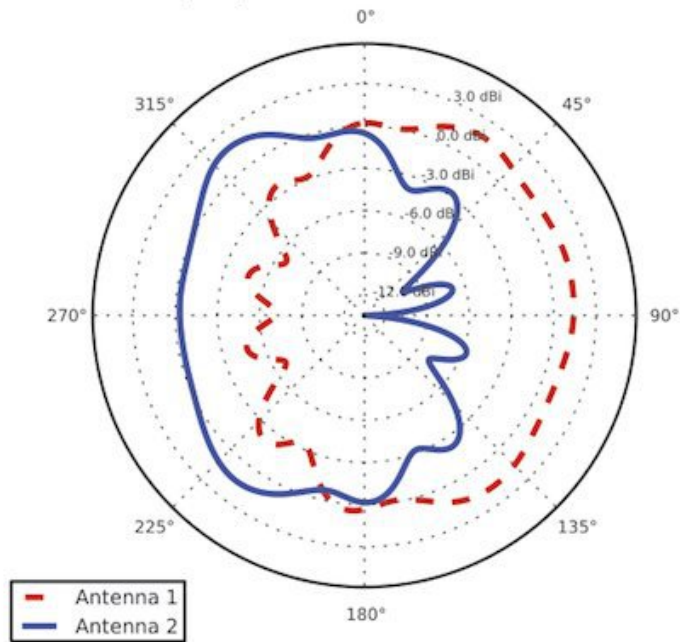

Band 3

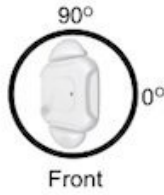

Frequency: 1843 MHz. Peak Gain: 0.78 dBi.

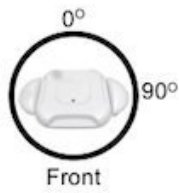
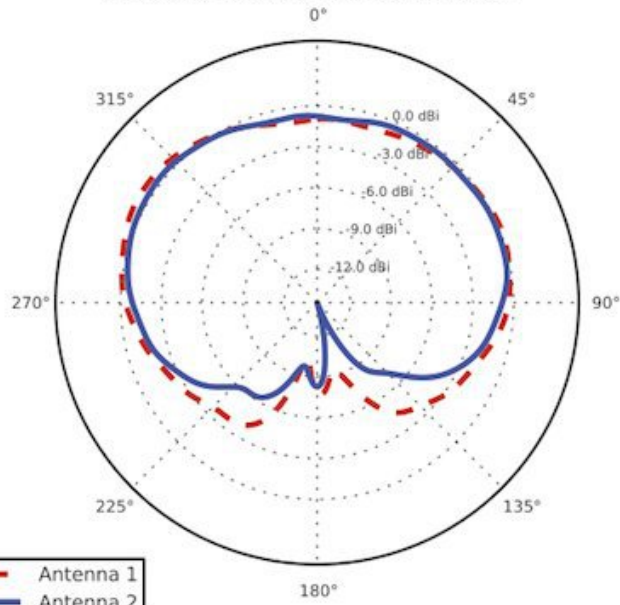

Frequency: 1843 MHz. Peak Gain: 2.18 dBi.

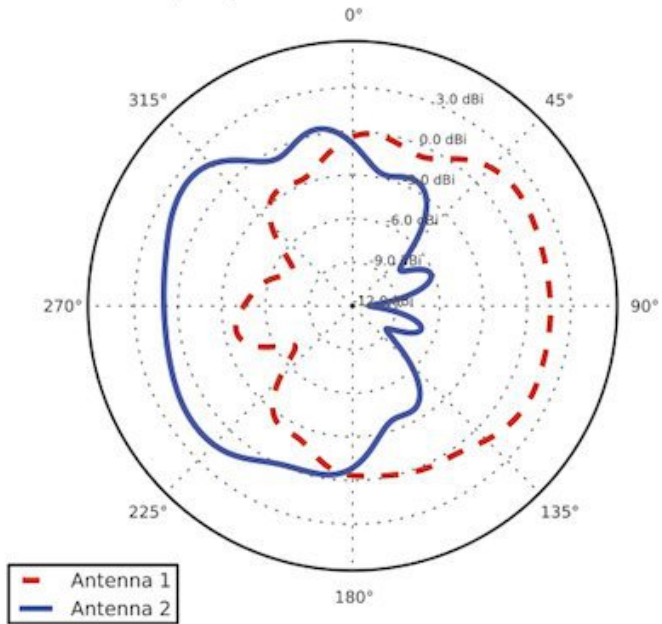

Band 4

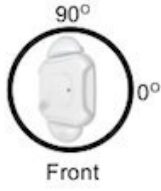

Frequency: 2133 MHz. Peak Gain: 2.32 dBi.

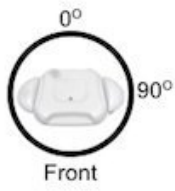
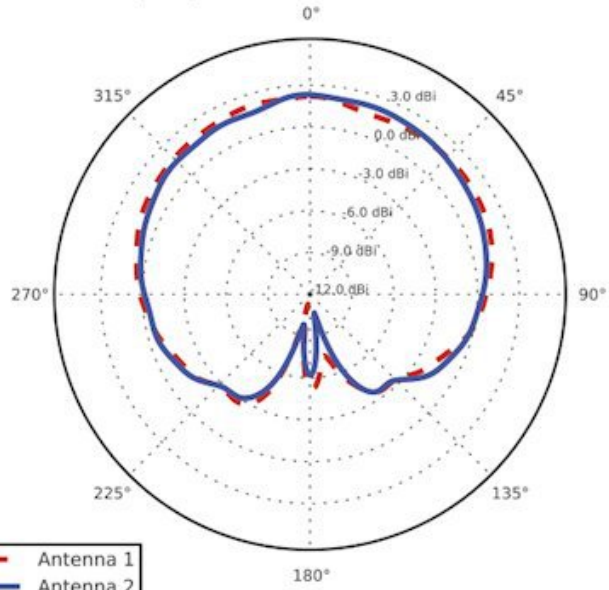

Frequency: 2133 MHz. Peak Gain: 1.46 dBi.

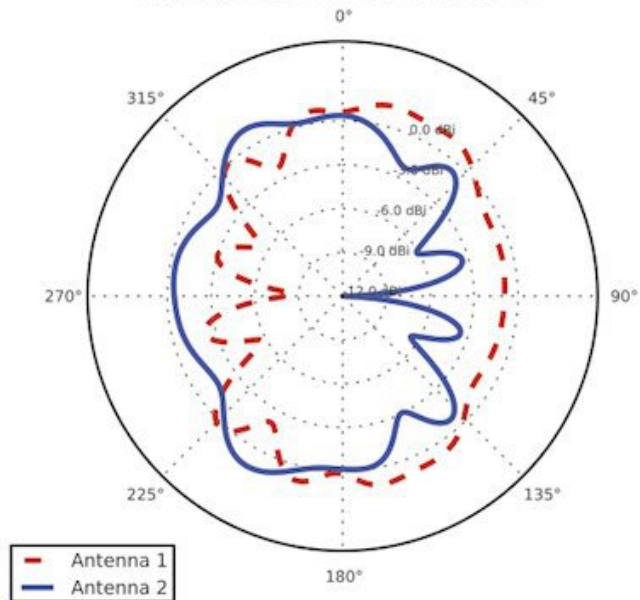

Safety Instructions

Translated versions of the following safety warnings are provided in the Regulatory Compliance and Safety Information document for this product, located on Cisco.com.



Warning **Statement 1071**—Warning Definition

Warning	<p>IMPORTANT SAFETY INSTRUCTIONS</p> <p>This warning symbol means danger. You are in a situation that could cause bodily injury. Before you work on any equipment, be aware of the hazards involved with electrical circuitry and be familiar with standard practices for preventing accidents. Use the statement number provided at the end of each warning to locate its translation in the translated safety warnings that accompanied this device.</p> <p>SAVE THESE INSTRUCTIONS</p>
Attention	<p>IMPORTANTES INFORMATIONS DE SÉCURITÉ</p> <p>Ce symbole d'avertissement indique un danger. Vous vous trouvez dans une situation pouvant entraîner des blessures ou des dommages corporels. Avant de travailler sur un équipement, soyez conscient des dangers liés aux circuits électriques et familiarisez-vous avec les procédures couramment utilisées pour éviter les accidents. Pour prendre connaissance des traductions des avertissements figurant dans les consignes de sécurité traduites qui accompagnent cet appareil, référez-vous au numéro de l'instruction situé à la fin de chaque avertissement.</p> <p>CONSERVEZ CES INFORMATIONS</p>



Warning **Statement 1004**—Installation Instructions

Warning	Read the installation instructions before connecting the system to the power source.
Attention	Avant de brancher le système sur la source d'alimentation, consulter les directives d'installation.



Warning **Statement 1074**—Comply with Local and National Electrical Codes

Warning	Installation of the equipment must comply with local and national electrical codes.
Attention	L'équipement doit être installé conformément aux normes électriques nationales et locales.

**Warning****Statement 1005—Circuit Breaker**

Warning	This product relies on the buildings installation for short-circuit (overcurrent) protection. Ensure that the protective device is rated not greater than: 10-15A, 100-240VAC
Attention	Pour ce qui est de la protection contre les courts-circuits (surtension), ce produit dépend de l'installation électrique du local. Vérifiez que le courant nominal du dispositif de protection n'est pas supérieur à: 10-15A, 100-240VAC

**Warning****Statement 332—Antenna Installation Warning**

Warning	In order to comply with FCC radio frequency (RF) exposure limits, antennas should be located at a minimum of 7.9 inches (20 cm) or more from the body of all persons.
Attention	Pour se conformer aux limites d'exposition à la fréquence radio préconisées par la FCC (Federal Communications Commission), les antennes doivent se situer à un minimum de 20 cm de toute personne.

**Warning****Statement 12—Power Supply Disconnection Warning**

Warning	Before working on a chassis or working near power supplies, unplug the power cord on AC units; disconnect the power at the circuit breaker on DC units.
Attention	Avant de travailler sur un châssis ou à proximité d'une alimentation électrique, débrancher le cordon d'alimentation des unités en courant alternatif ; couper l'alimentation des unités en courant continu au niveau du disjoncteur.

**Warning****Statement 2017**—Class A Notice for FCC

Modifying the equipment without Cisco's authorization may result in the equipment no longer complying with FCC requirements for Class A digital devices. In that event, your right to use the equipment may be limited by FCC regulations, and you may be required to correct any interference to radio or television communications at your own expense.

This equipment has been tested and found to comply with the limits for a Class A digital device, pursuant to Part 15 of the FCC Rules. These limits are designed to provide reasonable protection against harmful interference when the equipment is operated in a commercial environment. This equipment generates, uses, and can radiate radio frequency energy and, if not installed and used in accordance with the instruction manual, may cause harmful interference to radio communications. Operation of this equipment in a residential area is likely to cause harmful interference in which case users will be required to correct the interference at their own expense.

**Caution**

Caution	The fasteners you use to mount the unit on a ceiling must be capable of maintaining a minimum pullout force of 20 lbs (9 kg) and must use all 4 indented holes on the mounting bracket.
Mise en garde	Les attaches que vous utilisez pour installer le châssis au plafond doivent être capables de résister à une force d'arrachement minimale de 9 kg (20 lb) et doivent utiliser les quatre orifices de montage prévus sur le support de montage.

**Caution**

Caution	This product and all interconnected equipment must be installed indoors within the same building, including the associated LAN connections as defined by Environment A of the IEEE 802.af Standard.
Mise en garde	Conformément à la définition de l'environnement A de la norme IEEE 802.af, ce produit et tout l'équipement interconnecté, y compris les connexions LAN associées, doivent être installés à l'intérieur d'un même bâtiment.

**Note****Statement 287**—Declaration of Conformity to R&TTE Directive 1999/5/EC for the European Community, Switzerland, Norway, Iceland and Liechtenstein

This equipment is in compliance with the essential requirements and other relevant provisions of Directive 1999/5/EC.



Note This product is suitable for operation in a building's environmental air space, such as above suspended ceilings, in accordance with Section 300-22(C) of the National Electrical Code (NEC) and Sections 2-128, 12-010(3) and 12-100 of the Canadian Electrical Code, Part 1, C22.1.

Peut être utilisé dans des gaines transportant de l'air traité, conformément à la section 300-22(C) du National Electrical Code et aux articles 21-128, 12-010(3) et 12-100 du Code Canadien de l'électricité, Première partie, CSA C22.1.



Note This Class [A/B] digital apparatus complies with Canadian ICES-003.

Cet appareil numérique de la classe [A/B] est conforme à la norme NMB-003 du Canada.



Note **Statement 8007**—CE Mark for Class-II Radio Equipment



Note Use only with listed ITE equipment.

If you require assistance installing or operating your small cell, contact customer support.

For warranty information, refer to: <http://www.cisco-servicefinder.com/WarrantyFinder.aspx>

Cisco and the Cisco logo are trademarks or registered trademarks of Cisco and/or its affiliates in the U.S. and other countries. To view a list of Cisco trademarks, go to this URL: <http://www.cisco.com/go/trademarks>. Third-party trademarks mentioned are the property of their respective owners. The use of the word partner does not imply a partnership relationship between Cisco and any other company. (1110R)

© 2015 Cisco Systems, Inc. All rights reserved.



Americas Headquarters
Cisco Systems, Inc.
San Jose, CA 95134-1706
USA

Asia Pacific Headquarters
Cisco Systems (USA) Pte. Ltd.
Singapore

Europe Headquarters
Cisco Systems International BV
Amsterdam, The Netherlands

Cisco has more than 200 offices worldwide. Addresses, phone numbers, and fax numbers are listed on the Cisco Website at www.cisco.com/go/offices.