



TEST REPORT

FCC ID.	Y44-XH120	
Test Report No.	TCT220303E018	
Date of issue	Aug. 18, 2022	
Testing laboratory	SHENZHEN TONGCE TESTING LAB	
Testing location/ address:	2101 & 2201, Zhenchang Factory Renshan Industrial Zone, Fuhai Subdistrict, Bao'an District, Shenzhen, Guangdong, 518103, People's Republic of China	
Applicant's name	STONEX SRL	
Address	via dei Mille 4, 20900 Monza-MB, Italy	
Manufacturer's name ...	Guangzhou Situoli Surveying and Mapping Technology Co., Ltd.	
Address	Room 601, Building C, No. 7, Caipin Road, Luogang Science City, Huangpu District Guangzhou Guangdong Province 510663, China	
Standard(s)	FCC CFR Title 47 Part 15 Subpart C Section 15.247 FCC KDB 558074 D01 15.247 Meas Guidance v05r02 ANSI C63.10:2013	
Product Name	Handheld Laser Scanner	
Trade Mark	Stonex	
Model/Type reference	XH120	
Rating(s)	Refer to EUT description of page 3	
Date of receipt of test item	Mar. 03, 2022	
Date (s) of performance of test	Mar. 03, 2022 ~ Aug. 18, 2022	
Tested by (+signature) ...	Rleo LIU	
Check by (+signature)	Beryl ZHAO	
Approved by (+signature):	Tomsin	



General disclaimer:

This report shall not be reproduced except in full, without the written approval of SHENZHEN TONGCE TESTING LAB. This document may be altered or revised by SHENZHEN TONGCE TESTING LAB personnel only, and shall be noted in the revision section of the document. The test results in the report only apply to the tested sample.

Table of Contents

1. General Product Information	3
1.1. EUT description	3
1.2. Model(s) list.....	3
1.3. Operation Frequency	4
2. Test Result Summary	5
3. General Information.....	6
3.1. Test environment and mode.....	6
3.2. Description of Support Units.....	7
4. Facilities and Accreditations	8
4.1. Facilities	8
4.2. Location	8
4.3. Measurement Uncertainty.....	8
5. Test Results and Measurement Data	9
5.1. Antenna requirement	9
5.2. Conducted Emission.....	10
5.3. Maximum Conducted (Average) Output Power	14
5.4. Emission Bandwidth	16
5.5. Power Spectral Density.....	17
5.6. Conducted Band Edge and Spurious Emission Measurement	19
5.7. Radiated Spurious Emission Measurement.....	21
Appendix A: Test Result of Conducted Test	
Appendix B: Photographs of Test Setup	
Appendix C: Photographs of EUT	

1. General Product Information

1.1. EUT description

Product Name:	Handheld Laser Scanner
Model/Type reference:	XH120
Sample Number:	TCT220303E018-0101
Operation Frequency	2412MHz~2462MHz (802.11b/802.11g/802.11n(HT20)) 2422MHz~2452MHz (802.11n(HT40))
Channel Separation:	5MHz
Number of Channel	11 for 802.11b/802.11g/802.11n(HT20) 7 for 802.11n(HT40)
Modulation Technology	802.11b: Direct Sequence Spread Spectrum (DSSS) 802.11g/802.11n: Orthogonal Frequency Division Multiplexing(OFDM)
Data speed	802.11b: 1Mbps, 2Mbps, 5.5Mbps, 11Mbps 802.11g: 6Mbps, 9Mbps, 12Mbps, 18Mbps, 24Mbps, 36Mbps, 48Mbps, 54Mbps 802.11n: Up to 300Mbps
Antenna Type:	Antenna 0:External Antenna Antenna 1: Ceramic Antenna
Antenna Gain:	Antenna 0: 2.3dBi Antenna 1: 5dBi
Rating(s):	Adapter Information: MODEL: IN2C180 INPUT: AC 100-240V, 50/60Hz, 2.5A OUTPUT(Total): DC 26.1V, 6.9A OUTPUT1: DC 26.1V, 5.0A, 130.5W OUTPUT2: DC 26.1V, 6.9A, 180.0W Rechargeable Li-ion Battery DC 22.8V

Note: The antenna gain listed in this report is provided by applicant, and the test laboratory is not responsible for this parameter.

1.2. Model(s) list

None.

1.3. Operation Frequency

For 802.11b/g/n(HT20)

Channel	Frequency	Channel	Frequency	Channel	Frequency	Channel	Frequency
1	2412MHz	4	2427MHz	7	2442MHz	10	2457MHz
2	2417MHz	5	2432MHz	8	2447MHz	11	2462MHz
3	2422MHz	6	2437MHz	9	2452MHz	--	--

For 802.11n(HT40)

Channel	Frequency	Channel	Frequency	Channel	Frequency	Channel	Frequency
--	--	4	2427MHz	7	2442MHz	--	--
--	--	5	2432MHz	8	2447MHz	--	--
3	2422MHz	6	2437MHz	9	2452MHz		

Note:

In section 15.31(m), regards to the operating frequency range over 10 MHz, the Lowest frequency, the middle frequency, and the highest frequency of channel were selected to perform the test, and the selected channel see below:

802.11b/802.11g/802.11n(HT20)

Channel	Frequency
The lowest channel	2412MHz
The middle channel	2437MHz
The Highest channel	2462MHz

802.11n(HT40)

Channel	Frequency
The lowest channel	2422MHz
The middle channel	2437MHz
The Highest channel	2452MHz

2. Test Result Summary

Requirement	CFR 47 Section	Result
Antenna requirement	§15.203/§15.247 (c)	PASS
AC Power Line Conducted Emission	§15.207	PASS
Conducted Output Power	§15.247 (b)(3)	PASS
6dB Emission Bandwidth	§15.247 (a)(2)	PASS
Power Spectral Density	§15.247 (e)	PASS
Band Edge	§15.247(d)	PASS
Spurious Emission	§15.205/§15.209	PASS

Note:

1. PASS: Test item meets the requirement.
2. Fail: Test item does not meet the requirement.
3. N/A: Test case does not apply to the test object.
4. The test result judgment is decided by the limit of test standard.

3. General Information

3.1. Test environment and mode

Operating Environment:		
Condition	Conducted Emission	Radiated Emission
Temperature:	25 °C	25.3 °C
Humidity:	55 % RH	54 % RH
Atmospheric Pressure:	1010 mbar	1010 mbar
Test Software:		
Software Information:	Command	
Power Level:	Default	
Test Mode:		
Engineering mode:	Keep the EUT in continuous transmitting by select channel and modulations with Fully-charged battery	
<p>The sample was placed 0.8m & 1.5m for the measurement below & above 1GHz above the ground plane of 3m chamber. Measurements in both horizontal and vertical polarities were performed. During the test, each emission was maximized by: having the EUT continuously working, investigated all operating modes, rotated about all 3 axis (X, Y & Z) and considered typical configuration to obtain worst position, manipulating interconnecting cables, rotating the turntable, varying antenna height from 1m to 4m in both horizontal and vertical polarizations. The emissions worst-case(Z axis) are shown in Test Results of the following pages.</p>		

We have verified the construction and function in typical operation. All the test modes were carried out with the EUT in transmitting operation, which was shown in this test report and defined as follows:

Per-scan all kind of data rate in lowest channel, and found the follow list which it was worst case.

Mode	Data rate
802.11b	1Mbps
802.11g	6Mbps
802.11n(HT20)	6.5Mbps
802.11n(HT40)	13.5Mbps

3.2. Description of Support Units

The EUT has been tested as an independent unit together with other necessary accessories or support units. The following support units or accessories were used to form a representative test configuration during the tests.

Equipment	Model No.	Serial No.	FCC ID	Trade Name
/	/	/	/	/

Note:

1. All the equipment/cables were placed in the worst-case configuration to maximize the emission during the test.
2. Grounding was established in accordance with the manufacturer's requirements and conditions for the intended use.
3. For conducted measurements (Output Power, 6dB Emission Bandwidth, Power Spectral Density, Spurious Emissions), the antenna of EUT is connected to the test equipment via temporary antenna connector, the antenna connector is soldered on the antenna port of EUT, and the temporary antenna connector is listed in the Test Instruments.

4. Facilities and Accreditations

4.1. Facilities

The test facility is recognized, certified, or accredited by the following organizations:

- FCC - Registration No.: 645098

SHENZHEN TONGCE TESTING LAB

Designation Number: CN1205

The testing lab has been registered and fully described in a report with the (FCC) Federal Communications Commission. The acceptance letter from the FCC is maintained in our files.

- IC - Registration No.: 10668A-1

SHENZHEN TONGCE TESTING LAB

CAB identifier: CN0031

The testing lab has been registered by Certification and Engineering Bureau of Industry Canada for radio equipment testing.

4.2. Location

SHENZHEN TONGCE TESTING LAB

Address: 2101 & 2201, Zhenchang Factory Renshan Industrial Zone, Fuhai Subdistrict, Bao'an District, Shenzhen, Guangdong, 518103, People's Republic of China

TEL: +86-755-27673339

4.3. Measurement Uncertainty

The reported uncertainty of measurement $y \pm U$, where expanded uncertainty U is based on a standard uncertainty multiplied by a coverage factor of $k=2$, providing a level of confidence of approximately 95 %.

No.	Item	MU
1	Conducted Emission	± 3.10 dB
2	RF power, conducted	± 0.12 dB
3	Spurious emissions, conducted	± 0.11 dB
4	All emissions, radiated(<1 GHz)	± 4.56 dB
5	All emissions, radiated(1 GHz - 18 GHz)	± 4.22 dB
6	All emissions, radiated(18 GHz- 40 GHz)	± 4.36 dB

5. Test Results and Measurement Data

5.1. Antenna requirement

Standard requirement: FCC Part15 C Section 15.203 /247(c)

15.203 requirement:

An intentional radiator shall be designed to ensure that no antenna other than that furnished by the responsible party shall be used with the device. The use of a permanently attached antenna or of an antenna that uses a unique coupling to the intentional radiator, the manufacturer may design the unit so that a broken antenna can be replaced by the user, but the use of a standard antenna jack or electrical connector is prohibited.

15.247(c) (1)(i) requirement:

(i) Systems operating in the 2400-2483.5 MHz band that is used exclusively for fixed. Point-to-point operations may employ transmitting antennas with directional gain greater than 6dBi provided the maximum conducted output power of the intentional radiator is reduced by 1 dB for every 3 dB that the directional gain of the antenna exceeds 6dBi.

E.U.T Antenna:

The WIFI antenna 0 is external antenna, antenna 1 is ceramic antenna, both of them are permanently attached and unique coupling to the intentional radiator.

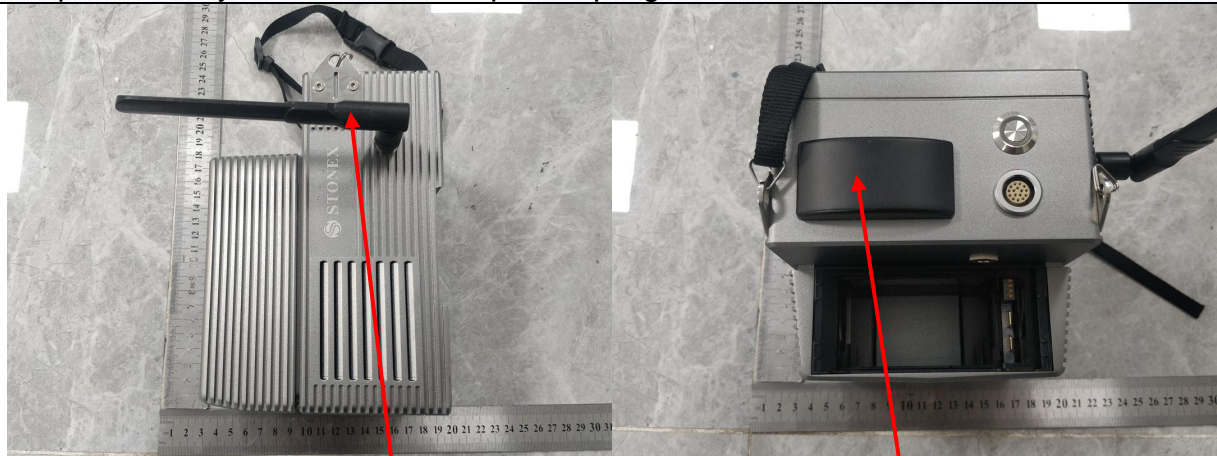

Antenna 0

Antenna 1

Refer to KDB 662911 D01 Multiple Transmitter Output v02r01:

Unequal antenna gains, with equal transmit powers, if transmit signals are correlated, then Directional gain = $10\log[(10^{2.3/20} + 10^{5/20})^2/2] = 6.76\text{dBi}$

Note: Above directional gain not applicable to power measurements.

5.2. Conducted Emission

5.2.1. Test Specification

Test Requirement:	FCC Part15 C Section 15.207														
Test Method:	ANSI C63.10:2013														
Frequency Range:	150 kHz to 30 MHz														
Receiver setup:	RBW=9 kHz, VBW=30 kHz, Sweep time=auto														
Limits:	<table border="1"> <thead> <tr> <th rowspan="2">Frequency range (MHz)</th> <th colspan="2">Limit (dBuV)</th> </tr> <tr> <th>Quasi-peak</th> <th>Average</th> </tr> </thead> <tbody> <tr> <td>0.15-0.5</td> <td>66 to 56*</td> <td>56 to 46*</td> </tr> <tr> <td>0.5-5</td> <td>56</td> <td>46</td> </tr> <tr> <td>5-30</td> <td>60</td> <td>50</td> </tr> </tbody> </table>	Frequency range (MHz)	Limit (dBuV)		Quasi-peak	Average	0.15-0.5	66 to 56*	56 to 46*	0.5-5	56	46	5-30	60	50
Frequency range (MHz)	Limit (dBuV)														
	Quasi-peak	Average													
0.15-0.5	66 to 56*	56 to 46*													
0.5-5	56	46													
5-30	60	50													
Test Setup:	<p><i>Remark</i> E.U.T: Equipment Under Test LISN: Line Impedance Stabilization Network Test table height=0.8m</p>														
Test Mode:	Charging + Transmitting Mode														
Test Procedure:	<ol style="list-style-type: none"> The E.U.T is connected to the main power through a line impedance stabilization network (L.I.S.N.). This provides a 50ohm/50uH coupling impedance for the measuring equipment. The peripheral devices are also connected to the main power through a LISN that provides a 50ohm/50uH coupling impedance with 50ohm termination. (Please refer to the block diagram of the test setup and photographs). Both sides of A.C. line are checked for maximum conducted interference. In order to find the maximum emission, the relative positions of equipment and all of the interface cables must be changed according to ANSI C63.10: 2013 on conducted measurement. 														
Test Result:	PASS														

5.2.2. Test Instruments

Conducted Emission Shielding Room Test Site (843)				
Equipment	Manufacturer	Model	Serial Number	Calibration Due
EMI Test Receiver	R&S	ESCI3	100898	Jul. 03, 2023
Line Impedance Stabilisation Network(LISN)	Schwarzbeck	NSLK 8126	8126453	Feb. 24, 2023
Line-5	TCT	CE-05	/	Jul. 03, 2023
EMI Test Software	Shurple Technology	EZ-EMC	/	/

5.2.3. Test data

Please refer to following diagram for individual

Conducted Emission on Line Terminal of the power line (150 kHz to 30MHz)

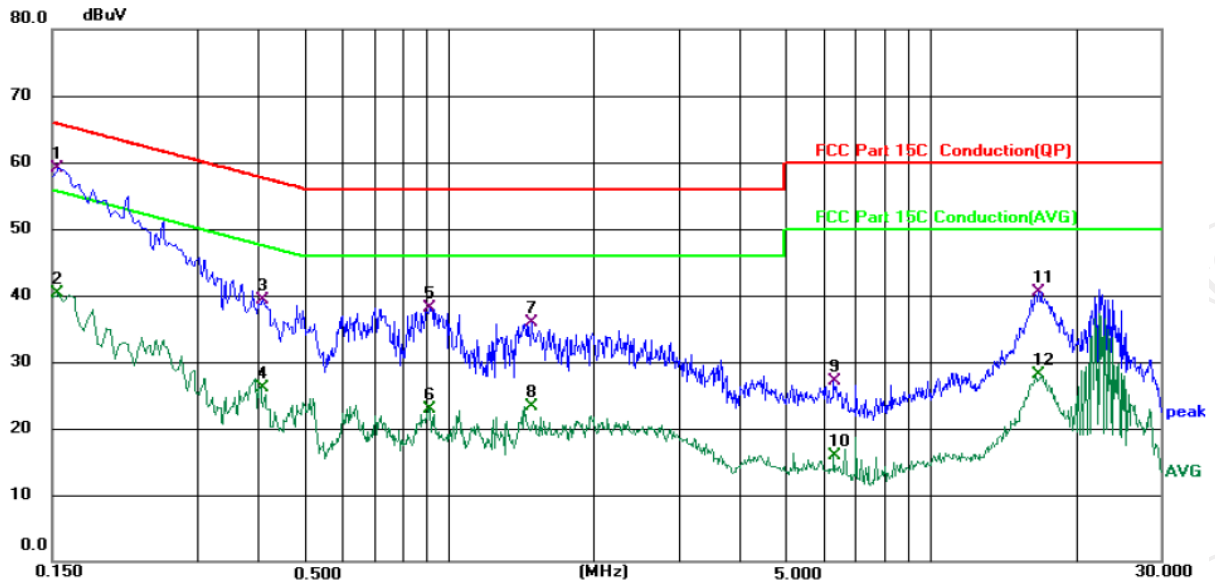

Site 844 Shielding Room Phase: **L1** Temperature: 25 (°C) Humidity: 55 %

Limit: FCC Part 15C Conduction(QP) Power: AC 120 V/60 Hz

No.	Mk.	Freq.	Reading Level	Correct Factor	Measurement	Limit	Over	Detector	Comment
		MHz	dBuV	dB	dBuV	dBuV	dB		
1	*	0.1539	49.51	9.59	59.10	65.79	-6.69	QP	
2		0.1539	30.69	9.59	40.28	55.79	-15.51	AVG	
3		0.4100	30.08	9.23	39.31	57.65	-18.34	QP	
4		0.4100	16.84	9.23	26.07	47.65	-21.58	AVG	
5		0.9140	28.82	9.28	38.10	56.00	-17.90	QP	
6		0.9140	13.71	9.28	22.99	46.00	-23.01	AVG	
7		1.4860	26.45	9.37	35.82	56.00	-20.18	QP	
8		1.4860	14.01	9.37	23.38	46.00	-22.62	AVG	
9		6.3020	17.53	9.56	27.09	60.00	-32.91	QP	
10		6.3020	6.25	9.56	15.81	50.00	-34.19	AVG	
11		16.8100	30.86	9.70	40.56	60.00	-19.44	QP	
12		16.8100	18.41	9.70	28.11	50.00	-21.89	AVG	

Note:

Freq. = Emission frequency in MHz

Reading level (dBuV) = Receiver reading

Corr. Factor (dB) = LISN factor + Cable loss

Measurement (dBuV) = Reading level (dBuV) + Corr. Factor (dB)

Limit (dBuV) = Limit stated in standard

Margin (dB) = Measurement (dBuV) – Limits (dBuV)

Q.P. =Quasi-Peak

AVG =average

* is meaning the worst frequency has been tested in the frequency range 150 kHz to 30MHz.

Conducted Emission on Neutral Terminal of the power line (150 kHz to 30MHz)

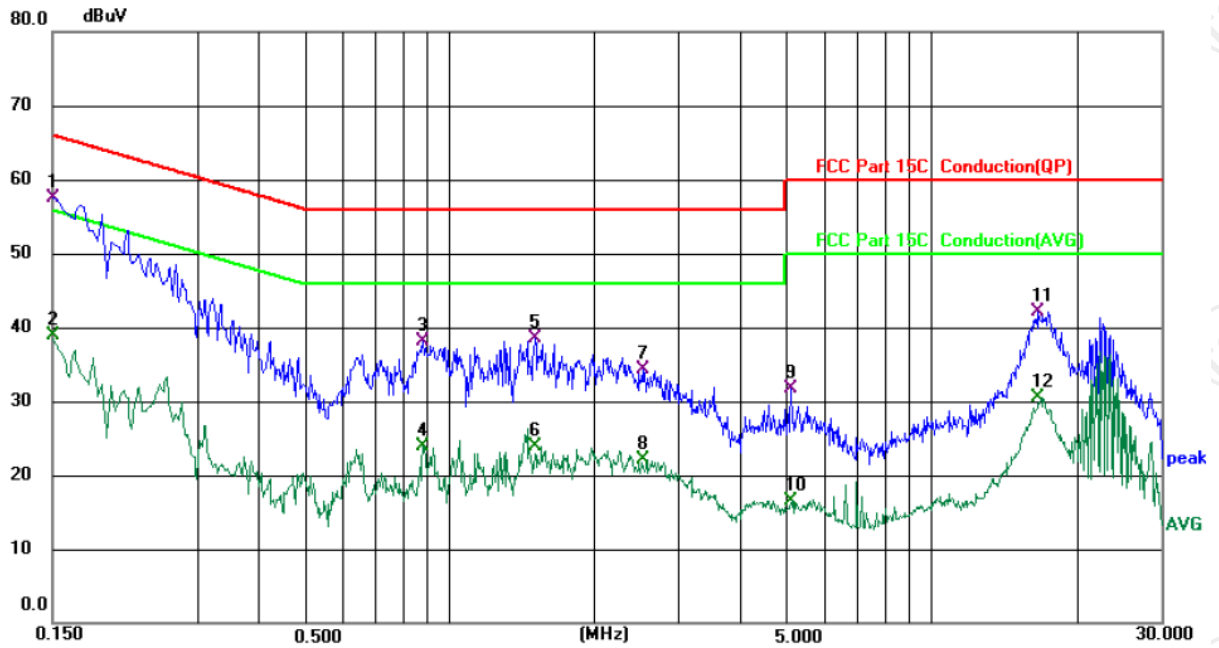

Site 844 Shielding Room Phase: *N* Temperature: 25 (°C) Humidity: 55 %

Limit: FCC Part 15C Conduction(QP) Power: AC 120 V/60 Hz

No.	Mk.	Freq.	Reading Level	Correct Factor	Measurement	Limit	Over	Detector	Comment
		MHz	dBuV	dB	dBuV	dBuV	dB		
1	*	0.1500	47.92	9.61	57.53	66.00	-8.47	QP	
2		0.1500	29.22	9.61	38.83	56.00	-17.17	AVG	
3		0.8820	28.92	9.27	38.19	56.00	-17.81	QP	
4		0.8820	14.69	9.27	23.96	46.00	-22.04	AVG	
5		1.5100	29.20	9.35	38.55	56.00	-17.45	QP	
6		1.5100	14.61	9.35	23.96	46.00	-22.04	AVG	
7		2.5178	24.93	9.41	34.34	56.00	-21.66	QP	
8		2.5178	12.78	9.41	22.19	46.00	-23.81	AVG	
9		5.1340	22.13	9.48	31.61	60.00	-28.39	QP	
10		5.1340	7.07	9.48	16.55	50.00	-33.45	AVG	
11		16.7179	32.38	9.70	42.08	60.00	-17.92	QP	
12		16.7179	20.73	9.70	30.43	50.00	-19.57	AVG	

Note:

Freq. = Emission frequency in MHz

Reading level (dBuV) = Receiver reading

Corr. Factor (dB) = LISN factor + Cable loss

Measurement (dBuV) = Reading level (dBuV) + Corr. Factor (dB)

Limit (dBuV) = Limit stated in standard

Margin (dB) = Measurement (dBuV) – Limits (dBuV)

Q.P. =Quasi-Peak

AVG =average

* is meaning the worst frequency has been tested in the frequency range 150 kHz to 30MHz.

5.3. Maximum Conducted (Average) Output Power

5.3.1. Test Specification

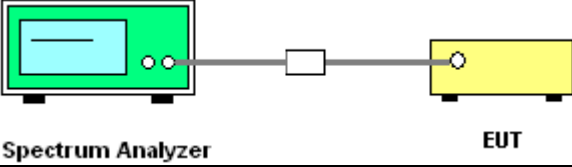
Test Requirement:	FCC Part15 C Section 15.247 (b)(3)
Test Method:	KDB 558074 D01 v05r02, KDB662911 D01 Multiple Transmitter Output v02r01
Limit:	30dBm
Test Setup:	 <p>The diagram shows a Spectrum Analyzer (green box) connected to an EUT (yellow box) via a white attenuator box. The connection is made using cables.</p>
Test Mode:	Transmitting mode with modulation
Test Procedure:	<ol style="list-style-type: none"> 1. The RF output of EUT was connected to the spectrum analyzer by RF cable and attenuator. The path loss was compensated to the results for each measurement. 2. Set to the maximum power setting and enable the EUT transmit continuously. 3. Measure the conducted output power and record the results in the test report.
Test Result:	PASS

5.3.2. Test Instruments

Name	Manufacturer	Model No.	Serial Number	Calibration Due
Spectrum Analyzer	Agilent	N9020A	MY49100619	Jul. 04, 2023
Combiner Box	Ascentest	AT890-RFB	/	/

5.3.3. Test Data

Configuration IEEE 802.11b/ Antenna 0+Antenna 1				
Test channel	Maximum Conducted (AVG) Output Power (dBm)		Limit (dBm)	Result
	Antenna 0	Antenna 1		
Lowest	16.49	15.01	30	PASS
Middle	16.52	14.86	30	PASS
Highest	16.87	14.72	30	PASS

Configuration IEEE 802.11g/ Antenna 0+Antenna 1				
Test channel	Maximum Conducted (AVG) Output Power (dBm)		Limit (dBm)	Result
	Antenna 0	Antenna 1		
Lowest	14.57	15.17	30	PASS
Middle	14.18	14.69	30	PASS
Highest	14.23	14.76	30	PASS

Configuration IEEE 802.11n(HT20)/ Antenna 0+Antenna 1					
Test channel	Maximum Conducted (AVG) Output Power (dBm)			Limit (dBm)	Result
	Antenna 0	Antenna 1	Total		
Lowest	14.35	12.97	16.72	29.24	PASS
Middle	14.24	12.71	16.55	29.24	PASS
Highest	14.36	12.71	16.62	29.24	PASS

Configuration IEEE 802.11n(HT40)/ Antenna 0+Antenna 1					
Test channel	Maximum Conducted (AVG) Output Power (dBm)			Limit (dBm)	Result
	Antenna 0	Antenna 1	Total		
Lowest	13.72	12.17	16.02	29.24	PASS
Middle	13.31	12.06	15.74	29.24	PASS
Highest	13.45	11.79	15.71	29.24	PASS

Note:

Refer to KDB 662911 D01 Multiple Transmitter Output v02r01:
 For power measurements on IEEE 802.11 devices,
 Array Gain = 0 dB (i.e., no array gain) for $N_{ANT} \leq 4$;
 Array Gain = 0 dB (i.e., no array gain) for channel widths ≥ 40 MHz for any N_{ANT} ;
 Array Gain = $5 \log(N_{ANT}/N_{SS})$ dB or 3 dB, whichever is less, for 20-MHz channel widths with $N_{ANT} \geq 5$.
 Because $N_{ANT}=2$, so Array Gain = 0, Directional gain = $G_{ANT} + \text{Array Gain} = 6.76\text{dBi} > 6\text{dBi}$, power limit = $30 - (6.76 - 6) = 29.24\text{dBm}$.

5.4. Emission Bandwidth

5.4.1. Test Specification

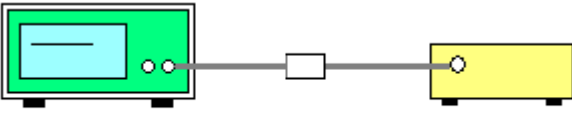
Test Requirement:	FCC Part15 C Section 15.247 (a)(2)
Test Method:	FCC KDB 558074 D01 15.247 Meas Guidance v05r02
Limit:	>500kHz
Test Setup:	 <p style="text-align: center;">Spectrum Analyzer EUT</p>
Test Mode:	Transmitting mode with modulation
Test Procedure:	<ol style="list-style-type: none"> 1. Set to the maximum power setting and enable the EUT transmit continuously. 2. Make the measurement with the spectrum analyzer's resolution bandwidth (RBW) = 100 kHz. Set the Video bandwidth (VBW) = 300 kHz. In order to make an accurate measurement. The 6dB bandwidth must be greater than 500 kHz. 3. Measure and record the results in the test report.
Test Result:	PASS

5.4.2. Test Instruments

Name	Manufacturer	Model No.	Serial Number	Calibration Due
Spectrum Analyzer	Agilent	N9020A	MY49100619	Jul. 04, 2023
Combiner Box	Ascentest	AT890-RFB	/	/

5.5. Power Spectral Density

5.5.1. Test Specification

Test Requirement:	FCC Part15 C Section 15.247 (e)
Test Method:	FCC KDB 558074 D01 15.247 Meas Guidance v05r02
Limit:	The peak power spectral density shall not be greater than 8dBm in any 3kHz band at any time interval of continuous transmission.
Test Setup:	 <p style="text-align: center;">Spectrum Analyzer EUT</p>
Test Mode:	Transmitting mode with modulation
Test Procedure:	<ol style="list-style-type: none"> 1. The RF output of EUT was connected to the spectrum analyzer by RF cable and attenuator. The path loss was compensated to the results for each measurement. 2. Set to the maximum power setting and enable the EUT transmit continuously. 3. Make the measurement with the spectrum analyzer's resolution bandwidth (RBW): $3 \text{ kHz} \leq \text{RBW} \leq 100 \text{ kHz}$. Video bandwidth $\text{VBW} \geq 3 \times \text{RBW}$. Set the span to at least 1.5 times the OBW. 4. Detector = RMS, Sweep time = auto couple. 5. Employ trace averaging (RMS) mode over a minimum of 100 traces. Use the peak marker function to determine the maximum power level. 6. Measure and record the results in the test report.
Test Result:	PASS

5.5.2. Test Instruments

Name	Manufacturer	Model No.	Serial Number	Calibration Due
Spectrum Analyzer	Agilent	N9020A	MY49100619	Jul. 04, 2023
Combiner Box	Ascentest	AT890-RFB	/	/

5.5.3. Test data

Configuration IEEE 802.11b/ Antenna 0, Antenna 1				
Test channel	AVG Power Spectral Density (dBm/3kHz)		Limit (dBm/3kHz)	Result
	Antenna 0	Antenna 1		
Lowest	-14.42	-16.18	8	PASS
Middle	-14.94	-16.46	8	PASS
Highest	-14.34	-16.13	8	PASS

Configuration IEEE 802.11g/ Antenna 0, Antenna 1				
Test channel	AVG Power Spectral Density (dBm/3kHz)		Limit (dBm/3kHz)	Result
	Antenna 0	Antenna 1		
Lowest	-18.88	-16.22	8	PASS
Middle	-19.22	-16.67	8	PASS
Highest	-18.98	-16.52	8	PASS

Configuration IEEE 802.11n(HT20)/ Antenna 0, Antenna 1					
Test channel	AVG Power Spectral Density (dBm/3kHz)			Limit (dBm/3kHz)	Result
	Antenna 0	Antenna 1	Total		
Lowest	-19.18	-20.64	-16.84	7.24	PASS
Middle	-19.03	-20.49	-16.69	7.24	PASS
Highest	-19.38	-21.02	-17.11	7.24	PASS

Configuration IEEE 802.11n(HT40)/ Antenna 0, Antenna 1					
Test channel	AVG Power Spectral Density (dBm/3kHz)			Limit (dBm/3kHz)	Result
	Antenna 0	Antenna 1	Total		
Lowest	-22.91	-24.52	-20.63	7.24	PASS
Middle	-23.32	-24.50	-20.86	7.24	PASS
Highest	-23.31	-24.55	-20.88	7.24	PASS

Note:

The PSD result have added a Correction Factor: $10\log(3\text{KHz}/30\text{KHz})$, cause a 30KHZ RBW has used in measurement.

Directional gain = $10 \log[(10^{G1/20} + 10^{G2/20} + \dots + 10^{GN/20})^2 / N_{ANT}]$ dBi=6.76 >6, So limit=8-(6.76-6)=7.24dBm/3kHz

Refer to Appendix A: Test Result of Conducted Test

5.6. Conducted Band Edge and Spurious Emission Measurement

5.6.1. Test Specification

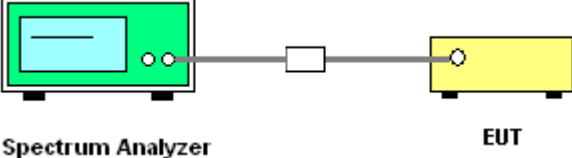
Test Requirement:	FCC Part15 C Section 15.247 (d)
Test Method:	FCC KDB 558074 D01 15.247 Meas Guidance v05r02
Limit:	In any 100 kHz bandwidth outside of the authorized frequency band, the emissions which fall in the non-restricted bands shall be attenuated at least 20 dB / 30dB relative to the maximum PSD level in 100 kHz by RF conducted measurement and radiated emissions which fall in the restricted bands, as defined in Section 15.205(a), must also comply with the radiated emission limits specified in Section 15.209(a).
Test Setup:	 <p style="text-align: center;">Spectrum Analyzer EUT</p>
Test Mode:	Transmitting mode with modulation
Test Procedure:	<ol style="list-style-type: none"> 1. The RF output of EUT was connected to the spectrum analyzer by RF cable and attenuator. The path loss was compensated to the results for each measurement. 2. Set to the maximum power setting and enable the EUT transmit continuously. 3. Set RBW = 100 kHz, VBW=300 kHz, Peak Detector. Unwanted Emissions measured in any 100 kHz bandwidth outside of the authorized frequency band shall be attenuated by at least 20 dB relative to the maximum in-band peak PSD level in 100 kHz when maximum peak conducted output power procedure is used. If the transmitter complies with the conducted power limits based on the use of RMS averaging over a time interval, the attenuation required under this paragraph shall be 30 dB instead of 20 dB per 15.247(d). 4. Measure and record the results in the test report. 5. The RF fundamental frequency should be excluded against the limit line in the operating frequency band.
Test Result:	PASS

5.6.2. Test Instruments

Name	Manufacturer	Model No.	Serial Number	Calibration Due
Spectrum Analyzer	Agilent	N9020A	MY49100619	Jul. 04, 2023
Combiner Box	Ascentest	AT890-RFB	/	/

5.7. Radiated Spurious Emission Measurement

5.7.1. Test Specification

Test Requirement:	FCC Part15 C Section 15.209																													
Test Method:	ANSI C63.10: 2013																													
Frequency Range:	9 kHz to 25 GHz																													
Measurement Distance:	3 m																													
Antenna Polarization:	Horizontal & Vertical																													
Operation mode:	Transmitting mode with modulation																													
Receiver Setup:	<table border="1"> <thead> <tr> <th>Frequency</th> <th>Detector</th> <th>RBW</th> <th>VBW</th> <th>Remark</th> </tr> </thead> <tbody> <tr> <td>9kHz- 150kHz</td> <td>Quasi-peak</td> <td>200Hz</td> <td>1kHz</td> <td>Quasi-peak Value</td> </tr> <tr> <td>150kHz- 30MHz</td> <td>Quasi-peak</td> <td>9kHz</td> <td>30kHz</td> <td>Quasi-peak Value</td> </tr> <tr> <td>30MHz-1GHz</td> <td>Quasi-peak</td> <td>120KHz</td> <td>300KHz</td> <td>Quasi-peak Value</td> </tr> <tr> <td rowspan="2">Above 1GHz</td> <td>Peak</td> <td>1MHz</td> <td>3MHz</td> <td>Peak Value</td> </tr> <tr> <td>Peak</td> <td>1MHz</td> <td>10Hz</td> <td>Average Value</td> </tr> </tbody> </table>	Frequency	Detector	RBW	VBW	Remark	9kHz- 150kHz	Quasi-peak	200Hz	1kHz	Quasi-peak Value	150kHz- 30MHz	Quasi-peak	9kHz	30kHz	Quasi-peak Value	30MHz-1GHz	Quasi-peak	120KHz	300KHz	Quasi-peak Value	Above 1GHz	Peak	1MHz	3MHz	Peak Value	Peak	1MHz	10Hz	Average Value
	Frequency	Detector	RBW	VBW	Remark																									
	9kHz- 150kHz	Quasi-peak	200Hz	1kHz	Quasi-peak Value																									
	150kHz- 30MHz	Quasi-peak	9kHz	30kHz	Quasi-peak Value																									
	30MHz-1GHz	Quasi-peak	120KHz	300KHz	Quasi-peak Value																									
Above 1GHz	Peak	1MHz	3MHz	Peak Value																										
	Peak	1MHz	10Hz	Average Value																										
Limit:	<table border="1"> <thead> <tr> <th>Frequency</th> <th>Field Strength (microvolts/meter)</th> <th>Measurement Distance (meters)</th> </tr> </thead> <tbody> <tr> <td>0.009-0.490</td> <td>2400/F(KHz)</td> <td>300</td> </tr> <tr> <td>0.490-1.705</td> <td>24000/F(KHz)</td> <td>30</td> </tr> <tr> <td>1.705-30</td> <td>30</td> <td>30</td> </tr> <tr> <td>30-88</td> <td>100</td> <td>3</td> </tr> <tr> <td>88-216</td> <td>150</td> <td>3</td> </tr> <tr> <td>216-960</td> <td>200</td> <td>3</td> </tr> <tr> <td>Above 960</td> <td>500</td> <td>3</td> </tr> </tbody> </table>	Frequency	Field Strength (microvolts/meter)	Measurement Distance (meters)	0.009-0.490	2400/F(KHz)	300	0.490-1.705	24000/F(KHz)	30	1.705-30	30	30	30-88	100	3	88-216	150	3	216-960	200	3	Above 960	500	3					
	Frequency	Field Strength (microvolts/meter)	Measurement Distance (meters)																											
	0.009-0.490	2400/F(KHz)	300																											
	0.490-1.705	24000/F(KHz)	30																											
	1.705-30	30	30																											
	30-88	100	3																											
	88-216	150	3																											
	216-960	200	3																											
	Above 960	500	3																											
	<table border="1"> <thead> <tr> <th>Frequency</th> <th>Field Strength (microvolts/meter)</th> <th>Measurement Distance (meters)</th> <th>Detector</th> </tr> </thead> <tbody> <tr> <td rowspan="2">Above 1GHz</td> <td>500</td> <td>3</td> <td>Average</td> </tr> <tr> <td>5000</td> <td>3</td> <td>Peak</td> </tr> </tbody> </table>	Frequency	Field Strength (microvolts/meter)	Measurement Distance (meters)	Detector	Above 1GHz	500	3	Average	5000	3	Peak																		
Frequency	Field Strength (microvolts/meter)	Measurement Distance (meters)	Detector																											
Above 1GHz	500	3	Average																											
	5000	3	Peak																											
Test setup:	For radiated emissions below 30MHz																													
	<p>30MHz to 1GHz</p>																													

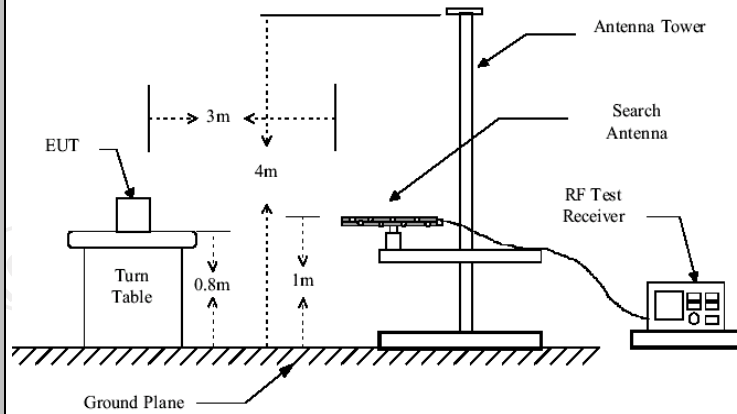

Above 1GHz

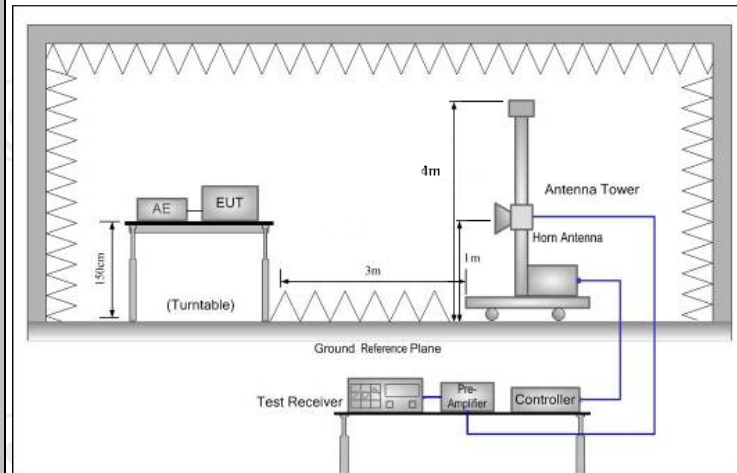

Test Procedure:

1. For the radiated emission test below 1GHz:
The EUT was placed on a turntable with 0.8 meter above ground. The EUT was set 3 meters from the interference receiving antenna, which was mounted on the top of a variable height antenna tower. The EUT was arranged to its worst case and then tune the antenna tower (from 1 m to 4 m) and turntable (from 0 degree to 360 degrees) to find the maximum reading. A pre-amp and a high PASS filter are used for the test in order to get better signal level.
- For the radiated emission test above 1GHz:
Place the measurement antenna on a turntable with 1.5 meter above ground, which is away from each area of the EUT determined to be a source of emissions at the specified measurement distance, while keeping the measurement antenna aimed at the source of emissions at each frequency of significant emissions, with polarization oriented for maximum response. The measurement antenna may have to be higher or lower than the EUT, depending on the radiation pattern of the emission and staying aimed at the emission source for receiving the maximum signal. The final measurement antenna elevation shall be that which

	<p>maximizes the emissions. The measurement antenna elevation for maximum emissions shall be restricted to a range of heights of from 1 m to 4 m above the ground or reference ground plane.</p> <p>3. Corrected Reading: Antenna Factor + Cable Loss + Read Level - Preamp Factor = Level</p> <p>4. For measurement below 1GHz, If the emission level of the EUT measured by the peak detector is 3 dB lower than the applicable limit, the peak emission level will be reported. Otherwise, the emission measurement will be repeated using the quasi-peak detector and reported.</p> <p>5. Use the following spectrum analyzer settings:</p> <ul style="list-style-type: none"> (1) Span shall wide enough to fully capture the emission being measured; (2) Set RBW=120 kHz for $f < 1$ GHz; VBW \geq RBW; Sweep = auto; Detector function = peak; Trace = max hold; (3) Set RBW = 1 MHz, VBW= 3MHz for $f > 1$ GHz for peak measurement. <p>For average measurement: VBW = 10 Hz, when duty cycle is no less than 98 percent. VBW $\geq 1/T$, when duty cycle is less than 98 percent where T is the minimum transmission duration over which the transmitter is on and is transmitting at its maximum power control level for the tested mode of operation.</p>
Test results:	PASS

5.7.2. Test Instruments

Radiated Emission Test Site (966)				
Name of Equipment	Manufacturer	Model	Serial Number	Calibration Due
EMI Test Receiver	R&S	ESIB7	100197	Jul. 03, 2023
Spectrum Analyzer	R&S	FSQ40	200061	Jul. 03, 2023
Pre-amplifier	SKET	LNPA_0118G-45	SK2021012102	Feb. 24, 2023
Pre-amplifier	SKET	LNPA_1840G-50	SK202109203500	Feb. 24, 2023
Pre-amplifier	HP	8447D	2727A05017	Jul. 03, 2023
Loop antenna	Schwarzbeck	FMZB1519B	00191	Jun. 11, 2024
Broadband Antenna	Schwarzbeck	VULB9163	340	Jul. 05, 2024
Horn Antenna	Schwarzbeck	BBHA 9120D	631	Jul. 05, 2024
Horn Antenna	Schwarzbeck	BBHA 9170	00956	Apr. 10, 2023
Antenna Mast	Keleto	RE-AM	/	/
Coaxial cable	SKET	RC-18G-N-M	/	Feb. 24, 2024
Coaxial cable	SKET	RC_40G-K-M	/	Feb. 24, 2024
EMI Test Software	Shurple Technology	EZ-EMC	/	/

5.7.3. Test Data

Please refer to following diagram for individual
Below 1GHz

Horizontal:

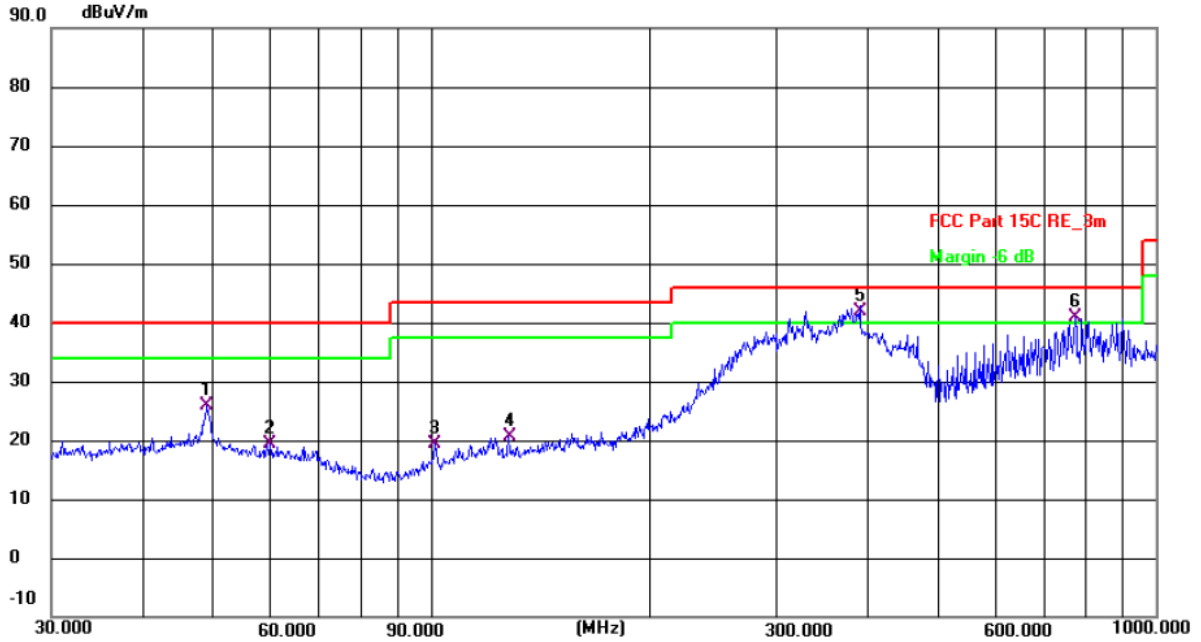

Site #1 3m Anechoic Chamber

Polarization: *Horizontal*

Temperature: 25.3(C) Humidity: 54 %

Limit: FCC Part 15C RE_3m

Power: DC 22.8 V

No.	Frequency (MHz)	Reading (dBuV)	Factor (dB/m)	Level (dBuV/m)	Limit (dBuV/m)	Margin (dB)	Detector	P/F	Remark
1	49.1865	12.07	13.78	25.85	40.00	-14.15	QP	P	
2	60.0690	6.86	12.52	19.38	40.00	-20.62	QP	P	
3	101.2883	8.75	10.51	19.26	43.50	-24.24	QP	P	
4	128.1126	8.01	12.55	20.56	43.50	-22.94	QP	P	
5 *	390.7225	25.63	16.34	41.97	46.00	-4.03	QP	P	
6 !	774.1584	17.04	23.76	40.80	46.00	-5.20	QP	P	

Vertical:

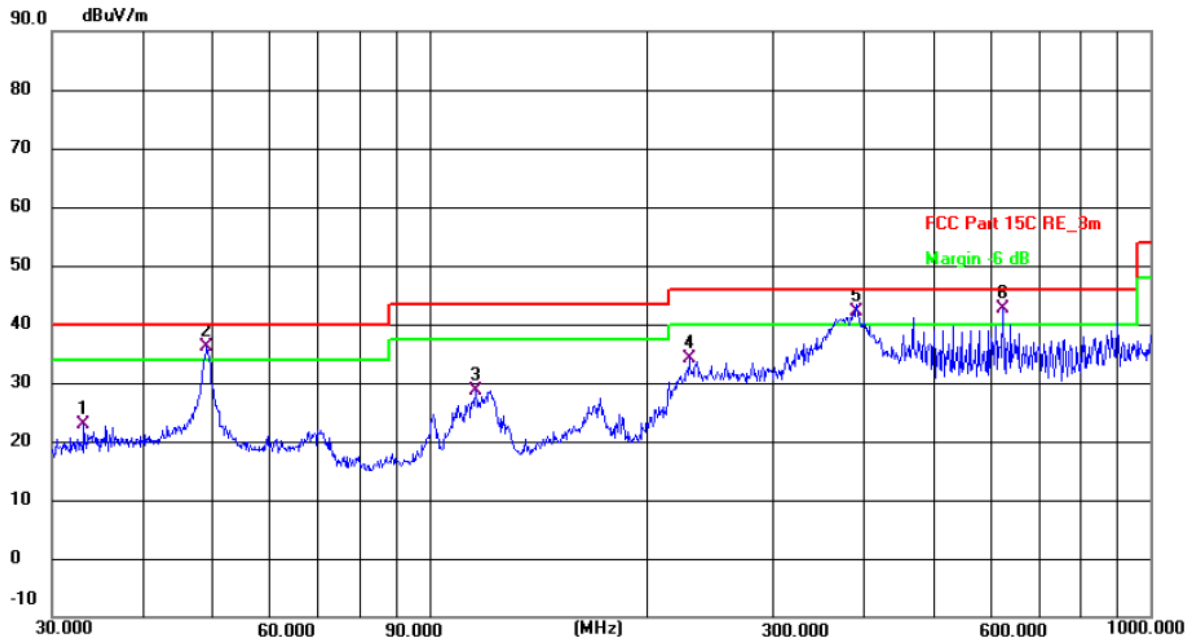

Site #1 3m Anechoic Chamber
Limit: FCC Part 15C RE_3m

Polarization: **Vertical**
Power: DC 22.8 V

Temperature: 25.3(C) Humidity: 54 %

No.	Frequency (MHz)	Reading (dBuV)	Factor (dB/m)	Level (dBuV/m)	Limit (dBuV/m)	Margin (dB)	Detector	P/F	Remark
1	33.2111	9.69	13.16	22.85	40.00	-17.15	QP	P	
2 !	49.1865	22.27	13.78	36.05	40.00	-3.95	QP	P	
3	116.1320	16.91	11.80	28.71	43.50	-14.79	QP	P	
4	229.2930	22.08	12.00	34.08	46.00	-11.92	QP	P	
5 !	390.7225	25.79	16.34	42.13	46.00	-3.87	QP	P	
6 *	625.0778	21.09	21.66	42.75	46.00	-3.25	QP	P	

- Note:**
- The low frequency, which started from 9KHz~30MHz, was pre-scanned and the result which was 20dB lower than the limit line per 15.31(o) was not reported
 - Measurements were conducted in all three channels (high, middle, low) and all modulation(802.11b, 802.11g, 802.11n(HT20), 802.11n(HT40)), and the worst case Mode (Highest channel and 802.11b transmit with antenna 0) was submitted only.
 - Freq. = Emission frequency in MHz
 Measurement (dBuV/m) = Reading level (dBuV) + Corr. Factor (dB)
 Correction Factor= Antenna Factor + Cable loss – Pre-amplifier
 Limit (dBuV/m) = Limit stated in standard
 Margin (dB) = Measurement (dBuV/m) – Limits (dBuV/m)
 * is meaning the worst frequency has been tested in the test frequency range.

Test Result of Radiated Spurious at Band edges

Lowest channel 2422:

Horizontal:

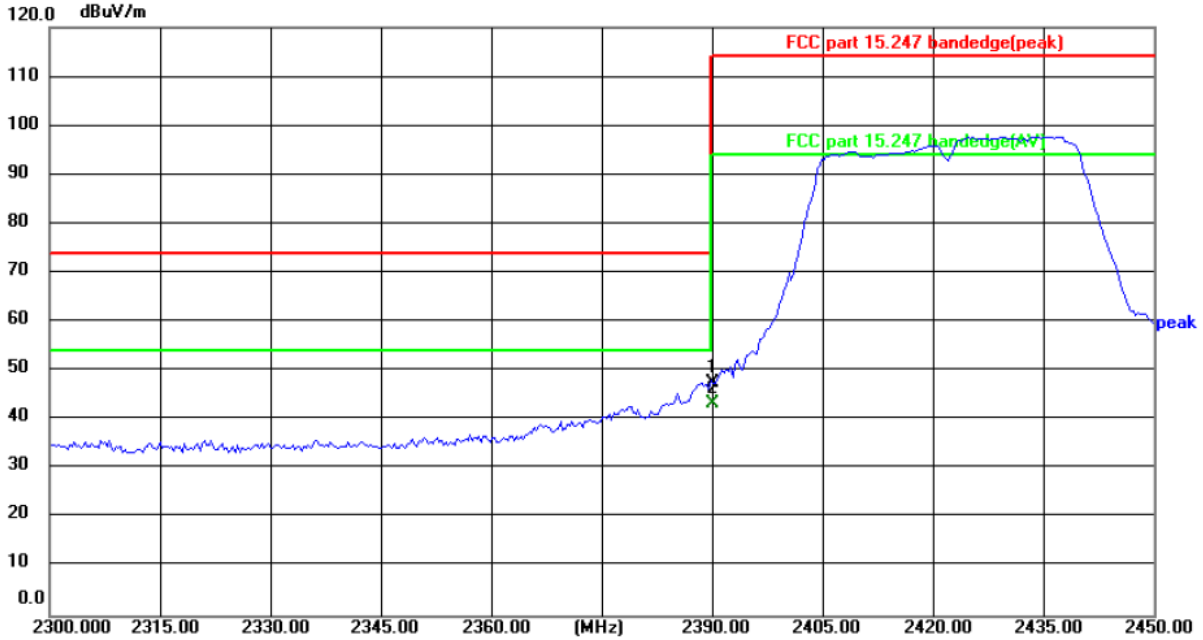

Site

Polarization: **Horizontal**

Temperature: 25(°C)

Limit: FCC part 15.247 bandedge(peak)

Power: DC 22.8 V

Humidity: 55 %

No.	Frequency (MHz)	Reading (dBuV)	Factor (dB/m)	Level (dBuV/m)	Limit (dBuV/m)	Margin (dB)	Detector	P/F	Remark
1	2390.000	60.66	-13.15	47.51	74.00	-26.49	peak	P	
2 *	2390.000	56.41	-13.15	43.26	54.00	-10.74	AVG	P	

Vertical:

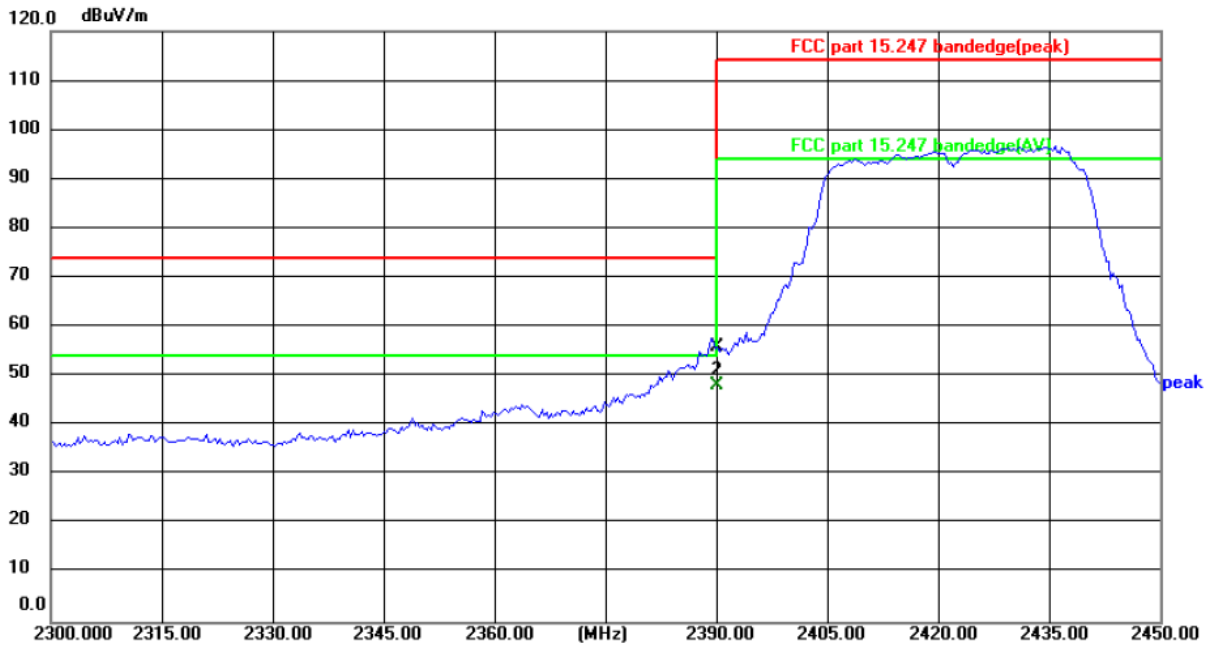

Site: Polarization: **Vertical** Temperature: 25(°C)
 Limit: FCC part 15.247 bandedge(peak) Power: DC 22.8 V Humidity: 55 %

No.	Frequency (MHz)	Reading (dBuV)	Factor (dB/m)	Level (dBuV/m)	Limit (dBuV/m)	Margin (dB)	Detector	P/F	Remark
1	2390.000	69.06	-13.05	56.01	74.00	-17.99	peak	P	
2 *	2390.000	61.21	-13.05	48.16	54.00	-5.84	AVG	P	

Note: Measurements were conducted in all two channels (high, low) and all modulation (802.11b, 802.11g, 802.11n(HT20), 802.11n(HT40)), and the worst case Mode 802.11n(HT40) was submitted only.

Highest channel 2452:

Horizontal:

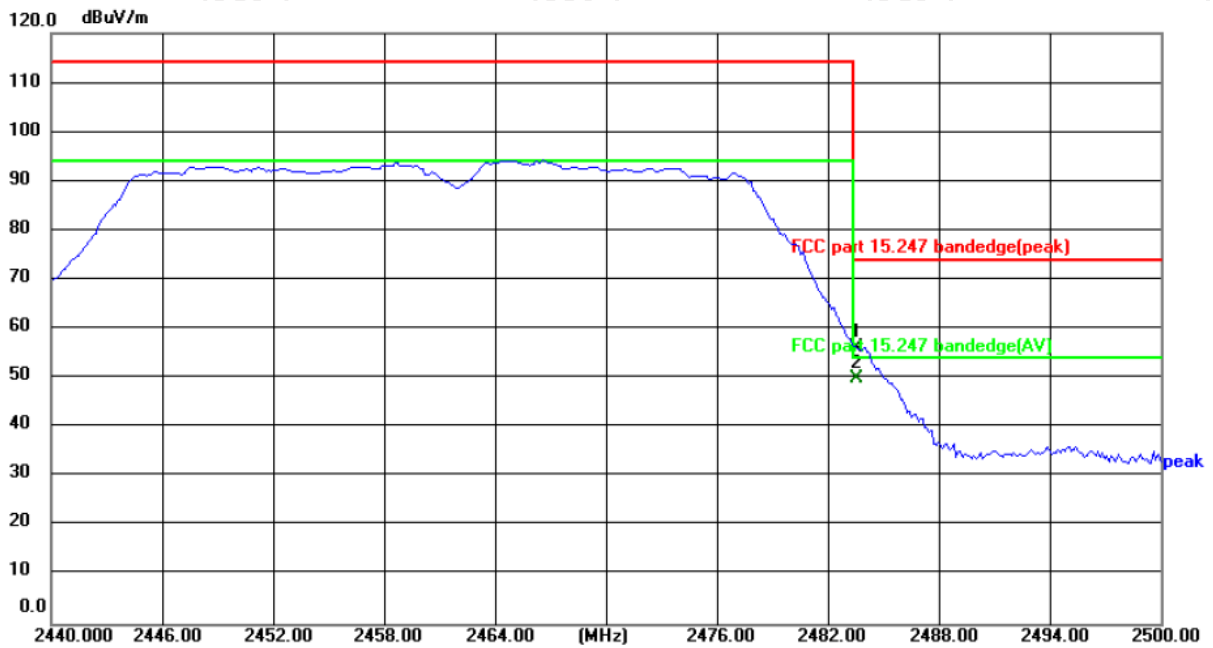

Site: _____ Polarization: **Horizontal** Temperature: 25(°C)
 Limit: FCC part 15.247 bandedge(peak) Power: DC 22.8 V Humidity: 55 %

No.	Frequency (MHz)	Reading (dBuV)	Factor (dB/m)	Level (dBuV/m)	Limit (dBuV/m)	Margin (dB)	Detector	P/F	Remark
1	2483.500	69.10	-12.84	56.26	74.00	-17.74	peak	P	
2 *	2483.500	62.90	-12.84	50.06	54.00	-3.94	AVG	P	

Vertical:

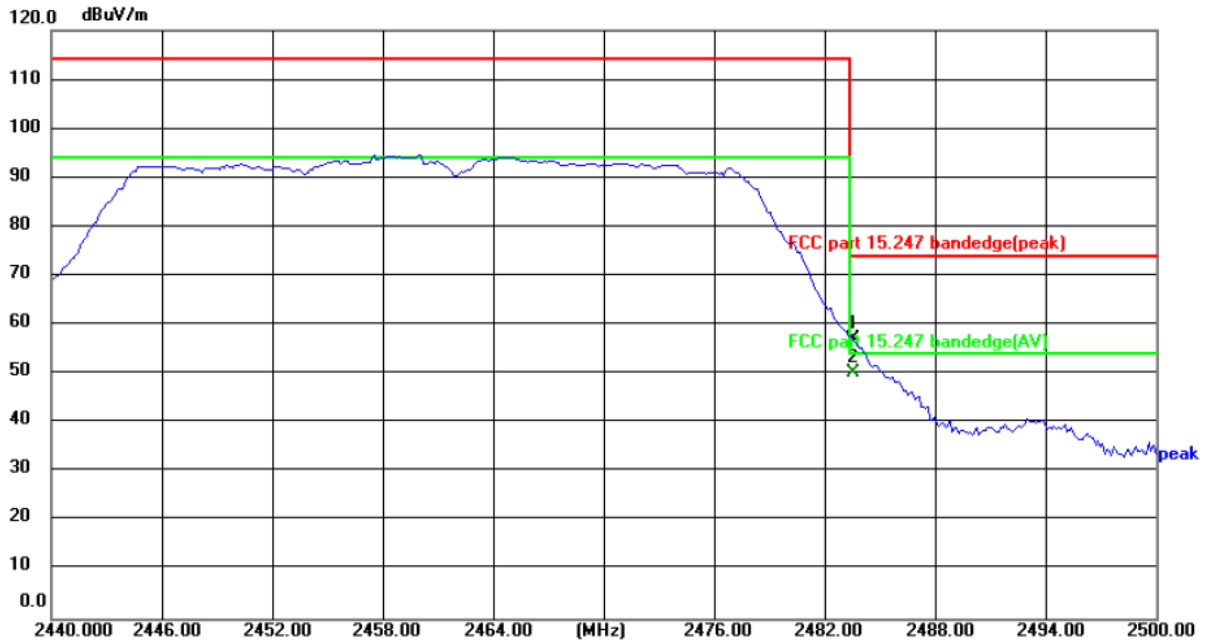

Site: Polarization: **Vertical** Temperature: 25(°C)
 Limit: FCC part 15.247 bandedge(peak) Power: DC 22.8V Humidity: 55 %

No.	Frequency (MHz)	Reading (dBuV)	Factor (dB/m)	Level (dBuV/m)	Limit (dBuV/m)	Margin (dB)	Detector	P/F	Remark
1	2483.500	70.10	-12.84	57.26	74.00	-16.74	peak	P	
2 *	2483.500	63.13	-12.84	50.29	54.00	-3.71	AVG	P	

Note:

1. Peak Final Emission Level=Peak Reading + Correction Factor;
2. Correction Factor= Antenna Factor + Cable loss – Pre-amplifier
3. Measurements were conducted in all modulation(802.11b, 802.11g, 802.11n(HT20), 802.11n(HT40)), and the worst case Mode 802.11n(HT40)) was submitted only.

MIMO

Lowest channel 2422:

Horizontal:

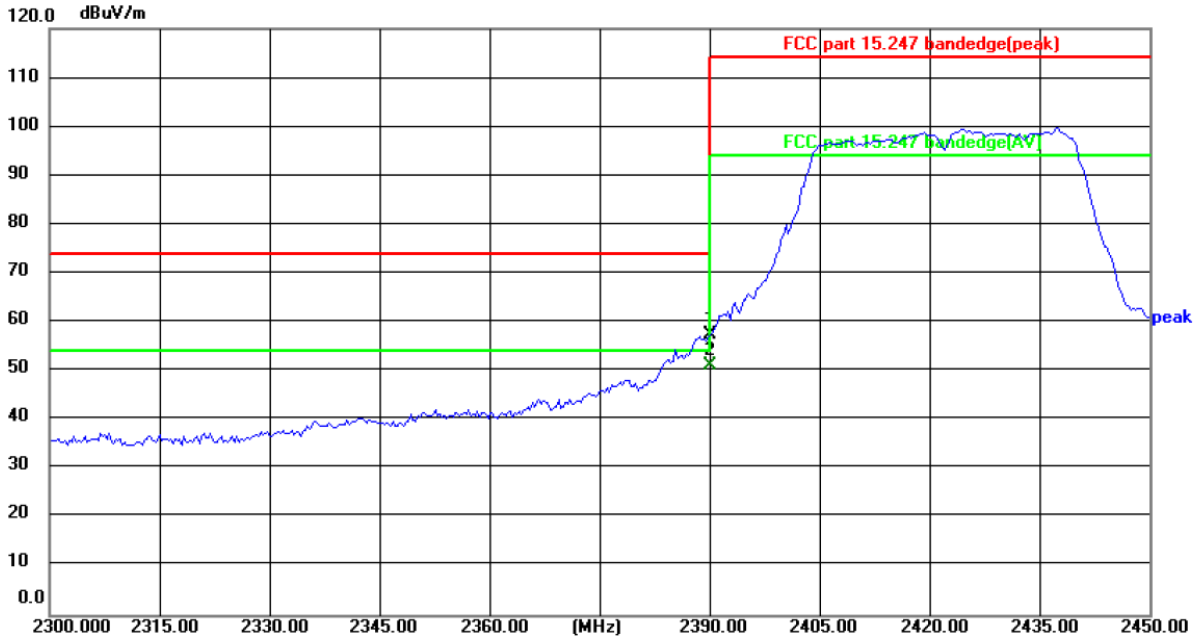

Site: #3 3m Anechoic Chamber Polarization: **Horizontal** Temperature: 25(°C) Humidity: 55 %

Limit: FCC part 15.247 bandedge(peak) Power:DC 22.8 V

No.	Frequency (MHz)	Reading (dBuV)	Factor (dB/m)	Level (dBuV/m)	Limit (dBuV/m)	Margin (dB)	Detector	P/F	Remark
1	2390.000	70.66	-13.15	57.51	74.00	-16.49	peak	P	
2 *	2390.000	64.31	-13.15	51.16	54.00	-2.84	AVG	P	

Vertical:

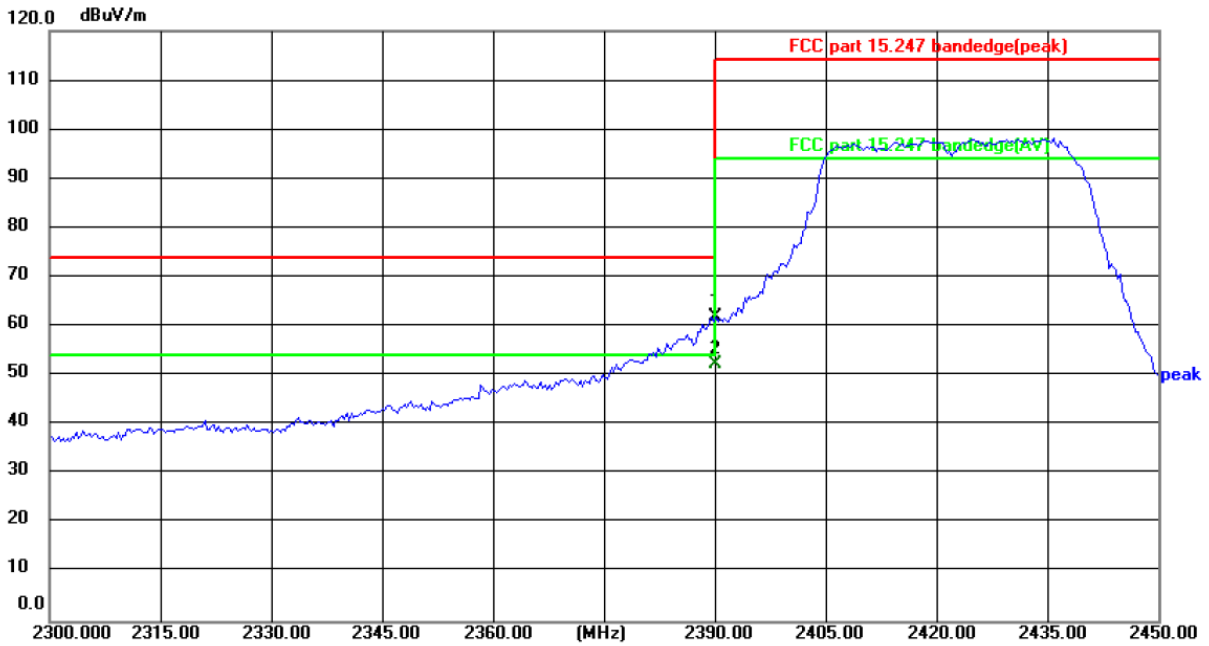

Site: #3 3m Anechoic Chamber Polarization: **Vertical** Temperature: 25(°C) Humidity: 55 %

Limit: FCC part 15.247 bandedge(peak) Power:DC 22.8 V

No.	Frequency (MHz)	Reading (dBuV)	Factor (dB/m)	Level (dBuV/m)	Limit (dBuV/m)	Margin (dB)	Detector	P/F	Remark
1	2390.000	75.06	-13.05	62.01	74.00	-11.99	peak	P	
2 *	2390.000	65.41	-13.05	52.36	54.00	-1.64	AVG	P	

Note: Measurements were conducted in all two channels (high, low) and all modulation (802.11b, 802.11g, 802.11n(HT20), 802.11n(HT40)), and the worst case Mode 802.11n(HT40) was submitted only.

Highest channel 2452:

Horizontal:

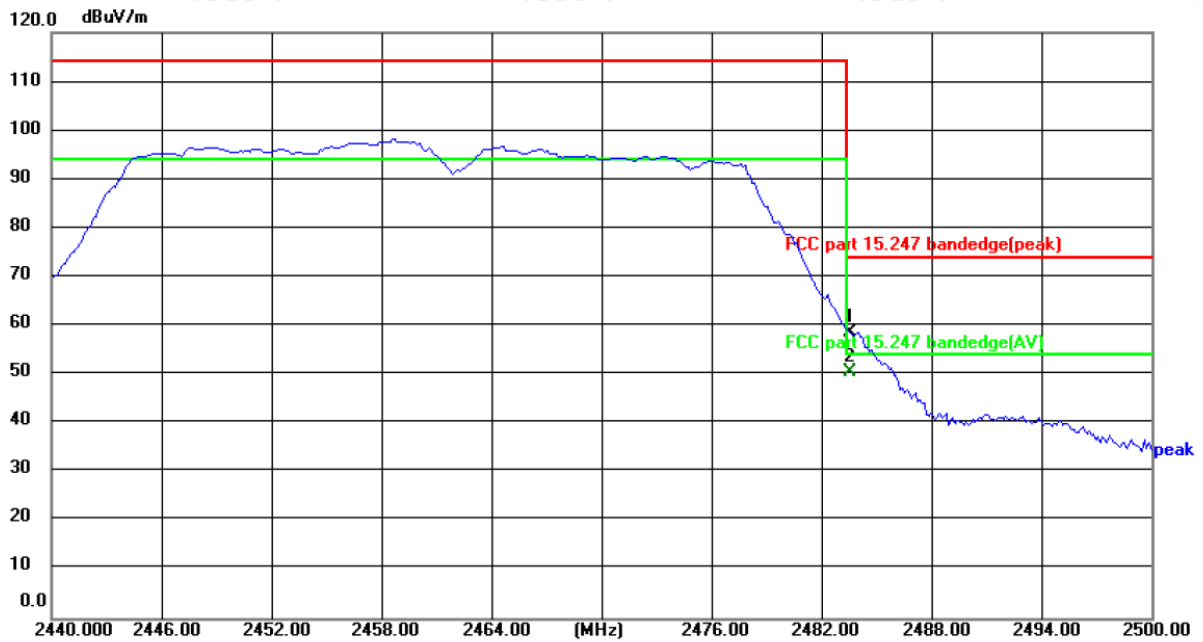

Site: #3 3m Anechoic Chamber Polarization: **Horizontal** Temperature: 25(°C) Humidity: 55 %

Limit: FCC part 15.247 bandedge(peak) Power:DC 22.8 V

No.	Frequency (MHz)	Reading (dBuV)	Factor (dB/m)	Level (dBuV/m)	Limit (dBuV/m)	Margin (dB)	Detector	P/F	Remark
1	2483.500	71.60	-12.84	58.76	74.00	-15.24	peak	P	
2 *	2483.500	63.26	-12.84	50.42	54.00	-3.58	AVG	P	

Vertical:

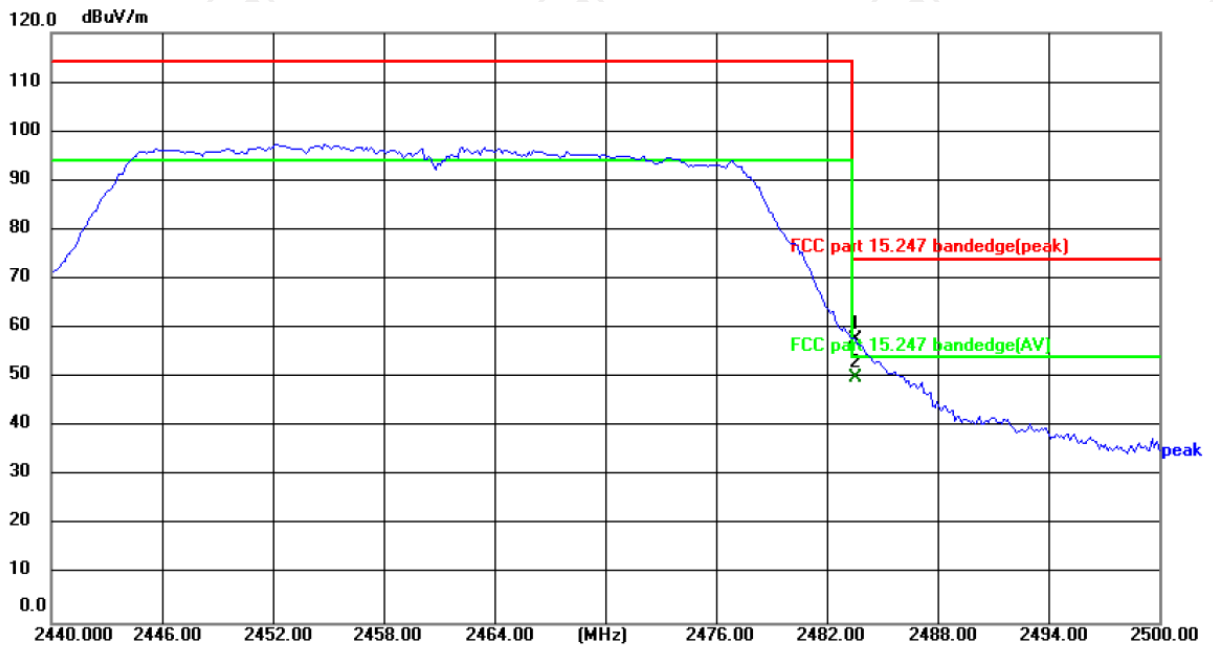

Site: #3 3m Anechoic Chamber Polarization: **Vertical** Temperature: 25(°C) Humidity: 55 %

Limit: FCC part 15.247 bandedge(peak) Power:DC 22.8 V

No.	Frequency (MHz)	Reading (dBuV)	Factor (dB/m)	Level (dBuV/m)	Limit (dBuV/m)	Margin (dB)	Detector	P/F	Remark
1	2483.500	70.60	-12.84	57.76	74.00	-16.24	peak	P	
2 *	2483.500	62.76	-12.84	49.92	54.00	-4.08	AVG	P	

Note:

1. Peak Final Emission Level=Peak Reading + Correction Factor;
2. Correction Factor= Antenna Factor + Cable loss – Pre-amplifier
3. Measurements were conducted in all modulation(802.11b, 802.11g, 802.11n(HT20), 802.11n(HT40)), and the worst case Mode 802.11n(HT40)) was submitted only.

Above 1GHz

Modulation Type: 802.11b

Low channel: 2412 MHz

Frequency (MHz)	Ant. Pol. H/V	Peak reading (dB μ V)	AV reading (dB μ V)	Correction Factor (dB/m)	Emission Level		Peak limit (dB μ V/m)	AV limit (dB μ V/m)	Margin (dB)
					Peak (dB μ V/m)	AV (dB μ V/m)			
4824	H	45.89	---	0.75	46.64	---	74	54	-7.36
7236	H	34.57	---	9.87	44.44	---	74	54	-9.56
---	H	---	---	---	---	---	---	---	---
4824	V	45.06	---	0.75	45.81	---	74	54	-8.19
7236	V	34.24	---	9.87	44.11	---	74	54	-9.89
---	V	---	---	---	---	---	---	---	---

Middle channel: 2437MHz

Frequency (MHz)	Ant. Pol. H/V	Peak reading (dB μ V)	AV reading (dB μ V)	Correction Factor (dB/m)	Emission Level		Peak limit (dB μ V/m)	AV limit (dB μ V/m)	Margin (dB)
					Peak (dB μ V/m)	AV (dB μ V/m)			
4874	H	45.60	---	0.97	46.57	---	74	54	-7.43
7311	H	36.48	---	9.83	46.31	---	74	54	-7.69
---	H	---	---	---	---	---	---	---	---
4874	V	45.52	---	0.97	46.49	---	74	54	-7.51
7311	V	34.86	---	9.83	44.69	---	74	54	-9.31
---	V	---	---	---	---	---	---	---	---

High channel: 2462 MHz

Frequency (MHz)	Ant. Pol. H/V	Peak reading (dB μ V)	AV reading (dB μ V)	Correction Factor (dB/m)	Emission Level		Peak limit (dB μ V/m)	AV limit (dB μ V/m)	Margin (dB)
					Peak (dB μ V/m)	AV (dB μ V/m)			
4924	H	46.64	---	1.18	47.82	---	74	54	-6.18
7386	H	36.27	---	10.07	46.34	---	74	54	-7.66
---	H	---	---	---	---	---	---	---	---
4924	V	44.18	---	1.18	45.36	---	74	54	-8.64
7386	V	34.25	---	10.07	44.32	---	74	54	-9.68
---	V	---	---	---	---	---	---	---	---

Note:

1. Emission Level=Peak Reading + Correction Factor; Correction Factor= Antenna Factor + Cable loss – Pre-amplifier
2. Margin (dB) = Emission Level (Peak) (dB μ V/m)-Average limit (dB μ V/m)
3. The emission levels of other frequencies are very lower than the limit and not show in test report.
4. Measurements were conducted from 1 GHz to the 10th harmonic of highest fundamental frequency. The highest test frequency is 25GHz.
5. Data of measurement shown "----"in the above table mean that the reading of emissions is attenuated more than 20 dB below the limits or the field strength is too small to be measured.
6. 802.11b is SISO mode and the worst case Antenna (ANT0) was submitted only.

Modulation Type: 802.11g

Low channel: 2412 MHz

Frequency (MHz)	Ant. Pol. H/V	Peak reading (dB μ V)	AV reading (dB μ V)	Correction Factor (dB/m)	Emission Level		Peak limit (dB μ V/m)	AV limit (dB μ V/m)	Margin (dB)
					Peak (dB μ V/m)	AV (dB μ V/m)			
4824	H	48.03	---	0.75	48.78	---	74	54	-5.22
7236	H	37.98	---	9.87	47.85	---	74	54	-6.15
---	H	---	---	---	---	---	---	---	---
4824	V	47.91	---	0.75	48.66	---	74	54	-5.34
7236	V	37.27	---	9.87	47.14	---	74	54	-6.86
---	V	---	---	---	---	---	---	---	---

Middle channel: 2437MHz

Frequency (MHz)	Ant. Pol. H/V	Peak reading (dB μ V)	AV reading (dB μ V)	Correction Factor (dB/m)	Emission Level		Peak limit (dB μ V/m)	AV limit (dB μ V/m)	Margin (dB)
					Peak (dB μ V/m)	AV (dB μ V/m)			
4874	H	46.89	---	0.97	47.86	---	74	54	-6.14
7311	H	37.06	---	9.83	46.89	---	74	54	-7.11
---	H	---	---	---	---	---	---	---	---
4874	V	46.02	---	0.97	46.99	---	74	54	-7.01
7311	V	35.14	---	9.83	44.97	---	74	54	-9.03
---	V	---	---	---	---	---	---	---	---

High channel: 2462 MHz

Frequency (MHz)	Ant. Pol. H/V	Peak reading (dB μ V)	AV reading (dB μ V)	Correction Factor (dB/m)	Emission Level		Peak limit (dB μ V/m)	AV limit (dB μ V/m)	Margin (dB)
					Peak (dB μ V/m)	AV (dB μ V/m)			
4924	H	45.91	---	1.18	47.09	---	74	54	-6.91
7386	H	36.68	---	10.07	46.75	---	74	54	-7.25
---	H	---	---	---	---	---	---	---	---
4924	V	44.89	---	1.18	46.07	---	74	54	-7.93
7386	V	35.36	---	10.07	45.43	---	74	54	-8.57
---	V	---	---	---	---	---	---	---	---

Note:

1. Emission Level=Peak Reading + Correction Factor; Correction Factor= Antenna Factor + Cable loss – Pre-amplifier
2. Margin (dB) = Emission Level (Peak) (dB μ V/m)-Average limit (dB μ V/m)
3. The emission levels of other frequencies are very lower than the limit and not show in test report.
4. Measurements were conducted from 1 GHz to the 10th harmonic of highest fundamental frequency. The highest test frequency is 25GHz.
5. Data of measurement shown "---" in the above table mean that the reading of emissions is attenuated more than 20 dB below the limits or the field strength is too small to be measured.
6. 802.11g is SISO mode and the worst case Antenna (ANT0) was submitted only.

Modulation Type: 802.11n(HT20)

Low channel: 2412 MHz									
Frequency (MHz)	Ant. Pol. H/V	Peak reading (dBμV)	AV reading (dBμV)	Correction Factor (dB/m)	Emission Level		Peak limit (dBμV/m)	AV limit (dBμV/m)	Margin (dB)
					Peak (dBμV/m)	AV (dBμV/m)			
4824	H	47.24	---	0.75	47.99	---	74	54	-6.01
7236	H	37.18	---	9.87	47.05	---	74	54	-6.95
---	H	---	---	---	---	---	---	---	---
4824	V	45.26	---	0.75	46.01	---	74	54	-7.99
7236	V	35.37	---	9.87	45.24	---	74	54	-8.76
---	V	---	---	---	---	---	---	---	---

Middle channel: 2437MHz									
Frequency (MHz)	Ant. Pol. H/V	Peak reading (dBμV)	AV reading (dBμV)	Correction Factor (dB/m)	Emission Level		Peak limit (dBμV/m)	AV limit (dBμV/m)	Margin (dB)
					Peak (dBμV/m)	AV (dBμV/m)			
4874	H	46.08	---	0.97	47.05	---	74	54	-6.95
7311	H	36.45	---	9.83	46.28	---	74	54	-7.72
---	H	---	---	---	---	---	---	---	---
4874	V	46.35	---	0.97	47.32	---	74	54	-6.68
7311	V	37.29	---	9.83	47.12	---	74	54	-6.88
---	V	---	---	---	---	---	---	---	---

High channel: 2462 MHz									
Frequency (MHz)	Ant. Pol. H/V	Peak reading (dBμV)	AV reading (dBμV)	Correction Factor (dB/m)	Emission Level		Peak limit (dBμV/m)	AV limit (dBμV/m)	Margin (dB)
					Peak (dBμV/m)	AV (dBμV/m)			
4924	H	46.65	---	1.18	47.83	---	74	54	-6.17
7386	H	36.12	---	10.07	46.19	---	74	54	-7.81
---	H	---	---	---	---	---	---	---	---
4924	V	46.08	---	1.18	47.26	---	74	54	-6.74
7386	V	34.42	---	10.07	44.49	---	74	54	-9.51
---	V	---	---	---	---	---	---	---	---

Note:

1. Emission Level=Peak Reading + Correction Factor; Correction Factor= Antenna Factor + Cable loss – Pre-amplifier
2. Margin (dB) = Emission Level (Peak) (dBμV/m)-Average limit (dBμV/m)
3. The emission levels of other frequencies are very lower than the limit and not show in test report.
4. Measurements were conducted from 1 GHz to the 10th harmonic of highest fundamental frequency. The highest test frequency is 25GHz.
5. Data of measurement shown "----" in the above table mean that the reading of emissions is attenuated more than 20 dB below the limits or the field strength is too small to be measured.
6. 802.11n(HT20) is MIMO mode.

Modulation Type: 802.11n(HT40)

Low channel: 2422 MHz									
Frequency (MHz)	Ant. Pol. H/V	Peak reading (dBμV)	AV reading (dBμV)	Correction Factor (dB/m)	Emission Level		Peak limit (dBμV/m)	AV limit (dBμV/m)	Margin (dB)
					Peak (dBμV/m)	AV (dBμV/m)			
4844	H	47.30	---	0.75	48.05	---	74	54	-5.95
7266	H	35.92	---	9.87	45.79	---	74	54	-8.21
---	H	---	---	---	---	---	---	---	---
4824	V	46.72	---	0.75	47.47	---	74	54	-6.53
7236	V	35.66	---	9.87	45.53	---	74	54	-8.47
---	V	---	---	---	---	---	---	---	---

Middle channel: 2437MHz									
Frequency (MHz)	Ant. Pol. H/V	Peak reading (dBμV)	AV reading (dBμV)	Correction Factor (dB/m)	Emission Level		Peak limit (dBμV/m)	AV limit (dBμV/m)	Margin (dB)
					Peak (dBμV/m)	AV (dBμV/m)			
4874	H	47.05	---	0.97	48.02	---	74	54	-5.98
7311	H	37.88	---	9.83	47.71	---	74	54	-6.29
---	H	---	---	---	---	---	---	---	---
4874	V	47.27	---	0.97	48.24	---	74	54	-5.76
7311	V	34.91	---	9.83	44.74	---	74	54	-9.26
---	V	---	---	---	---	---	---	---	---

High channel: 2452 MHz									
Frequency (MHz)	Ant. Pol. H/V	Peak reading (dBμV)	AV reading (dBμV)	Correction Factor (dB/m)	Emission Level		Peak limit (dBμV/m)	AV limit (dBμV/m)	Margin (dB)
					Peak (dBμV/m)	AV (dBμV/m)			
4904	H	45.08	---	1.18	46.26	---	74	54	-7.74
7356	H	34.16	---	10.07	44.23	---	74	54	-9.77
---	H	---	---	---	---	---	---	---	---
4904	V	45.78	---	1.18	46.96	---	74	54	-7.04
7356	V	36.35	---	10.07	46.42	---	74	54	-7.58
---	V	---	---	---	---	---	---	---	---

Note:

1. Emission Level=Peak Reading + Correction Factor; Correction Factor= Antenna Factor + Cable loss – Pre-amplifier
2. Margin (dB) = Emission Level (Peak) (dBμV/m)-Average limit (dBμV/m)
3. The emission levels of other frequencies are very lower than the limit and not show in test report.
4. Measurements were conducted from 1 GHz to the 10th harmonic of highest fundamental frequency. The highest test frequency is 25GHz.
5. Data of measurement shown "----" in the above table mean that the reading of emissions is attenuated more than 20 dB below the limits or the field strength is too small to be measured.
6. 802.11n(HT40) is MIMO mode.

Appendix A: Test Result of Conducted Test

Antenna 0

Duty Cycle

Condition	Mode	Frequency (MHz)	Antenna	Duty Cycle (%)	Correction Factor (dB)
NVNT	b	2412	Ant0	99.71	0
NVNT	b	2437	Ant0	99.68	0
NVNT	b	2462	Ant0	99.68	0
NVNT	g	2412	Ant0	97.64	0.10
NVNT	g	2437	Ant0	97.69	0.10
NVNT	g	2462	Ant0	97.64	0.10
NVNT	n20	2412	Ant0	97.47	0.11
NVNT	n20	2437	Ant0	97.47	0.11
NVNT	n20	2462	Ant0	97.47	0.11
NVNT	n40	2422	Ant0	95.20	0.21
NVNT	n40	2437	Ant0	95.29	0.21
NVNT	n40	2452	Ant0	95.17	0.21

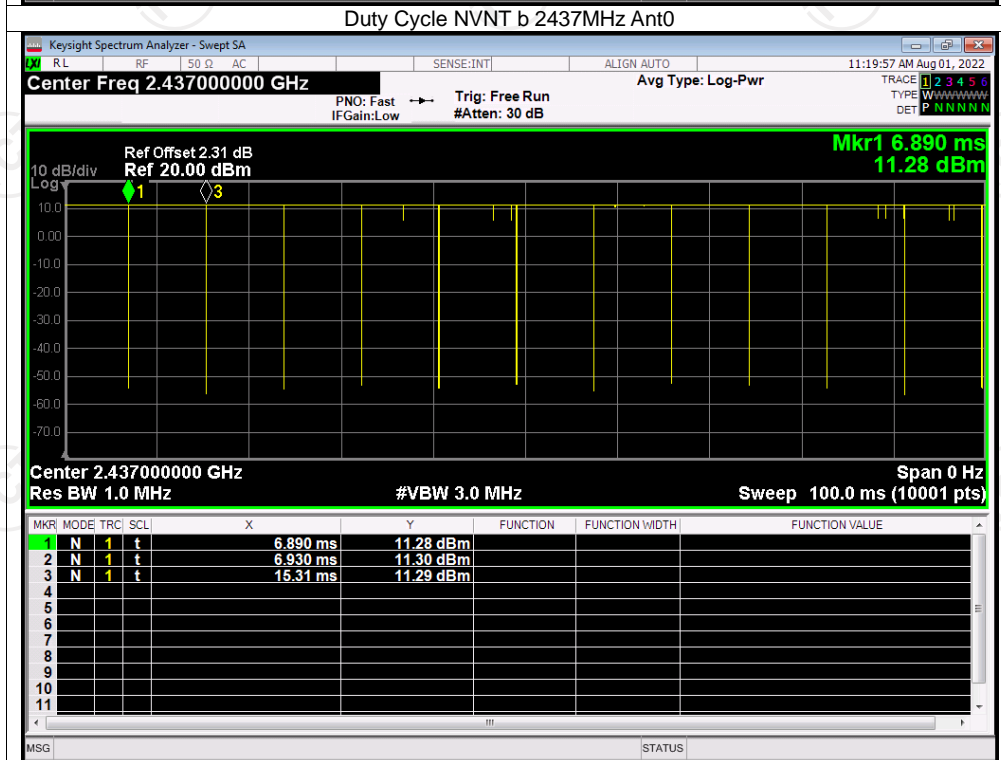
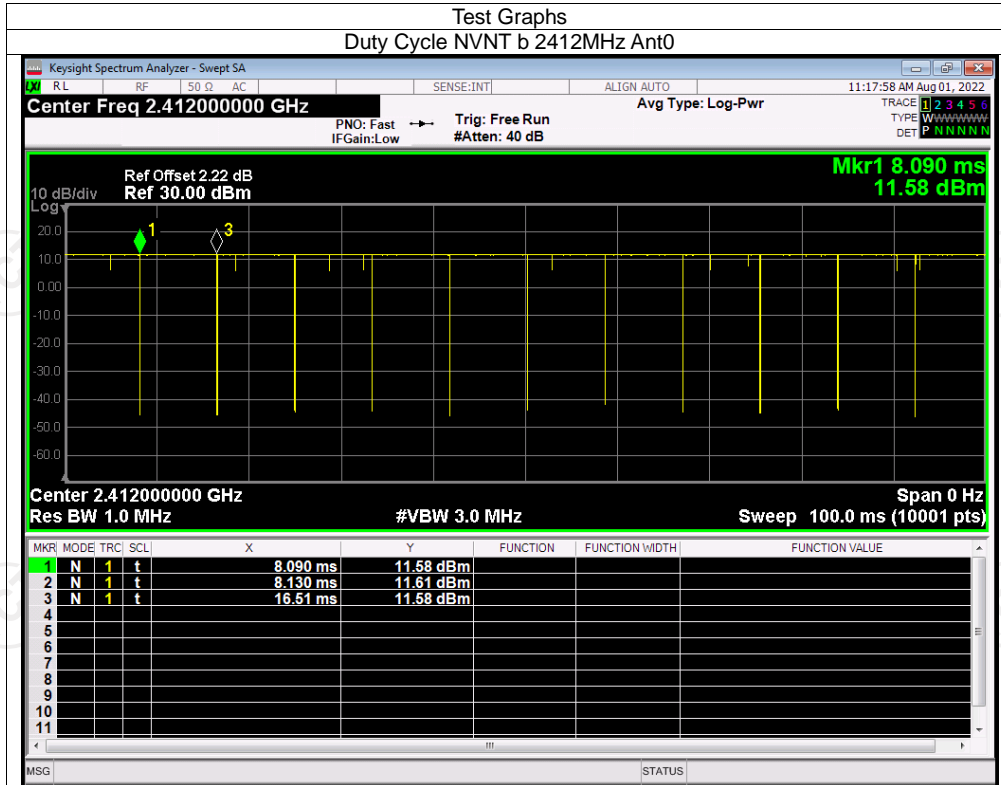

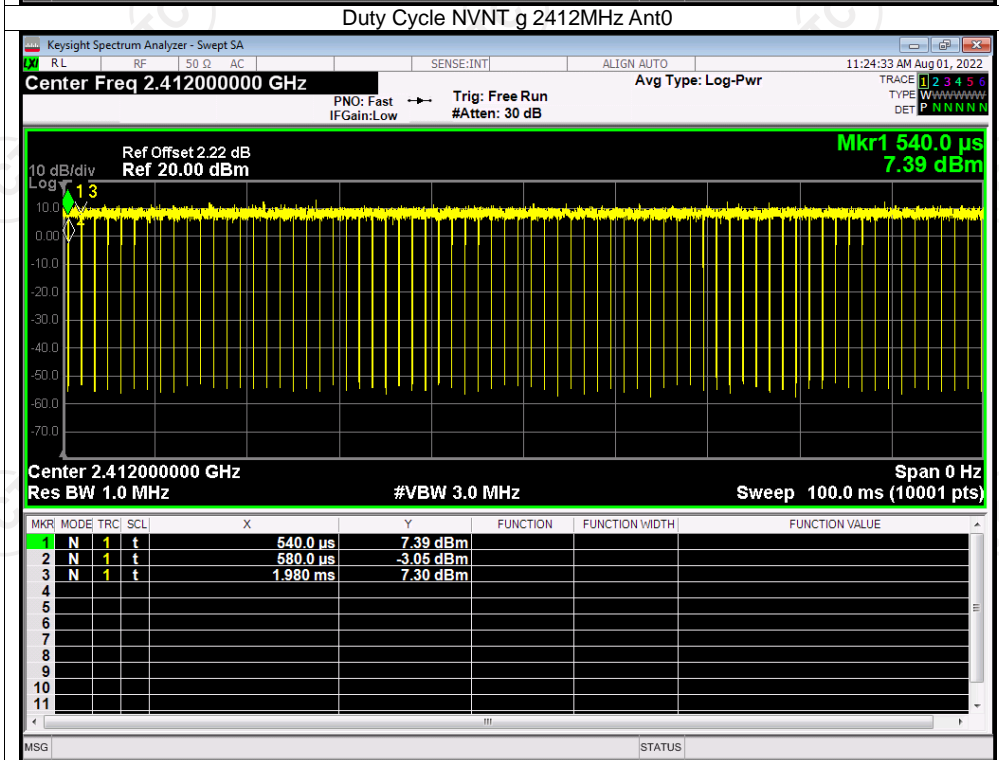
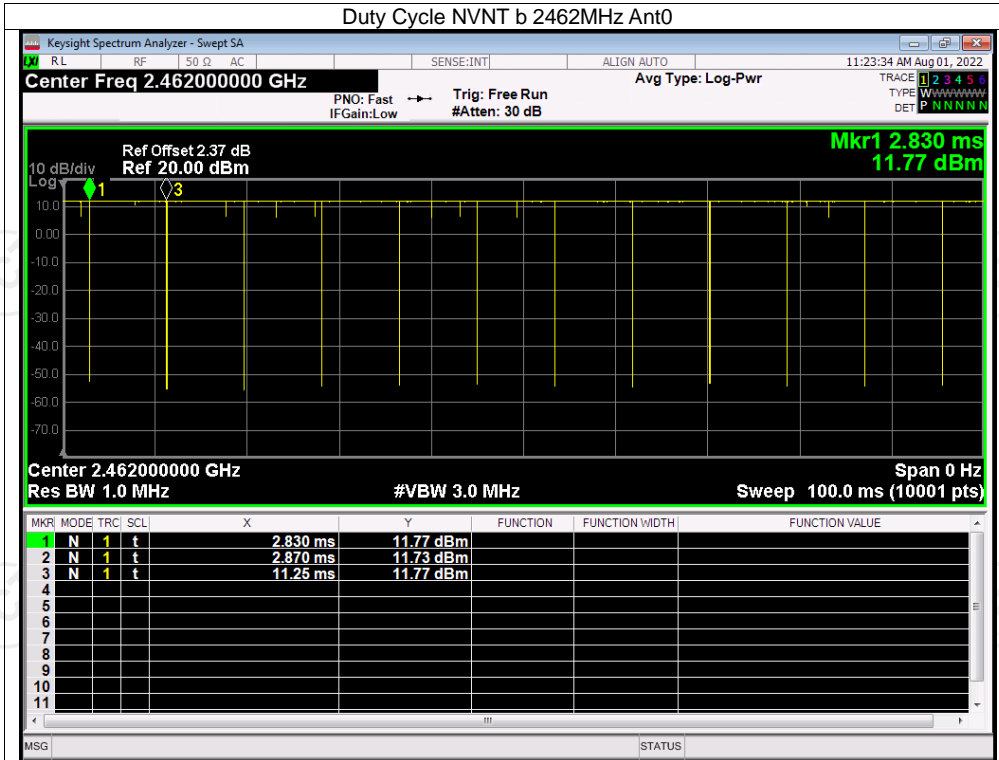

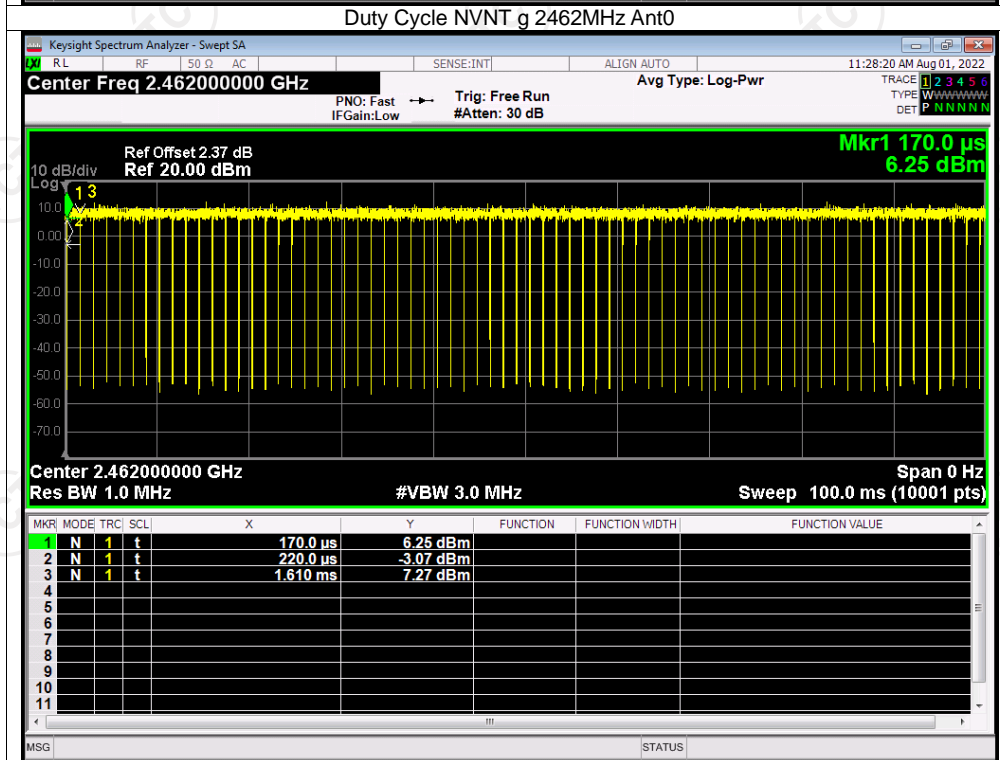
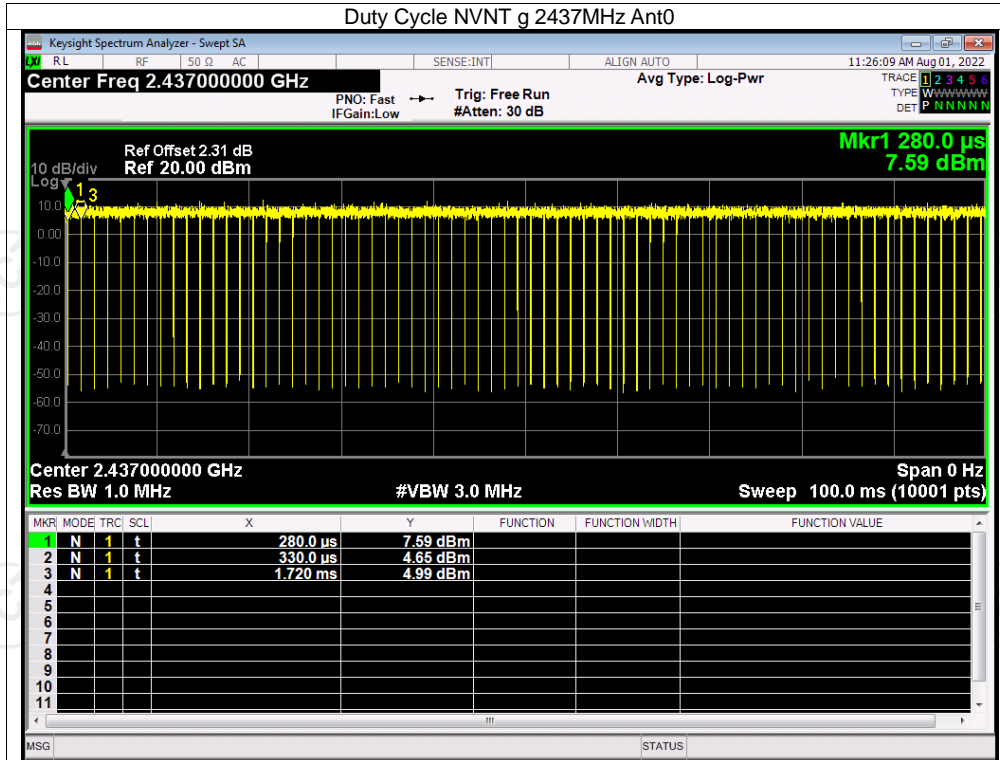

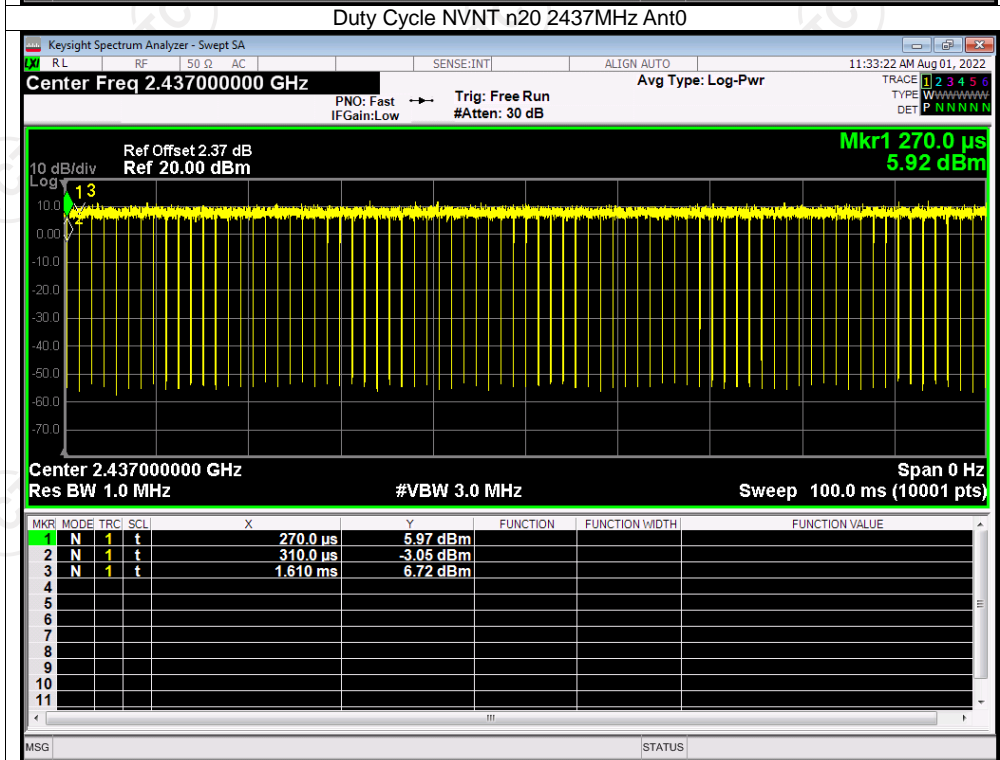
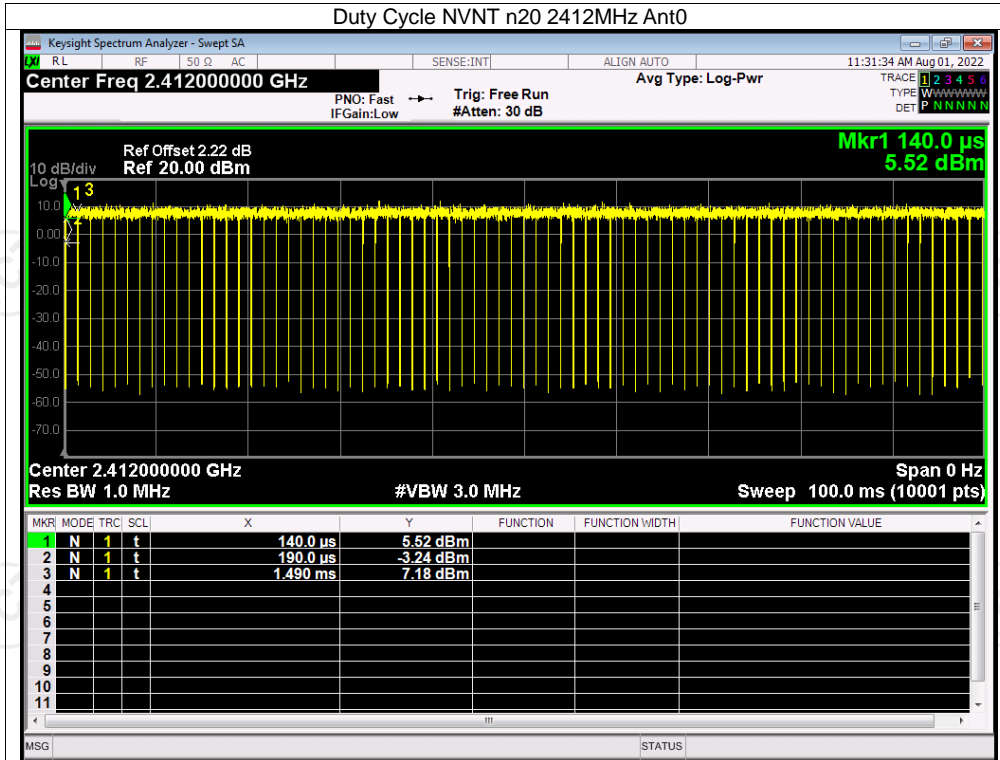

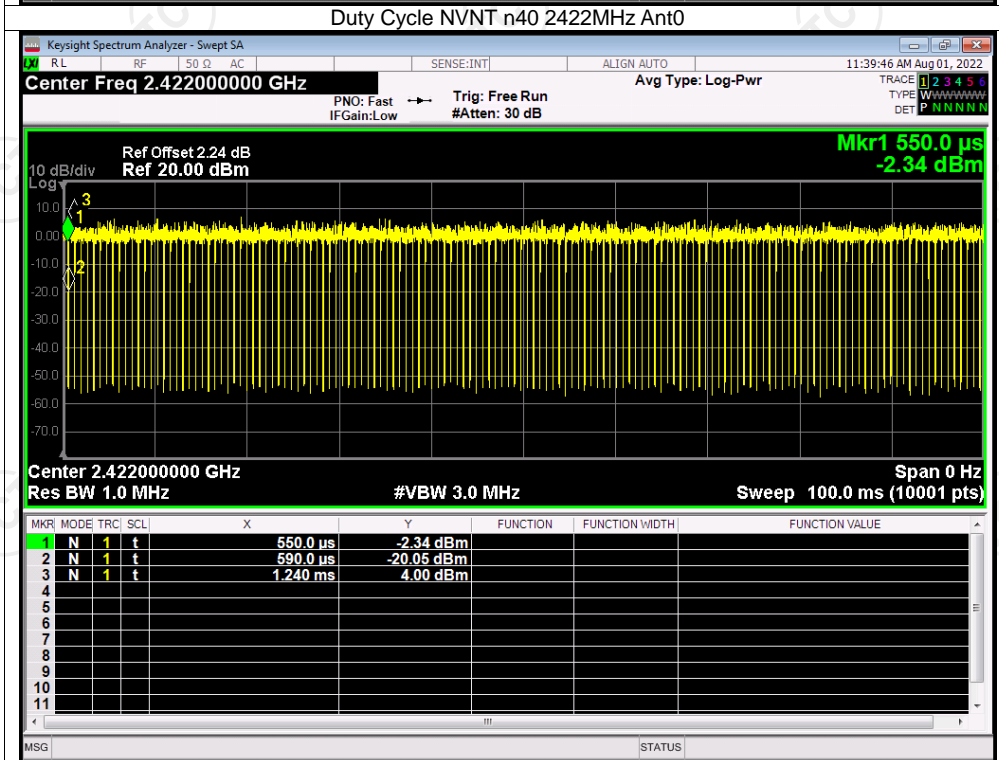
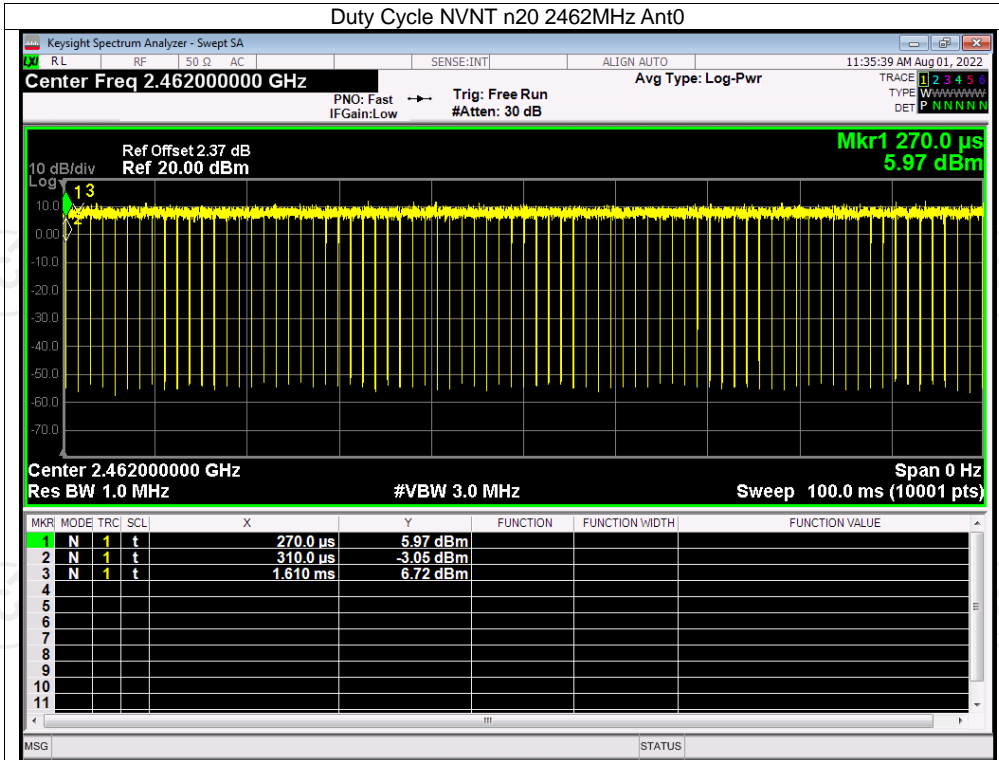

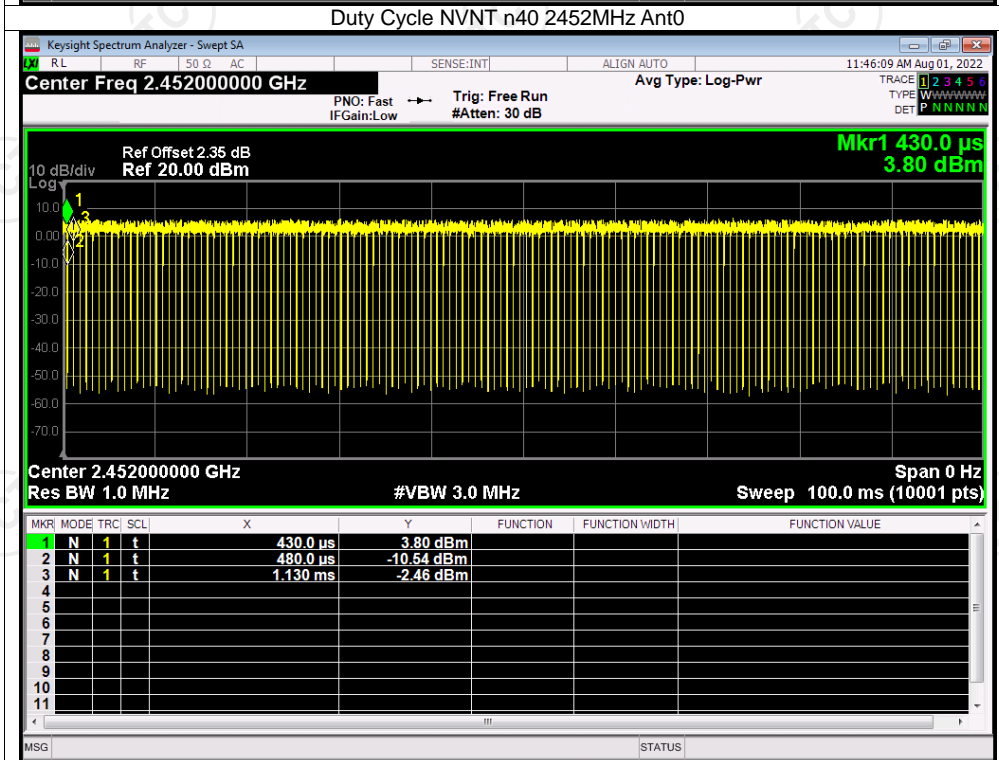
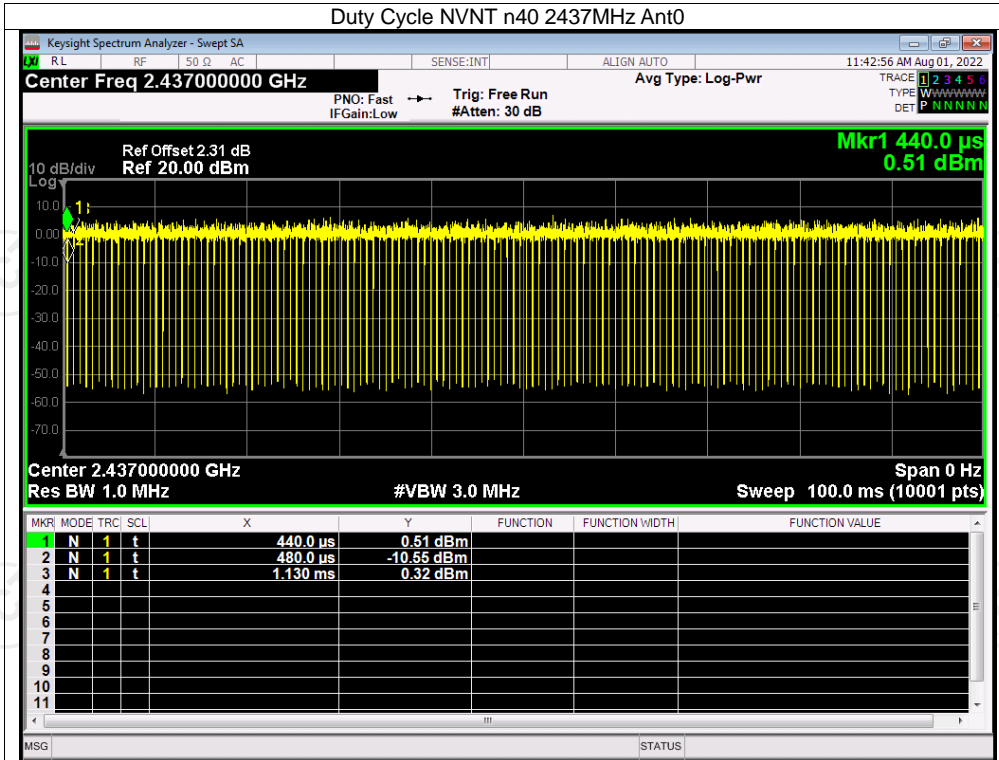

Maximum Conducted Output Power

Condition	Mode	Frequency (MHz)	Antenna	Conducted Power (dBm)	Duty Factor (dB)	Total Power (dBm)	Limit (dBm)	Verdict
NVNT	b	2412	Ant0	16.49	0	16.49	30	Pass
NVNT	b	2437	Ant0	16.52	0	16.52	30	Pass
NVNT	b	2462	Ant0	16.87	0	16.87	30	Pass
NVNT	g	2412	Ant0	14.47	0.10	14.57	30	Pass
NVNT	g	2437	Ant0	14.08	0.10	14.18	30	Pass
NVNT	g	2462	Ant0	14.13	0.10	14.23	30	Pass
NVNT	n20	2412	Ant0	14.24	0.11	14.35	30	Pass
NVNT	n20	2437	Ant0	14.13	0.11	14.24	30	Pass
NVNT	n20	2462	Ant0	14.25	0.11	14.36	30	Pass
NVNT	n40	2422	Ant0	13.51	0.21	13.72	30	Pass
NVNT	n40	2437	Ant0	13.10	0.21	13.31	30	Pass
NVNT	n40	2452	Ant0	13.24	0.21	13.45	30	Pass

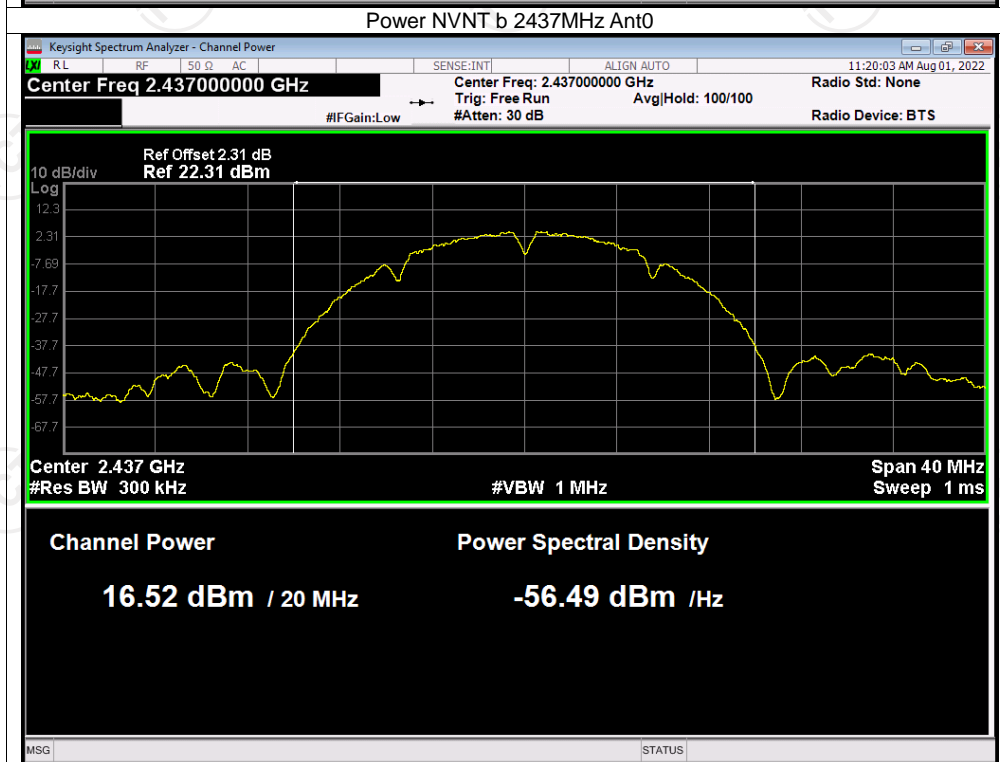
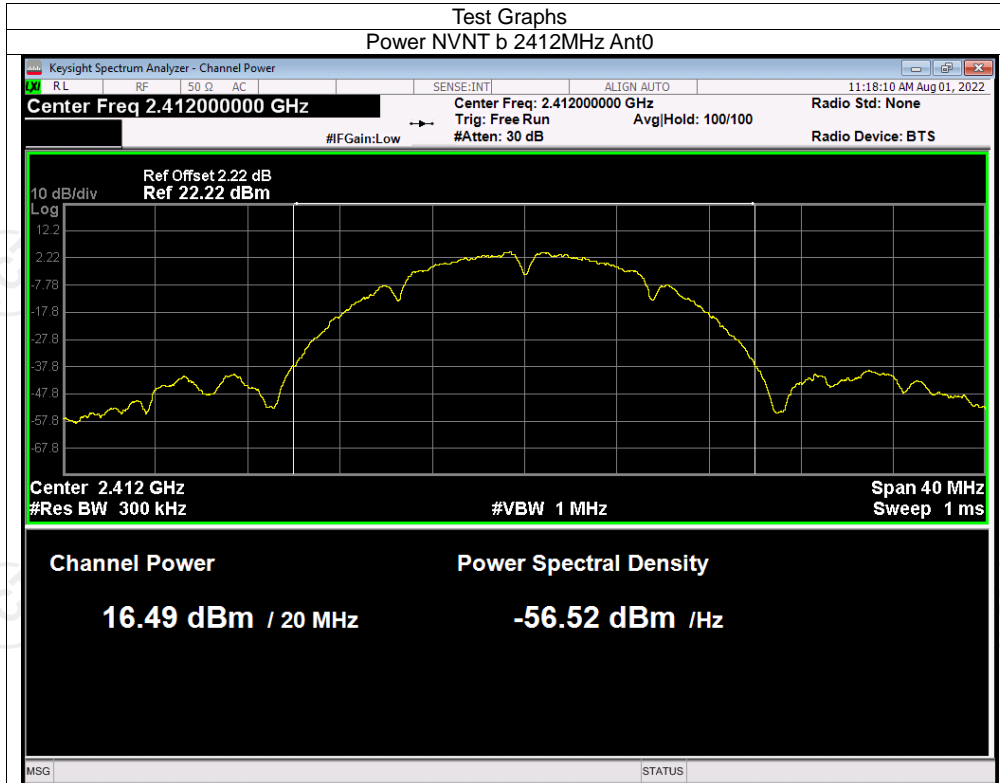

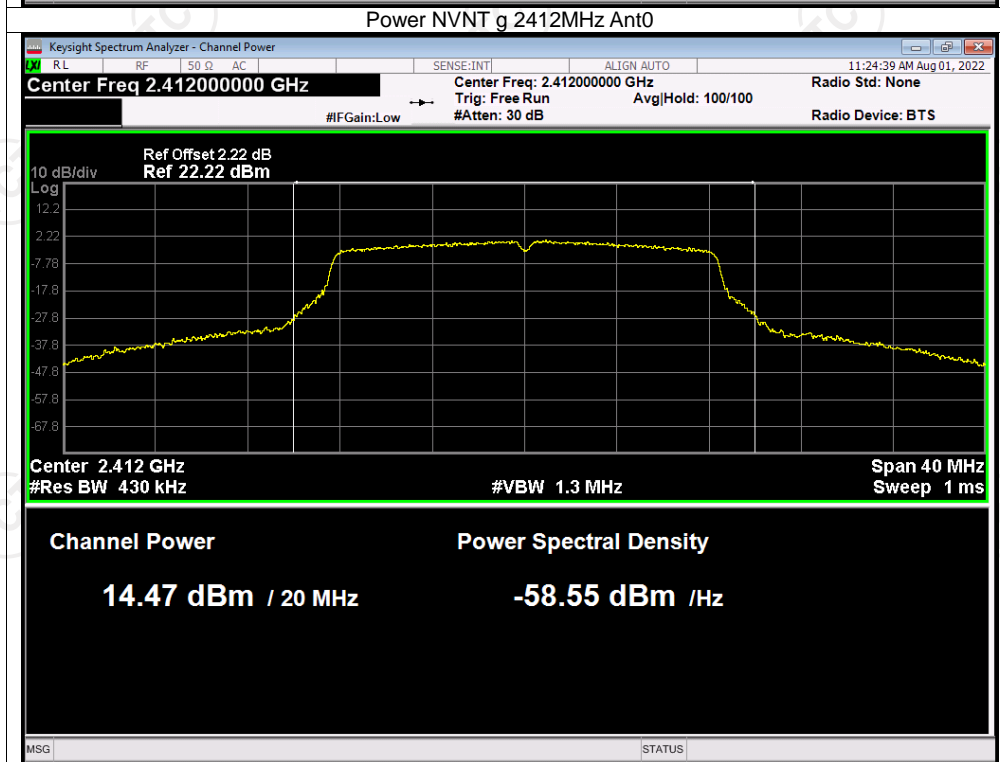
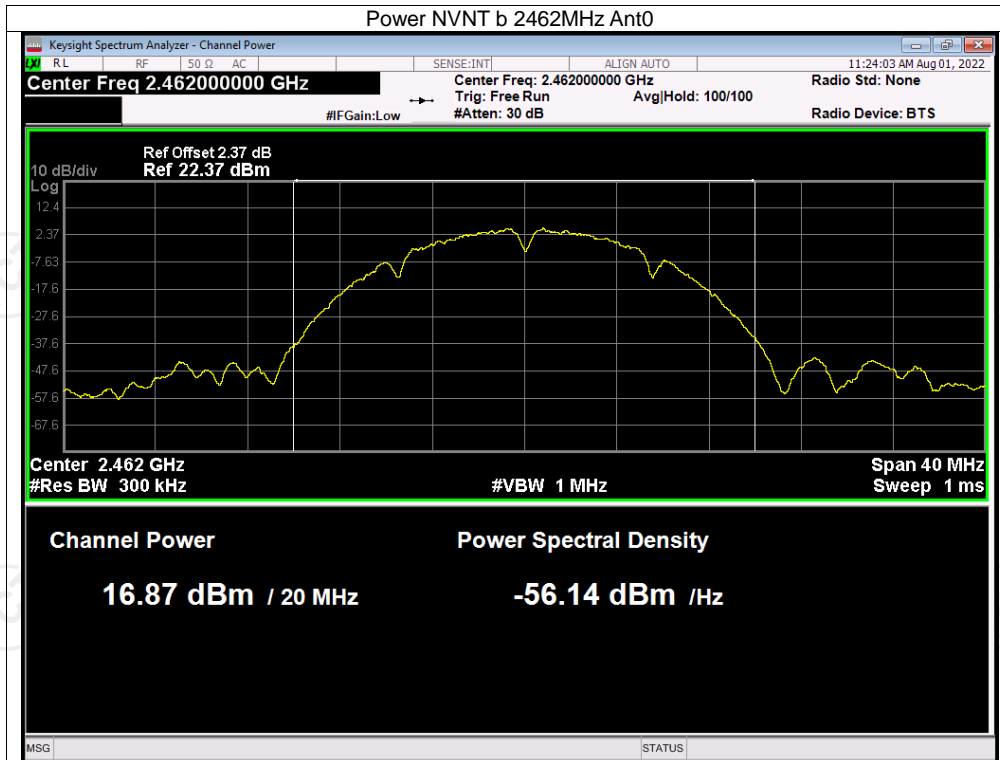

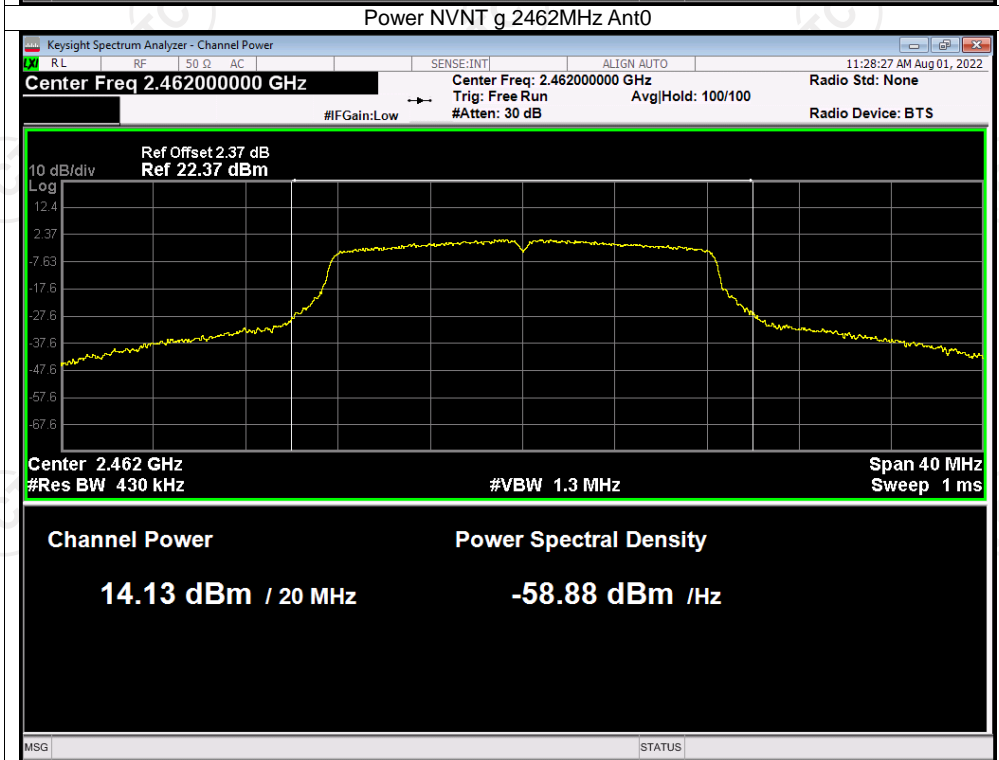
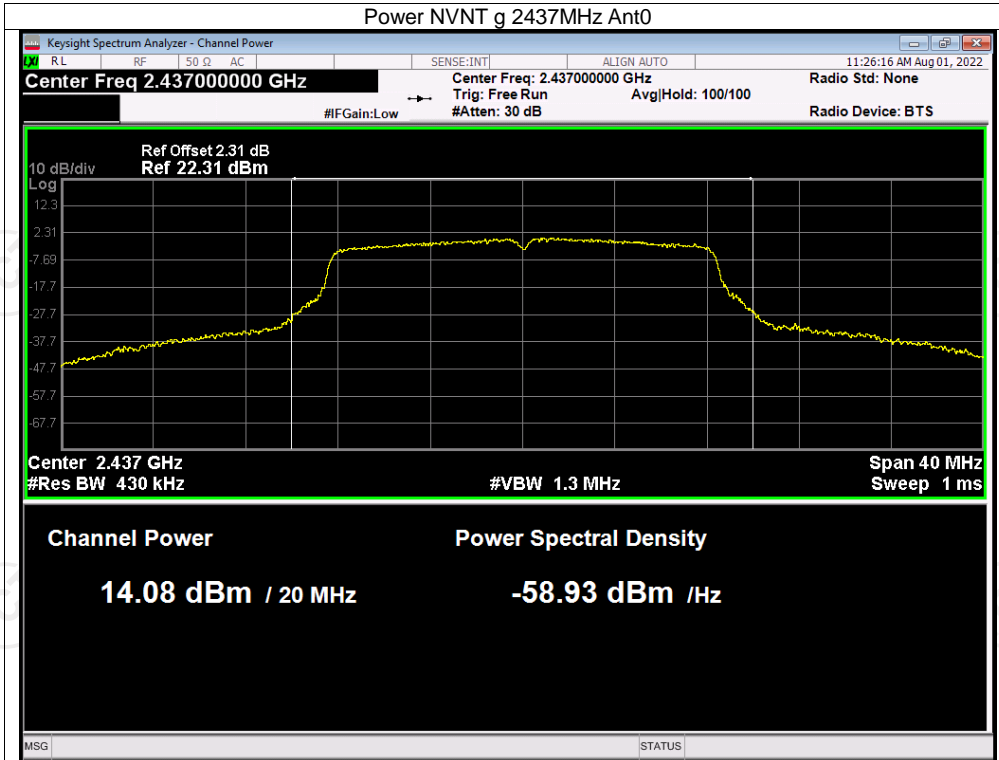

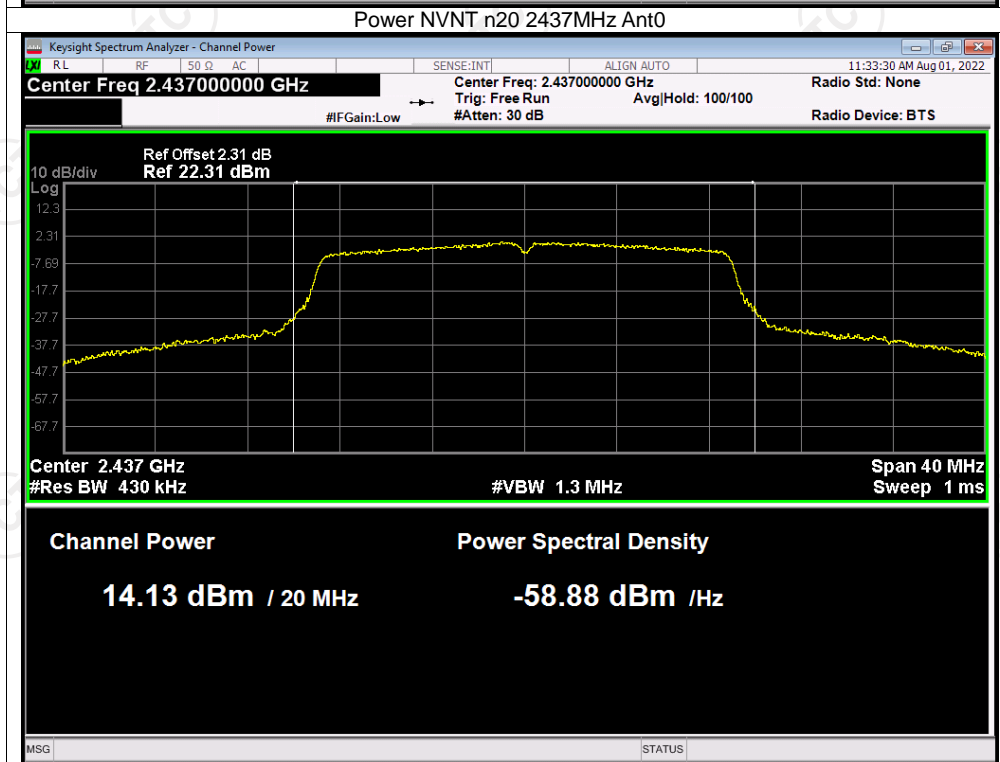
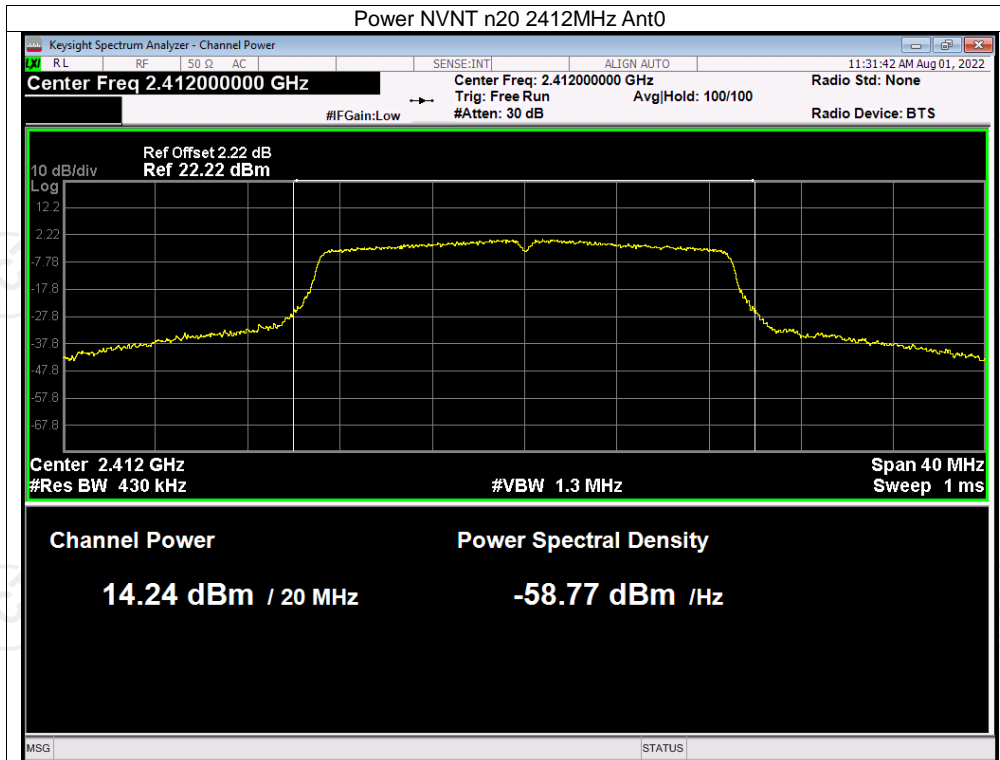

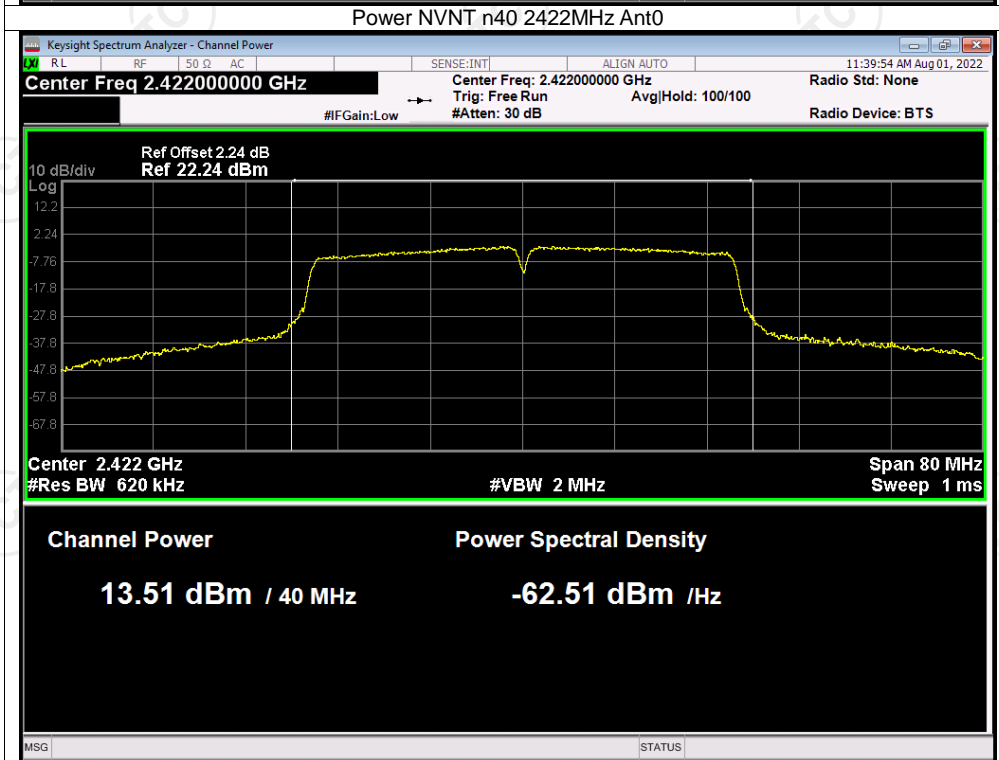
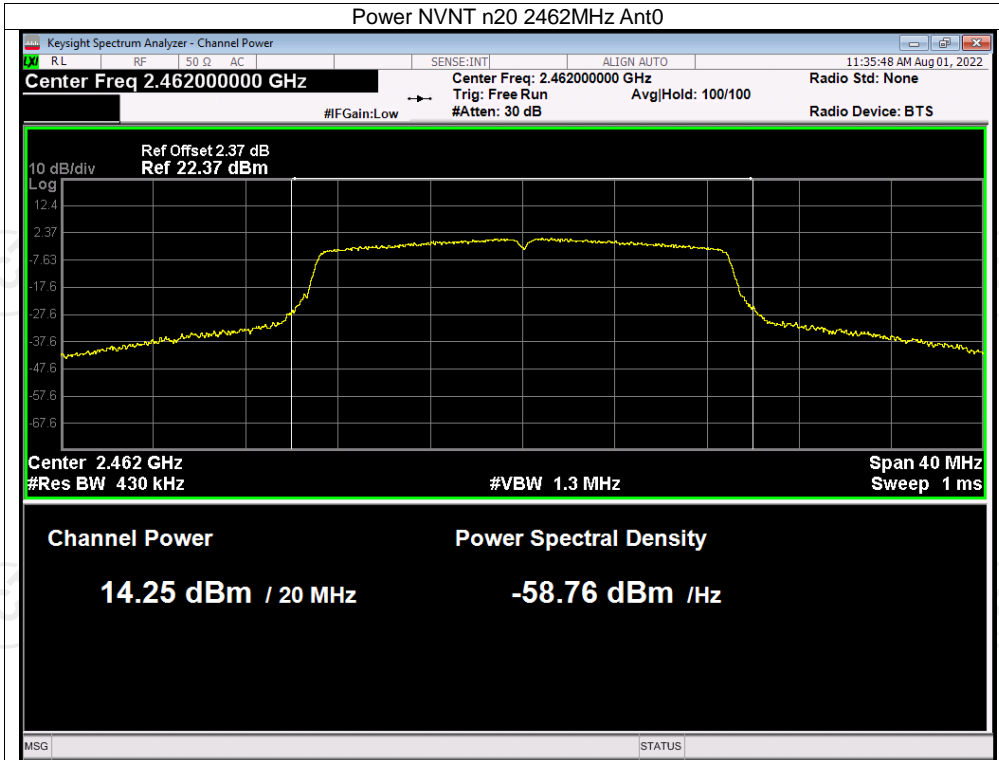

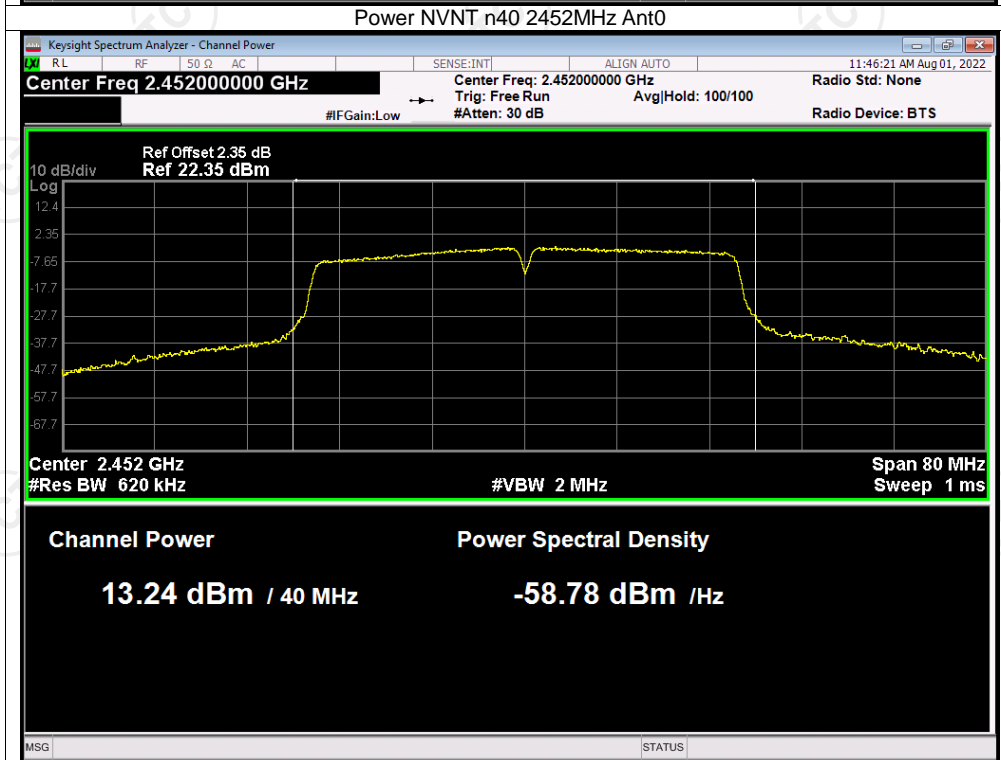
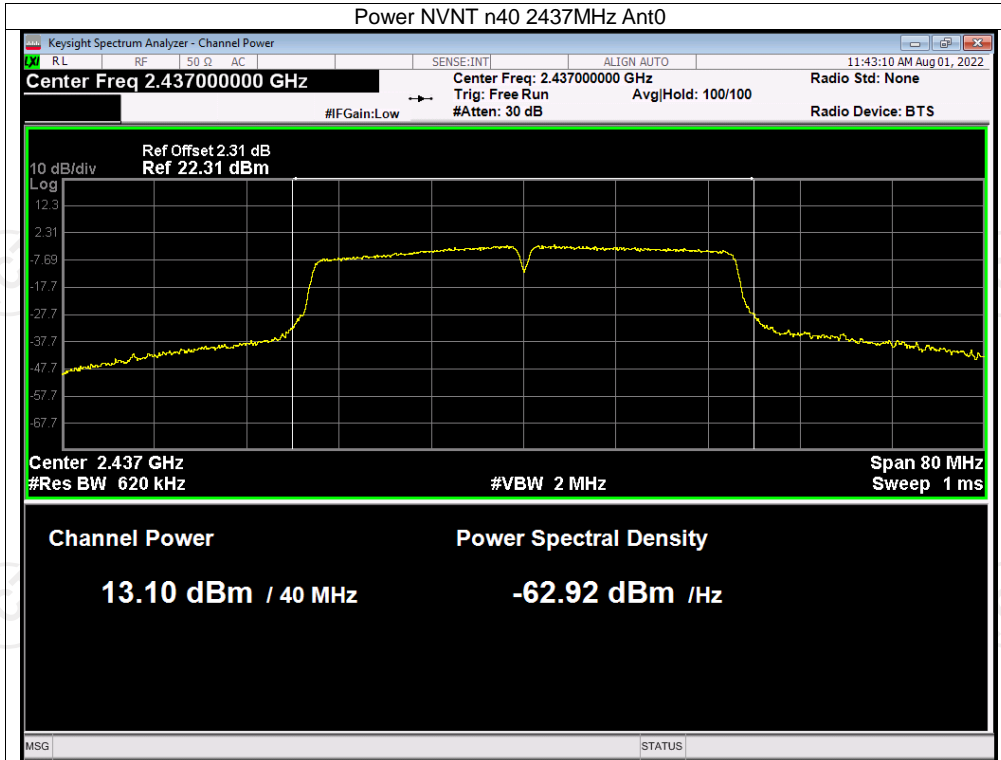

-6dB Bandwidth

Condition	Mode	Frequency (MHz)	Antenna	-6 dB Bandwidth (MHz)	Limit -6 dB Bandwidth (MHz)	Verdict
NVNT	b	2412	Ant0	8.009	0.5	Pass
NVNT	b	2437	Ant0	8.071	0.5	Pass
NVNT	b	2462	Ant0	8.050	0.5	Pass
NVNT	g	2412	Ant0	15.137	0.5	Pass
NVNT	g	2437	Ant0	15.070	0.5	Pass
NVNT	g	2462	Ant0	15.119	0.5	Pass
NVNT	n20	2412	Ant0	15.045	0.5	Pass
NVNT	n20	2437	Ant0	15.123	0.5	Pass
NVNT	n20	2462	Ant0	15.113	0.5	Pass
NVNT	n40	2422	Ant0	35.117	0.5	Pass
NVNT	n40	2437	Ant0	32.570	0.5	Pass
NVNT	n40	2452	Ant0	33.799	0.5	Pass

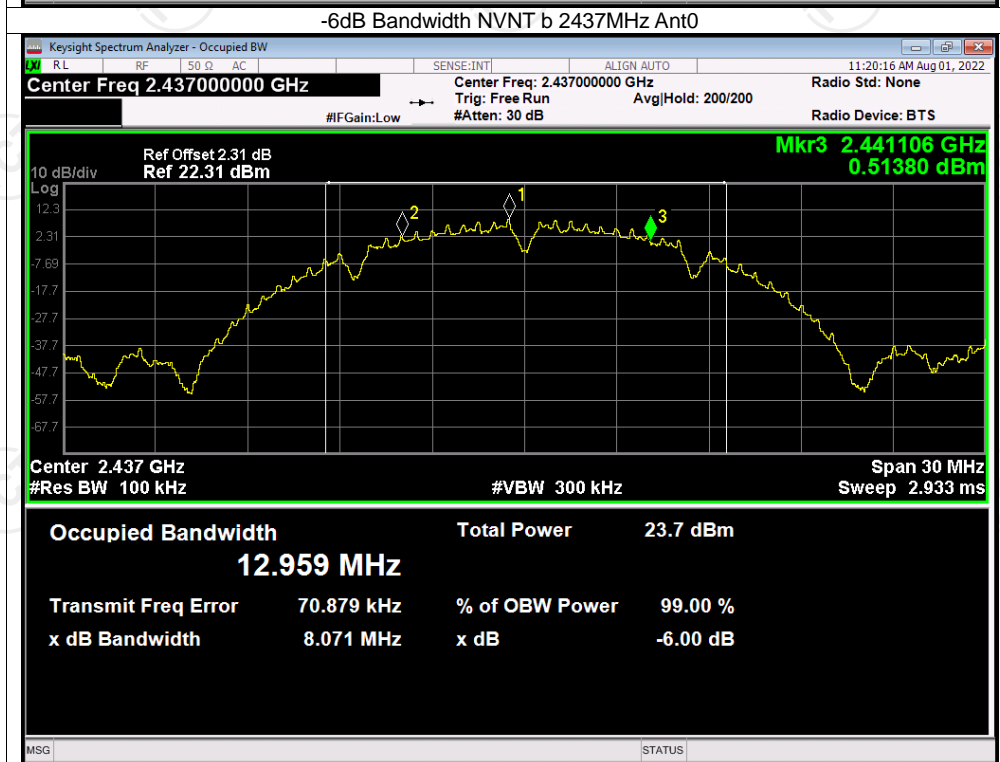

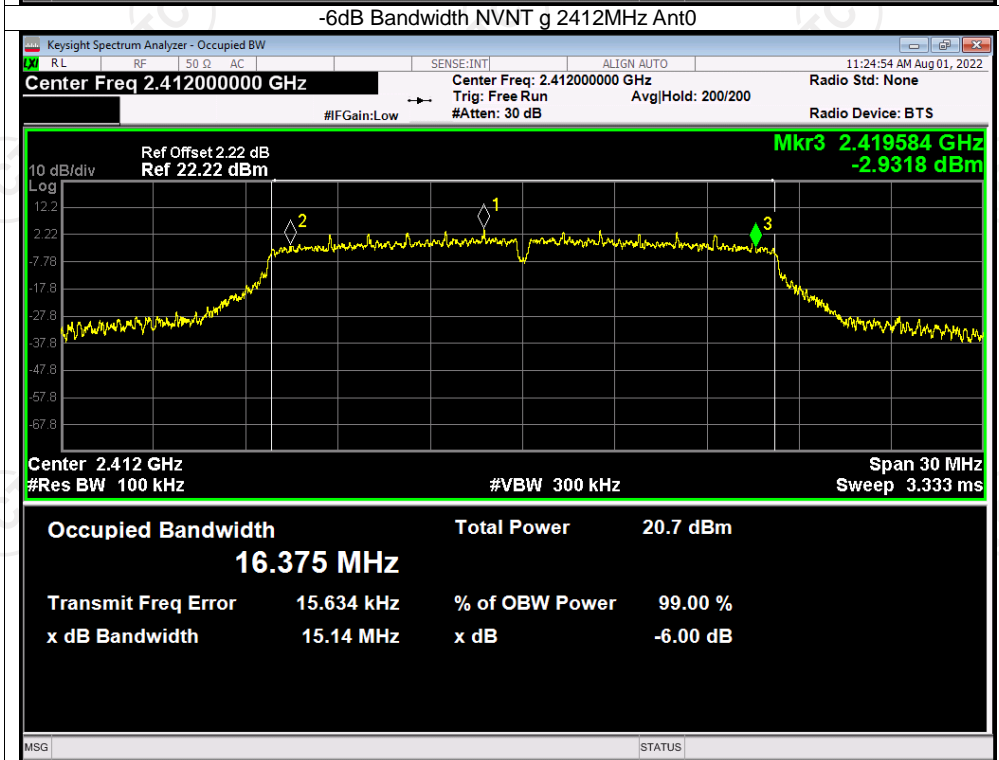
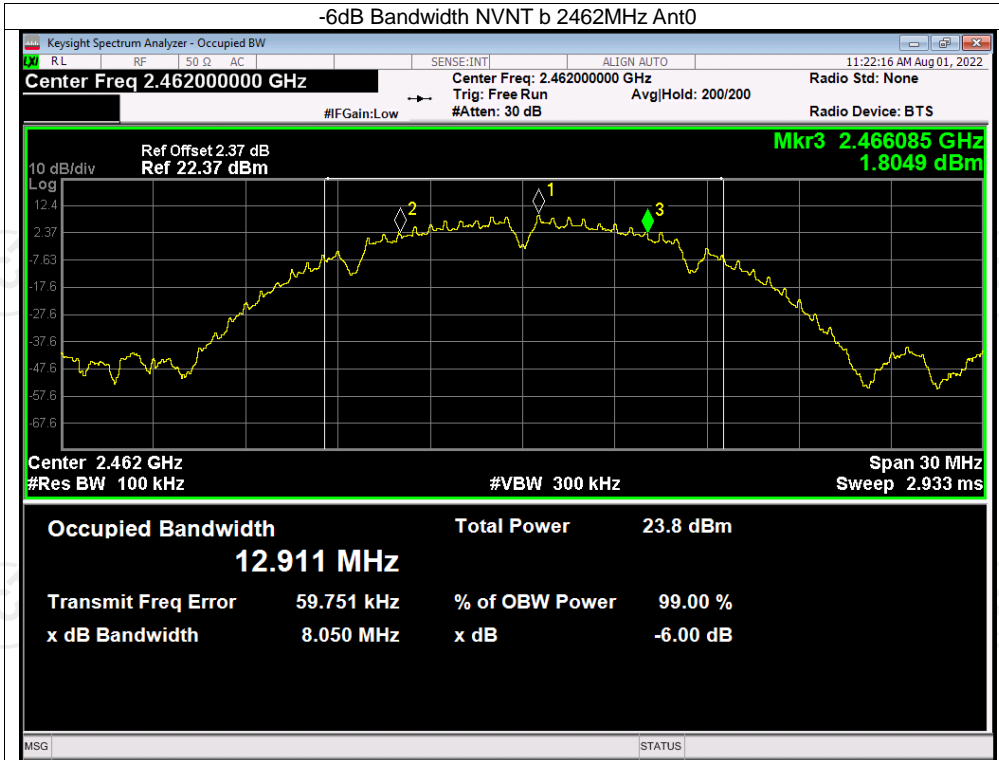

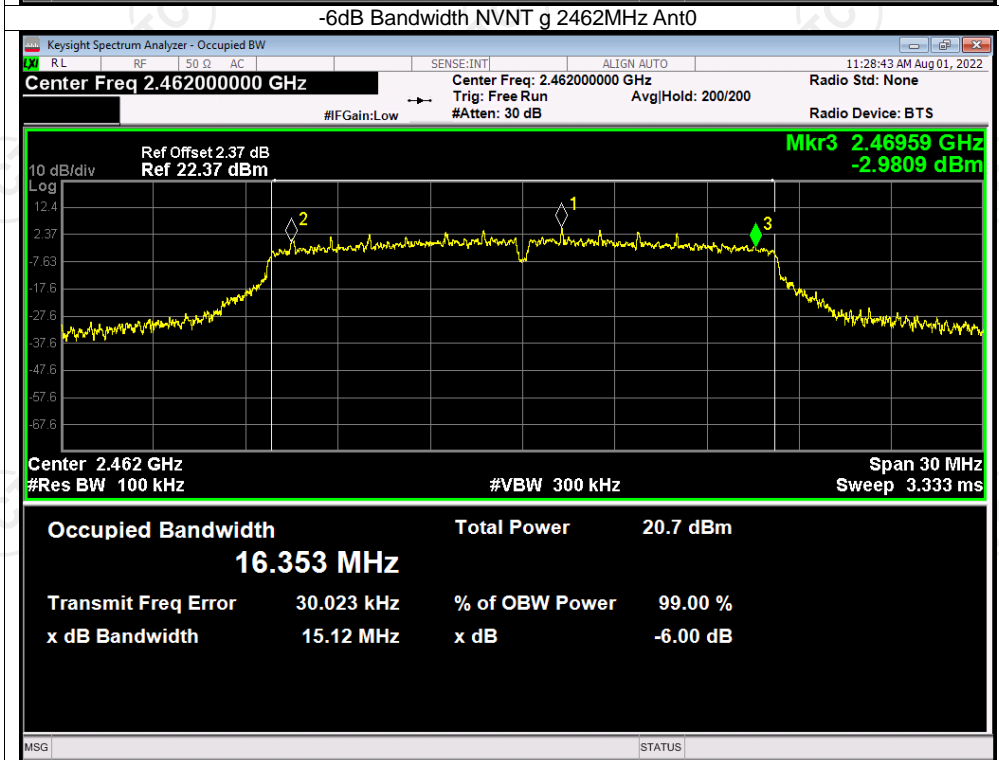
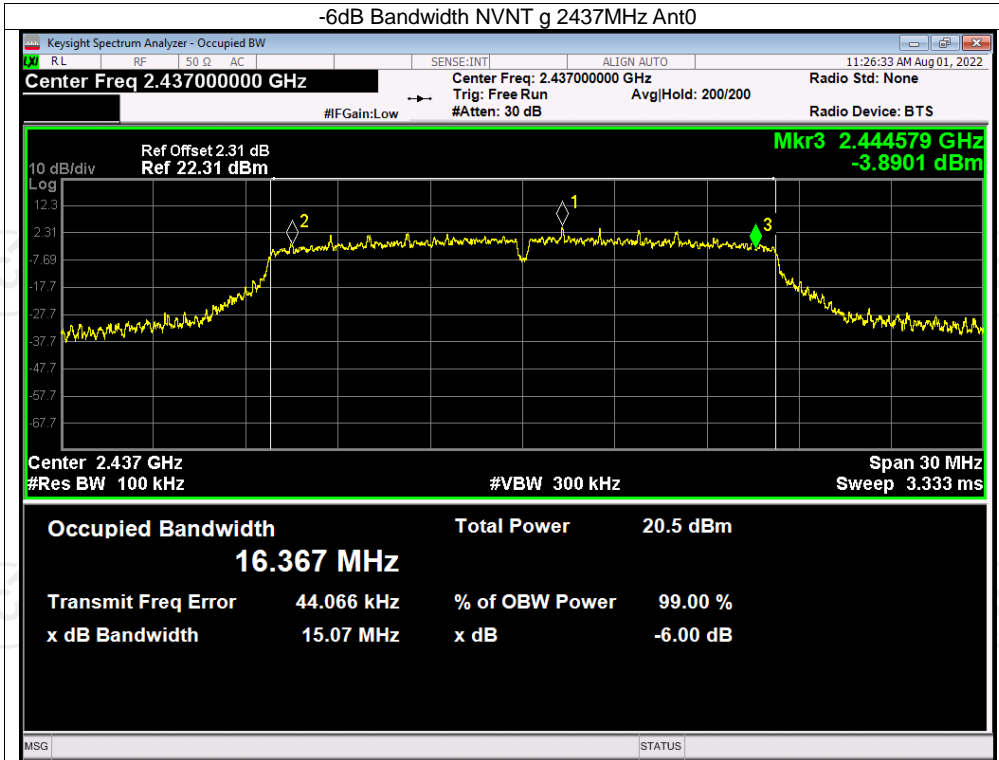

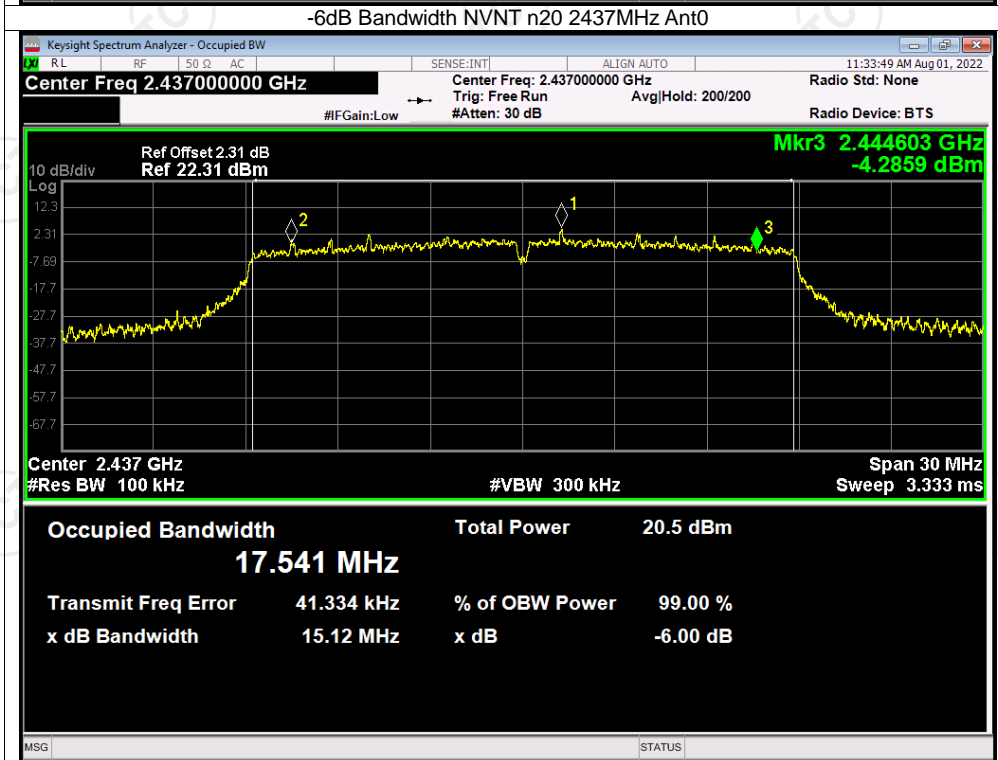
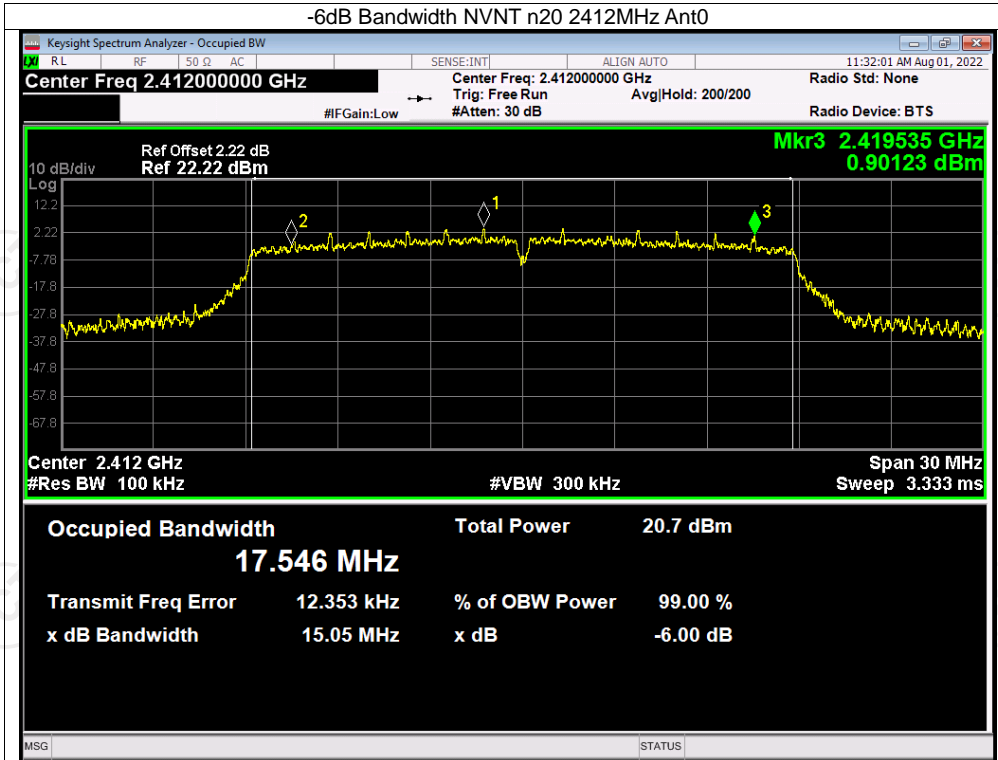

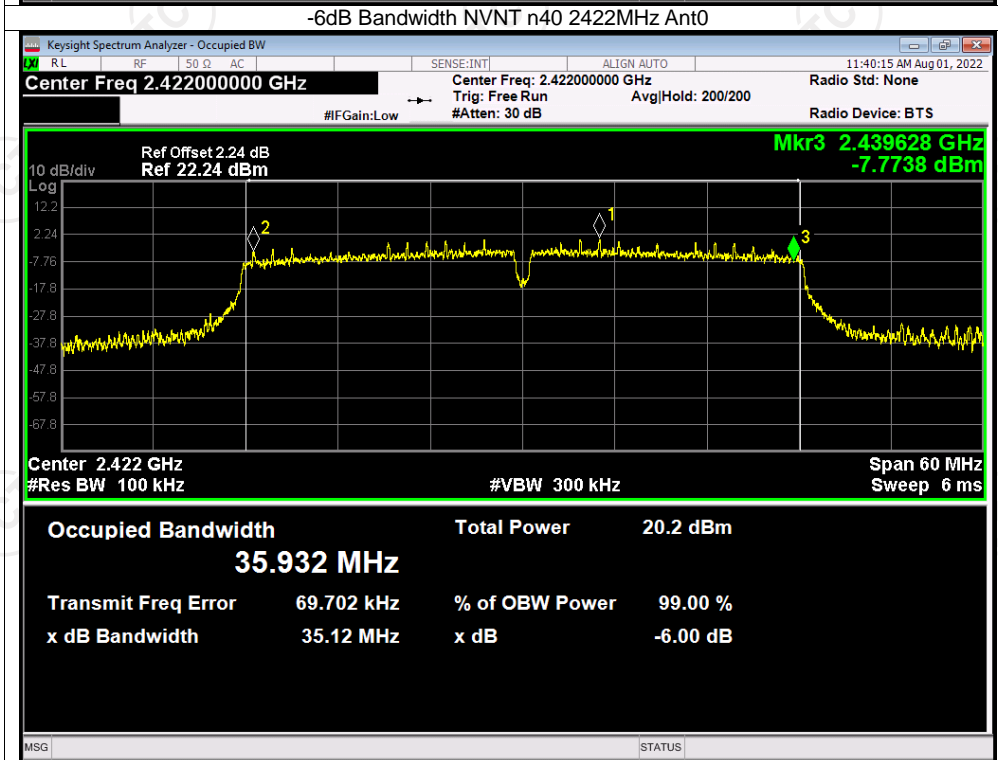
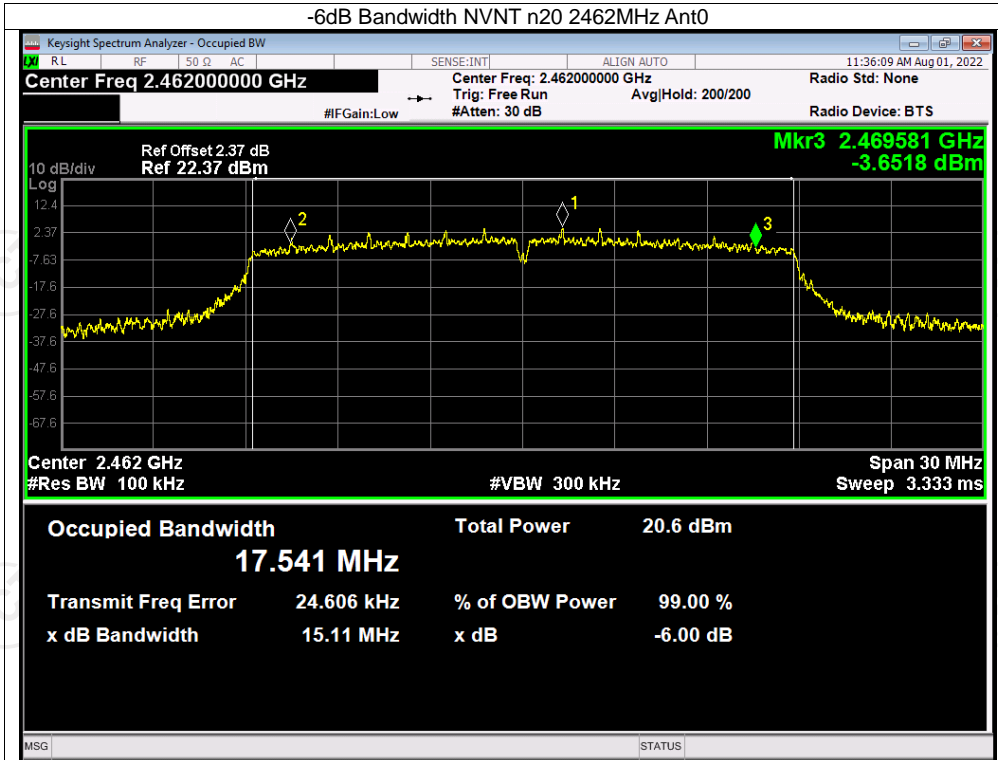

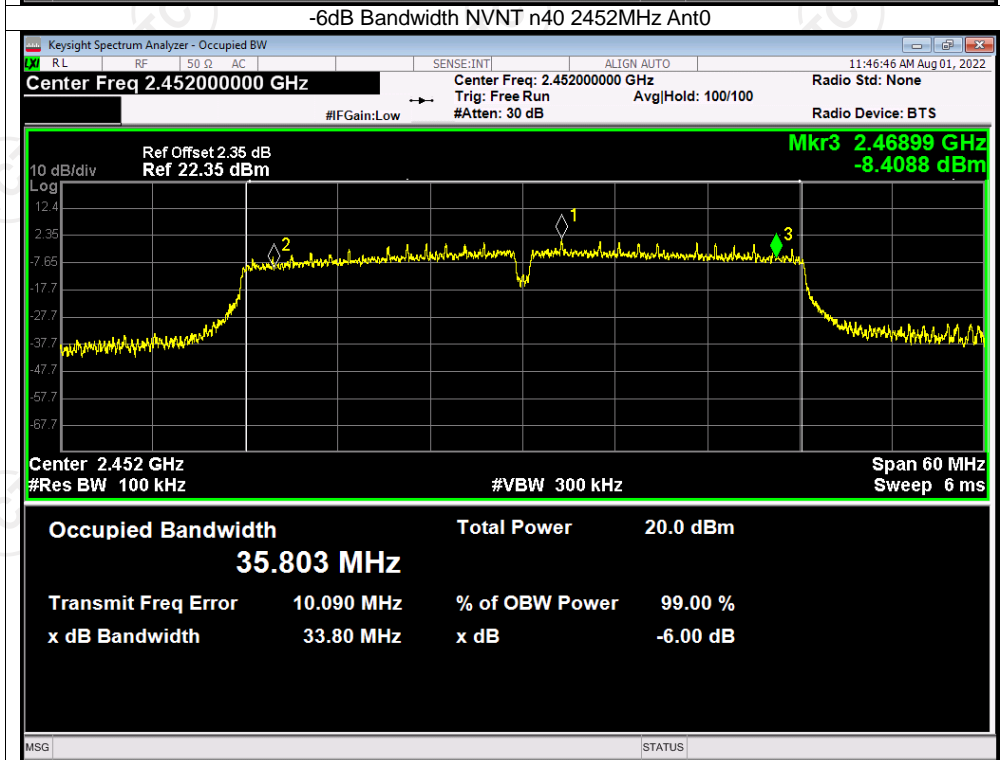
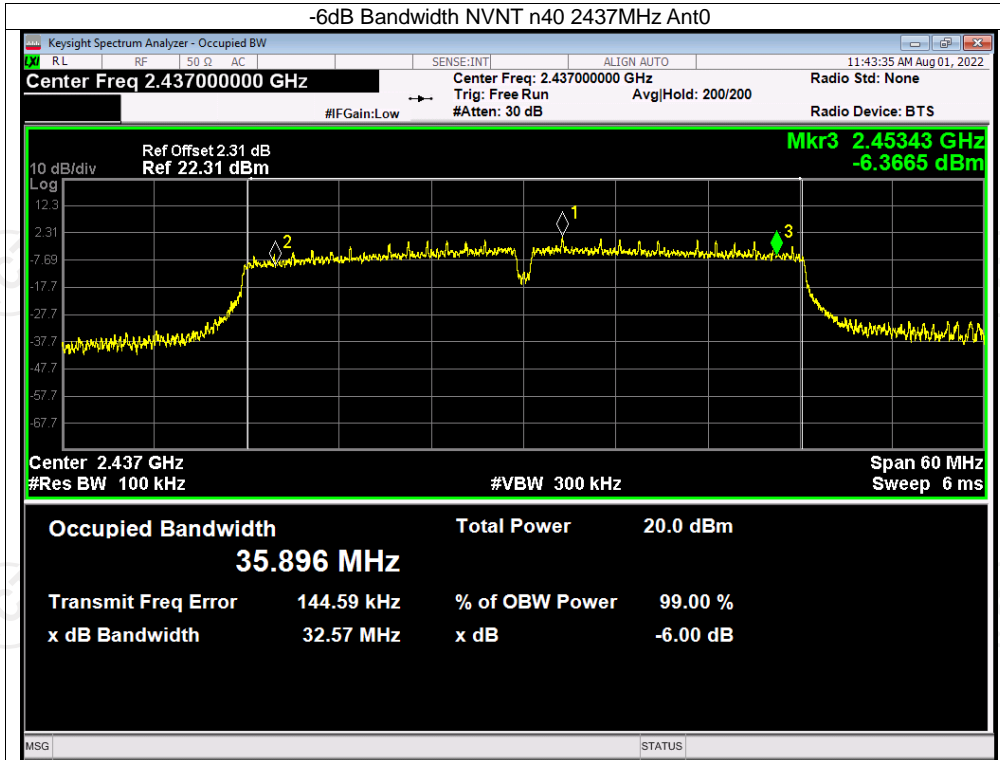

Maximum Power Spectral Density Level

Condition	Mode	Frequency (MHz)	Antenna	Conducted PSD (dBm/30kHz)	Duty Factor (dB)	Total PSD (dBm/30kHz)	Total PSD (dBm/3kHz)	Limit (dBm/3kHz)	Verdict
NVNT	b	2412	Ant0	-4.42	0	-4.42	-14.42	8	Pass
NVNT	b	2437	Ant0	-4.94	0	-4.94	-14.94	8	Pass
NVNT	b	2462	Ant0	-4.34	0	-4.34	-14.34	8	Pass
NVNT	g	2412	Ant0	-8.98	0.10	-8.88	-18.88	8	Pass
NVNT	g	2437	Ant0	-9.32	0.10	-9.22	-19.22	8	Pass
NVNT	g	2462	Ant0	-9.08	0.10	-8.98	-18.98	8	Pass
NVNT	n20	2412	Ant0	-9.29	0.11	-9.18	-19.18	8	Pass
NVNT	n20	2437	Ant0	-9.14	0.11	-9.03	-19.03	8	Pass
NVNT	n20	2462	Ant0	-9.49	0.11	-9.38	-19.38	8	Pass
NVNT	n40	2422	Ant0	-13.12	0.21	-12.91	-22.91	8	Pass
NVNT	n40	2437	Ant0	-13.53	0.21	-13.32	-23.32	8	Pass
NVNT	n40	2452	Ant0	-13.52	0.21	-13.31	-23.31	8	Pass

Note: Total PSD (dBm/3kHz) = Total PSD (dBm/30kHz) +10log(3kHz/30kHz)

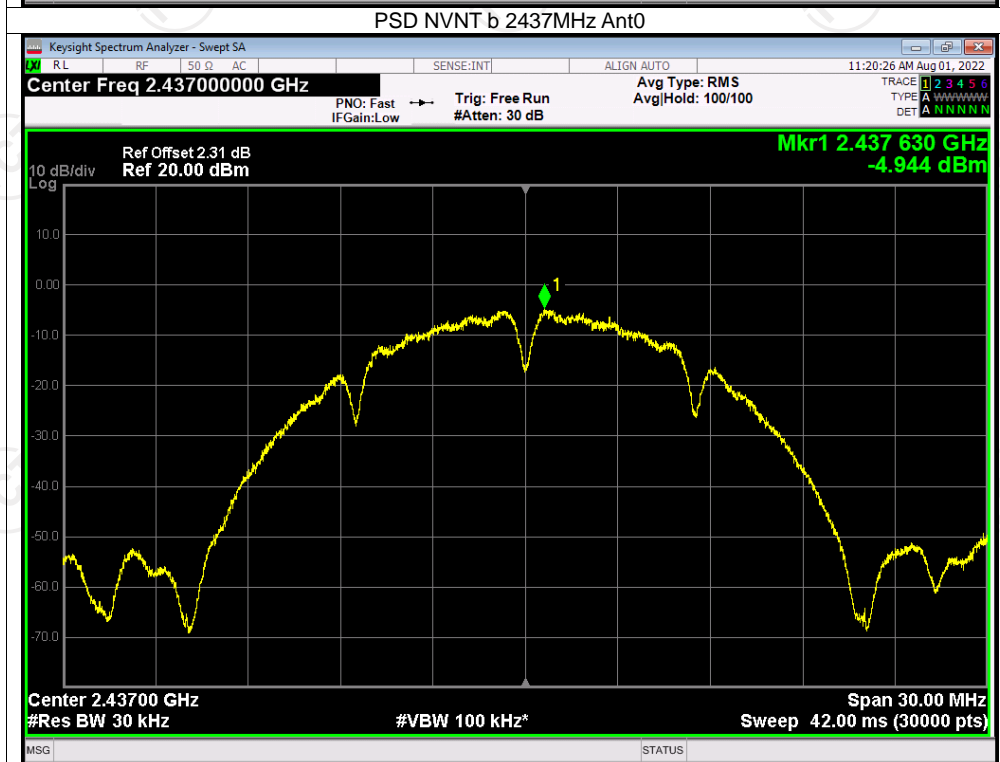
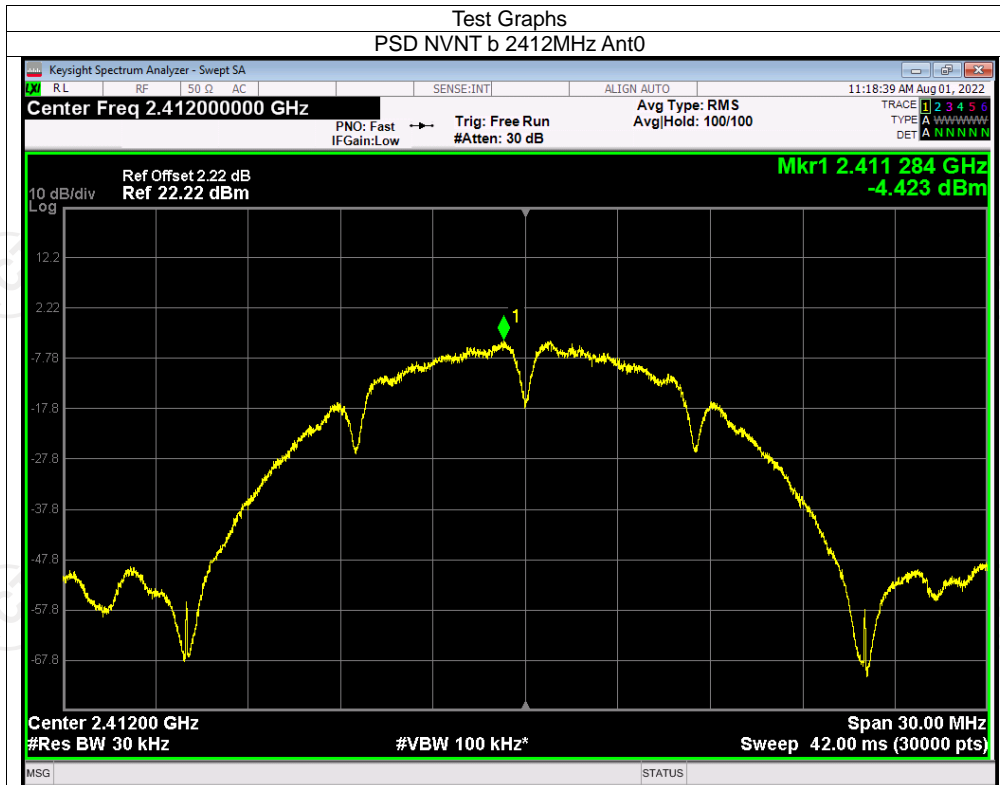

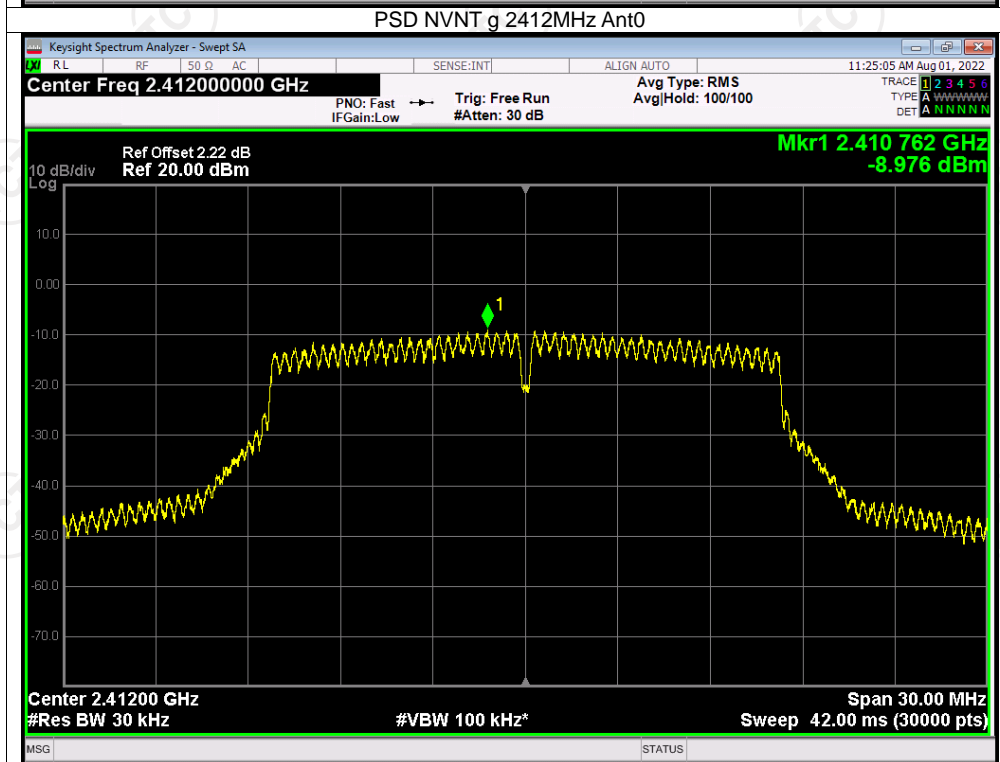
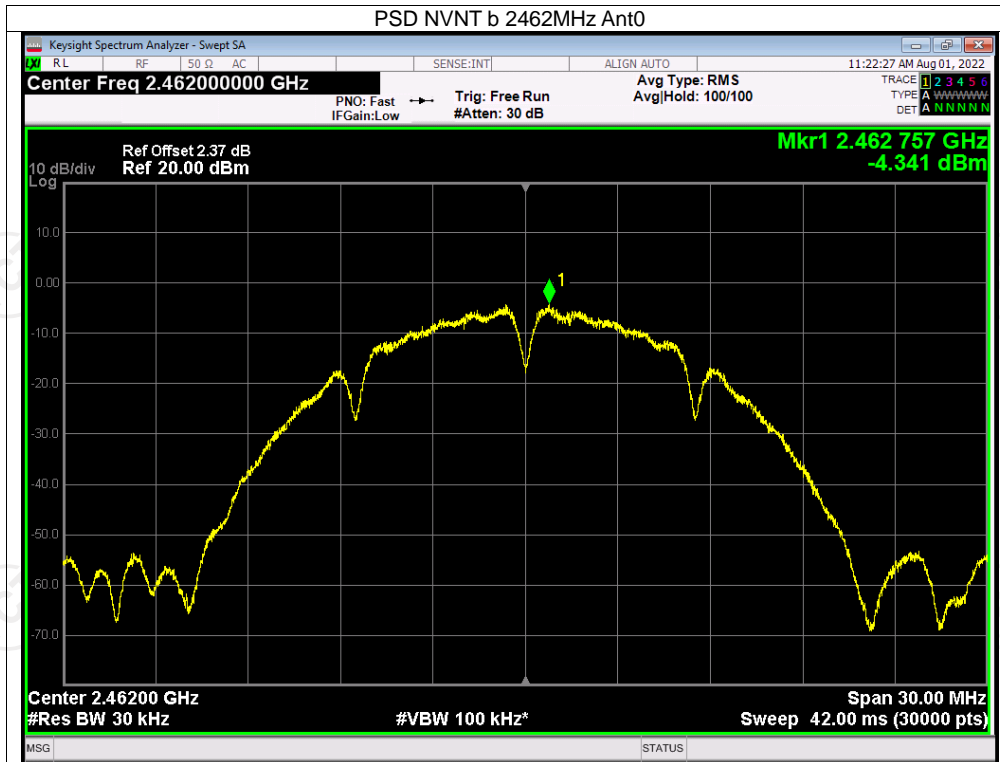

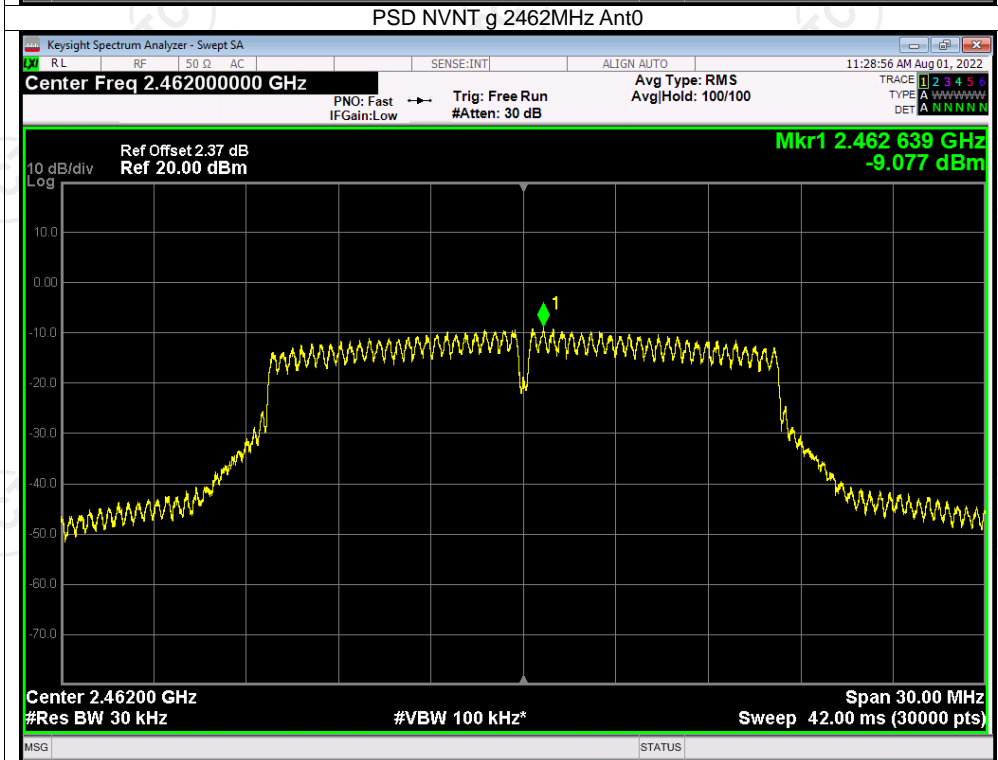
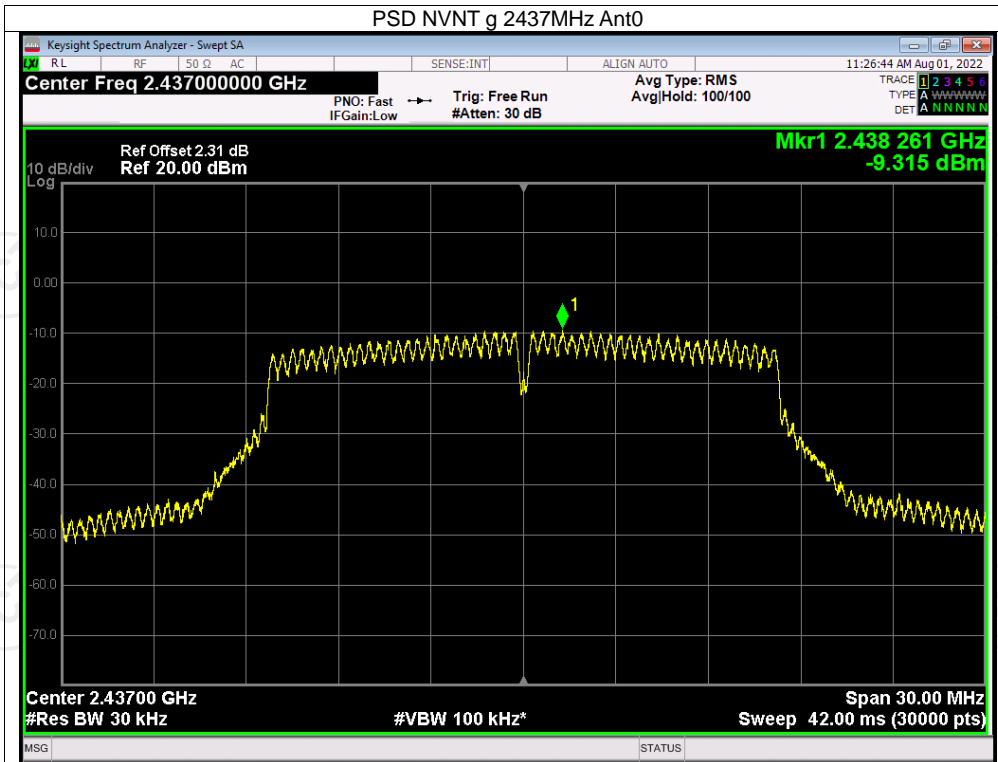

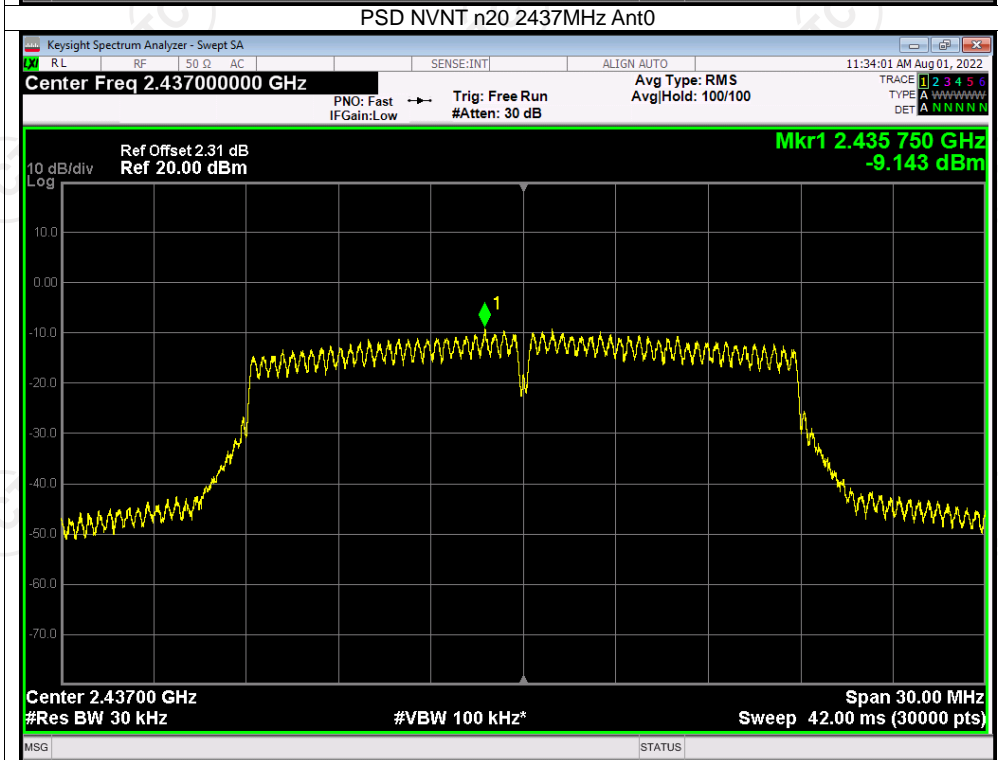
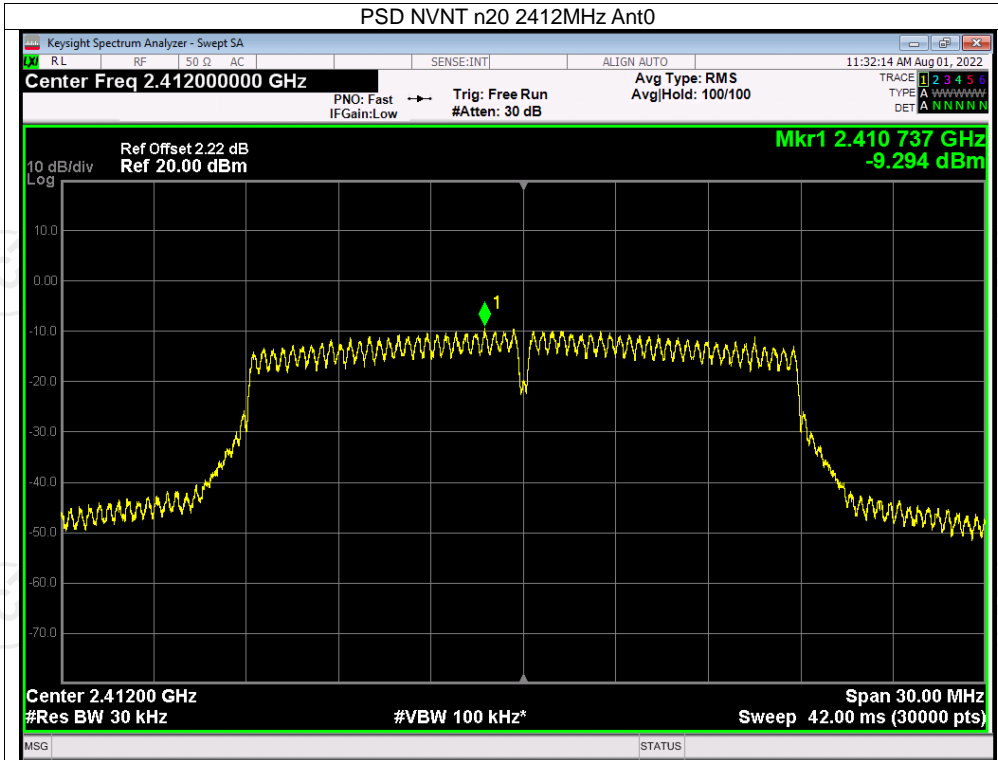

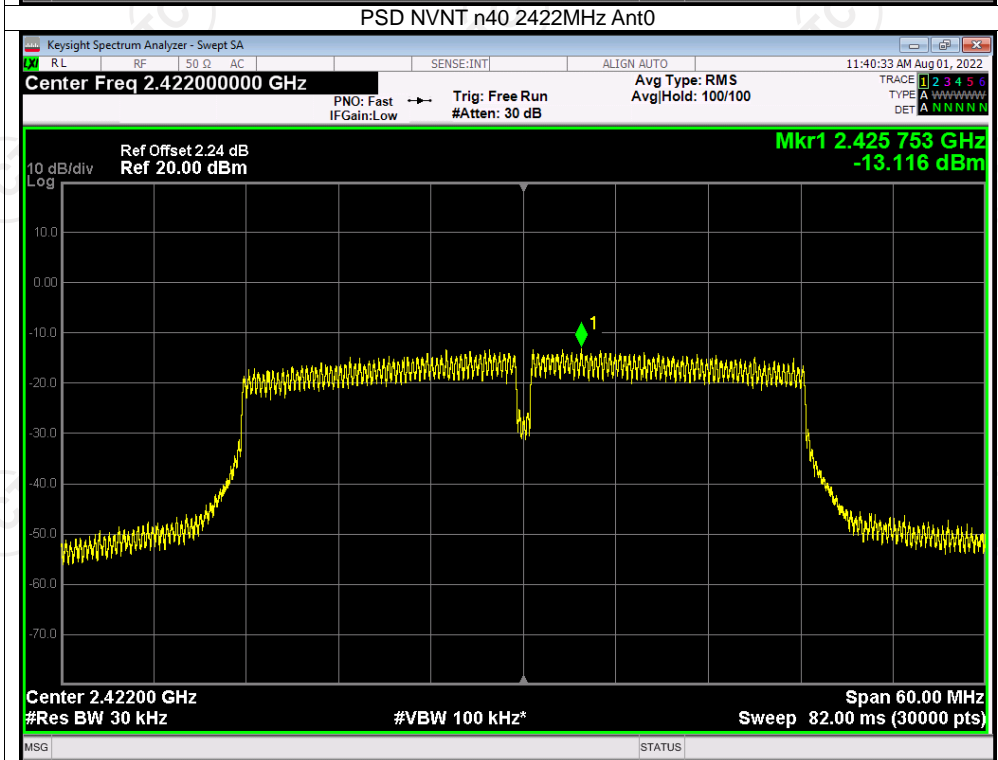
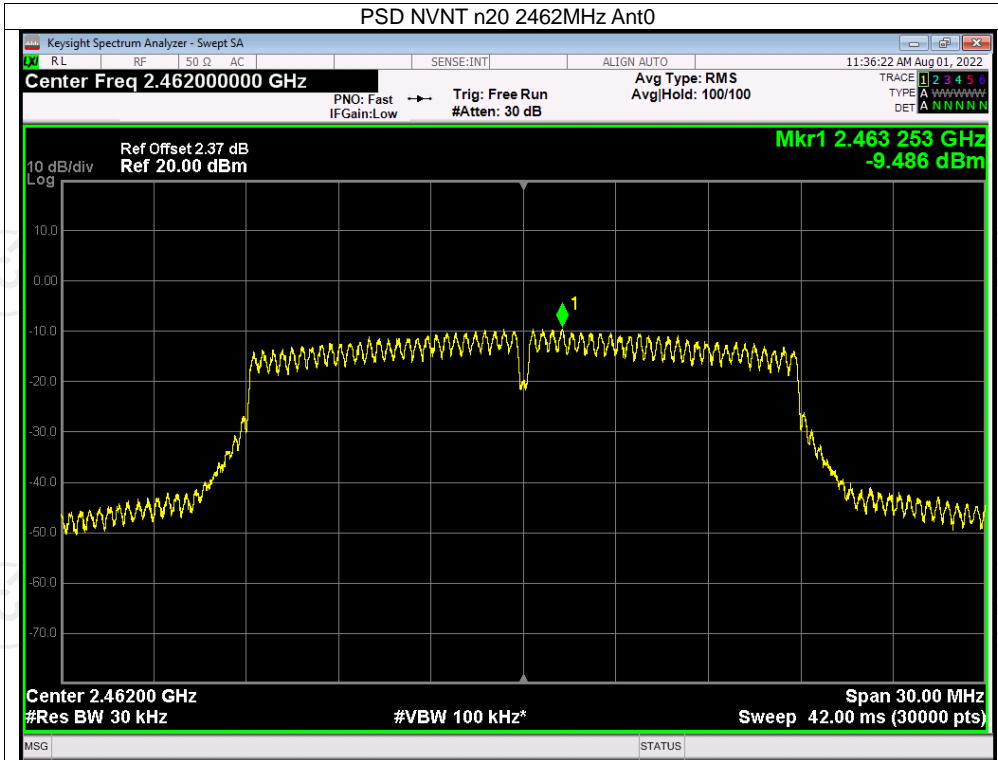

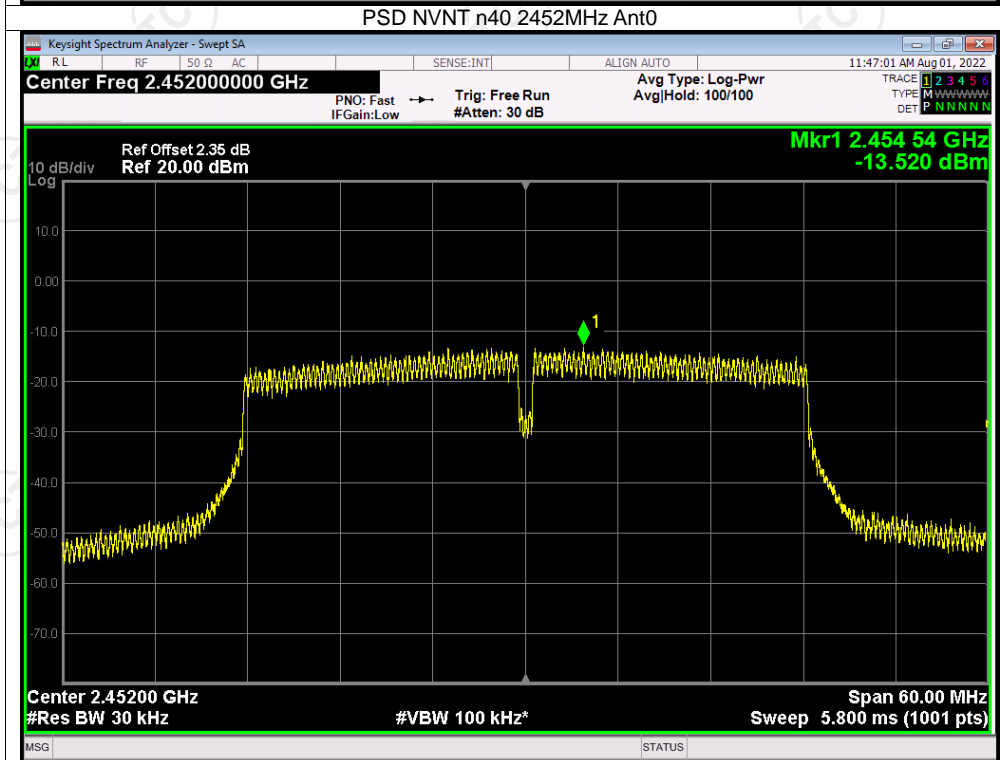
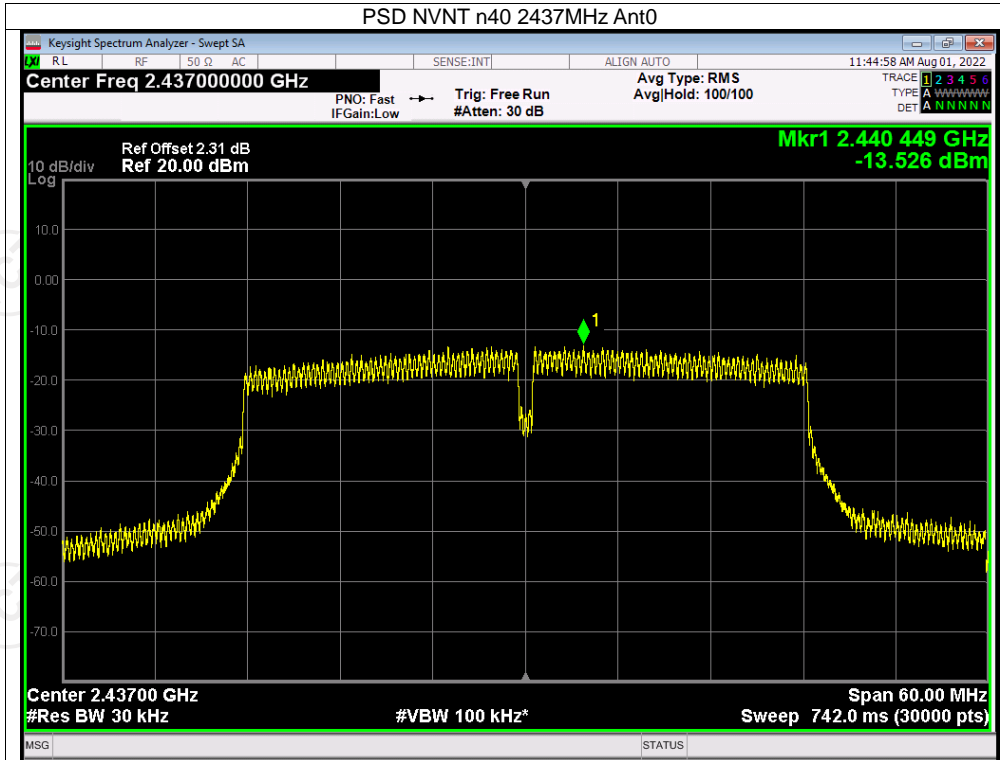

Band Edge

Condition	Mode	Frequency (MHz)	Antenna	Max Value (dBc)	Limit (dBc)	Verdict
NVNT	b	2412	Ant0	-60.27	-30	Pass
NVNT	b	2462	Ant0	-61.03	-30	Pass
NVNT	g	2412	Ant0	-46.13	-30	Pass
NVNT	g	2462	Ant0	-45.28	-30	Pass
NVNT	n20	2412	Ant0	-47.20	-30	Pass
NVNT	n20	2462	Ant0	-42.52	-30	Pass
NVNT	n40	2422	Ant0	-36.86	-30	Pass
NVNT	n40	2452	Ant0	-30.77	-30	Pass

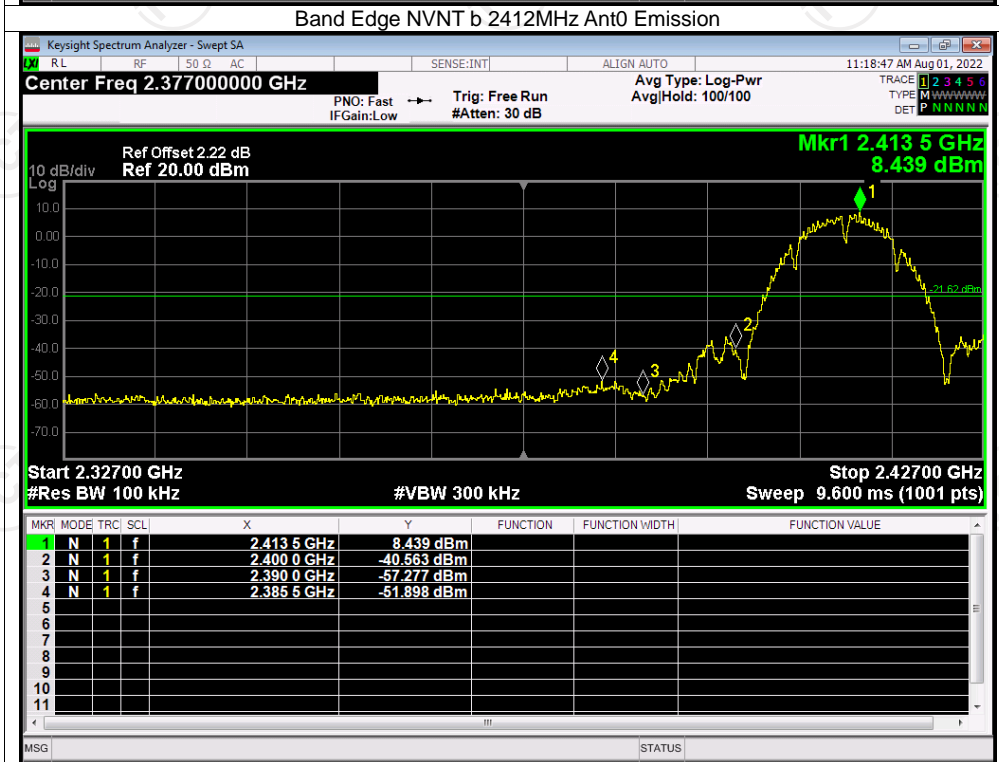
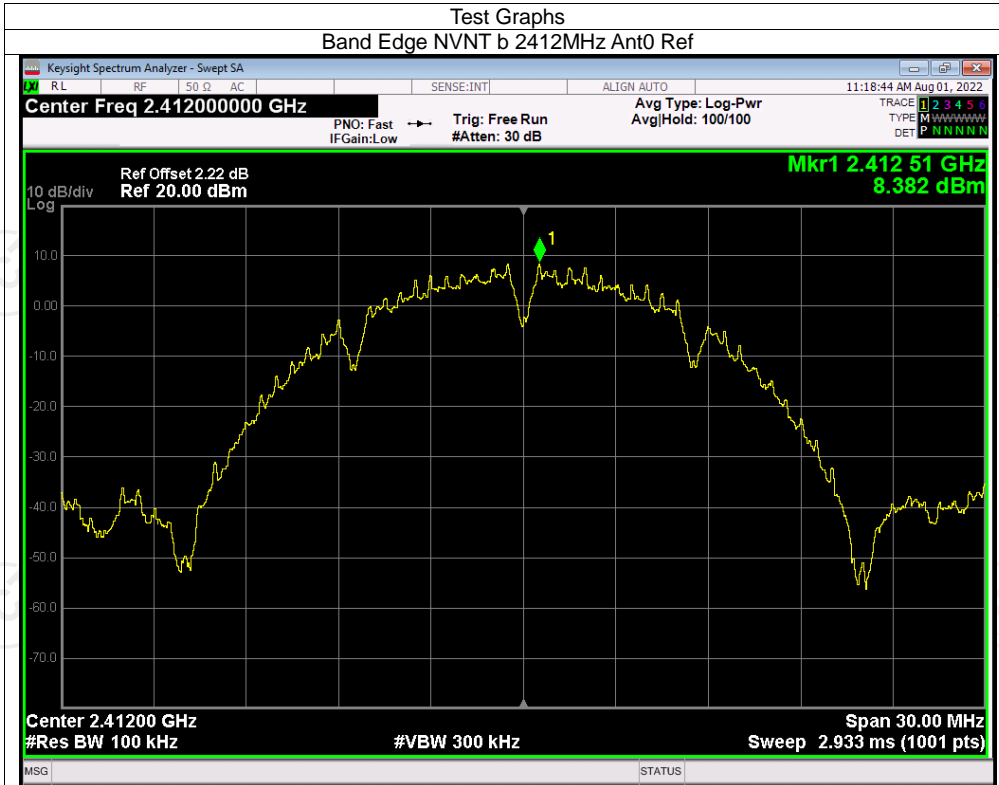

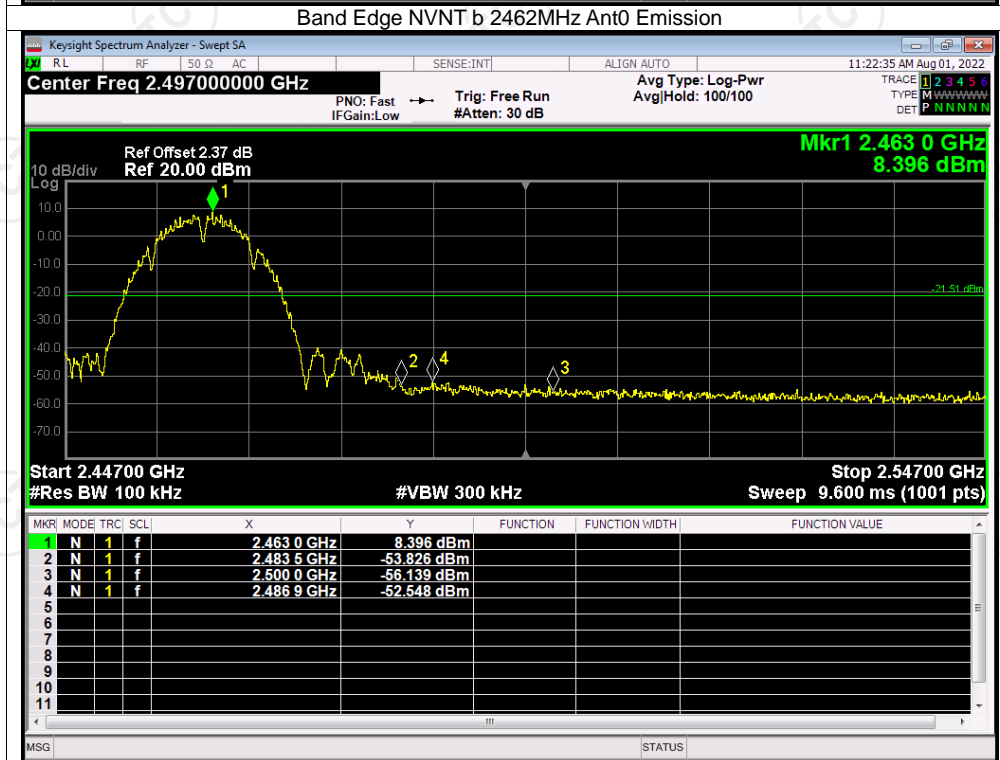
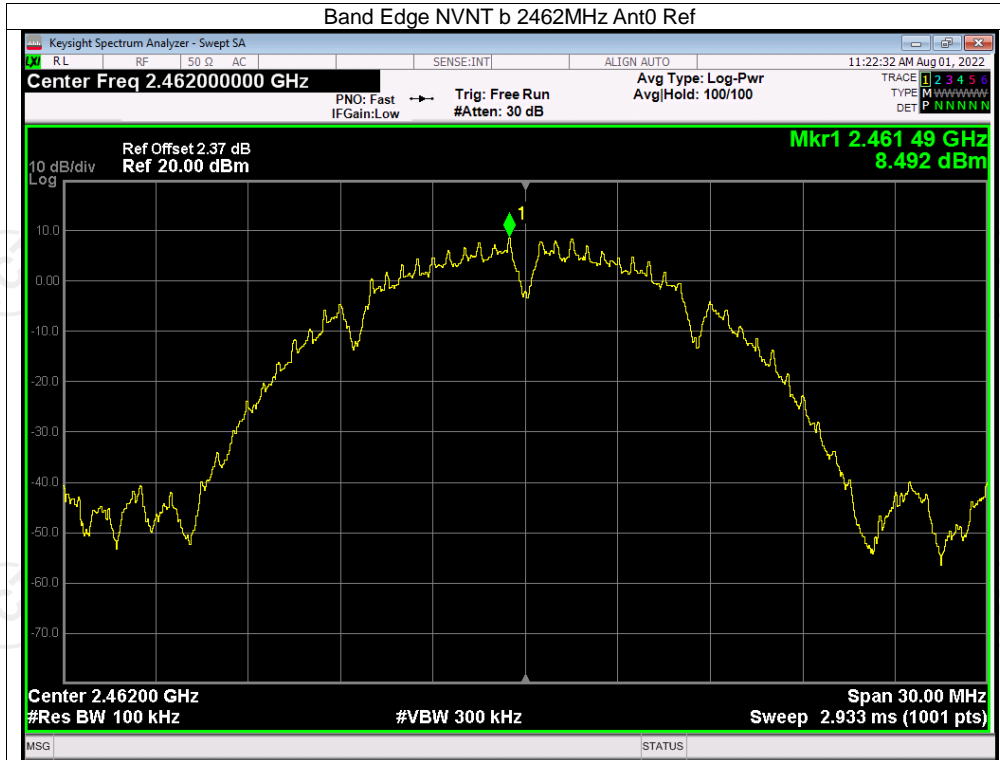

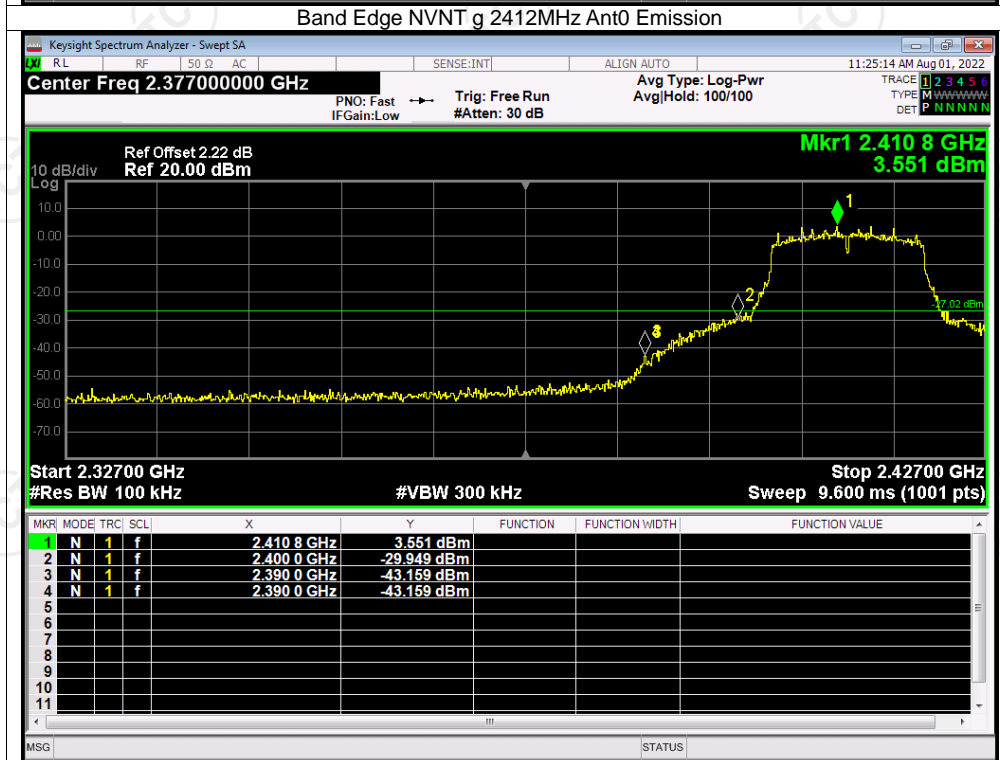
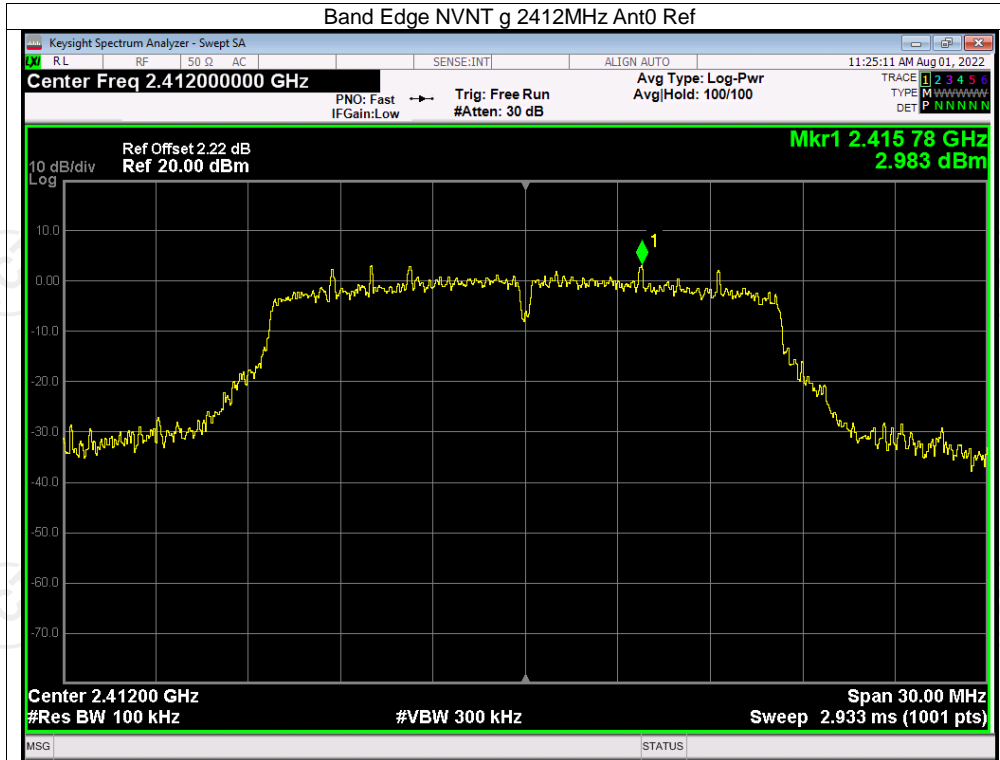

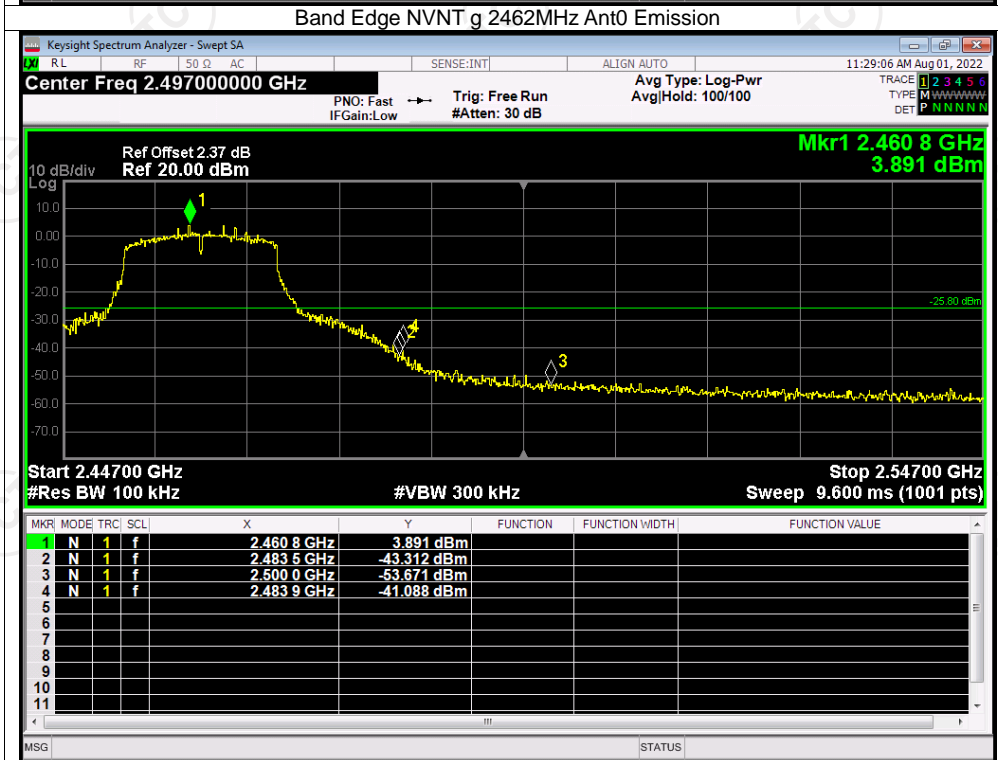
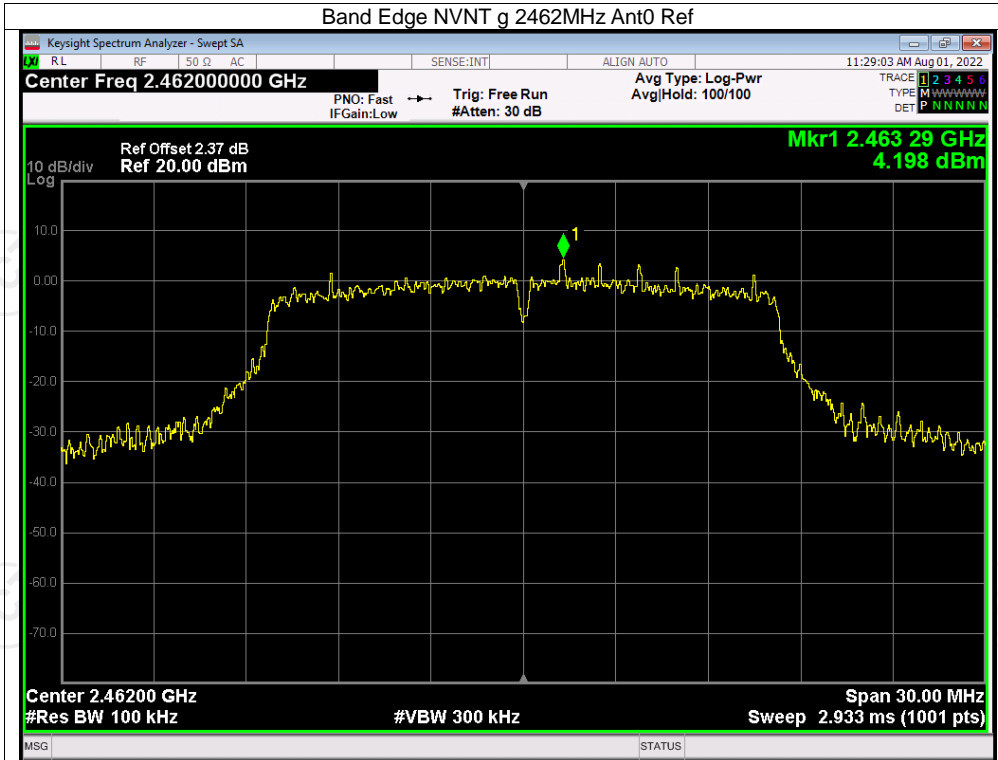

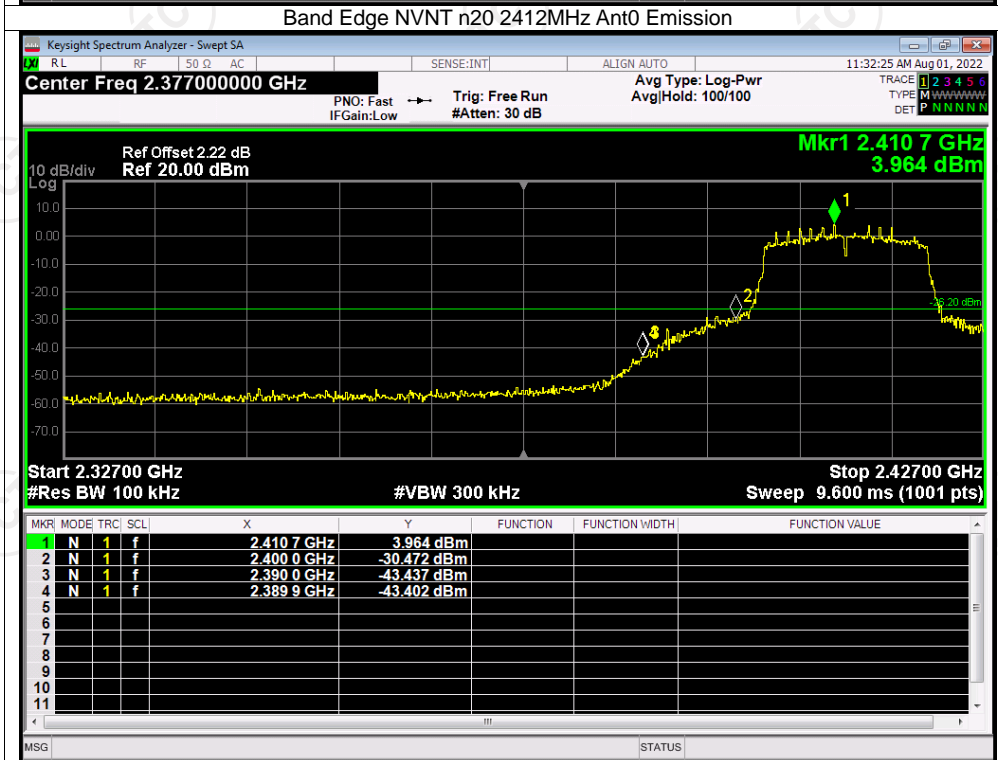
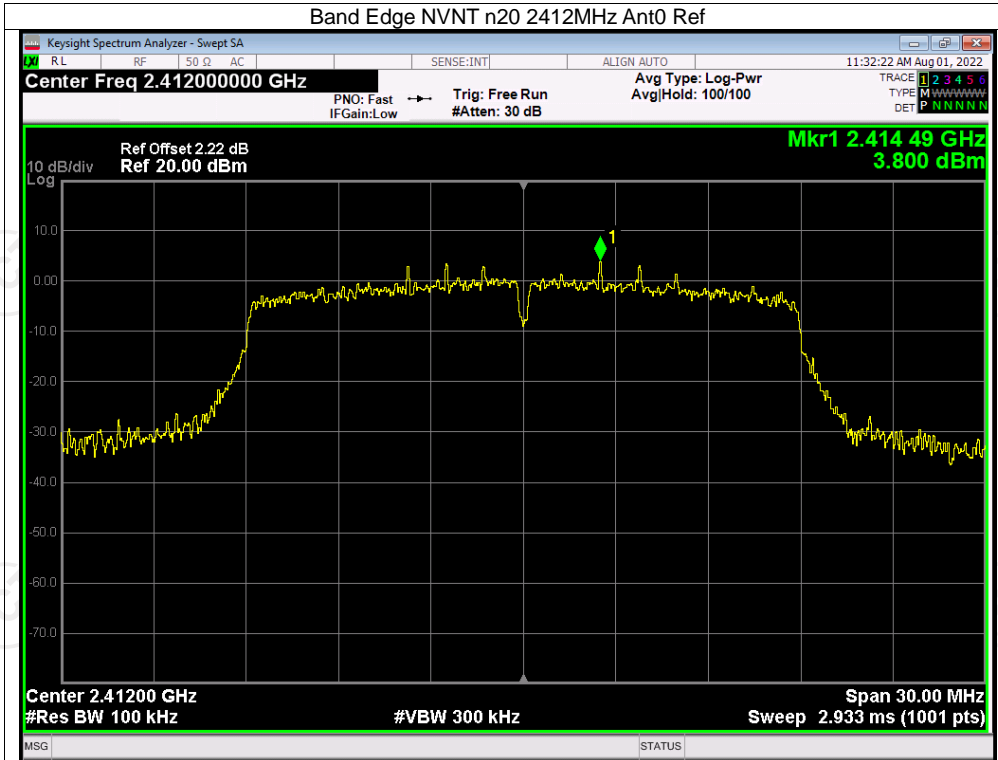

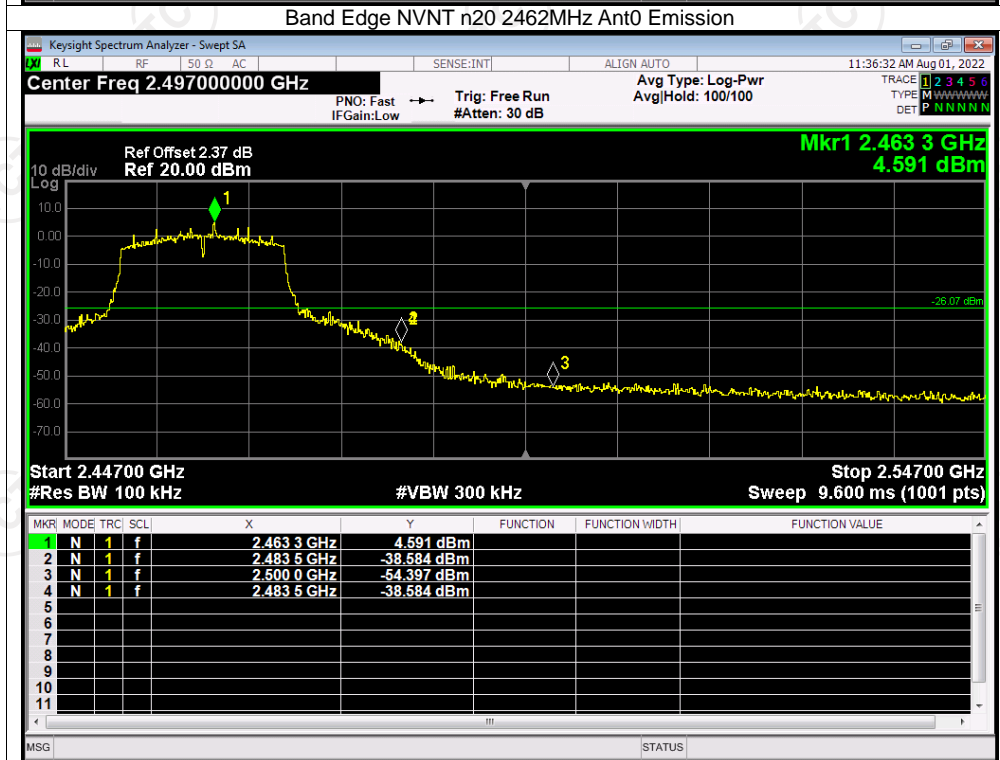
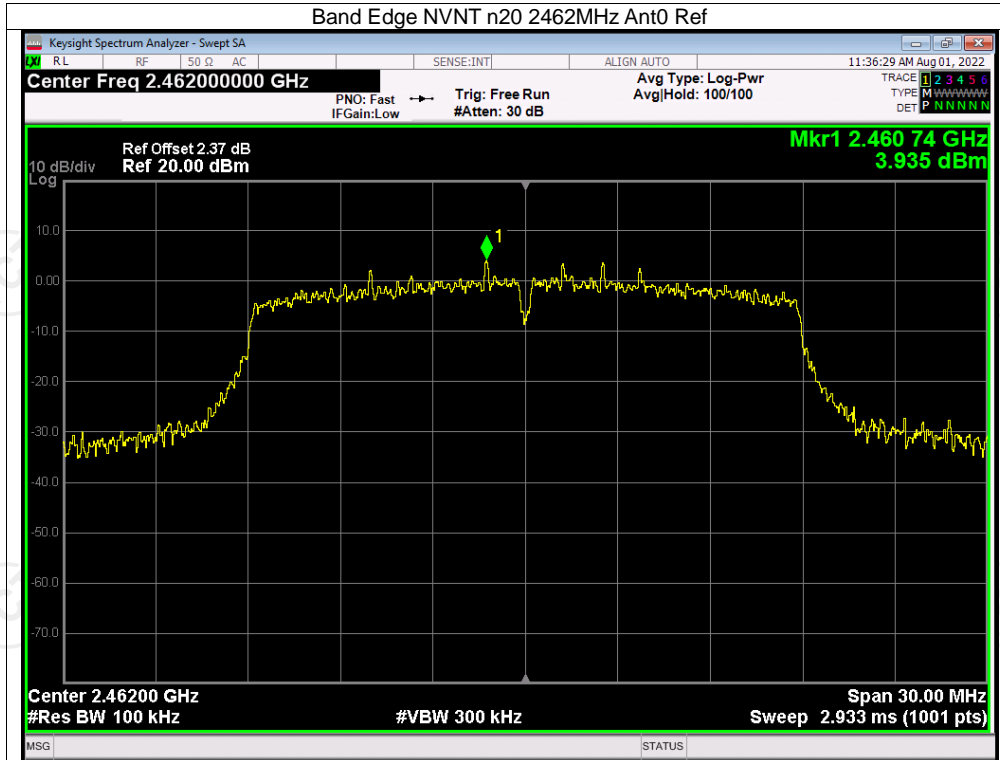

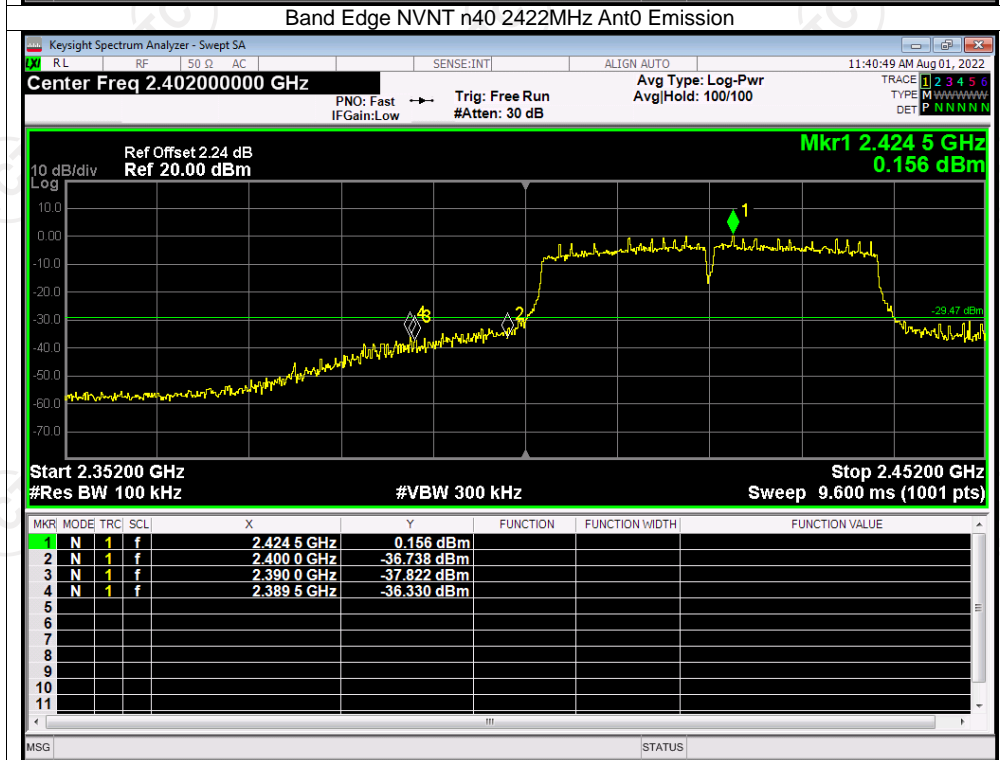
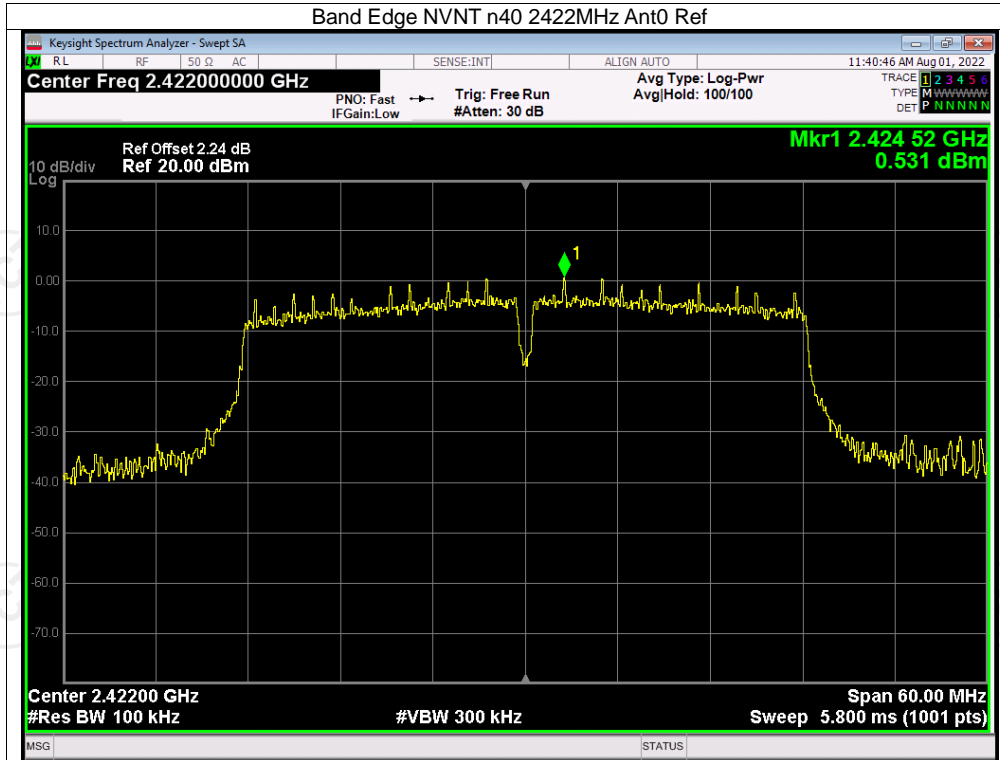

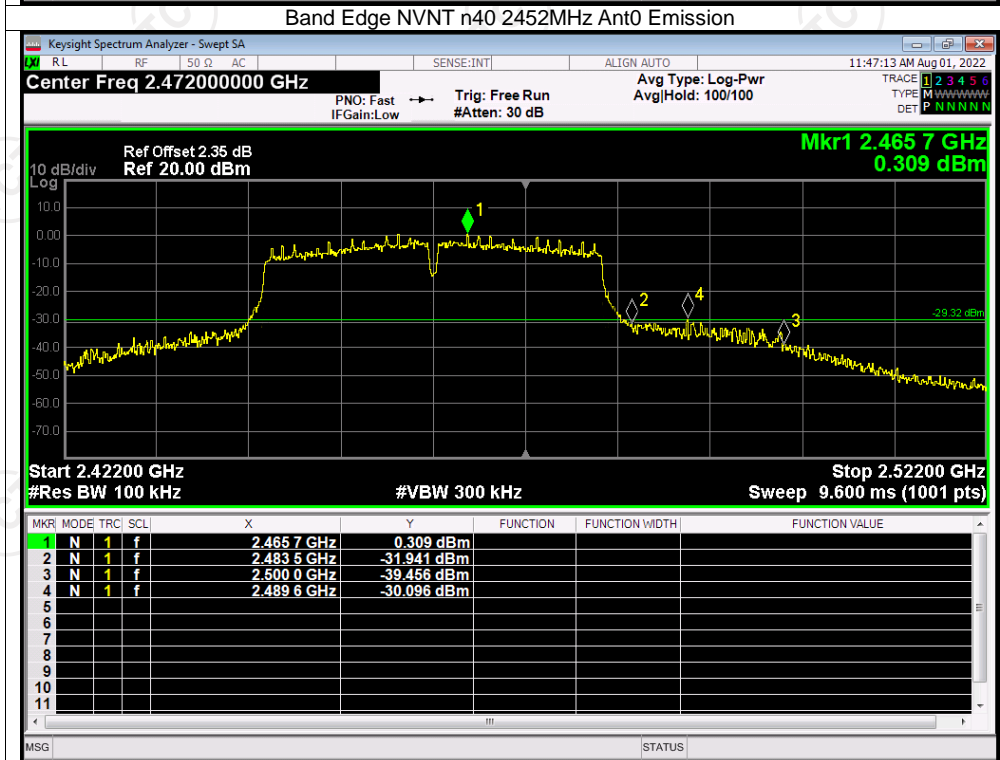
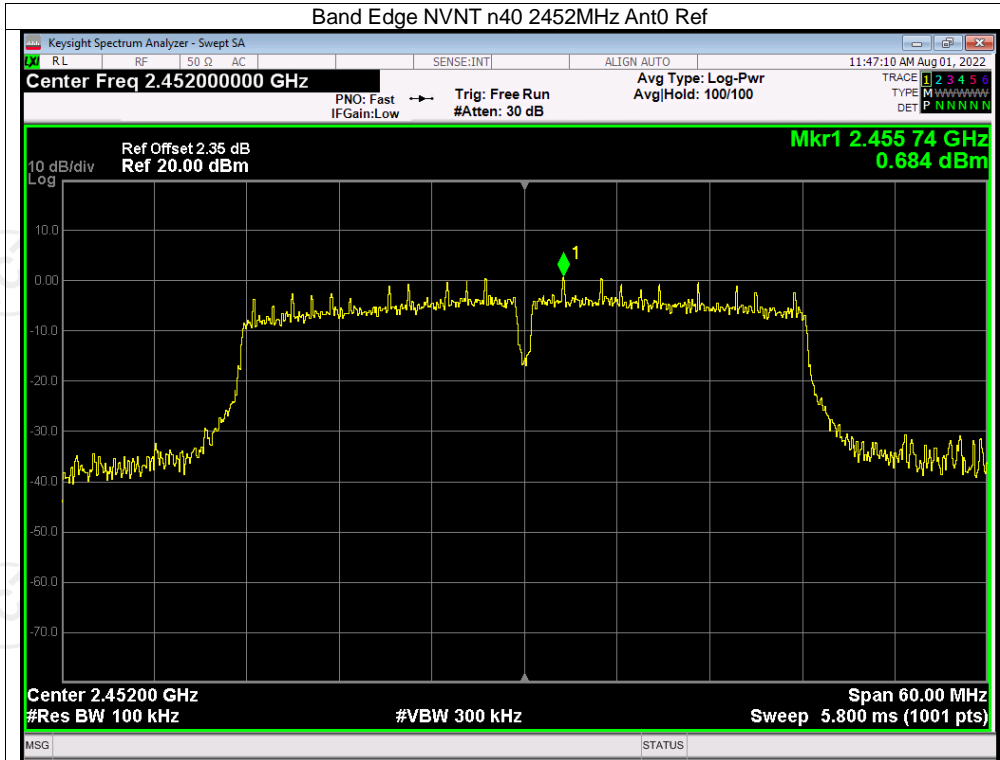

Conducted RF Spurious Emission

Condition	Mode	Frequency (MHz)	Antenna	Max Value (dBc)	Limit (dBc)	Verdict
NVNT	b	2412	Ant0	-49.09	-30	Pass
NVNT	b	2437	Ant0	-50.85	-30	Pass
NVNT	b	2462	Ant0	-53.40	-30	Pass
NVNT	g	2412	Ant0	-49.01	-30	Pass
NVNT	g	2437	Ant0	-48.48	-30	Pass
NVNT	g	2462	Ant0	-49.52	-30	Pass
NVNT	n20	2412	Ant0	-50.08	-30	Pass
NVNT	n20	2437	Ant0	-48.99	-30	Pass
NVNT	n20	2462	Ant0	-49.08	-30	Pass
NVNT	n40	2422	Ant0	-45.48	-30	Pass
NVNT	n40	2437	Ant0	-45.75	-30	Pass
NVNT	n40	2452	Ant0	-44.65	-30	Pass

